

SIDE

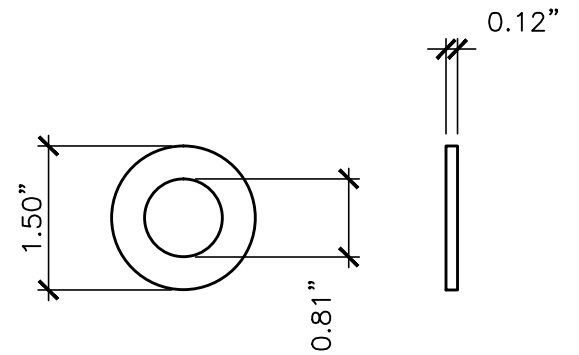

WASHER X2

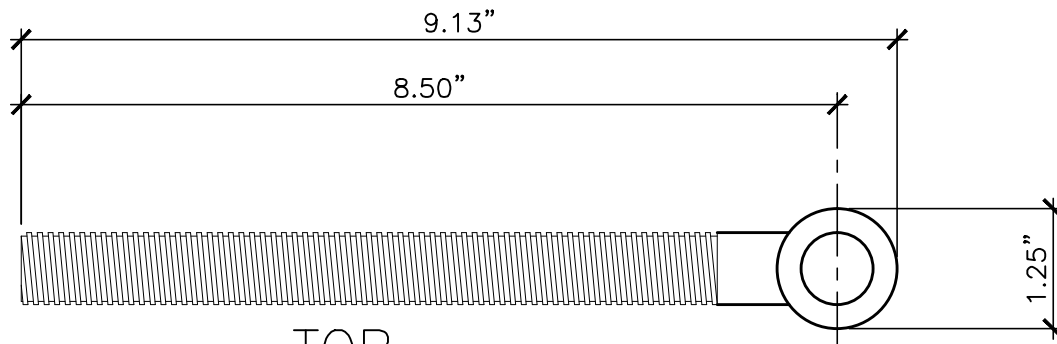

TOP

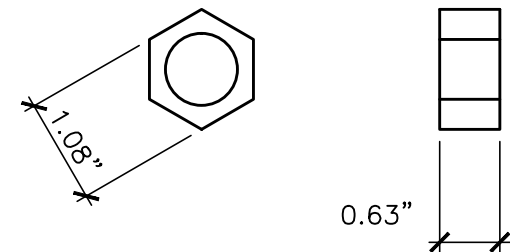

NUT X2

<p>PROPERTY OF:          SNUG COTTAGE          HARDWARE LLC          MARYSVILLE MI.          48040</p>	<p>PRODUCT DESCRIPTION:          8" x 3/4" THREADED ADJUSTABLE 'J' BOLT          ALL DIMENSIONS ±0.125"</p>	<p>PART NUMBER:          8801-082/08P</p>
--	---	---

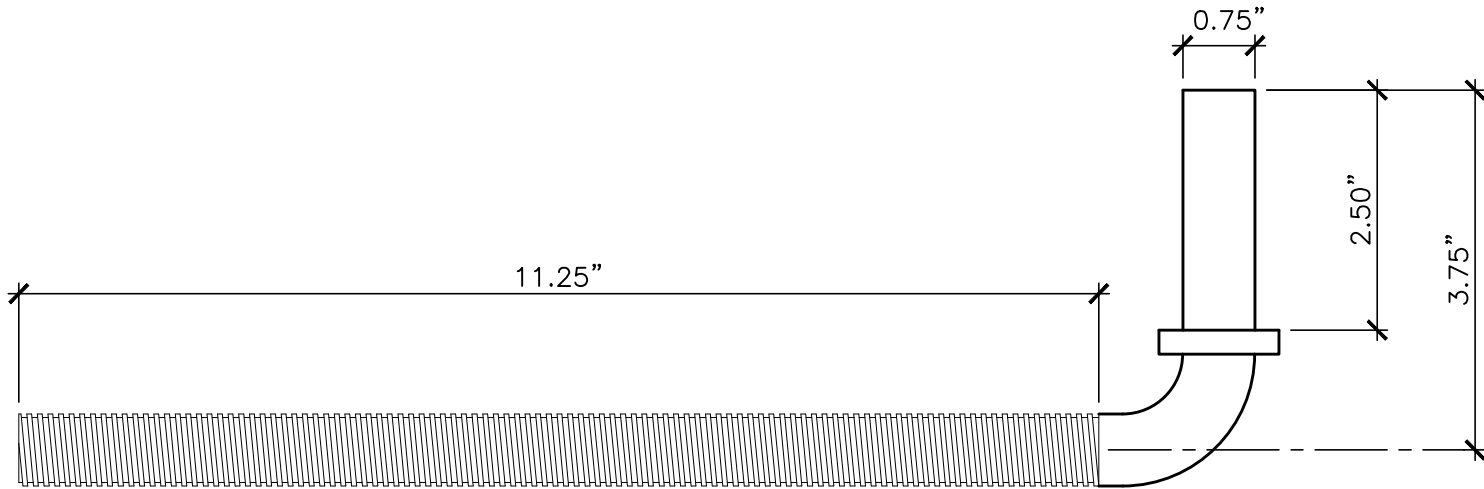

SIDE

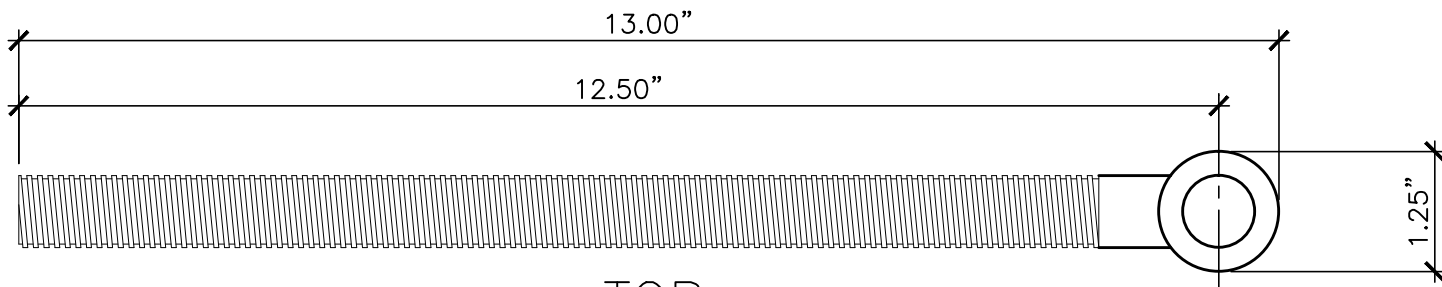

TOP

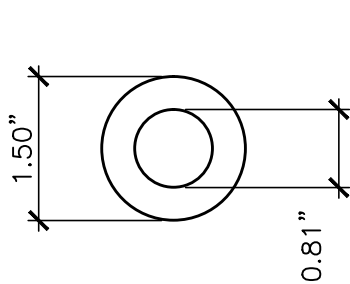

WASHER X2

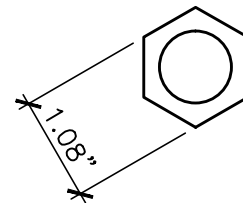
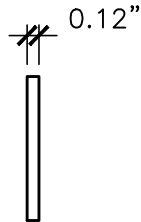

NUT X2

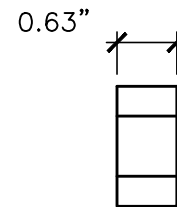

<p>PROPERTY OF:          SNUG COTTAGE          HARDWARE LLC          MARYSVILLE MI.          48040</p>	<p>PRODUCT DESCRIPTION:          12" x 3/4" THREADED ADJUSTABLE 'J' BOLT          ALL DIMENSIONS ±0.125"</p>	<p>PART NUMBER:          8801-122/12P</p>
--	--	---

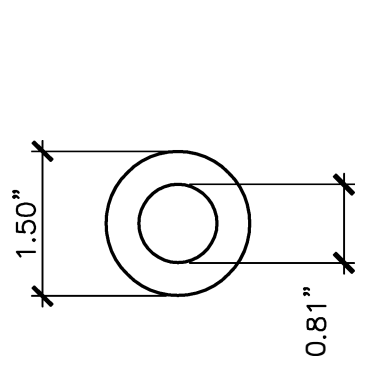
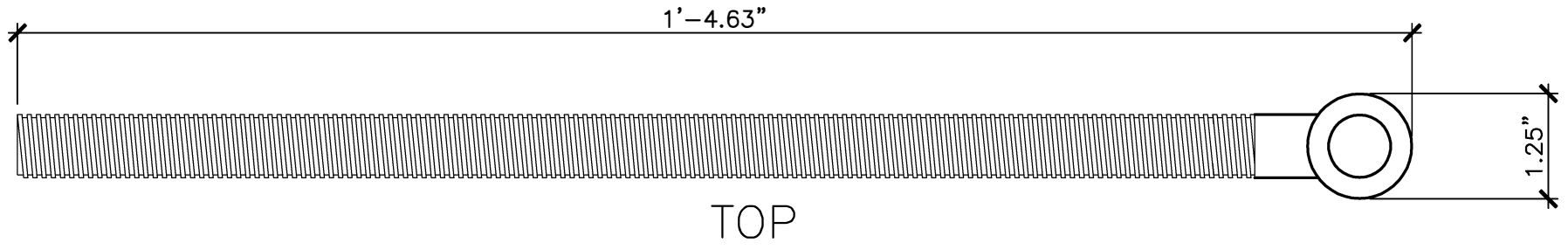
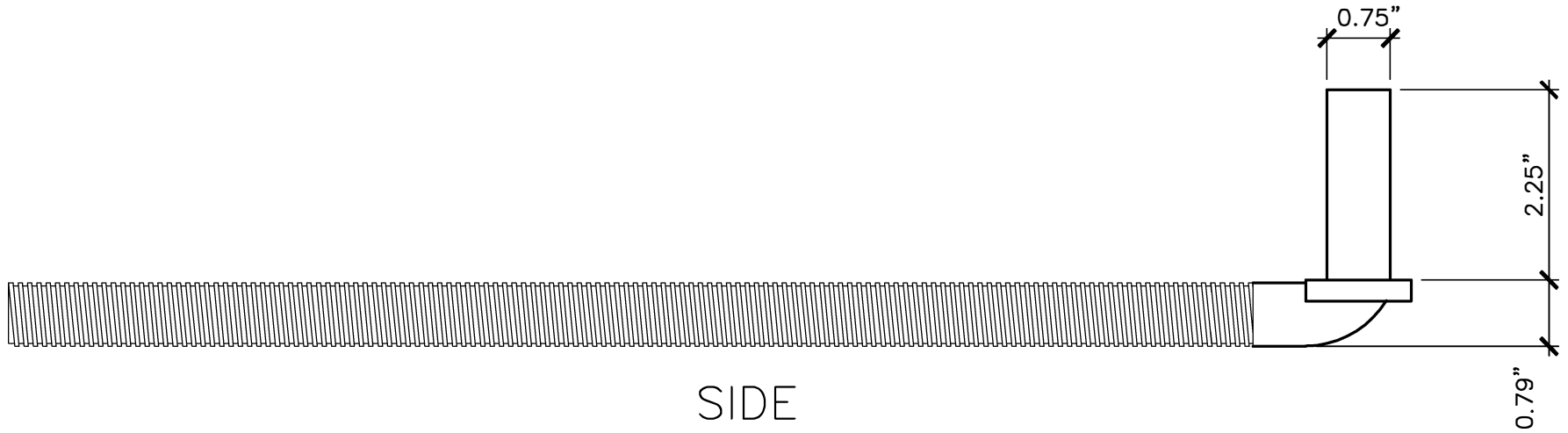

WASHER X2

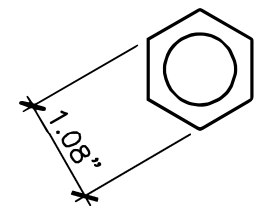
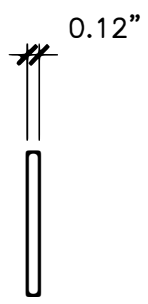

NUT X2

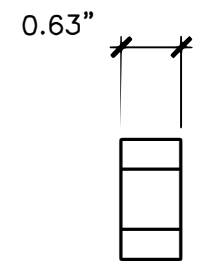

<p>PROPERTY OF:          SNUG COTTAGE          HARDWARE LLC          MARYSVILLE MI.          48040</p>	<p>PRODUCT DESCRIPTION:          16" x 3/4" THREADED ADJUSTABLE 'J' BOLT          ALL DIMENSIONS ±0.125"</p>	<p>PART NUMBER:          8800-162/16SP</p>
--	--	--