



Installation Instructions

R8000 Series

Rigid Regular Arm Door Closer

ASSA ABLOY

CAUTION

An incorrectly installed or improperly adjusted door closer can cause property damage or personal injury. These instructions should be followed to avoid the possibility of misapplication or misadjustment.

Regular Non Hold Open Arm

This series of door closers is not available with a hold open function.

- With or without suffix "DA" (Delayed Action) closing

Closer Power †	Series	
Sized Closer ¹ Sizes 2, 3, 4, 5, or 6	R8300	R8500
Multi-Size Closer ² 1 thru 6	R8301	R8501

¹ Series are sized door closers with 50% power increase for each size.

² Series can be adjusted from power size 1 thru 6.

† Size 1 weakest power size, size 6 strongest.

Note: For Special Applications a separate door and frame preparation template is packed with these instructions. Use this instruction sheet for installation sequence and closer adjustments only.



The closing force for Series R8000 door closers is adjustable from a size 1 to a size 6, as outlined in ANSI Standard A156.4. When these series of door closers are installed and adjusted to conform to ADA reduced opening force requirements (5 lbs max.) for interior doors, they may not have adequate closing force to reliably close and latch the door. Power adjustments charted on Page 4 are recommended where possible, to ensure proper door control.

Pull Side Installation

Closer mounts on hinge (pull) side of door. Models with narrow Cover illustrated.

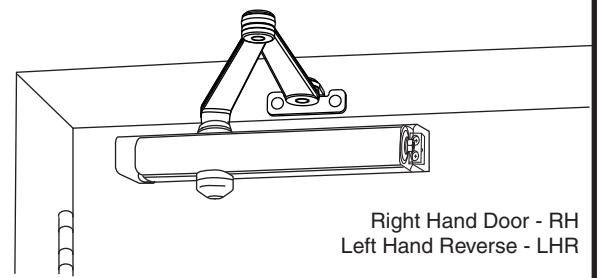
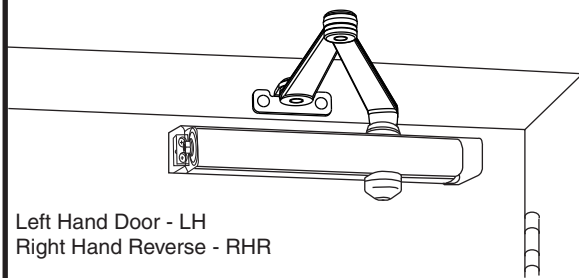

• MAXIMUM HINGE SIDE FRAME REVEAL IS 1/8" (3mm).

- All components are non handed.
- It is recommended that the door, on which the door closer will be installed, be hung on ball bearing hinges. Door must swing freely.
- A separate door stop, supplied by others, is recommended to prevent damage to the door closer, closer arm, or to the door, frame or adjacent walls.
- Door and Frame must be properly reinforced, or use of special fasteners employed, to prevent the mounting screws from pulling out.
- All dimensions are given in inches with corresponding metric dimensions (millimeters) in parenthesis.
- Door closer cover projects 2-1/8" (54 mm) from door surface.

Template



ASSA ABLOY

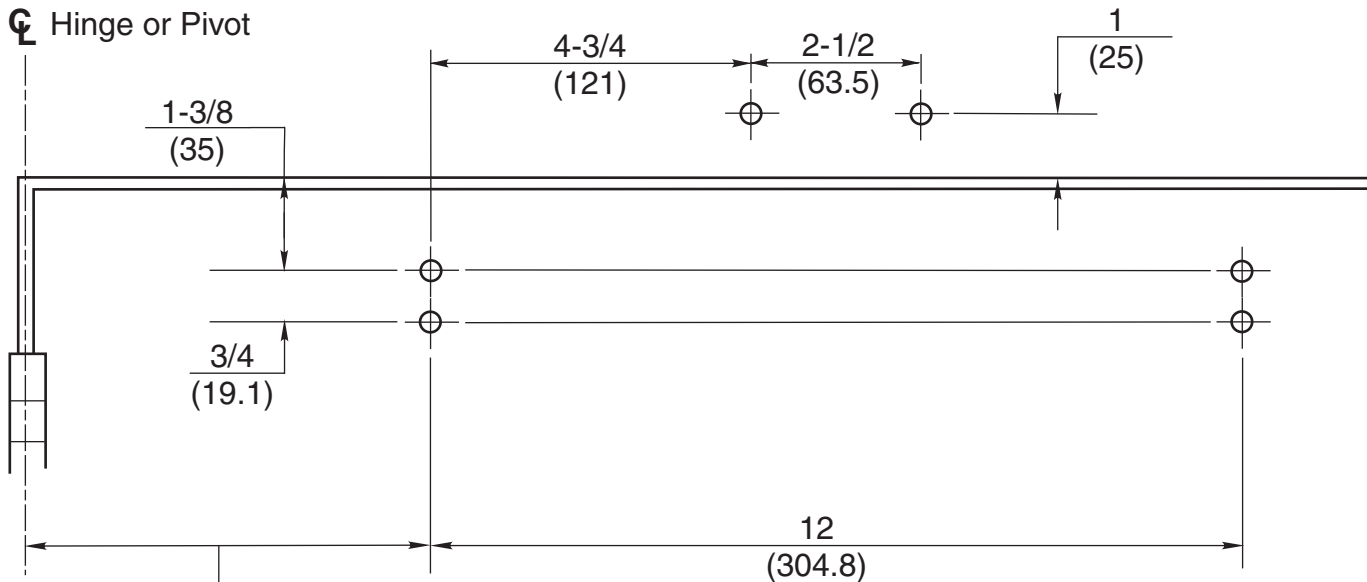

Opening	inches	mm.
To 100°	7-1/2	191
100° to 130°	6	152
*Over 130°	4-1/2	114

* Door will swing to 180°, conditions permitting.

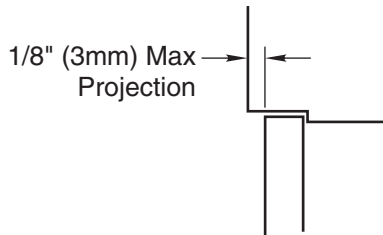

Do Not Scale Drawing

Right Hand Door Shown

Same dimensions apply for Left Hand Door measured from centerline of pivot point.

Dimensions are in inches (mm).

Preparation for Fasteners		
Fasteners	Door or Frame	Drill-Sizes
Self-Drilling Screw	Aluminum or Metal	3/16" (4.30 mm.)
	Wood	3/16" (4.30 mm.)
1/4" - 20 machine screw	Metal	#7 (0.201" dia.) or 5 10mm drill tap: 1/4" - 20
SNB (optional)	Hollow-Metal	9/32" (7.00 mm.) through; 3/8" (9.50 mm.) door face opposite to closer
	Aluminum or Wood	3/8" (9.50 mm.) through
TBGN (optional)	All	9/32" (7.00 mm.) through; 3/8" (9.50 mm.) dia. x 3/8" (9.50 mm.) deep door face opposite to closer

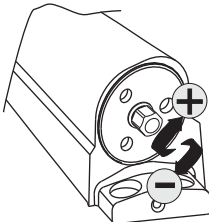

Power Adjust

Use 5/16" Socket or Adjustable Wrench for this Adjustment

Power Adjustment Chart for R8301/R8501 ONLY				
DOOR	Number of Turns Required			
	MAXIMUM DOOR SIZE			
	32" (0.85M)	36" (0.90M)	42" (1.00M)	48" (1.20M)
Interior Door	0	2	5	8
Exterior Door	2	5	8	11

NOTE: Maximum of 20 turns (360°) of Power Adjustment Shaft. Closer is shipped set at 10 turns.

Installation Sequence

- **Select angle of opening** and use dimensions shown to locate 4 holes on door for closer body and 2 holes on frame face for arm shoe.
- **Prepare door and frame** for fasteners. See "Preparation for Fasteners", Page 2.
- **For R8301/R8501 MODELS ONLY:** Set closing power for door size using chart on Page 2.
- **Mount closer body** on door. Be sure that power adjustment shaft is away from hinge.
- **Place main arm on shaft**, aligning 'S' mark on arm with pinion flat on pinion shaft (see illustration at right). Push down into position. Secure with 1/4-20 x 1/2 (13) 7/16" hex washer head screw.
- With door closed, rotate main arm away from hinge and align shoe with mounting holes in frame. Fasten arm shoe to frame with round head screws provided.

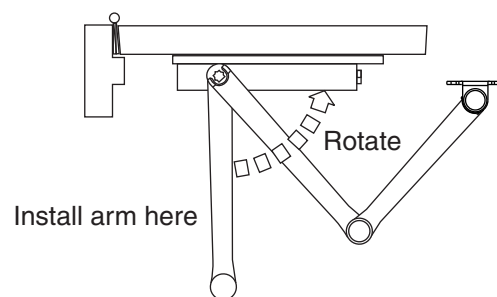
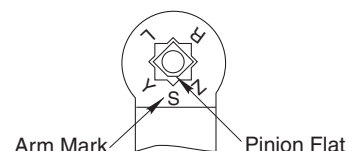

CAUTION: Closer arm is under spring tension and may be difficult to rotate.

- **Make closer adjustments** (see page 4) before installing cover.

CAUTION: Do Not Back Valves Out of Closer or a Leak Will Result.

- **INSTALL COVER:**

R8300 Series Only:

Fasten cover to closer with 2 #6-32 x 5/16 FHMS screws. Screw Pinion cap onto pinion shaft by hand or with a Phillips screw driver - DO NOT OVER TIGHTEN.

R8500 Series Only:

Place insert into notch in cover that will not be used. Fasten cover to closer with 2 #6-32 x 5/16 FHMS screws at each end of closer.

R8300 Series

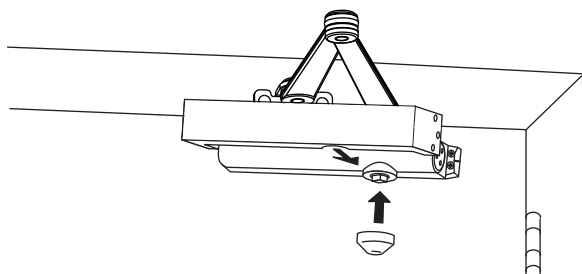

R8500 Series

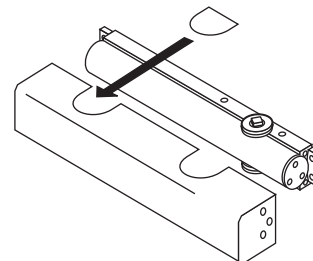

Unit Adjustment

Closing Power Adjustment –

Using "Power Adjustment Chart" from page 2, select the correct number of turns for power adjustment shaft that corresponds with the installation. With 5/16" socket or adjustable wrench, rotate adjustment full 360° clockwise turns to desired setting. After closer has been installed and proper adjustments made to the sweep and latch, it may be necessary to readjust spring power for good closing action.

Control Valve Adjustments

(see Figure 2)

Closing Speed Controls (Figure 1A or 1B And 2.)

- Valve "S" Controls Sweep Range.
 - Valve "L" Controls Latch Range.
 - Valve "D" Controls Delay Range.
- For optional Delayed Action models.

Opening Cycle

- "Backcheck" valve controls the strength of cushioning in Backcheck Range. NEVER close this valve completely – it is not to provide a positive stop. (see Figure 4 and Figure 5).

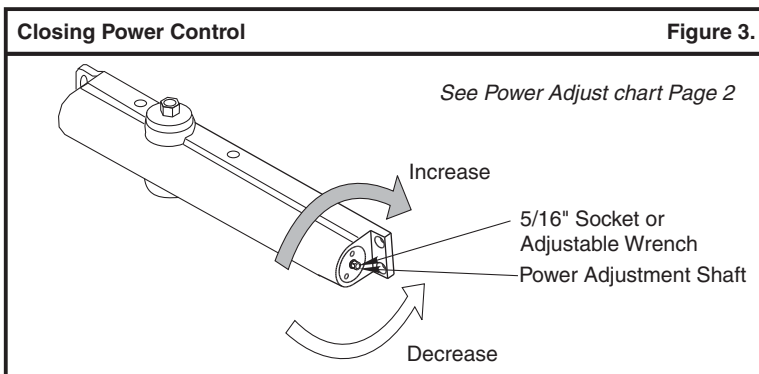
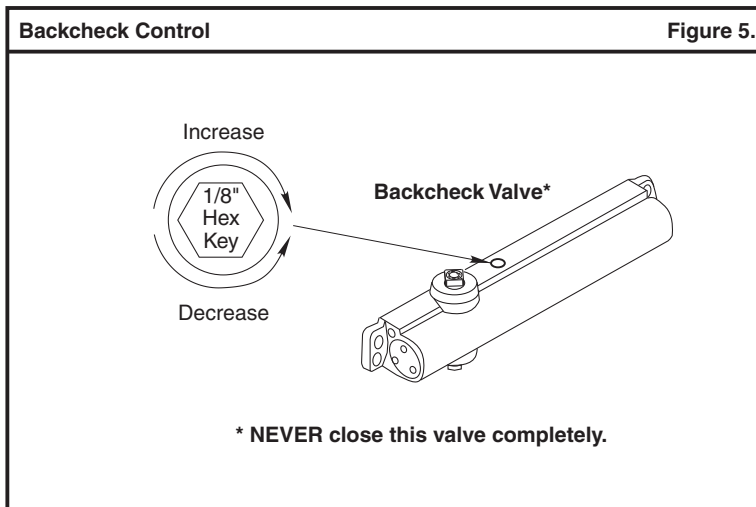
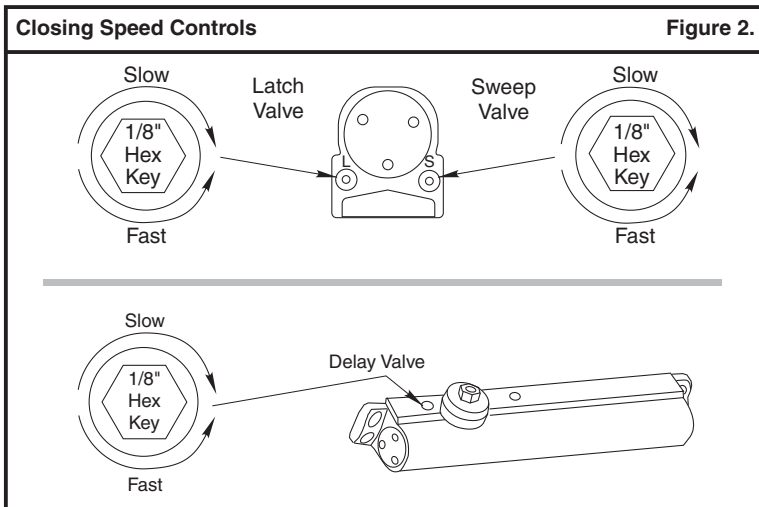
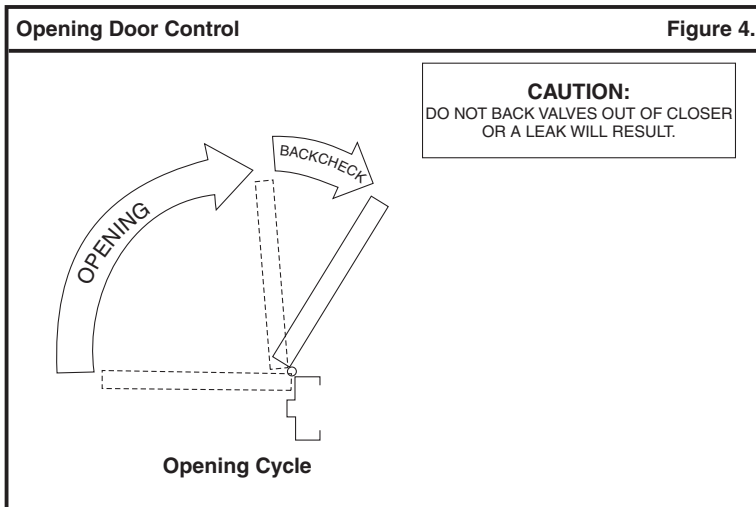
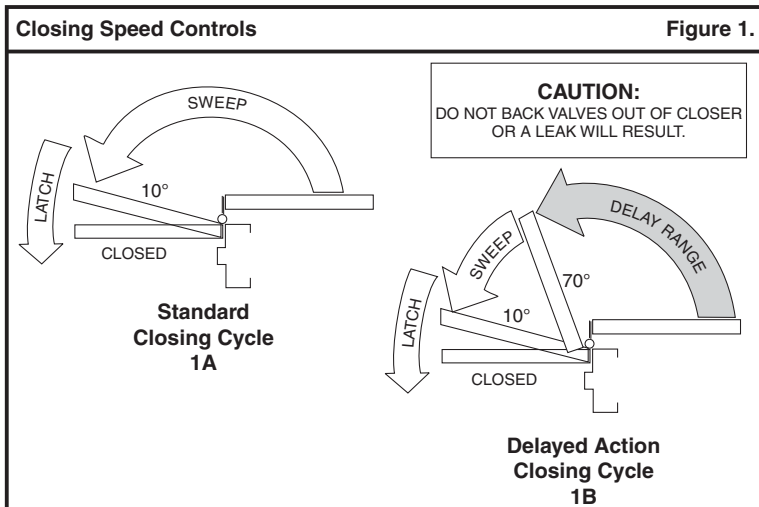

ASSA ABLOY

3000 Highway 74 East • Monroe, NC 28112
Tel: (877)-974-2255 • Fax: (800)-338-0965
www.nortondoорcontrols.com