

Healthcare Hardware



Table of Contents

Healthcare Hardware

HP Series Bored Lock with Push/Pull ALP Trim	3
114/115 Series Push/Pull Trim	4
8200/7800 Series Features	5
8200 Series with BHW Trim	6
8200 Series with BHL Trim	7
8200 Series with Push/Pull Trim (ALP)	8
7800 Series with Push/Pull Trim (PT)	9
7800 Series with Behavioral Health Knob Trim (BHD)	10
9200 Series with Behavioral Health Knob Trim for High Security (BHD)	11-12
Functions & Descriptions	13-19
Electrical Functions and Requirements	20
Power Supplies and Requirements	21
Turns, Emergency Releases and Indicators	22
Cylinders and Rosettes	23-24
Strikes and Fronts & Screw Packs	25
Cylinder & Mechanical Options	26-27
How To Order & Finishes	28
Handing Information	29
8200/7800 Series and HP Certifications	30
Multi-Functional Lockbody & Architectural Specifications	31-32

Any retrofit or other field modification to a fire rated opening can potentially impact the fire rating of the opening, and Sargent Manufacturing Company makes no representations or warranties concerning what such impact may be in any specific situation. When retrofitting any portion of an existing fire rated opening, or specifying and installing a new fire-rated opening, please consult with a code specialist or local code official (Authority Having Jurisdiction) to ensure compliance with all applicable codes and ratings.



MicroShield®

As part of their promise to provide innovative solutions to their customers, certain ASSA ABLOY Group brands offer the MicroShield® technology, a silver-based antimicrobial coating designed to inhibit the growth of bacteria.

MicroShield® is a registered trademark of Yale Security Inc., an ASSA ABLOY Group company.

MicroShield® Coating

- Revolutionary finish coating available on all SARGENT product lines, utilizes a silver-based antimicrobial compound from Agion Technologies
- As an integral part of the finish coating, MicroShield® lasts for the life of the hardware
- MicroShield® coating permanently suppresses the growth of bacteria, algae, fungus, mold and mildew. It is effective against a broad spectrum of bacteria.
- Non-toxic and completely safe. The Agion antimicrobial compound is EPA and NSF approved and FDA listed for use in medical and food preparation equipment.
- Applications: Anywhere there is need for a clean environment (hospitals, laboratories, schools, medical centers, daycare, food processing etc.)

HP Series Bored Lock with Push/Pull ALP Trim

Healthcare Hardware

SARGENT
ASSA ABLOY

HP Bored Lock with Push/Pull Trim

The HP Series Bored Lock with ALP push/pull trim provides an aesthetically-pleasing alternative to standard push/pull products. Ease of operation allows its use in many environments, including healthcare and education. The paddle shape and location create a comfortable target for door activation without using hands.

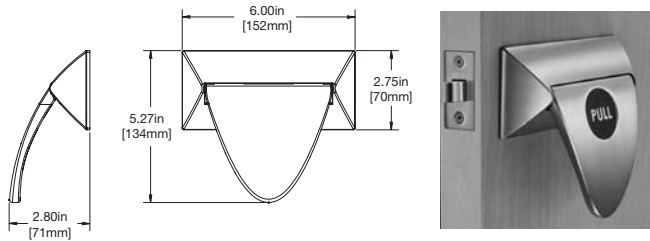

Features

- Paddle trim can be mounted in horizontal (up or down) or vertical (sideways) orientations in the field
- Easy installation
- 15 function trim is non-handed; lockbody is easily field reversible
- Through-bolted trim for stability
- Available in 2-3/4", 5" or 7" backsets
- UL Fire Rating standard
- Torx® and spanner screws optional with ALP
- Lead lining is optional: specify 74- option
- Covers and paddles are cast stainless steel
- Finish: 32D
- Patent pending and/or patent www.assaabloydss.com/patents

Specifications

Door Thickness	1-3/4" (44mm) to 1-7/8" (47mm) standard; for doors greater than 1-7/8" (47mm) to 2-1/4" (57mm), specify 31- and door thickness (For thicker doors, consult factory)		
Backset	5" (127mm) standard. For 2-3/4" (70mm) backset (specify as 24-HP) and 7" (177mm) backset (specify as 26-HP) available on order		
Strike	2-3/4" (70mm) ANSI A115.2 curved lip strike # 800		
Bolt	Brass, 1/2" (13mm) throw		
Hand	Specify hand (RHR, RH, LHR or LH)		
Escutcheons	Cast stainless steel		
UL Listed	UL Listed for use on fire doors (4x10 opening)		
Options	Backsets	24-	2-3/4" (70mm) backset
		26-	7" (177mm) backset
	Strikes	14-	505 Full Lip Strike
		28-	4-7/8" (124mm) ANSI curved lip strike # 808
		WBS-	Wrought Box Strike
	Thick Doors	31-	For doors thicker than 1-7/8" to 2-1/4"; specify 31- and door thickness
	Security Screws	36-	6-Lobe Security Head Screws
		37-	Spanner Security Head Screws
	Lead Lining	74-	Lead lined
Antimicrobial Coating	SG-	MicroShield® – Antimicrobial clear powder coat (only available with 32D finish)	
Markers	P-	Push/Pull Paddle Identification (non-handed)	
Finishes	32D For other finishes consult factory		
Finish Protection	CPC-	Clear Powder Coat	
Door Prep	ANSI A115.1 modified per SARGENT standard bored template 4695		

How To Order

SG-	HP	U65	ALP	32D	RHR
Option	Series	Function	Trim	Finish	Hand
Mechanical Options this page	HP Series Bored Locks	U15 - Passage U65 - Privacy	Push/Pull Trim	32D	RHR LHR RH LH

Always specify hand of lock
 - 15 function is Non-Handed
 - 5" Backset standard with square corner front, 2-1/4" x 1-1/8"

Series and Function	Descriptions
HPU15 Passage Set	- Both paddles retract latch - Ideal for patient rooms and closets
HPU65 Privacy Set 	- I/S paddle always retracts latch - O/S paddle retracts latch, except when locked by inside push button - Closing door unlocks outside paddle - Includes emergency release - Ideal for bathrooms - Vertical orientation required

Experience a safer
and more open world

1-800-727-5477 • www.sargentlock.com

3

Copyright © 2007-2020, Sargent Manufacturing Company. All rights reserved. Reproduction in whole or in part without the express written permission of Sargent Manufacturing Company is prohibited.

90712 04/20

114/115 Series Push/Pull Trim

Healthcare Hardware

SARGENT
ASSA ABLOY

Designed for convenience and utility, the 114/115 hospital latches open with a gentle pull or slight push, making them ideal for hands free operation. Both the 114 push-pull and 115 push-pull latch with its low profile helps eliminate any obstruction while passing through an opening. Slim tapered paddles and smartly styled escutcheons possess all the elements of tasteful, yet functional design. The chassis design makes this hospital latch constructed for both durability and ease of install.

Specifications

For Doors	1-3/4" (44mm) to 2-1/4" (57mm)		
Backset	5" (127mm) standard. For 2-3/4" (70mm) backset (specify as 24-115) and 7" (177mm) backset (specify as 26-115) available on order		
Strike	2-3/4" (70mm) ANSI A115.2 curved lip strike # 800		
Bolt	Brass, 1/2" (13mm) throw		
Hand	Specify hand (RHR, RH, LHR or LH)		
114	Push/Pull Paddles - both mounted down position only. Cast; Projection from door 3-1/4" (83mm)		
115	Push Paddle - mounted up position only . Cast; 1-5/8" (41mm) x 4-1/2" (114mm); Projection from door 2-1/2" (64mm)		
115	Pull Paddle - mounted down position only . Cast; 1-5/8" x 4-3/4"; Projection from door 2-15/16"		
Escutcheons	Cold drawn; 2-1/2" (64mm) x 6-7/8" (175mm)		
UL Listed	UL Listed for use on fire doors. See Underwriters Laboratories Building Materials List		
Options	Backsets	24-	2-3/4" (70mm) backset
		26-	7" (177mm) backset
	Strike	28-	4-7/8" (124mm) ANSI curved lip strike # 808
		WBS-	Wrought Box Strike
	Security Screws	36-	6-Lobe Security Head Screws
		37-	Spanner Security Head Screws
	Lead Lining	74-	Lead lined. Specify Push or Pull side
	Antimicrobial Coating	SG-	MicroShield® - Antimicrobial clear powder coat (only available with 15 and 26D finishes)
	Push/Pull Marking	P-	P- Push/Pull to be stamped on each escutcheon
Through Bolts	TB-	Through-bolt pack, specify door thickness: 1-3/4", 2" & 2-1/4"	
Finishes	03, 04, 09, 10, 10B, 10BE, 15, 26, 26D For other finishes consult factory		

114 Push-Pull



114 latches are mounted in the down position as shown and are available with "PUSH" and "PULL" stamped into the top of the escutcheon.

115 Push-Pull



Designed for convenience and utility, the 114/115 hospital latches open with a gentle pull or slight push, making them ideal for hands free operation. Both the 114 push-pull and 115 push-pull latch with its low profile helps eliminate any obstruction while passing through an opening. Slim tapered paddles and smartly styled escutcheons possess all the elements of tasteful, yet functional design. The chassis design makes this hospital latch constructed for both durability and ease of install.

8200/7800 Series Mortise Lock Features

Healthcare Hardware



The patented SARGENT Mortise Locks are designed and constructed with high quality components to provide maximum security, performance and durability. These locks represent over a century of innovation and experience in manufacturing hardware and are the industry's benchmark for mortise locks: Strong - Durable - Flexible - Innovative and Secure.

8237 with ALP trim shown

Outside front plate: 1/16" (1.6mm) brass, bronze or stainless steel. Adjustable for door bevels from flat to 1/8" (3mm) in 2" (51mm)

3/4" (19mm) projection stainless steel one-piece latchbolt, reversible without opening case. Anti-friction piece is securely staked in place for quiet operation and prevents scratching of strike plate

Non-handed stainless steel auxiliary deadlatch

Inside front: 1/8" (3mm) cold rolled steel holds lock securely in door

Patent pending and/or patent
www.assaabloydss.com/patents

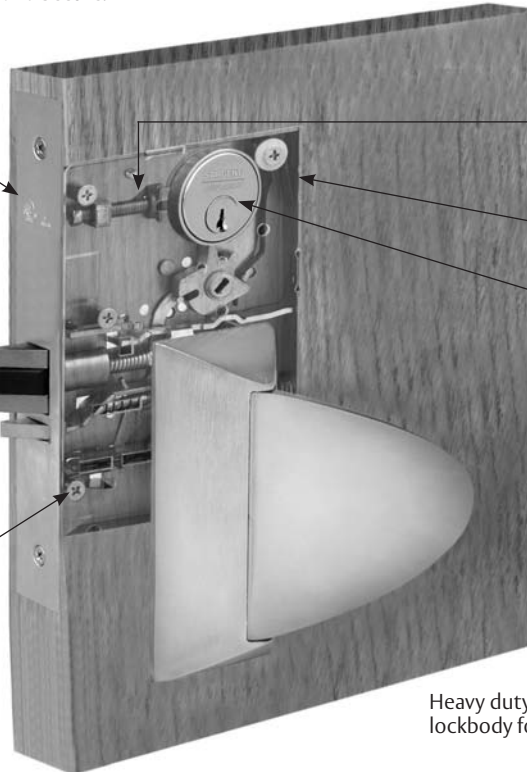

Cylinder retainer-two prong grip meets Security Grade 1

Extra strong 7/64" (3mm) steel case for improved impact resistance

6-pin solid brass cylinder standard; multiple keying systems available

Heavy gauge corrosion resistant parts through out provide security, reliability, durability and longevity



Heavy duty hubs and spring cartridge with in the lockbody for superior strength and cycle life

8200 & 7800 Series Lockbody Dimensions

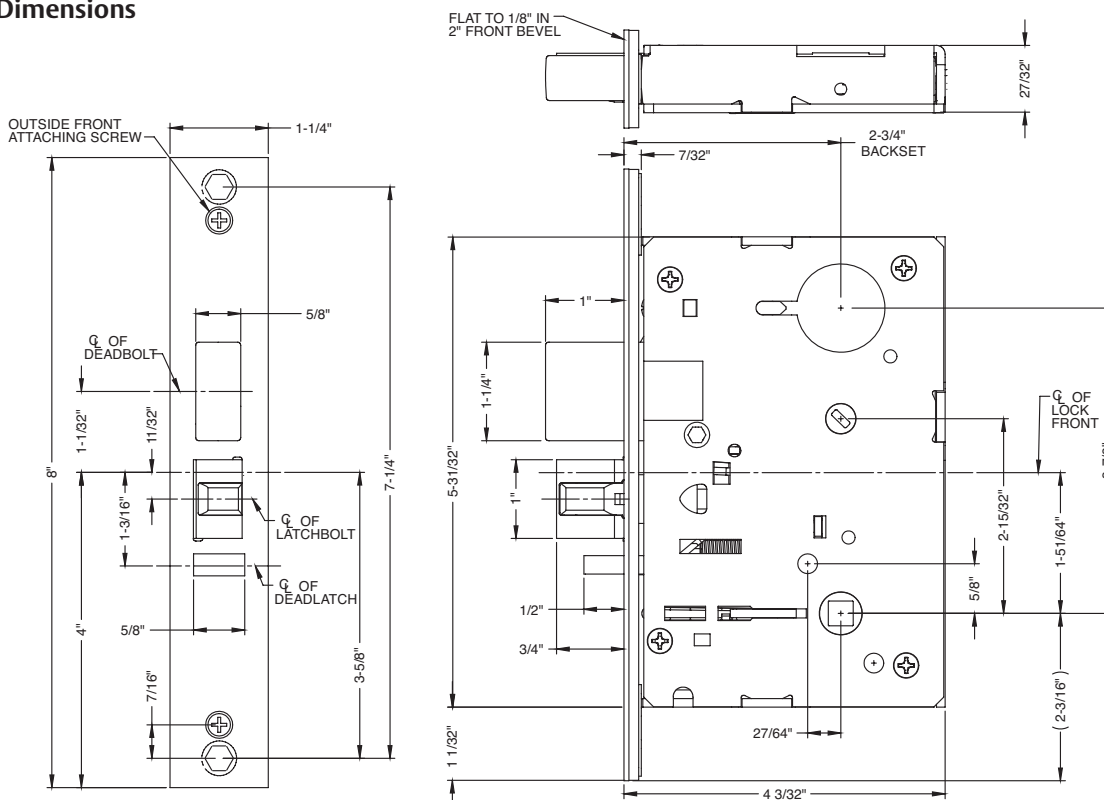

Experience a safer and more open world

1-800-727-5477 • www.sargentlock.com

8200 Series with BHW* Trim

Healthcare Hardware

SARGENT
ASSA ABLOY

8200 Series with BHW Trim

Part of the Behavioral Health Series® of products, the 8200 Series mortise lock with BHW trim provides an innovative solution for behavioral health environments. The unique integrated lever and escutcheon combines aesthetics with safety. Ease of operation, along with the strength and versatility of the 8200 Series mortise lock allows its use in many applications.

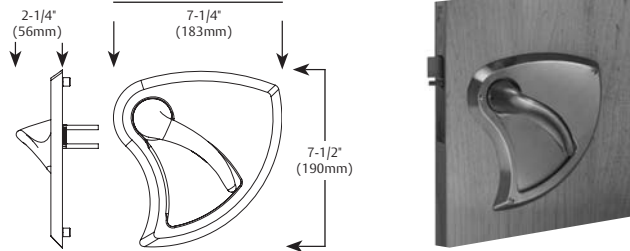

How To Order

SG-11- Option	82 Series	37 Function	BHW Trim	32D Finish	RHR Hand
Mechanical Options this page	8200 Series Mortise Locks	See pages 13-20	Lever & Escutcheon	32D	RHR
Cylinder Options page 23					LHR
					RH
					LH

Features

- ANSI/BHMA Grade 1
- Available in 37 functions
- Uses standard mortise prep
- Easy installation
- Tapered surfaces on all components
- ADA Compliant
- Available with MicroShield®, an antimicrobial coating
- 6 Lobe head security screws (Torx® type) are standard with BHW Trim
- Matching thumbturn available
- Finish: 32D
- Trim only option available with existing sectional and escutcheon trim only
- Handed
- Trim only kits:
 - 694-1 Trim only, non-keyed functions (BHW Trim only)
 - 694-2 Trim only, single cylinder functions (BHW Trim only)
 - 694-3 Trim only, double cylinder (BHW Trim only)
- Patent pending and/or patent www.assaabloydss.com/patents

Specifications

Door Thickness	1-3/4" (44mm) to 1-7/8" (47mm) standard; for doors greater than 1-7/8" (47mm) to 2-1/4" (57mm), specify 31- and door thickness (For thicker doors, consult factory)	
Backset	2-3/4" (70mm) only	
Case	12 gauge heavy duty wrought steel, zinc dichromate plated. Thickness 7/64" (3mm) (.109")	
Outside Front Plate	Brass, bronze or stainless steel. 8" (203mm) x 1-1/4" (31mm), ANSI Standard A115.1. Adjustable at any angle from flat to beveled 1/8" (3mm) in 2" (51mm)	
Springs	High carbon steel	
Latchbolt	Stainless steel 3/4" (19mm) projection one-piece, anti-friction reversible latch	
Auxiliary Deadlatch	Stainless steel, non-handed	
Deadbolt	One-piece hardened stainless steel, with 1" (25mm) projection	
Hand	Handed - Must specify hand on order	
Mechanical Options	Cylinders	Cylinder Options see page 26-27
	Strikes	23- 4-7/8" (124mm) ANSI Strike with 1-1/8" (29mm) Flat Lip
		OBS- Open Back Strike
		WBS- Wrought Box Strike
	Thick Doors	31- For doors thicker than 1-7/8" to 2-1/4"; specify 31- and door thickness
	Electrical Options	DX- Deadbolt monitoring - Monitor deadbolt position (not available with LX-)
		LX- Latchbolt monitor - Monitors latchbolt position (not available with deadbolt functions)
		RX- Request to Exit - Monitors each lever independently
	Lead Lining	74- Lock case wrapped in lead (specify hand)
Antimicrobial Coating	SG- MicroShield® - antimicrobial clear powder coat (available with 32D finish only)	
Strike	Brass, bronze or stainless steel; ANSI Standard A115.1; curved lip, non-handed (strike box optional)	
Keys	Two, nickel silver (control key or emergency key must be ordered when required) #41 (1-1/8") cylinder supplied standard	
Masterkeying	Can be masterkeyed or grand masterkeyed. Construction keying available	
Stile	8-1/2" (216mm) minimum stile	
Door Prep	ANSI A115.1 modified per SARGENT standard mortise template A4711	

Packaging

8205 x BHW	approx. 6.1 lbs. (2.7kg)/box
------------	------------------------------

* Although these products are better designed for behavioral health applications than traditional trim, they do not eliminate the risk that an object can be affixed to, or around them.

8200 Series with BHL* Trim

Healthcare Hardware

8200 with BHL Trim

The SARGENT BHL trim is part of the Behavioral Health Series® of products. With an array of functions, this trim can be used on virtually any opening in healthcare applications. Sloping surfaces and overlapping rose and lever address safety concerns common in behavioral health. Optimal for tough environments, the SARGENT 8200 Series mortise lock provides impressive strength and reliability.

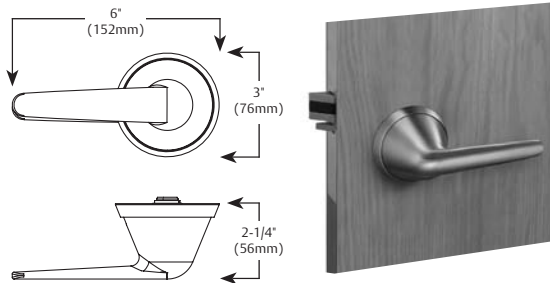

How To Order

SG-11- Option	82 Series	37 Function	BHL Trim	32D Finish	LH Hand
Mechanical Options this page	8200 Series Mortise Locks	See pages 13-20	BHL	32D	RHR
Cylinder Options page 23					LHR
					RH
					LH

Features

- Available in 22 functions
- UL Fire Rated
- ANSI/BHMA Grade 1
- Inside and outside levers rotate freely up and down to 45° when locked
- Sloped surfaces
- Concealed hardware
- Overlapping lever and rose construction
- ADA compliant
- 6 Lobe head security screws (Torx® type) are standard with BHL Trim
- Non-handed
- Finish: 32D
- Available with MicroShield®, an antimicrobial coating

Specifications

Door Thickness	1-3/4" (44mm) to 1-7/8" (47mm) standard; for doors greater than 1-7/8" (47mm) to 2-1/4" (57mm), specify 31- and door thickness (For thicker doors, consult factory)			
Backset	2-3/4" (70mm) only			
Case	12 gauge heavy duty wrought steel, zinc dichromate plated. Thickness 7/64" (3mm) (.109")			
Outside Front Plate	Brass, bronze or stainless steel. 8" (203mm) x 1-1/4" (31mm), ANSI Standard A115.1. Adjustable at any angle from flat to beveled 1/8" (3mm) in 2" (51mm)			
Springs	High carbon steel			
Latchbolt	Stainless steel 3/4" (19mm) projection one-piece, anti-friction reversible latch			
Auxiliary Deadlatch	Stainless steel, non-handed			
Deadbolt	One-piece hardened stainless steel, with 1" (25mm) projection			
Hand	Non-handed			
Mechanical Options	Cylinders	Cylinder Options see page 26-27		
	Strikes	23-	4-7/8" (124mm) ANSI Strike with 1-1/8" (29mm) Flat Lip	
		OBS-	Open Back Strike	
		WBS-	Wrought Box Strike	
	Thick Doors	31-	For doors thicker than 1-7/8" to 2-1/4"; specify 31- and door thickness	
	Security Screws	37-	Spanner head security screws (available with front plate and strike only)	
	Lead Lining	74-	Lock case wrapped in lead (specify hand)	
	Antimicrobial Coating	SG-	MicroShield® - antimicrobial clear powder coat (available with 32D only)	
	Electrical Options	DX-	Deadbolt monitoring - Monitor deadbolt position (not available with LX-)	
LX-		Latchbolt monitor - Monitors latchbolt position (not available with deadbolt functions)		
Strike	Brass, bronze or stainless steel; ANSI Standard A115.1; curved lip, non-handed (strike box optional)			
Keys	Two, nickel silver (control key or emergency key must be ordered when required) #41 (1-1/8") cylinder supplied standard			
Masterkeying	Can be masterkeyed or grand masterkeyed. Construction keying available			
Stile	4-1/2" (114mm) minimum stile			
Door Prep	ANSI A115.1 modified per SARGENT standard mortise template A7057			

Packaging

8205 x BHL	approx. 6.1 lbs. (2.7kg)/box	6 boxes/case
------------	------------------------------	--------------

Experience a safer
and more open world

* Although these products are a better design for behavioral health applications than traditional trim, they do not eliminate the risk that an object can be affixed to, or around them.

8200 Series with Push/Pull Trim (ALP)

Healthcare Hardware



8200 Series with Push/Pull Trim (ALP)

The Series 8200 mortise lock with push/pull trim provides an aesthetically-pleasing alternative to standard push/pull products. Ease of operation, along with the strength, versatility and integrity of the 8200 Series mortise lock, allows its use in many types of environments. Perfect for health care facilities, including behavioral health units, patient room doors and operating rooms.

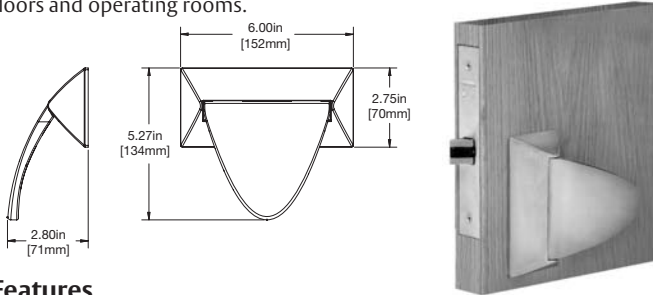

How To Order

SG-11- Option	82 Series	37 Function	ALP Trim	32D Finish	LHR Hand
Mechanical Options this page	8200 Series Mortise Locks	See pages 13-20	Lever	32D	RHR
Cylinder Options page 23					LHR
					RH
					LH

NOTE: ALP trim requires a special 8200 mortise lock body, which is shipped automatically when ALP is specified. When ordering a lock body only for use with ALP trim, please refer to your SARGENT Price Book for the correct ordering number.

Features

- Paddle trim can be mounted in horizontal (up or down) and vertical (sideways) orientations in the field
- Easy installation
- Trim is non-handed; lockbody is easily field reversible
- Through-bolted trim for stability
- Torx® and spanner screws optional with ALP
- Lead lining is optional (Lockbody only), specify 74- option
- Covers are cast stainless steel
- Paddles are cast stainless steel
- Finish: 32D
- Patent pending and/or patent www.assaabloydss.com/patents

Specifications

Door Thickness	1-3/4" (44mm) to 1-7/8" (47mm) standard; for doors greater than 1-7/8" (47mm) to 2-1/4" (57mm), specify 31- and door thickness (for thicker doors, consult factory)	
Backset	2-3/4" (70mm) only	
Case	12 gauge heavy duty wrought steel, zinc dichromate plated. Thickness 7/64" (3mm) (.109")	
Outside Front Plate	Brass, bronze or stainless steel. 8" (203mm) x 1-1/4" (31mm), ANSI Standard A115.1. Adjustable at any angle from flat to beveled 1/8" (3mm) in 2" (51mm)	
Springs	High carbon steel	
Latchbolt	Stainless steel 3/4" (19mm) projection one-piece, anti-friction reversible latch	
Auxiliary Deadlatch	Stainless steel, non-handed	
Deadbolt	One-piece hardened stainless steel, with 1" (25mm) projection	
Hand	Specify hand on order; easily field reversible	
Mechanical Options	Cylinders	Cylinder Options see page 26-27
	Strikes	23- 4-7/8" (124mm) ANSI Strike with 1-1/8" (29mm) Flat Lip
		OBS- Open Back Strike
		WBS- Wrought Box Strike
	Thick Doors	31- For Doors Thicker than 1-7/8" to 2-1/4"; specify 31- and door thickness
	Security Screws	36- 6 Lobe head security screws (Torx® type)
		37- Spanner head security screws
	Indicators	49- Visual Status Indicator or Occupancy Indicator w/Emergency Release
		50- Secured Indicator
	Lead Lining	74- Lock case wrapped in lead (specify hand)
Antimicrobial Coating	SG- MicroShield® - antimicrobial clear powder coat (only available with 32D finish)	
Markers	P- Push/Pull Paddle Identification (Non-handed)	
Strike	Brass, bronze or stainless steel; ANSI Standard A115.1; curved lip, non-handed (strike box optional)	
Keys	Two, nickel silver (control key or emergency key must be ordered when required) #41 (1-1/8") cylinder supplied standard	
Masterkeying	Can be masterkeyed or grand masterkeyed. Construction keying available	
Stile	4-1/2" (114mm) minimum stile	
Door Prep	ANSI A115.1 modified per SARGENT standard mortise template A7057	

Packaging

8205 x ALP	approx. 6.1 lbs. (2.7kg)/box	6 boxes/case
------------	------------------------------	--------------

7800 Series with Push/Pull Trim (PT)

Healthcare Hardware

7800 Series with Push/Pull Trim (PT)

The Push/Pull design known for its ease of operation is coupled with the strength and integrity of a mortise lock to provide greater versatility. The trim, commonly used in hospitals and health care facilities, can now service conference rooms, handicapped restrooms, laboratories and pharmaceutical facilities that require more durability and security features than a cylindrical lock can provide.

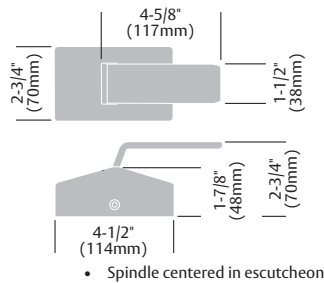

7837 PT
Horizontal Mount Shown

How To Order

SG-11-	78	37	PT	32D	LH
Option	Series	Function	Trim	Finish	Hand
Mechanical Options this page	7800 Series Mortise Locks	See pages 13-20	Push/Pull Trim	03, 04, 09, 10, 10B, 10BE, 10BL, 20D, 32 or 32D	RHR
					LHR
Cylinder Options page 23					RH
					LH

NOTE: The PT trim is always supplied with an 7800PT mortise lockbody, all mortise lockbodies are labeled for ease of identification. When ordering lockbody only for PT trim, always specify 7800PT lockbody.

Features

- Paddle trim orientation can be mounted in vertical (up or down) and horizontal positions as a standard product, no need for specifying mount positions on order
- Down or horizontal paddle orientation is required for cylinder side of door
- Horizontal paddle orientation is required if thumb turn or a emergency release is used
- Patent pending and/or patent www.assaabloydss.com/patent
- Easy installation
- Handing is easily field reversible
- Through-bolted trim for stability
- 6 Lobe security type screws (Torx®) standard for PT trim
- Engraving on paddle – consult factory
- Lead lining is optional (Lockbody only), specify 74- option
- Covers are heavy wrought stainless steel, brass or bronze
- Paddles are cast stainless steel, brass or bronze
- Finishes: 3, 4, 9, 10, 10B, 10BE, 10BL, 20D, 32, 32D

Specifications

For Doors	Door thickness 1-3/4" (44mm) to 2" (51mm) standard with adaptable spindle. For thicker doors, consult factory.		
Backset	2-3/4" (70mm) only		
Case	12 gauge heavy duty wrought steel, zinc dichromate plated. Thickness 7/64" (3mm) (.109")		
Outside Front Plate	Brass, bronze or stainless steel. 8" (203mm) x 1-1/4" (31mm), ANSI Standard A115.1. Adjustable at any angle from flat to beveled 1/8" (3mm) in 2" (51mm) 1/8" (3mm) in 2" (51mm)		
Springs	High carbon steel		
Latchbolt	Stainless steel 3/4" (19mm) projection one-piece, anti-friction reversible latch		
Auxiliary Deadlatch	Stainless steel, non-handed		
Deadbolt	One-piece hardened stainless steel, with 1" (25mm) projection		
Hand	Specify hand on order; easily field reversible		
Mechanical Options	Cylinders	Cylinder Options see page 26-27	
	Strikes	23- 4-7/8" (124mm) ANSI Strike with 1-1/8" (29mm) Flat Lip	
		OBS- Open Back Strike	
		WBS- Wrought Box Strike	
	Security Screws	37- Spanner head security screws	
	Electrical Options	DX- Deadbolt monitoring - Monitor deadbolt position (not available with LX-)	
		LX- Latchbolt monitor - Monitors latchbolt position (not available with deadbolt functions)	
RX- Request to Exit - Monitors each lever independently			
Lead Lining	74- Lock case wrapped in lead (specify hand)		
Antimicrobial Coating	SG-	MicroShield® - antimicrobial clear powder coat (available with 32D finish only)	
Strike	Brass, bronze or stainless steel; ANSI Standard A115.1; curved lip, non-handed (strike box optional)		
Keys	Two, nickel silver (control key or emergency key must be ordered when required)		
Masterkeying	Can be masterkeyed or grand masterkeyed. Construction keying available		
Stile	5" (127mm) minimum stile for 7800 Push/Pull Trim		
Door Prep	ANSI A115.1 modified per template (see template 4512 only)		

7800 Series with BHD* Trim

Healthcare Hardware



7800 Series with BHD Trim

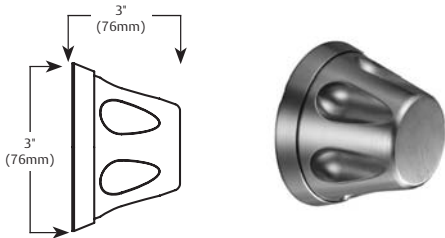

How To Order

SG-67	78	37	BHD	32D
Option	Series	Function	Trim	Finish
Mechanical Options this page	7800 Series Mortise Locks	See pages 13-20	Knob	32D
Cylinder Options page 23				

Features

- Available in 36 functions
- UL Fire Rated
- ANSI/BHMA Grade 1
- Sloped surfaces on all components
- Overlapping knob and rose construction
- Finish: 32D
- Available with MicroShield® option, antimicrobial coating

Specifications

Door Thickness	1-3/4" (44mm) to 1-7/8" (47mm) standard; for doors greater than 1-7/8" (47mm) to 2-1/4" (57mm), specify 31- and door thickness (for thicker doors, consult factory)		
Backset	2-3/4" (70mm) only		
Case	12 gauge heavy duty wrought steel, zinc dichromate plated. Thickness 7/64" (3mm) (.109")		
Outside Front Plate	Brass, bronze or stainless steel. 8" (203mm) x 1-1/4" (31mm), ANSI Standard A115.1. Adjustable at any angle from flat to beveled 1/8" (3mm) in 2" (51mm)		
Springs	High carbon steel		
Latchbolt	Stainless steel 3/4" (19mm) projection one-piece, anti-friction reversible latch		
Auxiliary Deadlatch	Stainless steel, non-handed		
Deadbolt	One-piece hardened stainless steel, with 1" (25mm) projection		
Hand	Non-handed		
Mechanical Options	Cylinders	Cylinder Options see page 26-27	
	Strikes	23-	4-7/8" (124mm) ANSI Strike with 1-1/8" (29mm) Flat Lip
		OBS-	Open Back Strike
		WBS-	Wrought Box Strike
	Lever/Knob Combination	67-	Lock furnished w/ knob both sides (Not available with AV-Option)
		68-	Lock furnished w/ lever handle outside x knob inside (Not available with AV-Option)
		69-	Lock furnished w/ lever handle inside x knob outside (Not available with AV-Option)
	Thick Doors	31-	For Doors Thicker than 1-7/8" to 2-1/4"; specify 31- and door thickness
	Security Screws	36-	6 Lobe head security screws (Torx® type)
		37-	Spanner head security screws
Electrical Options	DX-	Deadbolt monitoring - Monitor deadbolt position (not available with LX-)	
	LX-	Latchbolt monitor - Monitors latchbolt position (not available with deadbolt functions)	
Lead Lining	74-	Lock case wrapped in lead (specify hand)	
Antimicrobial Coating	SG-	MicroShield® - antimicrobial clear powder coat (available in 32D only)	
Strike	Brass, bronze or stainless steel; ANSI Standard A115.1; curved lip, non-handed (strike box optional)		
Keys	Two, nickel silver (control key or emergency key must be ordered when required) #41 (1-1/8") cylinder supplied standard		
Masterkeying	Can be masterkeyed or grand masterkeyed. Construction keying available		
Stile	4-1/2" (114mm) minimum stile		
Door Prep	ANSI A115.1 modified per SARGENT standard mortise template A7057		

* Although these products are a better design for behavioral health applications than traditional trim, they do not eliminate the risk that an object can be affixed to, or around them.

Packaging

7837 x BHD	approx. 6.1 lbs. (2.7kg)/box	6 boxes/case
------------	------------------------------	--------------

10

1-800-727-5477 • www.sargentlock.com

Experience a safer and more open world

9200 Series with BHD* Trim for High Security

Healthcare Hardware

SARGENT
ASSA ABLOY

9200 Series with BHD Trim for High Security

The 9200 Series with BHD Trim is designed to provide additional safety on openings that withstand extreme abuse, vandalism and malicious impact. It is well-suited for Psychiatric and minimum security detention facilities, as well as exposed perimeter doors in commercial facilities.

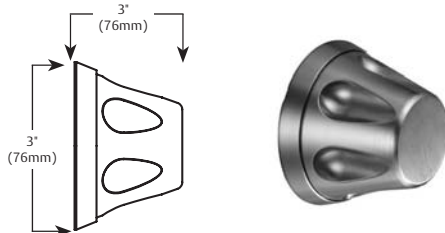

How To Order

SG-67	92	37	BHD	32D
Option	Series	Function	Trim	Finish
Mechanical Options this page	9200 Series Mortise Locks	See pages 13-20	Knob	32D

Features

- Available in 26 functions
- UL Fire Rated
- ANSI/BHMA Grade 1
- Sloped surfaces on all components
- Overlapping knob and rose construction
- Finish: 32D
- Available with MicroShield® option, antimicrobial coating option

Specifications

Door Thickness	1-3/4" (44mm) to 1-7/8" (47mm) standard; for doors greater than 1-7/8" (47mm) to 2-1/4" (57mm), specify 31- and door thickness (For thicker doors, consult factory)	
Backset	2-3/4" (70mm) only	
Case	12 gauge heavy duty wrought steel, zinc dichromate plated. Thickness 7/64" (3mm) (.109")	
Outside Front Plate	Brass, bronze or stainless steel. 8" (203mm) x 1-1/4" (31mm), ANSI Standard A115.1. Adjustable at any angle from flat to beveled 1/8" (3mm) in 2" (51mm)	
Springs	High carbon steel	
Latchbolt	Stainless steel 3/4" (19mm) projection one-piece, anti-friction reversible latch	
Auxiliary Deadlatch	Stainless steel, non-handed	
Deadbolt	One-piece hardened stainless steel, with 1" (25mm) projection	
Hand	Non-handed	
Mechanical Options	Cylinders	Cylinder Options see page 26-27
	Strikes	23- 4-7/8" (124mm) ANSI Strike with 1-1/8" (29mm) Flat Lip
		OBS- Open Back Strike
		WBS- Wrought Box Strike
	Lever/Knob Combination	67- Lock furnished w/ knob both sides (Not available with AV-Option)
		68- Lock furnished w/ lever handle outside x knob inside (Not available with AV- Option)
		69- Lock furnished w/ lever handle inside x knob outside (Not available with AV-Option)
	Thick Doors	31- For Doors Thicker than 1-7/8" to 2-1/4"; specify 31- and door thickness
	Security Screws	36- 6 Lobe head security screws (Torx® type)
		37- Spanner head security screws
Lead Lining	74- Lock case wrapped in lead (specify hand)	
Antimicrobial Coating	SG- MicroShield® - antimicrobial clear powder coat (available in 32D only)	
Strike	Brass, bronze or stainless steel; ANSI Standard A115.1; curved lip, non-handed (strike box optional)	
Keys	Two, nickel silver (control key or emergency key must be ordered when required) #41 (1-1/8") cylinder supplied standard	
Masterkeying	Can be masterkeyed or grand masterkeyed. Construction keying available	
Stile	4-1/2" (114mm) minimum stile	
Door Prep	ANSI A115.1 modified per SARGENT standard mortise template A7057	

Packaging

9237 x BHD	approx. 6.1 lbs. (2.7kg)/box	6 boxes/case
------------	------------------------------	--------------

* Although these products are a better design for behavioral health applications than traditional trim, they do not eliminate the risk that an object can be affixed to, or around them.

Experience a safer
and more open world

1-800-727-5477 • www.sargentlock.com

11

9200 Series with BHW Trim for High Security

Healthcare Hardware

SARGENT
ASSA ABLOY

9200 Series with BHW Trim for High Security

The 9200 Series with BHW Trim is designed to provide additional safety on openings that withstand extreme abuse, vandalism and malicious impact. It is well-suited for Psychiatric and minimum security detention facilities, as well as exposed perimeter doors in commercial facilities.

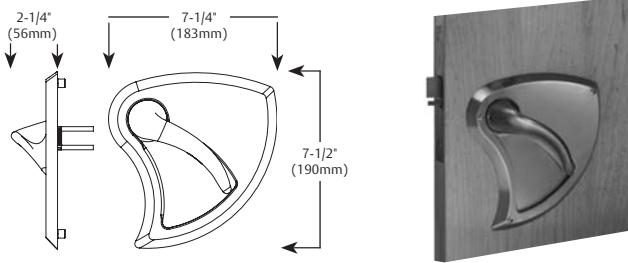

How To Order

SG-67	92	37	BHW	32D
Option	Series	Function	Trim	Finish
Mechanical Options this page	9200 Series Mortise Locks	See pages 13-20	Lever and Escutcheon	32D
Cylinder Options page 23				

Features

- ANSI/BHMA Grade 1
- Available in 26 functions
- Uses standard mortise prep
- Trim Only option available with existing sectional and escutcheon trim only
- Tapered surfaces on all components
- Available with MicroShield®, an antimicrobial coating
- ADA Compliant
- 6 Lobe head security screws (Torx® type) are standard with BHW Trim
- Matching thumbturn available
- Finish: 32D
- Handed
- Trim only kits:
 - 694-1 Trim only, non-keyed functions (BHW Trim only)
 - 694-2 Trim only, single cylinder functions (BHW Trim only)
 - 694-3 Trim only, double cylinder (BHW Trim only)
- Patent pending and/or patent www.assaabloydss.com/patent

Specifications

Door Thickness	1-3/4" (44mm) to 1-7/8" (47mm) standard; for doors greater than 1-7/8" (47mm) to 2-1/4" (57mm), specify 31- and door thickness (For thicker doors, consult factory)	
Backset	2-3/4" (70mm) only	
Case	12 gauge heavy duty wrought steel, zinc dichromate plated. Thickness 7/64" (3mm) (.109")	
Outside Front Plate	Brass, bronze or stainless steel. 8" (203mm) x 1-1/4" (31mm), ANSI Standard A115.1. Adjustable at any angle from flat to beveled 1/8" (3mm) in 2" (51mm)	
Springs	High carbon steel	
Latchbolt	Stainless steel 3/4" (19mm) projection one-piece, anti-friction reversible latch	
Auxiliary Deadlatch	Stainless steel, non-handed	
Deadbolt	One-piece hardened stainless steel, with 1" (25mm) projection	
Hand	Handed - Must specify hand on order	
Mechanical Options	Cylinders	Cylinder Options see page 26-27
	Strikes	23- 4-7/8" (124mm) ANSI Strike with 1-1/8" (29mm) Flat Lip
		OBS- Open Back Strike
		WBS- Wrought Box Strike
	Thick Doors	31- For doors thicker than 1-7/8" to 2-1/4"; specify 31- and door thickness
	Electrical Options	DX- Deadbolt monitoring - Monitor deadbolt position (not available with LX-)
		LX- Latchbolt monitor - Monitors latchbolt position (not available with deadbolt functions)
		RX- Request to Exit - Monitors each lever independently
Lead Lining	74- Lock case wrapped in lead (specify hand)	
Antimicrobial Coating	SG- MicroShield® - antimicrobial clear powder coat (available with 32D finish only)	
Strike	Brass, bronze or stainless steel; ANSI Standard A115.1; curved lip, non-handed (strike box optional)	
Keys	Two, nickel silver (control key or emergency key must be ordered when required) #41 (1-1/8") cylinder supplied standard	
Masterkeying	Can be masterkeyed or grand masterkeyed. Construction keying available	
Stile	4-1/2" (114mm) minimum stile	
Door Prep	ANSI A115.1 modified per SARGENT standard mortise template A4711	

Packaging

9237 x BHD	approx. 6.1 lbs. (2.7kg)/box
------------	------------------------------

* Although these products are a better design for behavioral health applications than traditional trim, they do not eliminate the risk that an object can be affixed to, or around them.

Available Functions for Healthcare Hardware

	04	05	06	13	15	16	17	24	25	26	27	28	29	30	31	35	36	37	38	39	40	41	43	45	46	47	48	49	50	51	52	55	56	57	58	59	65	66	67	68	70	71	72	73				
7800 BHD	x	x	x	x	x	x	x	x	x	x	x	x	x	x	x	x	x	x	x	x	x	x	x	x	x	x	x	x	x	x	x	x	x	x	x	x	x	x	x	x	x	x	x	x	x	x	x	
7800 PT	x				x	x	x	x		x								x					x	x												x												
8200 ALP	x	x	x	x	x	x	x	x	x	x	x	x	x	x	x	x	x	x	x	x	x	x	x	x	x	x	x	x	x	x	x	x	x	x	x	x	x	x	x	x	x	x	x	x	x	x	x	x
8200 BHL	x	x			x	x	x	x	x	x	x							x	x	x	x																x	x	x									
8200 BHW	x	x			x	x	x	x	x	x	x	x	x					x	x	x	x	x	x	x	x	x	x	x	x	x	x	x	x	x	x	x	x	x	x	x	x	x	x	x	x	x	x	
9200 BHD	x	x	x		x*	x	x	x	x	x							x	x	x	x	x*	x	x					x*	x						x*	x*	x				x*	x*	x*	x*				
9200 BHW	x	x			x	x	x	x	x									x	x	x	x	x	x					x	x																			
M9200BHW	x				x	x	x			x								x	x	x	x							x																				
HP ALP					x																																											

* Not available with Mogul Cylinder (M-option)

Single Cylinder without Deadbolt

04 Storeroom or Closet

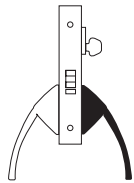

- Key outside retracts latchbolt
- Trim outside locked at all times
- Trim inside always retracts latchbolt
- Auxiliary deadlatch
- A Multi-Function Lock Body
- **ANSI F07**

36 Closet

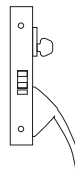

- Key locks and unlocks trim
- No inside trim or cylinder
- A Multi-Function Lock Body
- Auxiliary dead latch

*05 Office or Entry

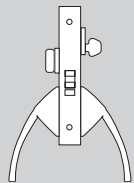

- Key outside retracts latchbolt, also locks and unlocks outside trim
- Trim inside always retracts latchbolt, trim outside remains locked
- Thumbturn inside locks and unlocks outside trim
- Auxiliary deadlatch
- A Multi-Function 8200 ALP/7800 PT Lock Body
- **ANSI F04**

The Multi-Function Advantage:

1. 05 function can be used as an 04, 15 and 37 functions without additional parts.
2. By adding an additional cylinder, an 05 function can be used as a 38 function lock.
3. By adding a Trim One Side Kit, an 05 function can be used as an 06, 13, 31 and 36 functions (Not available with 7800PT).

37 Classroom

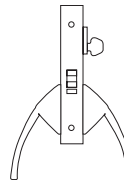

- Key outside retracts latchbolt, also locks and unlocks outside trim
- Trim inside always retracts latchbolt
- Auxiliary deadlatch
- A Multi-Function Lock Body
- **ANSI F05**

55 Office or Entry

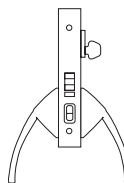

- Key outside retracts latchbolt
- Trim inside always retracts latchbolt, outside trim remains locked
- Trim outside is locked and unlocked by the toggle only

06 Storeroom or Service

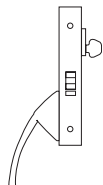

- No trim outside, cylinder only
- Key outside retracts latchbolt
- Trim inside always retracts latchbolt
- Auxiliary deadlatch
- Same as 04 Function without trim outside

56 Office & Inner Entry Lock

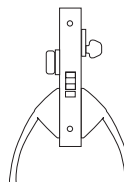

- Key outside retracts latchbolt
- Trim inside always retracts latchbolt and unlocks outside trim
- Trim outside is locked by thumbturn or key
- Auxiliary deadlatch

⚠ **CAUTION:** Not recommended for use on any door used for Life Safety egress
If shaded, trim rigid at all times

NOTE: Paddle orientation on this page is only a representation; all functions can be used with levers or paddles.

Experience a safer
and more open world

Single Cylinder without Deadbolt

57 Institutional Privacy

8200, R8200, 7800

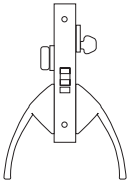

- Key outside retracts latchbolt, overriding thumbturn when held in locked position
- Thumbturn inside locks & unlocks outside trim
- Trim outside unlocks when the door closes or operating trim inside
- Trim inside always retracts latchbolt
- Auxiliary deadlatch

Note: Key locks & unlocks trim outside

58 Institutional Privacy

8200, R8200, 7800

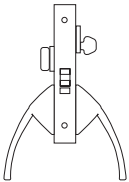

- Key outside retracts latchbolt, overriding thumbturn when held in locked position
- Thumbturn inside locks & unlocks outside trim
- Trim outside does not unlock when the door closes
- Trim outside unlocks when operating trim inside
- Trim inside always retracts latchbolt
- Auxiliary deadlatch

Note: Key locks & unlocks trim outside

♦ **CAUTION:** Not recommended for use on any door used for Life Safety egress
If shaded, trim rigid at all times

NOTE: Paddle orientation on this page is only a representation; all functions can be used with levers or paddles.

Single Cylinder with Deadbolt

↕31 Utility



- Key outside retracts latchbolt
- Trim outside is always locked
- No inside trim or cylinder
- A Multi-Function Lock Body
- Auxiliary deadlatch

67 Institutional Privacy

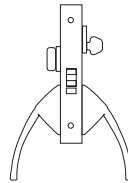

- Key outside retracts latchbolt, overriding thumbturn when held in locked position
- Thumbturn inside locks and unlocks outside trim
- Trim outside unlocks when the door closes or by operating trim inside
- Trim inside always retracts latchbolt
- Auxiliary deadlatch
- **ANSI F26**
- **NOTE:** Key does not lock trim outside, only unlocks it

↕24 Room Door

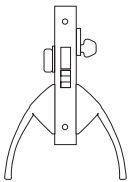

- Key outside or thumbturn inside retracts and projects deadbolt
- Trim either side retracts latchbolt
- Latchbolt and deadbolt operate independently of each other
- **ANSI F21**

30 Dummy Trim Deadlock

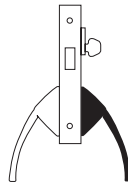

- Deadbolt operation only
- Key outside retracts and projects deadbolt
- Trim inside always retracts deadbolt
- Trim outside is always locked
- Same as 28 Function without a thumbturn

25 Dormitory or Exit

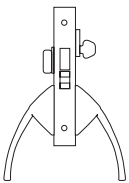

- Key outside or thumbturn inside retracts and projects deadbolt
- Trim from either side retracts latchbolt, when the deadbolt is in the retracted position
- Trim outside is locked, when the deadbolt is projected
- When deadbolt is projected, Trim inside retracts latchbolt and deadbolt simultaneously, unlocking outside trim
- **ANSI F13**

↕35 Storeroom

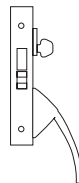

- Key outside retracts and projects deadbolt
- Trim outside retracts latchbolt, except when deadbolt is projected
- No inside trim or cylinder

↕27 Closet or Storeroom

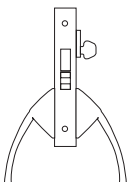

- Key outside retracts and projects deadbolt
- Trim from either side retracts latchbolt
- Same as 24 function without thumbturn
- Latchbolt and deadbolt operate independently of each other

43 Apartment Corridor Door

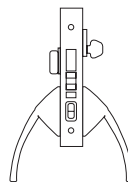

- Key and thumbturn both retract and project the deadbolt
- Trim outside is locked by toggle or projecting deadbolt
- Trim outside is unlocked by toggle only
- Key retracts both latchbolt and deadbolt, trim outside remains locked
- Trim inside always retracts latchbolt (and deadbolt simultaneously), trim outside remains locked
- Auxiliary deadlatch
- **ANSI F20**

28 Dummy Trim Deadlock

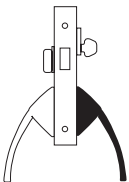

- Deadbolt operation only
- Key outside retracts and projects deadbolt
- Trim inside always retracts deadbolt
- Trim outside is always locked
- Thumbturn inside retracts and projects deadbolt

↕**CAUTION:** Not recommended for use on any door used for Life Safety egress
If shaded, trim rigid at all times



Single Cylinder with Deadbolt

45 Dormitory or Exit

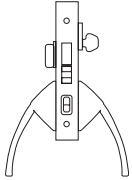

- Key and thumbturn both retract and project deadbolt
- Trim outside is locked by toggle or projecting deadbolt
- Trim outside is unlocked by toggle only
- Key retracts both latchbolt and deadbolt, trim outside remains locked
- Trim inside always retracts latchbolt (and deadbolt simultaneously), trim outside remains locked
- Same as an 8243 without auxiliary deadlatch
- **ANSI F12**

50 Hotel Guest

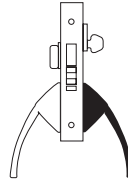

- Hotel Cylinder (50 Function) Required (Standard and Emergency Keys)
- Standard Key retracts latchbolt only, will not retract or project deadbolt
- Emergency Key will retract latchbolt and deadbolt and also project deadbolt
- Thumbturn retracts and projects deadbolt
- Trim inside retracts latchbolt and deadbolt simultaneously
- Trim outside is always locked
- Auxiliary deadlatch
- Available with Conventional, LFIC (60- and 63-) and Keso (82- and F1-82-) key systems
- **ANSI F15**

+47 Front Door or Apartment Corridor Door

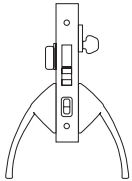

- Key and thumbturn both retract and project deadbolt
- Trim outside is locked by toggle or projecting deadbolt
- Trim outside is unlocked by toggle only
- Key retracts both latchbolt and deadbolt, trim outside remains locked
- Trim inside retracts latchbolt only, deadbolt is retracted manually and trim outside remains locked
- **ANSI F08/F10**

51 Storeroom Deadbolt

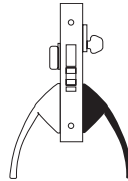

- Key and thumbturn both retract and project the deadbolt
- Key will also retract latchbolt
- Trim inside retracts latchbolt and deadbolt simultaneously
- Trim outside is always locked
- Auxiliary deadlatch
- Same as 50 function with a std cylinder

Double Cylinder without Deadbolt

16 Apartment, Exit or Public Restroom

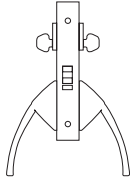

- Key outside retracts latchbolt
- Key inside is required to lock and unlock trim outside
- Trim inside always retracts latchbolt
- Auxiliary deadlatch
- Special -105 cam, required for inside cylinder (supplied)
- **ANSI F09**

38 Classroom Security Intruder Latchbolt

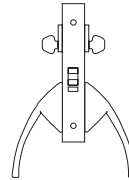

- Key from either side locks and unlocks outside trim
- Key from either side retracts latchbolt
- Trim outside retracts latchbolt, except when locked
- Trim inside always retracts latchbolt
- Auxiliary deadlatch
- **ANSI F32**

17 Asylum or Institutional

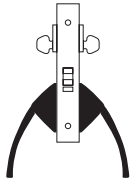

- Key from either side retracts latchbolt
- Trim on both sides are locked at all times
- Auxiliary deadlatch
- **ANSI F30**

59 Double Locking

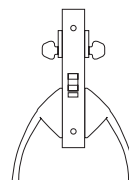

- Key from either side locks and unlocks both the inside and outside trims
- Key from either side retracts latchbolt
- Key from either side can retract latchbolt without unlocking trims
- Auxiliary deadlatch

⚠ **CAUTION:** Not recommended for use on any door used for Life Safety egress
If shaded, trim rigid at all times

NOTE: Paddle orientation on this page is only a representation of the product; all functions can be used with paddles in any orientation.

Experience a safer
and more open world

1-800-727-5477 • www.sargentlock.com

17

Double Cylinder with Deadbolt

†26 Store Door

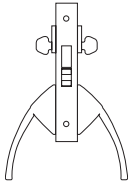

- Key from either side retracts and projects deadbolt
- Trim from either side retracts latchbolt
- Latchbolt and deadbolt are independent of each other
- **ANSI F14**

40 Classroom Security Intruder Deadbolt

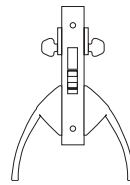

- Key either side retracts or projects deadbolt which also unlocks or locks outside trim
- Trim outside retracts latchbolt, except when locked
- Trim outside is only locked by projecting the deadbolt
- Trim inside retracts both latchbolt and deadbolt simultaneously, and unlocks outside trim
- Auxiliary deadlatch
- Same as an 8239 with Auxiliary deadlatch
- **ANSI F34**

29 Dummy Trim Deadlock

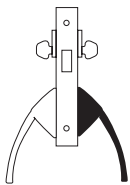

- Deadbolt operation only
- Key on either side retracts and projects deadbolt
- Trim inside retracts deadbolt
- Trim outside is always locked

41 Classroom Security Intruder Deadbolt

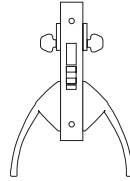

- Key from either side retracts and projects deadbolt
- When deadbolt is projected, 1st key rotation retracts deadbolt, 2nd key rotation unlocks trim outside
- Key retraction of latchbolt from either side unlocks trim outside
- Trim outside retracts latchbolt, except when locked
- Trim inside (when deadbolt is projected) retracts both latchbolt and deadbolt simultaneously and the outside trim remains locked
- Auxiliary deadlatch

39 Classroom Security Intruder Deadbolt

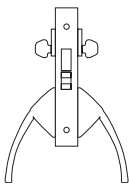

- Key either side retracts or projects deadbolt which also unlocks or locks outside trim
- Trim outside retracts latchbolt, except when locked
- Trim outside is only locked by projecting the deadbolt
- Trim inside retracts both latchbolt and deadbolt simultaneously, and unlocks outside trim
- **ANSI F33**

46 Dormitory or Exit

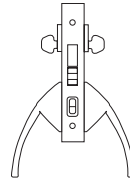

- Key from either side retracts and projects deadbolt
- Key from either side retracts both latchbolt and deadbolt, trim outside remains locked
- Trim outside is locked by toggle or projecting deadbolt
- Trim outside is unlocked by toggle only
- Trim inside (when deadbolt is projected) retracts both latchbolt and deadbolt simultaneously and the outside trim remains locked

†48 Store Door

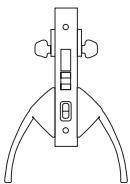

- Key from either side retracts and projects deadbolt
- Key from either side retracts latchbolt
- Trim outside is locked by toggle or projecting deadbolt and unlocked by toggle only
- Trim inside (when deadbolt is projected) retracts latchbolt only, and outside trim remains locked
- **ANSI F25**

†49 Security Deadbolt

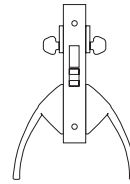

- Key from either side retracts and projects deadbolt
- Key from either side retracts latchbolt
- Trim inside and outside are locked only when deadbolt is projected

†52 Institutional Deadbolt

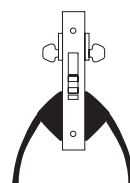

- Key from either side retracts and projects deadbolt
- Key from either side retract latchbolt
- Trim inside and out are always locked
- Auxiliary deadlatch

†**CAUTION:** Not recommended for use on any door used for Life Safety egress
If shaded, trim rigid at all times

Non-Keyed

13 Exit Latch



- No outside trim or cylinder
- Trim inside retracts latchbolt
- Auxiliary deadlatch
- A Multi-Function Lockbody
- **ANSI F31**

15 Passage or Closet

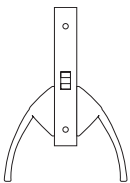

- Trim from either side retracts latchbolt at all times
- **ANSI F01**

65 Privacy Bath/Bedroom

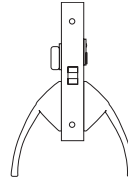

- Trim outside retracts latchbolt except when locked by thumbturn
- Trim inside retracts latchbolt and unlocks outside trim
- Emergency Release locks/unlocks trim outside-by coin, screwdriver or Emergency key (14-0057) ordered separately.
- Thumbturn locks and unlocks trim outside
- Closing the door will unlock outside trim
- **ANSI F22**

66 Privacy Bath/Bedroom

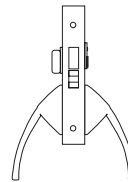

- Trim outside retracts latchbolt except when deadbolt is projected
- Trim inside retracts both latchbolt and deadbolt simultaneously, unlocking the outside trim
- Emergency Release retracts and projects deadbolt-by coin, screw driver or Emergency key (14-0057) ordered separately
- Thumbturn retracts and projects deadbolt
- **ANSI F19**

68 Privacy Bath/Bedroom

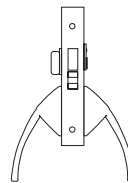

- Trim from either side retracts latchbolt at all times
- Thumbturn retracts and projects deadbolt
- Emergency release retracts and projects deadbolt-by coin, screwdriver or Emergency key (14-0057) ordered separately
- Latchbolt and deadbolt are independent of each other
- **ANSI F02**

⚠ **CAUTION:** Not recommended for use on any door used for Life Safety egress
If shaded, trim rigid at all times

NOTE: Paddle orientation on this page is only a representation of the product; all functions can be used with paddles in any orientation.

Experience a safer
and more open world

1-800-727-5477 • www.sargentlock.com

19

SARGENT 8200 Electromechanical Mortise locks are designed to handle single opening, stand alone applications, or can be readily integrated into sophisticated access control systems. They meet ANSI/BHMA A 156.13 Grade 1 requirements, are UL listed on fire doors, and satisfy industry standards for operating temperature, shock and fire hazard.

Electromechanical Functions

70 Electrical (Fail Safe)

71 Electrical (Fail Secure)

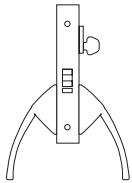

- 70 function- Power OFF, unlocks outside trim (by solenoid)
- 71 function- Power OFF, locks outside trim (by solenoid)
- Always specify voltage: 12VDC or 24VDC
- Key outside retracts latchbolt
- Trim outside retracts latchbolt except when locked
- Trim outside can only be locked and unlocked with the solenoid
- Trim inside always retracts latchbolt
- Auxiliary deadlatch

72 Electrical (Fail Safe)

73 Electrical (Fail Secure)

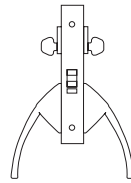

- 72 function- Power OFF, unlocks both trims (by solenoid)
- 73 function- Power OFF, locks both trims (by solenoid)
- Always specify voltage: 12VDC or 24VDC
- Key on either side retracts latchbolt
- Trim from either side retracts latchbolt, except when trims are locked
- Both trims can be locked and unlocked with the solenoid
- Trim can not be locked separately, only together
- Auxiliary deadlatch

⚠ **CAUTION:** Not recommended for use on any door used for Life Safety egress

NOTE: Paddle orientation on this page is only a representation of the product; all functions can be used with paddles in any orientation.

Electrical Requirements for Electromechanical Functions:

Voltage: Operates from 12-24VDC Regulated. Full wave rectification installed inside the lockbody.

Current:

- Actuator draw = .015 Amp continuous
- Maximum (2) locks per 1 Amp power supply (1/2 Amp peak current draw)

Operating Temp.: Max. 151°F (66°C), Min -31°F (-35°C)

UL and CUL listed for use on Fire Doors

Note: Repeated operation at voltage exceeding +/- 10% is not recommended

Warning:

- **Do not** connect locks to a circuit sharing an additional electromagnetic device as the lock may be damaged
- Transient voltage must be suppressed at the source or before connecting with the lock
- Varistor rated at 35 volts (peak) may be used for transient voltage protection

NOTE: Opening the lockbody or the actuator replacement in the field by non-authorized personnel voids UL label and lock warranty

549 Kit for Retrofitting ALP Push/Pull Trim

Contains 2 retrofit plates and 8 screws. Use to cover prep from 114/115 and PT push/pull trim, as well as other manufacturer's trim, when retrofitting ALP trim. Available in 32D finish standard. Order kit #549.

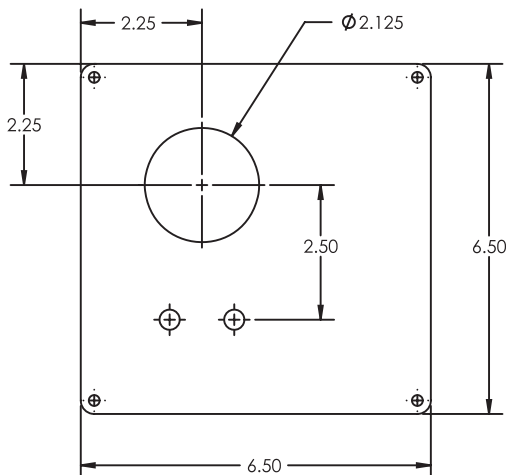

684 Positive Pull Stop Kit

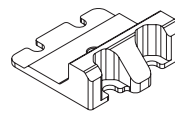

- This kit prevents the latch from retracting when pulling the door closed.
- Used on openings where weather stripping is installed or when door closers are not utilized.
- Order kit # 684

Power Supplies and Requirements

Healthcare Hardware

Requirements for Electrical and Data Transfer

To answer the demand for “smart” electronic access control and locking solutions that require fast, easy, and cost-effective installation, ASSA ABLOY Group brands use the ElectroLynx® standardized plug-in connectors and color-coded wiring system.

With ElectroLynx, doorway components come pre-wired for easy hookup to the power source. Key to the system is the transfer device hinge that carries power from the frame to the locking hardware.

Features of ElectroLynx:

- Makes it easy to bring power to the locking hardware
- Wires have connectors that snap together, like plugging a telephone into a jack

To connect an 8200 Electrified Mortise Lock to the electronic access control system, the following items are required:

- 8200 Electrified Mortise Lock
- ASSA ABLOY Door Group pre-wired door, or ElectroLynx retrofit cable (order from MCKINNEY)
- Electronic transfer device (ElectroLynx electronic transfer hinge or Electrical Power Transfer with standard hinge, from MCKINNEY)
- ElectroLynx cable from the hinge to above the ceiling (order from MCKINNEY)

Information regarding cable selection, hinge requirements and order strings can be found in the McKinney Transfer Device Solutions catalog. Consult 800-810-WIRE (9473) with questions on application specifications and requirements.

McKINNEY QC8 ElectroLynx Hinges for 8270-8274 functions and the RX- option is recommended. McKinney QC12 ElectroLynx Hinges for LX- or DX- option is recommended.



12VDC & 24VDC Power Supplies:



- UL Class 2 Listed
- Four 12V models and four 24V models available
- Integral battery charging capability keeps sealed lead acid gel/cell at full charge in case of line voltage failure (737-battery sold separately)
- Fused line voltage input with one, four, or eight DC outputs (depending on model)
- Each circuit can be individually turned on and off via a slide switch; the power status of each is shown by an LED.
- In the event of a DC short the problem is confined to the zone of difficulty
- Fire alarm interface standard

SARGENT MODEL No.	DESCRIPTION
3521	12V - 1 AMP POWER SUPPLY
3541	12V - 3 AMP POWER SUPPLY
3551	12V - 4.5 AMP POWER SUPPLY
3571	12V - 6 AMP POWER SUPPLY
737	12V - 5 AMP HOUR BACKUP BATTERY

SARGENT MODEL No.	DESCRIPTION
3520	24V - 1 AMP POWER SUPPLY
3540	24V - 2 AMP POWER SUPPLY
3550	24V - 4 AMP POWER SUPPLY
3570	24V - 6 AMP POWER SUPPLY
738	24V - 5 AMP HOUR BACKUP BATTERY

Turns, Emergency Releases and Indicators

Healthcare Hardware

SARGENT
ASSA ABLOY

130KBHA Turn for use with 8200 Mortise BHW, ALP, BHL and BHD Trim



- 3-3/4" x 2-1/2" rectangular shape
- Stainless steel housing
- Meets ADA and OMH Requirements

184KBHA Emergency Release (used with BHW, ALP, BHL and BHD trim)



- 3-3/4" x 2-1/2" rectangular shape
- Stainless steel housing
- Meets ADA and OMH Requirements

130W Turn for use with PT Trim



- 1-1/2" (38mm) round brass, bronze or stainless steel plate
- Meets ADA Requirements



184W Emergency Release for use with PT Trim



- 1-1/2" (38mm) round brass, bronze or stainless steel plate
- For 65, 66 and 68 functions only

Emergency Key 14-0057



- Carbon steel
- For 65, 66 and 68 functions only
- Must be ordered separately

Lock Status and Secured Indicators for use with 8200 Mortise ALP Trim

49- Option Visual Status Indicator for Non Secure Applications

- Designed to work with Classroom Security functions
- Red/White indicator plate standard, field replaceable OCC/VAC plate included
- Mounts on inside of door
- Functions available: 30 and 37
- As retrofit, order 185CALP x finish



49- Option Occupancy Indicator with Emergency Release

- Ideal for restrooms or conference rooms where easy determination of use needs to be made
- OCC/VAC indicator plate standard, field replaceable Red/White plate included
- Mounts on outside of door
- Emergency coin operated release standard
- Functions available: 65, 66 and 68
- As retrofit, order 185PALP x finish



50- Option Secured Indicator Rose

- Non-handed mounting
- VAC/OCC indicator plate standard, field replaceable Red/White plate included
- Mounts on outside of door
- Available for the following functions: 24, 25, 26, 28, 29, 30, 36, 37, 38, 39, 40, 41, 43, 45, 50, 51, 52, 67
- Patent pending design
- For retrofit kits: Specify: 186PALP x finish



NOTE: For 49- and 50- Options, key will not retract latchbolt when used with 37 and 38 functions lock, the key will lock and unlock outside trim

Copyright © 2007-2020, Sargent Manufacturing Company. All rights reserved. Reproduction in whole or in part without the express written permission of Sargent Manufacturing Company is prohibited.

Cylinder Lengths (Dim X)

Cylinder No.	41	42	43	44	46	48	50	52	54	56
Dim X Length Under Cylinder Head	1-1/8" (29mm)	1-1/4" (32mm)	1-3/8" (35mm)	1-1/2" (38mm)	1-3/4" (44mm)	2" (51mm)	2-1/4" (57mm)	2-1/2" (64mm)	2-3/4" (70mm)	3" (76mm)

NOTE: ALP 8200 and 7800 PT locks on 1-3/4" thick doors require a minimum cylinder length of #41 (1-1/8") cylinder

40 Series Type Cylinder



- Cylinder body: Solid brass
- Cap: Brass, bronze or stainless steel
- All functions take a Standard Cam Functions
- Standard Cam 13-0664
- 16 function requires a 105 cam on the inside cylinder
- 50 Hotel Cam -115 supplied standard with all Hotel Function Cylinders

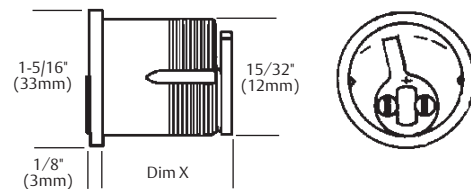

7850/8250 Function Hotel Cylinder



- When door is locked by deadbolt, only emergency key is able to unlock
- Must request emergency key separately (14-0036 x keying info)
- Supplied with Cam suffix -115 for Hotel Functions

10- Option Signature Series



- The protected system offers the building owner full control over duplication of keys. Highly pick resistant cylinders
- 10-63- Option- Signature cylinder with Large Format Interchangeable Cores

11- Option XC Key System



- Patented system works with existing SARGENT keyway adding increased security
- 11- XC Std Cylinder
- 11-63- Large Format Interchangeable core
- 11-73- Small Format Interchangeable core

F1-82- and 82- Option KESO



- The system offers the building owner full control over duplication of keys
- Highly pick resistant cylinders
- Expanded levels of masterkeying
- F1-83- and 83- Option- Keso removable core
- 84- Option- Keso construction core cylinder

51- Option Old Style Removable Core



- Available for **existing systems only** Permanent Removable Cores
- Control key used to remove core, must request control key separately

60- or 70- Option Plastic Construction Core



- For doors that do not require key locking during the construction period
- Operate with coin or flat screw driver
- 60- Hardware to accept SARGENT Permanent LFIC (Removable core), disposable plastic core provided
- 70- Hardware to accept 6- or 7-Pin SFIC Permanent Cores, disposable plastic core provided

63- Option Large Format Interchangeable (Removable) Core



- Allows immediate removal of the core. Virtually unlimited key changes
- Available with Signature and XC- features as 10-63-, 11-60-, 11-63- and 11-64-
- For disposable core, see 60- Option
- 63- Hardware provided with LFIC (Removable core) cylinder
- 64- Hardware provided with Keyed construction core to accept LFIC (Removable) permanent core
- Control key used to remove core, must request control key separately

21- Option Lost Ball Construction System

- The SARGENT construction keying system protects the building owner by providing temporary masterkeying during the construction period

No. 97 Rosette



- Standard for 8200 ALP and 7800 mortise locks
- Standard for cylinders ordered separately from hardware
- Brass, bronze or stainless steel
- 1-11/16" diameter (43mm), 9/32" (7mm)
- Finishes: 3, 4, 10, 10B, 10BE, 10BL, 20D, 26, 26D, 32, 32D

7300B Interchangeable Core



- Small Format Interchangeable Core
- SARGENT Interchangeable Core cylinders and MasterKey Systems are available for increased security through quick change of keying. It is unnecessary to remove a cylinder.
- SARGENT 7300B Interchangeable Cores are available in SARGENT 4A and 4B keyways, as well as the following standard competitor keyways: A, B, C, D, E, F, G, H, J, K, L, M
- For disposable core, see 70- Option
- 72- Hardware to accept 6- or 7-Pin SFIC (Keyed construction core provided) cylinder
- 73- Hardware provided with 6-Pin SFIC, SARGENT 4A, 4B keyways
- 65-73- Hardware provided to accept Uncombined 6-Pin SFIC (Permanent) core - (Packed loose for field keying)
- 65-73-7P- Hardware provided to accept Uncombined 7-Pin SFIC (Permanent) core - (Packed loose for field keying)
- 73-7P- Hardware provided with Small Format 7-Pin Interchangeable core, SARGENT 4A, 4B keyways
- 11-70-7P- Hardware to accept XC- SFIC (7-Pin) XC- Permanent cores, disposable plastic core provided
- 11-72-7P-* Hardware to accept XC- SFIC (7-Pin Keyed construction core provided) cylinder; Permanent core ordered separately
- 11-73-7P-* Hardware provided with XC- Small Format 7-Pin Interchangeable core (Includes masterkeying, grand masterkeying)
- 11-65-73-7P- Hardware provided to accept XC- Uncombined 7-Pin SFIC (Permanent) Core - (Packed loose)
- * Control key used to remove core (provided separately)

1SB Cylinder Collar



- Standard for 7800 BHD, 8200 BHL & BHW mortise locks
- Stainless steel
- 1-29/32" diameter
- Finishes: 32, 32D
- Available in 4 sizes. See 8200 Mortise Catalog for specifics on collar sizes and measurements

For complete cylinder information, see Cylinders and Components, Signature, Keso, Keso F1 or XC catalogs.

For details on cylinder collar kits, see 8200 Mortise Catalog (page 27).

Strikes and Fronts

Healthcare Hardware

- Curved lip strikes: Brass, bronze or stainless steel
- 877 Open back strike: Brass plated
- To order strikes separately, specify strike part number and finish
- Strikes ordered separately are furnished with machine screws
- Order strike box 77-1141 separately
- All locks are packed standard with a universal non-handed curved lip ANSI 4-7/8" (124mm) strike.
- Specify part number when ordering with complete lock
- See chart below for part number and lip lengths
- Open back strike not available for deadbolt functions

Curved Lip Strike

Door Thickness	Part No.	Lip Length
Double Door	82-0229	7/8" (23mm)
1-3/8" - 1-1/2" (35mm) (38mm)	82-0109	1-1/8" (29mm)
1-5/8" - 1-3/4" (41mm) (44mm)	82-0110 Standard	1-1/4" (32mm)
1-7/8" - 2" (48mm) (51mm)	82-0111	1-3/8" (35mm)
2-1/8" - 2-1/2" (54mm) (64mm)	82-0112	1-5/8" (41mm)
2-5/8" - 3" (67mm) (76mm)	82-0113	1-7/8" (48mm)
3-1/8" - 3-1/2" (79mm) (89mm)	82-0114	2-1/8" (54mm)
3-3/8" - 4" (86mm) (101mm)	82-0115	2-3/8" (61mm)
4-1/8" - 4-1/2" (105mm) (114mm)	82-0116	2-5/8" (67mm)
4-5/8" - 5" (117mm) (127mm)	82-0117	2-7/8" (73mm)

Curved Lip Strike (Standard)

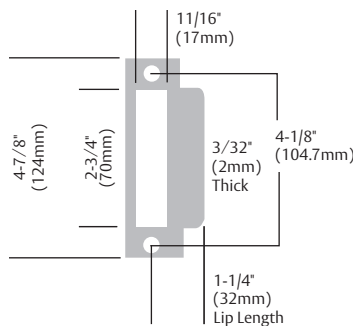

78-0034 Deadbolt Strike

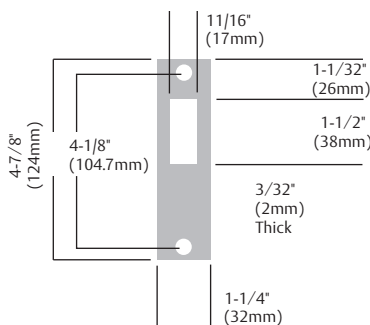

877 Open Back Strike

- Strike handed by **active leaf**

Door Thickness	Part No. RHRB	Part No. LHRB
1-3/4" (44mm)	82-0332	82-0333
2" (51mm)	82-0334	82-0335
2-1/4" (57mm)	82-0336	82-0337
2-1/2" (64mm)	82-0338	82-0339
2-3/4" (70mm)	82-0340	82-0341
3" (76mm)	82-0342	82-00343

877 Open Back Strike

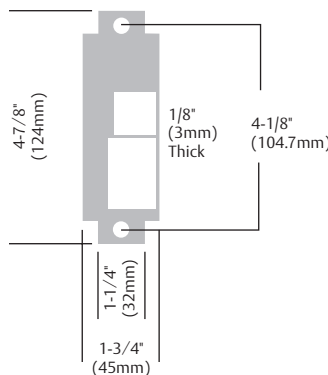

77-1141 Wrought Box Strike



- For both curved and flat lip strikes
- Optional: Specify WBS- when ordering with lock
- If ordering separately, use part # 77-1141

6 Lobe & Spanner Bit packs

Part Number	Descriptions
82-3855	6 Lobe Bit Pack 6 bits
82-3856	(sizes- T8, T9, T10, T15, T20, T25, T27) 9/32" Driver Spanner Bit Pack 5 bits (sizes- 6, 8, 10, 12, 14) 1/4" Driver

Outside Front Plate

Standard 1-1/4" (32mm)	Functions
82-0423	15, 65
82-0424	04, 05, 06, 13, 16, 17, 31, 36, 37, 38
82-0425	28, 29, 30
82-0426	24, 25, 26, 27, 35, 39
82-0427	40, 41, 50, 52
82-0429	45, 46, 47, 48
82-0430	43
82-0424	70, 71, 72, 73
82-0428	55

Outside Front Plate

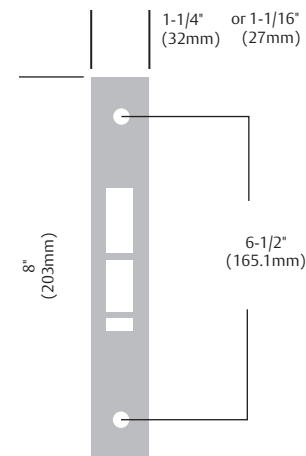

No. 677 Rabbeted Door Kits

677 Kit adapts 7800/8200 locks for rabbeted doors consists of rabbeted strip and strike. Std for 1-3/4" to 2" doors.
Specify 2-677 for 2-1/4" thick doors. Hardware Finished.

Cylinder Options

Categories	How to Specify	Detailed Description
Conventional Cylinder	-*	SARGENT Conventional Cylinders Supplied Standard
Degree Key System	DG1-	SARGENT Degree Key System Level 1 (Bump and pick resistant)
	DG1-21-	Degree Level 1 Construction Master Keying
	DG1-60-	Degree Level 1 Removable Disposable Construction Core
	DG1-63-	Degree Level 1 Removable Core
	DG1-64-	Degree Level 1 Removable Construction Keyed LFIC
	DG1-65-	Degree Level 1 Unassembled/Uncombined Core
	DG2-	SARGENT Degree Key System Level 2 (Geographically exclusive; bump and pick resistant)
	DG2-21-	Degree Level 2 Construction Master Keying
	DG2-60-	Degree Level 2 Removable Disposable Construction Core
	DG2-63-	Degree Level 2 Removable Core
	DG2-64-	Degree Level 2 Removable Construction Keyed LFIC
	DG2-65-	Degree Level 2 Unassembled/Uncombined Core
	DG3-	SARGENT Degree Key System Level 3 (Geographically exclusive; UL437 certified; bump and pick resistant)
	DG3-21-	Degree Level 3 Construction Master Keying
	DG3-60-	Degree Level 3 Removable Disposable Construction Core
	DG3-63-	Degree Level 3 Removable Core
DG3-64-	Degree Level 3 Removable Construction Keyed LFIC	
Signature Key System	10-	SARGENT Signature Key System (Not available with other key systems)
	10-21-	SARGENT Signature Construction Key System (Lost Ball)
Signature Large Format Interchangeable Core (Removable Core)	10-63-	SARGENT Signature LFIC (Removable) Core Cylinder
XC- Key System	11-	XC Key System (Not available with other key systems, unless specified)
	11-21-	XC- Construction Key System (Lost Ball)
XC- Large Format Interchangeable Core (Removable Core)	11-60-	Hardware to accept XC- Permanent LFIC (Removable core), disposable plastic core provided
	11-63-	Hardware provided with XC- LFIC (Removable core) cylinder - (Includes masterkeying, grand masterkeying)
	11-64-	Hardware provided with keyed construction core to accept XC- LFIC (Removable) Permanent core ordered separately
XC- Small Format Interchangeable Cores	11-70-7P-	Hardware to accept XC- SFIC (7-Pin) XC- Permanent cores, disposable plastic core provided
	11-72-7P-	Hardware to accept XC- SFIC (7-Pin Keyed construction core provided) cylinder Permanent core ordered separately
	11-73-7P-	Hardware provided with XC- Small Format 7-Pin Interchangeable core (Includes masterkeying, grand masterkeying)
	11-65-73-7P-	Hardware provided to accept XC- Uncombined 7-Pin SFIC (Permanent) Core - (Packed loose)
Construction Key System	21-	SARGENT Lost Ball Construction keying for Conventional, XC and Signature series (N/A with 63- or 73-)
	22-	SARGENT Construction Split Key System for Conventional cylinders (Existing systems only) (N/A with 10-, 11-, 63- or 73-)
Old Style Removable Core	51-	Removable Core Cylinder (Old style) provided (Existing systems only)
	52-	Removable Construction Core (Old style) Permanent core ordered separately (Existing systems only)

* Option available with 50 function hotel lockout cylinders

NOTE: Interchangeable core and removable core cylinders do not meet Security Grade 1 requirements

Cylinder Options

Categories	How to Specify	Detailed Description
Large Format Interchangeable Core	60-*	Hardware to accept SARGENT Permanent LFIC (Removable core), disposable plastic core provided (Permanent cores ordered separately)
	63-*	Hardware provided with LFIC (Removable core) cylinder - (Includes masterkeying, grand masterkeying)
	64-	Hardware provided with Keyed construction core to accept LFIC (Removable) permanent core (Ordered separately)
Small Format Interchangeable Cores	70-	Hardware to accept 6- or 7-Pin SFIC Permanent Cores, disposable plastic core provided
	72-	Hardware to accept 6- or 7-Pin SFIC (Keyed construction core provided) cylinder (Permanent core ordered separately)
	73-	Hardware provided with 6-Pin SFIC (Includes masterkeying, grand masterkeying)
	65-73-	Hardware provided to accept Uncombined 6-Pin SFIC (Permanent) core - (Packed loose for field keying)
	65-73-7P-	Hardware provided to accept Uncombined 7-Pin SFIC (Permanent) core - (Packed loose for field keying)
	73-7P-	Hardware provided with Small Format 7-Pin Interchangeable core - (Includes masterkeying, grand masterkeying)
Keso and Keso F1	81-	Hardware provided with housings to accept Keso (83) and Keso F1 (F1-83-) removable cores (Permanent cores ordered separately)
	82-*	Hardware provided with SARGENT Keso Security Cylinder
	F1-82-*	Hardware provided with SARGENT Keso F1 Security Cylinder (Patented)
	83-	Hardware provided with SARGENT Keso Security Removable Core cylinder
	F1-83-	Hardware provided with SARGENT Keso F1 Security Removable Core cylinder (Patented)
	84-	Hardware provided with SARGENT Keso Construction Cores (Permanent cores ordered separately)
Additional Security	BR-	Bump Resistant Cylinder (Available with conventional and conventional XC cylinders only)
Less Cylinder	LC-	Less Cylinder - SARGENT supplies standard blocking rings for 1-1/8" cylinders (For longer cylinders order collars/rings separately)
Schlage Keyways	SC-	Schlage C keyway cylinder, 0 bitted
	SE-	Schlage E keyway cylinder, 0 bitted

* Option available with 50 function hotel lockout cylinders

NOTE: For V-10 Cylinders and information contact ASSA

NOTE: Interchangeable core and removable core cylinders do not meet Security Grade 1 requirements

Mechanical Options

Categories	How to Specify	Detailed Description
Strike Option	23-	4-7/8" (124mm) ANSI flat lip strike coat (available for 32 and 32D finishes)
	OBS-	Open Back Strike
	WBS-	Wrought Box Strike
Thick Doors	31-	For 8200 ALP trim: doors 1-7/8" (48mm) to 2-1/4" (57mm) thick - see cylinder options for limitations on door thickness. When ordering the following information is required: Location of lock within the door, door thickness -IF paneled -must specify panel thickness and panel location (inside or outside of the door) For doors thicker than 2-1/4" -consult factory. For 7800 PT trim: door thickness 1-3/4" (44mm) to 2" (51mm) standard; For thicker doors, consult factory.
Security Fasteners	36-	6 Lobe head security screws (Torx® type) (supplied standard on BHL Trim and PT trim)
	37-	Spanner head security screw
Electrical Options+**	DX-	Deadbolt monitoring - Monitor deadbolt position (not available with LX-)
	LX-	Latchbolt monitor - Monitors latchbolt position (not available with deadbolt functions)
	RX-	Request to Exit - Monitors each lever independently
Visual Indicators	* 49-	Visual Status Indicator or Occupancy Indicator w/Emergency Release (available with 8200 ALP only)
	* 50-	Secured Indicator (available with 8200 ALP with cylinder functions only)
Lead Lining	74-	Lead Lining or Wrapping
Markers	P-	Push/Pull Paddle Identification (non-handed)
Finish Protection	CPC-	Clear Powder Coat
	SG-	MicroShield® antimicrobial clear powder coat (only available with 15, 26D and 32D finishes)

* Not available with 8200 BHW

** Not available with 9200 BHD

+ not available with ALP trim

How to Order 8200BHL/ 8200 BHW/8200ALP/7800 BHD/9200 BHD Series Mortise Locks

10- Options*	82 Series	71 Function	12VDC Voltage	BHL Trim	32D Finish	RHR Hand
For all available options see pages 26-27	9200, 8200 or 7800 Mortise Lock	Pages 13-20 for Details	12VDC	BHL Trim for 8200 or BHW Trim for 8200 or BHD Trim for 8200 or ALP trim for 8200	32D	RHR
			24VDC			RH
			Must be specified for Functions 70, 71, 72 & 73			LHR
						LH

* Multiple options can be selected

How To Order 7800PT Series Mortise Locks

10- Options*	82 Series	71 Function	12VDC Voltage	PT Trim	32D Finish	RHR Hand
For all available options see pages 26-27	7800 Mortise Lock	Pages 28 for Details	12VDC	PT trim for 7800	32D	RHR
			24VDC			RH
			Must be specified for Functions 70, 71, 72 & 73			LHR
						LH

* Multiple options can be selected

How To Order 114/115 Series Push/Pull Units

28-P- Options	115 Series	26D Finish	RH Hand
See page 26-27	114	03, 04, 09, 10, 10B, 10BE, 15, 26 & 26D	RHR
			LHR
	115		RH
			LH

How To Order HP Bored Locks with ALP Trim

SG- Option	HP Series	U65 Function	ALP Trim	32D Finish	RHR Hand
See page 26-27	HP Series Tubular Locks	15 - Passage 65 - Privacy	Push/Pull Trim	32D	RHR
					LHR
					RH
					LH

Finishes

8200 or HP locks with ALP Trim	8200 BHW, 8200 BHL, 7800 BHD, 9200 BHD	7800 Push/Pull Trim	114/115 Push-Pull	7800 PT Trim	Description	BHMA
		03	03	03	Polished brass, clear coated	605
		04	04	04	Satin brass, clear coated	606
		09	09	09	Polished bronze, clear coated	611
		10	10	10	Satin bronze, clear coated	612
		10B	10B	10B	Oxidized bronze, oil rubbed	613
		10BE	10BE	10BE	Dark Oxidized Satin Bronze Equivalent	613E
				10BL	Oxidized satin, bronze, clear coated	613L
					Polished nickel, clear coated	618
			15		Satin nickel, clear coated	619
				20D	Statuary dark bronze, clear coated	624
			26		Polished chrome	625
			26D		Satin chrome	626
				32	Polished stainless steel	629
32D	32D	32D		32D	Satin stainless steel	630

SG- MicroShield® antimicrobial clear powder coat (only available with 15, 26D and 32D finishes)
Split Finishes - specify outside finish first, then inside finish example: US26D (outside) / US04 (inside)

Door Handing

Patent pending and/or patent www.assaabloydss.com/patent

NOTE: Changing the hand of the lockbody is either a 1 or 2 step process depending on the hand of the lockbody and what hand it needs to be. Remember the RED surface of the locking piece (step A) always faces the locked or outside surface of the door. The bevel on the latchbolt (step B) must always face the strike.

1. Changing a lockbody from LH to RHRB or RH to LHRB or the opposite requires only step (A) to be performed.
2. Changing a lockbody from LH to LHRB or RH to RHRB or the opposite requires only step (B) to be performed.
3. Changing a lockbody from LH to RH or RH to LH or the opposite requires both step (A) and (B) to be performed.

To change hand of locking piece

NOTE: The following Functions (04, 06, 16 & 31) require that the Green Catch Screw is removed prior to rotating the Locking Slide.

1. Position Lock Body so the Red Surface of the Locking Slide is facing you.
2. With Blade Type Screw Driver, push on the Red surface of the locking Slide so it rotates towards the back of the lock.
3. Continue to Rotate the Locking Slide for a full 180°, so that the Red Surface is visible on the opposite side of the lock.
4. RED indicates locked (outside) side.

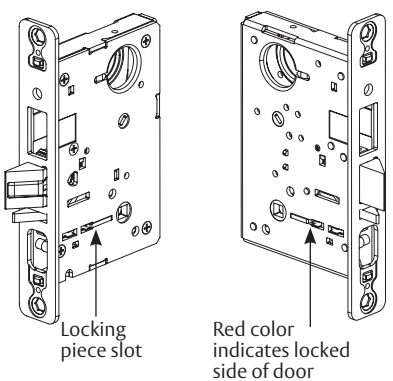

Locking piece slot

Red color indicates locked side of door

To change hand of latch and guardbolt:

1. Insert the blade of a slotted screwdriver (>1/4") into the spade shape slot behind latch.
2. Rotate the screwdriver 90° to push latchbolt out until back of bolt clears lock case front.
3. Rotate latchbolt 180° until the latchbolt drops back into the lockbody.

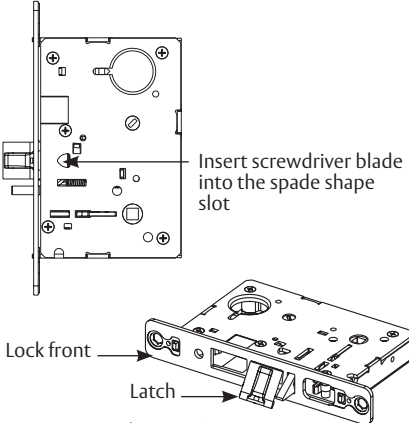

Insert screwdriver blade into the spade shape slot

Lock front

Latch

Rotate screwdriver 90° to push latch out until back of latch clears lock front, then rotate latch 180°, latch will then re-enter lockbody
(NOTE: Latch can not be unscrewed)

Door Handing

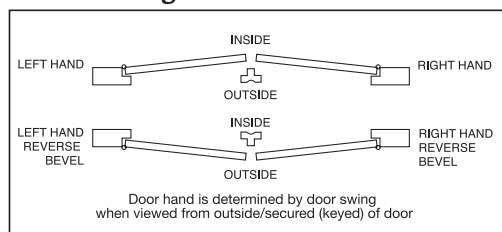

8200/7800 and HP Certifications

Healthcare Hardware



Certification Compliance for 8200 & 7800 Mortise Locks

ANSI/BHMA	Certified to ANSI/BHMA A156.13 Series 1000 Operational Grade 1 and Security Grade 1 with all standard trims. ANSI/ASTM F476-84 Grade 40 with concealed mortise cylinder. NOTE: LFIC (Removable) Cylinders and SFIC Cylinders do not meet Security Grade 1 requirements.
ADA 	Meets A117.1 Accessibility Code. Meets BOMA International 4.13.8 Complies with American Disability Act; Consult local authorities
UL	UL and cUL Listed for use with 3 hour fire "A" label 4 x 10 single and 8 x 10 double and lesser class doors. UL symbol on front stamped letter F indicates listing.
Positive Pressure	Meets ANSI/UL 10C, Positive Pressure Fire Test of Door Assemblies
California	California State Reference Code (Formerly Title 19, California State Fire Marshal Standard)

Any retrofit or other field modification to a fire rated opening can potentially impact the fire rating of the opening, and Sargent Manufacturing Company makes no representations or warranties concerning what such impact may be in any specific situation. When retrofitting any portion of an existing fire rated opening, or specifying and installing a new fire-rated opening, please consult with a code specialist or local code official (Authority Having Jurisdiction) to ensure compliance with all applicable codes and ratings.

Warranty for 8200 & 7800 Mortise Locks

Warranty	10 year limited warranty, 2 year limited warranty on electrified locks. Warranty limited to replacement of Lockbody and/or components.
----------	---

Certification Compliance for HP Bored Locks

ANSI/BHMA	Certified to ANSI/BHMA A156.2 Series 1000 Grade 1 with all standard trims.
ADA	Meets A117.1 Accessibility Code.
UL	UL and cUL Listed for use on 3 hour fire doors (4 x 8 single and smaller doors). UL symbol on front stamped letter F indicates listing.

Warranty for HP Bored Locks

Warranty	1 year limited warranty. Warranty limited to replacement of Lockbody and/or components.
----------	--

Any retrofit or other field modification to a fire rated opening can potentially impact the fire rating of the opening, and Sargent Manufacturing Company makes no representations or warranties concerning what such impact may be in any specific situation. When retrofitting any portion of an existing fire rated opening, or specifying and installing a new fire-rated opening, please consult with a code specialist or local code official (Authority Having Jurisdiction) to ensure compliance with all applicable codes and ratings.

Multi-Functional Lockbody & Architectural Specifications

Healthcare Hardware

How to Change Lock Function:

The Green Catch Screw must be located in the designated location as specified on the lock case to produce the desired function.

There are three locations: one location for 05, 37 and 38 functions; one location for 04, 06, 13 and 31 functions; and one location for 36 function.

NOTE: To change to functions 04, 06, 13 and 31, the hub must be at the 45° position as specified on the case before screwing in the green catch screw.

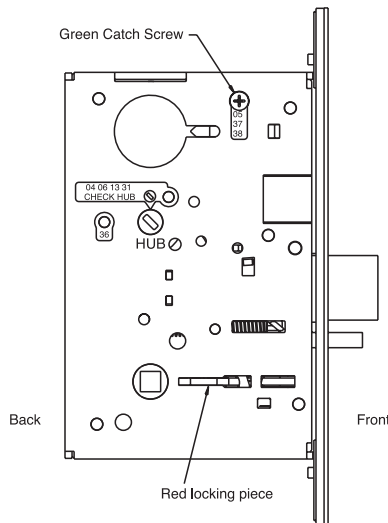

2.1 Heavy Duty Mortise Locks

- A. Heavy duty mortise locks shall be 8200/7800 Series as manufactured by SARGENT Manufacturing Company, New Haven, CT.
- B. Locks shall meet or exceed the requirements of ANSI/BHMA A156.13 Series 1000, Operational Grade 1, and Security Grade 1 with all standard trims.
- C. Locks shall be easily re-handed without opening the lock body.
- D. Locks shall comply with UL 10C positive pressure requirements.
- E. Locks required for fire doors shall be listed by Underwriters Laboratories for ratings of A label (3 hours) and less, for doors up to 4'0" (1.2m) x 10' 0" (3.05m) and pairs of doors 8'0" (2.4m) x 10' 0" (3.05m)
- F. Construction:
 - 1. Lock functions shall be manufactured in a single-sized case formed from 12 gauge steel minimum.
 - 2. Lock cases shall be closed on all sides and back.
 - 3. Locks shall have field adjustable, beveled, armored front, with a 1/8" (3mm) thickness minimum.
 - 4. Locks shall have a one piece, 3/4" (19mm) throw anti-friction stainless steel latch.
 - 5. Deadbolts, where specified, shall be full one inch (25mm) throw made of one-piece hardened stainless steel.
- G. Locks shall have a 2-3/4" (70mm) backset, standard.
- H. Strikes shall be non-handed with a curved lip.
- I. To ensure proper alignment, push/pull trim shall be through-bolted.
- J. Locks shall have brass 6-Pin cylinder, standard.
- K. Locks shall have a 10 year limited warranty. 2 year limited warranty on electrified locks.
- L. Behavioral Health, Mortise: ANSI/BHMA A156.13, Series 1000, Operational and Security Grade 1 mortise type manufactured to accepted OMH requirements with ligature-resistant lever and escutcheon trim. Locksets to be manufactured with a corrosion resistant, formed steel case. Levers and escutcheons are manufactured from stainless steel material. Provide optional lead-lining (lock body), Torx® fasteners, and Antimicrobial coating as specified in Hardware Sets.
 - 1. Acceptable Manufacturers:
 - a. Sargent Manufacturing (SA) - 8200 BHW Series
 - b. Corbin Ruswin (RU) – ML2000 BHSS Series
 - c. Accurate Lock (AC) – CP Crescent Pull Series (with Teflon pad)
- M. Behavioral Health, Mortise: ANSI/BHMA A156.13, Series 1000, Operational and Security Grade 1 mortise type manufactured to Office of Mental Health (OMH) requirements with behavioral health lever and rose trim. Locksets to be manufactured with a corrosion resistant, formed steel case. Levers and roses are manufactured from stainless steel material. Provide optional lead-lining (lock body), Torx® fasteners, and Antimicrobial coating as specified in Hardware Sets.
 - 1. Acceptable Manufacturers:
 - a. Sargent Manufacturing (SA) - 8200 BHL Series.
 - b. Corbin Ruswin (RU) - ML2000 BLSS Series.
 - c. Best Lock (BE) - SPSL Series
 - d. Town Steel (TS) - MRX-L Series

Multi-Functional Lockbody & Architectural Specifications

Healthcare Hardware

SARGENT
ASSA ABLOY

2.2 Heavy Duty Bored Locks

- A. Bored hospital latches shall be HP Series as manufactured by Sargent Manufacturing Company, New Haven, CT.
- B. Locks shall meet or exceed the requirements of ANSI/BHMA A156.2 Series 4000 Operational Grade 1.
- C. Locks shall be easily re-handed with a non-handed curved lip strike.
- D. Locks shall comply with UL 10C positive pressure requirements.
- E. Lockset paddles shall be capable of horizontal or vertical mounting positions.
- F. Locks shall have 2-3/4", 5" or 7" backset available.

The ASSA ABLOY Group is the global leader in access solutions. Every day, we help billions of people experience a more open world.

ASSA ABLOY Opening Solutions leads the development within door openings and products for access solutions in homes, businesses and institutions. Our offering includes doors, frames, door and window hardware, locks, perimeter fencing, access control and service.



SARGENT Manufacturing Company
100 Sargent Drive
New Haven, CT 06511 USA
800-727-5477
www.sargentlock.com

Founded in the early 1800s, SARGENT® is a market leader in locksets, cylinders, door closers, exit devices, electro-mechanical products and access control systems for new construction, renovation, and replacement applications. The company's customer base includes commercial construction, institutional, and industrial markets.
Copyright © 2007-2020, SARGENT Manufacturing Company. All rights reserved. Reproduction in whole or in part without the express written permission of SARGENT Manufacturing Company is prohibited. Patent pending and/or patent www.assaabloydss.com/patents.