

9 Series Stainless Steel Door Switches



In or Out...we make it Easy!®



950P4 & 950P6
4-1/2" or 6" Button
(114.3mm or 152.4mm)



940NP
1-3/4" x 4-1/2"
(44.5 x 114.3mm)



940HP
2-3/4" x 4-1/2"
(69.9 x 114.3mm)



940NHP
1-3/4" x 4-1/2"
(44.5 x 114.3mm)



940P
2-3/4" x 4-1/2"
(69.9 x 114.3mm)



950HP4 & 950HP6
4-1/2" or 6" Button
(114.3mm or 152.4mm)

Features & Benefits

940 (Rectangular)

- Large 2-3/4" by 4-1/2" faceplate
- Available in "Handicap" symbol styles (940H, 940NH)
- Momentary action switch standard
- Stainless steel faceplate
- Narrow versions are compatible with 1-3/4" door frame profiles
- Available in Spanish and blank versions (additional charges applicable)
- Tamper-Resistant

950 (Circular)

- 950-4 model features large 4-1/2" (114.3mm) diameter button with faceplate designed for 2" x 4" (50.8 x 101.6mm) switch boxes
- 950-6 model features large 6" (152.4mm) diameter button with faceplate designed for 4" x 4" x 1-1/2" (101.6 x 101.6 x 38.1mm) junction boxes
- Available in "Handicap" symbol styles (950H4, 950H6)
- Momentary action switch standard
- Stainless steel faceplate
- Available in Spanish and blank versions (additional charges applicable)
- Tamper-Resistant

Stainless Steel Switches

These popular stainless steel switches meet the highest construction and performance standards. Dependable, responsive and easy to install, these assisted door switches are ideal for a broad range of door automation applications.

In addition to the regular faceplate size, model 940 features a narrow faceplate for mounting on door frames. Model 950 comes in the standard 4-1/2" (114.3mm) diameter as well as a handy 6" (152.4mm) diameter for high visibility and **easy** use.

Optional Mounting Accessories

940 - Rectangular

- SUR**.....Surface mount box (940P/940HP)
Standard finish: Brown
- SUR-N**.....Narrow surface mount box
(940NP/940NHP)
Standard finish: Black

950 - Circular

- SUR-4**.....Surface mount box (950P4/950HP4)
Standard finish: Brown
- SUR-6**.....Surface mount box (950P6/950HP6)
Standard finish: Black

Highlights

- Debossed and Filled Exit & Handicapped Legends
- Stainless Steel
- Tamper-Resistant
- Ideal for Vandal-Prone Areas
- 2-Year Limited Warranty

Applications

- Handicap Areas
- Vandal-Prone Areas
- Vestibules
- Storefront
- Commercial
- Industrial
- Health Care

Options

940/950

- DMO**.....DPDT Momentary Switch
- WRMO**.....Weather resistant momentary
- TD30**.....30 Sec. Fixed Relock Timer
- TD30A**.....0-30 Sec. Adjustable Timer

950









- ESC-4**Escutcheons (for 950P4/950HP4)
- ESC-6**Escutcheons (for 950P6/950HP6)
- WMN**.....Wire-Mold Notch (for escutcheons)

Finishes (940 & 950)

- 3**.....Polished brass
- 4**.....Brushed brass
- 10B**.....Brushed Dark Bronze
- 32D**.....Brushed Stainless Steel (Standard)



In or Out...we make it Easy!®

Description	Switch Mode	Switch Configuration	Switch Rating	Standard Finish
940P-MO Exit Button	Momentary Action	SPDT	4A @24VDC  /CSA	32D
940NP-MO Exit Button (Narrow)	Momentary Action	SPDT	4A @24VDC  /CSA	32D
940HP-MO Handicap	Momentary Action	SPDT	4A @24VDC  /CSA	32D
940NHP-MO Handicap (Narrow)	Momentary Action	SPDT	4A @24VDC  /CSA	32D
950P4-MO Exit Button	Momentary Action	SPDT	4A @24VDC  /CSA	32D
950P6-MO Exit Button	Momentary Action	SPDT	4A @24VDC  /CSA	32D
950HP4-MO Handicap	Momentary Action	SPDT	4A @24VDC  /CSA	32D
950HP6-MO Handicap	Momentary Action	SPDT	4A @24VDC  /CSA	32D

NOTE: Specifications are subject to change without notice.

Profiles

940

950-4

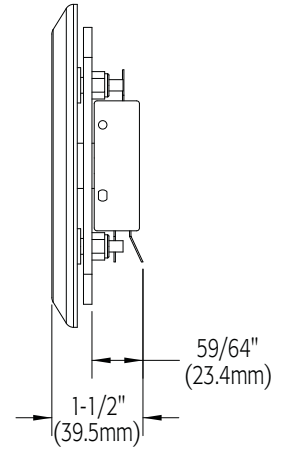
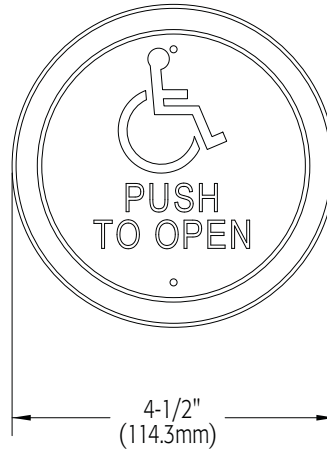
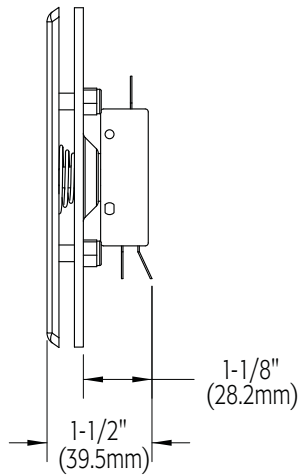
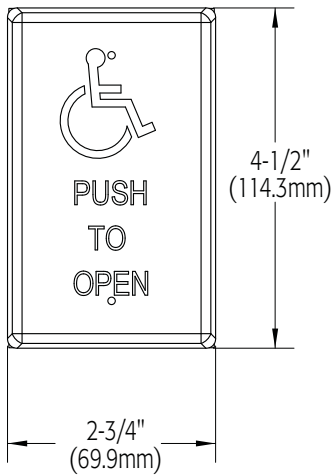

RCI also offers a complete line of Electromagnetic Locks, Electric Locks, Electric Strikes, Power Supplies, Keypads & Readers, Exit Devices, Systems & Door Hardware