

# QL Series Cylindrical Lever Locks



## Features:

**Door Preparation** – Requires standard 2-1/8" (53.97mm) bore through door.

**Backset** – 2-3/4" (69.85mm)

**Door Thickness** – Fits 1-3/8" (34.93mm) to 1-3/4" (44.45mm) doors standard.

**Latch** – Stainless Steel 1/2" (12.7mm) throw, UL Listed, guarded latchbolt on all locking functions

**Latch Front** – 1-1/8" x 2-1/4" for 2-3/4" (69.85mm) backset.

**Exposed Trim** – QL Levers are pressure cast zinc measuring 4-3/4" (120.65mm) in length. QL Roses are wrought brass 3-11/32" (84.8mm) diameter. Total projection from face of door is 2-17/32" (64.5mm).

## Finishes:

	BHMA	U.S. Equiv.	Arrow Equiv.	Finish
<b>1</b>	605	US3	03	Bright Brass
<b>3</b>	613	US10B	10B	Dark Oxide Bronze, Oil Rubbed
<b>5</b>	626	US26D	26D	Satin Chromium Plated

## Design:

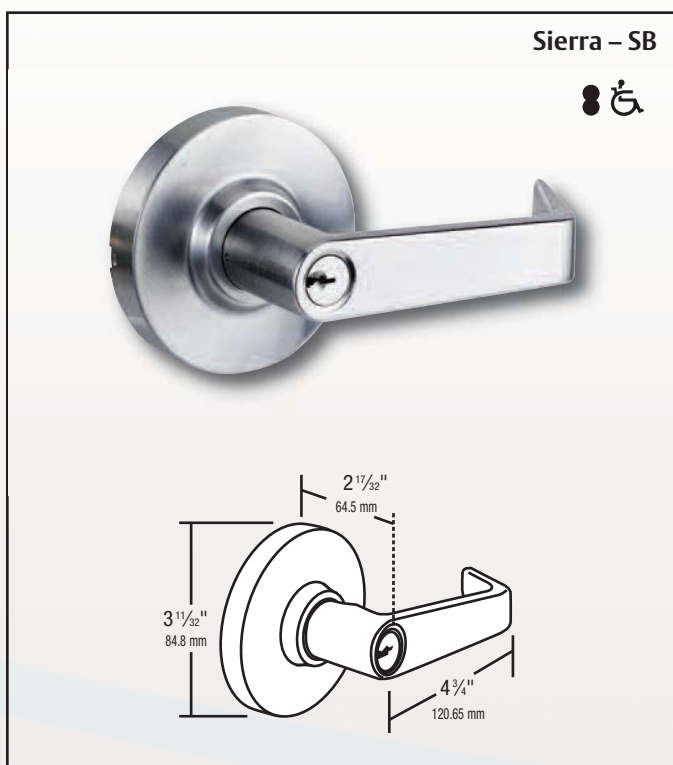

## Professional Replacement Products

The QL Series is a robust Grade 1 lockset featuring a Freewheeling Lever for abuse resistance, two screw lockset install for quick installation and a 10 Year Mechanical Warranty. The perfect solution for replacing or upgrading locksets in commercial applications.

### Freewheeling Lever

**Warranty** – Ten Year Warranty

**Handing** – Non-handed

**Packaging** – 6 per case

**Strike** – 4-7/8" ANSI (123.83mm)

**Cylinder** – Solid brass 6 pin, Arrow AR and Schlage CS Keyway, keyed different

**Keys** – 2 brass keys





## Certification & Compliance:

- Arrow QL Series Cylindrical Lever Locks are BHMA Grade 1 Certified, ANSI/BHMA A156.2, Series 4000
- All Arrow QL Series Locks are U.L. and c.U.L. list for use on 3 hour, A label or lesser doors
- Meets American with Disabilities Act Requirements

# QL Series Cylindrical Lever Locks

Professional Replacement Products

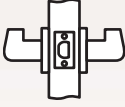
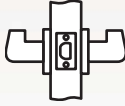
## Functions:

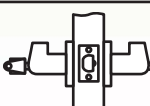
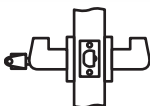
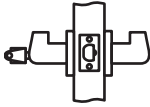
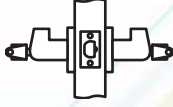
ARROW STANDARD	FUNCTION		DESCRIPTION
QL01	Passage		Latchbolt operated by lever either side.
QL72	Privacy		Latchbolt operated by lever either side except when inside turnbutton locks outside. Unlocked by rotating button or by using tool outside.
QL08	1/2 Dummy Trim		Rigid trim for one side of door only. Used as pull or to match active trim.
QL81	Entrance		Latchbolt operated by lever either side except when outside lever is locked by turn-button inside. When outside lever is locked, latchbolt operated by key outside or turning inside lever. Inside button must be manually released.
QL82	Storeroom		Outside lever always locked. Latchbolt operated by key in outside lever, or by turning inside lever.
QL87	Classroom		Latchbolt operated by lever either side except when key outside locks outside lever. Inside lever always free. Key outside locks/unlocks outside lever only.
QL97	Intruder Classroom		Deadlocking latch bolt operated by lever from either side. Key either inside or outside locks or unlocks outside lever. Inside lever always operates latchbolt.

## Latches & Strikes:

### Spring Latches 2-3/4" Backset

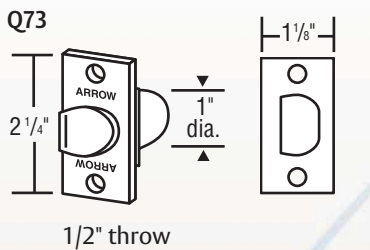

### Dead Latches 2-3/4" Backset

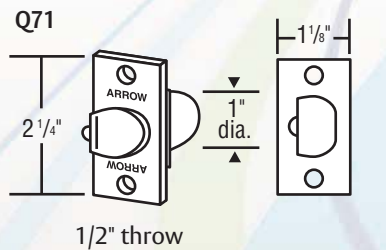

### Strikes Standard with QL Series

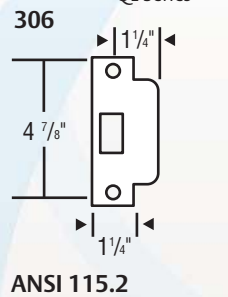

## Installation:

161 prep for retrofit and secure installation.

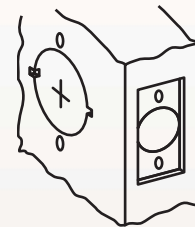

## Order Example:

**Example:** To order a QL Series entry function lockset with a Sierra design lever, satin stainless steel finish, with an Q71 strike, and 2-3/4" deadlocking latch, keyed different:

### Specify:

Standard:	QL	81	SB	26D	306	Q71	KD	XXX
	Series	Function	Design	Finish	Strike	Latch	Keying	Options (if required)