

# ET-PDL

Trilogy® Panic Exit Device Trim

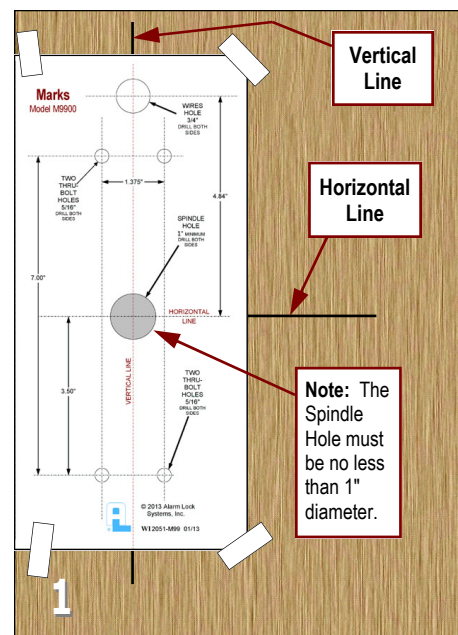

# INSTRUCTIONS & TEMPLATE



**1. Existing Installations:** Remove the existing Exit Device from the door. Position Alarm Lock template (on this sheet) on the horizontal & vertical lines of the **existing** spindle hole.

**New Installations:** Use the Marks template to mount the Marks Exit Device on the door. Remove Exit Device and use the Alarm Lock template (on this sheet) to locate and line up the template with the horizontal and vertical lines indicated and tape on the door.

**Existing and New Installations:** Mark all hole centers on each side of door (four "THRU-BOLT HOLES", one "SPINDLE HOLE" and one "WIRES HOLE"). Drill all holes from both sides of door to avoid splintering. Drill all thru holes STRAIGHT through the door.

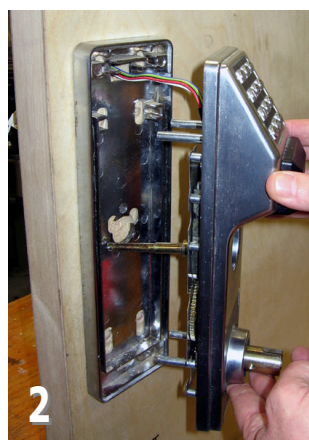

2. Position Exterior Assembly on door (shown above).

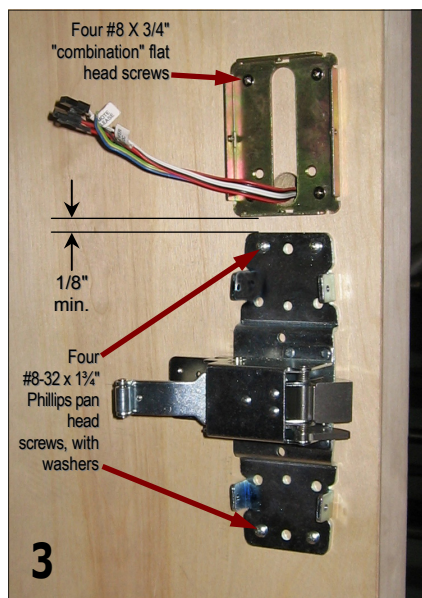

**3. Replace Exit Device and fasten with four #8-32 x 1 1/4" Phillips pan head screws and washers (do not over-tighten). Pull wires through Battery Mounting Plate (do not pinch or cut wires) and position Battery Mounting Plate a minimum of 1/8" above Exit Device, and fasten with four #8 x 3/4" "combination" flat head screws.**

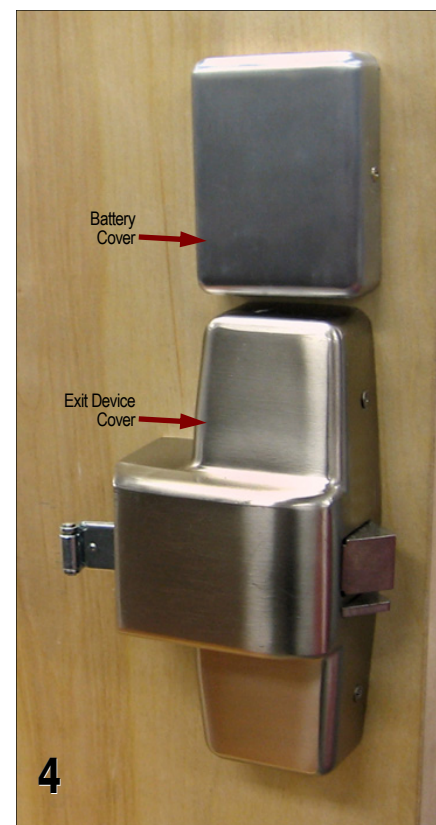

**4. Connect the Battery Pack (batteries may be shrink wrapped or may be inside a self-contained housing) and secure inside the Battery Cover with the hook and loop fastener (provided). Position the Battery Cover and fasten with four #6-32 x 5/16" screws.**

Fasten Exit Device Cover and fasten with the four screws provided (as detailed in the Marks installation instructions).

**Check lock for proper operation before closing door.**

## Marks Model M9900

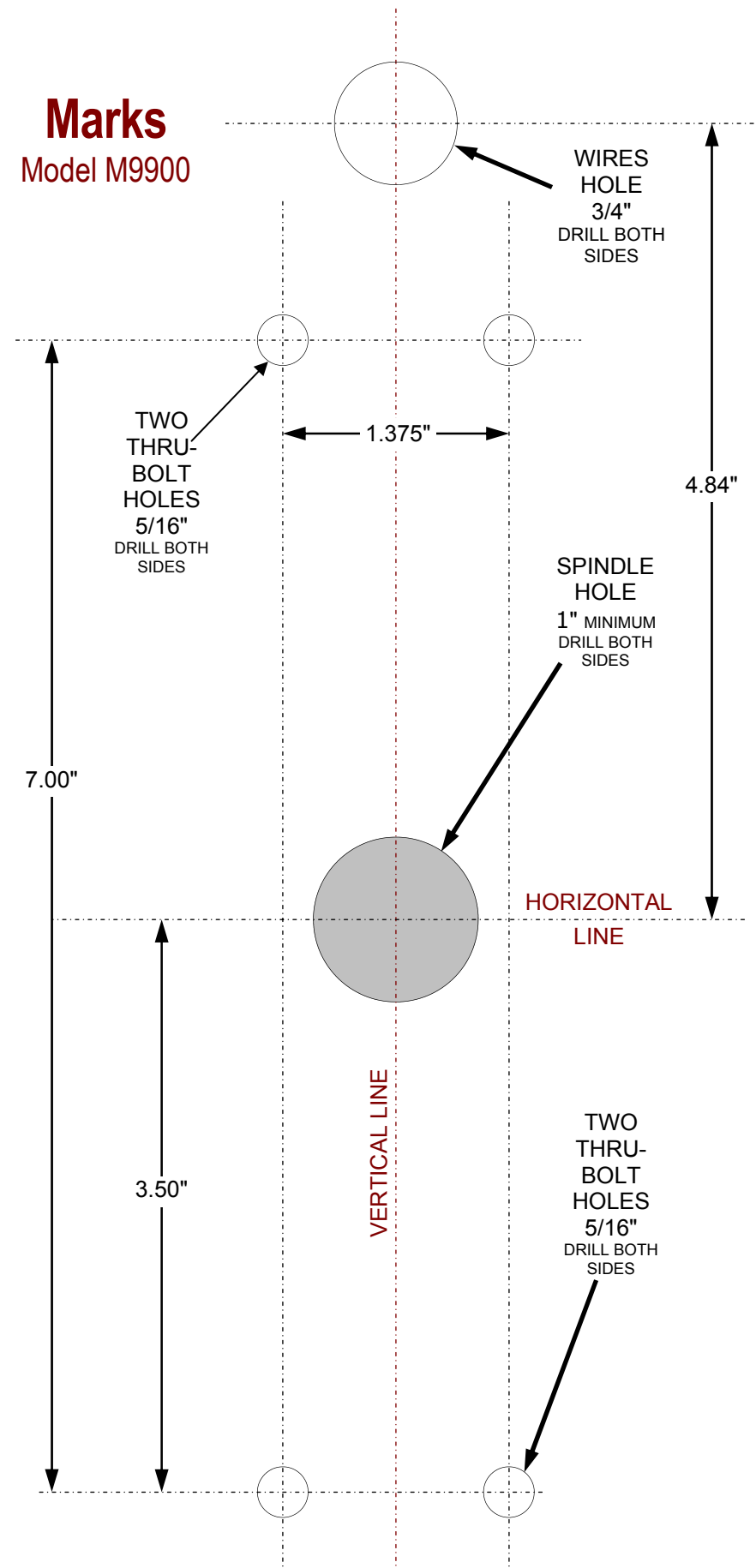

## Marks

Model M9900  
Rim Exit Device

## To Change Cylinder

**IMPORTANT:**  
When replacing cylinder be sure to use the proper Cylinder Adapter and Tailpiece.



Alarm Lock Systems, Inc.  
A division of the NAPCO Security Technologies, Inc.  
345 Bayview Avenue, Amityville, NY 11701  
Tel: (631) 789-4871 Fax: (631) 789-3383  
www.alarmlock.com  
Publicly traded on NASDAQ Symbol: NSSC

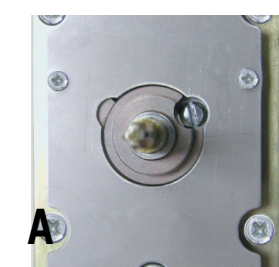

A. Remove Cover plate. Rotate the spindle either direction to expose and remove cylinder screws.

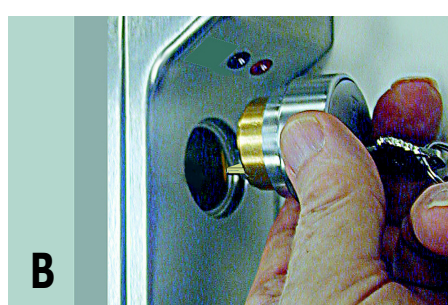

B. Remove old cylinder and insert new cylinder.

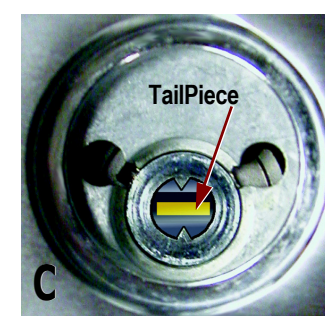

C. Note: The tailpiece must be in the horizontal position as shown in the image above.



© 2013 Alarm Lock Systems, Inc.

WI2051-M99 02/13