

MLX Series Cylindrical Lever Locks

Professional Replacement Products



The MLX Series is a robust Grade 2 lockset featuring a FreeWheeling Lever for abuse resistance, two screw lockset install for quick installation and a 10 Year Mechanical Warranty. The perfect solution for replacing or upgrading locksets in commercial applications.

Features:

Door Preparation – Requires standard 2-1/8" (53.97mm) bore through door.

Backset – 2-3/4" (69.85mm)

Door Thickness – Fits 1-3/8" (34.93mm) to 1-3/4" (44.45mm) doors standard.

Latch – Stainless Steel 1/2" (12.7mm) throw, UL Listed, guarded latchbolt on all locking functions

Latch Front – 1-1/8" x 2-1/4" for 2-3/4" (69.85mm) backset.

Exposed Trim – MLX Levers are pressure cast zinc measuring 4-3/4" (120.65mm) in length. MLX Roses are wrought brass 3-11/32" (84.8mm) diameter. Total projection from face of door is 2-17/32" (64.5mm).

Finishes:

	BHMA	U.S. Equiv.	Arrow Equiv.	Finish
1	605	US3	03	Bright Brass
3	613	US10B	10B	Dark Oxide Bronze, Oil Rubbed
5	626	US26D	26D	Satin Chromium Plated

Freewheeling Lever

Warranty – Ten Year Warranty

Handing – Non-handed

Packaging – 6 per case

Strike – 4-7/8" ANSI (123.83mm)

Cylinder – Solid brass 6 pin, Arrow AR and Schlage CS Keyway, keyed different

Keys – 2 brass keys

Certification & Compliance:



- Arrow MLX Series Cylindrical Lever Locks are BHMA Grade 2 Certified, ANSI/BHMA A156.2, Series 4000
- All Arrow MLX Series Locks are U.L. and c.U.L. list for use on 3 hour, A label or lesser doors
- Meets American with Disabilities Act Requirements



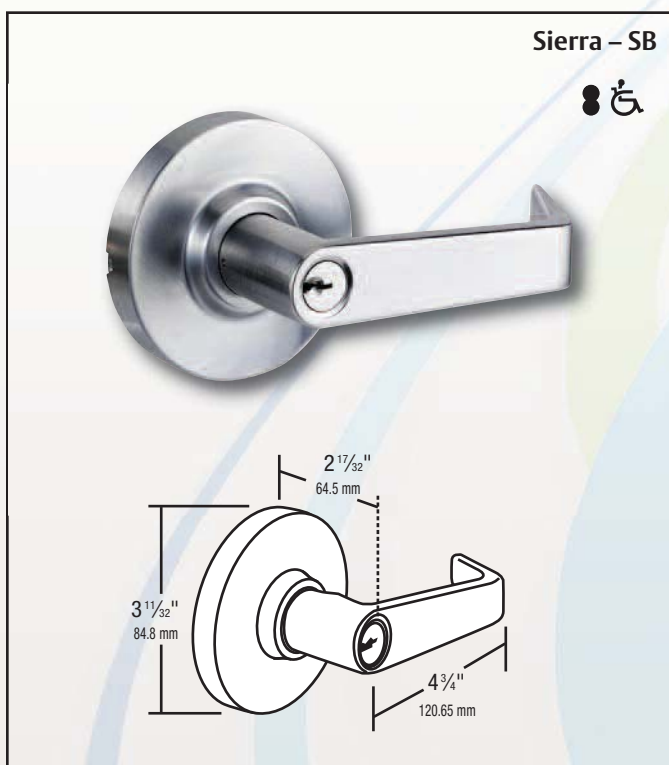

Design:

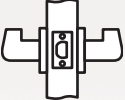
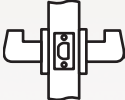

MLX Series Cylindrical Lever Locks

Professional Replacement Products

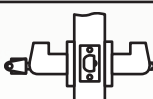
Functions:

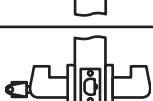
ARROW STANDARD	FUNCTION		DESCRIPTION
MLX01	Passage		Latchbolt operated by lever either side.
MLX72	Privacy		Latchbolt operated by lever either side except when inside turnbutton locks outside. Unlocked by rotating button or by using tool outside.
MLX08	1/2 Dummy Trim		Rigid trim for one side of door only. Used as pull or to match active trim.
MLX81	Entrance		Latchbolt operated by lever either side except when outside lever is locked by turn-button inside. When outside lever is locked, latchbolt operated by key outside or turning inside lever. Inside button must be manually released.
MLX82	Storeroom		Outside lever always locked. Latchbolt operated by key in outside lever, or by turning inside lever.
MLX87	Classroom		Latchbolt operated by lever either side except when key outside locks outside lever. Inside lever always free. Key outside locks/unlocks outside lever only.

Latches & Strikes:

Spring Latches 2-3/4" Backset

R23

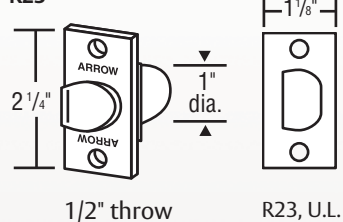

Dead Latches 2-3/4" Backset

R21

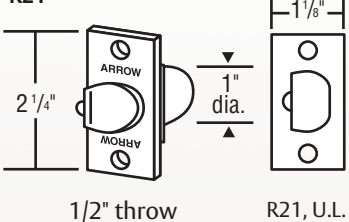

Strikes Standard with MLX Series

306

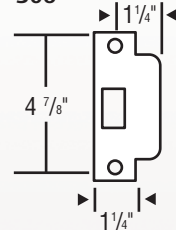

Installation:

161 prep for retrofit and secure installation.

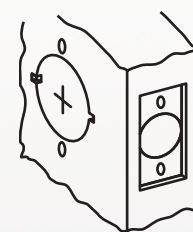

Order Example:

Example: To order a MLX Series entry function lockset with a Sierra design lever, satin stainless steel finish, with an R21 strike, and 2-3/4" deadlocking latch, keyed different:

Specify:

Standard:	<u>MLX</u>	<u>81</u>	<u>SB</u>	<u>26D</u>	<u>306</u>	<u>R21</u>	<u>KD</u>	<u>XXX</u>
	Series	Function	Design	Finish	Strike	Latch	Keying	Options (if required)