











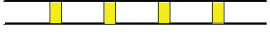

## NORMAL OPERATION LOCK INDICATIONS

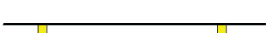
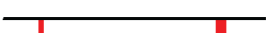
One yellow flash		Card read
One green flash		Access granted
Five yellow, one red flash		Force closed (in open mode)
Continous yellow flashes (.25 sec every second)		Comhub busy
One red flash		Access denied (AC online)
Three red flashes		Access denied (AC offline)
Continous red flashes (.125 sec every second)		Lock is blocked (when closing)
Ten red flashes		Error in Lock
Continous yellow flashes (.25 sec every 5 seconds)		Low Battery
Continous red flashes (.25 sec every 5 seconds)		Dead Battery

## NORMAL OPERATION HUB INDICATIONS

Steady Green		Online
Green, 1 red flash		Lock offline
Green, 2 red flashes		Access control offline
Green, 3 red flashes		Access control offline and Lock offline
		UHF communication

# Aperio™ eForce® A100 Narrow Stile Keyless Entry



## Owner's Manual & Installation Instructions For Models A100-3090H



**ASSA ABLOY**

Adams Rite Manufacturing Co.  
10027 S. 51st St. Suite 102  
Phoenix, AZ 85044  
Phone: 800-872-3267  
Fax: 800-232-7329  
www.adamsrite.com

Adams Rite Manufacturing Co.  
Phone: 800-872-3267  
www.adamsrite.com



**ASSA ABLOY**

# Table of Contents

Warning .....	3
Definitions.....	3
System Overview .....	4
Operational Description.....	5
Hub Location .....	6
Hub Wiring.....	7
Trim Installation Tools & Equipment .....	8
Door Preparation.....	9
Spindle Preparation.....	10
Lock Series Configuration .....	11
Handing the eForce®.....	13
Mortise Cylinder Installation.....	14
Rex/DPS Cable Installation.....	15
Mounting the eForce .....	16
Battery Installation.....	17
Limited Warranty .....	18
Troubleshooting .....	19
LED Indications .....	20

## TROUBLESHOOTING

The eForce A100 LED is normally off until a credential is presented and then LED will momentarily turn green if credentials are valid. A red LED will show if credentials are not valid.

- Place known credential card in front of eForce®:
  - If the eForce® emits one short tone, but lock does not activate, check Wiegand data lines for connectivity and proper connection.

### Green light comes on, but lever will not retract latch or deadbolt:

- Check the eForce® body connection with lock/latch mechanism.
- Check the spindle length (see installation instructions).
- Check for proper door preparation (refer to door templates).

### No lights come on and Operator stays unlocked (unsecured):

- Ensure credential card matches reader type (iCLASS or PROX) if they do not match, the card will not trigger the eForce reader.
- Check the eForce® body connection.
- Check battery level, replace if necessary.
- Check that the Battery cover is installed and secured.

### Credentials not activating lock:

- Trigger access control system to unlock the device.
- If this unlocks the lock:
  - Ensure that credentials are in system database.
  - Refer to additional EAC documentation.

# LIMITED WARRANTY

Adams Rite Manufacturing Co. (hereinafter ADAMS RITE) manufactures its products in a manner to be free of defects. Should any defect of manufacture (in material or workmanship) occur in its products, ADAMS RITE, upon prompt notification and proof to its satisfaction that the product was defective in manufacture for the use intended by ADAMS RITE, will at its option, exchange the product, repair the defect or refund the price charged by ADAMS RITE, FOB factory based on the following schedule:

- All mechanical products for five (5) years from the date of manufacture;
- All electrical products (including EL and ED exit devices) for three (3) years from the date of manufacture;
- The RITE Door<sup>®</sup> for five (5) years from the date of manufacture;
- UltraLine Electric Strikes for five (5) years from the date of manufacture.

**Limitations and exclusions:** This is a limited warranty and is in lieu of all other warranties including the implied warranties of merchantability and fitness for use) and under no circumstances shall ADAMS RITE be liable for any incidental or consequential damages or losses.

This warranty covers products as outlined above manufactured from May 1, 2003 forward.

This warranty does not cover damages from such causes as abuse, accident, neglect, fire or freight damage.

## **WARRANTY CONDITIONS**

The selling dealer from who this exit device was purchased is responsible for advising the purchaser of the period of no charge warranty exchange, repair or refund. Replacement parts under the terms of the warranty must be furnished by the Adams Rite dealer or agency.

## **FACTORY ASSISTANCE**

If the purchaser is unable to locate a service agency, or if the purchaser does not receive satisfaction from the source of which the exit device was purchased, or from local dealer, write or contact Adams Rite at the following address:

**Adams Rite Manufacturing Co.**  
**10027 S. 51st St. Suite 102**  
**Phoenix, AZ 85044**  
**Phone: 800-872-3267**  
**Fax: 800-232-7329**  
**www.adamsrite.com**

## **WARNING**

### **FCC Statement**

This equipment has been tested and found to comply with the limits for a class B digital device, pursuant to part 15 of the FCC Rules. These limits are designed to provide reasonable protection against harmful interference in a residential installation. This equipment generates, uses, and can radiate radio frequency energy and if not installed and used in accordance with the instructions, may cause harmful interference to radio communications. However, there is no guarantee that interference will not occur in a particular installation. If this equipment does cause harmful interference to radio or television reception, which can be determined by turning the equipment off and on, the user is encouraged to try to correct the interference by one or more of the following measures:

- Reorient or relocate the receiving antenna.
- Increase the separation between the equipment and receiver.
- Connect the equipment into an outlet on a circuit different from that to which the receiver is connected.
- Consult the dealer or an experienced radio/TV technician for help.

Operation with non-approved equipment is likely to result in interference to radio and TV reception. The user is cautioned that changes and modifications made to the equipment without the approval of manufacturer could void the user's authority to operate this equipment.

### **IC Statement**

This class [B] digital apparatus meets all requirements of the Canadian Interference Causing Equipment Regulations. Operation is subject to the following two conditions:

- (1) this device may not cause harmful interference, and
- (2) this device must accept any interference received, including interference that may cause undesired operation.

## **DEFINITIONS**

- **Aperio™** Aperio is a wireless lock technology for use with an access control system. Aperio is developed by ASSA ABLOY, the global leader in door opening solutions.
- **Electronic Access Control (EAC) System** – The EAC system provides the access decision to the hub where access to the lock is either granted or denied.
- **Wiegand** – Communication protocol utilized between the Aperio<sup>®</sup> hub and access control system, which consists of two data lines, WG0, WG1.
- **PROX** – Class of contactless card credentials that operate on 125kHz.
- **iCLASS** – Class of contactless card credentials that operate on 13.56MHz.
- **Secured State** – State of eForce<sup>®</sup>: turning lever does not retract latching hardware.
- **Unsecured State** – State of eForce<sup>®</sup>: turning lever retracts the latching hardware.

## SYSTEM OVERVIEW

The A100-3090H electrified trim provides access control to narrow stile aluminum doors when combined with an access control system and Adams Rite locking hardware.

The A100-3090H includes an integrated iCLASS or PROX reader and electrified lever. The lever handle will not engage the deadlatch or deadbolt until authorization is received wirelessly from the access control system. The A100-3090H is connected to the access control system through the included wireless Aperio hub. The hub connects to the access control system with Wiegand wiring and signal wiring for REX, DPS, Tamper and Low Battery.

The Aperio™ eForce® will mechanically interface with: Adams Rite MS Series Deadbolts; Adams Rite 4500/4900 Deadlatches; Adams Rite 8000 Series Exit Devices; Yale 7200 Series Narrow Stile Exit Devices; Corbin Russwin ED4000 Series, and SARGENT 8500 Narrow Design Rim Exit Devices.

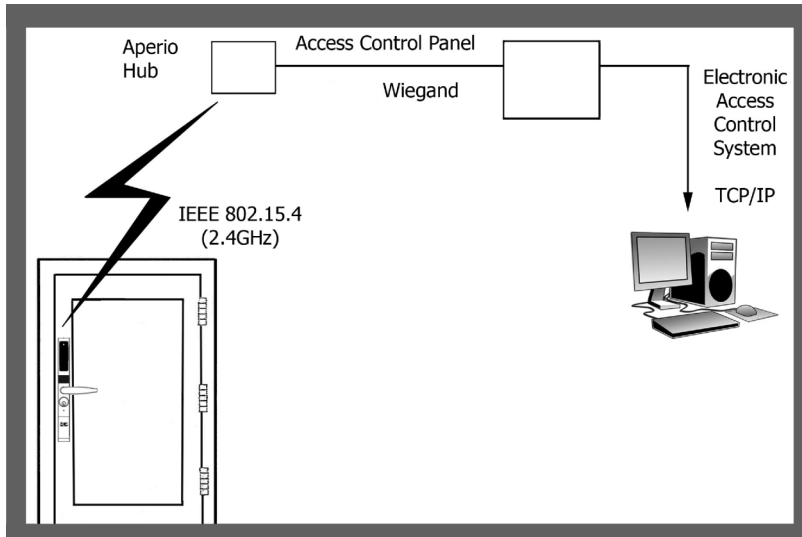

## OPERATIONAL SPECIFICATIONS

- IEEE 802.15.4 UHF Interface operating at 2.4GHz
- iCLASS or PROX Reader technology
- AES 128 bit encryption
- 4-AA battery operated
- Operating Temperature Range: -31° to 150°F (-35° to 65°C)
- Operating Humidity Range: 5% to 95% relative humidity non-condensing

## STEP 8 BATTERY INSTALLATION



FIG. 22

- Properly insert 4 (AA) Alkaline batteries into battery holder observing the polarity markings.
- Plug battery pack into eForce® connector (FIG. 22).



FIG. 23

- Insert battery case into the eForce® as shown (FIG 23).
- Slide battery cover over the batteries.
- A battery moisture shield is pre-installed at the factory to protect the batteries from the elements.



FIG. 24

- Insert 5/64" Allen key (included) and turn clockwise two full turns to secure the battery cover. (FIG. 24).
- Aperio is activated when battery cover is installed and secured.
- The eForce A100-3090H will self-test and beep once upon installation of the batteries.

## STEP 7 Mounting the A100-3090



FIG. 19

- Insert the properly dimensioned spindle into the output hub.
- Mount the A100 onto the mounting bracket and guide the spindle into the Cam Plug.
- The A100 must sit flush on the door surface.

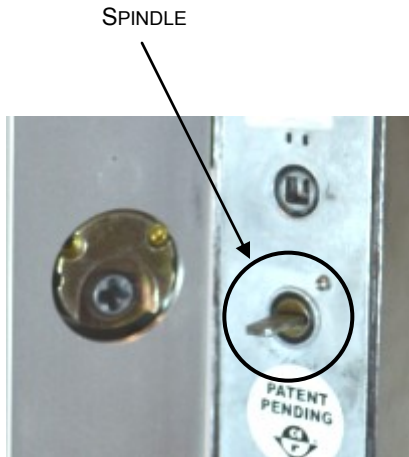

FIG. 20

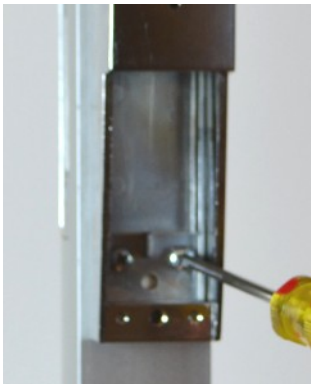

FIG. 21

- Secure with two (2) #10-32 x 5/8" screws as shown.

## OPERATIONAL DESCRIPTION

When the eForce® is in a secured state, the LED in the front plastic faceplate will be off, and the lever will not operate the locking mechanism.

### Credential Card Operation

When a user presents a supported credential to the lock, the Aperio system is designed to send the credential wirelessly to the Aperio Hub. The Aperio Hub then communicates with an EAC system. The EAC system provides the access decision to the Aperio Hub where access to the lock is either granted or denied.

To gain entry using an iCLASS or Prox Card:

- Place card in front of the small plastic cover, at a **distance no greater than one inch**.
- The access control system will receive the card credential information, and will send an unlock signal to the eForce® if the credentials are valid.
- The LED will change states from off to green, and a short audible tone will be heard to indicate a valid unlock status.
- Rotate the lever to gain entry into the building.
- Deadlatch versions will return to a secured locked state after the access control system unlock period has expired. Deadbolt versions will remain unlocked until the deadbolt is thrown again. NOTE: the access control system will determine the unlock period. There are no adjustments in the eForce® for unlock period.



### Adding Card Credentials

Consult the access control system manual or the system administrator to manage your credential database. The eForce® does not store card credentials; it simply extracts the information from the card and sends it to the access control system for verification.

### Lock & Hub Pairing

The eForce A100-3090H is paired with the communication hub that is included in the same box. Locks and hubs cannot be interchanged in the field. If either the eForce A100-3090H or the communication hub require replacement, both parts will need to be replaced at the same time.

### Manual Operation – Key Cylinder

1. Insert key into lock cylinder.
2. Turn the key 180° to the detent position and hold.
3. Rotate the lever until latch or deadbolt clear the strike and open the door.
4. Return the key to the 12 o'clock position and remove the key.



## HUB LOCATION

### Choose the Hub location

The hub should be mounted near the top of a wall, on the ceiling or above the ceiling to reduce potential for interference.

For a stable and reliable radio link, it is recommended that the hub is located within fifty (50) feet of the lock. A maximum of two interior walls between the hub and lock is recommended

Recommended locations:

A: Wall Mount

B: Ceiling Mount

C: Above Ceiling Mount

\*Note the Hub is not rated for use in Plenum spaces

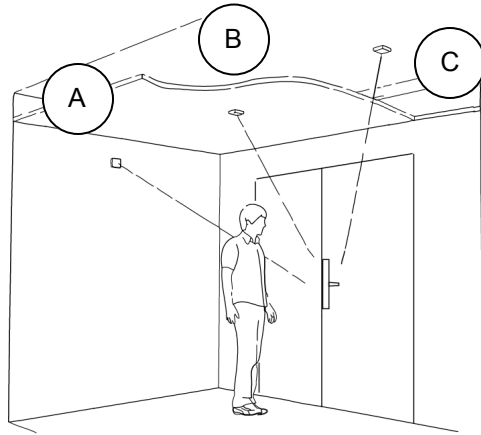

### Mounting the Hub

The included hub mounting adapter plate can be used to mount the hub on a single or double gang box.

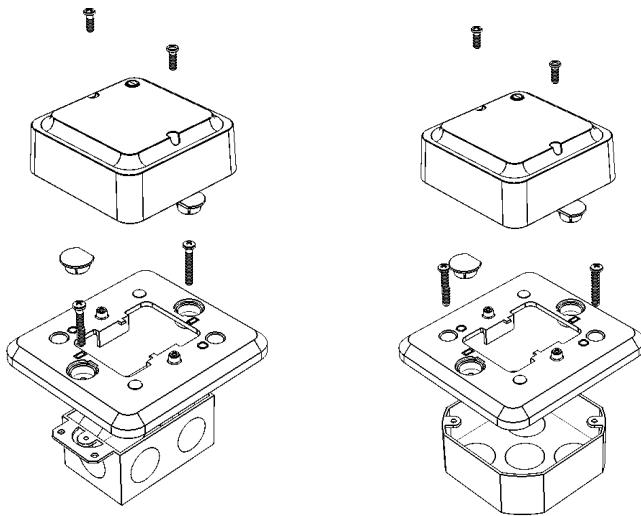

## STEP 6 REX/DPS CABLE INSTALLATION



FIG. 16

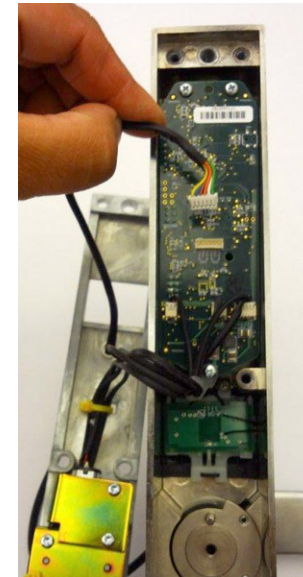

FIG. 17



FIG. 18

- Using a Phillips Head screwdriver, remove the eight (8) #10-32 x 5/8" screws on the back of the eForce and gently lift the back plate off the housing. (Fig. 16).
- Plug the Rex/DPS cable into the board and run the other end of the cable through the grommet and out of the backplate as shown in Figure 17.
- Gently place back plate on housing and secure with eight (8) #10-32

PIN #	WIRE COLOR	FUNCTION	CONTACT
1	Yellow	D.P.S. (Door Position Switch)	N.C.
2	Blue		COM
3	Brown		N.O.
4	Orange	REX (Request to Exit)	N.C.
5	White		COM
6	Green		N.O.

## STEP 5 MORTISE CYLINDER INSTALLATION

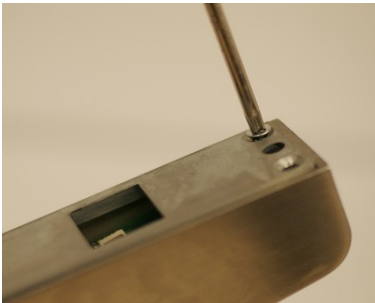

FIG. 14

- Using a Philips Head Screwdriver, remove the eight (8) #10-32 x 5/8" screws on the back of the eForce® and gently lift the back plate off the housing.

- **CAUTION!** There are wires connecting the housing and back plate assembly. Handle with care.

- **Do not over-tighten!**



FIG. 15

- Install Cylinder into housing. Secure and fasten with supplied locking ring using locking ring spanner tool. (FIG. 15)

- Gently place back plate back on housing and secure with eight (8) #10-32 x 5/8" screws.

- **CAUTION!** There are wires connecting the housing and back plate assembly. Handle with care.

- **Do not over-tighten!**

- **Do not use Dummy Cylinder!**

## HUB WIRING

The Aperio hub connects to the Access Control system via Wiegand wiring. The hub requires 8-24VDC power (250mA). The hub has four form C relays that can be used to transmit door position status, request to exit, low battery signal and a tamper signal. The Hub connects to the lock wirelessly.

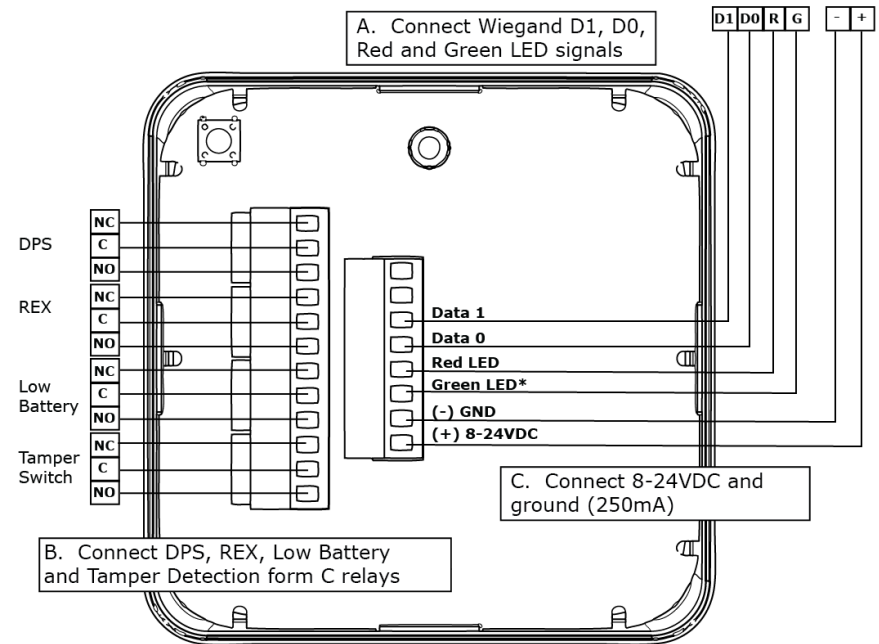

**\*Note:** the **Green LED** input is used to grant access to the lock. If the Green LED signal is not available to indicate approved access, the input can be activated by another unlock signal or relay tied to the GRN LED pin



Mounting the Hub

Scan the QR Codes to view installation videos online.



Wiring the Hub

# TRIM INSTALLATION TOOLS & EQUIPMENT

## IMPORTANT NOTES:

- The A100-3090H-C/P-01, and A100-3090H-CK/PK-01 are designed exclusively for latching hardware including:
  - Adams Rite 4500/4900 Deadlatches;
  - Adams Rite 8000 Series Exit Devices;
  - Yale 7200 Series Narrow Stile Exit Devices;
  - Corbin Russwin ED4000 Series, and
  - SARGENT 8500 Narrow Design Rim Exit Devices.
- The A100-3090H-C/P-02 & A100-3090H-CK/PK-02 are compatible with Adams Rite MS® Series Deadbolts only! **THESE UNITS ARE NOT INTERCHANGEABLE.**
- These instructions, and the fasteners supplied, apply to **metal door applications.**
- Other door types will need fasteners designed for the given medium.

## TOOLS NEEDED:

Common hand tools such as center punch, drill gun, 1/4" drill bit, Phillips screwdriver, pliers, slotted screwdriver, pencil.

## ADDITIONAL EQUIPMENT NEEDED:

An approved credential card for verification.  
Mortise Cylinder - 1" to 1 1/2" in length range with MS cam (Fig. 1). (Note: 1" cylinders require a 1/8" trim ring).

## SUPPLIED PARTS:

NOTE: A cam plug is supplied for either the -01 model latch or -02 model lock.

Item	Description	Qty.
1	Mounting Bracket (Part # 22-9076)	1
2	#10-32 X 5/8" Phillips Pan Head Screws w/Lockwasher	4
3	Spindle (Part # 22-9154)	1
4	5/64" Allen Key	1
5	Cylinder Locking Ring (Part # 24-0061)	1
6	Locking Ring Spanner Tool (Part # 22-0594)	1

**THIS PRODUCT MUST BE INSTALLED ACCORDING TO ALL APPLICABLE BUILDING AND LIFE SAFETY CODES**

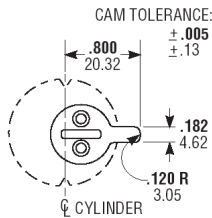
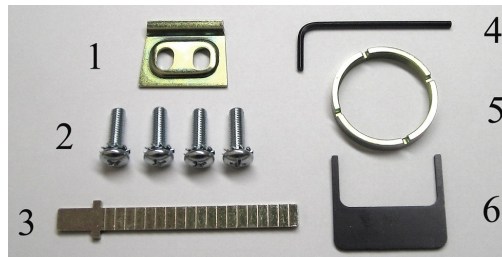
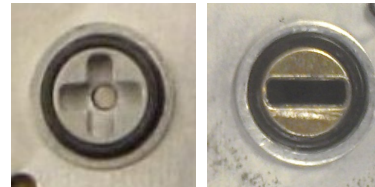

FIG. 1

## STEP 4 HANDING THE eForce®



FIG. 13



- The eForce® is shipped in a non-handed neutral position with the access cover off as shown.
- To hand the eForce®, rotate the handle until it clicks into the horizontal position.
- Proceed to step 5 if installing the A100-3090H-C/P-02 & A100-3090H-CK/PK-02!**
- The output hub, located on the back of the eForce®, is shipped with a clockwise rotation as viewed from rear. In some instances, this rotation must be changed to match the device and/or hand of the door (refer to Handing Setup Chart).
- To change rotation, insert a flat screwdriver into the output hub (FIG. 13) located on the back of the eForce® and turn approximately 270° Clockwise or Counter Clock-wise.
- This will reconfigure the unit to the opposite rotation.

### HANDING SETUP CHART

DEVICE TYPE	LEFT HAND REVERSE ROTATION	RIGHT HAND REVERSE ROTATION
SVR	CLOCKWISE	CLOCKWISE
Mortise Latch	COUNTER-CLOCKWISE	CLOCKWISE
CVR	CLOCKWISE	CLOCKWISE
Rim	COUNTER-CLOCKWISE	COUNTER-CLOCKWISE

## NOTE:

- Hubs that have (+) shape are for use with deadlatches & exits only.
- Hubs that have (-) shape are for use with deadbolts only.



**RIM Exit Device Application: A100-3090H for 8700/8800**

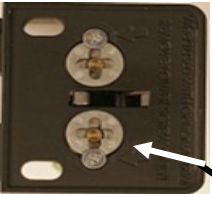

FIG. 10

- On the back side of the exit device, remove only the lower Phillips head screw, depending on hand of door, to free up the cylinder actuator for use. (FIG. 10)

CYLINDER ACTUATOR SCREW



FIG. 11

**MS 1850 Application: A100-3090H for MS® Series Deadbolt**

- Two (2) brass hex head screws and the set screw from the MS1850 will fasten the cam plug to the MS1850. (FIG. 11)
- For MS® Deadbolt, insert Cam Plug (FIG. 12) into lock case with notch on the cam plug aligned with lock case setscrew.
- Tighten setscrew and secure with the two (2) brass cam plug screws. Cam Plug must be positioned below door surface.

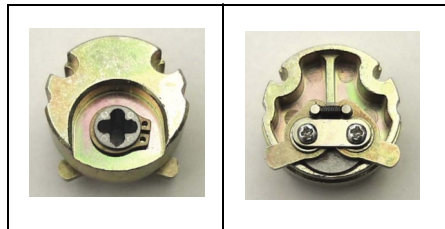
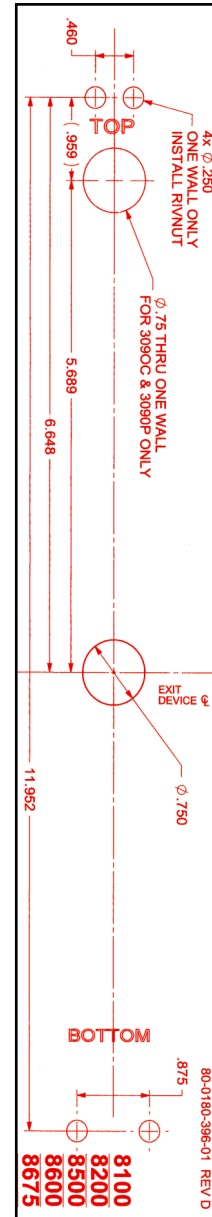

FIG. 12

**STEP 1 DOOR PREPARATION**

FIG. 2



- Select the stick-on template to match the application.
- For Yale, Corbin Russwin and SARGENT exit devices, use template 80-0180-396-01.
- Mark the backset and horizontal centerlines.
- Apply clear template over the centerline marks (FIG. 2).
- Center-punch four (4) referenced mounting holes and remove template.
- Drill holes at center-punch locations using a 1/4" drill bit.
- Install Rivnuts. Refer to instructions supplied in Rivnut kit.
- Install mounting bracket (Item 1) with two (2) each of #10-32 x 5/8" (Item 2) Phillips pan head screws. (FIG. 3)

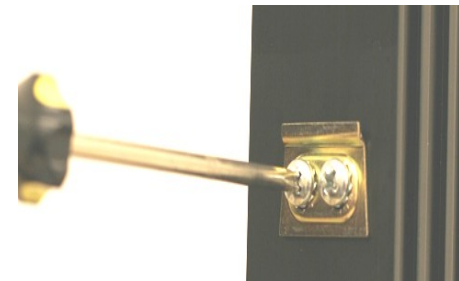

FIG. 3

## STEP 2 SPINDLE PREPARATION (For 1-3/4" doors)

**For Adams Rite MS1850 Deadbolts, 4500/4900 Deadlatches, & 8000 Series Mortise Exit Devices:**

Snap-off spindle at fifth (5th) notch as shown in FIG. 4. For 2" thick door add one notch.

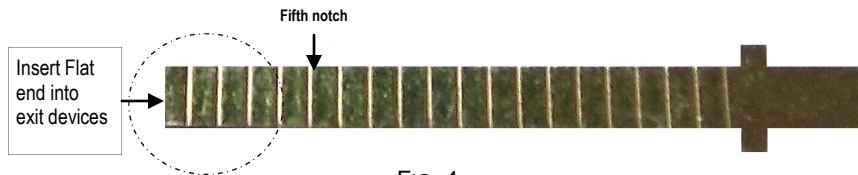

FIG. 4

**For Adams Rite 8600 Concealed Vertical Rod Exit Devices:**

Snap-off spindle at sixth (6th) notch as shown in FIG.5. For 2" thick doors add two notches.

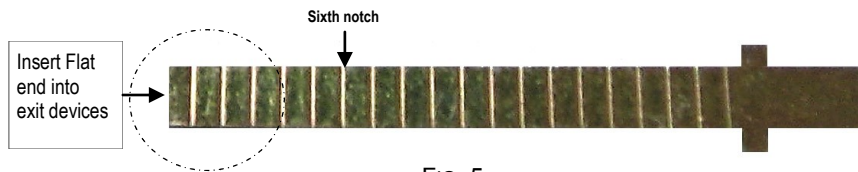

FIG. 5

**For Adams Rite 8000 Series Surface Vertical Rod & Rim Exit Devices, Yale 7200 Series Narrow Stile Exit Devices, Corbin Russwin ED4000 Series, and SARGENT 8500 Narrow Design Rim Exit Devices:** Snap-off spindle at fourteenth (14th) notch as shown in FIG. 6. For 2" thick doors add two notches.



FIG. 6

## STEP 3 CONFIGURE FOR LOCK SERIES

**Mortise Latch Application: A100-3090H for 4500/4900 (including 8300/8400 Exit Devices)**

Configure the supplied cam plug to match the hand of door. Insert into latch case with notch on the cam plug aligned with latch case set screw. Tighten set screw and secure with the two brass cam plug screws.



**CVR Exit Device Application: A100-3090H for 8500/8600**

Install Tailpiece adapter on the vertical rod and fasten with Phillips screw as shown.

FIG. 9

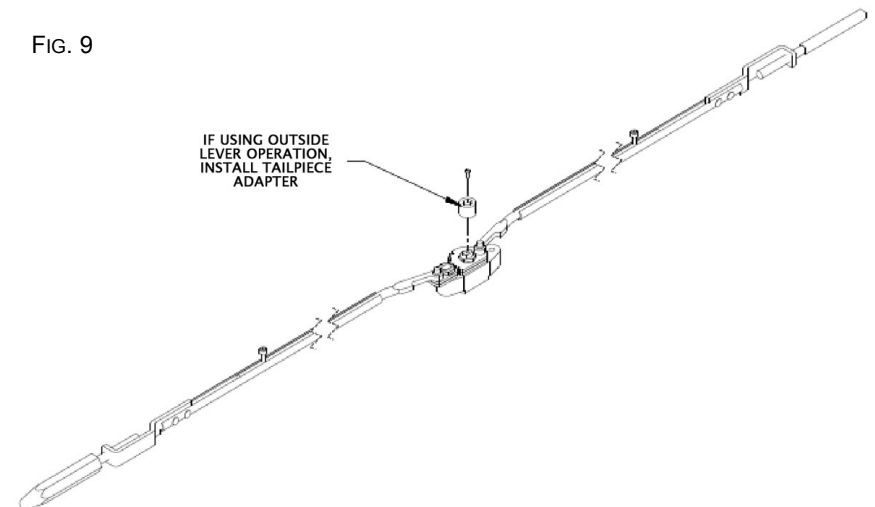

Note: Devices manufactured before 1997 will not accept the tail piece adapter