

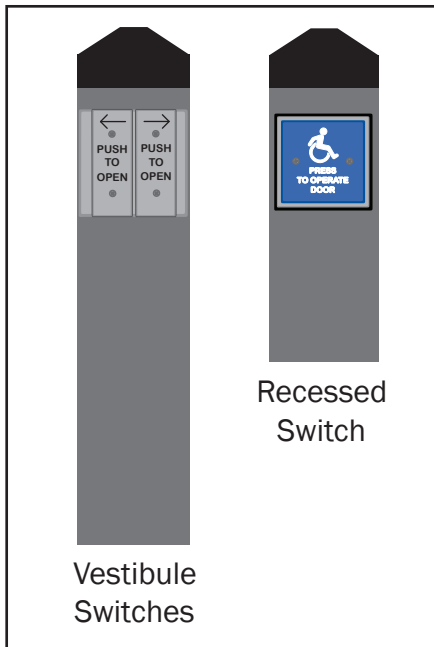

ENGINEERED FOR MOTION

608 Series Heavy Duty

Push Plate Switch Posts



base coat on all surfaces and an industrial grade exterior powder coat finish. An innovative ABS plastic rust shield fits under the mounting shoe to help block the corrosive action of concrete to steel contact. The integral plastic cap allows superior wireless signal range.

The 608 Series posts come standard with a single recess mounted switch, 2 switches for vestibule operation or blank (without preps) so that equipment can be custom fit in the field. MS SEDCO also offers custom machining and special finishes. All versions can be ordered for either hardwired or wireless operation.

Technical Data

- Microswitch Includes Rubber Bellows For Added Weather Protection
- 5" Square Tubular Steel, 1/8" Wall Thickness
- Formed Plastic Cap With Integral Transmitter (Optional) For Wireless Operation
- Interchangeable Surface And Inground Mounting Shoes
- Durable Exterior Grade LongLife™ Finish with Rust Shield In Gray Or Dark Bronze

DIMENSIONS
See Reverse

APPLICABLE STANDARDS

American National Standards Institute (ANSI) - Building Hardware Manufacturers Association (BHMA) - ANSI/BHMA A156.10 & A156.19.

Availability & Cost

AVAILABILITY

Available internationally from manufacturer's authorized distributors; contact MS SEDCO for the location of nearest distributor.

COST

Cost information on MS SEDCO products is available from the manufacturer's authorized distributors.

Warranty

MS SEDCO, Inc. guarantees this product to be free from manufacturing defects for one year from date of installation. Unless MS SEDCO is notified of the date of installation, the warranty will be in effect for one year from the date of shipment from our factory. If, during the first year, this product fails to operate and has not been tampered with or abused, the unit can be returned prepaid to the factory and be repaired free of charge. After one year, the unit will be repaired for a nominal service charge. **Limited warranty is in lieu of all other warranties, expressed or implied, including any implied warrantability of merchantability, no representative or person is authorized to assume for MS SEDCO any other liability in connection with the sale of our products. All warranties are limited to the duration of this written limited warranty. In no event shall MS SEDCO be liable for any special, incidental, consequential or other damage arising from any unclaimed breach of warranty as to its products or services.**

Product Name 608 Series

Heavy Duty Push Plate Switch Posts with LongLife™ Finishes

Contact Information

MS SEDCO
7898 Zionsville Road
Indianapolis, IN 46268
Phone: (317) 842-2545
www.mssedco.com

Product Description

BASIC USE

The 608 Series Switch Posts are designed to provide a free standing self-contained door activation device that can be installed at any location.

Attractive and built to withstand the toughest conditions, the 608 Series posts are made of 5" square tubular steel that is 1/8" thick. The durable LongLife™ Finish protects against rust and consists of two coats: a zinc rich

608 Series Heavy Duty Push Plate Switch Posts



ENGINEERED FOR MOTION

Maintenance

MS SEDCO recommends that all maintenance and adjustments be performed by an AAADM Certified Technician.

Technical Services

MS SEDCO's staff of factory trained sales and service personnel offer design assistance and technical support. Local distributors are also available to assist in selecting appropriate devices for specific uses and to provide onsite installation.

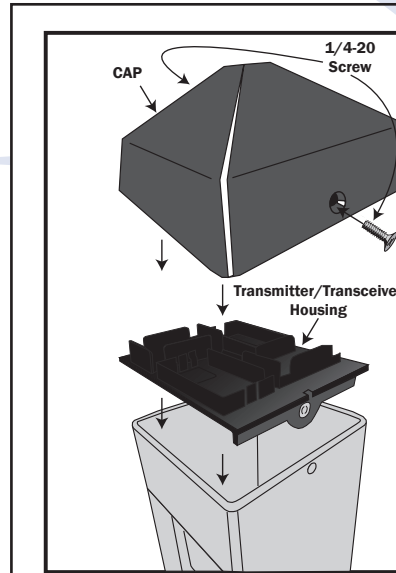

OPTIONAL RADIO TRANSMITTER LOCATED DIRECTLY UNDER PLASTIC END CAP FOR OPTIMUM PERFORMANCE AND EASE OF BATTERY REPLACEMENT

DIMENSIONS

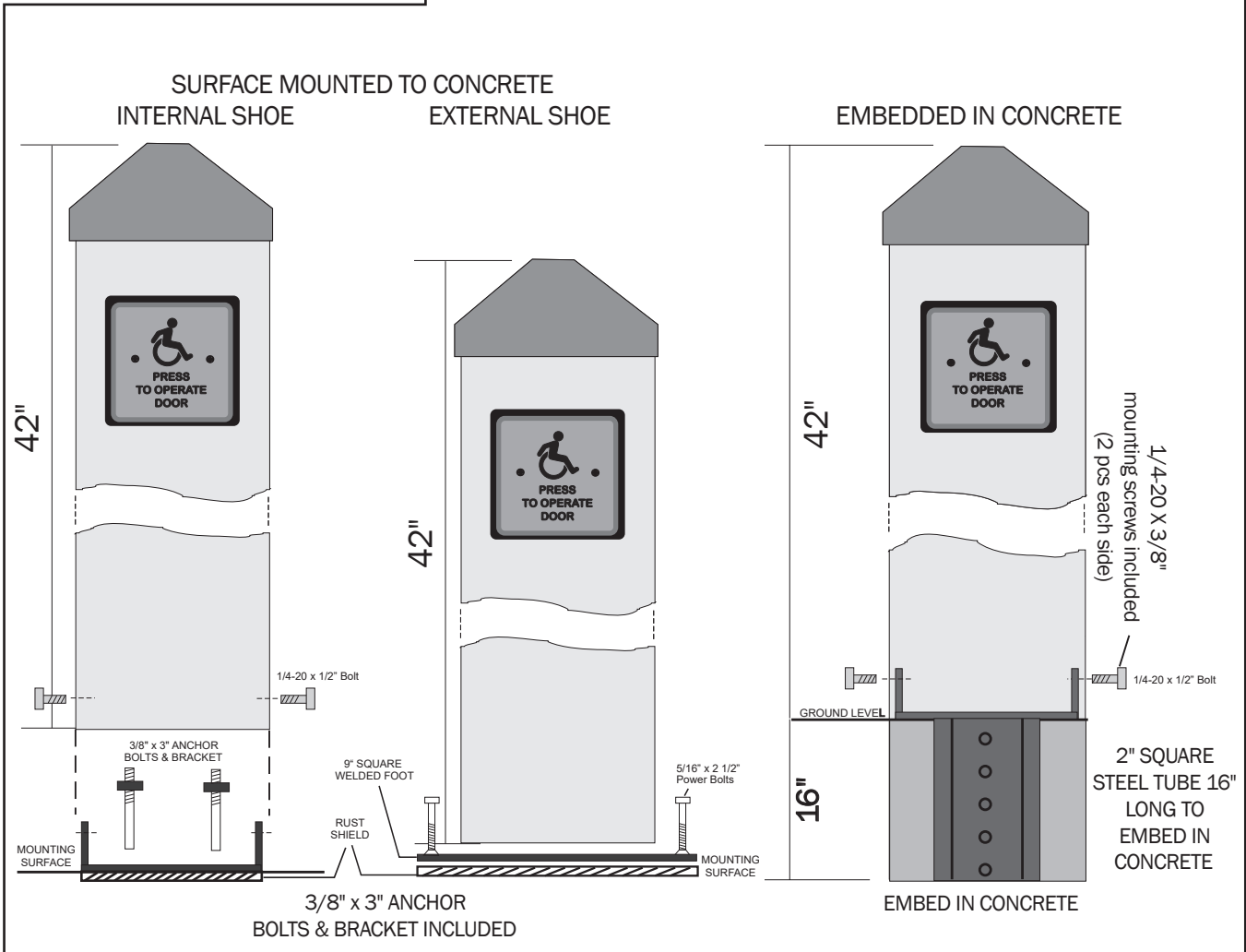

112017