



**IVES**

# Price book 8

Effective April 4, 2020 • Rev 04/20



**This price list supersedes and cancels all previous price lists. Prices shown are subject to change without notice.**

### Administrative Offices

Allegion Administrative Office  
11819 N. Pennsylvania St.  
Carmel, IN 46032  
allegion.com/us

### Placing orders

You can place orders with Allegion via the fax number or email listed below:

Fax#: 1-877-424-8494  
Email: Order\_lves@allegion.com

### Customer Care

Our Customer Care Representatives are available for questions or assistance.  
You can reach them at **877-671-7011** (Press 1 for Sales Support | Press 2 for Product Support | Press 3 for RSO) or through the email addresses listed below:

### Sales Support

support@allegion.com

### Technical Product Support

---

#### Hinges, O/H Stops, Accessories

Accessories\_TechProdSupport@allegion.com

### Request for Quote

---

#### Carolinas

(North Carolina, South Carolina, Virginia)  
Carolinas.Quotes@allegion.com

#### Central

(Arkansas, Illinois, Iowa, Kansas, Missouri, Nebraska, Oklahoma)  
Central.Quotes@allegion.com

#### Chicago

(Illinois-Northern, Wisconsin)  
Chicago.Quotes@allegion.com

#### Florida

Florida.Quotes@allegion.com

#### Great Lakes

(New York, Pennsylvania)  
GreatLakes.Quotes@allegion.com

#### Metro New York

Metro.Quotes@allegion.com

#### Michigan

Michigan.Quotes@allegion.com

#### Mid Atlantic North

(New York, Pennsylvania)  
Mid.Atlantics.north.quotes@allegion.com

#### Mid Atlantic South

(Delaware, Maryland, New Jersey)  
Mid.Atlantics.south.quotes@allegion.com

#### Midwest

(Indiana, Kentucky, Ohio, West Virginia)  
Midwest.Quotes@allegion.com

#### Mountain States

(Colorado, Idaho, Montana, Nevada, Utah, Wyoming)  
Mtn.States.Quotes@allegion.com

#### New England

(Connecticut, Main, Massachusetts, New Hampshire, Rhode Island, Vermont)  
NewEngland.Quotes@allegion.com

#### North Central

(Minnesota, North Dakota, South Dakota)  
NorthCentral.Quotes@allegion.com

#### Northern California

NoCal.Quotes@allegion.com

#### Northwest

(Alaska, Oregon, Washington)  
Northwest.Quotes@allegion.com

#### South

(Alabama, Georgia, Louisiana, Mississippi, Tennessee)  
South.Quotes@allegion.com

#### Southern California

(California-Southern, Hawaii)  
SoCal.Quotes@allegion.com

#### Southwest

(Arizona, New Mexico)  
Southwest.Quotes@allegion.com

#### Texas

Texas.Quotes@allegion.com

Terms and Conditions ..... ii-v  
How to use this book ..... vi  
Index by Product Number..... vii  
Keys to Finishes ..... viii-ix  
Hinges..... 1-15  
Continuous Hinge..... 16-23  
Pivots .....24-26  
Architectural Hardware.....27-88  
Warranty ..... Inside Back Cover

**BAA/ARRA**

For a list of available BAA/ARRA compliant products please contact your local RSO or Customer Care at 877-671-7011

## Allegion General Terms and Conditions of Sale and Service

**1. GENERAL/ACCEPTANCE.** (a) This Agreement contains the only terms and conditions by which Company will quote and sell Deliverables to Customer; (b) The terms "purchase order" or "order" for the purposes of this Agreement include the term "request for quotation," as appropriate; (c) This Agreement supersedes all pre-printed or boilerplate terms and conditions set forth in any purchase order issued by Customer; (d) No reference herein to Customer's purchase order will in any way incorporate different or additional terms and conditions, all of which Company hereby expressly objects to; (e) **ANY ACCEPTANCE BY COMPANY OF CUSTOMER'S PURCHASE ORDER IS EXPRESSLY CONDITIONED ON THE CUSTOMER'S ASSENT TO AND ACCEPTANCE OF THE TERMS AND CONDITIONS CONTAINED IN THIS AGREEMENT;** (f) Company reserves the right to decline any order, in whole or in part, for any reason.

### 2. ORDERS.

a. **Order Processing.** When Customer wishes to place an order for Deliverables, it will deliver to Company a purchase order. All such purchase orders must (i) be in a written format acceptable to Company, (ii) be legible, (iii) include a purchase order number, (iv) include Customer's account number, invoice address, ship to address, shipping method, shipper's letter of instruction for international shipments, part number, pricing, and designated contact information, (v) include, if applicable, any special configuration ID numbers, necessary programming information, special factory instructions, and requested specifications regarding a particular finish, handing, design, backset, or strike, (vi) reference any applicable pricing discounts under an ongoing buying program or based on a written quote from Company, along with the applicable buying program number or quotation number, and (vii) not combine buying program and quoted product on the same order.

b. **Minimum Orders.** In the event the order value does not meet any required minimum net Deliverable value, Company may, at its sole discretion, (i) increase the quantity of items in the order to meet the minimum net Deliverable value requirement; (ii) apply a minimum order charge; (iii) reject the order, or (iv) waive the requirement, provided that the waiver of a requirement for one order shall not constitute a waiver of the requirement for any future orders.

c. **Acceptance of Purchase Orders.** Company will endeavor to (i) acknowledge receipt of each purchase order issued in accordance with this Agreement, and (ii) notify Customer whether Company accepts or rejects the purchase order. If Company fails to accept or reject a purchase order within a reasonable time period, such failure to respond will be deemed a rejection of the entire order. Orders that combine buying program and quoted product on the same order will be routed back to your local RSO office in order to review subject purchase order.

d. **Changes to Order/ Cancellation of Orders.** Additional terms and conditions regarding order changes and cancellations are available on the Allegion customer website, **WHICH TERMS ARE EXPRESSLY INCORPORATED HEREIN BY REFERENCE.** Unless otherwise provided herein, Customer acknowledges that (i) requesting a Change Order may cause a delay in the scheduled shipment date, a longer lead time or result in a new scheduled shipment date; (ii) Orders may not be changed after 48 hours of Company's order acknowledgment; (iii) After 48 hours of Company's order acknowledgment, all changes to an accepted purchase order will be subject to a Change Order charge of 25% of the net Deliverable value, plus the cost of labor and fabrication or raw material that Company incurred prior to the receipt of the Change Order from Customer, or that may be required due to the Change Order; (iv) the requested change may result in additional charges for labor, fabrication, and raw material, and (v) if Customer cancels an order or portion of an order that includes Deliverables that have been manufactured and prepped for shipping, a 45% restocking fee will apply. Notwithstanding the foregoing, Customer cannot change or cancel credential orders, reader orders, biometrics orders or any non-cataloged, special, Custom or nonstandard items once they have been placed. All cancelled orders for a Non Recurring Expense (NRE), credential orders, reader orders, biometrics orders, and/or Custom orders will be subject to a cancellation charge of 100% of the acknowledged price.

e. **Add-ons.** Add-on orders will not be accepted. Additions to orders will be entered as separate stand-alone orders and must qualify for all terms of sale, including discounts, on an individual basis.

f. **Fast-Track Orders.** No changes or cancellations will be accepted on the 24-Hour Fast Track Program. For 3-day Fast Track orders, changes and cancellations may only be requested by Customer within 24 hours of Company's order acknowledgment if the order has not shipped. For 5-Day Fast Track orders, changes and cancellations may only be requested by Customer if the order has not shipped and if the request is made to Company within 48 hours of Company's order acknowledgment. Return Material Authorization (RMA) for Deliverables must be processed through Fast Track Customer Service.

g. **Steelcraft Orders.** For all Steelcraft orders, changes or cancellations are allowed without penalty only if made within 48 hours of Company's order acknowledgment, and provided that the order has not shipped. Some exceptions do apply – please consult the factory. Changes are not allowed on Rapid Program orders after the order has been entered and acknowledged. After 48 hours of Company's order acknowledgment, all changes or cancellations are subject to a charge of 25% of the order. Unless otherwise specified by Company in writing, any changes to orders acknowledged by Company that affect the delivery date will be deemed a new order and will require acknowledgement by Company as provided in this Section. Additional products, features, terms and conditions regarding the Rapid Program are available on the Allegion customer website, **WHICH TERMS ARE EXPRESSLY INCORPORATED HEREIN BY REFERENCE.**

### 3. PRICES, INVOICES AND PAYMENT.

a. **Prices.** The prices in Company's Price Book are subject to change at any time, without notice to Customer. Company may charge Customer additional amounts if Customer requests special packing, marking, shipment, product modification, or engineering services. Oral prices specified by Company are null and void. Quote numbers must be referenced on Customer's purchase order in order for the Company's quoted pricing to apply. Orders that do not reference a quote number will receive buy program pricing or book net pricing. Quoted prices are for those specific products quoted for a specified job, and are subject to the Price Book in effect at the time Company receives the order.

b. **Taxes.** Prices do not include any present or future federal, state or local property, license, privilege, sales, use, excise, gross receipts or other like taxes or assessments which may result from transactions or any services performed in connection therewith. Any taxes, charges, or duties imposed by any governmental authority on the sale of Deliverables will be paid by Customer, in addition to the selling price specified by Company. Credits for U.S. sales tax applied to invoices will only be granted if valid exemption documentation is provided within 30-days of the invoice date and a case is initiated by customer service. Exemption documentation may be emailed to [sales.tax.certificates@allegion.com](mailto:sales.tax.certificates@allegion.com), this e-mail address cannot be used to request a credit for sales tax charged all such requests must be made with customer service. All certificates sent to the e-mail address must include the following information: (1) Customer account number(s); (2) Customer name; and (3) Allegion brand(s) the certificate should be applied to.

c. **Payment Terms.** Company will deliver to Customer an invoice with each shipment of Deliverables hereunder. Customer will pay all invoiced amounts within 35 days of the invoice date (subject to any early pay discounts that may be offered to Customer by Company in its sole discretion). Customer will make all payments in United States dollars. Past due invoices will be subject to a late payment service charge of 1.5% per month on any overdue unpaid balance, equivalent to 18% per annum, or the maximum rate permitted by law, whichever is less. Customer shall reimburse Company for all costs of collection, including, without limitation, reasonable attorneys' fees, for any overdue amount owed by Customer to Company, and such collection costs shall also be subject to interest charges.

### 4. QUOTATIONS.

a. **Project Quotations.** Project or new construction quotes are restricted to the specific project quoted for the quantities, finishes, and series of Deliverables referenced on the quote. Company reserves the right to require proof of sale of Company products for any quoted project.

b. **Stock Quotations.** Deliverables fulfilling stock quotations may only be used for the following: i) Stocking of the Customer's shelves for small, quick-turn, discretionary projects, or ii) Sale to a general contractor or installer for new construction. Stock quotations may not be used for any project containing any Company no-substitution, specified products. Deliverables purchased under Stock Quotations cannot be redistributed to other Customer branch locations or re-sold to other resellers or used for aftermarket sales, end-user annual contracts or sold over the counter to any walk in trade.

c. **General.** All quotes are subject to this Agreement, unless otherwise specified by Company, and are subject to change at any time prior to Company's acceptance of a purchase order referencing the applicable quote number. Company, its representatives and employees reserve the right, in their sole discretion and for any reason, to refuse a Customer's request to quote a price other than the standard list price, regardless of whether Company or its representatives or employees have previously quoted discounted prices to the Customer on some or all of its orders. Customer's failure to comply with this Section 4 will be considered a material breach of this Agreement, and will entitle Company to immediately terminate any purchase orders and/or Customer's ability to distribute Company's products.

**5. SECURITY INTEREST.** Customer grants Company, and Company retains, a purchase money security interest and lien on any and all of Customer's rights, title and interest in each Deliverable sold by Company to Customer, wherever located, until the invoice for the applicable Deliverable(s) is paid in full, including any late charges and costs of collection. Customer authorizes Company to, and will assist Company in, taking all necessary steps to perfect and maintain Company's interest in such Deliverables.

**6. CREDIT TERMS.** Unless Customer pre-pays all of its purchase orders in advance, its purchase orders will be subject to the credit limit and other terms of credit ("Credit Terms") set forth in Company's credit application, which Credit Terms Customer acknowledges are subject to change by Company at any time. Company reserves the right to request payment in advance of shipment or any order or to request adequate assurances for Customer's payment of an order and may withhold or stop shipment, without any liability to Company, until Customer submits payment or adequate assurance of payment.

**7. RESALE OF DELIVERABLES.** Customer agrees and warrants that it will offer Company products in support of Company-written specifications and will maintain sufficient inventory to adequately support End Users, installers, and/or general contractors' needs. Company may implement an MSRP or a resale pricing programs at any time in its sole discretion. Failure to comply with such program(s) will be considered a material breach of this Agreement, and will entitle Company to immediately terminate any purchase order and/or Customer's ability to distribute Company's products. Customer shall, at its own expense, gain and maintain sufficient knowledge of the industry and products competitive with Deliverables so as to be able to (a) explain in detail to End Users, installers, and/or general contractors the differences between the Deliverables and competing products, (b) ensure that an adequate number of trained, capable and qualified technical personnel with sufficient knowledge of the Deliverables and who have obtained all necessary licenses and permits are available to assist End Users, installers, and/or general contractors, and (c) respond to such End Users, installers, and/or general contractors with respect to the general operation and use of the Deliverables including, but not limited to, (1) acting as a liaison between the End Users, installers and/or general contractors and Company in matters requiring Company participation, (2) providing general product information and configuration support on standard protocols and features, (3) collecting relevant technical problem identification information, and (4) posting and distributing any warranty information concerning the Products in accordance with Company's instructions. Customer is responsible for all service and support resulting from the re-sale of any Deliverable to End-Users, installers and/or general contractors, examples of which may include, but are not limited to, support activities such as installation, initialization, software set-up, training, trouble-shooting, technical support and field service. In the event Customer is unwilling or unable to perform said support activities, Company reserves the right to recover from Customer any and all expenses incurred by Company to resolve the afore-mentioned End-User, installer and/or general contractor issues. Technical product training is recommended for Customer in order to fully service and support Deliverables purchased from Company that are resold to End-Users, installers and/or general contractors.

**8. DEFAULT.** If Customer is in default of payment or otherwise with respect to any purchase order or other contract with Company, Company shall have the right, in addition to all other legal remedies and without prejudice to any of its right hereunder, to defer further shipments under that or any other purchase order until such default is corrected and to declare all outstanding bills of Customer to be immediately due and payable.

### 9. INSPECTION AND DELIVERY.

a. **Inspection.** Customer will inspect all Deliverables immediately after receiving them. Customer will be deemed to have accepted the Deliverables unless Customer notifies Company in writing of any nonconformance within 10 days of delivery and provides Company written evidence reasonably documenting that nonconformance. Inspection of Deliverables at Company's facility is not permitted.

b. **Delivery.** Delivery schedules for Deliverables are based upon current production capacities, material or component availability, and inventory, and may be changed by Company as conditions require. Delivery schedules for services are based upon Company's prompt receipt of, and prompt access to, Customer's equipment and all information necessary to complete the services. In no event will any delivery date be construed as falling within the meaning of "time is of the essence." Partial delivery shall be accepted by Customer and paid for at the price and on the terms stated herein. Any partial delivery shall constitute a separate sale, and payment shall be separately made when due. If any part of a delivery hereunder is not delivered by Company in accordance with Customer's purchase order, this Agreement shall not be affected thereby.

**10. TITLE & RISK OF LOSS.** Unless otherwise specified by Company, (i) where the Customer is located in the United States, all Deliverables will be sold "Uniform Commercial Code, FOB Origin, Company's factory"; and (ii) where the Customer is located outside of the United States, all Products will be sold "Ex-works, Company's factory (Incoterms 2010)." In either instance, title and risk of loss will pass to Customer upon delivery to the carrier at Company's factory, provided, however, as set forth herein, Company shall retain a security interest in the Deliverables until full payment has been made therefore, and Customer agrees, upon request, to do all things and acts necessary to protect Company's interest by adequately insuring the Deliverables against loss or damage from any cause and to have Company named as an additional insured. Customer will promptly provide Company with a copy of the relevant certificate of insurance upon Company's request.

**11. SHIPPING.**

a. **Freight Charges.** Company will ship all Deliverables in accordance with Company's freight shipment guidelines, which are set forth on the My Allegion Portal ("Freight Shipping Guidelines"), **WHICH TERMS ARE EXPRESSLY INCORPORATED HEREIN.**

b. **Rush Charges.** Expedited order options are available as set forth in Company's Freight Shipping Guidelines.

c. **Packing and Marking.** Company will pack, mark, and ship Deliverables according to its standard procedures for shipment, unless the parties agree, in writing, that Company will comply with any special instructions provided by Customer. Special instructions may result in an increased price.

d. **International Shipments.** For all international orders, a Shipper's letter of instruction must be submitted in writing with the order. Failure to do so will result in the order being rejected. Complete adherence to this order requirement will be strictly enforced. Company will not be held liable for any charges resulting from delays due to lack of complete required information being supplied.

e. Once received by the Company, a purchase order cannot be combined with any other order to increase average order size as it relates to Company's Freight Shipping Guidelines. However, for orders placed under Company's FastTrack 24 Hour/5 Day Program (available for Schlage, Von Duprin, LCN and Glynn-Johnson products); ii) FastTrack 24 Hour/3 Day Program (available for Ives products); or ProExpress (available for specific product lines stated in the ProExpress price book for Falcon, Ives, Glynn Johnson, LCN, Schlage and Von Duprin products), the applicable brands or product categories may, subject to certain order requirements identified by Company, be combined on a single order to increase average order size used in Company's Freight Shipping Guidelines.

**12. CLAIMS.** All claims must be submitted in writing to Company as follows: (i) All claims for prices must be submitted within thirty (30) days from the date of invoice; (ii) All claims regarding Deliverable quantity or incorrect orders must be submitted within ten (10) days from the date of delivery; (iii) All claims for damage to Deliverables (while in the care, custody, and control of Company) must be submitted within thirty (30) days from the date of invoice; (iv) All claims for loss or damage to Deliverables while in the care, custody, and/or control of a carrier will be the responsibility of Customer, unless otherwise agreed by the parties.

**13. PRODUCT CHANGES.** Company's product policy is one of ongoing update and revision, and accordingly, Company reserves the right to change, without notice, the design of, or the process of manufacturing, the Deliverables covered by this Agreement.

**14. PRODUCT USAGE LIMITATION.** Customer agrees: (i) not to sell or use a Deliverable in any manner contrary to the manner in which the Deliverable is intended to be used; and/or (ii) not to modify the design of any Deliverable for use with another product without the prior written consent of Company.

**15. PRODUCT RETURNS.** Unless otherwise agreed by the parties in writing, Deliverables that are correctly furnished by Company per the purchase order may not be returned unless Customer receives written authorization from Company. If returns are authorized by Company, a return merchandise authorization ("RMA") number must be provided by Company. Deliverables identified under such RMA must be returned to Company within 90 days of issuance of the RMA. Such RMA number and any accompanying RMA documents, the original invoice number, and a written explanation for the return must be included with the returned Deliverables in order for Company to inspect and approve a credit for the return. **For warranty returns,** a credit in the amount of the original purchase price will only be issued if, after Company's receipt and inspection of the returned Deliverables, Company confirms, in its sole discretion, the defect is valid and approves the return. **For non-warranty returns/convenience returns,** in the event Company approves such a return, in its sole discretion, the following shall apply: (a) the total amount of Deliverables requested to be returned shall be a minimum of \$250.00; (b) a credit will be made to Customer's account in the amount of the original purchase price less freight and a handling charge of 45% of the net material on the original invoice; and (c) only Deliverables that are new, current, standard, non-obsolete, non-specially manufactured, unused, in their original condition as at the time of sale by Company to Customer, in their original packaging and in Customer's inventory less than 180 days from the date of shipment by the Company, and not ordered as part of a master key solution may be considered by Company for return. Such credit will only be issued if, after Company's receipt and inspection of Deliverables, Company approves the return. The amount of final credit will be determined upon receipt at the factory and following Company's inspection and analysis of the condition of the returned material. Company retains the right to deny credit to anyone for any reason.

**16. CONFIDENTIAL INFORMATION.**

a. **Non-Use And Non-Disclosure.** Customer shall not use the Confidential Information of the Company except for the purpose of performing its obligations under this Agreement or exercising the rights granted herein (the "Purpose"). Customer shall protect Confidential Information of the Company from disclosure and unauthorized use in the same manner that it protects its own Confidential Information, but in no event shall such standard of care be less than reasonable care. Customer may disclose Confidential Information of the Company only to its employees who require such information for the Purpose and who are subject to confidentiality obligations at least as protective as those set forth herein.

b. **Proprietary Information and Advice.** (a) All designs, data, and specifications provided by Company are proprietary and may not be disclosed or reused by Customer without the prior written consent of Company; (b) Company assumes no obligation or liability for any advice given by Company, the results obtained, or damages incurred as a result of such advice, and all such advice is given and accepted at Customer's risk.

c. **Return.** Upon the termination or expiration of a purchase order or this Agreement or upon the request of the Company, the Customer agrees to end all further use of, to immediately return to the Company the original version of, and to delete or destroy all copies of, any and all Confidential Information of the Company.

**17. TRADEMARKS.** Except as agreed to by Company in writing, Customer agrees not to (a) use Company's name in any form of publicity; or (b) use, create, register or market, directly or indirectly, in whole or in part, Company's names, logos, brands, or any other trademarks, or names that are now or may hereafter be owned by Company, as part of Customer's corporate or business name, as part of an internet domain name, uniform resource locator (URL), or in any way connected with Customer's business, trade address or other designations. Upon termination of this Agreement or upon the request of company for any reason, any use of Company's trademarks or names will be immediately discontinued.

**18. LIMITED WARRANTY.**

**COMPANY MAKES NO OTHER WARRANTIES EXCEPT THOSE STATED IN COMPANY'S LIMITED WARRANTY IN EFFECT ON THE DATE COMPANY ACCEPTS EACH APPLICABLE PURCHASE ORDER ("LIMITED WARRANTY"). THE LIMITED WARRANTY MAY BE FOUND IN THE APPLICABLE PRICE BOOK AND ON THE ALLEGION CUSTOMER WEBSITE, WHICH TERMS ARE EXPRESSLY INCORPORATED HEREIN BY REFERENCE. COMPANY WILL MAIL CUSTOMER A HARD COPY OF THIS WARRANTY UPON CUSTOMER'S WRITTEN REQUEST. IN THE EVENT THAT CERTAIN DELIVERABLE WARRANTIES ARE NOT FURNISHED BY THE COMPANY TO CUSTOMER, COMPANY WARRANTS ONLY TO CUSTOMER THAT THE DELIVERABLES WILL BE FREE FROM DEFECTS IN MATERIAL AND WORKMANSHIP FOR A PERIOD OF 12 MONTHS FROM THE DATE OF SHIPMENT OF THE DELIVERABLES. COMPANY'S SOLE OBLIGATION UNDER THIS WARRANTY IS LIMITED TO REPAIRING OR REPLACING, AT COMPANY'S OPTION, THE DEFECTIVE DELIVERABLE, PROVIDED WRITTEN NOTICE OF THE DEFECT OR NONCONFORMANCE IS PROVIDED BY CUSTOMER WITHIN 30 DAYS OF DISCOVERY OF THE DEFECT OR NONCONFORMANCE. COMPANY DISCLAIMS ALL OTHER WARRANTIES, EXPRESS OR IMPLIED, WITH RESPECT TO THE DELIVERABLES, INCLUDING BUT NOT LIMITED TO, ANY IMPLIED WARRANTIES OF NON-INFRINGEMENT, MERCHANTABILITY, OR FITNESS FOR A PARTICULAR PURPOSE.**

a. **Exclusions.** The provisions of this Limited Warranty do not apply to Deliverables that: (A) are not the proper size for the application; (B) are not installed in accordance with Company's published installation instructions; (C) are installed with improper or incorrect parts and/or are used for purposes for which they are not designed or intended; (D) have been repaired or altered without the Company's prior written consent; (E) have been subjected to misuse, abuse, negligence or accident; (F) have been improperly stored, installed, maintained or operated; (G) have been used in violation of written instructions provided by Company to Customer; (H) have been subjected to improper temperature, humidity, or other environmental conditions, or (I) have been affected by normal wear and tear. In addition, the provisions of this Limited Warranty do not apply to any defects or issues with the design or performance of equipment or products not manufactured by Company, nor does it apply to any code compliance or permit requirements for the assembly, installation, erection or construction of any goods. Company is not responsible for loss or damage resulting from use of Deliverables in conjunction with parts or systems not manufactured by Company. Accessories or products furnished by the Company, but manufactured by others, shall carry whatever warranty the manufacturers have conveyed to the Company and which can be passed to Customer.

b. **Services.** Company warrants that its services will be free from defects in material and workmanship for a period of 12 months from the date of completion of the particular items of service. Company's sole obligation under this service warranty is limited to repair or reperformance, at its option of the service, provided however, if repair or reperformance is either impractical or impossible, the Company will refund to Customer that portion of the price paid to Company for any defective service, provided written notice of the defect or nonconformance is provided by Customer within 30 days of discovery of the nonconformance.

c. **Notification.** Customer agrees to immediately notify Company in writing if any claim is made against Customer for any damages caused by any modules, parts, products, service or other Deliverables which may be the direct result of any defect in the manufacture of such aforementioned products. Customer agrees to cooperate with Company and its counsel in the defense of such claim and Customer agrees not to settle such claim without Company's written consent. If Customer fails to notify Company of such claim or fails to cooperate in such defense as aforesaid, then Company shall be discharged from any obligations under this Section and shall have no further liability to Customer.

d. **Exceptions.** The following costs and expenses are not covered by the provisions of these limited warranties: (i) labor costs for the removal and reinstallation of Deliverables or other manufacturer's products; (ii) shipping and freight expenses required to return Deliverables to Company; (iii) normal maintenance; and (iv) economic losses. In addition, the provisions of this warranty are not applicable to anything other than defects in Company's material (products only) or workmanship.

**19. LIMITATION OF REMEDIES.**

**CUSTOMER'S EXCLUSIVE AND SOLE REMEDY ON ACCOUNT OF, OR IN RESPECT OF, THE FURNISHING OF NON-CONFORMING DELIVERABLES, SHALL BE TO (A) SECURE REPAIR OR REPLACEMENT OF THE PRODUCTS; OR (B) SECURE REPAIR OR RE-PERFORMANCE OF THE SERVICES OR TO OBTAIN A REFUND OF THE PRICE PAID FOR THE DEFECTIVE SERVICE, ALL AT COMPANY'S OPTION. IN NO EVENT WILL THE COMPANY'S MAXIMUM LIABILITY EXCEED THE SELLING PRICE FOR THE DELIVERABLE. THE WARRANTY, OBLIGATIONS AND LIABILITIES OF COMPANY (INCLUDING ITS SUPPLIERS) AND THE RIGHTS AND REMEDIES OF CUSTOMER ARE EXCLUSIVE AND ARE IN LIEU OF AND CUSTOMER HEREBY WAIVES AND RELEASES ALL OTHER WARRANTIES, OBLIGATIONS, REPRESENTATIONS OR LIABILITIES EXPRESS OR IMPLIED ARISING BY LAW, IN CONTRACT, TORT (INCLUDING NEGLIGENCE OR STRICT LIABILITY) OR OTHERWISE, INCLUDING BUT NOT LIMITED TO (I) ANY IMPLIED WARRANTY OF MERCHANTABILITY OR FITNESS FOR A PARTICULAR PURPOSE OR ANY WARRANTY IMPLIED THROUGH COURSE OF PERFORMANCE, COURSE OF DEALING, OR USAGE OF TRADE OR (II) CLAIMS ARISING OUT OF THE NEGLIGENCE OF COMPANY OR COMPANY'S SUPPLIERS OR (III) ANY OTHER CLAIM ARISING OUT OF, CONNECTED WITH, OR RESULTING FROM THE PERFORMANCE OF COMPANY OR FROM THE DESIGN, MANUFACTURE, SALE, REPAIR, LEASE OR USE OF THE DELIVERABLE, OR ANY COMPONENT THEREOF, DELIVERED OR RENDERED HEREUNDER OR OTHERWISE.**

**20. INDEMNIFICATION AND LIMITATION OF LIABILITY.** a. Customer shall indemnify, defend and hold Company, and its officers, directors, employees, customers, Affiliates, suppliers, users and agents, (collectively the "Indemnitees") harmless from and against any and all damages, claims, losses, expenses, costs, obligations, liabilities, including without limiting the generality of the foregoing, liabilities for court costs and attorneys' fees, suffered directly or indirectly by an Indemnitee by reason of, or arising out of any injury, death or loss to any person, or injury to any property (collectively, "Damages"), received or sustained by any person(s) or property, arising out of, occasioned by, attributable or related to i) any breach of any representation or warranty made by Customer, its officers, directors, employees, affiliates, users, agents, representatives or customers to Company or any third party, (ii) any failure by



# Terms and Conditions

Customer to perform or fulfill any of its covenants, acts and/or omissions to Company or to any third party, or (iii) any litigation, proceeding or claim by any third party relating in any way to the obligations of Customer and/or the Deliverables sold by Company to Customer hereunder. Customer shall not consummate any settlement of any indemnified claim without the Indemnitees' prior written consent. Customer's obligation to indemnify Indemnitees will continue in full force and effect notwithstanding the termination or expiration of any order under this Agreement. In any claim against an Indemnitee by an employee of Customer or any subcontractor or anyone directly or indirectly employed by any of them or anyone for whose acts they may be liable, the indemnification obligations set forth in this Section shall not be limited in any way by or for Customer or any subcontractor under any applicable worker's compensation act, disability or other employee benefit act, or insurance coverage. This provision shall survive termination of any order or Agreement. **IN NO EVENT WILL COMPANY, ITS OFFICERS, DIRECTORS, EMPLOYEES, CUSTOMERS, AFFILIATES, USERS AND AGENTS, (NOR COMPANY'S SUPPLIERS) BE LIABLE FOR ANY INCIDENTAL, CONSEQUENTIAL, INDIRECT, SPECIAL, OR PUNITIVE DAMAGES OF ANY KIND OR NATURE UNDER ANY CIRCUMSTANCES INCLUDING, BUT NOT LIMITED TO, LOSS OF USE OF THE PRODUCTS, SERVICE INTERRUPTION, LOSS OF PROFITS, LOSS OF REVENUE, LOSS OF INTEREST, LOST GOODWILL, LOSS OF DATA, WORK STOPPAGE, IMPAIRMENT OF OTHER GOODS, LOSS BY REASON OF SHUTDOWN OR NON-OPERATION, INCREASED EXPENSES OF OPERATION, OR CLAIMS OF CUSTOMER'S CUSTOMERS, OR ANY OTHER LOSSES OR DAMAGES ARISING OUT OF ANY LACK OR LOSS OF USE OF THE DELIVERABLES WHETHER BASED ON CONTRACT, WARRANTY, TORT (INCLUDING, BUT NOT LIMITED TO, STRICT LIABILITY OR NEGLIGENCE), PATENT INFRINGEMENT, OR OTHERWISE, EVEN IF ADVISED OF THE POSSIBILITY OF SUCH DAMAGES.**

b) **INTELLECTUAL PROPERTY INDEMNITY.** Company makes no representation or warranty to the Customer that the Deliverables shall not infringe any intellectual property rights including, without limitations, claims arising from patent, copyright, trademark, trade secret, or other intellectual property infringement. Customer agrees to hold Company harmless from and defend the Company against any such claim of intellectual property infringement, including any Damages resulting from that claim, the cost of complying with any preliminary or permanent injunction, and all other costs of defense (including the attorneys' fees and costs), in connection with the foregoing.

c) To the extent that applicable law does not permit any limitations set out in this Agreement, such limitation shall not be applied or invoked. Nothing in this Agreement will be interpreted to disclaim liability of Company or the Indemnitees for gross negligence or willful misconduct. The limitations of remedy and liability herein shall not be interpreted to affect Company's obligations, if any, for claims for (i) property damage, (ii) personal injury, or (iii) wrongful death asserted by persons who are not parties to or beneficiaries of this Agreement. Further, the limitations of remedy and liability herein shall not be interpreted to limit Company's or Customer's right, if permitted by applicable law, to assert a claim for contribution among joint tortfeasors in connection with a claim by a person who is not a party to this Agreement.

**21. CERTIFICATIONS.** Certification of Deliverables for compliance with UL and ANSI standards are tested and performed by third-party independent laboratories. Any field modification or alteration of certified Deliverables will void certification and Company is not liable to Customer to certify any modified or altered Deliverable.

**22. TERM FOR CLAIMS. NO ACTION ARISING OUT OF ANY CLAIMED BREACH OF THIS AGREEMENT BY COMPANY MAY BE BROUGHT BY CUSTOMER MORE THAN ONE (1) YEAR AFTER THE CAUSE OF ACTION HAS ARISEN.**

**23. CONSUMER PRODUCTS WITH RESPECT TO "CONSUMER PRODUCTS" AS DEFINED UNDER THE MAGNUSON-MOSS WARRANTY ACT ("MMWA"), THE FOLLOWING STATEMENTS ARE MADE. (A) SOME STATES OR LOCAL LAWS DO NOT ALLOW LIMITATIONS ON HOW LONG AN IMPLIED WARRANTY LASTS, SO THE ABOVE LIMITATION MAY NOT APPLY TO YOU; (B) IF ANY IMPLIED WARRANTY IS PROVIDED UNDER THE MMWA, IT IS LIMITED TO THE DURATION OF THE WARRANTY PROVIDED IN SECTION 18 ABOVE. (C) SOME STATES OR LOCAL LAWS DO NOT ALLOW THE EXCLUSION OR LIMITATION OF INCIDENTAL OR CONSEQUENTIAL DAMAGES, SO THE ABOVE LIMITATION OR EXCLUSION MAY NOT APPLY TO YOU; AND (D) THIS WARRANTY GIVES YOU SPECIFIC LEGAL RIGHTS AND YOU MAY ALSO HAVE OTHER RIGHTS WHICH VARY FROM STATE TO STATE OR LOCATION TO LOCATION.**

**24. FORCE MAJEURE/EXCUSABLE DELAY.** Any delay or failure of Company to perform its obligations hereunder will be excused to the extent that it is caused by an event or occurrence beyond Company's control such as, by way of example and not by way of limitation, acts of God, acts by any governmental authority (whether valid or invalid), governmental laws and regulations not presently in effect, fires, floods, windstorms, explosions, riots, natural disasters, wars, sabotage, accidents, labor problems (including, without limitation, lockouts, strikes, and slowdowns) at Company's facility, its source plant or their suppliers, inability to obtain power, material, labor equipment, or transportation, or court injunction or order. The delivery date will be extended for a time equal to that of the delay and the schedule for Company's performance will be deemed adjusted to that effect.

**25. ENTIRE AGREEMENT AND AMENDMENT.** This Agreement, together with the attachments, exhibits, webpages, or supplements specifically referenced and incorporated herein, constitute the entire agreement between Company and Customer with respect to the matters contained herein and supersede all previous communications, representations, or agreements, either oral or written between Company and Customer. No agreement or understanding varying or expanding this Agreement will be binding upon either party unless it is in writing and signed by a duly authorized representative of each party hereto.

**26. CONFLICTS.** In the event of any conflict or inconsistency between the terms of any agreement, or any part of an agreement or the various documents (including, but not limited to, electronic documents) between Company and Customer, unless the parties agree otherwise in writing, the various components of the agreements shall be given the following precedence (in descending order of precedence): a) any master agreement or long term agreement between Company and Customer; b) any specific terms, conditions and/or warranties of the individual products or Deliverables; c) the terms and conditions of this Agreement, and d) any purchase order.

**27. UNSATISFACTORY CREDIT/TERMINATION FOR INSOLVENCY OR DEFAULT.** Customer shall furnish Company with statements evidencing Customer's financial condition as Company may, from time to time, reasonably request, and shall notify Company immediately of any and all events that may have a material adverse effect on Customer's business or financial

condition. If Company determines, in its sole discretion, that Customer's financial condition or creditworthiness is inadequate or unsatisfactory, then in addition to Company's other rights, Company may without liability or penalty, take any of the following actions: (i) modify the payment terms for any outstanding and/or future purchases; (ii) cancel any previously accepted orders; (iii) delay any further shipment of Deliverables to Customer; or (iv) any combination of the above.

Company may immediately terminate an order from Customer by giving written notice to Customer in the event of the happening of any of the following or any other comparable event: (i) insolvency of the Customer; (ii) filing of a petition in bankruptcy by or against the Customer; (iii) appointment of a receiver or trustee for the Customer; (iv) execution of an assignment for the benefit of creditors by the Customer, all of which will allow Company to demand reclamation of all affected orders; (v) Customer ceases or threatens to cease to trade; (vi) Company determines that Customer does not meet or no longer meets the credit requirements of Company or Customer's credit account is closed; (vii) any Customer violation of law, specifically including, without limitation, those laws set forth in this Agreement.

In the event of termination in accordance with this section, Company will not be obligated to accept any existing or additional orders from Customer and Company will be released from its obligation to deliver under orders accepted prior to such termination. The rejection or termination of any order by Company will not entitle Customer to any termination or severance compensation, or to any payment in respect to any goodwill established by Customer, or render Company liable for damages on account of the loss of prospective profits, or on account of any loss, expenditure, investment or obligation incurred or made by Customer.

No action taken under this Section 27 by Company (nor any failure of Company to act under this Section 27) will constitute a waiver by Company of any of its rights to enforce Customer's obligations, including the obligation of Customer to make payments as required under this Agreement. Upon termination of any order, all amounts owed by Customer to Company will become immediately due and payable, whether or not otherwise then due or payable.

**28. CREDIT RISK ON RESALE OF DELIVERABLES.** Customer is responsible for all credit risks with respect to, and for collecting payment for, all Deliverables sold to third parties (including End Users, installers, and/or general contractors) whether or not Customer has made full payment to Company for such Deliverables. The inability of Customer to collect payment for any Deliverable shall not affect Customer's obligation to pay Company for any Deliverable.

**29. GOVERNING LAW; VENUE; AND EXPENSES.** Any dispute or claim relating to this Agreement shall be governed by and construed according to the laws of the State of Indiana (excluding its conflict of laws principles); and not by the provisions of the 1980 United Nations Convention on the International Sale of Goods. Any disputes or claims shall be instituted and maintained in the courts of the State of Indiana. Customer consents to the exercise of jurisdiction over it by such courts and agrees that Indiana is not an inconvenient forum for any action arising from or relating to this Agreement. Customer agrees to pay for all expenses (including, but not limited to, collection costs, court costs and attorneys' fees) incurred by Company in enforcing the obligations of Customer under this Agreement.

**30. RELATIONSHIP OF THE PARTIES.** Nothing in this Agreement or any other document creates an employment, partnership, joint venture, or agency relationship between Company and Customer, including that of franchisee/franchisor. No party will have any power or authority to enter into any commitment on behalf of or otherwise bind the other party on any matter. No employee of Customer will be deemed to be an employee of Company. If any provision of this Agreement is deemed to create a franchise relationship or business opportunity between the Parties, then Company may terminate any purchase order or this Agreement or the Parties shall negotiate in good faith to modify this Agreement so as to effect the original intent of the Parties as closely as possible in a mutually acceptable manner in order that the transactions contemplated hereby are consummated as a reseller agreement and not a franchise or business opportunity agreement.

**31. SETOFF.** Customer does not have the right to setoff or to back charge against any amounts which become payable to Company under this Agreement or otherwise. Company will not accept responsibility for backcharges for the cost of material or labor by Customer or any third party.

**32. ELECTRONIC COMMUNICATIONS AND ELECTRONIC SIGNATURES.** Both parties expressly agree to electronic transactions and acknowledge that documents they sign electronically will bind them to the same extent as a paper signature. Customer represents and warrants to Company that only employees authorized to bind Customer legally shall electronically sign any document under this Agreement. Customer shall comply with any method of electronic communication/payment processing specified by Company, including electronic funds transfer, pay-on-receipt processes/systems, order transmission, releases, electronic signature, and electronic communication systems, including, without limitation, the use of electronic data interchange ("EDI") portals. Notwithstanding the foregoing, e-mails, even those containing a signature block of one of Company's representatives, shall not constitute a signed writing.

### **33. COMPLIANCE WITH APPLICABLE LAWS.**

a. **General.** Company and Customer will comply with all applicable federal, state and municipal laws, regulations, codes, ordinances and orders that pertain to the Deliverables, including but not limited to full compliance with any applicable provisions of The Health Insurance Portability and Accountability Act. Where the Customer is located outside the United States, or where the customer intends to ship the product outside the United States, the Customer shall be responsible for compliance with all U.S. export laws, and for filing all U.S. Electronic Export Information, as applicable.

b. The Customer acknowledges and agrees that: (i) it shall not violate applicable laws and regulations in performing its duties under this Agreement; (ii) it does not and shall not engage in any conduct that shall violate any applicable anti-bribery or anti-corruption laws or regulations; (iii) it (and its owners, officers, directors, employees and agents) shall not pay, offer, promise or authorize the payment of, either directly or indirectly, anything of value (including but not limited to cash, gifts and entertainment) to (a) any government official or employee of any government; (b) any official or employee of any department, agency, or instrumentality of a government; (c) any employee of any corporation or entity owned or controlled by a government; (d) any family member of such officials or employees; (e) any political party, party official, or political candidate; or (f) any other persons, owners, officers, directors, employees and agents of any corporation or entity; to improperly or illegally assist in obtaining or retaining business (including but not limited to any contracts, avoidance of duties or reduction of tariffs, reduction of taxes or

to obtain money owed, or to obtain regulatory approval) or for the purpose of causing, soliciting or inducing the sale and purchase of the Deliverables by any party, and (iv) it has full knowledge of and will comply with the Company's Code of Conduct for Business Partners as set forth on the Allegion customer website. **WHICH IS HEREBY INCORPORATED BY REFERENCE.**

c. The Customer shall indemnify and hold the Company harmless from any claim, demand, expense or cost arising from any breach of this Article.

d. The Customer shall permit the Company to conduct an audit or review of the Customer's financial books and records and business operations at such other times that the Company considers it necessary to confirm compliance with this provision. Such audit may be conducted by representatives of the Company or, at the Company's sole discretion, by a certified public accounting firm selected by the Company. The Customer shall cooperate with any inquiries from the Company's Ethics & Compliance Group.

e. A violation of this provision constitutes a material breach of this Agreement and the Company may terminate any purchase order or this Agreement immediately, with no opportunity to cure, in accordance with Section 27 of this Agreement.

f. Notwithstanding the foregoing provisions of this Section 33, (i) Company is not responsible for obtaining or maintaining any permits for the performance of services or the verification or compliance with any code requirements relative to the performance of services, (ii) to the extent any sale of Deliverables pursuant to this Agreement may require approval of the U.S. Government, Company's obligations under this Agreement are conditioned upon the grant of such approval and upon compliance by Customer with any restrictions imposed by the U.S. Government in connection with such approval, and (iii) in the event the Deliverables are to be used in a nuclear facility, the Customer shall, prior to such use, arrange for insurance or governmental indemnity protecting Company against liability. The Customer hereby releases and agrees to indemnify Company and its suppliers for any nuclear damage including, but not limited to, loss of use, in any manner arising out of the nuclear incident, whether alleged to be due, in whole or in part by Company or its suppliers.

g. **No Inducements.** Each party represents to each other that neither it nor any person acting on its behalf has, in contravention of any applicable law, given or offered to give or will give or offer to give, any sum of money or other material consideration to any person, directly or indirectly, as an inducement to obtain business hereunder or to influence the granting of licenses or other governmental permissions to enter into this Agreement or perform obligations hereunder.

h. **Equal Employment Opportunity.** Company is a U.S. federal contractor that complies with Executive Order 11246, as amended, and applicable regulations in 41 CFR Parts 60-1 through 60-60, 29 U.S.C. § 793 and applicable regulations in 41 CFR § 60-741; and 38 U.S.C. § 4212 and applicable regulations in 41 CFR Part 60-250 and 60-300. **THE FOLLOWING PROVISIONS ARE INCORPORATED HEREIN BY REFERENCE:** Executive Order 11246, as amended by Executive Order 13672, and 41 CFR § 60-4.3(a); Executive Order 11701 and 41 CFR §§ 60-250.5(a), 60-300.5; Executive Order 11758 and 41 CFR § 60-741.5(a); U.S. immigration laws, including the L-1 Visa Reform Act of 2004 and the H-1B Visa Reform Act of 2004; and Executive Order 13496.

i. **Ethical Business Conduct.** Customer shall adopt and comply with Company's Business Partner Code of Conduct which is **EXPRESSLY INCORPORATED HEREIN BY REFERENCE.**

**34. REPRESENTATIONS AND WARRANTIES.** Customer represents, warrants and covenants to Company that: (a) it has the right, power, and authority to enter into this Agreement and fully perform its obligations hereunder; (b) it has all necessary rights in and to its respective Content and Marks for use within the scope of this Agreement, including the licenses granted herein; and (c) it complies, and at all times shall comply, with all laws, rules, and regulations in effect that are applicable to its performance under this Agreement, including obtaining all such approvals and/or permits as may be required hereunder.

**35. NO THIRD-PARTY BENEFICIARY.** Each party is entering into this Agreement solely based on the representations contained herein for its own purposes and not for the benefit of any third party.

**36. NOTICES AND CHANGE OF ADDRESS.** All notices or other communications under this Agreement shall be in writing and delivered in person, or sent by receipted courier, express mail, e-mail, or postage prepaid certified or registered mail, addressed to the party for whom it is intended, at the addresses set forth in this Agreement. Either party may change its address for notice by giving written notice to the other party. Any notice or other communication shall be deemed given no later than the date actually received. Notice by courier, express mail, certified mail, or registered mail shall be deemed given on the date it is officially recorded as delivered and, in the absence of such record of delivery, it shall be rebuttably presumed to have been delivered on the third Business Day after it was deposited. Notices sent by e-mail require tangible confirmation of receipt from addressee.

**37. ASSIGNMENT.** Customer may not assign this Agreement without the prior written consent of Company. Company may assign its rights and delegate its duties under this Agreement, without the prior consent of Customer, to an Affiliate, or to a third party in the event of a spin-off, merger, business combination, consolidation or sale of all, or substantially all, of its assets or business that are related to this Agreement. The rights and duties in this Agreement shall bind and inure to the benefit of any such assignee.

**38. SEVERABILITY.** If any provision of this Agreement is held to be invalid, illegal, or unenforceable under any statute, regulation, ordinance, executive order, or other rule of law, that provision will be deemed severed to the extent necessary to comply with such statute, regulation, ordinance, order, or rule. In the event such provision is deemed severed, the parties will negotiate in good faith to arrive at an alternative arrangement approximating the original business objective of the parties. The remaining terms and conditions of this Agreement will remain in effect.

**39. NO IMPLIED WAIVER.** The failure of either party at any time to require performance by the other party of any provision of this Agreement will in no way affect the right to require such performance at any time thereafter, nor will the waiver of either party of a breach of any provision of this Agreement constitute a waiver of any succeeding breach of the same or any other provision.

**40. MISCELLANEOUS.** (a) This Agreement does not make either party the agent or legal representative of the other party. Neither party is authorized to create any obligation on behalf of the other party including, but not limited to, the obligation for payment of any service or warranty obligation hereunder; (b) The rights and remedies herein reserved to Company are cumulative and additional to any other rights and remedies provided at law or equity; (c) The official text of this Agreement is in the English language. If this Agreement is translated into another language, the English text will govern any question with respect to interpretation;

(d) The headings in this Agreement are for convenience of reference only and do not affect the meaning of this Agreement in any manner.

## DEFINITIONS.

Capitalized terms have the meanings set forth in this Section, or in the Section in which they first appear in this Agreement.

**"Agreement"** means these Allegion Terms and Conditions of Sale and Service, together with any applicable Country Supplement or Region Supplement provided by Company, and all of the documents referenced herein or therein.

**"Affiliate"** means any Person that directly or indirectly, through one or more intermediaries, controls, is controlled by, or is under common control with, the Company. The term "control" (including the terms "controlled by" and "under common control with") means the possession, directly or indirectly, of the power to direct or cause the direction of the management and policies of a Person, whether through the ownership of voting securities, by contract or otherwise. **"Business Day"** means any day except Saturday, Sunday or any other day on which commercial banks located in the United States are authorized or required by Law to be closed for business.

**"Company"** means Schlage Lock Company, LLC or any subsidiary or affiliate thereof selling products that are part of the Allegion product portfolio. Schlage Lock Company and/or its subsidiary or affiliates will be severally but not jointly liable under the Agreement.

**"Company Marks"** refers to the Marks of Company.

**"Confidential Information"** shall mean any and all information provided by either party to the other party pertaining to the disclosing party's business. Confidential Information shall include, but not be limited to, any bidding lists, formulae for products, manufacturing processes, production techniques, packaging processes, methods, research materials, ideas, marketing plans and related materials, quality standards, test results and data, apparatus, engineering drawings, contract documents, computer software, hardware, or firmware, business activities information such as financial information, reports, projections, books and records, customer and supplier information, and operations, customer and supplier lists and data, specifications, know how, and other Proprietary Information or Trade Secrets (as defined herein) that either party may furnish to the other party. Confidential Information shall not include information that:

(a) is or becomes publicly known if such public knowledge or disclosure is not the result of any act or failure to act on the part of the receiving party; (b) is, at the time of disclosure, already known to the Receiving Party without utilizing the Confidential Information; (c) is information disclosed to the Receiving Party by a third party which is not to the Receiving Party's knowledge, after inquiry of the third party, under a duty of confidentiality to the Disclosing Party; or (d) is independently developed by the Receiving Party without the use of Confidential Information. The Receiving Party shall have the burden of proof as to prior knowledge and absence of breach. Confidential Information may be furnished in any tangible or intangible form including, but not limited to, writings, drawings, computer and other electronic media, logic diagrams, component specifications, graphs, prototypes, samples, or verbal communications and regardless of whether such information is marked or designated as "confidential." For the avoidance of doubt, all information, knowledge or data disclosed by Company to Customer, regardless of whether disclosed in written, tangible, oral, visual or other form, including, without limitation, sample products, equipment, software, or other objects or material, provided by Company to Customer, and all information, knowledge or data which was obtained by Customer from visits to Company's facilities, shall be considered "Confidential Information" under this Agreement.

**"Content"** means all information (including without limitation any text, music, sound, photographs, video, graphics, data or software), in any medium, on a particular Company Web page or Website or in Marketing Materials.

**"Customer"** means the purchaser of Deliverables from Company.

**"Deliverables"** means any good or service or both purchased by Customer from Company under these General Terms and Conditions of Sale and Service.

**"End Users"** means the purchaser that (a) has acquired a Deliverable from Customer for (i) its own and its Affiliate's/Affiliates' internal use and not for resale, remarketing or distribution or (ii) incorporation into its own products and (b) is an individual or entity, other than any federal, state or local agency, office or division.

**"IP"** means all intellectual property and industrial property rights comprising or relating to/ of the following: (a) Patents; (b) Trademarks; (c) internet domain names, whether or not Trademarks, registered by any authorized private registrar or Governmental Authority, web addresses, web pages, website and URLs; (d) works of authorship, expressions, designs and design registrations, whether or not copyrightable, including copyrights and copyrightable works, software and firmware, application programming interfaces, architecture, files, records, schematics, data, data files, and databases and other specifications and documentation; (e) Trade Secrets; and (f) all other intellectual property and industrial property rights, and all rights, interests and protections that are associated with, equivalent or similar to, or required for the exercise of, any of the foregoing, however arising, in each case whether registered or unregistered and including all registrations and applications for, and renewals or extensions of, such rights or forms of protection pursuant to the Laws of any jurisdiction throughout in any part of the world.

**"Marketing Materials"** means all marketing brochures, buckslips, pamphlets, emails, text, call scripts or other material, whether in printed format, audio or audiovisual format, or in any other format, that contain any (i) Content relating to the Company Deliverables or (ii) Company Marks.

**"Marks"** means collectively the domain names, trademarks, trade names, service marks, trade dress, logos, and the like used or provided by either party for use in connection with this Agreement.

**"Patents"** means all patents (including all reissues, divisionals, provisionals, continuations and continuations-in-part, re-examinations, renewals, substitutions and extensions thereof), patent applications, and other patent rights and any other Governmental Authority-issued indicia of invention ownership (including inventor's certificates, petty patents and patent utility models).

**"Person"** means a person or entity.

**"Price Books"** mean Company's current Price Book in effect for the applicable Deliverable being purchased by Customer.

**"Trade Secrets"** means and includes business or technical information of either party, including processes, formulas, devices, techniques, compilations and other material that a party attempts to maintain in secret and that derive commercial value for such party from not being generally known to the public or readily ascertainable through independent development or reverse engineering.

## How to use this book

---

Products are shown in four groups; Hinges, Continuous Hinges, Pivots and Architectural Hardware. Each group is organized in numerical order and no longer in alpha/numerical. Particularly in the Architectural Hardware group, the products are organized by the part number regardless of the prefix or suffix. Example WS33X Wall Stop will be in numerical sequence of 33; CS115 Crash Stop numerical sequence 115.

For convenience there are a few exceptions where an accessory follows the associated product; example, the COR72 Coordinator is followed by MBI Mounting Bracket.

The service parts section of previous books has been changed. Service parts for many products have been listed with the product. A full list of available service parts may be obtained from the Ives website. You may also contact your local sales representative or Ives customer service for more assistance on the availability of service parts.

Information contained in the list price table:

**Model:** Column contains model family description and general catalog information

**Substrate:** Column contains material substrate information (i.e. aluminum, brass, steel)

**Model Number:** Column contains the model number and additional prefix for other distinguishing features or packaging type. Package type prefix (SP) descriptions are as follows:

**SP** – Slim Pack

**Item Number:** Item number field is UPC number or sku number, where available.

**Weight:** Contains the total weight of product in box quantity. Not all weights shown.

**Order Quantity:** Contains the minimum order quantity for identified product, if required.

**Box Quantity :** Number of items in master carton or special package type.

**Markings Cartons:** Markings (e.g., door locations, stock reference numbers) on individual product cartons will be provided with no charge.

Products available to mark include the following:

Architectural Hinges	Push/Pull Plates
Continuous Hinges	Protection Plates
Pivots	Coordinators
8000 Series Pulls	Flush Bolts
9000 Series Push bars/Pull combinations	Vandal Resistant Trim

**Lead Times:** Stocked products will typically ship within 3-5 days. Made to order products will have a standard lead time of 2-3 weeks, unless otherwise noted. See product pages for specific exceptions. Purchase orders that combine made-to-order and stocked items will be held and shipped together.



# Numerical Index

Part No.	Page	Part No.	Page	Part No.	Page	Part No.	Page	Part No.	Page
<b>hinges</b>									
3PBI	1, 2	DP2	27	COR52	35	FS439	48	VR900	57
3CBI	3, 4	2	27	FB52	36	FS441	48	VR904	57
3CBI HW	5	LG7	27	FB53	36	WS443	48	VR900LLP	57
3CBI WT	6, 7	COR7G	27	054	36	FS444	48	VR904LLP	57
3SPI	7	07	28	059	36	WS445	48	VR910DT	57
5PBI	8	COR9G	28	59	37	FS446	48	VR914DT	57
5PBI	9-10	FS9	28	060	37	WS447	49	VR910NL	57
5BB1 HW	11	LG10	28	60	37	FS448	49	VR914NL	57
5BB1 SC	12	CL11	28	COR60	37	WS449	49	VR910M-DT	57
5BB1 HW SC	12	LG11	28	061	38	FS450	49	VR910M-NL	57
5BB1 WT	13, 14	WS11	28	61	38	FS452	49	919	57
1010	15	WS11X	29	61	38	FS452	49	950	57
1011	15	CL12	29	61	39	SB453	49	955	58
1012	15	LG12	29	FB61	39	SB453	50	960	58
1020	15	FS13	29	FB62	39	FS455	50	962	58
1021	15	LG13	29	63	39	FB457	50	990	58
		CL14	29	64	39	FB458	50	991	58
		LG14	29	SR64	39	RB470	50	RL1152	59
		FS17	29	WS65	39	RB471	50	FS1153/FS1154	59
		R14	29	SR65	39	RB472	50	SB1600M1	59
		AS18	29	SR66	39	481	51	SB1600M2	59
		FS18	29	066	40	482	51	SB1630	60
		FL20	29	66	40	482 s	51	SB1640	60
		WS20	29	69	40	482 s	51	3125	61
		WS20X	30	70	40, 41	482 s	51	31251/31252	61
		CL21/21A	30	71	41	FS495	51	8102HD	65
		CL22	30	72	41	FS496	51	8103HD	65, 66
		22	30	COR72	41	FS497	51	8103EZHD	66
		25	30	73	41	FS544	51	8105	67
		026	30, 31	90	41	FS555	51	8111	67
		RL30	31	CS115	41	506	52	8112	67
		RL30A	31	HB159	41	507	52	8121	68
		FB31	31	218	42	507B	52	8145EZHD	68
		COR32	31	221	42	508	52	8169	68
		COR42	31	222	42	508C	52	8181	69
		COR52	32	223	42	509C	52	8189	69
		COR60	32	227	42	510C	52	8190HD	69
		COR72	32	230	42	510BC	52	8190EZHD	70
		FL20	32	253	43	511BC	52	8200	71
		FL32	32	253	43	543	52	8281	72
		FL44	32	253	43	543B	52	8302	72, 73
		MB1	32	261	43	554	52	8303	74, 75
		MB1F & MB1V	32	262	43	559B	53	8305	75, 76
		MB2	32	262	43	571	53	8312	77
		MB2F & MB2V	32	265	43	572	53	8320	77
		MB3F & MB3V	32	265	43	574	54	8311	77
		FB32	33	299	43, 44	575	54	8371	78
		COR32	33	325	44	580	54	8372	78
		FL32	33	326	44	581	54, 55	8400	79, 80
		RL32	33	327	44	582	55	8700	82
		RL32A	33	330	44	585/586	55	8800	82
		FB33	33	335	44	601	55	8848	82
		WS33	33	336	44	620	55	8975	82
		WS33X	33	345	45	620	56	9100HD	83
		RL36/36A	33	347	45	STK685	56	9103EZHD	83
		RL38	33	349	45	STK685L	56	9145EZHD	84
		40	33, 34	FB358	45	U696	56	9190HD	85
		FS40	34	SB360	45	696-700-701	56	9190EZHD	86
		WS40	34	401/402CVX	45	696-700-701	56	9264	87
		FB41	34	WS404-CVX	46	698	56	9264F	87
		FS41	34	405	46	698	56	9266	87
		42	34	406/407CVX	46	698	56	9266F	87
		COR42	34	406/407CCV	46	700	56		
		FB42	35	FS410	47	701	56		
		FS42	35	411	47	VR810DT	57		
		FS43	35	430	47	VR814DT	57		
		FL44	35	FS434	47	VR810NL	57		
		WS45	35	R435	47	VR814NL	57		
		WS45X	35	FS436	47	VR810NL-V	57		
		S48	35	R437	47	VR814NL-V	57		
		FB51	35	FS438	48	AS895	57		
<b>architectural hardware</b>									
CBI	27								
DP1	27								
LG1	27								

## Key to Finishes

IVES FINISH	ANSI/BHMA	US Number	Finish Description	Base Material
A3	666	US3	Bright Brass, Clear Coat	Aluminum
A4	667	US4	Satin Brass, Clear Coat	Aluminum
A5		US5	Brass, Blackened, Satin Relieved	Aluminum
A10	668	US10	Satin Bronze, Clear Coat	Aluminum
A10B	703	US10B	Dark Bronze, Oil Rubbed	Aluminum
A14	669	US14	Bright Nickel, Clear Coat	Aluminum
A15	670	US15	Satin Nickel, clear Coat	Aluminum
A26	672	US26	Bright Chrome	Aluminum
A26D	702	US26D	Satin Chrome	Aluminum
A-643E/716			Aged Bronze, Blackened, Edge Relieved	Aluminum
A92	673		Aluminum Clear Coat	Aluminum
A-BLK			Matte Black	Aluminum
A-W			White	Aluminum
	627	US27	Satin Aluminum, Clear Coated	Aluminum
	441		Satin Stainless Anodized	Aluminum
PA28	628	US28	Satin Aluminum, Clear Anodized	Aluminum
	688		Satin Brass Anodized	Aluminum
	709		Satin Bronze Anodized	Aluminum
	710	313AN	Dark Bronze Anodized	Aluminum
	711	315AN	Black Anodized	Aluminum
	712		Bright Chrome Anodized	Aluminum
	713		Satin Chrome Anodized	Aluminum
B3	605	US3	Bright Brass, Clear Coat	Brass/Bronze
B4	606	US4	Satin Brass, Clear Coat	Brass/Bronze
B5	609	US5	Satin Brass, Blackened, Satin Relieved	Brass/Bronze
B9	611	US9	Bright Bronze, Clear Coat	Brass/Bronze
B10	612	US10	Satin Bronze, Clear Coat	Brass/Bronze
B10B	613	US10B	Dark Bronze, Oil Rubbed	Brass/Bronze
	614	US10A	Satin Bronze, Relieved, Clear Coated	Brass/Bronze
	616	US11	Satin Bronze, Blackened, Clear Coated	Brass/Bronze
B14	618	US14	Bright Nickel, Clear Coat	Brass/Bronze
B15	619	US15	Satin Nickel, Clear Coat	Brass/Bronze
B15A	620	US15A	Satin Nickel, Blackened, Satin Relieved	Brass/Bronze
B26	625	US26	Bright Chrome	Brass/Bronze
B26D	626	US26D	Satin Chrome	Brass/Bronze
B-643E/716			Aged Bronze, Blackened, Edge Relieved	Brass/Bronze
B-BLK	622		Matte Black	Brass/Bronze
	603	US2G	Zinc Plated	Steel
F2C	604	US2C	Zinc Plated	Steel
F3	632	US3	Bright Brass, Clear Coat	Steel
F4	633	US4	Satin Brass, Clear Coat	Steel
F5	638	US5	Satin Brass, Blackened, Satin Relieved	Steel
F10	639	US10	Satin Bronze, Clear Coat	Steel
F10B	640	US10B	Dark Bronze, Oil Rubbed	Steel
	641	US10A	Oxidized Satin Bronze, Relieved, Clear Coated	Steel
	643	US11	Satin Bronze, Blackened, Relieved, Clear Coated	Steel
F14	645	US14	Bright Nickel, Clear Coat	Steel
F15	646	US15	Satin Nickel, Clear Coated	Steel
F15A	647	US15A	Satin Nickel, Blackened, Relieved, Clear Coated	Steel
F26	651	US26	Bright Chrome	Steel
F26D	652	US26D	Satin Chrome	Steel
F-643E/716			Aged Bronze, Blackened, Edge Relieved	Steel
F-BLK	622		Matte Black	Steel
F-W			White	Steel
SP4			Dull Brass Painted	All
SP10	691		Dull Bronze Painted	All

## Key to Finishes

IVES FINISH	ANSI/BHMA	US Number	Finish Description	Base Material
SP28	689		Aluminum Painted	All
SP313	695		Dark Bronze Painted	All
SPBLK	622		Matte Black	All
USP	600	USP	Primed For Paint	All
US32	629	US32	Bright Stainless Steel	Stainless Steel
US32-316	629-316	US32-316	Bright Stainless Steel - 316 Series	Stainless Steel - 316
US32D	630	US32D	Satin Stainless Steel	Stainless Steel
US32D-316	630-316	US32D-316	Satin Stainless Steel - 316 Series	Stainless Steel - 316
US32D	654		Satin Stainless Steel	Stainless Steel
Z605	677	US3	Bright Brass, Clear Coat	Zinc
	678	US4	Satin Brass, Clear Coat	Zinc
Z609		US5	Satin Brass, Blackened, Satin Relieved	Zinc
Z613	704	US10B	Dark Bronze, Oil Rubbed	Zinc
Z619		US15	Satin Nickel, Clear Coat	Zinc
Z625	681	US26	Bright Chrome	Zinc
	682	US26D	Satin Chrome	Zinc
Z-643E/716			Aged Bronze, Blackened, Edge Relieved	Zinc
Z-BLK	676		Matte Black	Zinc
Z-W			White	Zinc
CLR			Clear	Plastic
BLK			Matte Black	Rubber or Plastic
WHT			White	Rubber or Plastic
GRY			Grey	Rubber
TAN			Tan	Rubber
BRN			Brown	Rubber

### Custom Finishes

Optional powder coat finishes are available on many Ives products. To have a specific color matched and to determine powder coat availability please contact:

**TIGER Drylac U.S.A., Inc.**  
**3945 Swenson Ave**  
**St. Charles, IL 60174**  
**800-243-8148**  
**[www.tiger-coatings.us](http://www.tiger-coatings.us)**

Powder coat must be selected from Tiger Drylac **Series 38 or 49**.

Please specify **both** the full powder coat product number and the RAL number when placing your order.

**Example: 49/15320 RAL 1015**





DESCRIPTION	SIZE	STEEL BASED		BRASS / STAINLESS BASED		US REFERENCE	BOX	CASE	NOTES
		BHMA FINISH	LIST	BHMA FINISH	LIST				
 <p>Three Knuckle Plain Bearing Standard Weight</p> <p>For use on standard weight doors with medium frequency usage</p> <p><b>Available in:</b> Steel w/Steel Pin Brass w/Brass Pin Stainless w/Stainless Pin</p> <p>Non-removable Pin (Steel and Stainless Steel Based 4.5 x 4.5 Hinges add \$4.50 all others add \$9.25 list)</p> <p><b>Packed with:</b> Wood and machine screws</p> <p><b>Available options:</b> SEC - Security Screws HT - Hospital tip RC - Round corners SH - Security Studs See page 14 for pricing</p>	3.5"x3.5" (89x89mm)	600	\$12.60	----	\$ ----	USP	3	24	
		632	18.40	605	64.40	US3	3	24	
		633	13.20	606	53.60	US4	3	24	
		639	14.00	612	50.00	US10	3	24	
		640	18.40	613	64.40	US10B	3	24	
		641	18.40	614	64.40	US10A	3	24	
		643	19.50	616	64.40	US11	3	24	
		F643E/716	19.50	B643E/716	64.40	US11E	3	24	
		646	19.50	619	64.40	US15	3	24	
		651	18.40	625	68.00	US26	3	24	
		652	15.50	626	60.80	US26D	3	24	652 finish Stocked
		F-BLK	14.00	B-BLK	50.00	US19	3	24	
		----	----	629	73.50	US32	3	24	
		----	----	630	70.70	US32D	3	24	
		4"x4" (102x102mm)	600	13.90	----	----	USP	3	24
	632		20.50	605	72.40	US3	3	24	
	633		14.50	606	60.20	US4	3	24	
	639		15.50	612	56.30	US10	3	24	
	640		20.50	613	72.50	US10B	3	24	
	641		20.50	614	72.50	US10A	3	24	
	643		21.50	616	72.50	US11	3	24	
	F643E/716		21.50	B643E/716	64.40	US11E	3	24	
	646		21.50	619	72.50	US15	3	24	
	651		20.50	625	76.40	US26	3	24	
	652		17.30	626	68.40	US26D	3	24	
	F-BLK		15.50	B-BLK	56.30	US19	3	24	
	----		----	629	82.90	US32	3	24	
	----		----	630	79.60	US32D	3	24	
	4.5"x4" (114x102mm)		600	7.50	----	----	USP	3	24
		632	14.70	605	41.80	US3	3	24	
		633	7.50	606	34.90	US4	3	24	
		639	9.10	612	32.50	US10	3	24	
		640	13.30	613	41.80	US10B	3	24	
		641	14.20	614	41.80	US10A	3	24	
		643	14.70	616	41.80	US11	3	24	
		F643E/716	14.70	B643E/716	41.80	US11E	3	24	
		646	14.70	619	41.80	US15	3	24	
		651	14.70	625	44.10	US26	3	24	
		652	11.20	626	39.40	US26D	3	24	652 finish Stocked
		F-BLK	9.10	B-BLK	32.50	US19	3	24	
		----	----	629	47.70	US32	3	24	
		----	----	630	46.40	US32D	3	24	
		4.5"x4.5" (114x114mm)	600	7.50	----	----	USP	3	24
	632		14.70	605	41.80	US3	3	24	
	633		7.50	606	34.90	US4	3	24	
639	9.10		612	32.50	US10	3	24		
640	14.70		613	41.80	US10B	3	24		
641	14.70		614	41.80	US10A	3	24		
643	14.70		616	41.80	US11	3	24		
F643E/716	14.70		B643E/716	41.80	US11E	3	24		
646	14.70		619	41.80	US15	3	24		
651	14.70		625	44.10	US26	3	24		
652	<b>8.50</b>		626	39.40	US26D	3	24		
F-BLK	9.10		B-BLK	32.50	US19	3	24		
----	----		629	47.70	US32	3	24		
----	----		630	46.40	US32D	3	24		

**Note: Specify BHMA finish code when ordering.**

 Indicates products that have EPD documentation available and meet LEED v4.

Contact Ives Customer Service for pricing on additional sizes and finishes

Bold pricing indicates item is in stock and available for **Fast Track** and **ProXpress**

DESCRIPTION	SIZE	STEEL BASED		BRASS / STAINLESS BASED		US REFERENCE	BOX	CASE	NOTES
		BHMA FINISH	LIST	BHMA FINISH	LIST				
 <p>3PB1</p> <p>Three Knuckle Plain Bearing Standard Weight</p> <p>For use on standard weight doors with medium frequency usage</p>	5"x4.5" (127x114mm)	600	\$35.70	----	\$ ----	USP	3	24	
		632	53.50	605	98.00	US3	3	24	
		633	37.90	606	81.50	US4	3	24	
		639	40.00	612	76.00	US10	3	24	
		640	53.50	613	98.00	US10B	3	24	
		641	53.50	614	98.00	US10A	3	24	
		643	55.50	616	98.00	US11	3	24	
		F643E/716	55.50	B643E/716	98.00	US11E	3	24	
		646	55.50	619	98.00	US15	3	24	
		651	53.50	625	103.20	US26	3	24	
		652	44.50	626	92.50	US26D	3	24	
		F-BLK	40.00	B-BLK	76.00	US19	3	24	
		----	----	629	112.00	US32	3	24	
		----	----	630	107.60	US32D	3	24	

**Note: Specify BHMA finish code when ordering.**

 Indicates products that have EPD documentation available and meet LEED v4.

Contact Ives Customer Service for pricing on additional sizes and finishes

Bold pricing indicates item is in stock and available for **Fast Track** and **ProXpress**

DESCRIPTION	SIZE	STEEL BASED		BRASS / STAINLESS BASED		US REFERENCE	BOX	CASE	NOTES
		BHMA FINISH	LIST	BHMA FINISH	LIST				
 <p>Three Knuckle Concealed Bearing Standard Weight</p> <p>For use on standard weight doors with medium frequency usage</p> <p><b>Available in:</b> Steel w/Steel Pin Brass w/Brass Pin Stainless w/Stainless Pin</p> <p>Non-removable Pin (Steel and Stainless Steel Based 4.5 x 4.5 Hinges add \$4.50 all others add \$9.25 list)</p> <p><b>Packed with:</b> Wood and machine screws</p> <p><b>Available options:</b> SEC - Security Screws HT - Hospital tip RC - Round corners SH - Security Studs</p> <p>TW - Electric Thru Wire See page 14 for pricing and available sizes</p>	3.5"x3.5" (89x89mm)	600	\$28.70	----	\$ ----	USP	3	24	
		632	43.70	605	63.10	US3	3	24	
		633	30.90	606	52.40	US4	3	24	
		639	32.80	612	48.90	US10	3	24	
		640	43.70	613	63.10	US10B	3	24	
		641	43.70	614	63.10	US10A	3	24	
		643	45.50	616	63.10	US11	3	24	
		F643E/716	45.50	B643E/716	63.10	US11E	3	24	
		646	45.50	619	63.10	US15	3	24	
		651	43.70	625	66.60	US26	3	24	
		652	36.50	626	59.60	US26D	3	24	
		F-BLK	32.80	B-BLK	48.90	US19	3	24	
		----	----	629	72.20	US32	3	24	
		----	----	630	69.30	US32D	3	24	
		4"x4" (102x102mm)	600	31.10	----	----	USP	3	24
	632		46.90	605	71.10	US3	3	24	
	633		33.10	606	59.10	US4	3	24	
	639		35.20	612	55.30	US10	3	24	
	640		46.90	613	71.10	US10B	3	24	
	641		46.90	614	71.10	US10A	3	24	
	643		48.80	616	71.10	US11	3	24	
	F643E/716		48.80	B643E/716	71.10	US11E	3	24	
	646		48.80	619	71.10	US15	3	24	
	651		46.90	625	75.10	US26	3	24	
	652		39.10	626	67.20	US26D	3	24	
	F-BLK		35.20	B-BLK	55.30	US19	3	24	
	----		----	629	81.40	US32	3	24	
	----		----	630	78.20	US32D	3	24	630 finish Stocked
	4.5"x4" (114x102mm)		600	17.60	----	----	USP	3	24
		632	24.70	605	62.50	US3	3	24	
		633	17.60	606	52.00	US4	3	24	
		639	19.20	612	48.70	US10	3	24	
		640	17.60	613	62.50	US10B	3	24	640 finish Stocked
		641	17.60	614	62.50	US10A	3	24	
		643	24.70	616	62.50	US11	3	24	
		F643E/716	24.70	B643E/716	62.50	US11E	3	24	
		646	27.40	619	62.50	US15	3	24	646 finish Stocked
		651	24.70	625	66.20	US26	3	24	
		652	20.80	626	58.90	US26D	3	24	652 finish Stocked
		F-BLK	19.20	B-BLK	48.70	US19	3	24	
		----	----	629	71.70	US32	3	24	
		----	----	630	63.60	US32D	3	24	
		4.5"x4.5" (114x114mm)	600	11.10	----	----	USP	3	24
	632		24.70	605	69.40	US3	3	24	
	633		17.60	606	52.00	US4	3	24	
639	19.20		612	48.70	US10	3	24	639 finish Stocked	
640	23.40		613	65.50	US10B	3	24	640 finish Stocked	
641	23.40		614	62.50	US10A	3	24	641 finish Stocked	
643	23.40		616	62.50	US11	3	24		
F643E/716	23.40		B643E/716	62.50	US11E	3	24		
646	23.40		619	51.80	US15	3	24		
651	23.40		625	66.20	US26	3	24	651 finish Stocked	
652	13.70		626	55.60	US26D	3	24	652 & 626 finish Stocked	
F-BLK	19.20		B-BLK	48.70	US19	3	24	F-BLK finish Stocked	
----	----		629	71.70	US32	3	24		
----	----		630	64.90	US32D	3	24	630 finish Stocked	

**Note: Specify BHMA finish code when ordering.**

 Indicates products that have EPD documentation available and meet LEED v4.

Contact Ives Customer Service for pricing on additional sizes and finishes

Bold pricing indicates item is in stock and available for **Fast Track** and **ProXpress**

HINGES

CONTINUOUS  
HINGES

PIVOTS

Numerical  
1-059Numerical  
59-437Numerical  
438-1021Numerical  
1152-8190Numerical  
8200-9266

## STEEL BASED

## BRASS / STAINLESS BASED

DESCRIPTION	SIZE	BHMA FINISH	LIST	BHMA FINISH	LIST	US REFERENCE	BOX	CASE	NOTES
 <p><b>3CB1</b></p> <p>Full Mortise Three Knuckle Concealed Bearing Standard Weight</p> <p>For use on standard weight doors with medium frequency usage</p> <p><b>Available in:</b> Steel w/Steel Pin Brass w/Brass Pin Stainless w/Stainless Pin</p> <p>Non-removable Pin (Steel and Stainless Steel Based 4.5 x 4.5 Hinges add \$4.50 all others add \$9.25 list)</p> <p><b>Packed with:</b> Wood and machine screws</p> <p><b>Available options:</b> SEC - Security Screws HT - Hospital tip RC - Round corners SH - Security Studs TW - Electric Thru Wire See page 14 for pricing</p>	5"x4.5" (127x114mm)	600	\$26.40	----	\$ ----	USP	3	24	
		632	39.30	605	77.70	US3	3	24	
		633	27.70	606	64.90	US4	3	24	
		639	29.60	612	60.70	US10	3	24	
		640	39.30	613	77.70	US10B	3	24	
		641	39.30	614	77.70	US10A	3	24	
		643	40.90	616	77.70	US11	3	24	
		F643E/716	40.90	B643E/716	77.70	US11E	3	24	
		646	40.90	619	77.70	US15	3	24	
		651	39.30	625	82.20	US26	3	24	
		652	30.90	626	73.50	US26D	3	24	<b>652 finish Stocked</b>
		F-BLK	29.60	B-BLK	60.70	US19	3	24	
		----	----	629	89.20	US32	3	24	
		----	----	630	79.70	US32D	3	24	<b>630 finish Stocked</b>
	5"x5" (127x127mm)	600	47.00	----	----	USP	3	24	
		632	70.60	605	77.70	US3	3	24	
		633	50.10	606	64.90	US4	3	24	
		639	52.90	612	60.70	US10	3	24	
		640	70.60	613	77.70	US10B	3	24	
		641	70.60	614	77.70	US10A	3	24	
		643	73.50	616	77.70	US11	3	24	
F643E/716		73.50	B643E/716	77.70	US11E	3	24		
646		73.50	619	77.70	US15	3	24		
651		70.60	625	82.20	US26	3	24		
652		58.70	626	73.50	US26D	3	24		
F-BLK		52.90	B-BLK	60.70	US19	3	24		
----		----	629	89.20	US32	3	24		
----		----	630	85.90	US32D	3	24	<b>630 finish Stocked</b>	

**Note: Specify BHMA finish code when ordering.**

 Indicates products that have EPD documentation available and meet LEED v4.

Contact Ives Customer Service for pricing on additional sizes and finishes

Bold pricing indicates item is in stock and available for **Fast Track** and **ProXpress**



DESCRIPTION	SIZE	STEEL BASED		BRASS / STAINLESS BASED		US REFERENCE	BOX	CASE	NOTES
		BHMA FINISH	LIST	BHMA FINISH	LIST				
 <p>Full Mortise Three Knuckle Concealed Bearing Heavy Weight</p> <p>For use on heavy weight doors with medium frequency usage</p> <p><b>Available in:</b> Steel w/Steel Pin Brass w/Brass Pin Stainless w/Stainless Pin</p> <p>Non-removable Pin (Steel and Stainless Steel Based 4.5 x 4.5 Hinges add \$4.50 all others add \$9.25 list)</p> <p><b>Packed with:</b> Wood and machine screws</p> <p><b>Available options:</b> SEC - Security Screws HT - Hospital tip RC - Round corners SH - Security Studs TW - Electric Thru Wire See page 14 for pricing</p>	4.5"x4" (114x102mm)	600	\$45.50	----	\$ ----	USP	3	24	
		632	58.50	605	115.30	US3	3	24	
		633	45.50	606	79.90	US4	3	24	
		639	48.40	612	74.40	US10	3	24	
		640	59.70	613	95.70	US10B	3	24	
		641	59.70	614	95.70	US10A	3	24	
		643	58.50	616	95.70	US11	3	24	
		F643E/716	58.50	B643E/716	95.70	US11E	3	24	
		646	62.10	619	73.90	US15	3	24	
		651	58.50	625	101.00	US26	3	24	
		652	47.00	626	90.60	US26D	3	24	652 finish Stocked
		F-BLK	48.40	B-BLK	74.40	US19	3	24	
		----	----	629	109.80	US32	3	24	
		----	----	630	99.50	US32D	3	24	630 finish Stocked
		4.5"x4.5" (114x114mm)	600	43.00	----	----	USP	3	24
	632		58.50	605	115.30	US3	3	24	
	633		45.50	606	79.90	US4	3	24	
	639		48.40	612	74.40	US10	3	24	
	640		59.70	613	95.70	US10B	3	24	
	641		59.70	614	95.70	US10A	3	24	
	643		58.50	616	95.70	US11	3	24	
	F643E/716		58.50	B643E/716	95.70	US11E	3	24	
	646		55.30	619	73.90	US15	3	24	646 finish Stocked
	651		58.50	625	101.00	US26	3	24	
	652		<b>47.00</b>	626	90.60	US26D	3	24	652 finish Stocked
	F-BLK		48.40	B-BLK	74.40	US19	3	24	
	----		----	629	109.80	US32	3	24	
	----		----	630	99.50	US32D	3	24	
	5"x4.5" (127x114mm)		600	52.60	----	----	USP	3	24
		632	68.90	605	130.30	US3	3	24	
		633	52.60	606	90.90	US4	3	24	
		639	55.60	612	84.90	US10	3	24	
		640	68.90	613	109.30	US10B	3	24	
		641	68.90	614	109.30	US10A	3	24	
		643	68.90	616	109.30	US11	3	24	
		F643E/716	68.90	B643E/716	109.30	US11E	3	24	
		646	71.40	619	87.40	US15	3	24	
		651	68.90	625	115.20	US26	3	24	
		652	<b>54.00</b>	626	103.40	US26D	3	24	652 finish Stocked
		F-BLK	55.60	B-BLK	84.90	US19	3	24	
		----	----	629	124.90	US32	3	24	
		----	----	630	113.40	US32D	3	24	630 finish Stocked
		5"x5" (127x127mm)	600	52.60	----	----	USP	3	24
	632		68.90	605	130.30	US3	3	24	
	633		52.60	606	90.90	US4	3	24	
639	55.60		612	84.90	US10	3	24		
640	68.90		613	109.30	US10B	3	24		
641	68.90		614	109.30	US10A	3	24		
643	68.90		616	109.30	US11	3	24		
F643E/716	68.90		B643E/716	109.30	US11E	3	24		
646	71.40		619	87.40	US15	3	24		
651	68.90		625	115.20	US26	3	24		
652	57.30		626	103.40	US26D	3	24		
F-BLK	55.60		B-BLK	84.90	US19	3	24		
----	----		629	124.90	US32	3	24		
----	----		630	120.20	US32D	3	24	630 finish Stocked	

**Note: Specify BHMA finish code when ordering.**

 Indicates products that have EPD documentation available and meet LEED v4.

Contact Ives Customer Service for pricing on additional sizes and finishes

Bold pricing indicates item is in stock and available for **Fast Track** and **ProXpress**

HINGES  
 CONTINUOUS HINGES  
 PIVOTS  
 Numerical 1-059  
 Numerical 59-437  
 Numerical 438-1021  
 Numerical 1152-8190  
 Numerical 8200-9266

DESCRIPTION	SIZE	STEEL BASED		BRASS / STAINLESS BASED		US REFERENCE	BOX	CASE	NOTES
		BHMA FINISH	LIST	BHMA FINISH	LIST				
<b>3CB1 WT</b>  Three Knuckle Concealed Bearing Wide Throw Standard Weight  For use on standard weight doors with medium frequency usage  <b>Available in:</b> Steel w/Steel Pin  Non-removable Pin (add \$9.25 List)  <b>Packed with:</b> Wood and machine screws  <b>Available options:</b> SEC - Security Screws HT - Hospital tip RC - Round corners SH - Security Studs TW - Electric Thru Wire See page 14 for pricing	4.5"x5" (127x114mm)	600	\$142.00	----	\$ ----	USP	3	24	
		632	212.90	605	----	US3	3	24	
		633	150.70	606	----	US4	3	24	
		639	159.40	612	----	US10	3	24	
		640	212.90	613	----	US10B	3	24	
		641	212.90	614	----	US10A	3	24	
		643	221.90	616	----	US11	3	24	
		F643E/716	221.90	B643E/716	----	US11E	3	24	
		646	221.90	619	----	US15	3	24	
		651	212.90	625	----	US26	3	24	
		652	177.30	626	----	US26D	3	24	
		F-BLK	159.40	B-BLK	----	US19	3	24	
		----	----	629	----	US32	3	24	
		----	----	630	----	US32D	3	24	
		4.5"x6" (114x152mm)	600	150.00	----	----	USP	3	24
	632		225.10	605	----	US3	3	24	
	633		159.20	606	----	US4	3	24	
	639		168.70	612	----	US10	3	24	
	640		225.10	613	----	US10B	3	24	
	641		225.10	614	----	US10A	3	24	
	643		234.60	616	----	US11	3	24	
	F643E/716		234.60	B643E/716	----	US11E	3	24	
	646		234.60	619	----	US15	3	24	
	651		225.10	625	----	US26	3	24	
	652		187.40	626	----	US26D	3	24	
	F-BLK		168.70	B-BLK	----	US19	3	24	
	----		----	629	----	US32	3	24	
	----		----	630	----	US32D	3	24	
	5"x6" (127x152mm)		600	158.30	----	----	USP	3	24
		632	237.20	605	----	US3	3	24	
		633	168.10	606	----	US4	3	24	
		639	177.70	612	----	US10	3	24	
		640	237.20	613	----	US10B	3	24	
		641	237.20	614	----	US10A	3	24	
		643	247.20	616	----	US11	3	24	
		F643E/716	247.20	B643E/716	----	US11E	3	24	
		646	247.20	619	----	US15	3	24	
		651	237.20	625	----	US26	3	24	
		652	197.70	626	----	US26D	3	24	
		F-BLK	177.70	B-BLK	----	US19	3	24	
		----	----	629	----	US32	3	24	
		----	----	630	----	US32D	3	24	
		5"x7" (127x178mm)	600	162.20	----	----	USP	3	24
	632		243.40	605	----	US3	3	24	
	633		172.20	606	----	US4	3	24	
639	182.50		612	----	US10	3	24		
640	243.40		613	----	US10B	3	24		
641	243.40		614	----	US10A	3	24		
643	253.20		616	----	US11	3	24		
F643E/716	253.20		B643E/716	----	US11E	3	24		
646	253.20		619	----	US15	3	24		
651	243.40		625	----	US26	3	24		
652	202.80		626	----	US26D	3	24		
F-BLK	182.50		B-BLK	----	US19	3	24		
----	----		629	----	US32	3	24		
----	----		630	----	US32D	3	24		

**Note: Specify BHMA finish code when ordering.**

Contact Ives Customer Service for pricing on additional sizes and finishes

Bold pricing indicates item is in stock and available for **Fast Track** and **ProXpress**

DESCRIPTION	SIZE	STEEL BASED		BRASS / STAINLESS BASED		US REFERENCE	BOX	CASE	NOTES
		BHMA FINISH	LIST	BHMA FINISH	LIST				
 <p>Three Knuckle Concealed Bearing Wide Throw Standard Weight</p> <p>For use on standard weight doors with medium frequency usage</p>	5"x8" (127x204mm)	600	\$174.10	----	\$ ----	USP	3	24	
		632	261.60	605	----	US3	3	24	
		633	185.40	606	----	US4	3	24	
		639	196.20	612	----	US10	3	24	
		640	261.60	613	----	US10B	3	24	
		641	261.60	614	----	US10A	3	24	
		643	272.30	616	----	US11	3	24	
		F643E/716	272.30	B643E/716	----	US11E	3	24	
		646	272.30	619	----	US15	3	24	
		651	261.60	625	----	US26	3	24	
		652	217.90	626	----	US26D	3	24	
		F-BLK	196.20	B-BLK	----	US19	3	24	
		----	----	629	----	US32	3	24	
		----	----	630	----	US32D	3	24	

DESCRIPTION	SIZE	STEEL BASED		BRASS / STAINLESS BASED		US REFERENCE	BOX	CASE	NOTES	
		BHMA FINISH	LIST	BHMA FINISH	LIST					
 <p>Spring Hinge Standard Weight</p> <p>UL listed for use on fire-rated doors</p> <p><b>Available in:</b> Steel w/ Steel Pin Stainless w/ Stainless Pin</p> <p><b>Packed with:</b> Wood and machine screws</p> <p><b>Available options:</b> SEC - Security Screws RC - Round corners See page 14 for pricing</p>	4"x4" (102x102mm)	600	\$19.90	----	\$	USP	3	24		
		632	28.40	605	----	US3	3	24	632 finish Stocked	
		633	22.80	606	----	US4	3	24	633 finish Stocked	
		639	25.60	612	----	US10	3	24		
		640	32.70	613	----	US10B	3	24	640 finish Stocked	
		641	31.20	614	----	US10A	3	24		
		643	28.40	616	----	US11	3	24		
		F643E/716	28.40	B643E/716	----	US11E	3	24		
		646	28.40	619	----	US15	3	24	646 finish Stocked	
		651	28.40	625	----	US26	3	24		
		652	25.60	626	----	US26D	3	24	652 finish Stocked	
		F-BLK	25.60	B-BLK	----	US19	3	24		
		----	----	629	----	US32	3	24		
		----	----	630	61.80	US32D	3	24	630 finish Stocked	
		4.5"x4" (114x102mm)	600	19.90	----	----	USP	3	24	
			632	28.40	605	----	US3	3	24	632 finish Stocked
			633	22.80	606	----	US4	3	24	
			639	25.60	612	----	US10	3	24	639 finish Stocked
	640		32.70	613	----	US10B	3	24	640 finish Stocked	
	641		31.20	614	----	US10A	3	24		
	643		28.40	616	----	US11	3	24		
	F643E/716		28.40	B643E/716	----	US11E	3	24		
	646		28.40	619	----	US15	3	24		
	651		28.40	625	----	US26	3	24		
	652		25.60	626	----	US26D	3	24	652 finish Stocked	
	F-BLK		25.60	B-BLK	----	US19	3	24		
	----		----	629	----	US32	3	24		
	----		----	630	61.80	US32D	3	24	630 finish Stocked	
	4.5"x4.5" (114x114mm)		600	19.10	----	----	USP	3	24	600 finish Stocked
			632	27.20	605	----	US3	3	24	632 finish Stocked
			633	21.80	606	----	US4	3	24	633 finish Stocked
			639	24.70	612	----	US10	3	24	639 finish Stocked
		640	31.30	613	----	US10B	3	24	640 finish Stocked	
		641	29.90	614	----	US10A	3	24	641 finish Stocked	
		643	27.20	616	----	US11	3	24	643 finish Stocked	
		F643E/716	27.20	B643E/716	----	US11E	3	24	643E finish Stocked	
		646	27.20	619	----	US15	3	24	646 finish Stocked	
		651	27.20	625	----	US26	3	24	651 finish Stocked	
		652	25.60	626	----	US26D	3	24	652 finish Stocked	
		F-BLK	24.70	B-BLK	----	US19	3	24	F-BLK finish Stocked	
	----	----	629	67.60	US32	3	24			
	----	----	630	72.20	US32D	3	24	630 finish Stocked		

**Note: Specify BHMA finish code when ordering.**

**Lead time exception:** Non-stocked Spring hinges and all Spring hinges with RC may take up to 10-12 weeks for shipment except 3SP1 4X4 652 RC-1/4

Contact Ives Customer Service for pricing on additional sizes and finishes

Bold pricing indicates item is in stock and available for **Fast Track** and **ProXpress**

HINGES  
 CONTINUOUS HINGES  
 PIVOTS  
 Numerical 1-059  
 Numerical 59-437  
 Numerical 438-1021  
 Numerical 1152-8190  
 Numerical 8200-9266

DESCRIPTION	SIZE	STEEL BASED		BRASS / STAINLESS BASED		US REFERENCE	BOX	CASE	NOTES
		BHMA FINISH	LIST	BHMA FINISH	LIST				
 <p>Five Knuckle Plain Bearing Standard Weight</p> <p>For use on standard weight doors with low frequency usage</p> <p><b>Available in:</b> Steel w/Steel Pin Brass w/Brass Pin Stainless w/Stainless Pin</p> <p>Non-removable Pin (Steel and Stainless Steel Based 4.5 x 4.5 Hinges add \$4.50 all others add \$9.25 list)</p> <p><b>Packed with:</b> Wood and machine screws</p> <p><b>Available options:</b> SEC - Security Screws HT - Hospital tip RC - Round corners SH - Security Studs See page 14 for pricing</p>	3.5"x3.5" (89x89mm)	600	\$7.20	----	\$ ----	USP	3	24	
		632	10.40	605	27.20	US3	3	24	
		633	7.70	606	22.50	US4	3	24	
		639	10.80	612	21.30	US10	3	24	
		640	10.80	613	27.20	US10B	3	24	
		641	10.80	614	27.20	US10A	3	24	
		643	11.10	616	27.20	US11	3	24	
		F643E/716	11.10	B643E/716	27.20	US11E	3	24	
		646	11.10	619	27.20	US15	3	24	
		651	10.80	625	28.60	US26	3	24	
		652	8.90	626	25.50	US26D	3	24	652 finish Stocked
		F-BLK	10.80	B-BLK	21.30	US19	3	24	
	----	----	629	31.00	US32	3	24		
	----	----	630	29.90	US32D	3	24	630 finish Stocked	
	4"x4" (102x102mm)	600	\$8.20	----	----	USP	3	24	
		632	12.50	605	31.10	US3	3	24	
		633	8.50	606	25.60	US4	3	24	
		639	9.20	612	24.20	US10	3	24	
		640	12.50	613	31.10	US10B	3	24	
		641	12.50	614	31.10	US10A	3	24	
		643	12.90	616	31.10	US11	3	24	
		F643E/716	12.90	B643E/716	31.10	US11E	3	24	
		646	12.90	619	31.10	US15	3	24	
		651	12.50	625	32.80	US26	3	24	
		652	10.30	626	29.30	US26D	3	24	
		F-BLK	9.20	B-BLK	24.20	US19	3	24	
	----	----	629	35.20	US32	3	24		
	----	----	630	34.10	US32D	3	24	630 finish Stocked	
	4.5"x4" (114x102mm)	600	9.00	----	----	USP	3	24	
		632	14.60	605	42.20	US3	3	24	
		633	7.50	606	36.20	US4	3	24	
		639	9.00	612	36.20	US10	3	24	
		640	14.30	613	42.20	US10B	3	24	
		641	14.30	614	39.60	US10A	3	24	
		643	14.60	616	39.60	US11	3	24	
		F643E/716	14.60	B643E/716	39.60	US11E	3	24	
		646	14.60	619	42.20	US15	3	24	
		651	14.60	625	48.50	US26	3	24	
		652	11.90	626	37.40	US26D	3	24	
		F-BLK	9.00	B-BLK	36.20	US19	3	24	
	----	----	629	45.00	US32	3	24		
	----	----	630	42.90	US32D	3	24	630 finish Stocked	
	4.5"x4.5" (114x114mm)	600	5.90	----	----	USP	3	24	600 finish Stocked
		632	14.70	605	42.20	US3	3	24	632 finish Stocked
		633	7.50	606	36.20	US4	3	24	633 finish Stocked
		639	9.00	612	36.20	US10	3	24	
		640	13.30	613	42.20	US10B	3	24	613 finish Stocked
		641	13.30	614	39.60	US10A	3	24	641 finish Stocked
643		14.60	616	39.60	US11	3	24		
F643E/716		14.60	B643E/716	39.60	US11E	3	24		
646		14.70	619	42.20	US15	3	24		
651		14.70	625	48.50	US26	3	24		
652		<b>8.90</b>	626	37.40	US26D	3	24	652 finish Stocked	
F-BLK		9.00	B-BLK	36.20	US19	3	24		
----	----	629	45.00	US32	3	24			
----	----	630	42.90	US32D	3	24			



**Note: Specify BHMA finish code when ordering.**

 Indicates products that have EPD documentation available and meet LEED v4.

Contact Ives Customer Service for pricing on additional sizes and finishes

Bold pricing indicates item is in stock and available for **Fast Track** and **ProXpress**



DESCRIPTION	SIZE	STEEL BASED		BRASS / STAINLESS BASED		US REFERENCE	BOX	CASE	NOTES
		BHMA FINISH	LIST	BHMA FINISH	LIST				
 <p><b>5PB1</b></p> <p>Five Knuckle Plain Bearing Standard Weight</p> <p>For use on standard weight doors with low frequency usage</p>	5"x4.5" (127x114mm)	600	\$13.20	----	\$ ----	USP	3	24	
		632	20.10	605	61.10	US3	3	24	
		633	14.20	606	51.10	US4	3	24	
		639	14.70	612	47.50	US10	3	24	
		640	20.10	613	61.10	US10B	3	24	
		641	20.10	614	61.10	US10A	3	24	
		643	21.00	616	61.10	US11	3	24	
		F643E/716	21.00	B643E/716	61.10	US11E	3	24	
		646	21.00	619	61.10	US15	3	24	
		651	20.10	625	64.70	US26	3	24	
		652	16.90	626	57.90	US26D	3	24	
		F-BLK	14.70	B-BLK	47.50	US19	3	24	
		----	----	629	69.60	US32	3	24	
		----	----	630	66.80	US32D	3	24	630 finish Stocked
 <p><b>5BB1</b></p> <p>Five Knuckle Ball Bearing Standard Weight</p> <p>For use on standard weight doors with medium frequency usage</p> <p><b>Available in:</b> Steel w/Steel Pin Brass w/Brass Pin Stainless w/Stainless Pin</p> <p>Non-removable Pin (Steel and Stainless Steel Based 4.5 x 4.5 Hinges add \$4.50 all others add \$9.25 list)</p> <p><b>Packed with:</b> Wood and machine screws</p> <p><b>Available options:</b> SEC - Security Screws HT - Hospital tip RC - Round corners SH - Security Studs TW - Electric Thru Wire</p> <p>See page 14 for pricing and available sizes</p>	3.5"x3.5" (89x89mm)	600	10.60	----	\$ ----	USP	3	24	
		632	16.10	605	39.00	US3	3	24	
		633	11.50	606	32.50	US4	3	24	
		639	12.20	612	30.40	US10	3	24	
		640	16.10	613	39.00	US10B	3	24	
		641	16.10	614	39.00	US10A	3	24	
		643	16.90	616	39.00	US11	3	24	
		F643E/716	16.90	B643E/716	39.00	US11E	3	24	
		646	16.90	619	39.00	US15	3	24	
		651	16.10	625	41.10	US26	3	24	
		652	12.60	626	36.70	US26D	3	24	652 finish Stocked
		F-BLK	12.20	B-BLK	30.40	US19	3	24	
		----	----	629	44.10	US32	3	24	
		----	----	630	39.80	US32D	3	24	630 finish Stocked
	4"x4" (102x102mm)	600	10.00	----	----	USP	3	24	600 finish Stocked
		632	16.10	605	37.80	US3	3	24	
		633	11.50	606	31.30	US4	3	24	
		639	12.20	612	29.40	US10	3	24	
		640	16.10	613	37.80	US10B	3	24	
		641	16.10	614	37.80	US10A	3	24	
		643	16.90	616	37.80	US11	3	24	
		F643E/716	16.90	B643E/716	37.80	US11E	3	24	
		646	16.90	619	37.80	US15	3	24	
		651	16.10	625	39.90	US26	3	24	
		652	12.60	626	35.70	US26D	3	24	652 finish Stocked
		F-BLK	12.20	B-BLK	29.40	US19	3	24	
		----	----	629	42.80	US32	3	24	
		----	----	630	41.10	US32D	3	24	
	4.5"x4" (114x102mm)	600	14.60	----	----	USP	3	24	
		632	20.90	605	50.10	US3	3	24	
		633	14.60	606	37.80	US4	3	24	
		639	16.60	612	37.80	US10	3	24	
		640	21.30	613	50.10	US10B	3	24	
		641	21.30	614	45.10	US10A	3	24	
643		20.90	616	45.10	US11	3	24		
F643E/716		20.90	B643E/716	45.10	US11E	3	24		
646		22.10	619	50.10	US15	3	24		
651		20.90	625	50.10	US26	3	24		
652		<b>16.90</b>	626	39.90	US26D	3	24	652 & 626 finish Stocked	
F-BLK		16.60	B-BLK	37.80	US19	3	24		
----		----	629	51.00	US32	3	24		
----		----	630	46.10	US32D	3	24		

**Note: Specify BHMA finish code when ordering.**

 Indicates products that have EPD documentation available and meet LEED v4.

Contact Ives Customer Service for pricing on additional sizes and finishes

Bold pricing indicates item is in stock and available for **Fast Track** and **ProXpress**

HINGES  
 CONTINUOUS HINGES  
 PIVOTS  
 Numerical 1-059  
 Numerical 59-437  
 Numerical 438-1021  
 Numerical 1152-8190  
 Numerical 8200-9266

DESCRIPTION	SIZE	STEEL BASED		BRASS / STAINLESS BASED		US REFERENCE	BOX	CASE	NOTES
		BHMA FINISH	LIST	BHMA FINISH	LIST				
 <p>Five Knuckle Ball Bearing Standard Weight</p> <p>For use on standard weight doors with medium frequency usage</p> <p><b>Available in:</b>            Steel w/Steel Pin            Brass w/Brass Pin            Stainless w/Stainless Pin</p> <p>Non-removable Pin (Steel and Stainless Steel Based 4.5 x 4.5 Hinges add \$4.50 all others add \$9.25 list)</p> <p><b>Packed with:</b>            Wood and machine screws</p> <p><b>Available options:</b>            SEC - Security Screws            HT - Hospital tip            RC - Round corners            SH - Security Studs            TW - Electric Thru Wire            See page 14 for pricing</p>	4.5"x4.5" (114x114mm)	600	<b>11.20</b>	----	\$ ----	USP	3	24	600 finish Stocked
		632	<b>19.60</b>	605	47.10	US3	3	24	632 & 605 finish Stocked
		633	<b>12.60</b>	606	35.70	US4	3	24	633 & 606 finish Stocked
		639	<b>15.70</b>	612	35.70	US10	3	24	639 & 612 finish Stocked
		640	<b>19.60</b>	613	<b>47.10</b>	US10B	3	24	640 & 613 finish Stocked
		641	19.60	614	45.10	US10A	3	24	641 finish Stocked
		643	19.60	616	45.10	US11	3	24	643 finish Stocked
		F643E/716	20.10	B643E/716	45.10	US11E	3	24	F643 & B643E finish Stocked
		646	23.80	619	47.10	US15	3	24	646 & 619 finish Stocked
		651	<b>19.60</b>	625	47.10	US26	3	24	651 & 625 finish Stocked
		652	<b>12.60</b>	626	39.90	US26D	3	24	652 & 626 finish Stocked
		F-BLK	16.00	B-BLK	36.40	US19	3	24	FBLK & BBLK finish Stocked
		----	----	629	51.00	US32	3	24	
		----	----	630	<b>46.10</b>	US32D	3	24	630 finish Stocked
		5"x4.5" (127x114mm)	600	22.40	----	----	USP	3	24
	632		33.80	605	57.40	US3	3	24	
	633		24.00	606	47.50	US4	3	24	
	639		25.30	612	44.40	US10	3	24	
	640		33.80	613	57.40	US10B	3	24	
	641		33.80	614	57.40	US10A	3	24	
	643		35.20	616	57.40	US11	3	24	
	F643E/716		35.20	B643E/716	57.40	US11E	3	24	
	646		35.20	619	57.40	US15	3	24	
	651		33.80	625	60.30	US26	3	24	
	652		<b>26.50</b>	626	54.00	US26D	3	24	652 finish Stocked
	F-BLK		25.30	B-BLK	44.40	US19	3	24	
	----		----	629	64.80	US32	3	24	
	----		----	630	58.70	US32D	3	24	630 finish Stocked
	5"x5" (127x127mm)		600	22.80	----	----	USP	3	24
		632	34.40	605	59.30	US3	3	24	
		633	24.20	606	49.20	US4	3	24	
		639	25.50	612	45.90	US10	3	24	
		640	34.40	613	59.30	US10B	3	24	
		641	34.40	614	59.30	US10A	3	24	
		643	35.60	616	59.30	US11	3	24	
		F643E/716	35.60	B643E/716	59.30	US11E	3	24	
646		35.60	619	59.30	US15	3	24		
651		34.40	625	62.40	US26	3	24		
652		28.40	626	55.70	US26D	3	24	652 finish Stocked	
F-BLK		25.50	B-BLK	45.90	US19	3	24		
----		----	629	67.10	US32	3	24		
----		----	630	64.40	US32D	3	24	630 finish Stocked	

**Note: Specify BHMA finish code when ordering.**

 Indicates products that have EPD documentation available and meet LEED v4.

Contact Ives Customer Service for pricing on additional sizes and finishes

Bold pricing indicates item is in stock and available for **Fast Track** and **ProXpress**

DESCRIPTION	SIZE	STEEL BASED		BRASS / STAINLESS BASED		US REFERENCE	BOX	CASE	NOTES
		BHMA FINISH	LIST	BHMA FINISH	LIST				
 <p>Five Knuckle Ball Bearing Heavy Weight</p> <p>For use on heavy weight doors doors with medium frequency usage</p> <p><b>Available in:</b> Steel w/Steel Pin Brass w/Brass Pin Stainless w/Stainless Pin</p> <p>Non-removable Pin (Steel and Stainless Steel Based 4.5 x 4.5 Hinges add \$4.50 all others add \$9.25 list)</p> <p><b>Packed with:</b> Wood and machine screws</p> <p><b>Available options:</b> SEC - Security Screws HT - Hospital tip RC - Round corners SH - Security Studs TW - Electric Thru Wire See page 14 for pricing</p>	4.5"x4" (114x102mm)	600	\$26.20	----	\$ ----	USP	3	24	
		632	39.30	605	74.00	US3	3	24	
		633	27.70	606	61.50	US4	3	24	
		639	29.40	612	57.70	US10	3	24	
		640	39.30	613	74.00	US10B	3	24	
		641	39.30	614	74.00	US10A	3	24	
		643	40.90	616	74.00	US11	3	24	
		F643E/716	40.90	B643E/716	74.00	US11E	3	24	
		646	40.90	619	74.00	US15	3	24	
		651	39.30	625	78.20	US26	3	24	
		652	30.60	626	69.90	US26D	3	24	652 finish Stocked
		F-BLK	29.40	B-BLK	57.70	US19	3	24	
		----	----	629	83.60	US32	3	24	
		----	----	630	75.50	US32D	3	24	
	4.5"x4.5" (114x114mm)	600	33.50	----	----	USP	3	24	
		632	43.40	605	74.00	US3	3	24	
		633	34.90	606	61.50	US4	3	24	633 finish Stocked
		639	36.50	612	57.70	US10	3	24	639 finish Stocked
		640	43.40	613	78.40	US10B	3	24	640 & 613 finish Stocked
		641	43.40	614	74.00	US10A	3	24	641 finish Stocked
		643	43.40	616	74.00	US11	3	24	643 finish Stocked
		F643E/716	44.10	B643E/716	74.00	US11E	3	24	
		646	43.40	619	72.60	US15	3	24	646 & 619 finish Stocked
		651	43.40	625	78.20	US26	3	24	651 & 625 finish Stocked
		652	<b>36.50</b>	626	65.80	US26D	3	24	652 & 626 finish Stocked
		F-BLK	37.30	B-BLK	57.70	US19	3	24	FBLK & BBLK finish Stocked
		----	----	629	83.60	US32	3	24	NRP also in FT and ProX
		----	----	630	<b>75.50</b>	US32D	3	24	630 finish Stocked
5"x4.5" (127x114mm)	600	41.50	----	----	USP	3	24		
	632	59.40	605	86.00	US3	3	24		
	633	43.10	606	71.90	US4	3	24		
	639	42.00	612	66.80	US10	3	24		
	640	50.50	613	86.00	US10B	3	24	640 finish Stocked	
	641	53.70	614	86.00	US10A	3	24		
	643	43.10	616	86.00	US11	3	24		
	F643E/716	43.10	B643E/716	86.00	US11E	3	24		
	646	43.10	619	86.00	US15	3	24		
	651	43.10	625	90.80	US26	3	24		
	652	<b>42.00</b>	626	76.50	US26D	3	24	652 & 626 finish Stocked	
	F-BLK	42.80	B-BLK	66.80	US19	3	24		
	----	----	629	97.50	US32	3	24		
	----	----	630	88.20	US32D	3	24	630 finish Stocked	
5"x5" (127x127mm)	600	42.80	----	----	USP	3	24		
	632	64.10	605	99.70	US3	3	24		
	633	45.50	606	83.00	US4	3	24		
	639	48.30	612	77.50	US10	3	24		
	640	64.10	613	99.70	US10B	3	24		
	641	64.10	614	99.70	US10A	3	24		
	643	67.10	616	99.70	US11	3	24		
	F643E/716	67.10	B643E/716	99.70	US11E	3	24		
	646	67.10	619	99.70	US15	3	24		
	651	64.10	625	105.10	US26	3	24		
	652	51.70	626	94.00	US26D	3	24	652 finish Stocked	
	F-BLK	48.30	B-BLK	77.50	US19	3	24		
	----	----	629	112.80	US32	3	24		
	----	----	630	102.00	US32D	3	24		



**Note: Specify BHMA finish code when ordering.**

 Indicates products that have EPD documentation available and meet LEED v4.

Contact Ives Customer Service for pricing on additional sizes and finishes

Bold pricing indicates item is in stock and available for **Fast Track** and **ProXpress**

HINGES  
 CONTINUOUS HINGES  
 PIVOTS  
 Numerical 1-059  
 Numerical 59-437  
 Numerical 438-1021  
 Numerical 1152-8190  
 Numerical 8200-9266

DESCRIPTION	SIZE	STEEL BASED		BRASS / STAINLESS BASED		US REFERENCE	BOX	CASE	NOTES
		BHMA FINISH	LIST	BHMA FINISH	LIST				
 <p>Five Knuckle Ball Bearing Swing Clear Standard Weight</p> <p>For use on standard weight doors with medium frequency usage</p> <p><b>Available in:</b> Steel w/ Steel Pin Square or Beveled Edge</p> <p>Non-removable Pin (add \$9.25 List)</p> <p><b>Packed with:</b> Wood and machine screws</p> <p><b>Available options:</b> SEC - Security Screws HT - Hospital tip SH - Security Studs TW - Electric Thru Wire See page 14 for pricing</p>	4.5" (114mm)	600	\$71.20	----	\$ ----	USP	3	24	
		632	83.60	605	----	US3	3	24	SC 632 finish Stocked
		633	71.20	606	----	US4	3	24	
		639	74.20	612	----	US10	3	24	
		640	83.60	613	----	US10B	3	24	SC 640 finish Stocked
		641	87.60	614	----	US10A	3	24	
		643	87.10	616	----	US11	3	24	
		F643E/716	87.10	B643E/716	----	US11E	3	24	
		646	87.10	619	----	US15	3	24	SC 646 finish Stocked
		651	83.60	625	----	US26	3	24	
		652	<b>65.80</b>	626	----	US26D	3	24	SC 652 finish Stocked
		F-BLK	74.20	B-BLK	----	US19	3	24	
	----	----	629	----	US32	3	24		
	----	----	630	97.20	US32D	3	24	SC/BSC 630 finish Stocked	
	5" (127mm)	600	71.20	----	----	USP	3	24	
		632	83.60	605	----	US3	3	24	
		633	71.20	606	----	US4	3	24	
		639	74.20	612	----	US10	3	24	
		640	83.60	613	----	US10B	3	24	SC/BSC 640 finish Stocked
		641	87.60	614	----	US10A	3	24	
		643	87.10	616	----	US11	3	24	
		F643E/716	87.10	B643E/716	----	US11E	3	24	
		646	87.10	619	----	US15	3	24	
		651	83.60	625	----	US26	3	24	
652		<b>65.80</b>	626	----	US26D	3	24		
F-BLK		74.20	B-BLK	----	US19	3	24		
----	----	629	----	US32	3	24			
----	----	630	113.30	US32D	3	24	SC 630 finish Stocked		
 <p>Five Knuckle Ball Bearing Swing Clear Heavyweight</p> <p>For use on heavy weight doors with medium frequency usage</p> <p><b>Available in:</b> Steel w/ Steel Pin Square or Beveled Edge</p> <p>Non-removable Pin (add \$9.25 List)</p> <p><b>Packed with:</b> Wood and machine screws</p> <p><b>Available options:</b> SEC - Security Screws HT - Hospital tip SH - Security Studs TW - Electric Thru Wire See page 14 for pricing</p>	4.5" (114mm)	600	81.60	----	----	USP	3	24	
		632	101.50	605	----	US3	3	24	
		633	81.60	606	----	US4	3	24	
		639	90.30	612	----	US10	3	24	SC/BSC 639 finish Stocked
		640	101.50	613	----	US10B	3	24	SC/BSC 640 finish Stocked
		641	101.50	614	----	US10A	3	24	
		643	101.50	616	----	US11	3	24	
		F643E/716	101.50	B643E/716	----	US11E	3	24	
		646	105.90	619	----	US15	3	24	
		651	101.50	625	----	US26	3	24	
		652	79.70	626	----	US26D	3	24	SC/BSC 652 finish Stocked
		F-BLK	90.30	B-BLK	----	US19	3	24	
	----	----	629	----	US32	3	24		
	----	----	630	143.20	US32D	3	24	SC/BSC 630 finish Stocked	
	5" (127mm)	600	81.60	----	----	USP	3	24	
		632	101.50	605	----	US3	3	24	
		633	81.60	606	----	US4	3	24	
		639	90.30	612	----	US10	3	24	SC 639 finish Stocked
		640	101.50	613	----	US10B	3	24	SC 640 finish Stocked
		641	101.50	614	----	US10A	3	24	
		643	101.50	616	----	US11	3	24	
		F643E/716	101.50	B643E/716	----	US11E	3	24	
		646	105.90	619	----	US15	3	24	
		651	101.50	625	----	US26	3	24	
652		79.70	626	----	US26D	3	24	SC/BSC 652 finish Stocked	
F-BLK		90.30	B-BLK	----	US19	3	24		
----	----	629	----	US32	3	24			
----	----	630	171.80	US32D	3	24	SC/BSC 630 finish Stocked		

**Note: Specify BHMA finish code when ordering.**

**Lead time exception:** Non-stocked Swing Clear hinges and all hinges with HT or SH may take up to 10-12 weeks for shipment except 5BB1SC 4.5 652 HT, 5BB1HW-SC 4.5 652 HT, 5BB1HW-SC 5 652 HT, and 5BB1HW-BSC 5 652 HT.

Contact Ives Customer Service for pricing on additional sizes and finishes

Bold pricing indicates item is in stock and available for **Fast Track** and **ProXpress**



DESCRIPTION	SIZE	STEEL BASED		BRASS / STAINLESS BASED		US REFERENCE	BOX	CASE	NOTES
		BHMA FINISH	LIST	BHMA FINISH	LIST				
<b>5BB1 WT</b>  Five Knuckle Ball Bearing Wide Throw Standard Weight For use on standard weight doors with medium frequency usage <b>Available in:</b> Steel w/Steel Pin Non-removable Pin (add \$9.00 List) <b>Packed with:</b> Wood and machine screws <b>Available options:</b> SEC - Security Screws HT - Hospital tip RC - Round corners SH - Security Studs TW - Electric Thru Wire See page 14 for pricing	4.5"x5" (114x127mm)	600	\$17.90	----	\$ ----	USP	3	24	
		632	26.90	605	----	US3	3	24	
		633	18.70	606	----	US4	3	24	
		639	20.10	612	----	US10	3	24	
		640	26.90	613	----	US10B	3	24	
		641	26.90	614	----	US10A	3	24	
		643	27.70	616	----	US11	3	24	
		F643E/716	27.70	B643E/716	----	US11E	3	24	
		646	27.70	619	----	US15	3	24	
		651	26.90	625	----	US26	3	24	
		652	22.10	626	----	US26D	3	24	652 finish Stocked
		F-BLK	20.10	B-BLK	----	US19	3	24	
		----	----	629	----	US32	3	24	
		----	----	630	----	US32D	3	24	
		4.5"x6" (114x152mm)	600	47.50	----	----	USP	3	24
	632		71.20	605	----	US3	3	24	
	633		50.50	606	----	US4	3	24	
	639		53.70	612	----	US10	3	24	
	640		71.20	613	----	US10B	3	24	
	641		71.20	614	----	US10A	3	24	
	643		74.20	616	----	US11	3	24	
	F643E/716		74.20	B643E/716	----	US11E	3	24	
	646		74.20	619	----	US15	3	24	
	651		71.20	625	----	US26	3	24	
	652		55.80	626	----	US26D	3	24	652 finish Stocked
	F-BLK		53.70	B-BLK	----	US19	3	24	
	----		----	629	----	US32	3	24	
	----		----	630	----	US32D	3	24	
	5"x6" (127x152mm)		600	64.10	----	----	USP	3	24
		632	96.00	605	----	US3	3	24	
		633	68.00	606	----	US4	3	24	
		639	72.30	612	----	US10	3	24	
		640	96.00	613	----	US10B	3	24	
		641	96.00	614	----	US10A	3	24	
		643	100.10	616	----	US11	3	24	
		F643E/716	100.10	B643E/716	----	US11E	3	24	
		646	100.10	619	----	US15	3	24	
		651	96.00	625	----	US26	3	24	
		652	80.10	626	----	US26D	3	24	
		F-BLK	72.30	B-BLK	----	US19	3	24	
----		----	629	----	US32	3	24		
----		----	630	----	US32D	3	24		
5"x7" (127x178mm)		600	64.10	----	----	USP	3	24	
	632	96.00	605	----	US3	3	24		
	633	68.00	606	----	US4	3	24		
	639	72.30	612	----	US10	3	24		
	640	96.00	613	----	US10B	3	24		
	641	96.00	614	----	US10A	3	24		
	643	100.10	616	----	US11	3	24		
	F643E/716	100.10	B643E/716	----	US11E	3	24		
	646	100.10	619	----	US15	3	24		
	651	96.00	625	----	US26	3	24		
	652	80.10	626	----	US26D	3	24		
	F-BLK	72.30	B-BLK	----	US19	3	24		
	----	----	629	----	US32	3	24		
	----	----	630	----	US32D	3	24		

**Note: Specify BHMA finish code when ordering.**

Contact Ives Customer Service for pricing on additional sizes and finishes

Bold pricing indicates item is in stock and available for **Fast Track** and **ProXpress**

DESCRIPTION	SIZE	STEEL BASED		BRASS / STAINLESS BASED		US REFERENCE	BOX	CASE	NOTES
		BHMA FINISH	LIST	BHMA FINISH	LIST				
 <p><b>5BB1 WT</b> Five Knuckle Ball Bearing Wide Throw Standard Weight For use on standard weight doors with medium frequency usage</p>	5"x8" (127x206mm)	600	\$64.10	----	\$----	USP	3	24	
		632	96.00	605	----	US3	3	24	
		633	68.00	606	----	US4	3	24	
		639	72.30	612	----	US10	3	24	
		640	96.00	613	----	US10B	3	24	
		641	96.00	614	----	US10A	3	24	
		643	100.10	616	----	US11	3	24	
		F643E/716	100.10	B643E/716	----	US11E	3	24	
		646	100.10	619	----	US15	3	24	
		651	96.00	625	----	US26	3	24	
		652	80.10	626	----	US26D	3	24	
		F-BLK	72.30	B-BLK	----	US19	3	24	
		----	----	629	----	US32	3	24	
		----	----	630	----	US32D	3	24	

**Note: Specify BHMA finish code when ordering.**

<b>BAA 5BB1</b> Five Knuckle Ball Bearing Standard Weight Build in America (BAA) Non-removable Pin (NRP) add \$4.50 List	4.5"x4.5" (114x114mm)	652	\$13.90	626	----	US26D	3	24	
		----	----	630	\$50.60	US32D	3	24	
<b>BAA 5BB1 HW</b> Five Knuckle Ball Bearing Heavy Weight Build in America (BAA) Non-removable Pin (NRP) add \$4.50 List	4.5"x4.5" (114x114mm)	652	\$39.90	626	----	US26D	3	24	
		----	----	630	\$82.50	US32D	3	24	
	5"x4.5" (127x114mm)	652	\$45.80	626	----	US26D	3	24	
		----	----	630	\$96.50	US32D	3	24	
<b>BAA 5BB1 HW BSC</b> Five Knuckle Ball Bearing Heavy Weight Build in America (BAA) Swing Clear - Beveled Edge	4.5" (114mm)	652	\$87.10	626	----	US26D	3	24	

**Additional Options Available for Most Hinges**

HINGE ADDITION/MODIFICATION	SPECIFY	LIST ADD PER HINGE
Non-Removable Pin	NRP	Reference each hinge type
Round Corners (specify 1/4" or 5/8" radius)	RC 1/4" or RC 5/8"	\$6.25
Security Studs (Includes NRP)	SH	8.75
Hospital Tips*	HT	11.25
Security Screws Machine Only	SEC	27.25

\* Hospital Tips and Thru-Wire options include pins that are non-removable. Additional NRP option is not required.

**Electric Thru-Wire Options\***

**Listed under UL 634**

TW4 - 4 Wire Thru Wire  
 TW8 - 8 Wire Thru Wire  
 MON - Monitor  
 TW4M - 4 Wire Thru Wire with Monitor  
 TW8M - 8 Wire Thru Wire with Monitor  
 CON - Allegion Connect  
 All TW4 and TW8 3 knuckle and 5 knuckle hinges are standard with the Allegion Connect 8-pin Connector

- TW and MON not available for 3.5X3.5 hinges, contact technical support.
- MON not available for 4X4 or smaller hinges, contact technical support.
- Not available on 3PB1, 3SP1, or 5PB1 models
- Not available with Security Stud (SH) option
- Packed one hinge per box with machine and wood screws
- Through-wire hinges cycle tested to ensure durability. Ives warranty applies -12 months from date of shipment

MODEL NO.	BOX QTY	STEEL BASED		BRASS / STAINLESS BASED		ALLEGION CONNECT (CON)
		FULL MORTISE	SWING CLEAR	FULL MORTISE	SWING CLEAR	
*MON	1	333.00	-	393.00	-	N/A
TW4	1	319.00	637.00	377.00	747.00	N/C
TW4M	1	608.00	-	730.00	-	N/C
TW8	1	482.00	814.00	574.00	1147.00	N/C
TW8M	1	814.00	-	868.00	-	N/C

For Stocked Electric Thru Wire Hinges, see pricing in the table below. Options above are List Add per Hinge.

 Indicates products that have EPD documentation available and meet LEED v4. *Bold pricing indicates item is in stock and available for Fast Track and ProXpress*

# Stocked Electric Thru-Wire Hinges

The hinges in the table below come standard with Allegion Connect (CON) at no extra charge.

DESCRIPTION	SIZE	TW OPTION	STEEL BASED BHMA FINISH	LIST	BRASS / STAINLESS BASED BHMA FINISH	LIST	US REFERENCE	BOX	CASE
<b>3CB1</b>	4.5X4	TW8 CON	652	\$475.40	626	---	US26D	1	12
			---	---	630	---	US32D	1	12
	4.5X4.5	TW4 CON	652	315.20	626	---	US26D	1	12
			---	---	630	---	US32D	1	12
		TW8 CON	652	468.20	626	---	US26D	1	12
			---	---	630	607.30	US32D	1	12
<b>3CB1 HW</b>	4.5X4.5	TW8 CON	652	502.20	626	---	US26D	1	12
			---	---	630	642.50	US32D	1	12
	5X4.5	TW8 CON	652	536.00	626	---	US26D	1	12
			---	---	630	---	US32D	1	12
<b>5BB1</b>	4.5x4	TW8 CON	652	471.40	626	---	US26D	1	12
			---	---	630	---	US32D	1	12
	4.5x4.5	TW4 CON	652	313.90	626	396.60	US26D	1	12
			---	---	630	402.80	US32D	1	12
		TW8 CON	646	478.60	619	---	US15	1	12
			652	467.20	626	581.80	US26D	1	12
	5x4.5	TW8 CON	---	---	630	588.20	US32D	1	12
			652	481.30	626	---	US26D	1	12
		TW8 CON	---	---	630	---	US32D	1	12
			652	338.40	626	---	US26D	1	12
<b>5BB1 HW</b>	4.5X4.5	TW4 CON	---	---	630	432.80	US32D	1	12
			652	491.50	626	639.50	US26D	1	12
		TW8 CON	---	---	630	617.90	US32D	1	12
			652	344.10	626	---	US26D	1	12
	5X4.5	TW4 CON	---	---	630	---	US32D	1	12
			652	497.20	626	---	US26D	1	12
		TW8 CON	---	---	630	630.90	US32D	1	12
			652	---	---	---	---	---	---

For all other Electric Thru Wire Hinges, see pricing in the table above.

**Lead time exception:** Non-Stocked Electric Thru Wire Hinges may take up to 4-5 weeks for shipment.

## Residential Hinges

MODEL	SUBSTRATE	MODEL NUMBER	BHMA FINISH	WEIGHT	ORDER QTY	BOX QTY	LIST PRICE
<b>1010*</b> Residential Hinge 3.5" Square Corner	Steel	1010 F-619E	646			2	\$8.30
		1010 F-622E	-			2	8.30
		1010 F-625E	651			2	8.30
		1010 F-626E	652			2	8.30
		1010 F-716E	-			2	8.30
<b>1011*</b> Residential Hinge 3.5" 5/8" Radius Corner	Steel	1011F-605E	632			2	8.30
		1011F-619E	646			2	8.30
		1011 F-622E	-			2	8.30
		1011 F-625E	651			2	8.30
		1011 F-626E	652			2	8.30
		1011F-716E	-			2	8.30
<b>1012*</b> Residential Hinge 3.5" 1/4" Radius Corner	Steel	1012 F-619E	646			2	8.30
		1012 F-622E	-			2	8.30
		1012 F-625E	651			2	8.30
		1012 F-626E	652			2	8.30
		1012 F-716E	-			2	8.30
<b>1020*</b> Residential Hinge 4" Square Corner	Steel	1020 F-619E	646			2	9.00
		1020 F-622E	-			2	9.00
		1020 F-625E	651			2	9.00
		1020 F-626E	652			2	9.00
		1020 F-716E	-			2	9.00
<b>1021*</b> Residential Hinge 4" 5/8" Radius Corner	Steel	1021 F-619E	646			2	9.00
		1021 F-622E	-			2	9.00
		1021 F-625E	651			2	9.00
		1021 F-626E	652			2	9.00
		1021 F-716E	-			2	9.00







\*Non rising pin standard. Hinge pin stop not recommended.

Contact Ives Customer Service for pricing on additional sizes and finishes

Bold pricing indicates item is in stock and available for **Fast Track** and **ProXpress**

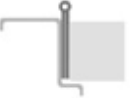
# Continuous Hinges - Pin and Barrel

STEEL BASED

MODEL	DESCRIPTION	FINISH	LENGTH	BHMA FINISH	LIST	NOTES
<b>600</b> UL Listed 	<b>600</b> <b>Concealed Hinge</b> 1/8" Inset Non Handed	USP	83"	600	\$323.80	<b>Stocked</b>
			85"	600	407.10	
			95"	600	395.40	
			120"	600	488.70	<b>Stocked</b>
<b>602</b> UL Listed 	<b>602</b> <b>Full Surface Flush Mount</b> Handed when cut or modified	USP	83"	600	364.10	<b>Stocked</b>
			85"	600	424.80	
			95"	600	424.80	
			120"	600	572.40	
<b>611</b> UL Listed 	<b>611</b> <b>Swing Clear</b> No Inset, Handed when cut or modified Built in Edge Guard	USP	83"	600	571.90	
			85"	600	647.80	
			95"	600	647.80	
			120"	600	751.10	
<b>700</b> UL Listed 	<b>700</b> <b>Concealed Hinge</b> 1/8" Inset Non Handed	US32D	83"	630	<b>573.40</b>	<b>Stocked, including HT and TWP</b>
			85"	630	663.80	<b>Stocked</b>
			95"	630	<b>663.80</b>	<b>Stocked</b>
			120"	630	811.00	<b>Stocked</b>
<b>702</b> UL Listed 	<b>702</b> <b>Full Surface Flush Mount</b> Handed when cut or modified	US32D	83"	630	663.80	<b>Stocked</b>
			85"	630	787.80	
			95"	630	787.80	
			120"	630	1,082.00	<b>Stocked</b>
<b>705</b> UL Listed 	<b>705</b> <b>Concealed Hinge</b> Handed when cut or modified Adjusta-Stud Fasteners	US32D	83"	630	<b>748.20</b>	<b>Stocked, including HT</b>
			85"	630	842.70	
			95"	630	842.70	<b>Stocked</b>
			120"	630	1,029.40	<b>Stocked</b>
<b>711</b> UL Listed 	<b>711</b> <b>Swing Clear Flush Mounted Surface Hinge</b> No Inset, Handed when cut or modified Built in Edge Guard	US32D	83"	630	643.40	<b>Stocked</b>
			85"	630	759.80	
			95"	630	738.00	
			120"	630	925.80	
<b>715</b> UL Listed 	<b>715</b> <b>Concealed Hinge Flush Mounted, Half Wrap</b> Handed when cut or modified Built in Edge Guard	US32D	83"	630	697.80	<b>Stocked, including HT</b>
			85"	630	788.20	<b>Stocked</b>
			95"	630	788.20	<b>Stocked</b>
			120"	630	977.50	

HINGES

CONTINUOUS HINGES

PIVOTS

Numerical 1-059

Numerical 59-437

Numerical 438-1021

Numerical 1152-8190

Numerical 8200-9266

Contact Ives Customer Service for pricing on additional sizes and finishes

Bold pricing indicates item is in stock and available for **Fast Track** and **ProXpress**

## Pin & Barrel Continuous Hinges - Additional Offerings

### Custom Processing\*

Custom cut to length	\$23.00	List add per hinge
Custom painting colors	Contact customer service for pricing and color approval. See Page ix for additional information. Additional lead time up to 6 weeks may be needed. Add pricing below to base pricing for the size needed.	
	\$1,166.00	Flat rate for hinge quantity less than 12 for Tiger/Drylac paint
	\$97.00	List add per hinge for each hinge greater than 12.

Dutch Door Prep	\$143.00	List add per hinge
Hospital Tips	\$143.00	List add per hinge

\* Return Policy - requires prior approval, consult factory

### Electrical Modifications

EPT - Electrical Power Transfer prep 600, 700, 705, and 715	\$124.00	List add per hinge
TW8 - Electric Through-Wire 600, 700, 705, and 715	\$405.00	List add per hinge
CON - Allegion Connect 600, 700, 705, and 715	\$56.00	List add per hinge (Must order with TW8 and add CON List Adder)

### Standard cutout locations. Top Edge of Door to Centerline of cutout.

Consult factory for custom locations. Specify location from top edge of door to centerline of cutout.  
TW8 location cannot be moved.

STD LENGTH	EPT	TW8
83"	30"	43-19/32"
85"	32"	45-17/32"
95"	42"	55-17/32"
120"	67"	80-17/32"

### Optional Mounting Hardware

Standard Mounting Hardware Hollow Metal Self Drilling / Self Tapping Screws (TEK) for Door and Frame 1/2 Wood Screws	\$0.00	No List Add
Security Screws Hollow Metal Door and Frame 1/2 Wood, 1/2 Hollow Metal Wood Door and Frame	\$42.00	List add per hinge Specify SECHM Specify SECWDHM Specify SECWDWD
Wood Screws Wood Door and Frame	\$23.00	List add per hinge Specify WD

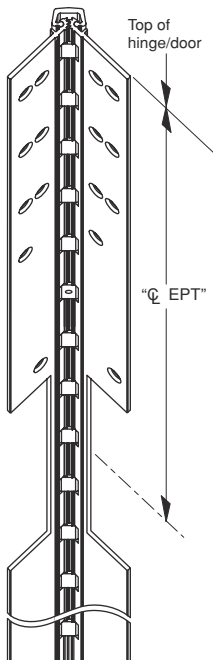

### Ives Continuous Hinge - EPT Order Detail

(EPT's Measure from the top of the hinge to the centerline of the EPT Cutout)

#### Please supply the following information

\_\_\_\_\_ P/O Number

\_\_\_\_\_ Order #



\_\_\_\_\_ Length of Continuous Hinge

\_\_\_\_\_ Indicate RH or LH

\_\_\_\_\_ EPT Location

Note - EPT location is calculated from the TOP of the Hinge to the Centerline of the EPT cutout.



Model	Description	Lengths	List Price - Finishes Listed are for Aluminum Cover, Hinge leaves are Stainless Steel									
			441 (US32DAN)	600 (USP)	628 (US28)	688 (US4AN)	709 (US10AN)	710 (313AN)	711 (315AN)	712 (US26AN)	713 (US26DAN)	
			Satin Stainless Anodized	Primed Paint	Clear Anodized	Satin Brass Anodized	Satin Bronze Anodized	Dark Bronze Anodized	Black Anodized	Buff Chrome Anodized	Satin Chrome Anodized	
 <b>700CS</b>	700CS Stainless Steel Full Mortise Hinge w/ AL Cover	83"	738.80	793.80	662.70	738.80	738.80	690.90	690.90	738.80	738.80	
		85"	841.80	895.30	765.60	841.80	841.80	792.30	792.30	841.80	841.80	
		95"	861.80	915.30	785.70	861.80	861.80	805.80	805.80	861.80	861.80	
		120"	1,122.40	1,177.20	1,046.10	1,122.40	1,122.40	1,072.80	1,072.80	1,122.40	1,122.40	
	<b>Stocked</b>	700CS w/ TWP Stainless Steel Full Mortise Hinge w/ AL Cover, and Thru Wire Panel	83"	1,448.50	1,472.40	1,413.80	1,448.50	1,448.50	1,425.80	1,425.80	1,448.50	1,448.50
			85"	1,448.50	1,472.40	1,413.80	1,448.50	1,448.50	1,425.80	1,425.80	1,448.50	1,448.50
			95"	1,448.50	1,472.40	1,413.80	1,448.50	1,448.50	1,425.80	1,425.80	1,448.50	1,448.50
			120"	1,448.50	1,472.40	1,413.80	1,448.50	1,448.50	1,425.80	1,425.80	1,448.50	1,448.50
 <b>711CS</b>	711CS Stainless Steel Swing Clear Hinge w/ AL Cover	83"	811.00	847.20	760.40	811.00	811.00	779.00	779.00	811.00	811.00	
		85"	836.40	872.50	785.70	836.40	836.40	805.80	805.80	836.40	836.40	
		95"	892.50	928.60	841.80	892.50	892.50	863.10	863.10	892.50	892.50	
		120"	1,049.00	1,085.00	996.70	1,049.00	1,049.00	1,015.50	1,015.50	1,049.00	1,049.00	
 <b>715CS</b>	715CS Stainless Steel Full Mortise Hinge w/ Edge Guard and w/ AL Cover	83"	859.20	920.80	773.60	859.20	859.20	805.80	805.80	859.20	859.20	
		85"	974.10	1,035.60	887.30	974.10	974.10	916.60	916.60	974.10	974.10	
		95"	995.40	1,055.50	908.70	995.40	995.40	939.40	939.40	995.40	995.40	
		120"	1,297.30	1,359.00	1,210.50	1,297.30	1,297.30	1,241.60	1,241.60	1,297.30	1,297.30	

**Lead time exception:** Non-Stocked 711CS and 715CS Pin & Barrel Hinges may take up to 4-5 weeks for shipment.  
Cut to Length, EPT cutouts, and optional mounting hardware of stocked hinges will ship in 2 weeks or less

### CS Series Continuous Hinges - Additional Offering

#### Custom Processing\*

Custom cut to length \$46.00 List add per hinge  
(All lengths = 13" from each end, TWP top only)

Custom painting colors Contact customer service for pricing and color approval. See Page ix for additional information.  
Additional lead time up to 6 weeks may be needed.

Add pricing below to base 628 finish pricing for the size needed.

\$1,166.00 Flat rate for hinge quantity less than 12 for Tiger/Drylac paint

\$97.00 List add per hinge for each hinge greater than 12.

\* Return Policy - requires prior approval, consult factory

Dutch Door Prep N/A List add per hinge

Hospital Tips N/A List add per hinge

#### Electrical Modifications

EPT - Electrical Power Transfer prep \$124.00 List add per hinge  
700CS and 715CS

TW8 - Electric Through-Wire N/A See above chart for hinge price with TWP (Thru Wire Panel)

CON - Allegion Connect \$56.00 List add per hinge (Must order with TW8 and add CON List Adder)  
700CS only

#### Standard cutout locations. Top Edge of Door to Centerline of cutout.

Consult factory for custom locations. Specify location from top edge of door to centerline of cutout.

TWP location cannot be moved.

STD LENGTH	EPT	TWP
83"	30"	43-13/16"
85"	32"	44-29/32"
95"	42"	55-9/32"
120"	67"	79-1/2"

#### Electrical Service Parts

700CS TWP Panel Service Kit \$949.00 List price

#### Optional Mounting Hardware

Standard Mounting Hardware \$0.00 No List Add  
Hollow Metal Self Drilling / Self Tapping Screws (TEK) for Door and Frame

Security Screws \$42.00 List add per hinge  
Hollow Metal Door and Frame Specify SECHM



Wood Screws \$23.00 List add per hinge  
Wood Door and Frame Specify WD

Contact Ives Customer Service for pricing on additional sizes and finishes

Bold pricing indicates item is in stock and available for **Fast Track** and **ProXpress**

# Continuous Geared Hinges

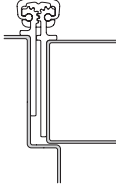
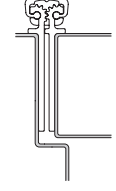
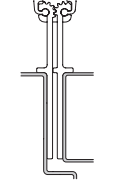
Aluminum Based

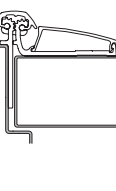
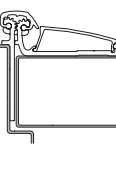
MODEL	DESCRIPTION	FINISH	LENGTH	BHMA FINISH	LIST	NOTES
<b>026XY</b> UL Listed 	<b>026XY Heavy Duty</b> Full Mortise - Narrow Frame Leaf, Wide Door Leaf 3/32" Inset Frame Leaf 1-9/16" Non Handed	US28	83"	628	\$262.20	
			85"	628	262.20	
			95"	628	319.00	
			119"	628	510.30	
		313AN	83"	710	326.00	
			85"	710	326.00	
			95"	710	418.30	
			119"	710	652.00	
		315AN	83"	711	374.90	
			85"	711	374.90	
			95"	711	480.80	
			119"	711	749.70	
<b>027XY</b> UL Listed 	<b>027XY Heavy Duty</b> Full Mortise - Wide Door Leaf Flush mounted, No inset Frame Leaf 1-7/8 " Non Handed	US28	83"	628	269.20	
			85"	628	269.20	
			95"	628	311.90	
			119"	628	503.30	
		313AN	83"	710	354.30	
			85"	710	354.30	
			95"	710	411.10	
			119"	710	645.00	
		315AN	83"	711	407.50	
			85"	711	407.50	
			95"	711	472.70	
			119"	711	741.70	
<b>040XY</b> UL Listed 	<b>040XY Heavy Duty</b> Full Mortise - Wide Throw Flush mounted, No inset Frame Leaf 1-11/16" Non Handed	US28	83"	628	460.70	
			85"	628	460.70	
			95"	628	566.90	
			119"	628	907.00	
		313AN	83"	710	602.40	
			85"	710	602.40	
			95"	710	722.80	
			119"	710	1,162.30	
		315AN	83"	711	692.80	
			85"	711	692.80	
			95"	711	831.20	
			119"	711	1,336.50	
<b>041XY</b> UL Listed 	<b>041XY Heavy Duty</b> Full Mortise - Swing Clear 1/16" inset Frame Leaf 1-7/8" Non Handed	US28	83"	628	510.30	
			85"	628	510.30	
			95"	628	609.30	
			119"	628	935.40	
		313AN	83"	710	673.30	
			85"	710	673.30	
			95"	710	807.80	
			119"	710	1,211.90	
		315AN	83"	711	774.30	
			85"	711	774.30	
			95"	711	929.00	
			119"	711	1,393.60	
<b>045XY</b> UL Listed 	<b>045XY Heavy Duty</b> Adjustable Half Surface 9/32" Inset Frame leaf 1-9/16" Non Handed	US28	83"	628	530.60	
			85"	628	530.60	
			95"	628	647.00	
			119"	628	970.50	
		313AN	83"	710	711.70	
			85"	710	711.70	
			95"	710	873.50	
			119"	710	1,294.10	
		315AN	83"	711	818.40	
			85"	711	818.40	
			95"	711	1,004.60	
			119"	711	1,488.10	
<b>046XY</b> UL Listed 	<b>046XY Heavy Duty</b> Adjustable Half Surface 9/32" Inset Frame leaf 1-7/8" Non Handed	US28	83"	628	569.40	
			85"	628	569.40	
			95"	628	698.90	
			119"	628	1,041.80	
		313AN	83"	710	763.50	
			85"	710	763.50	
			95"	710	931.70	
			119"	710	1,384.60	
		315AN	83"	711	878.00	
			85"	711	878.00	
			95"	711	1,071.50	
			119"	711	1,592.30	





Contact Ives Customer Service for pricing on additional sizes and finishes

Bold pricing indicates item is in stock and available for **Fast Track** and **ProXpress**

HINGES  
 CONTINUOUS HINGES  
 PIVOTS  
 Numerical 1-059  
 Numerical 59-437  
 Numerical 438-1021  
 Numerical 1152-8190  
 Numerical 8200-9266

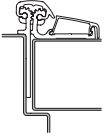
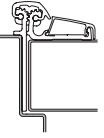
# Continuous Geared Hinges

Aluminum Based

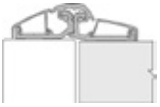

MODEL	DESCRIPTION	FINISH	LENGTH	BHMA FINISH	LIST	NOTES
<b>053XY</b> UL Listed  	<b>053XY Heavy Duty</b> Adjustable Half Surface 1/8" Inset Frame leaf 1-9/16" Non Handed	US28	83"	628	\$386.40	
			85"	628	386.40	
			95"	628	474.50	
			119"	628	732.00	
		313AN	83"	710	481.30	
			85"	710	481.30	
			95"	710	576.20	
			119"	710	976.10	
		315AN	83"	711	553.60	
			85"	711	553.60	
			95"	711	662.60	
			119"	711	1,122.50	
<b>054XY</b> UL Listed  	<b>054XY Heavy Duty</b> Adjustable Half Surface 1/8" Inset Frame leaf 1-7/8" Non Handed	US28	83"	628	413.50	
			85"	628	413.50	
			95"	628	488.00	
			119"	628	766.00	
		313AN	83"	710	494.80	
			85"	710	494.80	
			95"	710	589.80	
			119"	710	982.80	
		315AN	83"	711	569.00	
			85"	711	569.00	
			95"	711	678.30	
			119"	711	1,130.30	
<b>112HD</b> UL Listed  	<b>112HD Heavy Duty</b> Full Mortise No Inset, Non Handed Frame leaf 1-9/16"	US28	83"	628	<b>191.90</b>	<b>Stocked</b>
			85"	628	191.90	<b>Stocked</b>
			95"	628	239.20	<b>Stocked</b>
			120"	628	382.30	<b>Stocked</b>
		313AN	83"	710	247.70	<b>Stocked</b>
			85"	710	260.20	
			95"	710	309.30	<b>Stocked</b>
			120"	710	524.80	
<b>112XY</b> UL Listed  	<b>112XY Heavy Duty</b> Full Mortise - Narrow Frame Leaf, Narrow Door Leaf No Inset, Frame Leaf 1-9/16" Non Handed	US28	83"	628	240.90	<b>Stocked, including TWP</b>
			85"	628	240.90	
			95"	628	304.90	
			119"	628	481.90	
		313AN	83"	710	311.90	
			85"	710	311.90	
			95"	710	389.90	
			119"	710	630.80	
		315AN	83"	711	358.70	
			85"	711	358.70	
			95"	711	448.30	
			119"	711	725.40	
<b>114XY</b> UL Listed  	<b>114XY Heavy Duty</b> Full Mortise - Narrow Frame Leaf, Door Edge Protector 1/16" inset Frame Leaf 1-9/16" Non Handed	US28	83"	628	255.10	
			85"	628	255.10	
			95"	628	311.90	
			119"	628	503.30	
		313AN	83"	710	319.00	
			85"	710	319.00	
			95"	710	411.10	
			119"	710	645.00	
		315AN	83"	711	366.80	
			85"	711	366.80	
			95"	711	472.70	
			119"	711	741.70	
<b>157XY</b> UL Listed  	<b>157XY Heavy Duty</b> Adjustable Full Surface Center Pivot 1/16" Inset Non Handed	US28	83"	628	297.30	<b>Stocked</b>
			95"	628	390.00	
			119"	628	662.80	
		313AN	83"	710	356.40	
			95"	710	467.90	
			119"	710	732.10	
		315AN	83"	711	409.80	
			95"	711	538.20	
			119"	711	842.00	

Contact Ives Customer Service for pricing on additional sizes and finishes

Bold pricing indicates item is in stock and available for **Fast Track** and **ProXpress**

# Continuous Geared Hinges

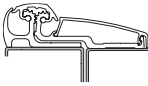
Aluminum Based

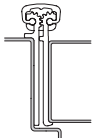
MODEL	DESCRIPTION	FINISH	LENGTH	BHMA FINISH	LIST	NOTES			
<b>210XY</b> UL Listed  	<b>210XY Heavy Duty</b> Adjustable Full Surface Swing Clear 1/32" Inset Non Handed	US28	83"	628	\$352.50				
			85"	628	352.50				
			95"	628	413.50				
			119"	628	718.50				
		313AN	83"	710	413.50				
			85"	710	413.50				
			95"	710	508.40				
			119"	710	786.20				
		315AN	83"	711	475.40				
			85"	711	475.40				
			95"	711	584.60				
			119"	711	904.20				
<b>224HD</b> UL Listed  	<b>224HD Heavy Duty</b> Full Mortise 1/16" Inset Non Handed	US28	83"	628	<b>204.80</b>	<b>Stocked</b>			
			85"	628	204.80	<b>Stocked</b>			
			95"	628	252.10	<b>Stocked</b>			
			120"	628	396.80				
		313AN	83"	710	254.90				
			85"	710	267.70				
			95"	710	339.90				
			120"	710	534.00				
			<b>224XY</b> UL Listed  	<b>224XY Heavy Duty</b> Full Mortise - Door Edge Protector 1/16" inset Frame Leaf 1-7/8" Non Handed (Handed with HT, TWP, EPT)	US28	83"	628	255.10	<b>Stocked, including TWP</b>
						85"	628	255.10	
95"	628	311.90							
119"	628	503.30							
313AN	83"	710			319.00	<b>Stocked</b>			
	85"	710			319.00				
	95"	710			411.10				
	119"	710			645.00				
315AN	83"	711	366.80						
	85"	711	366.80						
	95"	711	472.70						
	119"	711	741.70						

HINGES  
 CONTINUOUS HINGES  
 PIVOTS  
 Numerical 1-059  
 Numerical 59-437  
 Numerical 438-1021  
 Numerical 1152-8190  
 Numerical 8200-9266

Contact Ives Customer Service for pricing on additional sizes and finishes

Bold pricing indicates item is in stock and available for **Fast Track** and **ProXpress**

# Continuous Geared Hinges

## Geared Hinges - Additional Offerings

### Custom Processing\*

Custom cut to length	HD Models	\$23.00	List add per hinge
	XY Models	\$46.00	List add per hinge
Custom painting and anodized colors		Contact customer service for pricing and color approval. See Page ix for additional information. Additional lead time up to 6 weeks may be needed.	
		Add pricing below to base 628 finish pricing for the size needed.	
		\$1,166.00	Flat rate for hinge quantity less than 12 for Tiger/Drylac paint
		\$97.00	List add per hinge for each hinge greater than 12.

\* Return Policy - requires prior approval, consult factory

### Hospital Tip (HT)

HT - Hospital Tip		\$143.00	List add per hinge
<i>026XY, 027XY, 040XY, 112XY, 114XY, 224XY, and 936HD only</i>			
(no additional list add for 936HD)			

### Electrical Modifications

EPT - Electrical Power Transfer prep		\$124.00	List add per hinge
<i>026XY, 027XY, 112HD, 112XY, 114XY, 224HD, and 224XY only</i>			
TWP CON - Electric Through-Wire Panel with Allegion Connect		\$580.00	List add per hinge
<i>026XY, 027XY, 112XY, 114XY, and 224XY only</i>			

### Standard cutout locations. Top Edge of Door to Centerline of cutout.

Consult factory for custom locations. Specify location from top edge of door to centerline of cutout.

STD LENGTH	HD	XY	XY
	EPT	EPT	TWP
83"	30"	30"	43.5"
85"	32"	32"	45.5"
95"	42"	42"	55.5"
119" (XY)	-	66"	79.5"
120" (HD)	67"	-	-

### Electrical Service Parts

XY TWP Panel Service Kit		\$345.00	List price
<i>Same panel for all models (026XY, 027XY, 112XY, 114XY, 224XY)</i>			
<i>Use HGPART.1159 for US28, HGPART.1160 for 313AN</i>			
112HD TWP Panel Service Kit		\$293.00	List price
<i>Use 840737-28 for US28, 840737-42 for 313AN</i>			
224HD TWP Panel Service Kit		\$293.00	List price
<i>Use 840738-28 for US28, 84073842 for 313AN</i>			
112HD/224HD 6' Power Cable Kit for TW8 and TWP		\$414.00	List price
<i>Contains LH &amp; RH cable - 840738-00</i>			

### Optional Mounting Hardware

Standard Mounting Hardware		\$0.00	No List add
Hollow Metal Self Drilling / Self Tapping Screws (TEK) for Door and Frame			
Security Screws - Hex Pin Drive		\$42.00	List add per hinge
Hollow Metal Door and Frame			
1/2 Wood, 1/2 Hollow Metal			
Wood Door and Frame			
Wood Screws		\$23.00	List add per hinge
Wood Door and Frame			
1/2 Self Drill, Self Tap, 1/2 Wood			
Thread Forming Screws		\$23.00	List add per hinge
Hollow Metal Door and Frame			
1/2 Thread Forming, 1/2 Wood			
(Pilot holes required. Recommended for grout filled frame)			

Contact Ives Customer Service for pricing on additional sizes and finishes

Bold pricing indicates item is in stock and available for **Fast Track** and **ProXpress**

HINGES  
CONTINUOUS HINGES  
PIVOTS  
Numerical 1-059  
Numerical 59-437  
Numerical 438-1021  
Numerical 1152-8190  
Numerical 8200-9266

## MOUNTING HARDWARE

<b>Standard Hardware Included - Hollow Metal Door and Frame</b>		
Full Mortise Hinges	12-24 x 3/4" Steel Self Drilling/Self Tapping, Flat Head, Phillips Screw (TEK)	
Half Surface Hinges Includes 210XY	12-24 x 3/4" Steel Self Drilling/Self Tapping, Flat Head, Phillips Screw (TEK) 12-24 x 3/4" Steel Self Drilling/Self Tapping, Hex Head Screw (TEK)	
Full Surface Hinges 157XY Only	12-24 x 3/4" Steel Self Drilling/Self Tapping, Hex Head Screw (TEK)	
<b>Security Screws - Hollow Metal Door and Frame (SECHM)</b>		
Full Mortise Hinges 112HD and 224HD Only	12-24 x 3/4" Stainless Steel, Flat Head, Hex Pin Security Machine Screw	
Available as Accessory Parts Kit for Full Mortise XY Hinges (026XY, 027YX, 040XY, 041XY, 112XY, 112XY, 114XY, 224XY)		
<b>Security Screws - 1/2 Wood, 1/2 Hollow Metal (SECWDHM)</b>		
Full Mortise Hinges 112HD and 224HD Only	12-24 x 3/4" Stainless Steel, Flat Head, Hex Pin Security Machine Screw 12-24 x 3/4" Stainless Steel Socket, Flat Head, Hex Pin Security Wood Screw	
Available as Accessory Parts Kit for Full Mortise XY Hinges (026XY, 027YX, 040XY, 041XY, 112XY, 112XY, 114XY, 224XY)		
<b>Security Screws - Wood Door and Frame (SECWDWD)</b>		
Full Mortise Hinges 112HD and 224HD Only	12 X 1 1/4" Stainless Steel, Flat Head, Hex Pin Security Wood Screw	
Available as Accessory Parts Kit for Full Mortise XY Hinges (026XY, 027XY, 040XY, 041XY, 112XY, 114XY, 224XY)		
<b>Wood Door and Frame (WD)</b>		
Full Mortise Hinges	12 x 1-1/4" Flat Head, Phillips Screw	
Half Surface Hinges Includes 210XY	12 x 1-1/4" Flat Head, Phillips Screw 1/4 x 1-1/2" Hex Head Lag Screw	
Full Surface Hinges 157XY Only	1/4 x 1-1/2" Hex Head Lag Screw	
<b>1/2 Self Drill, Self Tap 1/2 Wood (TEKWD)</b>		
Full Mortise Hinges	12-24 x 3/4" Steel Self Drilling/Self Tapping, Flat Head, Phillips Screw (TEK)	12 x 1-1/4" Flat Head, Phillips Wood Screw
Half Surface Hinges	12-24 x 3/4" Steel Self Drilling/Self Tapping, Flat Head, Phillips Screw (TEK)	1/4 x 1-1/2" Hex Head, Lag Screw
Full Surface Hinges	12-24 x 3/4" Steel Self Drilling/Self Tapping, Hex Head Screw (TEK)	1/4 x 1-1/2" Hex Head, Lag Screw
<b>Thread Forming- Hollow Metal Door and Frame (TF)</b>		
Full Mortise Hinges 112HD and 224HD Only	12-24 x 3/4" Steel Thread Forming, Flat Head, Phillips Wood Screw	
Available as Accessory Parts Kit for Full Mortise XY Hinges (026XY, 027YX, 040XY, 041XY, 112XY, 112XY, 114XY, 224XY)		
<b>Thread Forming - 1/2 Thread Forming Hollow Metal, 1/2 Wood (TFWD)</b>		
Full Mortise Hinges 112HD and 224HD Only	12-24 x 3/4" Steel Thread Forming, Flat Head, Phillips Screw 12 x 1 1/4" Flat Head, Phillips Wood Screw	
Available as Accessory Parts Kit for Full Mortise XY Hinges (026XY, 027XY, 040XY, 041XY, 112XY, 114XY, 224XY)		

Templates and installation instructions available on line at [www.allegion.com/us](http://www.allegion.com/us)

Contact Ives Customer Service for pricing on additional sizes and finishes

Bold pricing indicates item is in stock and available for **Fast Track** and **ProXpress**



# Pivots

	MODEL	PART DESCRIPTION	POUND RATING	BOX QTY	US3	US4	US10	US10B	US15	US26 *US32	US26D *US32D	643e 716	SP28	SPI0	BLK	SP313	SP4
HINGES	<b>7212</b> 3/4" Offset Pivot	7212 SET	200	1	440.30	440.30	440.30	440.30	440.30	440.30	402.10	440.30	255.70	255.70	255.70	255.70	255.70
		7212 TOP	-	1	255.70	255.70	255.70	255.70	255.70	255.70	220.10	255.70	155.90	155.90	155.90	155.90	155.90
		7212 BTM	200	1	268.00	268.00	268.00	268.00	268.00	268.00	229.70	268.00	175.00	175.00	175.00	175.00	175.00
		7212 INT	100	1	294.00	294.00	294.00	294.00	294.00	294.00	255.70	294.00	202.50	202.50	202.50	202.50	202.50
CONTINUOUS HINGES	<b>7212V</b> 3/4" Offset Pivot, Jamb Mount	7212V SET	200	1	458.00	458.00	458.00	458.00	458.00	458.00	421.10	458.00	348.60	348.60	348.60	348.60	348.60
		7212V TOP	-	1	268.00	268.00	268.00	268.00	268.00	268.00	229.70	268.00	175.00	175.00	175.00	175.00	175.00
		7212V INT	100	1	294.00	294.00	294.00	294.00	294.00	294.00	255.70	294.00	202.50	202.50	202.50	202.50	202.50
PIVOTS	<b>7215</b> 3/4" Offset Pivot	7215 SET	500	1	476.00	476.00	476.00	476.00	476.00	476.00	<b>440.30</b>	476.00	384.30	384.30	384.30	384.30	384.30
		7215 TOP	-	1	255.70	255.70	255.70	255.70	255.70	255.70	220.10	255.70	155.90	155.90	155.90	155.90	155.90
		7215 BTM	500	1	294.00	294.00	294.00	294.00	294.00	294.00	274.90	294.00	299.40	299.40	299.40	299.40	299.40
		7215 INT	100	1	268.00	268.00	268.00	268.00	268.00	268.00	<b>238.00</b>	268.00	220.10	220.10	220.10	220.10	220.10
		7215PT(TW4) INT	-	1	958.80	958.80	958.80	958.80	958.80	958.80	744.00	958.80	696.60	696.60	696.60	696.60	696.60
Numerical 1-059	<b>7215F</b> Fire Rated 3/4" Offset Pivot	7215F SET	500	1	750.90	-	750.90	-	-	750.90	712.20	750.90	585.50	585.50	585.50	585.50	585.50
		7215F TOP	-	1	449.90	-	449.90	-	-	449.90	395.10	449.90	329.60	329.60	329.60	329.60	329.60
		7215F BTM	500	1	523.90	-	523.90	-	-	523.90	485.30	523.90	384.30	384.30	384.30	384.30	384.30
		7215F INT	100	1	421.10	-	421.10	-	-	421.10	402.10	421.10	340.50	340.50	340.50	340.50	340.50
Numerical 59-437	<b>7222</b> 3/4" Offset Pivot	7222 SET	200	1	384.30	384.30	384.30	384.30	384.30	384.30	348.60	384.30	255.70	255.70	255.70	255.70	255.70
		7222 TOP	-	1	255.70	255.70	255.70	255.70	255.70	255.70	220.10	255.70	155.90	155.90	155.90	155.90	155.90
		7222 BTM	200	1	249.00	249.00	249.00	249.00	249.00	249.00	211.90	249.00	147.70	147.70	147.70	147.70	147.70
		7222 INT	100	1	294.00	294.00	294.00	294.00	294.00	294.00	255.70	294.00	202.50	202.50	202.50	202.50	202.50
Numerical 438-1021	<b>7226</b> 3/4" Offset Pivot	7226 SET	600	1	458.00	458.00	458.00	458.00	458.00	458.00	<b>421.10</b>	458.00	329.60	329.60	329.60	329.60	329.60
		7226 TOP	-	1	255.70	255.70	255.70	255.70	255.70	255.70	220.10	255.70	155.90	155.90	155.90	155.90	155.90
		7226 BTM	600	1	274.90	274.90	274.90	274.90	274.90	274.90	255.70	274.90	229.70	229.70	229.70	229.70	229.70
		7226 INT	100	1	268.00	268.00	268.00	268.00	268.00	268.00	<b>238.00</b>	268.00	220.10	220.10	220.10	220.10	220.10
		7226PT(TW4) INT	-	1	958.80	958.80	958.80	958.80	958.80	958.80	744.00	958.80	696.60	696.60	696.60	696.60	696.60

**Lead time exception:** The following Pivots are stocked.

7212 Set, US26D, 7215 Set US26D, 7222 Set US26D, 7226 Set US26D, 7212-7212V-7222 INT US26D, 7215-7226-7227 INT US26D, 7215-7226-7227 PT INT US26D

Non-Stocked PT INT pivots may take up to 4-5 weeks for shipment.

# Pivots

MODEL	PART DESCRIPTION	POUND RATING	BOX QTY	US3	US4	US10	US10B	US15	US26 *US32	US26D *US32D	643e 716	SP28	SP10	BLK	SP313	SP4
<b>7226F</b> Fire Rated 3/4" Offset Pivot	7226F SET	600	1	659.20	-	659.20	-	-	659.20	623.60	659.20	530.70	530.70	530.70	530.70	530.70
	7226F TOP	-	1	449.90	-	449.90	-	-	449.90	395.10	449.90	329.60	329.60	329.60	329.60	329.60
	7226F BTM	600	1	467.70	-	467.70	-	-	467.70	402.10	467.70	377.50	377.50	377.50	377.50	377.50
	7226F INT	600	1	421.10	-	421.10	-	-	421.10	402.10	421.10	340.50	340.50	340.50	340.50	340.50
<b>7227</b> 3/4" Offset Pivot	7227 SET	700	1	769.80	769.80	769.80	769.80	769.80	769.80	733.20	769.80	641.30	641.30	641.30	641.30	641.30
	7227 TOP	-	1	255.70	255.70	255.70	255.70	255.70	255.70	220.10	255.70	155.90	155.90	155.90	155.90	155.90
	7227 BTM	700	1	696.00	696.00	696.00	696.00	696.00	696.00	623.60	696.00	577.20	577.20	577.20	577.20	577.20
	7227 INT	100	1	268.00	268.00	268.00	268.00	268.00	268.00	<b>238.00</b>	268.00	220.10	220.10	220.10	220.10	220.10
	7227PT(TW4) INT	-	1	958.80	958.80	958.80	958.80	958.80	958.80	744.00	958.80	696.60	696.60	696.60	696.60	696.60
<b>7227F</b> Fire Rated 3/4" Offset Pivot	7227F SET	700	1	969.50	-	969.50	-	-	969.50	932.80	969.50	823.30	823.30	823.30	823.30	823.30
	7227F TOP	-	1	449.90	-	449.90	-	-	449.90	395.10	449.90	329.60	329.60	329.60	329.60	329.60
	7227F BTM	700	1	696.00	-	696.00	-	-	696.00	623.60	696.00	577.20	577.20	577.20	577.20	577.20
	7227F INT	100	1	421.10	-	421.10	-	-	421.10	402.10	421.10	340.50	340.50	340.50	340.50	340.50
<b>7230F</b> Fire Rated 3/4" Offset Pivot	7230F SET	1000	1	823.30	-	823.30	-	-	823.30	<b>786.20</b>	823.30	696.00	696.00	696.00	696.00	696.00
	7230F TOP	-	1	421.10	-	421.10	-	-	421.10	395.10	421.10	340.50	340.50	340.50	340.50	340.50
	7230F BTM	1000	1	504.40	-	504.40	-	-	504.40	485.30	504.40	430.80	430.80	430.80	430.80	430.80
	7230F INT	100	1	458.00	-	458.00	-	-	458.00	<b>440.30</b>	458.00	377.50	377.50	377.50	377.50	377.50
<b>7237F</b> Fire Rated 3/4" Offset	7237F SET	1750	1	1,006.40	-	1,006.40	-	-	1,006.40	969.50	1,006.40	879.40	879.40	879.40	879.40	879.40
	7237F TOP	-	1	421.10	-	421.10	-	-	421.10	395.10	421.10	340.50	340.50	340.50	340.50	340.50
	7237F BTM	1750	1	696.00	-	696.00	-	-	696.00	676.90	696.00	631.90	631.90	631.90	631.90	631.90
	7237F INT	100	1	458.00	-	458.00	-	-	458.00	<b>440.30</b>	458.00	377.50	377.50	377.50	377.50	377.50
<b>7244F</b> Fire Rated 1-1/2" Offset Pivot	7244F SET	400	1	852.00	-	852.00	-	-	852.00	823.30	852.00	712.20	712.20	712.20	712.20	712.20
	7244F TOP	-	1	458.00	-	458.00	-	-	458.00	430.80	458.00	395.10	395.10	395.10	395.10	395.10
	7244F BTM	400	1	495.00	-	495.00	-	-	495.00	467.70	495.00	402.10	402.10	402.10	402.10	402.10
	7244F INT	100	1	495.00	-	495.00	-	-	495.00	467.70	495.00	412.90	412.90	412.90	412.90	412.90

**Lead time exception:** The following Pivots are stocked.

7230F Set US32D, 7230F-7237F INT US32D, 7215-7226-7227 PT INT US26D

Non-Stocked PT INT pivots may take up to 4-5 weeks for shipment.

HINGES  
 CONTINUOUS HINGES  
 PIVOTS  
 Numerical 1-059  
 Numerical 59-437  
 Numerical 438-1021  
 Numerical 1152-8190  
 Numerical 8200-9266

# Pivots

MODEL	PART DESCRIPTION	POUND RATING	BOX QTY	US3	US4	US10	US15	US10B	US26 *US32	US26D *US32D	643e 716	SP28	SP10	BLK	SP313	SP4	USP
<b>7245F</b> Fire Rated 1-1/2" Offset Pivot	7245FSET	500	1	1,098.10	-	1,098.10	-	-	1,098.10	1,061.30	1,098.10	969.50	969.50	969.50	969.50	969.50	-
	7245F TOP	-	1	458.00	-	458.00	-	-	458.00	430.80	458.00	395.10	395.10	395.10	395.10	395.10	-
	7245F BTM	500	1	769.80	-	769.80	-	-	769.80	750.90	769.80	676.90	676.90	676.90	676.90	676.90	-
	7245FINT	100	1	495.00	-	495.00	-	-	495.00	467.70	495.00	412.90	412.90	412.90	412.90	412.90	-
<b>7253</b> 1-1/2" Pivot Center Hung	7253SET	300	1	348.60	348.60	348.60	348.60	348.60	348.60	348.60	348.60	303.50	303.50	303.50	303.50	303.50	-
	7253 TOP	-	1	211.90	211.90	211.90	211.90	211.90	211.90	211.90	211.90	192.90	192.90	192.90	192.90	192.90	-
	7253 BTM	300	1	192.90	192.90	192.90	192.90	192.90	192.90	166.80	192.90	139.60	139.60	139.60	139.60	139.60	-
<b>7255</b> 1-1/2" Pivot Center Hung	7255SET	500	1	384.30	384.30	384.30	384.30	384.30	384.30	384.30	384.30	358.30	358.30	358.30	358.30	358.30	-
	7255 TOP	-	1	211.90	211.90	211.90	211.90	211.90	211.90	211.90	211.90	192.90	192.90	192.90	192.90	192.90	-
	7255 BTM	500	1	220.10	220.10	220.10	220.10	220.10	220.10	220.10	220.10	211.90	211.90	211.90	211.90	211.90	-
<b>7255J</b> 1-1/2" Pivot Center Hung	7255JSET	600	1	384.30	384.30	384.30	384.30	384.30	384.30	384.30	384.30	358.30	358.30	358.30	358.30	358.30	-
	7255J TOP	-	1	211.90	211.90	211.90	211.90	211.90	211.90	211.90	211.90	192.90	192.90	192.90	192.90	192.90	-
	7255J BTM	500	1	220.10	220.10	220.10	220.10	220.10	220.10	220.10	220.10	211.90	211.90	211.90	211.90	211.90	-
<b>7256</b> 1 1/2" Pivot Center Hung	7256SET	600	1	641.30	641.30	641.30	641.30	641.30	641.30	604.60	641.30	577.20	577.20	577.20	577.20	577.20	-
	7256 TOP	-	1	211.90	211.90	211.90	211.90	211.90	211.90	211.90	211.90	192.90	192.90	192.90	192.90	192.90	-
	7256 BTM	600	1	523.90	523.90	523.90	523.90	523.90	523.90	495.00	523.90	467.70	467.70	467.70	467.70	467.70	-
<b>7259</b> 1 1/2" Pivot Center Hung	7259SET	1000	1	1,152.70	1,152.70	1,152.70	1,152.70	1,152.70	1,152.70	1,114.50	1,152.70	1,078.80	1,078.80	1,078.80	1,078.80	1,078.80	-
	7259 TOP	-	1	449.90	449.90	449.90	449.90	449.90	449.90	384.30	449.90	321.40	321.40	321.40	321.40	321.40	-
	7259 BTM	1000	1	951.80	951.80	951.80	951.80	951.80	951.80	914.80	951.80	887.40	887.40	887.40	887.40	887.40	-
<b>91105F</b> Pocket Pivot E = Power Transfer	91105F	90	1	519.30	-	519.30	519.30	519.30	519.30	471.20	519.30	-	-	-	471.20	-	471.20
	E91105F	90	1	1,210.50	-	1,210.50	-	-	1,210.50	1,161.40	1,210.50	-	-	-	1,161.40	-	1,161.40

**Lead time exception:** The following Pivots are stocked.

7253 Set US26D and SP28, 7255 Set US26D and SP28, 7255J Set US26D, 91105F US32D, E91105 US32D

Non-Stocked E91105F pivots may take up to 4-5 weeks for shipment.

\* Fire rated models US32 and US32D (stainless), all others US26 and US26D (brass)

**Suffix Descriptions**

**BTM** - Bottom Only

**F** - Fire Rated

**INT** - Intermediate Pivot Only







**PT** - Power Transfer, TW4 standard, TW\* consult Factory for lead time.

**SET** - Top and Bottom Pivot

**TOP** - Top Only

**V** - Vertical Side Mount

(Weather Resistant) WP bearings available for 7215 26D and 7215F 32D bottom pivots at \$78 list add. Consult factory for lead time.

MODEL	SUBSTRATE	MODEL NUMBER	BHMA FINISH	WEIGHT	MUST BE ORDERED IN MULTIPLE QTY	MULTIPLE QTY	PACKED PER BOX	LIST PRICE	
								EACH	PACKAGE
<b>CBI</b> Carry Bar w/ Sex Bolts 	Steel	CBI USP	600	-	-	-	-	<b>\$37.90</b>	-
		CBI US3	632	-	-	-	-	58.00	-
		CBI US4	633	-	-	-	-	58.00	-
		CBI US10	639	-	-	-	-	58.00	-
		CBI US10B	640	-	-	-	-	58.00	-
		CBI US26	651	-	-	-	-	58.00	-
		CBI US26D**	652	-	-	-	-	58.00	-
		CBI BLK	-	-	-	-	-	37.90	-
<b>DPI</b> Dust Proof Strike Threshold Only 	Brass	DPI US3	605	-	-	1	-	30.20	-
		DPI US4	606	-	-	1	-	30.20	-
		DPI US10	612	-	-	1	-	30.20	-
		DPI US10B **	613	-	-	1	-	30.20	-
		DPI US26	625	-	-	1	-	30.20	-
		DPI US26D **	626	-	-	1	-	<b>30.20</b>	-
<b>LG1</b> Lock Guard with Security Pin Frame 	Steel	LG1 USP	600	-	-	1	-	25.40	-
		LG1 US2G**	603	-	-	1	-	<b>20.80</b>	-
		LG1 SP313	695	-	-	1	-	24.00	-
	Brass	LG1 US4	606	-	-	1	-	52.90	-
		LG1 US10	612	-	-	1	-	52.90	-
Stainless	LG1 US32D**	630	-	-	1	-	<b>48.10</b>	-	
<b>MB1</b> Mounting Bracket	See Page 32								
<b>DP2</b> Dust Proof Strike Floor and /or Threshold 	Brass	DP2 US3	605	-	-	1	-	38.00	-
		DP2 US4	606	-	-	1	-	38.00	-
		DP2 US10	612	-	-	1	-	38.00	-
		DP2 US10B **	613	-	-	1	-	<b>38.00</b>	-
		DP2 US15	619	-	-	1	-	38.00	-
		DP2 US26 **	625	-	-	1	-	38.00	-
		DP2 US26D **	626	-	-	1	-	<b>38.00</b>	-
		DP2 643E/716	-	-	-	1	-	38.00	-
DP2 BLK	622	-	-	1	-	38.00	-		
<b>MB2</b> Mounting Bracket	See Page 32								
<b>2</b> Elbow Cabinet Catch 	Aluminum	2A3**	666	0.9	-	1	20	<b>4.40</b>	-
		2A5	-	0.9	-	1	20	4.90	-
		2A14	669	0.9	-	1	20	4.90	-
		2A15	670	0.9	-	1	20	4.90	-
		2A26	672	0.9	-	1	20	4.90	-
		2A26D	702	0.9	-	1	20	4.90	-
		2A92**	673	0.9	-	1	20	<b>4.40</b>	-
		2A-643E/716	-	0.9	-	1	20	4.90	-
		2A-BLK	-	0.9	-	1	20	4.90	-
		SP2A3	666	37.5	Yes	25	25	-	\$110.25
		SP2A14	669	37.5	Yes	25	25	-	121.25
SP2A92**	673	37.5	Yes	25	25	-	110.25		
<b>MB3</b> Mounting Bracket	See Page 32								
<b>LG7</b> Lock Guard	Stainless	LG7 US32D**	630	-	-	1	-	48.10	-
<b>COR7G</b> Coordinator Gravity Arm 7" arm UL Listed 	Brass	COR7G US3	605	-	-	1	-	95.20	-
		COR7G US4	606	-	-	1	-	95.20	-
		COR7G US10	612	-	-	1	-	95.20	-
		COR7G US10B	613	-	-	1	-	95.20	-
		COR7G US26	625	-	-	1	-	128.40	-
		COR7G US26D**	626	-	-	1	-	79.10	-

HINGES  
 CONTINUOUS HINGES  
 PIVOTS  
 Numerical 1-059  
 Numerical 59-437  
 Numerical 438-1021  
 Numerical 1152-8190  
 Numerical 8200-9266

Lead time exception: \*\* Products are stocked and will typically ship in 3-5 days





Bold pricing indicates item is in stock and available for **Fast Track** and **ProXpress**

HINGES

CONTINUOUS  
HINGES













PIVOTS

Numerical  
1-059Numerical  
59-437Numerical  
438-1021Numerical  
1152-8190Numerical  
8200-9266

MODEL	SUBSTRATE	MODEL NUMBER	BHMA FINISH	WEIGHT	MUST BE ORDERED IN MULTIPLE QTY	MULTIPLE QTY	PACKED PER BOX	LIST PRICE	
								EACH	PACKAGE
<b>07</b> Window Lock 	Aluminum	07A3**	666	1.7	-	1	20	\$3.00	-
		07A10B	703	1.7	-	1	20	3.30	-
		07A14	669	1.7	-	1	20	3.30	-
		07A15	670	1.7	-	1	20	3.30	-
		07A26	672	1.7	-	1	20	3.30	-
		07A26D	702	1.7	-	1	20	3.30	-
		07A92	673	1.7	-	1	20	3.00	-
		07A-643E/716	-	1.7	-	1	20	3.30	-
		07A-BLK	-	1.7	-	1	20	4.40	-
		07A-W	-	1.7	-	1	20	4.40	-
		SP07A3	666	65	Yes	25	25	-	\$74.50
		SP07A5	-	65	Yes	25	25	-	110.25
		SP07A14	669	65	Yes	25	25	-	82.75
		SP07A92	673	65	Yes	25	25	-	74.50
		SP07A-W	-	52	Yes	20	20	-	88.20
<b>COR9G</b> Coordinator Gravity Arm 9" arm UL Listed	Brass	COR9G US3	605	-	-	1	-	107.60	-
		COR9G US4	606	-	-	1	-	107.60	-
		COR9G US10	612	-	-	1	-	107.60	-
		COR9G US10B	613	-	-	1	-	107.60	-
		COR9G US26	625	-	-	1	-	128.40	-
		COR9G US26D**	626	-	-	1	-	90.70	-
<b>FS9</b> Floor Stop 	Brass	FS9 US3	605	-	-	1	-	217.40	-
		FS9 US4	606	-	-	1	-	217.40	-
		FS9 US10	612	-	-	1	-	217.40	-
		FS9 US10B	613	-	-	1	-	217.40	-
		FS9 US26	625	-	-	1	-	217.40	-
		FS9 US26D	626	-	-	1	-	186.30	-
<b>LG10</b> Lock Guard	Stainless	LG10 US32D**	630	-	-	1	-	<b>44.80</b>	-
	Steel	LG10 USP	600	-	-	1	-	30.50	-
<b>CL11</b> Cabinet Latch 	Brass	CL11 US3	605	-	-	1	-	48.90	-
		CL11 US4	606	-	-	1	-	38.60	-
		CL11 US10	612	-	-	1	-	38.60	-
		CL11 US26D	626	-	-	1	-	<b>38.60</b>	-
<b>LG11</b> Lock Guard 	Stainless	LG11 US32D RH	630	-	-	1	-	52.90	-
		LG11 US32D LH**	630	-	-	1	-	52.90	-
	Steel	LG11 SP313 RH	695	-	-	1	-	40.00	-
		LG11 SP313 LH	695	-	-	1	-	40.00	-
<b>WS11</b> Wall Stop for Drywall Mounting 	Brass	WS11 US3	605	-	-	1	-	48.40	-
		WS11 US4	606	-	-	1	-	48.40	-
		WS11 US10	612	-	-	1	-	48.40	-
		WS11 US10B	613	-	-	1	-	48.40	-
		WS11 US26	625	-	-	1	-	48.40	-
		WS11 US26D**	626	-	-	1	-	47.10	-

Lead time exception: \*\* Products are stocked and will typically ship in 3-5 days

Bold pricing indicates item is in stock and available for **Fast Track** and **ProXpress**

MODEL	SUBSTRATE	MODEL NUMBER	BHMA FINISH	WEIGHT	MUST BE ORDERED IN MULTIPLE QTY	MULTIPLE QTY	PACKED PER BOX	LIST PRICE	
								EACH	PACKAGE
<b>WS11X</b> Wall Stop for Masonry Mounting 	Brass	WS11X US3	605	-	-	1	-	\$51.60	-
		WS11X US4	606	-	-	1	-	51.60	-
		WS11X US10	612	-	-	1	-	51.60	-
		WS11X US10B	613	-	-	1	-	51.60	-
		WS11X US26	625	-	-	1	-	51.60	-
		WS11X US26D	626	-	-	1	-	50.00	-
<b>CL12</b> Cabinet Latch 	Brass	CL12 US3	605	-	-	1	-	53.10	-
		CL12 US4**	606	-	-	1	-	47.00	-
		CL12 US10	612	-	-	1	-	47.00	-
		CL12 US26D **	626	-	-	1	-	<b>47.00</b>	-
<b>LG12</b> Lock Guard - Narrow 	Stainless	LG12 US32D **	630	-	-	1	-	<b>41.60</b>	-
	Steel	LG12 USP	600	-	-	1	-	30.50	-
<b>FS13</b> Floor Dome Stop 1" height 	Brass	FS13 US3	605	-	-	1	-	8.80	-
		FS13 US4	606	-	-	1	-	10.40	-
		FS13 US10	612	-	-	1	-	10.50	-
		FS13 US10B **	613	-	-	1	-	10.50	-
		FS13 US26	625	-	-	1	-	10.40	-
		FS13 US26D **	626	-	-	1	-	<b>8.80</b>	-
<b>LG13</b> Lock Guard 	Stainless	LG13 US32D **	630	-	-	1	-	<b>40.00</b>	-
	Steel	LG13 USP	600	-	-	1	-	26.40	-
<b>CL14</b> Cabinet Latch 	Brass	CL14 US3	605	-	-	1	-	48.70	-
		CL14 US4	606	-	-	1	-	40.90	-
		CL14 US10	612	-	-	1	-	40.90	-
		CL14 US26D **	626	-	-	1	-	<b>40.90</b>	-
<b>LG14</b> Lock Guard 	Stainless	LG14 US32D **	630	-	-	1	-	<b>65.70</b>	-
<b>FS17</b> Floor Dome Stop 1-11/32" height 	Brass	FS17 US3	605	-	-	1	-	9.70	-
		FS17 US4	606	-	-	1	-	11.70	-
		FS17 US10	612	-	-	1	-	12.10	-
		FS17 US10B	613	-	-	1	-	12.10	-
		FS17 US26	625	-	-	1	-	11.70	-
		FS17 US26D **	626	-	-	1	-	9.70	-
<b>R14</b> Riser For FS13 and FS17 Dome Stops 5/16" Height 	Steel	R14 US3	605	-	-	1	-	7.40	-
		R14 US4	606	-	-	1	-	7.40	-
		R14 US10	612	-	-	1	-	8.20	-
		R14 US10B	613	-	-	1	-	8.20	-
		R14 US26	625	-	-	1	-	8.20	-
		R14 US26D **	626	-	-	1	-	9.60	-
<b>AS18</b> Applied Stop 	Brass	AS18 US3	605	-	-	1	-	56.20	-
		AS18 US4	606	-	-	1	-	51.70	-
		AS18 US10	612	-	-	1	-	51.70	-
		AS18 US10B	613	-	-	1	-	56.20	-
		AS18 US26	625	-	-	1	-	56.20	-
		AS18 US26D **	626	-	-	1	-	56.20	-
<b>FS18</b> Security Floor or Wall Stop 	Steel/	FS18S **	-	-	-	1	-	<b>12.90</b>	-
	Rubber	FS18L **	-	-	-	1	-	<b>18.20</b>	-
<b>FL20</b> Filler Bar 	See page 32								
<b>WS20</b> Manual Wall Stop and Holder for Drywall Mounting 	Brass	WS20 US3	605	-	-	1	-	87.60	-
		WS20 US4	606	-	-	1	-	87.60	-
		WS20 US10	612	-	-	1	-	87.60	-
		WS20 US10B	613	-	-	1	-	87.60	-
		WS20 US26	625	-	-	1	-	87.60	-
		WS20 US26D **	626	-	-	1	-	73.50	-
	Aluminum	WS20 US28	628	-	-	1	-	70.10	-





Lead time exception: \*\* Products are stocked and will typically ship in 3-5 days

Bold pricing indicates item is in stock and available for **Fast Track** and **ProXpress**

HINGES  
 CONTINUOUS HINGES  
 PIVOTS  
 Numerical 1-059  
 Numerical 59-437  
 Numerical 438-1021  
 Numerical 1152-8190  
 Numerical 8200-9266

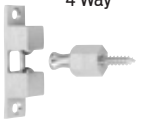





HINGES  
 CONTINUOUS HINGES  
 PIVOTS  
 Numerical 1-059  
 Numerical 59-437  
 Numerical 438-1021  
 Numerical 1152-8190  
 Numerical 8200-9266

MODEL	SUBSTRATE	MODEL NUMBER	BHMA FINISH	WEIGHT	MUST BE ORDERED IN MULTIPLE QTY	MULTIPLE QTY	PACKED PER BOX	LIST PRICE	
								EACH	PACKAGE
<b>WS20X</b> Manual Wall Stop and Holder for Masonry Mounting 	Brass	WS20X US3	605	-	-	1	-	\$90.60	-
		WS20X US4	606	-	-	1	-	90.60	-
		WS20X US10	612	-	-	1	-	90.60	-
		WS20X US10B	613	-	-	1	-	90.60	-
		WS20X US26	625	-	-	1	-	90.60	-
		WS20X US26D	626	-	-	1	-	78.30	-
	Aluminum	WS20X US28	628	-	-	1	-	74.50	-
<b>CL21/21A</b> Ball Catch 4 Way 	Brass	CL21 US26D	626	-	-	1	-	48.60	-
		CL21A US3	605	-	-	1	-	51.70	-
		CL21A US4	606	-	-	1	-	34.90	-
		CL21A US10	612	-	-	1	-	34.90	-
		CL21A US26	625	-	-	1	-	51.70	-
		CL21A US26D**	626	-	-	1	-	<b>38.00</b>	-
<b>CL22</b> Ball Catch 3 Way 	Brass	CL22 US3	605	-	-	1	-	30.40	-
		CL22 US4	606	-	-	1	-	21.30	-
		CL22 US10	612	-	-	1	-	21.30	-
		CL22 US26	625	-	-	1	-	30.40	-
		CL22 US26D	626	-	-	1	-	<b>25.60</b>	-
<b>22</b> Flush Pull 	Brass	22B3	605	1.1	-	1	20	3.60	-
		22B5	609	2.0	-	1	20	4.10	-
		22B10B**	613	1.3	-	1	20	4.10	-
		22B15**	619	1.6	-	1	20	4.00	-
		22B26	625	1.6	-	1	20	4.10	-
		22B26D**	626	1.1	-	1	20	4.10	-
		22B643E/716	-	1.1	-	1	20	4.10	-
		22B-BLK	622	1.1	-	1	20	4.10	-
SP22B3	605	50.0	Yes	25	25	-	92.25		
<b>25</b> Screen Door Pull 	Aluminum	25A3	666	1.2	-	1	20	2.10	-
		25A92	673	1.2	-	1	20	2.10	-
		25A-BLK	-	1.2	-	1	20	3.00	-
		25A-W	-	1.2	-	1	20	3.00	-
		SP25A3	666	30.0	Yes	25	25	-	51.25
		SP25A92	673	30.0	Yes	25	25	-	51.25
<b>026</b> Bar Window Lift 	Aluminum	026A3	666	1.9	-	1	10	2.10	-
		026A5	-	1.1	-	1	10	2.70	-
		026A14	669	1.8	-	1	10	2.70	-
		026A15	670	1.9	-	1	10	2.70	-
		026A26	672	1.9	-	1	10	2.70	-
		026A26D	702	1.9	-	1	10	2.70	-
		026A92	673	1.1	-	1	10	2.10	-
		026A-643E/716	-	1.1	-	1	10	2.70	-
		026A-BLK	-	1.4	-	1	10	3.20	-
		026A-W	-	1.4	-	1	10	3.20	-
		SP026A3	666	45.0	Yes	25	25	-	52.25
		SP026A5	-	45.0	Yes	25	25	-	66.25
		SP026A14	669	45.0	Yes	25	25	-	66.25
SP026A92	673	45.0	Yes	25	25	-	52.25		
		SP026A-W	-	-	Yes	20	20	-	63.80

Continued on next page.

Lead time exception: \*\* Products are stocked and will typically ship in 3-5 days

Bold pricing indicates item is in stock and available for **Fast Track** and **ProXpress**

MODEL	SUBSTRATE	MODEL NUMBER	BHMA FINISH	WEIGHT	MUST BE ORDERED IN MULTIPLE QTY	MULTIPLE QTY	PACKED PER BOX	LIST PRICE	
								EACH	PACKAGE
<i>Continued from previous page.</i> <b>026</b> Bar Window Lift 	Brass	026B3	605	-	-	1	10	\$9.40	
		026B5	609	-	-	1	10	11.30	
		026B15	619	-	-	1	10	11.50	
		026B26	625	-	-	1	10	11.50	
		026B26D	626	-	-	1	10	11.30	
		026B-643E/716	-	-	-	1	10	11.50	
		026B-BLK	622	-	-	1	10	11.50	
		SPO26B26	625	-	Yes	10	10	-	\$115.80
<b>RL30</b> Nylon Roller 	Brass	RL30 US3	605	-	-	1	-	79.40	-
		RL30 US4	606	-	-	1	-	67.60	-
		RL30 US10	612	-	-	1	-	70.30	-
		RL30 US10B **	613	-	-	1	-	82.30	-
		RL30 US15	619	-	-	1	-	79.40	-
		RL30 US26	625	-	-	1	-	79.40	-
		RL30 US26D **	626	-	-	1	-	<b>75.10</b>	-
		RL30 643E/716	-	-	-	1	-	82.30	-
		RL30 BLK	622	-	-	1	-	75.10	-
<b>RL30A</b> Nylon Roller w/ASA Strike 	Brass	RL30-A US3	605	-	-	1	-	88.90	-
		RL30-A US4	606	-	-	1	-	77.10	-
		RL30-A US10	612	-	-	1	-	80.20	-
		RL30-A US10B	613	-	-	1	-	92.20	-
		RL30-A US26	625	-	-	1	-	88.90	-
		RL30-A US26D **	626	-	-	1	-	84.70	-
<b>FB31</b> Automatic Flush Bolts, Metal Doors UL 3 Hour Top and Bottom Bolt P=Pair T=Top Bolt Only B=Bottom Bolt Only Optional Rod Lengths Available 18", 24", 36", 48" 13.00 List Add 	Steel	FB31P-12-MD US3	605	-	-	1	-	213.70	-
		FB31P-12-MD US4	606	-	-	1	-	213.70	-
		FB31P-12-MD US10	612	-	-	1	-	213.70	-
		FB31P-12-MD US10B **	613	-	-	1	-	213.70	-
	Stainless	FB31P-12-MD US32	629	-	-	1	-	213.70	-
		FB31P-12-MD US32D **	630	-	-	1	-	<b>213.70</b>	-
		FB31P-12-MD BLK	-	-	-	1	-	213.70	-
	Brass	FB31T-12-MD US3	605	-	-	1	-	112.80	-
		FB31T-12-MD US4	606	-	-	1	-	112.80	-
		FB31T-12-MD US10	612	-	-	1	-	112.80	-
		FB31T-12-MD US10B	613	-	-	1	-	112.80	-
	Stainless	FB31T-12-MD US32	629	-	-	1	-	112.80	-
		FB31T-12-MD US32D **	630	-	-	1	-	112.80	-
		FB31T-12-MD BLK	-	-	-	1	-	112.80	-
	Brass	FB31B-12-MD US3	605	-	-	1	-	112.80	-
		FB31B-12-MD US4	606	-	-	1	-	112.80	-
		FB31B12-MD US10	612	-	-	1	-	112.80	-
		FB31B-12-MD US10B	613	-	-	1	-	112.80	-
	Stainless	FB31B-12-MD US32	629	-	-	1	-	112.80	-
		FB31B-12-MD US32D**	630	-	-	1	-	112.80	-
FB31B-12-MD BLK		-	-	-	1	-	112.80	-	
<b>COR32*</b> Door Coordinator 32" Channel Length UL Listed *See note at page bottom for door prep charges.	Aluminum	COR32 US28	628	-	-	1	-	167.40	-
		COR32 315AN	711	-	-	1	-	223.50	-
		COR32 US26D	713	-	-	1	-	331.20	-
		COR32 US28w/FL20 **	628	-	-	1	-	183.50	-
<b>COR42*</b> Door Coordinator 42" Channel Length UL Listed *See note at page bottom for door prep charges.	Aluminum	COR42 US28**	628	-	-	1	-	180.10	-
		COR42 315AN	711	-	-	1	-	237.90	-
		COR42 US26D	713	-	-	1	-	352.10	-
		COR42 US28w/FL20**	628	-	-	1	-	196.20	-
		COR42 US28w/FL32	628	-	-	1	-	199.40	-
		COR42 US28w/FL44	628	-	-	1	-	204.20	-

\* Special factory preparation for use with vertical rod exit devices available. **List Add \$143.00.**

**Lead time exception:** \*\* Products are stocked and will typically ship in 3-5 days

**Bold pricing indicates item is in stock and available for Fast Track and ProXpress**

HINGES

CONTINUOUS HINGES

PIVOTS

Numerical 1-059

Numerical 59-437

Numerical 438-1021

Numerical 1152-8190

Numerical 8200-9266





HINGES  
 CONTINUOUS HINGES  
 PIVOTS  
 Numerical 1-059  
 Numerical 59-437  
 Numerical 438-1021  
 Numerical 1152-8190  
 Numerical 8200-9266

MODEL	SUBSTRATE	MODEL NUMBER	BHMA FINISH	WEIGHT	MUST BE ORDERED IN MULTIPLE QTY	MULTIPLE QTY	PACKED PER BOX	LIST PRICE	
								EACH	PACKAGE
<b>COR52*</b> Door Coordinator 52" Channel Length UL Listed *See note at page bottom for door prep charges.	Aluminum	COR52 US28	628	-	-	1	-	<b>\$170.40</b>	-
		COR52 315AN**	711	-	-	1	-	221.50	-
		COR52 US26D**	713	-	-	1	-	349.30	-
		COR52 US28w/FL20**	628	-	-	1	-	<b>186.50</b>	-
		COR52 US28w/FL32**	628	-	-	1	-	189.70	-
		COR52 US28w/FL44	628	-	-	1	-	194.50	-
<b>COR60*</b> Door Coordinator 60" Channel Length UL Listed *See note at page bottom for door prep charges.	Aluminum	COR60 US28**	628	-	-	1	-	198.80	-
		COR60 315AN	711	-	-	1	-	258.80	-
		COR60 US26D	713	-	-	1	-	376.10	-
		COR60 US28w/FL20**	628	-	-	1	-	214.90	-
		COR60 US28w/FL32**	628	-	-	1	-	218.10	-
		COR60 US28w/FL44	628	-	-	1	-	222.90	-
<b>COR72*</b> Door Coordinator 72" Channel Length UL Listed *See note at page bottom for door prep charges.	Aluminum	COR72 US28**	628	-	-	1	-	226.20	-
		COR72 315AN	711	-	-	1	-	312.00	-
		COR72 US26D	713	-	-	1	-	449.90	-
		COR72 US28w/FL20**	628	-	-	1	-	242.30	-
		COR72 US28w/FL32**	628	-	-	1	-	245.50	-
		COR72 US28w/FL44	628	-	-	1	-	250.30	-
<b>FL20</b> Filler Bar 20" Length	Aluminum	FL20 US28**	628	-	-	1	-	<b>16.10</b>	-
		FL20 315AN**	711	-	-	1	-	51.70	-
		FL20 US26D**	713	-	-	1	-	75.70	-
<b>FL32</b> Filler Bar 32" Length	Aluminum	FL32 US28**	628	-	-	1	-	19.30	-
		FL32 315AN	711	-	-	1	-	54.70	-
		FL32 US26D	713	-	-	1	-	82.00	-
<b>FL44</b> Filler Bar 44" Length	Aluminum	FL44 US28	628	-	-	1	-	24.10	-
		FL44 315AN	711	-	-	1	-	59.40	-
		FL44 US26D	713	-	-	1	-	96.40	-
<b>MB1</b> Mounting Bracket Stop Widths Over 2-1/2"	Aluminum	MB1 USP	600	-	-	1	-	<b>23.10</b>	-
		MB1 SP28**	689	-	-	1	-	<b>32.90</b>	-
		MB1 BLK**	-	-	-	1	-	32.90	-
<b>MB1F &amp; MB1V</b> Mounting Bracket Stop Widths 1-1/2" - 2-1/4"	Steel	MB1F USP	600	-	-	1	-	59.40	-
		MB1F SP28**	689	-	-	1	-	59.40	-
		MB1F BLK	-	-	-	1	-	59.40	-
		MB1V USP	600	-	-	1	-	94.50	-
		MB1V SP28	689	-	-	1	-	94.50	-
		MB1V BLK	-	-	-	1	-	94.50	-
<b>MB2</b> Mounting Bracket Stop Widths Up to 2-1/2"	Aluminum	MB2 USP	600	-	-	1	-	<b>27.10</b>	-
		MB2 SP28**	689	-	-	1	-	<b>37.20</b>	-
		MB2 BLK**	-	-	-	1	-	37.20	-
<b>MB2F &amp; MB2V</b> Mounting Bracket Stop Widths 2-3/8" - 3-1/4"	Steel	MB2F USP	600	-	-	1	-	59.20	-
		MB2F SP28**	689	-	-	1	-	59.20	-
		MB2F BLK	-	-	-	1	-	59.20	-
		MB2V USP	600	-	-	1	-	94.60	-
		MB2V SP28	689	-	-	1	-	94.60	-
		MB2V BLK	-	-	-	1	-	94.60	-
<b>MB3F &amp; MB3V</b> Mounting Bracket Stop Widths Over 3-3/8"	Steel	MB3F USP	600	-	-	1	-	59.20	-
		MB3F SP28**	689	-	-	1	-	59.20	-
		MB3F BLK	-	-	-	1	-	59.20	-
		MB3V USP	600	-	-	1	-	94.60	-
		MB3V SP28	689	-	-	1	-	94.60	-
		MB3V BLK	-	-	-	1	-	94.60	-

\* Special factory preparation for use with vertical rod exit devices available. List Add \$143.00.

Lead time exception: \*\* Products are stocked and will typically ship in 3-5 days

Bold pricing indicates item is in stock and available for **Fast Track** and **ProXpress**

MODEL	SUBSTRATE	MODEL NUMBER	BHMA FINISH	WEIGHT	MUST BE ORDERED IN MULTIPLE QTY	MULTIPLE QTY	PACKED PER BOX	LIST PRICE	
								EACH	PACKAGE
<b>FB32</b> Automatic Flush Bolts, Metal Doors UL 3 Hour Top Bolt w/Auxiliary Fire Latch 	Brass	FB32-12-MD US3	605	-	-	1	-	\$213.70	-
		FB32-12-MD US4	606	-	-	1	-	213.70	-
		FB32-12-MD US10	612	-	-	1	-	213.70	-
		FB32-12-MD US10B	613	-	-	1	-	213.70	-
	Stainless	FB32-12-MD US32	629	-	-	1	-	213.70	-
		FB32-12-MD US32D**	630	-	-	1	-	213.70	-
FB32-12-MD BLK		-	-	-	1	-	213.70	-	
<b>COR32</b> Door Coordinator	See page 31								
<b>FL32</b> Filler Bar	See page 32								
<b>RL32</b> Nylon Roller 		RL32 US3	605	-	-	1	-	107.30	-
		RL32 US4	606	-	-	1	-	101.40	-
		RL32 US10	612	-	-	1	-	105.40	-
		RL32 US10B**	613	-	-	1	-	111.50	-
		RL32 US15	619	-	-	1	-	107.30	-
		RL32 US26	625	-	-	1	-	107.30	-
		RL32 US26D**	626	-	-	1	-	<b>101.40</b>	-
		RL32 643E/716	-	-	-	1	-	111.50	-
		RL32 BLK	-	-	-	1	-	107.30	-
<b>RL32A</b> Nylon Roller w/ASA Strike 	Brass	RL32-A US3	605	-	-	1	-	116.80	-
		RL32-A US4	606	-	-	1	-	110.90	-
		RL32-A US10	612	-	-	1	-	115.40	-
		RL32-A US10B	613	-	-	1	-	121.40	-
		RL32-A US26	625	-	-	1	-	116.80	-
RL32-A US26D**	626	-	-	1	-	110.90	-		
<b>FB33</b> Top Auto Flush Bolt w/Auxiliary Fire Latch Retrofit Plate 	Brass	FB33-12-MD US3	605	-	-	1	-	220.70	-
		FB33-12-MD US4	606	-	-	1	-	220.70	-
		FB33-12-MD US10	612	-	-	1	-	220.70	-
		FB33-12-MD US10B	613	-	-	1	-	220.70	-
	Stainless	FB33-12-MD US32	629	-	-	1	-	220.70	-
		FB33-12-MD US32D	630	-	-	1	-	220.70	-
FB33-12-MD BLK	-	-	-	1	-	220.70	-		
<b>WS33</b> Wall Stop For Drywall Mounting	Brass	WS33 US26D**	626	-	-	1	-	<b>58.30</b>	-
<b>WS33X</b> Wall Stop For Masonary Mounting	Brass	WS33X US26D	626	-	-	1	-	62.10	-
<b>RL36/36A</b> Roller Latch Mortise	Stainless	RL36 US32D**	630	-	-	1	-	57.20	-
		RL36-A US32D	630	-	-	1	-	<b>67.20</b>	-
<b>RL38</b> Roller Latch Surface Mount	Stainless	RL38 US32D**	630	-	-	1	-	<b>54.00</b>	-
<b>40</b> Decorative Light Duty Surface Bolt Packed with Universal and Mortise Strike 	Brass	40B3 3 IN	605	1.9	-	1	10	17.50	-
		40B5 3 IN	609	1.9	-	1	10	17.50	-
		40B10B 3 IN	613	1.9	-	1	10	18.30	-
		40B15 3 IN	619	1.9	-	1	10	17.50	-
		40B26 3 IN	625	1.9	-	1	10	18.30	-
		40B26D 3 IN	626	1.9	-	1	10	18.30	-
		40B643E/716 3 IN	-	1.9	-	1	10	18.30	-
		40B-BLK 3 IN	622	1.9	-	1	10	18.30	-
		40B3 4 IN	605	2.4	-	1	10	18.30	-
		40B5 4 IN	609	2.4	-	1	10	18.40	-
		40B10B 4 IN	613	2.4	-	1	10	19.30	-
		40B15 4 IN	619	2.4	-	1	10	18.40	-
		40B26 4 IN	625	2.4	-	1	10	19.30	-
		40B26D 4 IN**	626	2.4	-	1	10	<b>19.30</b>	-
40B643E/716 4 IN	-	2.4	-	1	10	19.30	-		
40B-BLK 4 IN	622	2.4	-	1	10	19.30	-		

Lead time exception: \*\* Products are stocked and will typically ship in 3-5 days

Bold pricing indicates item is in stock and available for **Fast Track** and **ProXpress**

HINGES

CONTINUOUS HINGES

PIVOTS

Numerical 1-059

Numerical 59-437

Numerical 438-1021

Numerical 1152-8190

Numerical 8200-9266

HINGES

CONTINUOUS HINGES

PIVOTS





Numerical 1-059

Numerical 59-437

Numerical 438-1021





Numerical 1152-8190

Numerical 8200-9266

MODEL	SUBSTRATE	MODEL NUMBER	BHMA FINISH	WEIGHT	MUST BE ORDERED IN MULTIPLE QTY	MULTIPLE QTY	PACKED PER BOX	LIST PRICE	
								EACH	PACKAGE
Continued from previous page. <b>40</b> Decorative Light Duty Surface Bolt Packed with Universal and Mortise Strike	Brass	40B3 6 IN	605	3.5	-	1	10	\$21.60	-
		40B5 6 IN	609	3.5	-	1	10	21.60	-
		40B10B 6 IN	613	3.5	-	1	10	22.50	-
		40B15 6 IN	619	3.5	-	1	10	21.60	-
		40B26 6 IN	625	3.5	-	1	10	22.50	-
		40B26D 6 IN	626	3.5	-	1	10	22.50	-
		40B643E/716 6 IN	-	3.5	-	1	10	22.50	-
<b>FS40</b> Auto Floor Type Holder Floor Clearance 1/2" or less 	Brass	FS40 US3	605	-	-	1	-	91.80	-
		FS40 US4	606	-	-	1	-	68.60	-
		FS40 US10	612	-	-	1	-	91.80	-
		FS40 US10B	613	-	-	1	-	91.80	-
		FS40 US26	625	-	-	1	-	91.80	-
		FS40 US26D**	626	-	-	1	-	<b>68.60</b>	-
<b>WS40</b> Automatic Wall Stop and Holder 	Brass	WS40 US3	605	-	-	1	-	123.10	-
		WS40 US4	606	-	-	1	-	123.10	-
		WS40 US10	612	-	-	1	-	123.10	-
		WS40 US10B	613	-	-	1	-	123.10	-
		WS40 US26	625	-	-	1	-	123.10	-
		WS40 US26D**	626	-	-	1	-	<b>115.60</b>	-
<b>FB41</b> Automatic Flush Bolt Wood Door Top and Bottom Bolt UL Listed 90 Minutes  P=Pair T=Top Bolt Only B=Bottom Bolt Only 	Brass	FB41P-WD US3	605	-	-	1	-	223.50	-
		FB41P-WD US4	606	-	-	1	-	223.50	-
		FB41P-WD US10	612	-	-	1	-	223.50	-
		FB41P-WD US10B**	613	-	-	1	-	223.50	-
	Stainless	FB41P-WD US32	629	-	-	1	-	223.50	-
		FB41P-WD US32D**	630	-	-	1	-	<b>223.50</b>	-
		FB41P-WD BLK	-	-	-	1	-	223.50	-
	Brass	FB41T-WD US3	605	-	-	1	-	116.90	-
		FB41T-WD US4	606	-	-	1	-	116.90	-
		FB41T-WD US10	612	-	-	1	-	116.90	-
		FB41T-WD US10B	613	-	-	1	-	116.90	-
	Stainless	FB41T-WD US32	629	-	-	1	-	116.90	-
		FB41T-WD US32D**	630	-	-	1	-	116.90	-
		FB41T-WD BLK	-	-	-	1	-	116.90	-
	Brass	FB41B-WD US3	605	-	-	1	-	116.90	-
		FB41B-WD US4	606	-	-	1	-	116.90	-
		FB41B-WD US10	612	-	-	1	-	116.90	-
		FB41B-WD US10B	613	-	-	1	-	116.90	-
Stainless	FB41B-WD US32	629	-	-	1	-	116.90	-	
	FB41B-WD US32D	630	-	-	1	-	116.90	-	
	FB41B-WD BLK	-	-	-	1	-	116.90	-	
<b>FS41</b> Automatic Floor Type Holder Floor Clearance 9/16" to 1-1/16"	Brass	FS41 US3	605	-	-	1	-	95.50	-
		FS41 US4	606	-	-	1	-	72.60	-
		FS41 US10	612	-	-	1	-	95.50	-
		FS41 US10B	613	-	-	1	-	95.50	-
		FS41 US26	625	-	-	1	-	95.50	-
		FS41 US26D**	626	-	-	1	-	72.60	-
<b>42</b> Pocket Door Bolt 	Brass	42B3	605	0.9	-	1	10	15.50	-
		42B4	606	0.9	-	1	10	15.50	-
		42B5	609	0.9	-	1	10	17.10	-
		42B10	612	0.9	-	1	10	17.80	-
		42B10B**	613	0.9	-	1	10	<b>17.80</b>	-
		42B15**	619	0.9	-	1	10	<b>17.10</b>	-
		42B26**	625	0.9	-	1	10	<b>17.80</b>	-
		42B26D**	626	0.9	-	1	10	17.80	-
		42B643E/716	-	0.9	-	1	10	17.80	-
42B-BLK	622	0.9	-	1	10	17.80	-		
<b>COR42</b> Door Coordinator	See page 31								

Lead time exception: \*\* Products are stocked and will typically ship in 3-5 days

Bold pricing indicates item is in stock and available for **Fast Track** and **ProXpress**

MODEL	SUBSTRATE	MODEL NUMBER	BHMA FINISH	WEIGHT	MUST BE ORDERED IN MULTIPLE QTY	MULTIPLE QTY	PACKED PER BOX	LIST PRICE	
								EACH	PACKAGE
<b>FB42</b> Automatic Flush Bolt Wood Door UL 20 Minutes Top Bolt w/ Auxiliary Fire Latch	Brass	FB42-WD US3	605	-	-	1	-	\$225.60	-
		FB42-WD US4	606	-	-	1	-	225.60	-
		FB42-WD US10	612	-	-	1	-	225.60	-
	Stainless	FB42-WD US10B	613	-	-	1	-	225.60	-
		FB42-WD US32	629	-	-	1	-	225.60	-
		FB42-WD US32D**	630	-	-	1	-	225.60	-
<b>FS42</b> Automatic Floor Type Holder Floor Clearance 1-1/8" to 1-9/16"	Brass	FS42 US3	605	-	-	1	-	114.90	-
		FS42 US4	606	-	-	1	-	91.80	-
		FS42 US10	612	-	-	1	-	114.90	-
		FS42 US10B	613	-	-	1	-	114.90	-
		FS42 US26	625	-	-	1	-	114.90	-
		FS42 US26D	626	-	-	1	-	91.80	-
<b>FS43</b> Automatic Floor Type Holder Floor Clearance 1-5/8" to 2-11/16"	Brass	FS43 US3	605	-	-	1	-	126.40	-
		FS43 US4	606	-	-	1	-	103.50	-
		FS43 US10	612	-	-	1	-	126.40	-
		FS43 US10B	613	-	-	1	-	126.40	-
		FS43 US26	625	-	-	1	-	126.40	-
		FS43 US26D**	626	-	-	1	-	103.50	-
<b>FL44</b> Filler Bar	See page 32								
<b>WS45</b> Automatic Wall Holder For Drywall Mounting 	Brass	WS45 US3	605	-	-	1	-	164.90	-
		WS45 US4	606	-	-	1	-	164.90	-
		WS45 US10	612	-	-	1	-	164.90	-
		WS45 US10B	613	-	-	1	-	164.90	-
		WS45 US15	619	-	-	1	-	164.90	-
		WS45 US26	625	-	-	1	-	164.90	-
		WS45 US26D**	626	-	-	1	-	<b>160.90</b>	-
		WS45 B643E/716	-	-	-	1	-	164.90	-
	WS45 BLK	622	-	-	1	-	164.90	-	
Aluminum	WS45 US28	628	-	-	1	-	129.80	-	
<b>WS45X</b> Automatic Wall Holder For Masonry Mounting 	Brass	WS45X US3	605	-	-	1	-	174.50	-
		WS45X US4	606	-	-	1	-	174.50	-
		WS45X US10	612	-	-	1	-	174.50	-
		WS45X US10B	613	-	-	1	-	174.50	-
		WS45X US15	619	-	-	1	-	174.50	-
		WS45X US26	625	-	-	1	-	174.50	-
		WS45X US26D	626	-	-	1	-	170.30	-
		WS45X B643E/716	-	-	-	1	-	174.50	-
	WS45X BLK	622	-	-	1	-	174.50	-	
Aluminum	WS45X US28	628	-	-	1	-	139.20	-	
<b>S48</b> Mortise Bolt 	Brass	S48B3	605	2.6	-	1	10	20.60	-
		S48B5	609	2.6	-	1	10	24.80	-
		S48B10B	613	2.6	-	1	10	23.90	-
		S48B15	619	2.6	-	1	10	23.10	-
		S48B26	625	2.6	-	1	10	23.90	-
		S48B26D	626	2.6	-	1	10	23.90	-
<b>S48</b> Strike Package	09-40-605		605	-	-	1	-	5.90	-
	09-40-613		613	-	-	1	-	5.90	-
	09-40-626		626	-	-	1	-	5.90	-
<b>FB51</b> UL 3 Hour Constant Latching Top and Automatic Bottom Bolt, Metal Door  P=Pair T=Top Bolt Only B=Bottom Bolt Only  Optional Rod Lengths Available 18", 24", 36", 48" 13.00 List Add	Brass	FB51P-12-MD US3	605	-	-	1	-	213.70	-
		FB51P-12-MD US4	606	-	-	1	-	213.70	-
		FB51P-12-MD US10	612	-	-	1	-	213.70	-
		FB51P-12-MD US10B**	613	-	-	1	-	213.70	-
	Stainless	FB51P-12-MD US32	629	-	-	1	-	213.70	-
		FB51P-12-MD US32D**	630	-	-	1	-	<b>213.70</b>	-
		FB51P-12-MD BLK	-	-	-	1	-	213.70	-
	Brass	FB51T-12-MD US3	605	-	-	1	-	111.50	-
		FB51T-12-MD US4	606	-	-	1	-	111.50	-
		FB51T-12-MD US10	612	-	-	1	-	111.50	-
		FB51T-12-MD US10B	613	-	-	1	-	111.50	-
	Stainless	FB51T-12-MD US32	629	-	-	1	-	111.50	-
FB51T-12-MD US32D**		630	-	-	1	-	111.50	-	
FB51T-12-MD BLK		-	-	-	1	-	111.50	-	
<b>COR52</b> Door Coordinator	See page 32								

HINGES

CONTINUOUS HINGES

PIVOTS

Numerical 1-059

Numerical 59-437

Numerical 438-1021

Numerical 1152-8190



Numerical 8200-9266

Lead time exception: \*\* Products are stocked and will typically ship in 3-5 days

Bold pricing indicates item is in stock and available for **Fast Track** and **ProXpress**





HINGES  
 CONTINUOUS HINGES  
 PIVOTS  
 Numerical 1-059  
 Numerical 59-437  
 Numerical 438-1021  
 Numerical 1152-8190  
 Numerical 8200-9266

MODEL	SUBSTRATE	MODEL NUMBER	BHMA FINISH	WEIGHT	MUST BE ORDERED IN MULTIPLE QTY	MULTIPLE QTY	PACKED PER BOX	LIST PRICE	
								EACH	PACKAGE
<b>FB52</b> Flush Bolt UL 3 Hour Constant Latching Top w/ Auxiliary Fire Latch	Brass	FB52-12-MD US3	605	-	-	1	-	\$213.70	-
		FB52-12-MD US4	606	-	-	1	-	213.70	-
		FB52-12-MD US10	612	-	-	1	-	213.70	-
		FB52-12-MD US10B	613	-	-	1	-	213.70	-
	Stainless	FB52-12-MD US32	629	-	-	1	-	213.70	-
		FB52-12-MD US32D**	630	-	-	1	-	213.70	-
		FB52-12-MD BLK	-	-	-	1	-	213.70	-
<b>FB53</b> UL 3 Hour Constant Latching Top w/ Auxiliary Fire Latch and Retrofit Plate	Brass	FB53-12-MD US3	605	-	-	1	-	220.70	-
		FB53-12-MD US4	606	-	-	1	-	220.70	-
		FB53-12-MD US10	612	-	-	1	-	220.70	-
		FB53-12-MD US10B	613	-	-	1	-	220.70	-
	Stainless	FB53-12-MD US32	629	-	-	1	-	220.70	-
		FB53-12-MD US32D	630	-	-	1	-	220.70	-
		FB53-12-MD BLK	-	-	-	1	-	220.70	-
<b>054</b> Dutch Door Bolt 	Brass	054B3	605	2.3	-	1	5	50.70	-
		054B4	606	2.3	-	1	5	50.70	-
		054B10	612	2.3	-	1	5	46.10	-
		054B10B**	613	2.3	-	1	5	55.50	-
		054B15	619	2.3	-	1	5	57.60	-
		054B26	625	2.3	-	1	5	55.50	-
		054B26D**	626	2.3	-	1	5	<b>50.70</b>	-
<b>059</b> Handrail Bracket 	Aluminum	059A3**	666	3.2	-	1	20	4.00	-
		059A5**	-	3.2	-	1	20	4.00	-
		059A10	668	3.2	-	1	20	4.00	-
		059A10B**	703	3.2	-	1	20	4.00	-
		059A14	669	3.2	-	1	20	4.00	-
		059A15**	670	3.2	-	1	20	4.00	-
		059A26	672	3.2	-	1	20	4.00	-
		059A26D	702	3.2	-	1	20	4.00	-
		059A92**	673	3.2	-	1	20	<b>4.00</b>	-
		059A-643E/716**	-	3.2	-	1	20	4.00	-
		059A-BLK**	-	3.3	-	1	20	<b>5.40</b>	-
		059A-W	-	3.3	-	1	20	<b>5.40</b>	-
		SP059A3	666	68.0	Yes	20	20	-	\$82.20
		SP059A5	-	68.0	Yes	20	20	-	82.20
	SP059A14	669	68.0	Yes	20	20	-	82.20	
	SP059A92	673	68.0	Yes	20	20	-	82.20	
	Brass	059B3	605	3.2	-	1	10	23.40	-
		059B5	609	3.2	-	1	10	32.30	-
		059B10B	613	3.2	-	1	10	26.70	-
		059B15	619	3.2	-	1	10	26.70	-
059B15A		620	3.2	-	1	10	26.70	-	
059B26		625	3.2	-	1	10	32.30	-	
059B26D		626	3.2	-	1	10	32.30	-	
059B-643E/716		-	3.2	-	1	10	26.70	-	
059B-BLK		622	3.2	-	1	10	26.70	-	
SP059B10B		613	37.0	Yes	10	10	-	275.20	
SP059B26	625	37.0	Yes	10	10	-	329.20		
Zinc	059Z-619E	-	-	-	1	20	6.20	-	

Lead time exception: \*\* Products are stocked and will typically ship in 3-5 days

Bold pricing indicates item is in stock and available for **Fast Track** and **ProXpress**



MODEL	SUBSTRATE	MODEL NUMBER	BHMA FINISH	WEIGHT	MUST BE ORDERED IN MULTIPLE QTY	MULTIPLE QTY	PACKED PER BOX	LIST PRICE	
								EACH	PACKAGE
<b>59</b> Handrail Bracket 	Aluminum	59A3**	666	1.6	-	1	10	<b>\$4.10</b>	-
		59A5	-	2.1	-	1	10	5.30	-
		59A10B**	703	3.2	-	1	10	7.20	-
		59A14	669	2.1	-	1	10	5.30	-
		59A15**	670	2.0	-	1	10	<b>5.30</b>	-
		59A92**	673	3.2	-	1	10	4.10	-
		59A-643E/716**	-	2.0	-	1	10	<b>5.30</b>	-
		SP59A3	666	45.0	Yes	15	15	-	\$63.75
		SP59A5	-	45.0	Yes	15	15	-	77.55
		SP59A14	669	45.0	Yes	15	15	-	77.55
	SP59A92	673	45.0	Yes	15	15	-	63.75	
	Brass	59B3	605	3.8	-	1	10	24.60	-
		59B5	609	3.8	-	1	10	28.20	-
		59B15	619	3.8	-	1	10	28.20	-
		59B26	625	3.8	-	1	10	28.20	-
		59B26D	626	3.8	-	1	10	28.20	-
59B-643E/716		-	3.8	-	1	10	28.20	-	
SP59B3		605	41.0	Yes	10	10	-	245.40	
<b>060</b> Flexible Door Stop 3" Projection 		Steel	060F3	632	1.1	-	1	20	1.30
	060F5		638	1.1	-	1	20	1.30	-
	060F10		639	1.1	-	1	20	1.30	-
	060F10B**		640	1.1	-	1	20	<b>1.30</b>	-
	060F14**		645	1.1	-	1	20	<b>1.30</b>	-
	060F15**		646	1.1	-	1	20	<b>1.30</b>	-
	060F26		651	1.1	-	1	20	1.30	-
	060F26D**		652	1.1	-	1	20	<b>1.30</b>	-
	060F-643E/716		-	1.1	-	1	20	1.30	-
	060F-BLK		-	1.1	-	1	20	1.30	-
	SPO60F3		632	145.0	Yes	50	50	-	65.50
	SPO60F5		638	145.0	Yes	50	50	-	65.50
	SPO60F10B		640	145.0	Yes	50	50	-	65.50
	SPO60F14		645	145.0	Yes	50	50	-	65.50
	SRT (WSPART.1076)		9	-	Yes	100	100	-	43.60
	<b>60</b> Door Stop 3-3/4" Projection 		Aluminum	60A3	666	1.5	-	1	20
60A10B		703		1.5	-	1	20	5.40	-
60A14		669		1.5	-	1	20	3.80	-
60A15		670		1.5	-	1	20	3.80	-
60A26		672		1.5	-	1	20	3.80	-
60A26D		702		1.5	-	1	20	3.80	-
60A92**		673		1.5	-	1	20	<b>3.80</b>	-
60A-643E/716		-		1.5	-	1	20	5.40	-
60A-BLK		-		1.5	-	1	20	3.80	-
Brass		60B3		605	1.9	-	1	10	14.00
		60B4	606	1.9	-	1	10	14.00	-
		60B5	609	1.9	-	1	10	14.00	-
		60B10	612	1.9	-	1	10	18.30	-
		60B10B	613	1.9	-	1	10	18.30	-
		60B15	619	1.9	-	1	10	18.30	-
		60B26	625	1.9	-	1	10	18.30	-
		60B26D	626	1.9	-	1	10	18.30	-
		60B-643E/716	-	1.9	-	1	10	18.30	-
60B-BLK		622	1.9	-	1	10	18.30	-	
<b>60 Rubber Tips</b>		RT (WSPART.1075)	-	-	Yes	100	100	-	<b>93.30</b>
<b>COR60</b> Door Coordinator	See page 32								

HINGES  
 CONTINUOUS HINGES  
 PIVOTS  
 Numerical 1-059  
 Numerical 59-437  
 Numerical 438-1021  
 Numerical 1152-8190  
 Numerical 8200-9266

Lead time exception: \*\* Products are stocked and will typically ship in 3-5 days







Bold pricing indicates item is in stock and available for **Fast Track** and **ProXpress**

HINGES  
 CONTINUOUS HINGES  
 PIVOTS  
 Numerical 1-059  
 Numerical 59-437  
 Numerical 438-1021  
 Numerical 1152-8190  
 Numerical 8200-9266

MODEL	SUBSTRATE	MODEL NUMBER	BHMA FINISH	WEIGHT	MUST BE ORDERED IN MULTIPLE QTY	MULTIPLE QTY	PACKED PER BOX	LIST PRICE	
								EACH	PACKAGE
<b>061</b> <b>Flexible Door Stop</b> 4" Projection 	Steel	061F3	632	1.4	-	1	20	\$1.40	-
		061F5	638	1.4	-	1	20	1.40	-
		061F10	639	1.4	-	1	20	1.40	-
		061F10B	640	1.4	-	1	20	1.40	-
		061F14	645	1.4	-	1	20	1.40	-
		061F15	646	1.4	-	1	20	1.40	-
		061F26	651	1.4	-	1	20	1.40	-
		061F26D**	652	1.4	-	1	20	1.40	-
		061F-643E/716	-	1.4	-	1	20	1.40	-
		061F-BLK	-	1.4	-	1	20	1.40	-
		061F-W	-	1.4	-	1	20	1.40	-
		SP061F3	632	47.5	Yes	25	25	-	\$36.00
		SP061F5	638	47.5	Yes	25	25	-	36.00
SP061F14	645	47.5	Yes	25	25	-	36.00		
<b>Rubber Tip - Flexible Stops</b>	Rubber	SRT (WSPART.1076)	-	-	Yes	100	100	-	43.60
<b>61</b> <b>Solid Door Stop</b> 3-3/16" Projection  *Provided with Black Rubber Tip	Aluminum	61A3**	666	1.2	-	1	20	3.80	-
		61A5	-	1.2	-	1	20	3.80	-
		61A10	668	1.2	-	1	20	3.80	-
		61A10B**	703	1.2	-	1	20	<b>3.80</b>	-
		61A14**	669	1.2	-	1	20	<b>3.80</b>	-
		61A15**	670	1.2	-	1	20	<b>3.80</b>	-
		61A26	672	1.2	-	1	20	3.80	-
		61A26D	702	1.2	-	1	20	3.80	-
		61A92**	673	1.2	-	1	20	<b>3.80</b>	-
		*61A 643E/716**	-	1.2	-	1	20	3.80	-
		61A-BLK**	-	1.3	-	1	20	4.20	-
		61A-W**	-	1.3	-	1	20	<b>4.20</b>	-
		SP61A10B	703	42.5	Yes	25	25	-	102.25
		SP61A3	666	42.5	Yes	25	25	-	102.25
		SP61A5	-	42.5	Yes	25	25	-	102.25
		SP61A14	669	42.5	Yes	25	25	-	102.25
		SP61A92	673	42.5	Yes	25	25	-	102.25
SP61A-BLK	-	20.0	Yes	10	10	-	43.50		
SP61A-W	-	50.0	Yes	25	25	-	108.75		
<b>61</b> <b>Solid Door Stop</b> 3-1/8" Projection 	Brass	61B3	605	1.4	-	1	10	14.00	-
		61B4	606	1.4	-	1	10	14.00	-
		61B5**	609	1.4	-	1	10	14.00	-
		61B10	612	1.4	-	1	10	18.30	-
		61B10B**	613	1.4	-	1	10	18.30	-
		61B15**	619	1.4	-	1	10	18.30	-
		61B15A	620	1.4	-	1	10	18.30	-
		61B26**	625	1.4	-	1	10	18.30	-
		61B26D**	626	1.4	-	1	10	14.00	-
		61B-643E/716	-	1.4	-	1	10	18.30	-
		61B-BLK	622	1.4	-	1	10	18.30	-
		SP61B10B	613	-	Yes	10	10	-	189.50
		SP61B26 (WS.10347)	625	-	Yes	10	10	-	189.50

Lead time exception: \*\* Products are stocked and will typically ship in 3-5 days

Bold pricing indicates item is in stock and available for **Fast Track** and **ProXpress**

MODEL	SUBSTRATE	MODEL NUMBER	BHMA FINISH	WEIGHT	MUST BE ORDERED IN MULTIPLE QTY	MULTIPLE QTY	PACKED PER BOX	LIST PRICE		
								EACH	PACKAGE	
<b>61</b> Solid Door Stop 3-3/16" Projection <i>Continued from previous page</i>	Zinc	61Z-619E	-	4.1	-	1	20	\$3.60	-	
		61Z-643E/716**	-	-	-	1	20	4.70	-	
<b>61 Rubber Tips</b>		RT (WSPART.1075)	-	-	Yes	100	100	-	\$93.30	
<b>FB61</b> Flush Bolt for Wood Door UL 90 Minute Constant Latching Top and Automatic Bottom Bolt  P=Pair (Top half w/automatic bottom bolt) T=Top Bolt Only 	Brass	FB61P-WD US3	605	-	-	1	-	225.60	-	
		FB61P-WD US4	606	-	-	1	-	225.60	-	
		FB61P-WD US10	612	-	-	1	-	225.60	-	
		FB61P-WD US10B	613	-	-	1	-	225.60	-	
	Stainless	FB61P-WD US32	629	-	-	1	-	225.60	-	
		FB61P-WD US32D**	630	-	-	1	-	<b>225.60</b>	-	
		FB61P-WD BLK	-	-	-	1	-	225.60	-	
	Brass	FB61T-WD US3	605	-	-	1	-	116.90	-	
		FB61T-WD US4	606	-	-	1	-	116.90	-	
		FB61T-WD US10	612	-	-	1	-	116.90	-	
		FB61T-WD US10B	613	-	-	1	-	116.90	-	
	Stainless	FB61T-WD US32	629	-	-	1	-	116.90	-	
		FB61T-WD US32D**	630	-	-	1	-	116.90	-	
		FB61T-WD BLK	-	-	-	1	-	116.90	-	
<b>FB62</b> Flush Bolt for Wood Door UL 20 Minute Constant Latching Top w/Auxiliary Fire Latch	Brass	FB62-WD US3	605	-	-	1	-	225.60	-	
		FB62-WD US4	606	-	-	1	-	225.60	-	
		FB62-WD US10	612	-	-	1	-	225.60	-	
		FB62-WD US10B	613	-	-	1	-	225.60	-	
	Stainless	FB62-WD US32	629	-	-	1	-	225.60	-	
		FB62-WD US32D	630	-	-	1	-	225.60	-	
		FB62-WD BLK	-	-	-	1	-	225.60	-	
<b>63</b> Flexible Door Stop 	Steel	63F-605E	632	2.7	-	1	20	1.20	-	
		63F-609E	638	2.7	-	1	20	1.20	-	
		63F-619E**	646	1.8	-	1	20	<b>1.20</b>	-	
		63F-625E	-	1.8	-	1	20	1.20	-	
		63F-626E	-	1.8	-	1	20	1.20	-	
		63F-643E/716**	-	1.8	-	1	20	<b>1.20</b>	-	
		63F-BLK	-	1.8	-	1	20	1.20	-	
		63F-W**	-	1.8	-	1	20	1.20	-	
<b>63 Rubber Tips</b>		RT (WSPART.1075)	-	-	Yes	100	100	-	<b>93.30</b>	
<b>64</b> Door Stop 3-1/4" Projection 	Aluminum	64A3	666	2.3	-	1	20	3.30	-	
		64A10B	703	2.3	-	1	20	3.30	-	
		64A92	673	2.3	-	1	20	3.30	-	
	Brass	64B3	605	-	-	1	10	12.50	-	
		64B4	606	-	-	1	10	13.70	-	
		64B5	609	2.1	-	1	10	16.10	-	
		64B10	612	2.3	-	1	10	16.10	-	
		64B10B	613	2.3	-	1	10	16.10	-	
		64B15	619	2.3	-	1	10	16.10	-	
		64B26	625	2.3	-	1	10	16.10	-	
		64B26D	626	2.3	-	1	10	16.10	-	
		64B-643E/716	-	2.3	-	1	10	16.10	-	
		64B-BLK	622	2.3	-	1	10	16.10	-	
		<b>64 Rubber Tips</b>		RT (WSPART.1075)	-	-	Yes	100	100	-
<b>SR64</b> Door Silencer - Hollow Metal 		SR64 GRY (100/pk)**	-	2.1	-	1	100	<b>36.50</b>	-	
		SR64 GRY - BULK (2500/pk)	-	-	-	1	2,500	553.20	-	
<b>WS65</b> Wall Stop 	Aluminum	WS65 US3AL	666	2.8	-	1	20	5.30	-	
		WS65 US10AL	668	2.1	-	1	20	5.30	-	
		WS65 US10B-AL	703	2.8	-	1	20	5.30	-	
		WS65 US27**	673	-	-	1	20	5.30	-	
		SPWS65 US3AL	666	-	-	Yes	25	25	-	129.75
		SPWS65 US27	673	-	-	Yes	25	25	-	129.75
<b>WS65 Rubber Tips</b>		RT (WSPART.1075)	-	-	Yes	100	100	-	<b>93.30</b>	
<b>SR65</b> Door Silencer - Wood 		SR65 GRY (100/pk)**	-	-	-	1	100	<b>36.50</b>	-	
<b>SR66</b> Door Silencer - Adhesive 		SR66 BRN (100/pk)	-	-	-	1	100	36.50	-	
		SR66 GRY (100/pk)**	-	-	-	1	100	36.50	-	
		SR66 WHT (100/pk)	-	-	-	1	100	36.50	-	

Lead time exception: \*\* Products are stocked and will typically ship in 3-5 days

Bold pricing indicates item is in stock and available for **Fast Track** and **ProXpress**





HINGES  
 CONTINUOUS HINGES  
 PIVOTS  
 Numerical 1-059  
 Numerical 59-437  
 Numerical 438-1021  
 Numerical 1152-8190  
 Numerical 8200-9266

HINGES

CONTINUOUS  
HINGES





PIVOTS

Numerical  
1-059Numerical  
59-437Numerical  
438-1021Numerical  
1152-8190Numerical  
8200-9266

MODEL	SUBSTRATE	MODEL NUMBER	BHMA FINISH	WEIGHT	MUST BE ORDERED IN MULTIPLE QTY	MULTIPLE QTY	PACKED PER BOX	LIST PRICE	
								EACH	PACKAGE
<b>066</b> Casement Fastener 	Aluminum	066A3 RS MS SS	666	-	-	1	10	\$6.90	-
		066A5 RS MS SS	-	-	-	1	10	6.90	-
		066A10B RS MS SS	703	-	-	1	10	6.90	-
		066A14 RS MS SS	669	-	-	1	10	6.90	-
		066A92 RS MS SS	673	-	-	1	10	6.90	-
	Brass	066B3 RS MS SS	605	-	-	1	10	30.60	-
		066B5 RS MS SS	609	-	-	1	10	36.80	-
		066B15 RS MS SS	619	-	-	1	10	38.20	-
		066B26 RS MS SS	625	-	-	1	10	36.80	-
		066B26D RS MS SS	626	-	-	1	10	36.80	-
<b>66</b> Casement Fastener 	Aluminum	66A3 RS MS SS	666	-	-	1	10	8.00	-
		66A5 RS MS SS	-	-	-	1	10	8.00	-
		66A14 RS MS SS	669	-	-	1	10	8.00	-
		66A92 RS MS SS	673	-	-	1	10	8.00	-
	Brass	66B3 RS MS SS	605	-	-	1	10	37.40	-
		66B5 RS MS SS	609	-	-	1	10	37.40	-
		66B15 RS MS SS	619	-	-	1	10	37.40	-
		66B26 RS MS SS	625	-	-	1	10	37.40	-
		66B26D RS MS SS	626	-	-	1	10	37.40	-
		66B643E/716 RS MS SS	-	-	-	1	10	37.40	-
<b>69</b> Hinge Pin Door Stop Door Opening Adjustments 70° - 100° 	Steel	69F3	632	2.6	-	1	20	4.90	-
		69F5	638	2.6	-	1	20	4.90	-
		69F10	639	2.6	-	1	20	4.90	-
		69F10B**	640	2.6	-	1	20	4.90	-
		69F14**	645	2.6	-	1	20	<b>4.90</b>	-
		69F15**	646	2.6	-	1	20	<b>4.90</b>	-
		69F15A	647	2.6	-	1	20	4.90	-
		69F26	651	2.6	-	1	20	4.90	-
		69F26D**	652	2.6	-	1	20	4.90	-
		69F-643E/716	-	2.6	-	1	20	4.90	-
		69F-BLK	-	2.6	-	1	20	4.90	-
		SP69F3	632	82.5	Yes	25	25	-	\$121.75
		SP69F5	635	82.5	Yes	25	25	-	121.75
		SP69F14	645	82.5	Yes	25	25	-	121.75
<b>69 Rubber Tip</b>		09-310	-	-	Yes	100	100	87.00	-
<b>70</b> Hinge Pin Door Stop Door Opening Adjustments 85° - 125°   *Provided with Black Rubber Tip  Picture above for Brass and Zinc Substrates    Picture above for Aluminum Substrates  <i>Continued on next page.</i>	Aluminum	70A3**	666	1.3	-	1	20	2.60	-
		70A4	667	1.3	-	1	20	2.60	-
		70A5**	-	1.3	-	1	20	3.00	-
		70A10	668	1.3	-	1	20	2.60	-
		70A10B**	703	1.3	-	1	20	<b>3.00</b>	-
		70A14**	669	1.3	-	1	20	3.00	-
		70A15**	670	1.3	-	1	20	<b>3.00</b>	-
		70A26	672	1.3	-	1	20	<b>2.60</b>	-
		70A26D	702	1.3	-	1	20	<b>2.60</b>	-
		70A92**	673	1.3	-	1	20	<b>2.60</b>	-
		*70A 643E/716**	-	1.3	-	1	20	<b>3.00</b>	-
		70A-BLK**	-	1.4	-	1	20	3.60	-
		70A-W**	-	1.4	-	1	20	3.60	-
		SP70A3	666	55.0	Yes	25	25	-	66.25
	SP70A5	-	55.0	Yes	25	25	-	75.75	
	SP70A10	668	55.0	Yes	25	25	-	66.25	
	SP70A92	673	55.0	Yes	25	25	-	66.25	
	Brass	70B3	605	1.4	-	1	10	12.90	-
		70B4	606	1.4	-	1	10	12.90	-
		70B5	609	1.4	-	1	10	16.30	-
70B10		612	1.4	-	1	10	16.30	-	
70B10B**		613	1.4	-	1	10	<b>16.30</b>	-	
70B15**		619	1.4	-	1	10	<b>16.30</b>	-	
70B26		625	1.4	-	1	10	16.30	-	
70B26D**		626	1.4	-	1	10	16.30	-	
		70B643E/716	-	1.4	-	1	10	16.30	-
		70B-BLK	622	1.4	-	1	10	16.30	-

Lead time exception: \*\* Products are stocked and will typically ship in 3-5 days

Bold pricing indicates item is in stock and available for **Fast Track** and **ProXpress**

MODEL	SUBSTRATE	MODEL NUMBER	BHMA FINISH	WEIGHT	MUST BE ORDERED IN MULTIPLE QTY	MULTIPLE QTY	PACKED PER BOX	LIST PRICE	
								EACH	PACKAGE
<b>70</b> <b>Hinge Pin Door Stop</b> Door Opening Adjustments 85° - 125°  <i>Continued from previous page.</i>	Zinc	70Z-406E	-	-	-	1	10	\$3.60	-
		70Z-643E/716	-	-	-	1	20	3.60	-
<b>70 Rubber Tips</b>		RT (WSPART.1075)	-	-	Yes	100	100	-	<b>93.30</b>
<b>71</b> <b>Casement Adjuster</b> 	Brass	71B3 10 IN	605	1.7	-	1	2	73.40	-
		71B3 12 IN	605	1.9	-	1	2	79.80	-
		71B26 10 IN	625	1.7	-	1	2	73.40	-
		71B26 12 IN	625	1.9	-	1	2	79.80	-
<b>72</b> <b>Door Saver Residential</b> 	Zinc	72Z-605E	677	-	-	1	50	3.00	-
		72Z-609E	-	-	-	1	50	3.00	-
		72Z-613E	704	-	-	1	50	3.00	-
		72Z-619E **	-	-	-	1	50	3.00	-
		72Z-625E	681	-	-	1	50	3.00	-
		72Z-626E	682	-	-	1	50	3.00	-
		72Z-643E/716	-	-	-	1	50	3.00	-
		72Z-BLK	676	-	-	1	50	3.00	-
		72Z-W	-	-	-	1	50	3.00	-
<b>72 Rubber Tips</b>		RT (WSPART.1075)	-	-	Yes	100	100	-	<b>93.30</b>
<b>COR72</b> Door Coordinator	See page 32								
<b>73</b> <b>Door Saver Residential</b> 	Zinc	73Z-605E	677	-	-	1	25	5.90	-
		73Z-613E	704	-	-	1	25	5.90	-
		73Z-619E	-	-	-	1	25	5.90	-
		73Z-625E	681	-	-	1	25	5.90	-
<b>73 Rubber Tips</b>		RT (WSPART.1075)	-	-	Yes	100	100	-	<b>93.30</b>
<b>90</b> <b>Side Window Lock</b> 	Aluminum	SP90A3	666	45.0	Yes	25	25	-	118.50
<b>CS115</b> <b>Crash Stop</b> 	Steel	CS115 US10B 20 1/2 IN	613	5.0	-	1	5	54.10	-
		CS115 US10B 25 1/2 IN	613	5.5	-	1	5	57.70	-
		CS115 US10B 30 1/2 IN	613	6.0	-	1	5	64.00	-
		CS115 US26D 20 1/2 IN**	626	5.0	-	1	5	<b>54.10</b>	-
		CS115 US26D 25 1/2 IN**	626	5.5	-	1	5	57.70	-
		CS115 US26D 30 1/2 IN**	626	6.0	-	1	5	64.00	-
<b>HB159</b> <b>Handrail Bracket</b> 	Aluminum	HB159 US3AL	666	3.8	-	1	5	18.40	-
		HB159 US27	673	3.8	-	1	5	<b>18.40</b>	-

HINGES  
 CONTINUOUS HINGES  
 PIVOTS  
 Numerical 1-059  
 Numerical 59-437  
 Numerical 438-1021  
 Numerical 1152-8190  
 Numerical 8200-9266

Lead time exception: \*\* Products are stocked and will typically ship in 3-5 days

Bold pricing indicates item is in stock and available for **Fast Track** and **ProXpress**





HINGES

CONTINUOUS  
HINGES

PIVOTS

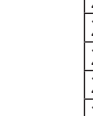
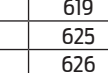

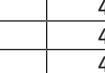
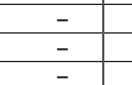

Numerical  
1-059Numerical  
59-437Numerical  
438-1021Numerical  
1152-8190Numerical  
8200-9266

MODEL	SUBSTRATE	MODEL NUMBER	BHMA FINISH	WEIGHT	MUST BE ORDERED IN MULTIPLE QTY	MULTIPLE QTY	PACKED PER BOX	LIST PRICE	
								EACH	PACKAGE
<b>218*</b> Finger Pull 1" Diameter 	Brass	218B3	605	1.6	Yes	4	40	-	\$11.40
		218B5	609	1.6	Yes	4	40	-	21.80
		218B10	612	1.6	Yes	4	40	-	21.80
		218B10B	613	1.6	Yes	4	40	-	21.80
		218B15	619	1.6	Yes	4	40	-	11.40
		218B26	625	1.6	Yes	4	40	-	15.50
		218B26D	626	1.6	Yes	4	40	-	15.50
		218B-643E/716	-	1.6	Yes	4	40	-	15.50
218B-BLK	622	1.6	Yes	4	40	-	15.50		
<b>221</b> Flush Pull 2-1/8" Diameter 	Brass	221B3	605	1.0	-	1	20	\$4.10	
		221B4	606	1.0	-	1	20	4.10	
		221B5	609	1.0	-	1	20	4.10	
		221B10	612	1.0	-	1	20	5.70	
		221B10B**	613	1.0	-	1	20	<b>4.90</b>	
		221B15**	619	1.0	-	1	20	4.70	
		221B26**	625	1.0	-	1	20	4.90	
		221B26D**	626	1.0	-	1	20	<b>4.90</b>	
		221B-643E/716	716	1.0	-	1	20	4.90	
221B-BLK	622	1	-	1	20	4.90			
<b>222</b> Flush Pull 3-1/8" High x 1-5/8" Wide x 7/16" 	Brass	222B3	605	1.5	-	1	10	24.10	-
		222B4	606	1.5	-	1	10	24.10	-
		222B5	609	1.5	-	1	10	27.60	-
		222B10	612	1.5	-	1	10	27.60	-
		222B10B**	613	1.5	-	1	10	27.60	-
		222B15**	619	1.5	-	1	10	26.70	-
		222B26	625	1.5	-	1	10	27.60	-
		222B26D**	626	1.5	-	1	10	<b>27.60</b>	-
		222B-643E/716	-	1.5	-	1	10	27.60	-
		222B-BLK	622	1.5	-	1	10	27.60	-
<b>223</b> Flush Pull 3-9/16" High x 1-5/16" Wide x 1/2" Deep 	Brass	223B3	605	0.7	-	1	10	7.40	-
		223B4	606	0.7	-	1	10	7.40	-
		223B10	612	0.7	-	1	10	8.30	-
		223B10B**	613	0.7	-	1	10	8.30	-
		223B15**	619	0.7	-	1	10	7.90	-
		223B26	625	0.7	-	1	10	8.30	-
		223B26D	626	0.7	-	1	10	<b>8.30</b>	-
		223B-643E/716	-	0.7	-	1	10	8.30	-
		223B-BLK	622	0.7	-	1	10	8.30	-
<b>227</b> Flush Pull 3-5/8" High x 1-3/4" Wide x 9/16" Deep 	Brass	227B3	605	1.0	-	1	10	11.00	-
		227B4	606	1.0	-	1	10	11.00	-
		227B5	609	1.0	-	1	10	12.30	-
		227B10	612	1.0	-	1	10	12.80	-
		227B10B**	613	1.0	-	1	10	12.80	-
		227B15**	619	1.0	-	1	10	12.30	-
		227B26	625	1.0	-	1	10	12.80	-
		227B26D**	626	1.0	-	1	10	<b>12.80</b>	-
		227B-643E/716	-	1	-	1	10	12.80	-
227B-BLK	622	1	-	1	10	12.80	-		
<b>230</b> Door Edge Pull 	Brass	230B3	605	1.3	-	1	10	15.70	-
		230B4	606	1.3	-	1	10	15.70	-
		230B5	609	1.3	-	1	10	17.10	-
		230B10	612	1.3	-	1	10	15.70	-
		230B10B**	613	1.3	-	1	10	17.90	-
		230B15**	619	1.3	-	1	10	17.10	-
		230B26**	625	1.3	-	1	10	17.90	-
		230B26D**	626	1.3	-	1	10	<b>17.90</b>	-
		230B-643E/716	-	1.3	-	1	10	17.90	-
		230B-BLK	622	1.3	-	1	10	17.90	-

\* NOTE: 218 Finger Pull priced at 4 per bag. Qty of 10 = 40 pieces.

Lead time exception: \*\* Products are stocked and will typically ship in 3-5 days

Bold pricing indicates item is in stock and available for **Fast Track** and **ProXpress**

MODEL	SUBSTRATE	MODEL NUMBER	BHMA FINISH	WEIGHT	MUST BE ORDERED IN MULTIPLE QTY	MULTIPLE QTY	PACKED PER BOX	LIST PRICE		
								EACH	PACKAGE	
<b>253</b> Decorative Heavy Duty Surface Bolt 	Brass	253B3 8 IN US MS	605	-	-	1	5	\$72.30	-	
		253B10B 8 IN US MS	613	-	-	1	5	83.20	-	
		253B26D 8 IN US MS	626	-	-	1	5	83.20	-	
		253B3 12 IN US MS	605	-	-	1	5	95.10	-	
		253B10B 12 IN US MS	613	-	-	1	5	101.70	-	
		253B26D 12 IN US MS	626	-	-	1	5	101.70	-	
<b>253</b> Mortise Strike Package	Brass	09-22-605	605	-	-	1	1	9.60	-	
		09-22-613	613	-	-	1	1	9.60	-	
		09-22-626	626	-	-	1	1	9.60	-	
<b>253</b> Angle Strike Package	Brass	09-33-605	605	-	-	1	1	21.40	-	
		09-33-613	613	-	-	1	1	21.40	-	
		09-33-626	626	-	-	1	1	21.40	-	
<b>261</b> Manual Flush Bolt 	Brass	261B3	605	2.4	-	1	10	22.00	-	
		261B5	609	2.4	-	1	10	24.20	-	
		261B10B	613	2.4	-	1	10	27.80	-	
		261B15	619	2.4	-	1	10	25.20	-	
		261B26	625	2.4	-	1	10	25.20	-	
		261B26D	626	2.4	-	1	10	25.20	-	
		SP261B3	605	3.8	-	Yes	15	15	-	\$332.55
		SP261B5	619	0.0	-	Yes	15	15	-	378.60
		<b>262</b> Manual Flush Bolt 	Brass	262B3	605	3.6	-	1	10	<b>32.30</b>
262B5	609			3.6	-	1	10	35.60	-	
262B10B	613			3.6	-	1	10	<b>37.20</b>	-	
262B15	619			3.6	-	1	10	37.20	-	
262B26	625			3.6	-	1	10	37.20	-	
262B26D**	626			3.6	-	1	10	<b>37.20</b>	-	
<b>262</b> Strike Package		09-40-605	605	-	-	1	1	5.90	-	
		09-40-613	613	-	-	1	1	5.90	-	
		09-40-626	626	-	-	1	1	5.90	-	
<b>265</b> Manual Flush Bolt 	Brass	265B3	605	2.1	-	1	10	25.10	-	
		265B5	609	2.1	-	1	10	27.60	-	
		265B10B	613	2.1	-	1	10	29.00	-	
		265B15	619	2.1	-	1	10	29.00	-	
		265B26	625	2.1	-	1	10	29.00	-	
		265B26D	626	2.1	-	1	10	29.00	-	
<b>265</b> Strike Package		09-40-605	605	-	-	1	1	5.90	-	
		09-40-613	613	-	-	1	1	5.90	-	
		09-40-626	626	-	-	1	1	5.90	-	
<b>299</b> Center Rescue Strike All Strikes Double Lip. Must be used with Center Hung Pivots. Strike Dimension Options: 7" Stk = 5 3/4" x 2 3/4" Frame 8" Stk = 6 3/4" x 2 3/4" Frame		299RS-7	630	-	-	1	-	56.70	-	
		299RS-8	630	-	-	1	-	56.70	-	
<b>299</b> Offset Rescue Strike All Strikes Double Lip. Must be used with Center Hung Pivots. Strike Dimension Options: 7" Stk = 5 3/4" x 2 3/4" Frame 8" Stk = 6 3/4" x 2 3/4" Frame		299RB-7	630	-	-	1	-	56.70	-	
		299RB-8	630	-	-	1	-	56.70	-	
<b>299</b> Rescue Emergency Stop (Stop Assembly Only)		299AL	630	-	-	1	-	120.00	-	
<b>299</b> Rescue Center Emergency Stop Strike (Part) All Strikes Double Lip. Must be used with Center Hung Pivots. Strike Dimension Options: 7" Stk = 5 3/4" x 2 3/4" Frame 8" Stk = 6 3/4" x 2 3/4" Frame		299ES-7	630	-	-	1	-	75.50	-	
		299ES-8	630	-	-	1	-	75.50	-	

Lead time exception: \*\* Products are stocked and will typically ship in 3-5 days

Bold pricing indicates item is in stock and available for **Fast Track** and **ProXpress**







HINGES  
 CONTINUOUS HINGES  
 PIVOTS  
 Numerical 1-059  
 Numerical 59-437  
 Numerical 438-1021  
 Numerical 1152-8190  
 Numerical 8200-9266

HINGES  
 CONTINUOUS HINGES  
 PIVOTS  
 Numerical 1-059  
 Numerical 59-437  
 Numerical 438-1021  
 Numerical 1152-8190  
 Numerical 8200-9266

MODEL	SUBSTRATE	MODEL NUMBER	BHMA FINISH	WEIGHT	MUST BE ORDERED IN MULTIPLE QTY	MULTIPLE QTY	PACKED PER BOX	LIST PRICE	
								EACH	PACKAGE
<b>299</b> <b>Rescue Offset Emergency Stop Strike (Part)</b> All Strikes Double Lip. Must be used with Center Hung Pivots. Strike Dimension Options: 7" Stk = 5 3/4" x 2 3/4" Frame 8" Stk = 6 3/4" x 2 3/4" Frame		299EB-7	630	-	-	1	-	\$75.50	-
		299EB-8	630	-	-	1	-	75.50	-
<b>299</b> <b>Rescue Center Emergency Strike Assembly</b> All Strikes Double Lip. Must be used with Center Hung Pivots. Strike Dimension Options: 7" Stk = 5 3/4" x 2 3/4" Frame 8" Stk = 6 3/4" x 2 3/4" Frame		299AS-7**	630			1	-	195.50	-
		299AS-8	630	-	-	1	-	195.50	-
<b>299</b> <b>Rescue Offset Emergency Strike Assembly</b> All Strikes Double Lip. Must be used with Center Hung Pivots. Strike Dimension Options: 7" Stk = 5 3/4" x 2 3/4" Frame 8" Stk = 6 3/4" x 2 3/4" Frame		299AB-7	630	-	-	1	-	195.50	-
		299AB-8	630	-	-	1	-	195.50	-
<b>325</b> <b>Magnetic Catch</b>	Aluminum	325A3	666	1.9	-	1	20	3.40	-
		325A92**	673	1.9	-	1	20	<b>3.40</b>	-
<b>326</b> <b>Heavy Duty Magnetic Catch</b>	Aluminum	326A3	666	3.0	-	1	10	3.40	-
		326A92**	673	3.0	-	1	10	<b>3.40</b>	-
<b>327</b> <b>Magnetic Catch Dual Triple Pole</b>	Aluminum	327A3**	666	4.0	-	1	10	16.20	-
		327A92**	673	4.0	-	1	10	<b>16.20</b>	-
<b>330</b> <b>Double Roller Catch</b>	Steel	330F2C	604	1.1	-	1	30	2.10	-
		SP330F2C	604	2.3	Yes	50	50	-	\$102.70
<b>335</b> <b>Roller Catch Adjustable</b>	Brass	335B3	605	1.6	-	1	10	16.20	-
		335B5	609	1.6	-	1	10	19.30	-
		335B10	612	1.6	-	1	10	19.30	-
		335B10B**	613	1.6	-	1	10	<b>19.30</b>	-
		335B15**	619	1.6	-	1	10	20.20	-
		335B26**	625	1.6	-	1	10	19.30	-
		335B26D**	626	1.6	-	1	10	19.30	-
		335B-643E/716	-	1.6	-	1	10	19.30	-
<b>335</b> <b>Strike &amp; Mounting Package</b>		09-45-613	613	-	-	1	1	7.20	-
		09-45-619	619	-	-	1	1	7.20	-
<b>336</b> <b>Roller Catch Adjustable</b>	Brass	336B3	605	1.6	-	1	10	14.70	-
		336B4	606	1.6	-	1	10	19.30	-
		336B5	609	1.6	-	1	10	19.30	-
		336B10	612	1.6	-	1	10	19.30	-
		336B10B**	613	1.6	-	1	10	19.30	-
		336B15	619	1.6	-	1	10	19.30	-
		336B26	625	1.6	-	1	10	19.30	-
		336B26D**	626	1.6	-	1	10	17.90	-
		336B-643E/716	-	1.6	-	1	10	19.30	-
<b>336</b> <b>Strike &amp; Mounting Package</b>		09-47-605	605	-	-	1	1	7.80	-
		09-47-613	613	-	-	1	1	7.80	-
		09-47-626	626	-	-	1	1	7.80	-

Lead time exception: \*\* Products are stocked and will typically ship in 3-5 days

Bold pricing indicates item is in stock and available for **Fast Track** and **ProXpress**

MODEL	SUBSTRATE	MODEL NUMBER	BHMA FINISH	WEIGHT	MUST BE ORDERED IN MULTIPLE QTY	MULTIPLE QTY	PACKED PER BOX	LIST PRICE	
								EACH	PACKAGE
<b>345</b> <b>Ball Catch</b> 	Brass	345B3**	605	0.8	-	1	10	\$9.50	-
		345B5	609	0.8	-	1	10	10.40	-
		345B10	612	0.8	-	1	10	10.80	-
		345B10B	613	0.8	-	1	10	10.80	-
		345B15	619	0.8	-	1	10	11.10	-
		345B26	625	0.8	-	1	10	10.80	-
<b>347</b> <b>Ball Catch</b> 	Brass	347B3**	605	1.9	-	1	10	14.10	-
		347B4	606	1.9	-	1	10	14.10	-
		347B5	609	1.9	-	1	10	15.20	-
		347B10	612	1.9	-	1	10	16.00	-
		347B10B**	613	1.9	-	1	10	<b>16.00</b>	-
		347B15**	619	1.9	-	1	10	<b>15.20</b>	-
		347B26**	625	1.9	-	1	10	<b>16.00</b>	-
		347B26D**	626	1.9	-	1	10	<b>16.00</b>	-
		347B-643E/716	-	1.9	-	1	10	16.00	-
		347B-BLK	622	1.9	-	1	10	16.00	-
<b>347</b> <b>Strike &amp; Mounting Package</b>		09-53-605	605	-	-	1	10	7.20	-
		09-53-613	613	-	-	1	10	7.20	-
		09-53-619	619	-	-	1	10	7.20	-
		09-53-625	625	-	-	1	10	7.20	-
		09-53-626	626	-	-	1	10	7.20	-
<b>349</b> <b>Ball Catch</b> 	Brass	349B3	605	1.8	-	1	10	14.10	-
		349B4	606	1.8	-	1	10	14.10	-
		349B5	609	1.8	-	1	10	16.70	-
		349B10	612	1.8	-	1	10	16.70	-
		349B10B**	613	1.8	-	1	10	16.70	-
		349B15**	619	1.8	-	1	10	17.30	-
		349B26	625	1.8	-	1	10	16.70	-
		349B26D**	626	1.8	-	1	10	<b>16.70</b>	-
		349B-643E/716	-	1.8	-	1	10	16.70	-
<b>349</b> <b>Strike &amp; Mounting Package</b>		09-61-605	-	-	-	1	1	7.20	-
		09-61-613	-	-	-	1	1	7.20	-
		09-61-626	-	-	-	1	1	7.20	-
<b>FB358</b> <b>Manual Flush Bolt Wood Door UL 90 Minutes</b> 	Brass	FB358 US3	605	1.7	-	1	2	41.50	-
		FB358 US4	606	1.7	-	1	2	41.50	-
		FB358 US10	612	1.7	-	1	2	41.50	-
		FB358 US10B**	613	1.7	-	1	2	<b>41.50</b>	-
		FB358 US15	619	1.8	-	1	5	41.50	-
		FB358 US26	625	1.7	-	1	2	41.50	-
		FB358 US26D**	626	1.7	-	1	2	<b>41.50</b>	-
		FB358 643E/716	-	1.7	-	1	2	41.50	-
FB358 BLK	622	1.7	-	1	2	41.50	-		
<b>SB360</b> <b>Surface Bolt Heavy Duty, UL Listed</b>	Steel	SB360 US2C 12 IN**	604	3.5	-	1	1	<b>122.80</b>	-
<b>SB360 - MS Strike Package</b>		09-82-604	604	-	-	1	1	27.30	-
<b>SB360 - SNB Package</b>		09-350-604	604	-	-	1	1	22.40	-
<b>401/402CVX</b> <b>Wall Bumper</b> w/Plastic Anchor Convex Rubber, with drywall and masonry anchors. 	Brass	WS401/402 CVX US3	605	2.9	-	1	10	18.50	-
		WS401/402 CVX US4	606	2.9	-	1	10	21.40	-
		WS401/402 CVX US10	612	2.9	-	1	10	21.40	-
		WS401/402 CVX US10B	613	2.9	-	1	10	21.40	-
		WS401/402 CVX US15	619	2.9	-	1	10	21.40	-
		WS401/402 CVX US26	625	2.9	-	1	10	21.40	-
		WS401/402 CVX US26D**	626	2.9	-	1	10	<b>21.40</b>	-
<b>401/402CCV</b> <b>Wall Bumper</b> w/Plastic Anchor Concave Rubber, with drywall and masonry anchors. 	Brass	WS401/402 CCV US3	605	3.1	-	1	10	18.50	-
		WS401/402 CCV US4	606	3.1	-	1	10	21.40	-
		WS401/402 CCV US10	612	3.1	-	1	10	21.40	-
		WS401/402 CCV US10B**	613	3.1	-	1	10	21.40	-
		WS401/402 CCV US15	619	3.1	-	1	10	21.40	-
		WS401/402 CCV US26	625	3.1	-	1	10	21.40	-
		WS401/402 CCV US26D**	626	3.1	-	1	10	<b>21.40</b>	-

HINGES  
 CONTINUOUS HINGES  
 PIVOTS  
 Numerical 1-059  
 Numerical 59-437  
 Numerical 438-1021  
 Numerical 1152-8190  
 Numerical 8200-9266

Lead time exception: \*\* Products are stocked and will typically ship in 3-5 days





Bold pricing indicates item is in stock and available for **Fast Track** and **ProXpress**

HINGES

CONTINUOUS  
HINGES





PIVOTS

Numerical  
1-059Numerical  
59-437Numerical  
438-1021Numerical  
1152-8190Numerical  
8200-9266

MODEL	SUBSTRATE	MODEL NUMBER	BHMA FINISH	WEIGHT	MUST BE ORDERED IN MULTIPLE QTY	MULTIPLE QTY	PACKED PER BOX	LIST PRICE	
								EACH	PACKAGE
<b>WS404-CVX</b> Small Wall Stop Convex Rubber 1" Base Diameter 	Brass	WS404 US3	605	1.0	-	1	20	\$6.50	-
		WS404 US4	606	1.0	-	1	20	7.70	-
		WS404 US5	609	1.0	-	1	20	7.70	-
		WS404 US10	612	1.0	-	1	20	7.70	-
		WS404 US10B	613	1.0	-	1	20	7.70	-
		WS404 US15	619	1.0	-	1	20	8.00	-
		WS404 US26	625	1.0	-	1	20	7.70	-
		WS404 US26D**	626	1.0	-	1	20	<b>7.70</b>	-
		WS404 643E/716	-	1	-	1	20	7.70	-
		WS404 BLK	622	1	-	1	20	7.70	-
<b>405</b> Coat and Hat Hook 	Aluminum	405A3	666	1.5	-	1	20	2.80	-
		405A4	667	1.5	-	1	20	2.80	-
		405A5	-	1.5	-	1	20	2.80	-
		405A10	668	1.5	-	1	20	2.80	-
		405A10B	703	1.5	-	1	20	2.80	-
		405A14	669	1.5	-	1	20	2.80	-
		405A92**	673	1.5	-	1	20	<b>2.80</b>	-
<b>406/407CVX</b> Wall Stop w/Plastic Anchor Convex Rubber, with drywall and masonry anchors. 	Brass	WS406/407CVX US3	605	1.8	-	1	10	4.40	-
		WS406/407CVX US4	606	1.8	-	1	10	4.40	-
		WS406/407CVX US5	609	1.8	-	1	10	5.00	-
		WS406/407CVX US10	612	1.8	-	1	10	5.00	-
		WS406/407CVX US10B**	613	1.8	-	1	10	<b>5.00</b>	-
		WS406/407CVX US15**	619	1.8	-	1	10	5.00	-
		WS406/407CVX US26**	625	1.8	-	1	10	5.00	-
		WS406/407CVX US26D**	626	1.8	-	1	10	4.40	-
		WS406/407CVX 643E/716	-	1.8	-	1	10	5.00	-
		WS406/407CVX BLK	622	1.8	-	1	10	5.00	-
Stainless	WS406/407CVX US32D**	630	1.8	-	1	10	<b>3.60</b>	-	
<b>406/407CCV</b> Wall Stop w/Plastic Anchor Concave Rubber, with drywall and masonry anchors. 	Brass	WS406/407CCV US3**	605	2.0	-	1	10	<b>4.40</b>	-
		WS406/407CCV US4**	606	2.0	-	1	10	4.40	-
		WS406/407CCV US5	609	1.8	-	1	10	5.00	-
		WS406/407CCV US10**	612	2.0	-	1	10	<b>5.00</b>	-
		WS406/407CCV US10B**	613	2.0	-	1	10	<b>5.00</b>	-
		WS406/407CCV US15**	619	2.0	-	1	10	5.00	-
		WS406/407CCV US26**	625	2.0	-	1	10	5.00	-
		WS406/407CCV US26D**	626	2.0	-	1	10	4.40	-
		WS406/407CCV 643E/716	-	2	-	1	10	5.00	-
		WS406/407CCV BLK	622	2	-	1	10	5.00	-
Stainless	WS406/407CCV US32D**	630	2.0	-	1	10	<b>3.60</b>	-	

Lead time exception: \*\* Products are stocked and will typically ship in 3-5 days

Bold pricing indicates item is in stock and available for **Fast Track** and **ProXpress**







MODEL	SUBSTRATE	MODEL NUMBER	BHMA FINISH	WEIGHT	MUST BE ORDERED IN MULTIPLE QTY	MULTIPLE QTY	PACKED PER BOX	LIST PRICE		
								EACH	PACKAGE	
<b>FS410</b> Universal Floor Dome Stop		FS410 US3	605	3.0		1		\$30.30	-	
		FS410 US15	619	3.0		1		25.60	-	
		FS410 US26	625	3.0		1		25.60	-	
		FS410 US26D**	626	3.0		1		25.60	-	
		FS410 643E/716	-	3.0		1		25.60	-	
		FS410 BLK	622	3.0		1		25.60	-	
<b>411</b> Wall Stop Adhesive Back	Rubber	411R-W**	-	1.1	-	1	20	<b>3.30</b>	-	
<b>430</b> Floor Door Stop 	Aluminum	SP430A3	666	1.9	Yes	25	25	-	\$76.25	
		SP430A5	-	1.9	Yes	25	25	-	79.25	
		SP430A14	669	1.9	Yes	25	25	-	79.25	
		SP430A92	673	1.9	Yes	25	25	-	76.25	
	Brass	430 US3	605	1.8	-	1	10	17.30	-	
		430 US4	606	1.8	-	1	10	16.00	-	
		430 US5	609	1.8	-	1	10	20.40	-	
		430 US10B	613	1.8	-	1	10	20.40	-	
		430 US15	619	1.8	-	1	10	21.40	-	
		430 US26	625	1.8	-	1	10	20.40	-	
430 US26D		626	1.8	-	1	10	20.40	-		
<b>430 Rubber Tip</b>	Rubber	RT (WSPART.1075)	-	-	Yes	100	100	-	<b>93.30</b>	
<b>FS434</b> Angle Door Stop	Steel	FS434 US2C**	604	4.0	-	1	10	<b>10.00</b>	-	
<b>FS434 Rubber Tip</b>		09-318	-	-	-	1	1	4.70	-	
<b>R435</b> Riser For 436 Door Stop 	Aluminum	R435 1/4 IN	-	2.1	-	1	20	7.00	-	
		R435 3/8 IN	-	2.6	-	1	20	7.00	-	
		R435 1/2 IN	-	2.9	-	1	20	<b>7.00</b>	-	
		R435 5/8 IN	-	3.3	-	1	20	7.00	-	
		R435 3/4 IN	-	3.2	-	1	20	7.00	-	
		R435 7/8 IN	-	3.2	-	1	20	7.00	-	
		R435 1 IN	-	3.1	-	1	20	7.00	-	
<b>FS436</b> Floor Dome Stop 1" Height 	Brass	FS436 US3	605	2.2	-	1	10	<b>7.40</b>	-	
		FS436 US4	606	2.2	-	1	10	7.40	-	
		FS436 US5	609	2.2	-	1	10	7.40	-	
		FS436 US10	612	2.2	-	1	10	8.50	-	
		FS436 US10B**	613	2.2	-	1	10	<b>8.50</b>	-	
		FS436 US15**	619	2.2	-	1	10	<b>8.50</b>	-	
		FS436 US26**	625	2.2	-	1	10	<b>7.70</b>	-	
		FS436 US26D**	626	2.2	-	1	10	<b>6.20</b>	-	
		FS436 643E/716	-	2.2	-	1	10	8.40	-	
		FS436 BLK	622	2.2	-	1	10	8.40	-	
	SPFS436US26D	626	2.5	Yes	10	10	-	62.10		
	Aluminum	FS436 US28**	628	-	-	-	1	10	<b>5.70</b>	-
		SPFS436US28	628	-	-	Yes	15	15	-	84.75
<b>R437</b> Riser For 438 Door Stop 	Aluminum	R437 1/4 IN	-	2.0	-	1	10	7.50	-	
		R437 3/8 IN	-	2.0	-	1	10	7.50	-	
		R437 1/2 IN	-	2.0	-	1	10	7.50	-	
		R437 5/8 IN	-	2.0	-	1	10	7.50	-	
		R437 3/4 IN	-	2.2	-	1	10	7.50	-	
		R437 1 IN	-	2.3	-	1	10	7.50	-	

HINGES  
 CONTINUOUS HINGES  
 PIVOTS  
 Numerical 1-059  
 Numerical 59-437  
 Numerical 438-1021  
 Numerical 1152-8190  
 Numerical 8200-9266

Lead time exception: \*\* Products are stocked and will typically ship in 3-5 days







Bold pricing indicates item is in stock and available for **Fast Track** and **ProXpress**



MODEL	SUBSTRATE	MODEL NUMBER	BHMA FINISH	WEIGHT	MUST BE ORDERED IN MULTIPLE QTY	MULTIPLE QTY	PACKED PER BOX	LIST PRICE		
								EACH	PACKAGE	
<b>FS438</b> <b>Floor Dome Stop</b> 13/8" Height 	Brass	FS438 US3	605	2.7	-	1	10	\$8.80	-	
		FS438 US4	606	2.7	-	1	10	8.80	-	
		FS438 US5	609	2.7	-	1	10	8.80	-	
		FS438 US10	612	2.7	-	1	10	10.00	-	
		FS438 US10B**	613	2.7	-	1	10	<b>10.00</b>	-	
		FS438 US15	619	2.7	-	1	10	12.70	-	
		FS438 US26	625	2.7	-	1	10	<b>9.40</b>	-	
		FS438 US26D**	626	2.7	-	1	10	<b>6.90</b>	-	
		FS438 643E/716	-	2.7	-	1	10	10.00	-	
	FS438 BLK	622	2.7	-	1	10	10.00	-		
	Aluminum	FS438 US28**	628	1.6	-	1	10	<b>6.80</b>	-	
<b>FS439</b> 	Zinc	FS439 US3	677	2.2	-	1	10	12.90	-	
		FS439 US4	678	2.2	-	1	10	12.90	-	
		FS439 US10B**	704	2.2	-	1	10	13.90	-	
		FS439 US15	-	2.2	-	1	10	12.90	-	
		FS439 US26	681	2.2	-	1	10	13.90	-	
		FS439 US26D**	682	2.2	-	1	10	11.40	-	
		FS439 643E/716	-	2.2	-	1	10	13.90	-	
		FS439 BLK	676	2.2	-	1	10	13.90	-	
			Stainless	FS439 US32D**	630	2.2	-	1	10	18.70
	<b>FS441</b> <b>Floor Stop</b> Now furnished with wood and masonry fasteners 	Brass	FS441 US3	605	1.1	-	1	2	25.60	-
FS441 US4			606	1.1	-	1	2	29.30	-	
FS441 US5			609	1.1	-	1	2	27.40	-	
FS441 US10			612	1.1	-	1	2	29.30	-	
FS441 US10B**			613	1.1	-	1	2	<b>27.40</b>	-	
FS441 US15			619	1.1	-	1	2	35.30	-	
FS441 US26			625	1.1	-	1	2	35.30	-	
FS441 US26D**			626	1.1	-	1	2	<b>24.90</b>	-	
FS441 643E/716			-	1.1	-	1	2	35.30	-	
FS441 BLK		622	1.1	-	1	2	27.40	-		
<b>FS441 Rubber Tip</b>		09-315	-	-	-	1	1	2.50	-	
<b>WS443</b> <b>Wall Door Stop</b> for Masonry Mounting 	Brass	WS443 US3	605	1.5	-	1	2	39.80	-	
		WS443 US4	606	1.5	-	1	2	49.60	-	
		WS443 US10	612	1.5	-	1	2	47.90	-	
		WS443 US10B	613	1.5	-	1	2	47.90	-	
		WS443 US15	619	1.5	-	1	2	49.60	-	
		WS443 US26	625	1.5	-	1	2	47.90	-	
		WS443 US26D**	626	1.5	-	1	2	47.90	-	
		WS443 643E/716	-	1.5	-	1	2	49.60	-	
		WS443 BLK	622	1.5	-	1	2	47.90	-	
	<b>WS443 Rubber Tip</b>		09-316	-	-	-	1	1	2.50	-
<b>FS444</b> <b>Floor Stop</b> for Masonry Mounting 	Brass	FS444 US3	605	2.0	-	1	2	30.40	-	
		FS444 US4	606	2.0	-	1	2	30.40	-	
		FS444 US10	612	2.0	-	1	2	30.40	-	
		FS444 US10B**	613	2.0	-	1	2	<b>35.80</b>	-	
		FS444 US15	619	2.0	-	1	2	38.90	-	
		FS444 US26	625	2.0	-	1	2	30.40	-	
		FS444 US26D**	626	2.0	-	1	2	<b>29.30</b>	-	
		FS444 643E/716	-	2.0	-	1	2	35.80	-	
		FS444 BLK	622	2.0	-	1	2	30.40	-	
	<b>FS444 Rubber Tip</b>		09-316	-	-	-	1	1	2.50	-
<b>WS445</b> <b>Wall Door Stop</b> w/Heavy Duty Holder for Masonry Mounting 	Brass	WS445 US3	605	1.9	-	1	2	63.10	-	
		WS445 US4	606	1.9	-	1	2	75.80	-	
		WS445 US10	612	1.9	-	1	2	75.80	-	
		WS445 US10B	613	1.9	-	1	2	75.80	-	
		WS445 US15	619	1.9	-	1	2	78.80	-	
		WS445 US26	625	1.9	-	1	2	75.80	-	
		WS445 US26D**	626	1.9	-	1	2	<b>75.80</b>	-	
		WS445 643E/716	-	1.9	-	1	2	78.80	-	
		WS445 BLK	622	1.9	-	1	2	75.80	-	
	<b>WS445 Rubber Tip</b>		09-316	-	-	-	1	1	2.50	-
<b>FS446</b> <b>Floor Stop</b> w/Heavy Duty Holder for Masonry Mounting 	Brass	FS446 US3	605	2.4	-	1	2	60.20	-	
		FS446 US4	606	2.4	-	1	2	60.20	-	
		FS446 US10	612	2.4	-	1	2	60.20	-	
		FS446 US10B**	613	2.4	-	1	2	<b>53.60</b>	-	
		FS446 US15	619	2.4	-	1	2	55.70	-	
		FS446 US26	625	2.4	-	1	2	60.20	-	
		FS446 US26D**	626	2.4	-	1	2	<b>42.80</b>	-	
		FS446 643E/716	-	2.4	-	1	2	60.20	-	
		FS446 BLK	622	2.4	-	1	2	60.20	-	
		Aluminum	FS446 US28	628	1.3	-	1	2	30.80	-
<b>FS446 Rubber Tip</b>		09-316	-	-	-	1	1	2.50	-	

Lead time exception: \*\* Products are stocked and will typically ship in 3-5 days







Bold pricing indicates item is in stock and available for **Fast Track** and **ProXpress**

MODEL	SUBSTRATE	MODEL NUMBER	BHMA FINISH	WEIGHT	MUST BE ORDERED IN MULTIPLE QTY	MULTIPLE QTY	PACKED PER BOX	LIST PRICE	
								EACH	PACKAGE
<b>WS447</b> Heavy Duty Wall Door Stop for Drywall Mounting 	Brass	WS447 US3	605	1.3	-	1	2	\$36.20	-
		WS447 US4	606	1.3	-	1	2	43.50	-
		WS447 US10	612	1.3	-	1	2	43.50	-
		WS447 US10B	613	1.3	-	1	2	43.50	-
		WS447 US15	619	1.3	-	1	2	45.20	-
		WS447 US26	625	1.3	-	1	2	43.50	-
		WS447 US26D**	626	1.3	-	1	2	<b>43.50</b>	-
		WS447 643E/716	-	1.3	-	1	2	36.30	-
		WS447 BLK	622	1.3	-	1	2	34.90	-
<b>WS447 Rubber Tip</b>		09-316	-	-	-	1	1	2.50	-
<b>FS448</b> Floor Door Stop Heavy Duty for Wood Mounting 	Brass	FS448 US3	605	1.9	-	1	2	34.10	-
		FS448 US4	606	1.9	-	1	2	34.10	-
		FS448 US5	609	1.9	-	1	2	39.60	-
		FS448 US10	612	1.9	-	1	2	34.10	-
		FS448 US10B**	613	1.9	-	1	2	<b>33.00</b>	-
		FS448 US15	619	1.9	-	1	2	42.80	-
		FS448 US26	625	1.9	-	1	2	42.80	-
		FS448 US26D**	626	1.9	-	1	2	<b>34.10</b>	-
		FS448 643E/716	-	1.9	-	1	2	42.80	-
		FS448 BLK	622	1.9	-	1	2	42.80	-
	Aluminum	FS448 US28	628	0.8	-	1	2	25.00	-
<b>FS448 Rubber Tip</b>		09-316	-	-	-	1	1	2.50	-
<b>WS449</b> Wall Door Stop w/Heavy Duty Holder for Drywall Mounting 	Brass	WS449 US3	605	1.6	-	1	2	60.30	-
		WS449 US4	606	1.6	-	1	2	72.30	-
		WS449 US10	612	1.6	-	1	2	72.30	-
		WS449 US10B	613	1.6	-	1	2	72.30	-
		WS449 US15	619	1.6	-	1	2	75.20	-
		WS449 US26	625	1.6	-	1	2	72.30	-
		WS449 US26D**	626	1.6	-	1	2	72.30	-
		WS449 643E/716	-	1.6	-	1	2	75.20	-
		WS449 BLK	622	1.6	-	1	2	72.30	-
	Aluminum	WS449 US28	628	0.9	-	1	2	50.50	-
<b>WS449 Rubber Tip</b>		09-316	-	-	-	1	1	2.50	-
<b>FS450</b> Floor Door Stop w/Heavy Duty Holder for Wood Mounting 	Brass	FS450 US3	605	2.2	-	1	2	64.00	-
		FS450 US4	606	2.2	-	1	2	64.00	-
		FS450 US10	612	2.2	-	1	2	64.00	-
		FS450 US10B	613	2.2	-	1	2	64.00	-
		FS450 US15	619	2.2	-	1	2	68.00	-
		FS450 US26	625	2.2	-	1	2	64.00	-
		FS450 US26D**	626	2.2	-	1	2	<b>46.60</b>	-
		FS450 643E/716	-	2.20	-	1	2	68.00	-
		FS450 BLK	622	2.2	-	1	2	64.00	-
	Aluminum	FS450 US28	628	1.1	-	1	2	34.60	-
<b>FS450 Rubber Tip</b>		09-316	-	-	-	1	1	2.50	-
<b>FS452</b> Kick Down Door Holder 4" 	Brass	FS452-4 US3	605	5.0	-	1	10	33.00	-
		FS452-4 US4	606	5.0	-	1	10	33.00	-
		FS452-4 US10	612	5.0	-	1	10	33.00	-
		FS452-4 US10B	613	5.0	-	1	10	34.80	-
		FS452-4 US15	619	5.0	-	1	10	45.10	-
		FS452-4 US26	625	5.0	-	1	10	48.90	-
		FS452-4 US26D**	626	5.0	-	1	10	<b>31.70</b>	-
		FS452-4 643E/716	-	5.0	-	1	10	45.10	-
	FS452-4 BLK	622	5.0	-	1	10	34.80	-	
Aluminum	FS452-4 US28	628	2.1	-	1	10	28.70	-	
<b>FS452 Rubber Tips</b>		HRT (FSPART.1075)	-	-	Yes	100	100	-	\$137.40
<b>FS452</b> Kick Down Door Holder 5" 	Brass	FS452-5 US3	605	5.8	-	1	10	45.60	-
		FS452-5 US4	606	5.8	-	1	10	45.60	-
		FS452-5 US10	612	5.8	-	1	10	45.60	-
		FS452-5 US10B	613	5.8	-	1	10	<b>45.60</b>	-
		FS452-5 US15	619	5.8	-	1	10	51.40	-
		FS452-5 US26	625	5.8	-	1	10	57.20	-
		FS452-5 US26D**	626	5.8	-	1	10	<b>39.30</b>	-
		FS452-5 643E/716	-	5.8	-	1	10	51.40	-
	FS452-5 BLK	622	5.8	-	1	10	45.60	-	
<b>FS452 Rubber Tips</b>		HRT (FSPART.1075)	-	-	Yes	100	100	-	137.40
<b>SB453</b> Surface Bolt UL Listed 8" 	Steel	SB453US2C-8-TB**	604	5.4	-	1	5	<b>44.70</b>	-
		SB453US3-8-TB	632	5.8	-	1	5	44.70	-
		SB453US4-8-TB	633	5.8	-	1	5	44.70	-
		SB453US10-8-TB	639	5.4	-	1	5	53.90	-
		SB453US10B-8-TB	640	5.4	-	1	5	57.90	-
		SB453US15-8-TB**	646	5.4	-	1	5	57.90	-
		SB453US26D-8-TB	652	5.4	-	1	5	55.10	-
		SB453643E/716-8-TB**	-	5.4	-	1	5	57.90	-
		SB453BLK-8-TB	-	5.8	-	1	5	44.70	-

Lead time exception: \*\* Products are stocked and will typically ship in 3-5 days







Bold pricing indicates item is in stock and available for **Fast Track** and **ProXpress**

HINGES  
 CONTINUOUS HINGES  
 PIVOTS  
 Numerical 1-059  
 Numerical 59-437  
 Numerical 438-1021  
 Numerical 1152-8190  
 Numerical 8200-9266

MODEL	SUBSTRATE	MODEL NUMBER	BHMA FINISH	WEIGHT	MUST BE ORDERED IN MULTIPLE QTY	MULTIPLE QTY	PACKED PER BOX	LIST PRICE	
								EACH	PACKAGE
<b>SB453</b> Surface Bolt UL Listed 12"	Steel	SB453US2C 12-TB	604	6.6	-	1	5	\$56.40	-
		SB453US10 12-TB	639	6.6	-	1	5	60.30	-
		SB453US10B 12-TB	640	6.6	-	1	5	65.80	-
		SB453US15 12-TB	646	6.6	-	1	5	69.60	-
		SB453US26D 12-TB**	652	6.6	-	1	5	69.60	-
		SB453643E/716 12-TB	-	6.6	-	1	5	69.60	-
		SB453BLK 12-TB	-	6.6	-	1	5	69.60	-
<b>SB453 Thrubolt with Cap Nut Pkg</b>		09-340-626	626	-	-	1	1	9.50	-
<b>SB453 Sex Bolt Pkg</b>		09-351-604	604	-	-	1	1	17.50	-
<b>FS455</b> 4" Kick Down Door Holder 	Aluminum	FS455-4 US3AL	666	1.9	-	1	10	<b>8.90</b>	-
		FS455-4 US5AL	-	2.0	-	1	10	13.20	-
		FS455-4 US10AL	668	1.9	-	1	10	8.90	-
		FS455-4 US27**	673	1.9	-	1	10	<b>8.90</b>	-
		SPFS455-4 US3AL	666	46.5	Yes	15	15	-	\$132.15
		SPFS455-4 US5AL	-	46.5	Yes	15	15	-	200.70
		SPFS455-4 US27	673	46.5	Yes	15	15	-	132.15
	Brass	FS455-4 US3	605	4.6	-	1	10	<b>35.80</b>	-
		FS455-4 US4	606	4.6	-	1	10	35.80	-
		FS455-4 US5	609	4.6	-	1	10	43.00	-
		FS455-4 US10	612	4.6	-	1	10	35.80	-
		FS455-4 US10B**	613	4.6	-	1	10	<b>43.00</b>	-
		FS455-4 US15	619	4.6	-	1	10	44.00	-
		FS455-4 US26	625	4.6	-	1	10	43.00	-
		FS455-4 US26D**	626	4.6	-	1	10	<b>43.00</b>	-
FS455-4 643E/716		-	4.6	-	1	10	44.00	-	
FS455-4 BLK	622	4.6	-	1	10	43.00	-		
<b>FS455 Rubber Tips</b>		HRT (FSPART.1075)	-	-	Yes	100	100	-	137.40
<b>FB457</b> Manual Flush Bolt UL 3 Hour Single Metal Door  Accessory Rod Lengths Available** 18", 24", 36", 48" 6.80 List Price	Brass	FB457-12 US3	605	2.0	-	1	12	30.80	-
		FB457-12 US4	606	2.0	-	1	12	30.80	-
		FB457-12 US10	612	2.0	-	1	12	30.80	-
		FB457-12 US10B**	613	2.0	-	1	12	30.80	-
		FB457-12 US15	619	2.0	-	1	12	30.80	-
		FB457-12 US26	625	2.0	-	1	12	30.80	-
		FB457-12 US26D**	626	2.0	-	1	12	<b>30.80</b>	-
		FB457-12 643E/716	-	2.0	-	1	12	30.80	-
		FB457-12 BLK	622	2.0	-	1	12	30.80	-
		<b>FB457 Bolt Tips</b>		09-176-604	-	-	-	1	1
<b>FB457 Guide PKG</b>		09-135	-	-	-	1	1	2.50	-
<b>FB458</b> Manual Flush Bolt UL 3 Hour Single Metal Door  Accessory Rod Lengths Available** 18", 24", 36", 48" 6.80 List Price	Brass	FB458 US3 12 IN**	605	2.0	-	1	12	<b>26.10</b>	-
		FB458 US4 12 IN**	606	2.0	-	1	12	26.10	-
		FB458 US5 12 IN	609	2.0	-	1	12	26.10	-
		FB458 US10 12 IN**	612	2.0	-	1	12	26.10	-
		FB458 US10B 12 IN**	613	2.0	-	1	12	26.10	-
		FB458 US15 12 IN**	619	2.0	-	1	12	<b>26.10</b>	-
		FB458 US26 12 IN**	625	2.0	-	1	12	26.10	-
		FB458 US26D 12 IN**	626	2.0	-	1	12	<b>24.20</b>	-
		FB458 643E/716 12 IN	-	2.0	-	1	12	26.10	-
		FB458 BLK 12 IN	622	2.0	-	1	12	26.10	-
<b>FB458 Bolt Tips</b>		09-176-604	604	-	-	1	1	5.70	-
<b>FB458 Guide PKG</b>		09-135	-	-	-	1	1	2.50	-
<b>RB470</b> Roller Bumper 2" Reach 	Brass	RB470 US3	605	0.9	-	1	2	34.30	-
		RB470 US26	625	0.9	-	1	2	43.00	-
		RB470 US26D	626	0.9	-	1	2	43.00	-
<b>RB470 Large Roller PKG</b>		09-137-626	626	-	-	1	1	6.50	-
<b>RB471</b> Roller Bumper 4-1/2" Projection 	Brass	RB471 US3	605	1.0	-	1	2	32.40	-
		RB471 US4	606	1.0	-	1	2	38.90	-
		RB471 US26	625	1.0	-	1	2	38.90	-
		RB471 US26D**	626	1.0	-	1	2	38.90	-
<b>RB472</b> Roller Bumper 6" Projection 	Brass	RB472 US3	605	1.1	-	1	2	34.40	-
		RB472 US4	606	1.1	-	1	2	41.00	-
		RB472 US10	612	1.1	-	1	2	41.00	-
		RB472 US10B	613	1.1	-	1	2	41.00	-
		RB472 US15	619	1.1	-	1	2	39.00	-
		RB472 US26	625	1.1	-	1	2	41.00	-
<b>RB472 Large Roller PKG</b>		09-137-626	626	-	-	1	1	6.50	-

Lead time exception: \*\* Products are stocked and will typically ship in 3-5 days

Bold pricing indicates item is in stock and available for **Fast Track** and **ProXpress**

MODEL	SUBSTRATE	MODEL NUMBER	BHMA FINISH	WEIGHT	MUST BE ORDERED IN MULTIPLE QTY	MULTIPLE QTY	PACKED PER BOX	LIST PRICE	
								EACH	PACKAGE
<b>481</b> Chain Door Guard 	Brass	481B3	605	2.5	-	1	10	\$12.50	-
		481B26D	626	2.5	-	1	10	14.60	-
	Steel	481F3	632	2.3	-	1	10	6.90	-
		481F4	633	2.3	-	1	10	6.90	-
		481F5	638	2.3	-	1	10	7.80	-
		481F10	639	2.3	-	1	10	7.80	-
		481F15**	646	2.3	-	1	10	6.90	-
		481F26	651	2.3	-	1	10	6.90	-
		481F26D	652	2.3	-	1	10	6.90	-
481F-643E/716	-	1.2	-	1	10	8.00	-		
481F-BLK	-	2.3	-	1	10	7.80	-		
<b>482</b> Door Guard 	Brass	482B3	605	5.0	-	1	5	34.50	-
		482B4	606	5.0	-	1	5	38.00	-
		482B10	612	5.0	-	1	5	38.00	-
		482B10B	613	5.0	-	1	5	38.00	-
		482B15	619	5.0	-	1	5	52.10	-
		482B26	625	5.0	-	1	5	38.00	-
		482B26D**	626	5.0	-	1	5	<b>38.00</b>	-
		482B643E/716	-	5.0	-	1	5	38.00	-
	482B-BLK	622	5.0	-	1	5	38.00	-	
	Zinc	482 Z605E	677	3.5	-	1	5	10.30	-
		482 Z609E	-	3.5	-	1	5	10.30	-
482 Z625E		681	3.5	-	1	5	12.20	-	
482 Z626E		682	3.5	-	1	5	12.20	-	
<b>482 ▲</b> Plate		09-170-605	605	-	-	1	1	7.80	-
		09-170-613	613	-	-	1	1	7.80	-
		09-170-626	626	-	-	1	1	7.80	-
<b>482 ▲</b> SHIM 1/8 In		09-576-626	626	-	-	1	1	17.80	-
<b>482 ▲</b> SHIM 3/8 In		09-577-626	626	-	-	1	1	28.20	-
<b>FS495</b> Auto Door Stop and Holder 3/8" Max Clearance Floor to Door 	Brass	FS495 US3	605	1.8	-	1	1	93.50	-
		FS495 US4	606	1.8	-	1	1	93.50	-
		FS495 US10	612	1.8	-	1	1	112.10	-
		FS495 US10B	613	1.8	-	1	1	112.10	-
		FS495 US26	625	1.8	-	1	1	112.10	-
		FS495 US26D**	626	1.8	-	1	1	<b>93.50</b>	-
<b>FS496</b> Auto Door Stop and Holder 1" Max Clearance Floor to Door 	Brass	FS496 US3	605	1.5	-	1	1	106.70	-
		FS496 US10	612	1.5	-	-	1	106.70	-
		FS496 US10B	613	1.5	-	1	1	106.70	-
		FS496 US26	625	1.5	-	1	1	106.70	-
		FS496 US26D	626	1.5	-	1	1	106.70	-
<b>FS497</b> Auto Door Stop and Holder 	Brass	FS497 US3	605	1.4	-	1	1	99.60	-
		FS497 US10	612	1.4	-	1	1	119.60	-
		FS497 US10B	613	1.4	-	1	1	119.60	-
		FS497 US26	625	1.4	-	1	1	119.60	-
		FS497 US26D	626	1.4	-	1	1	99.60	-
<b>FS544</b> Kick Down Door Holder 4" 	Steel	FS544 SP4	706	-	-	1	-	<b>13.20</b>	-
		FS544 SPI0	691	-	-	1	-	13.20	-
		FS544 SP28**	689	-	-	1	-	<b>13.20</b>	-
		FS544 SP313	695	-	-	1	-	13.20	-
		FS544 BLK	-	-	-	1	-	13.20	-
<b>FS555</b> Kick Down Door Holder 5" 	Steel	FS555 SP4	706	-	-	1	-	14.10	-
		FS555 SPI0	691	-	-	1	-	14.10	-
		FS555 SP28**	689	-	-	1	-	<b>14.10</b>	-
		FS555 SP313	695	-	-	1	-	14.10	-
		FS555 BLK	-	-	-	1	-	14.10	-

▲ Fits brass door guards only.

Lead time exception: \*\* Products are stocked and will typically ship in 3-5 days

Bold pricing indicates item is in stock and available for **Fast Track** and **ProXpress**

HINGES

CONTINUOUS HINGES

PIVOTS









Numerical 1-059

Numerical 59-437

Numerical 438-1021



Numerical 1152-8190

Numerical 8200-9266

MODEL	SUBSTRATE	MODEL NUMBER	BHMA FINISH	WEIGHT	MUST BE ORDERED IN MULTIPLE QTY	MULTIPLE QTY	PACKED PER BOX	LIST PRICE	
								EACH	PACKAGE
<b>506</b> Plymouth, Curved Double Coat Hook - Surface Mount 	Brass	506-605	605	-	-	1	20	\$12.60	-
		506-613	613	-	-	1	20	12.60	-
		506-625	625	-	-	1	20	12.60	-
		506-626	626	-	-	1	20	10.10	-
		506-643E/716	-	-	-	1	20	12.60	-
		506-BLK	622	-	-	1	20	12.60	-
<b>507</b> Rhodes, Parallel Double Coat Hook - Surface Mount 	Brass	507-605	605	-	-	1	20	29.00	-
		507-613	613	-	-	1	20	30.50	-
		507-625	625	-	-	1	20	30.50	-
		507-626	626	-	-	1	20	24.00	-
		507-643E/716	-	-	-	1	20	30.50	-
		507-BLK	622	-	-	1	20	30.50	-
<b>507B</b> Rhodes Single Coat Hook - Surface Mount	Brass	507B-605	605	-	-	1	50	29.00	-
		507B-613	613	-	-	1	50	30.50	-
		507B-625	625	-	-	1	50	30.50	-
		507B-626	626	-	-	1	50	24.00	-
		507B-643E/716	-	-	-	1	50	30.50	-
		507B-BLK	622	-	-	1	50	30.50	-
<b>508</b> Greenwich, Wide Body Double Coat Hook - Surface Mount 	Brass	508-605	605	-	-	1	8	77.30	-
		508-613	613	-	-	1	8	79.80	-
		508-625	625	-	-	1	8	79.80	-
		508-626	626	-	-	1	8	62.10	-
		508-643E/716	-	-	-	1	8	79.80	-
		508-BLK	622	-	-	1	8	79.80	-
<b>508C</b> Greenwich, Wide Body Double Coat Hook - Concealed Mount 	Brass	508C-605	605	-	-	1	8	150.80	-
		508C-613	613	-	-	1	8	157.20	-
		508C-619	619	-	-	1	8	142.60	-
		508C-625	625	-	-	1	8	120.30	-
		508C-626	626	-	-	1	8	157.20	-
		508C-643E/716	-	-	-	1	8	157.20	-
508C-BLK	622	-	-	1	8	152.60	-		
<b>509C</b> Tubular, Double Coat Hook - Concealed Mount 	Brass	509C-605	605	-	-	1	5	126.60	-
		509C-613	613	-	-	1	5	131.80	-
		509C-625	625	-	-	1	5	131.80	-
		509C-626	626	-	-	1	5	101.20	-
		509C-643E/716	-	-	-	1	5	131.80	-
		509C-BLK	622	-	-	1	5	131.80	-
<b>510C</b> Latitude, Angled Double Coat Hook - Concealed Mount 	Brass	510C-605	605	-	-	1	4	126.60	-
		510C-613	613	-	-	1	4	131.80	-
		510C-625	625	-	-	1	4	131.80	-
		510C-626	626	-	-	1	4	101.20	-
		510C-643E/716	-	-	-	1	4	131.80	-
		510C-BLK	622	-	-	1	4	131.80	-
<b>510BC</b> Latitude, Angled Single Coat Hook - Concealed Mount 	Brass	510BC-605	605	-	-	1	8	89.80	-
		510BC-613	613	-	-	1	8	93.80	-
		510BC-625	625	-	-	1	8	93.80	-
		510BC-626	626	-	-	1	8	72.20	-
		510BC-643E/716	-	-	-	1	8	93.80	-
		510BC-BLK	622	-	-	1	8	93.80	-
<b>511BC</b> Century, Wide Single Coat Hook - Concealed Mount	Brass	511BC-605	605	-	-	1	50	21.60	-
		511BC-613	613	-	-	1	50	21.60	-
		511BC-625	625	-	-	1	50	21.60	-
		511BC-626	626	-	-	1	50	16.40	-
		511BC-643E/716	-	-	-	1	50	21.60	-
		511BC-BLK	622	-	-	1	50	21.60	-
<b>543</b> Camelot, J Curve, Double Coat Hook - Surface Mount 	Stainless	543-629	629	-	-	1	10	11.40	-
		543-630	630	-	-	1	10	11.40	-
<b>543B</b> Camelot, J Curve, Single Coat Hook - Surface Mount	Stainless	543B-629	629	-	-	1	10	10.10	-
		543B-630	630	-	-	1	10	10.10	-
<b>554</b> Century, Wave Double Coat Hook - Surface Mount	Brass	554-605	605	-	-	1	10	31.60	-
		554-619	619	-	-	1	10	31.60	-
		554-625	625	-	-	1	10	25.30	-
		554-626	626	-	-	1	10	25.30	-
		554-643E/716	-	-	-	1	10	31.60	-
		554-BLK	622	-	-	1	10	31.60	-

Lead time exception: \*\* Products are stocked and will typically ship in 3-5 days

Bold pricing indicates item is in stock and available for **Fast Track** and **ProXpress**

MODEL	SUBSTRATE	MODEL NUMBER	BHMA FINISH	WEIGHT	MUST BE ORDERED IN MULTIPLE QTY	MULTIPLE QTY	PACKED PER BOX	LIST PRICE	
								EACH	PACKAGE
<b>558B</b> Orbit 1" J Curve w/ Bumper Single Coat Hook - Surface Mount	Brass	558B-605	605	-	-	1	20	\$103.80	-
		558B-613	613	-	-	1	20	108.90	-
		558B-619	619	-	-	1	20	103.80	-
		558B-625	625	-	-	1	20	108.90	-
		558B-626	626	-	-	1	20	83.50	-
		558B-643E/716	-	-	-	1	20	108.90	-
		558B-BLK	622	-	-	1	20	103.80	-
<b>559B</b> Tubular, w/ Disc Single Coat Hook - Surface Mount	Brass	559B-605	605	-	-	1	40	24.00	-
		559B-613	613	-	-	1	40	24.00	-
		559B-619	619	-	-	1	40	24.00	-
		559B-625	625	-	-	1	40	24.00	-
		559B-626	626	-	-	1	40	19.10	-
		559B-643E/716	-	-	-	1	40	24.00	-
<b>571</b> Coat and Hat Hook 	Aluminum	571A3**	666	1.3	-	1	20	<b>1.30</b>	-
		571A5	-	1.3	-	1	20	2.00	-
		571A10	668	1.3	-	1	20	1.30	-
		571A14**	669	1.3	-	1	20	2.00	-
		571A15**	670	1.3	-	1	20	2.00	-
		571A26	672	1.3	-	1	20	2.00	-
		571A26D	702	1.3	-	1	20	1.80	-
		571A92**	673	1.3	-	1	20	<b>1.30</b>	-
		571A-643E/716**	-	1.3	-	1	20	2.70	-
		571A-BLK	-	1.4	-	1	20	2.70	-
		571A-W	-	1.4	-	1	20	2.70	-
		SP571A3	666	47.5	Yes	25	25	-	\$35.25
		SP571A5	-	47.5	Yes	25	25	-	48.25
		SP571A14	669	47.5	Yes	25	25	-	49.75
	SP571A92	673	47.5	Yes	25	25	-	35.25	
	SP571A-W	-	47.5	Yes	25	25	-	67.50	
	Brass	571B3	605	1.5	-	-	10	9.00	-
		571B4	606	1.5	-	-	10	10.60	-
		571B5	609	1.5	-	-	10	10.60	-
		571B10B**	613	1.5	-	1	10	<b>10.60</b>	-
571B15**		619	1.5	-	1	10	11.20	-	
571B26		625	1.5	-	1	10	10.60	-	
571B26D**		626	1.5	-	1	10	<b>10.60</b>	-	
571B-643E/716		-	1.5	-	1	10	10.60	-	
571B-BLK		622	1.5	-	1	10	10.60	-	
SP571B26		625	24	Yes	10	10	-	110.60	
<b>572</b> Coat and Hat Hook 	Aluminum	572A3	666	1.9	-	1	20	4.40	-
		572A5	-	1.9	-	1	20	4.60	-
		572A10	668	1.9	-	1	20	4.60	-
		572A10B	703	0.0	-	1	20	4.60	-
		572A14	669	1.9	-	1	20	4.60	-
		572A15	670	1.9	-	1	20	4.60	-
		572A92	673	1.9	-	1	20	4.40	-
	Brass	572B3	605	1.1	-	1	10	12.20	-
		572B4	606	1.1	-	1	10	12.20	-
		572B5	609	1.1	-	1	10	15.30	-
		572B10	612	1.1	-	1	10	12.20	-
		572B10B	613	1.1	-	1	10	14.70	-
		572B15	619	1.1	-	1	10	15.30	-
		572B26	625	1.1	-	1	10	14.70	-
572B26D**	626	1.1	-	1	10	14.70	-		





HINGES  
 CONTINUOUS HINGES  
 PIVOTS  
 Numerical 1-059  
 Numerical 59-437  
 Numerical 438-1021  
 Numerical 1152-8190  
 Numerical 8200-9266

Lead time exception: \*\* Products are stocked and will typically ship in 3-5 days

Bold pricing indicates item is in stock and available for **Fast Track** and **ProXpress**







HINGES  
 CONTINUOUS HINGES  
 PIVOTS  
 Numerical 1-059  
 Numerical 59-437  
 Numerical 438-1021  
 Numerical 1152-8190  
 Numerical 8200-9266

MODEL	SUBSTRATE	MODEL NUMBER	BHMA FINISH	WEIGHT	MUST BE ORDERED IN MULTIPLE QTY	MULTIPLE QTY	PACKED PER BOX	LIST PRICE	
								EACH	PACKAGE
<b>574</b> Coat and Hat Hook 	Aluminum	574A3	666	1.6	-	1	10	\$8.90	-
		574A26	672	1.6	-	1	10	8.90	-
		574A92	673	0.0	-	1	10	8.90	-
	Brass	574B3	605	4.1	-	1	10	30.50	-
		574B4	606	0.0	-	1	10	30.50	-
		574B10	612	0.0	-	1	10	36.40	-
		574B10B	613	4.1	-	1	10	36.40	-
		574B15	619	0.0	-	1	10	40.10	-
		574B26	625	4.1	-	1	10	36.40	-
574B26D**	626	4.1	-	1	10	36.40	-		
<b>575</b> Coat and Hat Hook 	Aluminum	575A3	666	1.4	-	1	10	5.40	-
		575A10B	703	1.4	-	1	10	6.00	-
		575A92	673	1.4	-	1	10	5.40	-
<b>580</b> Ceiling Hook 	Aluminum	580A3	666	1.8	-	1	20	3.10	-
		580A5	-	0.0	-	1	20	3.30	-
		580A10	668	1.8	-	1	20	3.30	-
		580A14	669	1.8	-	1	20	3.30	-
		580A15	670	0.0	-	1	20	3.30	-
		580A26	672	1.8	-	1	20	3.30	-
		580A26D	702	1.8	-	1	20	3.30	-
		580A92**	673	1.8	-	1	20	<b>3.10</b>	-
		580A-643E/716**	-	0.0	-	1	20	3.30	-
		580A-BLK	-	0.0	-	1	20	3.30	-
		SP580A14	669	60.0	Yes	25	25	-	83.50
		SP580A3	666	60.0	Yes	25	25	-	77.25
		SP580A92	673	60.0	Yes	25	25	-	77.25
<b>581</b> Wardrobe Hook 	Aluminum	581A3	666	0.9	-	1	20	1.80	-
		581A5	-	0.9	-	1	20	2.00	-
		581A14	669	0.8	-	1	20	2.00	-
		581A15	670	0.9	-	1	20	2.00	-
		581A26	672	0.9	-	1	20	2.00	-
		581A26D	702	0.9	-	1	20	2.00	-
		581A92**	673	0.90	-	1	20	<b>1.80</b>	-
		581A-643E/716	-	0.90	-	1	20	2.00	-
		581A-BLK	-	0.90	-	1	20	2.60	-
		581A-W	-	0.90	-	1	20	2.60	-
		SP581A3	666	120.0	Yes	50	50	-	84.00
		SP581A5	-	120.0	Yes	50	50	-	96.50
		SP581A14	669	120.0	Yes	50	50	-	96.50
	SP581A92	673	2.4	Yes	50	50	-	84.00	
	Brass	581B3	605	0.8	-	1	10	6.10	-
		581B4	606	0.0	-	1	10	6.40	-
		581B5	609	0.8	-	1	10	7.30	-
		581B10	612	0.0	-	1	10	7.40	-
		581B10B	613	0.8	-	1	10	7.30	-
		581B15	619	0.8	-	1	10	7.50	-
581B26		625	0.8	-	1	10	7.30	-	
581B26D**	626	0.8	-	1	10	7.30	-		
581B-643E/716	-	-	-	1	10	7.50	-		
581B-BLK	622	-	-	1	10	7.30	-		

Continued on next page.

Lead time exception: \*\* Products are stocked and will typically ship in 3-5 days

Bold pricing indicates item is in stock and available for **Fast Track** and **ProXpress**

MODEL	SUBSTRATE	MODEL NUMBER	BHMA FINISH	WEIGHT	MUST BE ORDERED IN MULTIPLE QTY	MULTIPLE QTY	PACKED PER BOX	LIST PRICE	
								EACH	PACKAGE
<b>581</b> <b>Wardrobe Hook</b> <i>Continued from previous page.</i> 	Brass	SP581B26	625	27.0	Yes	10	10	-	\$72.00
	Zinc**	581Z-619E	-	2.6	-	1	20	\$5.40	-
<b>582</b> <b>Wardrobe Hook</b> 	Aluminum	582A3	666	1.0	-	1	20	2.00	-
		582A5	-	1.0	-	1	20	2.10	-
		582A10	668	1.0	-	1	20	2.10	-
		582A14**	669	1.0	-	1	20	2.10	-
		582A15	670	1.0	-	1	20	2.10	-
		582A26	672	1.0	-	1	20	2.10	-
		582A26D	702	1.0	-	1	20	2.10	-
		582A92**	673	1.0	-	1	20	<b>2.00</b>	-
		582A-643E/716	-	1.0	-	1	20	2.10	-
		582A-BLK	-	1.0	-	1	20	2.80	-
		582A-W**	-	1.0	-	1	20	2.80	-
		SP582A3	666	42.5	Yes	25	25	-	48.25
		SP582A5	-	42.5	Yes	25	25	-	51.25
		SP582A14	669	42.5	Yes	25	25	-	51.25
		SP582A92	673	42.5	Yes	25	25	-	48.25
	SP582A-W	-	35.0	Yes	25	25	-	70.50	
	Brass	582B3	605	1.2	-	1	10	8.00	-
		582B4	606	1.2	-	1	10	9.00	-
		582B5	609	1.2	-	1	10	9.00	-
		582B10	612	1.2	-	1	10	9.60	-
		582B10B	613	1.2	-	1	10	9.60	-
		582B15**	619	1.2	-	1	10	9.90	-
		582B26	625	1.2	-	1	10	9.60	-
582B26D**		626	1.2	-	1	10	<b>9.60</b>	-	
582B-643E/716		-	1.2	-	1	10	9.90	-	
582B-BLK		622	1.2	-	1	10	9.60	-	
SP582B26		625	12.0	Yes	10	10	-	100.40	
Zinc		582Z-619E	-	4.7	-	1	20	5.40	-
<b>585/586</b> <b>Closet Pole Socket</b> 	Steel	SP585F3	632	50.0	Yes	25	25	-	41.50
	Plastic	SP586P**	-	32.0	Yes	20	20	-	26.40
<b>601</b> <b>Mail Slot Sleeve</b> 	Brass	60113/4 IN**	630	0.4	-	1	1	20.50	-
<b>620</b> <b>Letter Box Plate</b> Magazine Open Back Plate Spring-Loaded Front Plate 	Brass	620B3	605	1.5	-	1	1	84.20	-
		620B5	609	1.5	-	1	1	103.80	-
		620B15	619	1.5	-	1	1	100.90	-
		620B26	625	1.5	-	1	1	100.90	-
		620B26D**	626	1.5	-	1	1	100.90	-
		620B-643E/716	-	3.3	-	1	1	100.90	-
		620B-BLK	622	3.3	-	1	1	100.90	-
	Aluminum	620PA28**	628	0.6	-	1	1	52.50	-

HINGES  
 CONTINUOUS HINGES  
 PIVOTS  
 Numerical 1-059  
 Numerical 59-437  
 Numerical 438-1021  
 Numerical 1152-8190  
 Numerical 8200-9266

Lead time exception: \*\* Products are stocked and will typically ship in 3-5 days

Bold pricing indicates item is in stock and available for **Fast Track** and **ProXpress**

HINGES

CONTINUOUS HINGES

PIVOTS



Numerical 1-059

Numerical 59-437

Numerical 438-1021



Numerical 1152-8190

Numerical 8200-9266

MODEL	SUBSTRATE	MODEL NUMBER	BHMA FINISH	WEIGHT	MUST BE ORDERED IN MULTIPLE QTY	MULTIPLE QTY	PACKED PER BOX	LIST PRICE	
								EACH	PACKAGE
<b>620</b> Sex Bolt PKG		09-355-605	605	-	-	1	1	\$12.30	-
		09-355-613	613	-	-	1	1	14.80	-
		09-355-626	626	-	-	1	1	14.80	-
<b>STK685</b> Double Acting Strike Custom Made Specify Jamb width when ordering	Brass	STK685 US3	605	-	-	1	-	316.30	-
		STK685 US4	606	-	-	1	-	316.30	-
		STK685 US10	612	-	-	1	-	316.30	-
		STK685 US10B	613	-	-	1	-	316.30	-
		STK685 US26	625	-	-	1	-	316.30	-
		STK685 US26D	626	-	-	1	-	316.30	-
<b>STK685L</b> Double Acting Strike, Custom Made Specify Dimple Location and Jamb Width when ordering	Brass	STK685L US3	605	-	-	1	-	316.30	-
		STK685L US4	606	-	-	1	-	316.30	-
		STK685L US10	612	-	-	1	-	316.30	-
		STK685L US10B	613	-	-	1	-	316.30	-
		STK685L US26	625	-	-	1	-	316.30	-
		STK685L US26D	626	-	-	1	-	316.30	-
<b>U696</b> Door Viewer, 150° UL Listed 90 Min	Brass	U696B4	606	0.5	-	1	10	17.60	-
		U696B10B	613	0.5	-	1	10	17.60	-
		U696B15	619	0.5	-	1	10	17.60	-
		U696B26	625	0.5	-	1	10	17.60	-
		U696B26D**	626	0.5	-	1	10	<b>17.60</b>	-
		U696B-643E/716	-	0.5	-	1	10	17.60	-
		U696B-BLK	622	0.5	-	1	10	17.60	-
<b>696-700-701</b> Viewer Cover	Brass	890312606	606	-	-	1	1	2.10	-
		890312613	613	-	-	1	1	2.10	-
		890312619	619	-	-	1	1	2.10	-
		890312625	625	-	-	1	1	2.10	-
		890312626	626	-	-	1	1	2.10	-
		890312716	716	-	-	1	1	2.10	-
		890312622	622	-	-	1	1	2.10	-
<b>696-700-701</b> Viewer Extension	Brass	890314626	626	-	-	1	1	3.20	-
<b>698</b> Door Viewer, 190° For Doors 1-3/8" to 2-1/8" U = UL Listed 90 Min P = Plastic Lens 	Brass	698B3	605	0.8	-	1	10	20.70	-
		698B26D**	626	0.8	-	1	10	<b>20.70</b>	-
		698P-B643E/716**	-	0.8	-	1	10	20.70	-
		U698B3**	605	0.8	-	1	10	<b>24.80</b>	-
		U698B15	619	0.8	-	1	10	24.80	-
		U698B26	625	0.8	-	1	10	24.80	-
		U698B26D**	626	0.8	-	1	10	<b>24.80</b>	-
		U698B-643E/716	-	0.8	-	1	10	24.80	-
		U698B-BLK	622	0.8	-	1	10	24.80	-
<b>698</b> Viewer Cover	Brass	890311605	605	-	-	1	1	2.70	-
		890311619	619	-	-	1	1	2.70	-
		890311625	625	-	-	1	1	2.70	-
		890311626	626	-	-	1	1	2.70	-
		890311716	716	-	-	1	1	2.70	-
		890311622	622	-	-	1	1	2.70	-
<b>698</b> Viewer Extension	Brass	890313626	626	-	-	1	1	4.30	-
<b>700</b> Door Viewer, 120° For Doors 1-3/8" to 2-1/16" U = UL Listed 90 Min 	Brass	700B4	606	0.5	-	1	10	8.90	-
		700B26D**	626	0.5	-	1	10	<b>8.90</b>	-
		U700B4	606	0.5	-	1	10	12.10	-
		U700B10B	613	0.5	-	1	10	12.10	-
		U700B15	619	0.5	-	1	10	12.10	-
		U700B26	625	0.5	-	1	10	12.10	-
		U700B26D**	626	0.5	-	1	10	<b>12.10</b>	-
		U700B-643E/716	-	0.5	-	1	10	12.10	-
U700B-BLK	622	0.5	-	1	10	12.10	-		
<b>700</b> Trim Washer		09-241-606	606	-	-	1	1	0.30	-
		09-241-613	613	-	-	1	1	0.30	-
		09-241-626	626	-	-	1	1	0.30	-
<b>701</b> Door Viewer, 120° For Doors 2-1/8" to 2-5/8" U = UL Listed 90 Min 	Brass	701B4	606	0.8	-	1	10	9.70	-
		701B10B	613	0.8	-	1	10	9.70	-
		701B26D	626	0.8	-	1	10	9.70	-
		U701B4	606	0.8	-	1	10	13.90	-
		U701B10B	613	0.8	-	1	10	13.90	-
		U701B15	619	0.8	-	1	10	13.90	-
		U701B26	625	0.8	-	1	10	13.90	-
		U701B26D	626	0.5	-	1	10	13.90	-
		U701B-643E/716	-	0.8	-	1	10	13.90	-
		U701B-BLK	622	0.8	-	1	10	13.90	-

Lead time exception: \*\* Products are stocked and will typically ship in 3-5 days







Bold pricing indicates item is in stock and available for Fast Track and ProXpress

MODEL	SUBSTRATE	MODEL NUMBER	BHMA FINISH	WEIGHT	MUST BE ORDERED IN MULTIPLE QTY	MULTIPLE QTY	PACKED PER BOX	LIST PRICE	
								EACH	PACKAGE
<b>VR810DT/VR814DT</b> Vandal Resistant Trim Use w/Falcon XX, 18 and 25 Series Exit Devices	Stainless	VR810-DT US32D	630	-	-	1	1	\$310.50	-
		VR814-DT US32D	630	-	-	1	1	310.50	-
<b>VR810NL/VR814NL</b> Vandal Resistant Trim Use w/Falcon XX, and 18 Series Rim Exit Devices	Stainless	VR810-NL RHR US32D	630	-	-	1	1	310.50	-
		VR810-NL LHR US32D	630	-	-	1	1	310.50	-
		VR814-NL RHR US32D	630	-	-	1	1	310.50	-
		VR814-NL LHR US32D	630	-	-	1	1	310.50	-
<b>VR810NL-V/VR814NL-V</b> Vandal Resistant Trim Use w/ Falcon XX-V, and w/ 25-R (Rim) and 25-V (surface vertical) devices	Stainless	VR810-NL-V US32D	630	-	-	1	1	310.50	-
		VR814-NL-V US32D	630	-	-	1	1	310.50	-
<b>AS895</b> Applied Stop 	Brass	AS895 US3	605	-	-	1	1	56.20	-
		AS895 US4	606	-	-	1	1	51.70	-
		AS895 US10	612	-	-	1	1	52.30	-
		AS895 US10B	613	-	-	1	1	56.20	-
		AS895 US26	625	-	-	1	1	56.20	-
		AS895 US26D	626	-	-	1	1	56.20	-
<b>VR900/VR904</b> Vandal Resistant Trim Use w/Mortise Locks Outswing Doors	Stainless	VR900 LHR US32D	630	-	-	1	1	310.50	-
		VR900 RHR US32D**	630	-	-	1	1	310.50	-
		VR904 LHR US32D	630	-	-	1	1	310.50	-
		VR904 RHR US32D	630	-	-	1	1	310.50	-
<b>VR900LLP/VR904LLP</b> Vandal Resistant Trim Use w/Mortise Locks Inswing Doors LLP = Less Lock Protectors	Stainless	VR900-LLP LH US32D	630	-	-	1	1	310.50	-
		VR900-LLP RH US32D	630	-	-	1	1	310.50	-
		VR904-LLP LH US32D	630	-	-	1	1	310.50	-
		VR904-LLP RH US32D	630	-	-	1	1	310.50	-
<b>VR910DT/VR914DT</b> Vandal Resistant Trim Use w/Von Duprin 98/99 Series Rim and Verticle Exit Devices	Stainless	VR910-DT US32D**	630	-	-	1	1	<b>310.50</b>	-
		VR914-DT US32D	630	-	-	1	1	310.50	-
<b>VR910NL/VR914NL</b> Vandal Resistant Trim Use w/Von Duprin 98/99 Series Rim and Verticle Exit Devices	Stainless	VR910-NL US32D**	630	-	-	1	1	<b>310.50</b>	-
		VR914-NL US32D**	630	-	-	1	1	310.50	-
<b>VR910M-DT/VR914M-DT</b> Vandal Resistant Trim Use w/Von Duprin 98/9975 Series Mortise Exit Devices	Stainless	VR910M-DT US32D	630	-	-	1	1	310.50	-
		VR914M-DT US32D	630	-	-	1	1	310.50	-
<b>VR910M-NL/VR914M-NL</b> Vandal Resistant Trim Use w/Von Duprin 98/9975 Series Mortise Exit Devices	Stainless	VR910M-NL LHR US32D	630	-	-	1	1	310.50	-
		VR910M-NL RHR US32D	630	-	-	1	1	310.50	-
		VR914M-NL LHR US32D	630	-	-	1	1	310.50	-
		VR914M-NL RHR US32D	630	-	-	1	1	310.50	-
<b>919</b> Flush Pull, Oval 4-23/32" High X 1-19/22" Wide x 15/32" Deep 	Brass	919-626	626	-	-	1	2	78.30	-
<b>950</b> Flush Pull, Rectangular 3-3/4" High X 2-7/8" Wide x 11/16" Deep 	Brass	950-605	605	-	-	1	2	87.80	-
		950-613	613	-	-	1	2	91.70	-
		950-619	619	-	-	1	2	87.80	-
		950-625	625	-	-	1	2	87.80	-
		950-626**	626	-	-	1	2	70.20	-

HINGES  
 CONTINUOUS HINGES  
 PIVOTS  
 Numerical 1-059  
 Numerical 59-437  
 Numerical 438-1021  
 Numerical 1152-8190  
 Numerical 8200-9266





Lead time exception: \*\* Products are stocked and will typically ship in 3-5 days

Bold pricing indicates item is in stock and available for **Fast Track** and **ProXpress**

	MODEL	SUBSTRATE	MODEL NUMBER	BHMA FINISH	WEIGHT	MUST BE ORDERED IN MULTIPLE QTY	MULTIPLE QTY	PACKED PER BOX	LIST PRICE		
									EACH	PACKAGE	
HINGES	<b>955</b> Flush Pull, Rectangular 4-5/8" High X 3-29/32" Wide x 1-3/16" Deep 	Brass	955-613	613	-	-	1	2	\$148.40	-	
			955-626	626	-	-	1	2	113.40	-	
CONTINUOUS HINGES	<b>960</b> Flush Pull, Rectangular 3-1/16" High X 1-7/8" Wide x 9/16" Deep 	Brass	960-605	605	-	-	1	2	39.20	-	
			960-613	613	-	-	1	2	40.50	-	
			960-619	619	-	-	1	2	39.20	-	
			960-625	625	-	-	1	2	39.20	-	
			960-626	626	-	-	1	2	31.00	-	
PIVOTS	<b>962</b> Flush Pull, Rectangular Black Inset 3-15/16" High X 2-7/16" Wide x 19/32" Deep	Brass	962-613	613	-	-	1	2	83.50	-	
			962-626	626	-	-	1	2	64.70	-	
Numerical 1-059	<b>990</b> Sliding Door Pull Doors 1-1/8" to 1-1/2" 	Aluminum	990A3	666	-	-	1	10	8.50	-	
			990A5	-	-	-	1	10	8.50	-	
			990A14	669	-	-	1	10	8.50	-	
			990A15**	670	-	-	1	10	9.50	-	
			990A26D	702	-	-	1	10	8.50	-	
			990A-643E/716	-	-	-	1	10	8.50	-	
		Brass	990B3	605	1.9	-	-	1	5	13.00	-
			990B-613**	613	1.9	-	-	1	5	<b>15.00</b>	-
			990B-619**	619	1.9	-	-	1	5	<b>15.00</b>	-
			990B26**	625	1.9	-	-	1	5	15.00	-
			990B26D	626	1.9	-	-	1	5	15.00	-
			990B-643E/716**	-	1.9	-	-	1	5	15.00	-
			990B-BLK	622	1.9	-	-	1	5	15.00	-
			Numerical 59-437	<b>991</b> Sliding Door Pull Privacy Doors 1-1/8" to 1-1/2" Thumb Turn on One Side Emergency Turn on Other Side 	Aluminum	991A3	666	-	-	1	10
991A5	-	-				-	1	10	10.00	-	
991A14	669	-				-	1	10	11.50	-	
991A15**	670	-				-	1	10	11.50	-	
991A26D	702	-				-	1	10	11.50	-	
991A-643E/716	-	-				-	1	10	11.50	-	
Brass	991B3**	605			2.3	-	-	1	5	18.30	-
	991B-613**	613			2.3	-	-	1	5	<b>20.90</b>	-
	991B-619**	619			2.3	-	-	1	5	<b>20.90</b>	-
	991B26**	625			2.3	-	-	1	5	<b>20.90</b>	-
	991B26D	626			2.3	-	-	1	5	20.90	-
	991B-643E/716**	-			2.3	-	-	1	5	<b>20.90</b>	-
	991B-BLK	622			2.3	-	-	1	5	20.90	-
	Numerical 438-1021	<b>991</b> Sliding Door Pull Privacy Doors 1-1/8" to 1-1/2" Thumb Turn on One Side Emergency Turn on Other Side 			Aluminum	991A3	666	-	-	1	10
991A5			-	-		-	1	10	10.00	-	
991A14			669	-		-	1	10	11.50	-	
991A15**			670	-		-	1	10	11.50	-	
991A26D			702	-		-	1	10	11.50	-	
991A-643E/716			-	-		-	1	10	11.50	-	
Brass			991B3**	605	2.3	-	-	1	5	18.30	-
			991B-613**	613	2.3	-	-	1	5	<b>20.90</b>	-
			991B-619**	619	2.3	-	-	1	5	<b>20.90</b>	-
			991B26**	625	2.3	-	-	1	5	<b>20.90</b>	-
			991B26D	626	2.3	-	-	1	5	20.90	-
			991B-643E/716**	-	2.3	-	-	1	5	<b>20.90</b>	-
			991B-BLK	622	2.3	-	-	1	5	20.90	-
			Numerical 1152-8190	<b>991</b> Sliding Door Pull Privacy Doors 1-1/8" to 1-1/2" Thumb Turn on One Side Emergency Turn on Other Side 	Aluminum	991A3	666	-	-	1	10
991A5	-	-				-	1	10	10.00	-	
991A14	669	-				-	1	10	11.50	-	
991A15**	670	-				-	1	10	11.50	-	
991A26D	702	-				-	1	10	11.50	-	
991A-643E/716	-	-				-	1	10	11.50	-	
Brass	991B3**	605			2.3	-	-	1	5	18.30	-
	991B-613**	613			2.3	-	-	1	5	<b>20.90</b>	-
	991B-619**	619			2.3	-	-	1	5	<b>20.90</b>	-
	991B26**	625			2.3	-	-	1	5	<b>20.90</b>	-
	991B26D	626			2.3	-	-	1	5	20.90	-
	991B-643E/716**	-			2.3	-	-	1	5	<b>20.90</b>	-
	991B-BLK	622			2.3	-	-	1	5	20.90	-
	Numerical 8200-9266	<b>991</b> Sliding Door Pull Privacy Doors 1-1/8" to 1-1/2" Thumb Turn on One Side Emergency Turn on Other Side 			Aluminum	991A3	666	-	-	1	10
991A5			-	-		-	1	10	10.00	-	
991A14			669	-		-	1	10	11.50	-	
991A15**			670	-		-	1	10	11.50	-	
991A26D			702	-		-	1	10	11.50	-	
991A-643E/716			-	-		-	1	10	11.50	-	
Brass			991B3**	605	2.3	-	-	1	5	18.30	-
			991B-613**	613	2.3	-	-	1	5	<b>20.90</b>	-
			991B-619**	619	2.3	-	-	1	5	<b>20.90</b>	-
			991B26**	625	2.3	-	-	1	5	<b>20.90</b>	-
			991B26D	626	2.3	-	-	1	5	20.90	-
			991B-643E/716**	-	2.3	-	-	1	5	<b>20.90</b>	-
			991B-BLK	622	2.3	-	-	1	5	20.90	-

Lead time exception: \*\* Products are stocked and will typically ship in 3-5 days

Bold pricing indicates item is in stock and available for **Fast Track** and **ProXpress**

MODEL	SUBSTRATE	MODEL NUMBER	BHMA FINISH	WEIGHT	MUST BE ORDERED IN MULTIPLE QTY	MULTIPLE QTY	PACKED PER BOX	LIST PRICE	
								EACH	PACKAGE
<b>RL1152</b> Combination Roller Latch/Applied Stop 	Brass	RL1152 US3	605	-	-	-	-	\$152.70	-
		RL1152 US4	606	-	-	-	-	144.70	-
		RL1152 US10	612	-	-	-	-	144.70	-
		RL1152 US10B	613	-	-	-	-	152.70	-
		RL1152 US15	619	-	-	-	-	152.70	-
		RL1152 US26	625	-	-	-	-	152.70	-
		RL1152 US26D**	626	-	-	-	-	<b>149.50</b>	-
		RL1152 643E/716	-	-	-	-	-	152.70	-
		RL1152 BLK	622	-	-	-	-	152.70	-
<b>FS1153/FS1154</b> Plunger Type Door Holder 	Aluminum	FS1153 US28**	628	-	-	-	-	<b>53.60</b>	-
	Brass	FS1154 US3	605	-	-	-	-	96.40	-
		FS1154 US4	606	-	-	-	-	96.40	-
		FS1154 US10	612	-	-	-	-	<b>96.40</b>	-
		FS1154 US10B	613	-	-	-	-	96.40	-
		FS1154 US26	625	-	-	-	-	96.40	-
FS1154 US26D**	626	-	-	-	-	96.40	-		
<b>SB1600M1</b> Handle Up 1 1/2" Steel Bolt B-Packed w/Mortise Strikes T-Packed w/Universal Strikes L-Locking Version* UL Listed 	Steel	SB1600M1-B SP28	689	-	-	-	-	136.60	-
		SB1600M1-B SP10	691	-	-	-	-	144.40	-
		SB1600M1-B BLK	-	-	-	-	-	144.40	-
		SB1600M1-B SP313	695	-	-	-	-	136.60	-
		SB1600M1-B SP4	706	-	-	-	-	144.40	-
		SB1600M1-T SP10	691	-	-	-	-	144.40	-
		SB1600M1-T SP28	689	-	-	-	-	136.60	-
		SB1600M1-T SP313	695	-	-	-	-	136.60	-
		SB1600M1-T BLK	-	-	-	-	-	144.40	-
		SB1600M1-T SP4	706	-	-	-	-	144.40	-
		SB1600M1-BL SP10	691	-	-	-	-	191.90	-
		SB1600M1-BL SP28	689	-	-	-	-	198.90	-
		SB1600M1-BL SP313	695	-	-	-	-	198.90	-
		SB1600M1-BL BLK	-	-	-	-	-	199.70	-
		SB1600M1-BL SP4	706	-	-	-	-	191.90	-
		SB1600M1-TL SP10	691	-	-	-	-	199.70	-
		SB1600M1-TL SP28	689	-	-	-	-	199.70	-
		SB1600M1-TL SP313	695	-	-	-	-	191.90	-
SB1600M1-TL BLK	-	-	-	-	-	191.90	-		
SB1600M1-TL SP4	706	-	-	-	-	199.70	-		
<b>SB1600M2</b> Handle Up 1 1/2" Steel Bolt B-Packed w/Mortise Strikes T-Packed w/Universal Strikes L-Locking Version* UL Listed 	Steel	SB1600M2-B SP4	706	-	-	-	-	144.40	-
		SB1600M2-B SP10	691	-	-	-	-	144.40	-
		SB1600M2-B SP28	689	-	-	-	-	136.60	-
		SB1600M2-B SP313	695	-	-	-	-	136.60	-
		SB1600M2-B BLK	-	-	-	-	-	144.40	-
		SB1600M2-BL SP4	706	-	-	-	-	199.70	-
		SB1600M2-T SP10	691	-	-	-	-	144.40	-
		SB1600M2-T SP28	689	-	-	-	-	136.60	-
		SB1600M2-T SP313	695	-	-	-	-	136.60	-
		SB1600M2-T BLK	-	-	-	-	-	144.40	-
		SB1600M2-T SP4	706	-	-	-	-	144.40	-
		SB1600M2-BL SP10	691	-	-	-	-	199.70	-
		SB1600M2-BL SP28	689	-	-	-	-	198.90	-
		SB1600M2-BL SP313	695	-	-	-	-	198.90	-
		SB1600M2-BL BLK	-	-	-	-	-	199.70	-
		SB1600M2-TL SP4	706	-	-	-	-	199.70	-
		SB1600M2-TL SP10	691	-	-	-	-	199.70	-
		SB1600M2-TL SP28	689	-	-	-	-	198.90	-
SB1600M2-TL SP313	695	-	-	-	-	198.90	-		
SB1600M2-TL BLK	-	-	-	-	-	199.70	-		

\* Lock default code = 1289. Alternative Codes: 1360/1390/1395.



Lead time exception: \*\* Products are stocked and will typically ship in 3-5 days

Bold pricing indicates item is in stock and available for **Fast Track** and **ProXpress**

HINGES  
 CONTINUOUS HINGES  
 PIVOTS  
 Numerical 1-059  
 Numerical 59-437  
 Numerical 438-1021  
 Numerical 1152-8190  
 Numerical 8200-9266





HINGES  
CONTINUOUS HINGES  
PIVOTS  
Numerical 1-059  
Numerical 59-437  
Numerical 438-1021  
Numerical 1152-8190  
Numerical 8200-9266

MODEL	SUBSTRATE	MODEL NUMBER	BHMA FINISH	WEIGHT	MUST BE ORDERED IN MULTIPLE QTY	MULTIPLE QTY	PACKED PER BOX	LIST PRICE	
								EACH	PACKAGE
<b>SB1630</b> <b>8" Steel Bolts</b> B-Packed w/Mortise Strikes T-Packed w/Universal Strikes L-Locking Version*  UL Listed  	Steel	SB1630-B US2G	603	--	--	--	--	<b>\$46.10</b>	--
		SB1630-B US10B	640	--	--	--	--	106.40	--
		SB1630-B US26D	652	--	--	--	--	65.80	--
		SB1630-T US2G	603	--	--	--	--	<b>51.30</b>	--
		SB1630-T US10B	640	--	--	--	--	111.50	--
		SB1630-T US26D	652	--	--	--	--	72.30	--
		SB1630-BL US2G	603	--	--	--	--	99.80	--
		SB1630-BL US10B	640	--	--	--	--	143.30	--
		SB1630-BL US26D	652	--	--	--	--	119.60	--
		SB1630-TL US2G	603	--	--	--	--	82.90	--
		SB1630-TL US10B	640	--	--	--	--	151.20	--
		SB1630-TL US26D	652	--	--	--	--	130.10	--
		SB1630-TB US2G	603	--	--	--	--	<b>60.80</b>	--
		SB1630-TB US10B	640	--	--	--	--	126.10	--
		SB1630-TB US26D	652	--	--	--	--	84.00	--
		SB1630-TBL US2G	603	--	--	--	--	95.90	--
SB1630-TBL US10B	640	--	--	--	--	162.70	--		
SB1630-TBL US26D	652	--	--	--	--	143.30	--		
<b>SB1640</b> <b>8" Steel Bolts</b> B-Packed w/Mortise Strikes T-Packed w/Universal Strikes L-Locking Version*  	Brass	SB1640-B US3	605	--	--	--	--	130.10	--
		SB1640-B US10B	613	--	--	--	--	130.10	--
		SB1640-B US26D	626	--	--	--	--	117.00	--
		SB1640-T US3	605	--	--	--	--	136.60	--
		SB1640-T US10B	613	--	--	--	--	136.60	--
		SB1640-T US26D	626	--	--	--	--	126.10	--
		SB1640-BL US3	605	--	--	--	--	173.50	--
		SB1640-BL US10B	613	--	--	--	--	173.50	--
		SB1640-BL US26D	626	--	--	--	--	160.40	--
		SB1640-TL US3	605	--	--	--	--	182.60	--
SB1640-TL US10B	613	--	--	--	--	182.60	--		
SB1640-TL US26D	626	--	--	--	--	168.20	--		

\* Lock default code = 1289. Alternative Codes: 1360/1390/1395.

Lead time exception: \*\* Products are stocked and will typically ship in 3-5 days

Bold pricing indicates item is in stock and available for **Fast Track** and **ProXpress**

MODEL	SUBSTRATE	MODEL NUMBER	VIEW NUMBER & FINISH	BHMA FINISH	WEIGHT	MUST BE ORDERED IN			LIST PRICE	
						MULTIPLE QTY	MULTIPLE QTY	PACKED PER BOX	EACH	PACKAGE
<b>3125</b> Door Knocker 	Brass	02-3125-605	-	605	1	-	-	1	29.50	-
		02-3125-609	-	609	1	-	-	1	34.70	-
		02-3125-619	-	619	1	-	-	1	34.70	-
		02-3125-625	-	625	1	-	-	1	34.70	-
		02-3125-626	-	626	1	-	-	1	29.50	-
		02-3125-643E/716	-	-	1	-	-	1	34.70	-
		02-3125-BLK	-	622	1	-	-	1	34.70	-
<b>31251/31252</b> Knocker/Viewer Available w/UL Viewer Only 	Brass	02-31251U-605	U700 w 606 viewer	605	-	-	-	1	42.80	-
		02-31251U-619	U700 w 619 viewer	619	-	-	-	1	48.80	-
		02-31251U-625	U700 w 625 viewer	625	-	-	-	1	48.80	-
		02-31251U-626	U700 w 626 viewer	626	-	-	-	1	48.80	-
		02-31251U-643E/716	U700 w 10B viewer	-	-	-	-	1	40.60	-
		02-31251U-BLK	U700 w BLK viewer	622	-	-	-	1	48.80	-
		02-31252U-605	U701 w 606 viewer	605	-	-	-	1	44.60	-
		02-31252U-619	U701 w 619 viewer	619	-	-	-	1	50.90	-
		02-31252U-625	U701 w 625 viewer	625	-	-	-	1	50.90	-
		02-31252U-626**	U701 w 626 viewer	626	-	-	-	1	50.90	-
		02-31252U-643E/716	U701 w 10B viewer	-	-	-	-	1	42.50	-
		02-31252U-BLK	U701 w BLK viewer	622	-	-	-	1	50.90	-

HINGES  
 CONTINUOUS HINGES  
 PIVOTS  
 Numerical 1-059  
 Numerical 59-437  
 Numerical 438-1021  
 Numerical 1152-8190  
 Numerical 8200-9266

Lead time exception: \*\* Products are stocked and will typically ship in 3-5 days

Bold pricing indicates item is in stock and available for **Fast Track** and **ProXpress**

# 8100/8300/9100/9200 Series Pulls

8169/8181/8281/8189/8312/8320/8371/8372/8373/8700/8800/8848/8975 - Decorative Series

## Mounting Methods

HINGES  
 CONTINUOUS HINGES  
 PIVOTS  
 Numerical 1-059  
 Numerical 59-437  
 Numerical 438-1021  
 Numerical 1152-8190  
 Numerical 8200-9266

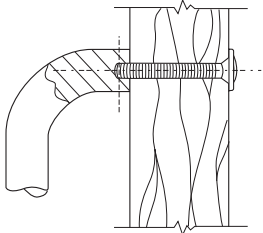
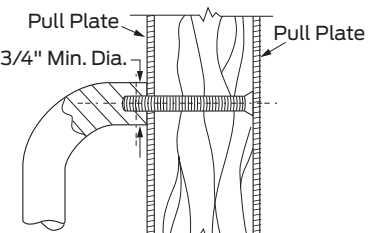
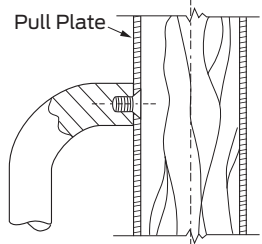
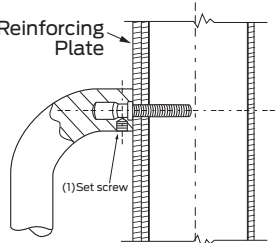
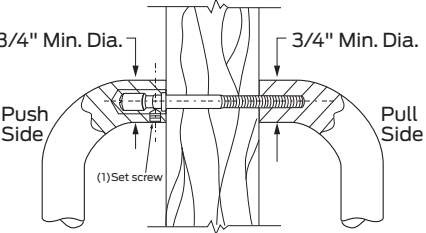
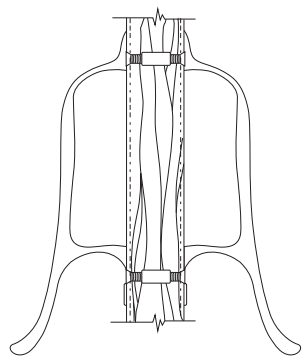
<p><b>Type Standard Mount</b></p>  <p><b>Standard Mounting</b></p>	<p><b>Type F Mount</b></p>  <p><b>Wood Doors Concealed Pull Mounting With Push Plate</b></p>	<p><b>Type G Mount</b></p>  <p><b>Concealed Pull Plate Mounting</b></p>
<p><b>Type L Mount</b></p>  <p><b>Reinforced Hollow Metal Door Concealed Pull Mounting</b></p>	<p><b>Type J or N Mount</b></p>  <p><b>Back to Back "Two-Anchor" Wood or Metal Door</b></p>	 <p><b>Back to Back Pull Mounting</b></p>

Lead time exception: \*\* Products are stocked and will typically ship in 3-5 days

Bold pricing indicates item is in stock and available for **Fast Track** and **ProXpress**

# 8100/8300/9100/9200 Series Pulls

8169/8181/8281/8189/8312/8320/8371/8372/8373/8700/8800/8848/8975 - Decorative Series

## Mounting Methods

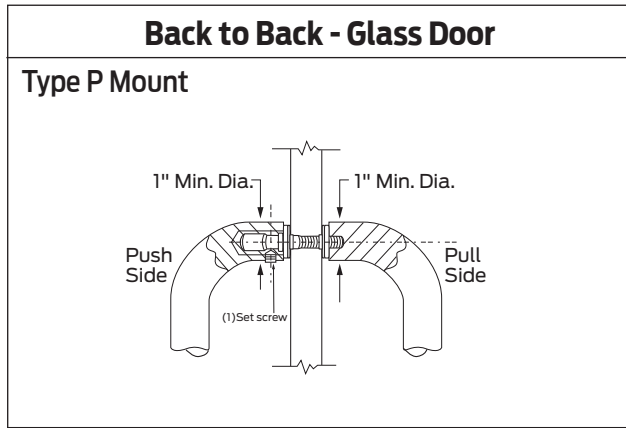
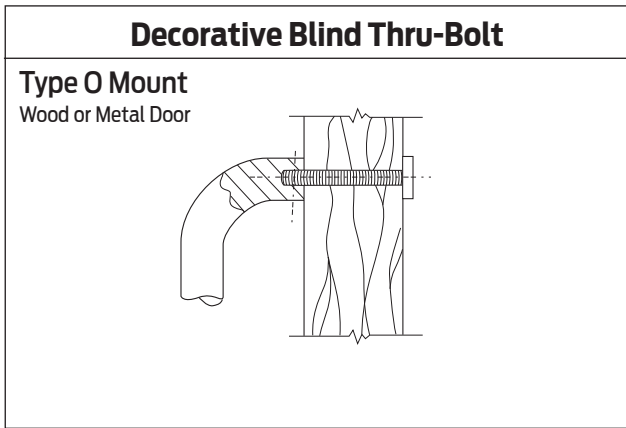

HINGES

CONTINUOUS HINGES

PIVOTS

Numerical  
1-059

Numerical  
59-437

Numerical  
438-1021

Numerical  
1152-8190

Numerical  
8200-9266

**Lead time exception:** \*\* Products are stocked and will typically ship in 3-5 days

*Bold pricing indicates item is in stock and available for **Fast Track** and **ProXpress***

# 8100/8200/8300/9100/9200 - Series

8169/8181/8281/8189/8312/8320/8371/8372/8373/8700/8800/8848/8975 - Decorative Series

## Special Pricing Information

- Through bolt fasteners are for standard 1-3/4" thick doors.
- Specify door thickness if other than standard. \$25 List Add for door thicknesses greater than 2.1/4".
- All screws are furnished standard as Phillips Head Drive.
- For fasteners other than shown contact our Customer Service Department for availability.

	Suffix		List Add	
Optional Mounting Types:	No Suffix Req'd	Standard (Provided with all single pulls unless other mount noted.)	8102HD, 8103HD, 8103EZHD, 8105, 8111-5, 8145EZHD, 8190HD, 8190EZHD, 8302, 8303, 8305, 8311, 9100HD, 9264, 9266 8169, 8181, 8281, 8189, 8312, 8320, 8371, 8372, 8373, 8700, 8800, 8848, 8975	No Additional Charge
	A	Concealed (One side, Aluminum)	8103HD, 8103EZHD, 8145EZHD, 8190HD, 8190EZHD, 8303, 9100HD, 9264, 9266 8169, 8181, 8281, 8189, 8312, 8320, 8371, 8848, 8975	19.00
	F	Countersunk Thru Bolt	8102HD, 8103HD, 8103EZHD, 8105, 8111-5, 8145EZHD, 8190HD, 8190EZHD, 8302, 8303, 8305, 8311, 9100HD 8169, 8181, 8281, 8189, 8312, 8320, 8371, 8372, 8373, 8700, 8800, 8848, 8975	No Additional Charge
	G	Concealed Pull Plate	8102, 8103, 8111, 8300, 8302, 8303, 8311	No Additional Charge
	I	Concealed (One Side, Wood Door)	8102HD, 8103HD, 8103EZHD, 8145EZHD, 8190HD, 8190EZHD, 8302, 8303, 9100HD, 9264, 9266 8169, 8181, 8281, 8189, 8312, 8320, 8371, 8372, 8373, 8700, 8800, 8848, 8975	13.00
	J*	Back to Back (Wood/Hollow Metal - 3/4" Round and Flat)	8102HD, 8302 8372, 8373, 8700, 8800	27.00
	K*	Back to Back (8121)	8121	9.00
	L	Concealed (One Side, Hollow Metal)	8103HD, 8103EZHD, 8145EZHD, 8190HD, 8190EZHD, 8303, 9100HD, 9264, 9266 8169, 8181, 8281, 8189, 8312, 8320, 8371, 8372, 8373, 8700, 8800, 8848, 8975	19.00
	N*	Back to Back (Wood/Hollow Metal - 1" Round)	8103HD, 8103EZHD, 8145EZHD, 8190HD, 8190EZHD, 8303, 9100HD, 9264, 9266 8169, 8181, 8281, 8189, 8312, 8320, 8371, 8848, 8975	27.00
	NO	Push Bar and Pull - Back to Back & Decorative Blind Thru Bolt (Wood/Hollow Metal)	9100HD, 9103EZHD, 9145EZHD, 9190HD, 9190EZHD	40.00
	NS	Push Bar and Pull - Back to Back & Standard (Wood/Hollow Metal)	9100HD, 9103EZHD, 9145EZHD, 9190HD, 9190EZHD	No Additional Charge
	O	Decorative Blind Thru Bolt (Wood/Hollow Metal)	8103HD, 8103EZHD, 8145EZHD, 8190HD, 8190EZHD, 9100HD, 9264, 9266 8169, 8181, 8281, 8189, 8312, 8320, 8371, 8848, 8975	31.00
	P*	Back to Back (1/2" Glass)	8103HD, 8103EZHD, 8145EZHD, 8190HD, 8190EZHD, 9100HD, 9264, 9266 8169, 8181, 8281, 8189, 8312, 8320, 8371, 8848, 8975	32.00
	PQ	Push Bar and Pull - Back to Back and Decorative Blind Thru Bolt (1/2" Glass)	9100HD, 9103EZHD, 9145EZHD, 9190HD, 9190EZHD	67.00
	Q	Decorative Blind Thru Bolt (1/2" Glass)	8103HD, 8103EZHD, 8145EZHD, 8190HD, 8190EZHD, 9100HD, 9264, 9266 8169, 8181, 8281, 8189, 8312, 8320, 8371, 8848, 8975	43.00
X	Security Thru Bolt with Std. Washer.	8103HD, 8103EZHD, 8145EZHD, 8190HD, 8190EZHD, 8303, 9100HD, 9264, 9266 8169, 8181, 8281, 8189, 8312, 8320, 8371, 8848, 8975	53.00 - 613/US10B 33.00 all other Finishes	
	<b>Prefix</b>			
	* PR	Order as pair with model numbers (e.g. - PR8103EZ)	Double the list price for single unit and add mounting price from above.	
	SGL	Single pull model machined for back to back application.	Based on mounting	
	<b>Model</b>			
Optional Custom Lengths: (available in 1" increments, fractional increments available as engineered specials)	9100HD, 9103EZHD, 9145EZHD, 9190HD, 9190EZHD	For lengths <28"	Same as 28" List Price	
		For lengths >28" and <33"	Same as 33" List Price	
		For lengths >33"	9.00/additional inch	
		Fractional increments available as engineered specials. List Add in addition to custom length pricing	174.00 List Add	
Optional Finish	AM	Anti-microbial Coating - US26D or US32D finishes only	38.00	
Optional Cut-Outs:	CFC	Cut for cylinder on 8200/8300 Series Push or Pull Plates (1-1/4" diameter)	6.75	
	CFT	Cut for Thumbturn on 8200/8300 Series Push or Pull Plates (3/8" diameter)	7.75	
Plates ordered for cut-out for cylinder or thumbturn, cutout is positioned 2" from top and centered in the plate width, up to 4" wide plates. For plates over 4" in width, cut-out is located 2" from edge. Please specify Door Handing LH or RH when ordering plates wider than 4".				
	<b>Model</b>	<b>Description</b>	<b>List Add</b>	
Optional Plate:	8300	For plate pierced for Pull, order 8300 Series Specify Center to Center dimension (5-1/4", 6", 8", 10"), Finish, and Plate Size	(to 8200 list price) 2.50	

Lead time exception: \*\* Products are stocked and will typically ship in 3-5 days

Bold pricing indicates item is in stock and available for **Fast Track** and **ProXpress**

MODEL	PULL CTC	SUBSTRATE	MODEL NUMBER	BHMA FINISH	WEIGHT	MUST BE ORDERED IN MULTIPLE QTY	MULTIPLE QTY	PACKED PER BOX	LIST PRICE	
									EACH	PACKAGE
<b>8102HD</b> Straight Door Pull 3/4" Round, 1-1/2" Clearance  Antimicrobial Coating US26D-AM or US32D-AM available.  See page 64 for optional mounting types and pricing.	6"	Brass	8102HD-6 US3	605	-	-	1	-	\$51.80	-
			8102HD-6 US4	606	-	-	1	-	51.80	-
			8102HD-6 US10	612	-	-	1	-	59.10	-
			8102HD-6 US10B	613	-	-	1	-	61.20	-
			8102HD-6 US15	619	-	-	1	-	61.20	-
			8102HD-6 US26	625	-	-	1	-	58.30	-
		8102HD-6 US26D	626	-	-	1	-	51.80	-	
		Aluminum	8102HD-6 US28	628	-	-	1	-	20.70	-
		Stainless	8102HD-6 US32D**	630	-	-	1	-	31.30	-
	8102HD-6 643E/716		-	-	-	1	-	61.20	-	
	8102HD-6 BLK		-	-	-	1	-	51.80	-	
	8"	Brass	8102HD-8 US3	605	-	-	1	-	58.30	-
			8102HD-8 US4	606	-	-	1	-	58.30	-
			8102HD-8 US10	612	-	-	1	-	66.80	-
			8102HD-8 US10B	613	-	-	1	-	69.10	-
			8102HD-8 US15	619	-	-	1	-	69.10	-
			8102HD-8 US26	625	-	-	1	-	64.80	-
		8102HD-8 US26D	626	-	-	1	-	58.30	-	
		Aluminum	8102HD-8 US28	628	-	-	1	-	21.50	-
		Stainless	8102HD-8 US32D	630	-	-	1	-	35.30	-
	8102HD-8 643E/716		-	-	-	1	-	69.10	-	
	8102HD-8 BLK		-	-	-	1	-	58.30	-	
	10"	Brass	8102HD-0 US3	605	-	-	1	-	68.10	-
			8102HD-0 US4	606	-	-	1	-	68.10	-
8102HD-0 US10			612	-	-	1	-	78.50	-	
8102HD-0 US10B			613	-	-	1	-	80.50	-	
8102HD-0 US15			619	-	-	1	-	80.50	-	
8102HD-0 US26			625	-	-	1	-	66.40	-	
8102HD-0 US26D		626	-	-	1	-	66.80	-		
Aluminum		8102HD-0 US28	628	-	-	1	-	23.00	-	
Stainless		8102HD-0 US32D	630	-	-	1	-	41.40	-	
	8102HD-0 643E/716	-	-	-	1	-	80.50	-		
	8102HD-0 BLK	-	-	-	1	-	68.10	-		
<b>8103HD</b> Straight Door Pull 1" Round, 1-1/2" Clearance  Antimicrobial Coating US26D-AM or US32D-AM available.  See page 64 for optional mounting types and pricing.	8"	Brass	8103HD-8 US3	605	-	-	1	-	0.00	-
			8103HD-8 US4	606	-	-	1	-	103.50	-
			8103HD-8 US10	612	-	-	1	-	103.50	-
			8103HD-8 US10B	613	-	-	1	-	116.50	-
			8103HD-8 US15	619	-	-	1	-	120.70	-
			8103HD-8 US26	625	-	-	1	-	120.70	-
		8103HD-8 US26D	626	-	-	1	-	110.20	-	
		Aluminum	8103HD-8 US28	628	-	-	1	-	103.90	-
		Stainless	8103HD-8 US32	629	-	-	1	-	30.00	-
	8103HD-8 US32D		630	-	-	1	-	74.50	-	
	8103HD-8 643E/716		-	-	-	1	-	61.50	-	
	8103HD-8 BLK		-	-	-	1	-	120.70	-	
	8103HD-8 US3		605	-	-	1	-	103.50	-	
	10"	Brass	8103HD-0 US4	606	-	-	1	-	114.30	-
			8103HD-0 US10	612	-	-	1	-	114.30	-
			8103HD-0 US10B	613	-	-	1	-	131.50	-
			8103HD-0 US15	619	-	-	1	-	131.50	-
			8103HD-0 US26	625	-	-	1	-	136.00	-
			8103HD-0 US26D	626	-	-	1	-	120.70	-
		Aluminum	8103HD-0 US28	628	-	-	1	-	114.30	-
		Stainless	8103HD-0 US32	629	-	-	1	-	31.50	-
			8103HD-0 US32D**	630	-	-	1	-	<b>82.70</b>	-
			8103HD-0 643E/716	-	-	-	1	-	69.00	-
			8103HD-0 BLK	-	-	-	1	-	131.50	-
									114.30	

HINGES  
 CONTINUOUS HINGES  
 PIVOTS  
 Numerical 1-059  
 Numerical 59-437  
 Numerical 438-1021  
 Numerical 1152-8190  
 Numerical 8200-9266



Continued on next page.

Lead time exception: \*\* Products are stocked and will typically ship in 3-5 days

Bold pricing indicates item is in stock and available for **Fast Track** and **ProXpress**



HINGES  
 CONTINUOUS HINGES  
 PIVOTS  
 Numerical 1-059  
 Numerical 59-437  
 Numerical 438-1021  
 Numerical 1152-8190  
 Numerical 8200-9266

MODEL	PULL CTC	SUBSTRATE	MODEL NUMBER	BHMA FINISH	WEIGHT	MUST BE ORDERED IN MULTIPLE QTY	MULTIPLE QTY	PACKED PER BOX	LIST PRICE			
									EACH	PACKAGE		
<b>8103HD</b> Straight Door Pull 1" Round, 1-1/2" Clearance  <i>Continued from previous page.</i>	12"	Brass	8103HD-2 US3	605	-	-	1	-	\$124.90	-		
			8103HD-2 US4	606	-	-	1	-	124.90	-		
			8103HD-2 US10	612	-	-	1	-	146.50	-		
			8103HD-2 US10B	613	-	-	1	-	148.90	-		
			8103HD-2 US15	619	-	-	1	-	148.90	-		
			8103HD-2 US26	625	-	-	1	-	132.80	-		
			8103HD-2 US26D	626	-	-	1	-	127.30	-		
		Aluminum	8103HD-2 US28	628	-	-	1	-	33.20	-		
		Stainless	8103HD-2 US32	629	-	-	1	-	90.70	-		
			8103HD-2 US32D	630	-	-	1	-	79.40	-		
8103HD-2 643E/716	-		-	-	1	-	148.90	-				
8103HD-2 BLK	-	-	-	1	-	124.90	-					
<b>8103EZHD</b> Straight Door Pull 1" Round, 2-1/2" Clearance Antimicrobial Coating US26D-AM or US32D-AM available. See page 64 for optional mounting types and pricing. 	8"	Brass	8103EZHD-8 US3	605	-	-	1	-	112.70	-		
			8103EZHD-8 US4	606	-	-	1	-	112.70	-		
			8103EZHD-8 US10	612	-	-	1	-	125.40	-		
			8103EZHD-8 US10B	613	-	-	1	-	129.50	-		
			8103EZHD-8 US15	619	-	-	1	-	129.50	-		
			8103EZHD-8 US26	625	-	-	1	-	118.80	-		
			8103EZHD-8 US26D	626	-	-	1	-	112.90	-		
			Aluminum	8103EZHD-8 US28	628	-	-	1	-	40.30	-	
		316 Stainless	8103EZHD-8 US32	629-316	-	-	1	-	98.80	-		
			8103EZHD-8 US32D	630-316	-	-	1	-	86.10	-		
			8103EZHD-8 643E/716	-	-	-	1	-	129.50	-		
			8103EZHD-8 BLK	-	-	-	1	-	112.70	-		
			10"	Brass	8103EZHD-0 US3	605	-	-	1	-	123.20	-
					8103EZHD-0 US4	606	-	-	1	-	123.20	-
	8103EZHD-0 US10	612			-	-	1	-	140.40	-		
	8103EZHD-0 US10B	613			-	-	1	-	144.70	-		
	8103EZHD-0 US15	619			-	-	1	-	144.70	-		
	8103EZHD-0 US26	625			-	-	1	-	129.50	-		
	Aluminum	8103EZHD-0 US26D	626	-	-	1	-	123.20	-			
	316 Stainless	8103EZHD-0 US28	628	-	-	1	-	42.10	-			
		8103EZHD-0 32-316	629-316	-	-	1	-	108.40	-			
		8103EZHD-0 32D-316	630-316	-	-	1	-	<b>95.40</b>	-			
		8103EZHD-0 643E/716	-	-	-	1	-	144.70	-			
		8103EZHD-0 BLK	-	-	-	1	-	123.20	-			
	12"	Brass	8103EZHD-2 US3	605	-	-	1	-	133.80	-		
			8103EZHD-2 US4	606	-	-	1	-	133.80	-		
			8103EZHD-2 US10	612	-	-	1	-	155.50	-		
			8103EZHD-2 US10B	613	-	-	1	-	157.70	-		
8103EZHD-2 US15			619	-	-	1	-	157.70	-			
8103EZHD-2 US26			625	-	-	1	-	141.70	-			
8103EZHD-2 US26D			626	-	-	1	-	136.30	-			
Aluminum			8103EZHD-2 US28	628	-	-	1	-	43.90	-		
316 Stainless		8103EZHD-2 32-316	629-316	-	-	1	-	117.80	-			
		8103EZHD-2 32D-316	630-316	-	-	1	-	104.40	-			
	8103EZHD-2 643E/716	-	-	-	1	-	157.70	-				
	8103EZHD-2 BLK	-	-	-	1	-	133.80	-				

Lead time exception: \*\* Products are stocked and will typically ship in 3-5 days

Bold pricing indicates item is in stock and available for **Fast Track** and **ProXpress**

MODEL	PULL CTC	SUBSTRATE	MODEL NUMBER	BHMA FINISH	WEIGHT	MUST BE ORDERED IN MULTIPLE QTY	MULTIPLE QTY	PACKED PER BOX	LIST PRICE	
									EACH	PACKAGE
<b>8105</b> <b>Straight Door Pull</b> <b>1" Flattened 1/2 Round,</b> <b>1-1/2" Clearance</b>  Antimicrobial Coating US26D-AM or US32D-AM available.  See page 64 for optional mounting types and pricing.	6"	Brass	8105-6 US3	605	-	-	1	-	\$56.40	-
			8105-6 US4	606	-	-	1	-	56.40	-
			8105-6 US10	612	-	-	1	-	69.30	-
			8105-6 US10B	613	-	-	1	-	71.20	-
			8105-6 US15	619	-	-	1	-	71.20	-
			8105-6 US26	625	-	-	1	-	56.90	-
			8105-6 US26D	626	-	-	1	-	51.90	-
		Aluminum	8105-6 US28	628	-	-	1	-	23.60	-
		Stainless	8105-6 US32D	630	-	-	1	-	43.10	-
	8105-6 643E/716		-	-	-	1	-	71.20	-	
	8105-6 BLK		-	-	-	1	-	56.40	-	
	8"	Brass	8105-8 US3	605	-	-	1	-	87.80	-
			8105-8 US4	606	-	-	1	-	87.80	-
			8105-8 US10	612	-	-	1	-	95.40	-
			8105-8 US10B	613	-	-	1	-	95.40	-
			8105-8 US15	619	-	-	1	-	95.40	-
			8105-8 US26	625	-	-	1	-	91.50	-
			8105-8 US26D	626	-	-	1	-	91.50	-
		Aluminum	8105-8 US28	628	-	-	1	-	29.50	-
		Stainless	8105-8 US32D	630	-	-	1	-	62.80	-
	8105-8 643E/716		-	-	-	1	-	95.40	-	
8105-8 BLK	-		-	-	1	-	87.80	-		
10"	Brass	8105-0 US3	605	-	-	1	-	95.40	-	
		8105-0 US4	606	-	-	1	-	95.40	-	
		8105-0 US10	612	-	-	1	-	106.70	-	
		8105-0 US10B	613	-	-	1	-	106.70	-	
		8105-0 US15	619	-	-	1	-	106.70	-	
		8105-0 US26	625	-	-	1	-	99.20	-	
		8105-0 US26D	626	-	-	1	-	99.20	-	
	Aluminum	8105-0 US28	628	-	-	1	-	30.40	-	
	Stainless	8105-0 US32D	630	-	-	1	-	70.70	-	
8105-0 643E/716		-	-	-	1	-	106.70	-		
8105-0 BLK		-	-	-	1	-	95.40	-		
<b>8111</b> <b>Door Pull 1-3/16"</b> <b>Projection</b> Antimicrobial Coating US26D-AM or US32D-AM available.  See page 64 for optional mounting types and pricing.	5" (Actual CTC = 5-1/4")	Brass	8111-5 US3	605	-	-	1	-	53.50	-
			8111-5 US4	606	-	-	1	-	53.50	-
			8111-5 US10	612	-	-	1	-	59.70	-
			8111-5 US10B	613	-	-	1	-	59.70	-
			8111-5 US15	619	-	-	1	-	59.70	-
			8111-5 US26	625	-	-	1	-	53.50	-
			8111-5 US26D	626	-	-	1	-	57.20	-
		Aluminum	8111-5 US28	628	-	-	1	-	33.30	-
		Stainless	8111-5 US32D	630	-	-	1	-	49.40	-
			8111-5 643E/716	613	-	-	1	-	59.70	-
			8111-5 BLK	605	-	-	1	-	53.50	-
<b>8112</b> <b>Door Pull 2-3/16"</b> Antimicrobial Coating US26D-AM available. Surface Mounted	5"	Brass	8112-5 US26D**	626	-	-	1	-	41.80	-

HINGES  
 CONTINUOUS HINGES  
 PIVOTS  
 Numerical 1-059  
 Numerical 59-437  
 Numerical 438-1021  
 Numerical 1152-8190  
 Numerical 8200-9266

Lead time exception: \*\* Products are stocked and will typically ship in 3-5 days

Bold pricing indicates item is in stock and available for **Fast Track** and **ProXpress**

HINGES

CONTINUOUS HINGES

PIVOTS



Numerical 1-059

Numerical 59-437

Numerical 438-1021

Numerical 1152-8190



Numerical 8200-9266

MODEL	PULL CTC	SUBSTRATE	MODEL NUMBER	BHMA FINISH	WEIGHT	MUST BE ORDERED IN MULTIPLE QTY	MULTIPLE QTY	PACKED PER BOX	LIST PRICE	
									EACH	PACKAGE
<b>8121</b> <b>Door Pull 3-1/2"</b> Antimicrobial Coating US26D-AM available. Surface Mounted 	5"	Brass	8121-5 US26D	626	-	-	1	-	\$60.90	-
			See page 64 for optional mounting types and pricing.							
<b>8145EZHD</b> <b>45 Offset Door Pull 1"</b> <b>Round, 2-1/2" Clearance</b> Antimicrobial Coating US26D-AM or US32D-AM available. See page 64 for optional mounting types and pricing.	8"	Brass	8145EZHD-8 US3	605	-	-	1	-	128.80	-
			8145EZHD-8 US4	606	-	-	1	-	128.80	-
			8145EZHD-8 US10	612	-	-	1	-	148.60	-
			8145EZHD-8 US10B	613	-	-	1	-	148.60	-
			8145EZHD-8 US15	619	-	-	1	-	148.60	-
			8145EZHD-8 US26	625	-	-	1	-	136.50	-
			8145EZHD-8 US26D	626	-	-	1	-	136.50	-
			316 Stainless	8145EZHD-8 32-316	629-316	-	-	1	-	135.40
	8145EZHD-8 32D-316	630-316	-	-	1	-	111.70	-		
	8145EZHD-8 643E/716	-	-	-	1	-	148.60	-		
	8145EZHD-8 BLK	-	-	-	1	-	128.80	-		
	10"	Brass	8145EZHD-0 US3	605	-	-	1	-	140.50	-
			8145EZHD-0 US4	606	-	-	1	-	140.50	-
			8145EZHD-0 US10	612	-	-	1	-	157.00	-
			8145EZHD-0 US10B	613	-	-	1	-	157.00	-
			8145EZHD-0 US15	619	-	-	1	-	157.00	-
			8145EZHD-0 US26	625	-	-	1	-	148.60	-
			8145EZHD-0 US26D	626	-	-	1	-	148.60	-
			316 Stainless	8145EZHD-0 32-316	629-316	-	-	1	-	144.90
	8145EZHD-0 32D-316	630-316	-	-	1	-	121.20	-		
	8145EZHD-0 643E/716	-	-	-	1	-	157.00	-		
	8145EZHD-0 BLK	-	-	-	1	-	140.50	-		
	12"	Brass	8145EZHD-2 US3	605	-	-	1	-	148.60	-
			8145EZHD-2 US4	606	-	-	1	-	148.60	-
			8145EZHD-2 US10	612	-	-	1	-	168.90	-
			8145EZHD-2 US10B	613	-	-	1	-	168.90	-
			8145EZHD-2 US15	619	-	-	1	-	168.90	-
			8145EZHD-2 US26	625	-	-	1	-	161.10	-
			8145EZHD-2 US26D	626	-	-	1	-	161.10	-
			316 Stainless	8145EZHD-2 32-316	629-316	-	-	1	-	154.50
	8145EZHD-2 32D-316	630-316	-	-	1	-	130.80	-		
	8145EZHD-2 643E/716	-	-	-	1	-	168.90	-		
8145EZHD-2 BLK	-	-	-	1	-	148.60	-			
18"	Brass	8145EZHD-18 US3	605	-	-	1	-	201.20	-	
		8145EZHD-18 US4	606	-	-	1	-	201.20	-	
		8145EZHD-18 US10	612	-	-	1	-	225.30	-	
		8145EZHD-18 US10B	613	-	-	1	-	225.30	-	
		8145EZHD-18 US15	619	-	-	1	-	225.30	-	
		8145EZHD-18 US26	625	-	-	1	-	213.00	-	
		8145EZHD-18 US26D	626	-	-	1	-	213.00	-	
		316 Stainless	8145EZHD-18 32-316	629-316	-	-	1	-	209.00	-
8145EZHD-18 32D-316	630-316	-	-	1	-	185.50	-			
8145EZHD-18 643E/716	-	-	-	1	-	225.30	-			
8145EZHD-18 BLK	-	-	-	1	-	201.20	-			
<b>8169</b> <b>Tubular Decorative C Shaped Pull 1" Dia.</b> See page 64 for optional mounting types and pricing. 	10"	Brass	8169-10-605	605	-	-	1	-	307.60	-
			8169-10-613	613	-	-	1	-	307.60	-
			8169-10-619*	619	-	-	1	-	307.60	-
			8169-10-625*	625	-	-	1	-	307.60	-
			8169-10-626*	626	-	-	1	-	307.60	-
			Stainless	8169-10-630	630	-	-	1	-	273.50
	8169-10-BLK	-	-	-	1	-	307.60	-		
	12"	Brass	8169-12-605	605	-	-	1	-	403.30	-
			8169-12-613*	613	-	-	1	-	403.30	-
			8169-12-619*	619	-	-	1	-	403.30	-
			8169-12-625*	625	-	-	1	-	403.30	-
			8169-12-626*	626	-	-	1	-	403.30	-
Stainless			8169-12-630	630	-	-	1	-	282.90	-
8169-12-BLK*	-	-	-	1	-	403.30	-			

Lead time exception: \*\* Products are stocked and will typically ship in 3-5 days

\*Finishes marked may date up to 4-5 weeks for shipment.

Bold pricing indicates item is in stock and available for **Fast Track** and **ProXpress**

MODEL	PULL CTC	SUBSTRATE	MODEL NUMBER	BHMA FINISH	WEIGHT	MUST BE ORDERED IN MULTIPLE QTY	MULTIPLE QTY	PACKED PER BOX	LIST PRICE		
									EACH	PACKAGE	
<b>8181</b> <b>Georgian Decorative Offset Pull 3/4" Dia.</b> See page 64 for optional mounting types and pricing. 	12"	Brass	8181-12-605	605	-	-	1	-	\$489.00	-	
			8181-12-613	613	-	-	1	-	489.00	-	
			8181-12-619*	619	-	-	1	-	489.00	-	
			8181-12-625*	625	-	-	1	-	489.00	-	
			8181-12-626*	626	-	-	1	-	489.00	-	
		Aluminum	8181-12-628*	628	-	-	1	-	459.80	-	
	16"	Brass	8181-12-630	630	-	-	1	-	471.40	-	
			8181-12-BLK*	-	-	-	1	-	489.00	-	
			8181-16-605	605	-	-	1	-	548.60	-	
			8181-16-613	613	-	-	1	-	548.60	-	
			8181-16-619*	619	-	-	1	-	548.60	-	
		8181-16-625*	625	-	-	1	-	548.60	-		
	18"	Brass	8181-16-626*	626	-	-	1	-	548.60	-	
			Aluminum	8181-16-628*	628	-	-	1	-	549.30	-
			Stainless	8181-16-630	630	-	-	1	-	548.60	-
			8181-16-BLK*	-	-	-	1	-	548.60	-	
			8181-18-605	605	-	-	1	-	578.40	-	
		8181-18-613	613	-	-	1	-	578.40	-		
	19 13/16"	Brass	8181-18-619*	619	-	-	1	-	578.40	-	
			8181-18-625*	625	-	-	1	-	578.40	-	
			8181-18-626*	626	-	-	1	-	578.40	-	
			Aluminum	8181-18-628*	628	-	-	1	-	579.10	-
			Stainless	8181-18-630	630	-	-	1	-	578.40	-
		8181-18-BLK*	-	-	-	1	-	578.40	-		
<b>8189</b> <b>Athens Decorative Offset Long Pull - 1 1/4" Dia.</b> See page 64 for optional mounting types and pricing. Custom lengths available as engineered special. 	19 13/16"	Brass	8189-19-605*	605	-	-	1	-	1,237.50	-	
			8189-19-613*	613	-	-	1	-	1,286.90	-	
			8189-19-619*	619	-	-	1	-	1,367.20	-	
			8189-19-625*	625	-	-	1	-	1,367.20	-	
			8189-19-626*	626	-	-	1	-	1,367.20	-	
		Stainless	8189-19-630*	630	-	-	1	-	776.70	-	
	8189-19-BLK*	-	-	-	1	-	1,367.20	-			
	<b>8190HD</b> <b>90° Offset Door Pull 1" Round, 2-1/4" Clearance</b> Antimicrobial Coating US26D-AM or US32D-AM available. See page 64 for optional mounting types and pricing. 	8"	Brass	8190HD-8 US3	605	-	-	1	-	122.00	-
				8190HD-8 US4	606	-	-	1	-	122.00	-
				8190HD-8 US10	612	-	-	1	-	141.00	-
				8190HD-8 US10B	613	-	-	1	-	141.00	-
				8190HD-8 US15	619	-	-	1	-	141.00	-
8190HD-8 US26				625	-	-	1	-	129.40	-	
Stainless			8190HD-8 US26D	626	-	-	1	-	129.40	-	
			8190HD-8 US32	629	-	-	1	-	108.60	-	
			8190HD-8 US32D	630	-	-	1	-	89.60	-	
			8190HD-8 643E/716	-	-	-	1	-	141.00	-	
			8190HD-8 BLK	-	-	-	1	-	122.00	-	
			8190HD-8 BLK	-	-	-	1	-	133.30	-	
10"		Brass	8190HD-0 US3	605	-	-	1	-	133.30	-	
			8190HD-0 US4	606	-	-	1	-	133.30	-	
			8190HD-0 US10	612	-	-	1	-	148.60	-	
			8190HD-0 US10B**	613	-	-	1	-	<b>142.80</b>	-	
			8190HD-0 US15	619	-	-	1	-	148.60	-	
			8190HD-0 US26	625	-	-	1	-	141.00	-	
		Stainless	8190HD-0 US26D**	626	-	-	1	-	135.10	-	
			8190HD-0 US32	629	-	-	1	-	116.20	-	
			8190HD-0 US32D**	630	-	-	1	-	<b>93.20</b>	-	
			8190HD-0 643E/716	-	-	-	1	-	142.80	-	
			8190HD-0 BLK	-	-	-	1	-	133.30	-	
			8190HD-0 BLK	-	-	-	1	-	133.30	-	
12"	Brass	8190HD-2 US3	605	-	-	1	-	141.00	-		
		8190HD-2 US4	606	-	-	1	-	141.00	-		
		8190HD-2 US10	612	-	-	1	-	160.10	-		
		8190HD-2 US10B	613	-	-	1	-	160.10	-		
		8190HD-2 US15	619	-	-	1	-	160.10	-		
		8190HD-2 US26	625	-	-	1	-	152.60	-		
	Stainless	8190HD-2 US26D	626	-	-	1	-	152.60	-		
		8190HD-2 US32	629	-	-	1	-	124.00	-		
		8190HD-2 US32D**	630	-	-	1	-	<b>100.50</b>	-		
		8190HD-2 643E/716	-	-	-	1	-	160.10	-		
		8190HD-2 BLK	-	-	-	1	-	141.00	-		
		8190HD-2 BLK	-	-	-	1	-	141.00	-		
18"	Brass	8190HD-18 US3	605	-	-	1	-	190.60	-		
		8190HD-18 US4	606	-	-	1	-	190.60	-		
		8190HD-18 US10	612	-	-	1	-	213.50	-		
		8190HD-18 US10B	613	-	-	1	-	213.50	-		
		8190HD-18 US15	619	-	-	1	-	213.50	-		
		8190HD-18 US26	625	-	-	1	-	201.90	-		
	Stainless	8190HD-18 US26D	626	-	-	1	-	201.90	-		
		8190HD-18 US32	629	-	-	1	-	167.50	-		
		8190HD-18 US32D	630	-	-	1	-	142.80	-		
		8190HD-18 643E/716	-	-	-	1	-	213.50	-		
		8190HD-18 BLK	-	-	-	1	-	190.60	-		
		8190HD-18 BLK	-	-	-	1	-	190.60	-		

HINGES  
 CONTINUOUS HINGES  
 PIVOTS  
 Numerical 1-059  
 Numerical 59-437  
 Numerical 438-1021  
 Numerical 1152-8190  
 Numerical 8200-9266

**Lead time exception:** \*\* Products are stocked and will typically ship in 3-5 days  
 \*Finishes marked may date up to 4-5 weeks for shipment.

Bold pricing indicates item is in stock and available for **Fast Track** and **ProXpress**

Additional 8190 Pulls Available in Fast Track and ProXpress				
MODELNUMBER	DESCRIPTION	SIZE	FINISH	Price
8190HD-0	90 Degree Offset Door Pull 1-3/4" (Mounting Type O)	10"	US32D	\$124.20
8190HD-2	90 Degree Offset Door Pull 1-3/4" (Mounting Type O)	12"	US32D	131.50

MODEL	PULL CTC	SUBSTRATE	MODEL NUMBER	BHMA FINISH	WEIGHT	MUST BE ORDERED IN MULTIPLE QTY	MULTIPLE QTY	PACKED PER BOX	LIST PRICE		
									EACH	PACKAGE	
<b>8190EZHD</b> <b>90 Offset Door Pull</b> <b>1" Round, 2-1/2" Clearance</b>  Antimicrobial Coating US26D-AM or US32D-AM available.  See page 64 for optional mounting types and pricing.	8"	Brass	8190EZHD-8 US3	605	-	-	1	-	\$128.80	-	
			8190EZHD-8 US4	606	-	-	1	-	128.80	-	
			8190EZHD-8 US10	612	-	-	1	-	148.60	-	
			8190EZHD-8 US10B	613	-	-	1	-	148.60	-	
			8190EZHD-8 US15	619	-	-	1	-	148.60	-	
			8190EZHD-8 US26	625	-	-	1	-	136.50	-	
		8190EZHD-8 US26D	626	-	-	1	-	136.50	-		
		316 Stainless	8190EZHD-8 32-316	629-316	-	-	1	-	135.40	-	
			8190EZHD-8 32D-316	630-316	-	-	1	-	111.70	-	
			8190EZHD-8 643E/716	-	-	-	-	-	148.60	-	
			8190EZHD-8 BLK	-	-	-	-	-	128.80	-	
			10"	Brass	8190EZHD-0 US3	605	-	-	1	-	140.50
	8190EZHD-0 US4				606	-	-	1	-	140.50	-
	8190EZHD-0 US10	612			-	-	1	-	157.00	-	
	8190EZHD-0 US10B	613			-	-	1	-	157.00	-	
	8190EZHD-0 US15	619			-	-	1	-	157.00	-	
	8190EZHD-0 US26	625			-	-	1	-	148.60	-	
	8190EZHD-0 US26D	626		-	-	1	-	148.60	-		
	316 Stainless	8190EZHD-0 32-316		629-316	-	-	1	-	144.90	-	
		8190EZHD-0 32D-316	630-316	-	-	1	-	121.20	-		
		8190EZHD-0 643E/716	-	-	-	-	-	157.00	-		
		8190EZHD-0 BLK	-	-	-	-	-	140.50	-		
	12"	Brass	8190EZHD-2 US3	605	-	-	1	-	148.60	-	
			8190EZHD-2 US4	606	-	-	1	-	148.60	-	
8190EZHD-2 US10			612	-	-	1	-	168.90	-		
8190EZHD-2 US10B			613	-	-	1	-	168.90	-		
8190EZHD-2 US15			619	-	-	1	-	168.90	-		
8190EZHD-2 US26			625	-	-	1	-	161.10	-		
8190EZHD-2 US26D		626	-	-	1	-	161.10	-			
316 Stainless		8190EZHD-2 32-316	629-316	-	-	1	-	154.50	-		
		8190EZHD-2 32D-316	630-316	-	-	1	-	130.80	-		
		8190EZHD-2 643E/716	-	-	-	-	-	168.90	-		
		8190EZHD-2 BLK	-	-	-	-	-	148.60	-		
		18"	Brass	8190EZHD-18 US3	605	-	-	1	-	201.20	-
	8190EZHD-18 US4			606	-	-	1	-	201.20	-	
8190EZHD-18 US10	612			-	-	1	-	225.30	-		
8190EZHD-18 US10B	613			-	-	1	-	225.30	-		
8190EZHD-18 US15	619			-	-	1	-	225.30	-		
8190EZHD-18 US26	625			-	-	1	-	213.00	-		
8190EZHD-18 US26D	626		-	-	1	-	213.00	-			
316 Stainless	8190EZHD-18 32-316		629-316	-	-	1	-	209.00	-		
	8190EZHD-18 32D-316		630-316	-	-	1	-	185.50	-		
	8190EZHD-18 643E/716		-	-	-	-	-	225.30	-		
	8190EZHD-18 BLK		-	-	-	-	-	201.20	-		

Lead time exception: \*\* Products are stocked and will typically ship in 3-5 days

Bold pricing indicates item is in stock and available for **Fast Track** and **ProXpress**

MODEL	PLATE SIZE	SUBSTRATE	MODEL NUMBER	BHMA FINISH	WEIGHT	MUST BE ORDERED IN MULTIPLE QTY	MULTIPLE QTY	PACKED PER BOX	LIST PRICE	
									EACH	PACKAGE
<b>8200 Push Plate</b> Antimicrobial Coating Available Specify US26D AM or US32D AM See page 64 for pricing.	3x12" (89x306mm)	Brass	8200 US3	605	-	-	-	-	\$22.80	-
			8200 US4	606	-	-	-	-	22.80	-
			8200 US10	612	-	-	-	-	25.40	-
			8200 US10B	613	-	-	-	-	28.40	-
			8200 US15	619	-	-	-	-	28.40	-
			8200 US26	625	-	-	-	-	28.40	-
			8200 US26D	626	-	-	-	-	28.40	-
		Aluminum	8200 US28	628	-	-	-	-	14.30	-
		Stainless	8200 US32D	630	-	-	-	-	14.00	-
	8200 BLK		-	-	-	-	-	22.80	-	
	3.5x15" (89x381mm)	Brass	8200 US3	605	-	-	-	-	25.00	-
			8200 US4	606	-	-	-	-	25.40	-
			8200 US10	612	-	-	-	-	30.00	-
			8200 US10B**	613	-	-	-	-	<b>30.90</b>	-
			8200 US15	619	-	-	-	-	30.90	-
			8200 US26	625	-	-	-	-	30.00	-
			8200 US26D	626	-	-	-	-	29.40	-
		Aluminum	8200 US28	628	-	-	-	-	<b>11.70</b>	-
		Stainless	8200 US32D**	630	-	-	-	-	<b>14.40</b>	-
			8200 BLK	-	-	-	-	-	25.00	-
	4x16" (102x408mm)	Brass	8200 US3	605	-	-	-	-	29.40	-
			8200 US4**	606	-	-	-	-	29.40	-
			8200 US10	612	-	-	-	-	33.60	-
			8200 US10B**	613	-	-	-	-	<b>34.90</b>	-
			8200 US15	619	-	-	-	-	34.90	-
			8200 US26	625	-	-	-	-	34.30	-
		8200 US26D**	626	-	-	-	-	<b>33.60</b>	-	
		Aluminum	8200 US28**	628	-	-	-	-	<b>11.10</b>	-
		Stainless	8200 US32D**	630	-	-	-	-	<b>16.80</b>	-
	8200 BLK		-	-	-	-	-	29.40	-	
	6x16" (153x408mm)	Brass	8200 US3	605	-	-	-	-	47.20	-
			8200 US4	606	-	-	-	-	47.20	-
			8200 US10	612	-	-	-	-	52.60	-
			8200 US10B	613	-	-	-	-	56.00	-
			8200 US15	619	-	-	-	-	57.20	-
			8200 US26	625	-	-	-	-	50.10	-
8200 US26D		626	-	-	-	-	50.10	-		
Aluminum		8200 US28	628	-	-	-	-	14.30	-	
Stainless		8200 US32D**	630	-	-	-	-	<b>23.00</b>	-	
		8200 BLK	-	-	-	-	-	47.20	-	
8x16" (204x408mm)	Brass	8200 US3	605	-	-	-	-	58.30	-	
		8200 US4	606	-	-	-	-	58.30	-	
		8200 US10	612	-	-	-	-	67.10	-	
		8200 US10B	613	-	-	-	-	71.50	-	
		8200 US15	619	-	-	-	-	71.50	-	
		8200 US26	625	-	-	-	-	65.60	-	
	8200 US26D	626	-	-	-	-	65.60	-		
	Aluminum	8200 US28	628	-	-	-	-	17.80	-	
	Stainless	8200 US32D**	630	-	-	-	-	<b>32.00</b>	-	
8200 BLK		-	-	-	-	-	58.30	-		

HINGES

CONTINUOUS HINGES

PIVOTS

Numerical 1-059

Numerical 59-437

Numerical 438-1021

Numerical 1152-8190

Numerical 8200-9266

Lead time exception: \*\* Products are stocked and will typically ship in 3-5 days

Bold pricing indicates item is in stock and available for **Fast Track** and **ProXpress**



HINGES  
 CONTINUOUS HINGES  
 PIVOTS  
 Numerical 1-059  
 Numerical 59-437  
 Numerical 438-1021  
 Numerical 1152-8190  
 Numerical 8200-9266

MODEL	PULL CTC	PLATE SIZE	SUBSTRATE	MODEL NUMBER	BHMA FINISH	WEIGHT	MUST BE ORDERED IN MULTIPLE PACKED			LIST PRICE	
							MULTIPLE QTY	QTY	PER BOX	EACH	PACKAGE
<b>8281</b> Georgian Decorative Straight Pull 1" Dia. with 1 1/4" Dia. Grip  See page 64 for optional mounting types and pricing. 	12"		Brass	8281-12-605	605	-	-	1		\$972.80	-
				8281-12-613	613	-	-	1	1,011.70	-	
				8281-12-619*	619	-	-	1	778.20	-	
				8281-12-625*	625	-	-	1	778.20	-	
				8281-12-626*	626	-	-	1	778.20	-	
				8281-12-628*	628	-	-	1	401.60	-	
			Aluminum	8281-12-630	630	-	-	1	778.20	-	
				8281-12-BLK*	-	-	-	1	778.20	-	
				Stainless Steel	8281-16-605	605	-	-	1	1,004.10	-
					8281-16-613	613	-	-	1	1,044.20	-
					8281-16-619*	619	-	-	1	803.40	-
					8281-16-625*	625	-	-	1	803.40	-
	8281-16-626*	626	-		-	1	803.40	-			
	8281-16-628*	628	-		-	1	416.80	-			
	16"	Brass	8281-16-630	630	-	-	1	803.40	-		
			8281-16-BLK*	-	-	-	1	803.40	-		
			Aluminum	8281-18-605	605	-	-	1	1,019.90	-	
				8281-18-613	613	-	-	1	1,060.60	-	
				8281-18-619*	619	-	-	1	815.90	-	
				8281-18-625*	625	-	-	1	815.90	-	
		8281-18-626*		626	-	-	1	815.90	-		
		8281-18-628*		628	-	-	1	424.20	-		
		Stainless Steel	8281-18-630	630	-	-	1	815.90	-		
			8281-18-BLK*	-	-	-	1	815.90	-		
18"			Brass	8302-6 US3	605	-	-	-	83.40	-	
				8302-6 US4	606	-	-	-	83.40	-	
	8302-6 US10			612	-	-	-	95.50	-		
	8302-6 US10B			613	-	-	-	99.20	-		
	8302-6 US15	619		-	-	-	99.20	-			
	8302-6 US26	625		-	-	-	94.50	-			
	Aluminum	8302-6 US26D	626	-	-	-	87.90	-			
		8302-6 US28	628	-	-	-	36.60	-			
		Stainless	8302-6 US32D	630	-	-	-	50.00	-		
			8302-6 643E/716	-	-	-	-	99.20	-		
			8302-6 BLK	-	-	-	-	83.40	-		
			6"	Brass	8302-6 US3	605	-	-	-	87.90	-
8302-6 US4	606				-	-	-	87.90	-		
8302-6 US10	612				-	-	-	99.60	-		
8302-6 US10B	613	-			-	-	103.40	-			
8302-6 US15	619	-			-	-	103.40	-			
8302-6 US26	625	-			-	-	99.00	-			
Aluminum	8302-6 US26D	626		-	-	-	92.00	-			
	8302-6 US28	628		-	-	-	36.10	-			
	Stainless	8302-6 US32D**		630	-	-	-	<b>52.10</b>	-		
		8302-6 643E/716		-	-	-	-	103.40	-		
		8302-6 BLK		-	-	-	-	87.90	-		
		6"		Brass	8302-6 US3	605	-	-	-	105.10	-
8302-6 US4			606		-	-	-	105.10	-		
8302-6 US10			612		-	-	-	118.10	-		
8302-6 US10B	613		-		-	-	124.80	-			
8302-6 US15	619		-		-	-	124.80	-			
8302-6 US26	625		-		-	-	114.70	-			
Aluminum	8302-6 US26D		626	-	-	-	107.90	-			
	8302-6 US28		628	-	-	-	39.00	-			
	Stainless		8302-8 US32D	630	-	-	-	60.80	-		
			8302-6 643E/716	-	-	-	-	124.80	-		
			8302-6 BLK	-	-	-	-	105.10	-		
			8"	Brass	8302-8 US3	605	-	-	-	90.20	-
8302-8 US4		606			-	-	-	90.20	-		
8302-8 US10		612			-	-	-	103.60	-		
8302-8 US10B	613	-			-	-	107.70	-			
8302-8 US15	619	-			-	-	107.70	-			
8302-8 US26	625	-			-	-	101.50	-			
Aluminum	8302-8 US26D	626		-	-	-	94.50	-			
	8302-8 US28	628		-	-	-	35.90	-			
	Stainless	8302-8 US32D**		630	-	-	-	<b>54.40</b>	-		
		8302-8 643E/716		-	-	-	-	107.70	-		
		8302-8 BLK		-	-	-	-	90.20	-		

Continued on next page.

**Lead time exception:** \*\* Products are stocked and will typically ship in 3-5 days  
 \*Finishes marked may date up to 4-5 weeks for shipment.

Bold pricing indicates item is in stock and available for **Fast Track** and **ProXpress**

MODEL	PULL CTC	PLATE SIZE	SUBSTRATE	MODEL NUMBER	BHMA FINISH	WEIGHT	MUST BE ORDERED IN			LIST PRICE	
							MULTIPLE QTY	MULTIPLE QTY	PACKED PER BOX	EACH	PACKAGE
<b>8302 Pull Plate</b> See page 64 for optional mounting types and pricing. Continued from previous page.	8"	4x16" (102x408mm)	Brass	8302-8 US3	605	-	-	-	-	\$94.50	-
				8302-8 US4	606	-	-	-	-	94.50	-
				8302-8 US10	612	-	-	-	-	108.20	-
				8302-8 US10B	613	-	-	-	-	107.30	-
				8302-8 US15	619	-	-	-	-	111.90	-
				8302-8 US26	625	-	-	-	-	105.90	-
			8302-8 US26D	626	-	-	-	-	99.00	-	
			Aluminum	8302-8 US28	628	-	-	-	-	36.70	-
			Stainless	8302-8 US32D**	630	-	-	-	-	<b>56.50</b>	-
				8302-8 643E/716	-	-	-	-	-	107.30	-
			8302-8 BLK	-	-	-	-	-	-	94.50	-
			8"	6x16" (153x408mm)	Brass	8302-8 US3	605	-	-	-	-
	8302-8 US4	606				-	-	-	-	111.80	-
	8302-8 US10	612				-	-	-	-	126.50	-
	8302-8 US10B	613				-	-	-	-	133.40	-
	8302-8 US15	619				-	-	-	-	133.40	-
	8302-8 US26	625				-	-	-	-	121.40	-
	8302-8 US26D	626			-	-	-	-	114.70	-	
	Aluminum	8302-8 US28			628	-	-	-	-	39.70	-
	Stainless	8302-8 US32D			630	-	-	-	-	65.40	-
		8302-8 643E/716			-	-	-	-	-	133.40	-
	8302-8 BLK	-			-	-	-	-	-	111.80	-
	10"	3.5x15" (89x381mm)			Brass	8302-0 US3	605	-	-	-	-
			8302-0 US4	606		-	-	-	-	100.70	-
			8302-0 US10	612		-	-	-	-	116.00	-
			8302-0 US10B	613		-	-	-	-	119.90	-
			8302-0 US15	619		-	-	-	-	119.90	-
			8302-0 US26	625		-	-	-	-	103.30	-
			8302-0 US26D	626	-	-	-	-	103.60	-	
			Aluminum	8302-0 US28	628	-	-	-	-	39.00	-
			Stainless	8302-0 US32D	630	-	-	-	-	<b>60.90</b>	-
				8302-0 643E/716	-	-	-	-	-	119.90	-
			8302-0 BLK	-	-	-	-	-	-	100.70	-
			10"	4x16" (102x408mm)	Brass	8302-0 US3	605	-	-	-	-
	8302-0 US4	606				-	-	-	-	105.20	-
	8302-0 US10	612				-	-	-	-	120.50	-
	8302-0 US10B	613				-	-	-	-	124.10	-
	8302-0 US15	619				-	-	-	-	124.10	-
	8302-0 US26	625				-	-	-	-	107.70	-
	8302-0 US26D	626			-	-	-	-	108.20	-	
	Aluminum	8302-0 US28			628	-	-	-	-	38.30	-
	Stainless	8302-0 US32D**			630	-	-	-	-	<b>63.00</b>	-
8302-0 643E/716		-			-	-	-	-	124.10	-	
8302-0 BLK	-	-			-	-	-	-	105.20	-	
10"	6x16" (153x408mm)	Brass			8302-0 US3	605	-	-	-	-	122.40
			8302-0 US4	606	-	-	-	-	122.40	-	
			8302-0 US10	612	-	-	-	-	138.80	-	
			8302-0 US10B	613	-	-	-	-	145.50	-	
			8302-0 US15	619	-	-	-	-	145.50	-	
			8302-0 US26	625	-	-	-	-	123.30	-	
		8302-0 US26D	626	-	-	-	-	123.80	-		
		Aluminum	8302-0 US28	628	-	-	-	-	41.30	-	
		Stainless	8302-0 US32D**	630	-	-	-	-	69.00	-	
			8302-0 643E/716	-	-	-	-	-	145.50	-	
		8302-0 BLK	-	-	-	-	-	-	122.40	-	



HINGES  
 CONTINUOUS HINGES  
 PIVOTS  
 Numerical 1-059  
 Numerical 59-437  
 Numerical 438-1021  
 Numerical 1152-8190  
 Numerical 8200-9266

Lead time exception: \*\* Products are stocked and will typically ship in 3-5 days



Bold pricing indicates item is in stock and available for **Fast Track** and **ProXpress**

HINGES  
 CONTINUOUS HINGES  
 PIVOTS  
 Numerical 1-059  
 Numerical 59-437  
 Numerical 438-1021  
 Numerical 1152-8190  
 Numerical 8200-9266

MODEL	PULL CTC	PLATE SIZE	SUBSTRATE	MODEL NUMBER	BHMA FINISH	WEIGHT	MUST BE ORDERED IN			LIST PRICE	
							MULTIPLE QTY	MULTIPLE QTY	PACKED PER BOX	EACH	PACKAGE
<b>8303 Pull Plate</b> Antimicrobial Coating US26D-AM or US32D-AM available. See page 64 for optional mounting types and pricing.	8"	3.5x15" (89x381mm)	Brass	8303-8 US3	605	-	-	-	-	\$138.40	-
				8303-8 US4	606	-	-	-	-	138.40	-
				8303-8 US10	612	-	-	-	-	156.80	-
				8303-8 US10B	613	-	-	-	-	162.50	-
				8303-8 US15	619	-	-	-	-	162.50	-
				8303-8 US26	625	-	-	-	-	149.90	-
			8303-8 US26D	626	-	-	-	-	143.10	-	
			Aluminum	8303-8 US28	628	-	-	-	-	46.40	-
			Stainless	8303-8 US32D	630	-	-	-	-	85.50	-
				8303-8 643E/716	-	-	-	-	-	162.50	-
				8303-8 BLK	-	-	-	-	-	138.40	-
			8"	4x16" (102x408mm)	Brass	8303-8 US3	605	-	-	-	-
	8303-8 US4	606				-	-	-	-	142.80	-
	8303-8 US10	612				-	-	-	-	160.90	-
	8303-8 US10B	613				-	-	-	-	166.80	-
	8303-8 US15	619				-	-	-	-	166.80	-
	8303-8 US26	625				-	-	-	-	154.20	-
	8303-8 US26D	626			-	-	-	-	147.60	-	
	Aluminum	8303-8 US28			628	-	-	-	-	45.70	-
	Stainless	8303-8 US32D**			630	-	-	-	-	<b>84.40</b>	-
		8303-8 643E/716			-	-	-	-	-	166.80	-
		8303-8 BLK			-	-	-	-	-	142.80	-
	8"	6x16" (153x408mm)			Brass	8303-8 US3	605	-	-	-	-
			8303-8 US4	606		-	-	-	-	160.10	-
8303-8 US10			612	-		-	-	-	179.40	-	
8303-8 US10B			613	-		-	-	-	188.10	-	
8303-8 US15			619	-		-	-	-	188.10	-	
8303-8 US26			625	-		-	-	-	169.80	-	
8303-8 US26D			626	-	-	-	-	163.20	-		
Aluminum			8303-8 US28	628	-	-	-	-	48.70	-	
Stainless			8303-8 US32D	630	-	-	-	-	94.10	-	
			8303-8 643E/716	-	-	-	-	-	188.10	-	
			8303-8 BLK	-	-	-	-	-	160.10	-	
10"			3.5x15" (89x381mm)	Brass	8303-0 US3	605	-	-	-	-	150.00
	8303-0 US4	606			-	-	-	-	150.00	-	
	8303-0 US10	612			-	-	-	-	172.60	-	
	8303-0 US10B	613			-	-	-	-	174.20	-	
	8303-0 US15	619			-	-	-	-	178.90	-	
	8303-0 US26	625			-	-	-	-	160.90	-	
	8303-0 US26D	626		-	-	-	-	154.30	-		
	Aluminum	8303-0 US28		628	-	-	-	-	48.20	-	
	Stainless	8303-0 US32D		630	-	-	-	-	90.10	-	
		8303-0 643E/716		-	-	-	-	-	174.20	-	
		8303-0 BLK		-	-	-	-	-	150.00	-	
	Continued on next page.	10"		4x16" (102x408mm)	Brass	8303-0 US3	605	-	-	-	-
8303-0 US4			606			-	-	-	-	154.30	-
8303-0 US10			612			-	-	-	-	177.00	-
8303-0 US10B			613			-	-	-	-	171.10	-
8303-0 US15			619			-	-	-	-	183.00	-
8303-0 US26			625			-	-	-	-	165.40	-
8303-0 US26D			626		-	-	-	-	158.60	-	
Aluminum			8303-0 US28		628	-	-	-	-	47.40	-
Stainless			8303-0 US32D**		630	-	-	-	-	<b>92.30</b>	-
			8303-0 643E/716		-	-	-	-	-	171.10	-
8303-0 BLK	-	-	-	-	-	154.30	-				

Lead time exception: \*\* Products are stocked and will typically ship in 3-5 days

Bold pricing indicates item is in stock and available for **Fast Track** and **ProXpress**

MODEL	PULL CTC	PLATE SIZE	SUBSTRATE	MODEL NUMBER	BHMA FINISH	WEIGHT	MUST BE ORDERED IN			LIST PRICE			
							MULTIPLE QTY	MULTIPLE QTY	PACKED PER BOX	EACH	PACKAGE		
<b>8303 Pull Plate</b> <i>Continued from previous page.</i> 	10"	6x16" (153x408mm)	Brass	8303-0 US3	605	-	-	-	-	\$171.60	-		
				8303-0 US4	606	-	-	-	-	171.60	-		
				8303-0 US10	612	-	-	-	-	195.40	-		
				8303-0 US10B	613	-	-	-	-	199.80	-		
				8303-0 US15	619	-	-	-	-	204.60	-		
				8303-0 US26	625	-	-	-	-	181.00	-		
				8303-0 US26D	626	-	-	-	-	174.50	-		
			Aluminum	8303-0 US28	628	-	-	-	-	50.40	-		
			Stainless	8303-0 US32D**	630	-	-	-	-	98.30	-		
				8303-0 643E/716	-	-	-	-	-	199.80	-		
8303-0 BLK	-	-		-	-	-	171.60	-					
<b>8305 Pull Plate</b> Antimicrobial Coating US26D-AM or US32D-AM available. See page 64 for optional mounting types and pricing. 	6"	3.5x15" (89x381mm)	Brass	8305-6 US3	605	-	-	-	-	88.30	-		
				8305-6 US4	606	-	-	-	-	88.30	-		
				8305-6 US10	612	-	-	-	-	106.40	-		
				8305-6 US10B	613	-	-	-	-	109.90	-		
				8305-6 US15	619	-	-	-	-	109.90	-		
				8305-6 US26	625	-	-	-	-	93.10	-		
				8305-6 US26D	626	-	-	-	-	88.00	-		
			Aluminum	8305-6 US28	628	-	-	-	-	39.70	-		
			Stainless	8305-6 US32D	630	-	-	-	-	63.20	-		
				8305-6 643E/716	-	-	-	-	-	109.90	-		
				8305-6 BLK	-	-	-	-	-	88.30	-		
			6"	4x16" (102x408mm)	Brass	8305-6 US3	605	-	-	-	-	92.70	-
						8305-6 US4	606	-	-	-	-	92.70	-
						8305-6 US10	612	-	-	-	-	110.70	-
						8305-6 US10B	613	-	-	-	-	114.00	-
	8305-6 US15	619				-	-	-	-	114.00	-		
	8305-6 US26	625				-	-	-	-	97.40	-		
	8305-6 US26D	626				-	-	-	-	92.30	-		
	Aluminum	8305-6 US28			628	-	-	-	-	39.10	-		
	Stainless	8305-6 US32D			630	-	-	-	-	62.90	-		
		8305-6 643E/716			-	-	-	-	-	114.00	-		
		8305-6 BLK			-	-	-	-	-	92.70	-		
	6"	6x16" (153x408mm)			Brass	8305-6 US3	605	-	-	-	-	109.90	-
						8305-6 US4	606	-	-	-	-	110.00	-
						8305-6 US10	612	-	-	-	-	129.50	-
						8305-6 US10B	613	-	-	-	-	135.70	-
			8305-6 US15	619		-	-	-	-	135.70	-		
			8305-6 US26	625		-	-	-	-	113.20	-		
			8305-6 US26D	626		-	-	-	-	108.20	-		
			Aluminum	8305-6 US28	628	-	-	-	-	42.10	-		
Stainless			8305-6 US32D	630	-	-	-	-	72.00	-			
			8305-6 643E/716	-	-	-	-	-	135.70	-			
			8305-6 BLK	-	-	-	-	-	110.00	-			
8"			3.5x15" (89x381mm)	Brass	8305-8 US3	605	-	-	-	-	121.40	-	
					8305-8 US4	606	-	-	-	-	121.40	-	
					8305-8 US10	612	-	-	-	-	133.90	-	
					8305-8 US10B	613	-	-	-	-	135.50	-	
	8305-8 US15	619			-	-	-	-	135.50	-			
	8305-8 US26	625			-	-	-	-	130.00	-			
	8305-8 US26D	626			-	-	-	-	130.00	-			
	Aluminum	8305-8 US28		628	-	-	-	-	45.80	-			
	Stainless	8305-8 US32D		630	-	-	-	-	84.40	-			
		8305-8 643E/716		-	-	-	-	-	135.50	-			
		8305-8 BLK		-	-	-	-	-	121.40	-			

HINGES  
 CONTINUOUS HINGES  
 PIVOTS  
 Numerical 1-059  
 Numerical 59-437  
 Numerical 438-1021  
 Numerical 1152-8190  
 Numerical 8200-9266

Lead time exception: \*\* Products are stocked and will typically ship in 3-5 days



Bold pricing indicates item is in stock and available for **Fast Track** and **ProXpress**

HINGES  
 CONTINUOUS HINGES  
 PIVOTS  
 Numerical 1-059  
 Numerical 59-437  
 Numerical 438-1021  
 Numerical 1152-8190  
 Numerical 8200-9266

MODEL	PULL CTC	PLATE SIZE	SUBSTRATE	MODEL NUMBER	BHMA FINISH	WEIGHT	MUST BE ORDERED IN			LIST PRICE	
							MULTIPLE QTY	MULTIPLE QTY	PACKED PER BOX	EACH	PACKAGE
<b>8305 Pull Plate</b> <i>Continued from previous page.</i> 	8"	4x16" (102x408mm)	Brass	8305-8 US3	605	-	-	-	-	\$126.00	-
				8305-8 US4	606	-	-	-	-	126.00	-
				8305-8 US10	612	-	-	-	-	138.40	-
				8305-8 US10B	613	-	-	-	-	139.80	-
				8305-8 US15	619	-	-	-	-	139.80	-
				8305-8 US26	625	-	-	-	-	134.10	-
			8305-8 US26D	626	-	-	-	-	134.10	-	
			Aluminum	8305-8 US28	628	-	-	-	-	45.20	-
			Stainless	8305-8 US32D**	630	-	-	-	-	83.10	-
		8305-8 643E/716	-	-	-	-	-	139.80	-		
		8305-8 BLK	-	-	-	-	-	126.00	-		
	8"	6x16" (153x408mm)	Brass	8305-8 US3	605	-	-	-	-	143.10	-
				8305-8 US4	606	-	-	-	-	143.10	-
				8305-8 US10	612	-	-	-	-	157.00	-
				8305-8 US10B	613	-	-	-	-	161.10	-
				8305-8 US15	619	-	-	-	-	161.10	-
				8305-8 US26	625	-	-	-	-	150.00	-
			8305-8 US26D	626	-	-	-	-	150.00	-	
			Aluminum	8305-8 US28	628	-	-	-	-	48.30	-
			Stainless	8305-8 US32D	630	-	-	-	-	92.90	-
		8305-8 643E/716	-	-	-	-	-	161.10	-		
		8305-8 BLK	-	-	-	-	-	143.10	-		
	10"	3.5x15" (89x381mm)	Brass	8305-0 US3	605	-	-	-	-	129.70	-
				8305-0 US4	606	-	-	-	-	129.70	-
8305-0 US10				612	-	-	-	-	146.10	-	
8305-0 US10B				613	-	-	-	-	147.70	-	
8305-0 US15				619	-	-	-	-	147.70	-	
8305-0 US26				625	-	-	-	-	138.20	-	
8305-0 US26D			626	-	-	-	-	138.20	-		
Aluminum			8305-0 US28	628	-	-	-	-	47.00	-	
Stainless			8305-0 US32D	630	-	-	-	-	92.60	-	
	8305-0 643E/716	-	-	-	-	-	147.70	-			
	8305-0 BLK	-	-	-	-	-	129.70	-			
10"	4x16" (102x408mm)	Brass	8305-0 US3	605	-	-	-	-	133.90	-	
			8305-0 US4	606	-	-	-	-	133.90	-	
			8305-0 US10	612	-	-	-	-	150.50	-	
			8305-0 US10B	613	-	-	-	-	151.80	-	
			8305-0 US15	619	-	-	-	-	151.80	-	
			8305-0 US26	625	-	-	-	-	142.60	-	
		8305-0 US26D	626	-	-	-	-	142.60	-		
		Aluminum	8305-0 US28	628	-	-	-	-	46.20	-	
		Stainless	8305-0 US32D**	630	-	-	-	-	90.90	-	
	8305-0 643E/716	-	-	-	-	-	151.80	-			
	8305-0 BLK	-	-	-	-	-	133.90	-			
10"	6x16" (153x408mm)	Brass	8305-0 US3	605	-	-	-	-	151.20	-	
			8305-0 US4	606	-	-	-	-	151.20	-	
			8305-0 US10	612	-	-	-	-	169.00	-	
			8305-0 US10B	613	-	-	-	-	173.20	-	
			8305-0 US15	619	-	-	-	-	173.20	-	
			8305-0 US26	625	-	-	-	-	158.10	-	
		8305-0 US26D	626	-	-	-	-	158.10	-		
		Aluminum	8305-0 US28	628	-	-	-	-	49.10	-	
		Stainless	8305-0 US32D	630	-	-	-	-	101.00	-	
	8305-0 643E/716	-	-	-	-	-	173.20	-			
	8305-0 BLK	-	-	-	-	-	151.20	-			

Lead time exception: \*\* Products are stocked and will typically ship in 3-5 days

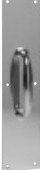
Bold pricing indicates item is in stock and available for **Fast Track** and **ProXpress**

MODEL	PULL CTC	PLATE SIZE	SUBSTRATE	MODEL NUMBER	BHMA FINISH	WEIGHT	MUST BE ORDERED IN			LIST PRICE	
							MULTIPLE QTY	MULTIPLE QTY	PACKED PER BOX	EACH	PACKAGE
<b>8311</b> <b>Pull Plate</b> Antimicrobial Coating US26D-AM or US32D-AM available. See page 64 for optional mounting types and pricing. 	5" (Actual CTC = 5-1/4")	3.5x15" (89x381mm)	Brass	8311-5 US3	605	-	-	-	-	\$85.10	-
				8311-5 US4	606	-	-	-	-	85.10	-
				8311-5 US10	612	-	-	-	-	96.10	-
				8311-5 US10B	613	-	-	-	-	97.60	-
				8311-5 US15	619	-	-	-	-	97.60	-
				8311-5 US26	625	-	-	-	-	89.50	-
			8311-5 US26D	626	-	-	-	-	93.40	-	
			Aluminum	8311-5 US28	628	-	-	-	-	50.10	-
			Stainless	8311-5 US32D	630	-	-	-	-	-	70.10
	8311-5 643E/716	-		-	-	-	-	-	97.60	-	
	8311-5 BLK	-		-	-	-	-	-	85.10	-	
	5" (Actual CTC = 5-1/4")	4x16" (102x408mm)	Brass	8311-5 US3	605	-	-	-	-	89.50	-
				8311-5 US4	606	-	-	-	-	89.50	-
				8311-5 US10	612	-	-	-	-	100.50	-
				8311-5 US10B	613	-	-	-	-	101.90	-
				8311-5 US15	619	-	-	-	-	101.90	-
				8311-5 US26	625	-	-	-	-	93.80	-
			8311-5 US26D	626	-	-	-	-	97.70	-	
Aluminum			8311-5 US28	628	-	-	-	-	49.20	-	
Stainless			8311-5 US32D	630	-	-	-	-	-	69.40	-
	8311-5 643E/716	-	-	-	-	-	-	101.90	-		
	8311-5 BLK	-	-	-	-	-	-	89.50	-		
5" (Actual CTC = 5-1/4")	6x16" (153x408mm)	Brass	8311-5 US3	605	-	-	-	-	106.60	-	
			8311-5 US4	606	-	-	-	-	106.60	-	
			8311-5 US10	612	-	-	-	-	119.00	-	
			8311-5 US10B	613	-	-	-	-	123.30	-	
			8311-5 US15	619	-	-	-	-	123.30	-	
			8311-5 US26	625	-	-	-	-	109.50	-	
		8311-5 US26D	626	-	-	-	-	113.50	-		
		Aluminum	8311-5 US28	628	-	-	-	-	52.20	-	
		Stainless	8311-5 US32D	630	-	-	-	-	-	78.80	-
8311-5 643E/716	-		-	-	-	-	-	123.30	-		
8311-5 BLK	-		-	-	-	-	-	106.60	-		
<b>8312</b> <b>Plymouth Decorative Curved Pull - 1" Dia.</b> See page 64 for optional mounting types and pricing. 	12"		Brass	8312-12-605	605	-	-	1	355.70	-	
				8312-12-613	613	-	-	1	431.90	-	
				8312-12-619*	619	-	-	1	431.90	-	
				8312-12-625*	625	-	-	1	431.90	-	
				8312-12-626*	626	-	-	1	431.90	-	
			Stainless Steel	8312-12-630	630	-	-	1	1,004.10	-	
				8312-12-BLK*	-	-	-	1	431.90	-	
<b>8320</b> <b>Plymouth Decorative Curved Pull - 1 1/4" Dia.</b> See page 64 for optional mounting types and pricing. 	20"		Brass	8320-20-605	605	-	-	1	660.50	-	
				8320-20-613	613	-	-	1	711.40	-	
				8320-20-619*	619	-	-	1	711.40	-	
				8320-20-625*	625	-	-	1	711.40	-	
				8320-20-626*	626	-	-	1	711.40	-	
			Stainless Steel	8320-20-630	630	-	-	1	1,129.80	-	
				8320-20-BLK*	-	-	-	1	711.40	-	



HINGES  
 CONTINUOUS HINGES  
 PIVOTS  
 Numerical 1-059  
 Numerical 59-437  
 Numerical 438-1021  
 Numerical 1152-8190  
 Numerical 8200-9266

Lead time exception: \*\* Products are stocked and will typically ship in 3-5 days  
 \*Finishes marked may date up to 4-5 weeks for shipment.

Bold pricing indicates item is in stock and available for **Fast Track** and **ProXpress**



HINGES  
 CONTINUOUS HINGES  
 PIVOTS  
 Numerical 1-059  
 Numerical 59-437  
 Numerical 438-1021  
 Numerical 1152-8190  
 Numerical 8200-9266

MODEL	PULL CTC	PLATE SIZE	SUBSTRATE	MODEL NUMBER	BHMA FINISH	WEIGHT	MUST BE ORDERED IN			LIST PRICE	
							MULTIPLE QTY	MULTIPLE QTY	PACKED PER BOX	EACH	PACKAGE
<b>8371</b> <b>Addison Decorative Flat Tip, Straight Pull 1" Dia.</b> See page 64 for optional mounting types and pricing. 	12"		Brass	8371-12-605	605	-	-	1	-	\$803.40	-
				8371-12-613	613	-	-	1	-	803.40	-
				8371-12-619*	619	-	-	1	-	803.40	-
				8371-12-625*	625	-	-	1	-	803.40	-
				8371-12-626*	626	-	-	1	-	803.30	-
				8371-12-BLK*	622	-	-	1	-	803.40	-
	18"		Brass	8371-18-605	605	-	-	1	-	848.50	-
				8371-18-613	613	-	-	1	-	848.50	-
				8371-18-619*	619	-	-	1	-	848.50	-
				8371-18-625*	625	-	-	1	-	848.50	-
				8371-18-626*	626	-	-	1	-	848.50	-
				8371-18-BLK*	622	-	-	1	-	848.50	-
	24"		Brass	8371-24-605	605	-	-	1	-	878.80	-
				8371-24-613	613	-	-	1	-	878.80	-
				8371-24-619*	619	-	-	1	-	878.80	-
				8371-24-625*	625	-	-	1	-	878.80	-
				8371-24-626*	626	-	-	1	-	878.80	-
				8371-24-BLK*	622	-	-	1	-	878.80	-
<b>8372</b> <b>Camelot Decorative Steeple Tip, Straight Pull 1" Dia.</b> See page 64 for optional mounting types and pricing. 	12"		Brass	8372-12-605	605	-	-	1	-	803.40	-
				8372-12-613	613	-	-	1	-	803.40	-
				8372-12-619*	619	-	-	1	-	803.40	-
				8372-12-625*	625	-	-	1	-	803.40	-
				8372-12-626*	626	-	-	1	-	803.30	-
				8372-12-BLK*	622	-	-	1	-	803.40	-
	18"		Brass	8372-18-605	605	-	-	1	-	848.50	-
				8372-18-613	613	-	-	1	-	848.50	-
				8372-18-619*	619	-	-	1	-	848.50	-
				8372-18-625*	625	-	-	1	-	848.50	-
				8372-18-626*	626	-	-	1	-	848.50	-
				8372-18-BLK*	622	-	-	1	-	848.50	-
	24"		Brass	8372-24-605	605	-	-	1	-	878.80	-
				8372-24-613	613	-	-	1	-	878.80	-
				8372-24-619*	619	-	-	1	-	878.80	-
				8372-24-625*	625	-	-	1	-	878.80	-
				8372-24-626*	626	-	-	1	-	878.80	-
				8372-24-BLK*	622	-	-	1	-	878.80	-
<b>8373</b> <b>Brookshire Decorative Acorn Tip, Straight Pull 1" Dia.</b> See page 64 for optional mounting types and pricing. 	12"		Brass	8373-12-605	605	-	-	1	-	803.40	-
				8373-12-613	613	-	-	1	-	803.40	-
				8373-12-619*	619	-	-	1	-	803.40	-
				8373-12-625*	625	-	-	1	-	803.40	-
				8373-12-626*	626	-	-	1	-	803.30	-
				8373-12-BLK*	622	-	-	1	-	803.40	-
	18"		Brass	8373-18-605	605	-	-	1	-	848.50	-
				8373-18-613	613	-	-	1	-	848.50	-
				8373-18-619*	619	-	-	1	-	848.50	-
				8373-18-625*	625	-	-	1	-	848.50	-
				8373-18-626*	626	-	-	1	-	848.50	-
				8373-18-BLK*	622	-	-	1	-	848.50	-
	24"		Brass	8373-24-605	605	-	-	1	-	878.80	-
				8373-24-613	613	-	-	1	-	878.80	-
				8373-24-619*	619	-	-	1	-	878.80	-
				8373-24-625*	625	-	-	1	-	878.80	-
				8373-24-626*	626	-	-	1	-	878.80	-
				8373-24-BLK*	622	-	-	1	-	878.80	-

Lead time exception: \*\* Products are stocked and will typically ship in 3-5 days  
 \*Finishes marked may date up to 4-5 weeks for shipment.

Bold pricing indicates item is in stock and available for **Fast Track** and **ProXpress**

### 8400 Protection Plates Stocked Protection Plates

All protection plates come standard with 4 Beveled Edges and Counter Sunk Holes (B-CS) at no extra charge.

MODEL	SUBSTRATE	FINISH	PLATE SIZE	WEIGHT	MUST BE ORDERED IN MULTIPLE QTY	MUTIPLE QTY	PACKED PER BOX	LIST PRICE			
								EACH	PACKAGE		
8400	Aluminum	US28	8X34	---	---	---	---	\$34.53	---		
		P-BLK	10 X 34	---	---	---	---	36.46	---		
	Plastic	CLR	8 X 34	---	---	---	---	29.15	---		
		US3	6X34	---	---	---	---	90.26	---		
	Brass	US3	8X34	---	---	---	---	113.64	---		
			10X34	---	---	---	---	142.05	---		
			8X34	---	---	---	---	127.38	---		
		US10	10X34	---	---	---	---	159.23	---		
			US10B	4X35	---	---	---	72.41	---		
		Stainless	US15	6X34	---	---	---	---	102.57	---	
				8X34	---	---	---	---	130.07	---	
				10X34	---	---	---	---	115.24	---	
			US32 US32D	4X34	---	---	---	---	---	22.13	---
				4X35	---	---	---	---	---	23.43	---
				4X41	---	---	---	---	---	27.34	---
				4X47	---	---	---	---	---	31.23	---
	6X30			---	---	---	---	---	29.28	---	
	6X34			---	---	---	---	---	33.20	---	
	6X35			---	---	---	---	---	35.14	---	
	8X22			---	---	---	---	---	25.38	---	
	8X26			---	---	---	---	---	30.00	---	
	8X28			---	---	---	---	---	32.30	---	
	8X30	---		---	---	---	---	34.61	---		
	8X32	---		---	---	---	---	36.90	---		
	8X34	---		---	---	---	---	<b>39.21</b>	---		
	8X34.5	---		---	---	---	---	41.54	---		
	8X35	---		---	---	---	---	41.54	---		
	8X36	---		---	---	---	---	41.54	---		
	8X38	---		---	---	---	---	43.84	---		
	8X40	---		---	---	---	---	46.14	---		
	8X41	---		---	---	---	---	48.45	---		
	8X42	---		---	---	---	---	48.45	---		
	8X46	---		---	---	---	---	53.07	---		
	8X47	---		---	---	---	---	55.38	---		
	10X17	---		---	---	---	---	31.73	---		
	10X22	---		---	---	---	---	31.73	---		
	10X23	---		---	---	---	---	34.61	---		
	10X26	---		---	---	---	---	37.49	---		
	10X28	---		---	---	---	---	40.38	---		
	10X29	---		---	---	---	---	43.27	---		
	10X30	---		---	---	---	---	43.27	---		
	10X31	---		---	---	---	---	46.14	---		
	10X32	---		---	---	---	---	46.14	---		
	10X33	---		---	---	---	---	49.03	---		
	10X34	---		---	---	---	---	<b>49.03</b>	---		
	10X34.5	---	---	---	---	---	51.91	---			
	10X35	---	---	---	---	---	<b>51.91</b>	---			
	10X36	---	---	---	---	---	51.91	---			
	10X37	---	---	---	---	---	54.79	---			
	10X38	---	---	---	---	---	54.79	---			
10X39	---	---	---	---	---	57.67	---				
10X40	---	---	---	---	---	57.67	---				
10X40.5	---	---	---	---	---	60.56	---				
10X41	---	---	---	---	---	60.56	---				
10X42	---	---	---	---	---	60.56	---				
10X42.5	---	---	---	---	---	63.44	---				
10X43	---	---	---	---	---	63.44	---				
10X44	---	---	---	---	---	63.44	---				
10X46	---	---	---	---	---	66.32	---				
10X46.5	---	---	---	---	---	69.22	---				
10X47	---	---	---	---	---	69.22	---				
12X28	---	---	---	---	---	48.45	---				
12X34	---	---	---	---	---	58.84	---				

HINGES  
 CONTINUOUS HINGES  
 PIVOTS  
 Numerical 1-059  
 Numerical 59-437  
 Numerical 438-1021  
 Numerical 1152-8190  
 Numerical 8200-9266

Contact Ives Customer Service for pricing on additional sizes and finishes

Bold pricing indicates item is in stock and available for **Fast Track** and **ProXpress**

### 8400 Protection Plates Stocked Protection Plates (continued)

All protection plates come standard with 4 Beveled Edges and Counter Sunk Holes (B-CS) at no extra charge.

MODEL	SUBSTRATE	FINISH	PLATE SIZE	WEIGHT	MUST BE ORDERED IN MULTIPLE QTY	MULTIPLE QTY	PACKED PER BOX	LIST PRICE	
								EACH	PACKAGE
8400 continued	Stainless continued	US32D continued	12X35	---	---	---	---	\$62.29	---
			12X40	---	---	---	---	69.22	---
			12X42	---	---	---	---	72.68	---
			12X46	---	---	---	---	79.60	---
			16X34	---	---	---	---	78.43	---
			16X40	---	---	---	---	92.28	---
			16X46	---	---	---	---	106.13	---
			18X34	---	---	---	---	95.78	---
			24X34	---	---	---	---	127.71	---
			30X34	---	---	---	---	159.65	---
			30X35	---	---	---	---	169.04	---
			30X40	---	---	---	---	187.82	---
			32X34	---	---	---	---	170.30	---
			34X34	---	---	---	---	180.93	---
			34X35	---	---	---	---	191.58	---
			34X36	---	---	---	---	191.58	---
			34X40	---	---	---	---	212.87	---
			34X46	---	---	---	---	244.80	---
			36X34	---	---	---	---	191.58	---
			36X35	---	---	---	---	202.84	---
36X40	---	---	---	---	225.38	---			
36X46	---	---	---	---	259.19	---			
8402	Stainless	US32D	10X34	---	---	---	---	67.52	---
			34X34	---	---	---	---	199.42	---
			34X46	---	---	---	---	263.28	---

For all other Protection Plates, see pricing in the table below.

### 8400 Protection Plate (List Price (Per 100 Square Inches))

FINISH	SUBSTRATE	MAX SIZE	UNDER 8"	8" ≤ 16"	OVER 16" ≤ 36"	OVER 36" ≤ 48"
US32D	Stainless	48 x 48"	\$17.00	\$15.00	\$16.30	\$15.20
US32	Stainless	48 x 48"	37.30	35.30	36.10	33.70
BLK	Stainless	24 x 48"	37.30	35.30	36.10	33.70
US3	Brass	24 x 48"	46.10	43.60	57.60	NA
US4	Brass	24 x 48"	46.10	43.60	57.60	NA
US10	Brass	24 x 48"	51.40	48.80	64.30	NA
US10B	Brass	36 x 48"	52.30	48.80	64.30	NA
US15	Stainless	24 x 48"	52.30	49.90	64.30	NA
US26	Stainless	36 x 48"	50.60	48.20	64.30	NA
US26D	Stainless	48 x 48"	50.60	48.20	64.30	NA
US28	Aluminum	48 x 48"	15.70	13.10	14.30	13.40
Clear	Plastic	48 x 48"	14.10	11.20	12.80	11.90
P-BLK	Plastic	48 x 48"	14.10	11.20	12.80	11.90
654	Satin Stainless Steel	48 x 48"	14.40	13.00	14.10	13.20

Kickplates must be ordered in 1/2" increments

### 8400 Options

MODEL	DESCRIPTION	SIZE	LIST ADD PER PLATE
<b>B-CS</b>	<b>Hand Bevel Four Edges (B4E) and Counter Sunk Holes</b>		Standard
<b>B-NH</b>	<b>No Mounting Holes</b> - US32D, US32, US3, US4, US28, Clear Plastic, Black Plastic only		29.00
<b>B-NHA</b>	<b>No Mounting Holes with Adhesive</b> - US32D, US32, US3, US4, US28, Clear, Black only	12" and under over 12" up to 24"	29.00 59.00
<b>TK-TX</b>	Includes Self Drilling Tek Screws and Torx Brand Security Screws (package of 16 each)		14.00
<b>ERS</b>	<b>Prepped for Extra Row of Screws</b> (For extra mounting hole option, customer must specify location and quantity of holes required)		Consult Factory

MODEL	DESCRIPTION	SIZE	LIST ADD PER PLATE
<b>8401</b>	<b>Gasket Tape Kit</b> (sold separately)	Fits 8" x 34"	\$23.00 ea.
<b>8402</b>	<b>UL Label Kickplate</b> (not available on plastic kickplates)		20.00 ea.

Lead time exception: \*\* Products are stocked and will typically ship in 3-5 days

Bold pricing indicates item is in stock and available for **Fast Track** and **ProXpress**

# Door Plate Hundred Square Inch Sizing Chart

width

height	inches	22	24	26	28	30	32	34	36	38	40	42	44	46	48
4	0.88	0.96	1.04	1.12	1.2	1.28	1.36	1.44	1.52	1.6	1.68	1.76	1.84	1.92	
6	1.32	1.44	1.56	1.68	1.8	1.92	2.04	2.16	2.28	2.4	2.52	2.64	2.76	2.88	
8	1.76	1.92	2.08	2.24	2.4	2.56	2.72	2.88	3.04	3.2	3.36	3.52	3.68	3.84	
10	2.2	2.4	2.6	2.8	3	3.2	3.4	3.60	3.80	4	4.2	4.4	4.6	4.8	
12	2.64	2.88	3.12	3.36	3.6	3.84	4.08	4.32	4.56	4.8	5.04	5.28	5.52	5.76	
14	3.08	3.36	3.64	3.92	4.2	4.48	4.76	5.04	5.32	5.6	5.88	6.16	6.44	6.72	
16	3.52	3.84	4.16	4.48	4.8	5.12	5.44	5.76	6.08	6.4	6.72	7.04	7.36	7.68	
18	3.96	4.32	4.68	5.04	5.4	5.76	6.12	6.48	6.84	7.2	7.56	7.92	8.28	8.64	
20	4.4	4.8	5.2	5.6	6	6.4	6.8	7.20	7.60	8	8.4	8.8	9.2	9.6	
22	4.84	5.28	5.72	6.16	6.6	7.04	7.48	7.92	8.36	8.8	9.24	9.68	10.12	10.56	
24	5.28	5.76	6.24	6.72	7.2	7.68	8.16	8.64	9.12	9.6	10.08	10.56	11.04	11.52	
26	5.72	6.24	6.76	7.28	7.8	8.32	8.84	9.36	9.88	10.4	10.92	11.44	11.96	12.48	
28	6.16	6.72	7.28	7.84	8.4	8.96	9.52	10.08	10.64	11.2	11.76	12.32	12.88	13.44	
30	6.6	7.2	7.8	8.4	9	9.6	10.2	10.80	11.40	12	12.6	13.2	13.8	14.4	
32	7.04	7.68	8.32	8.96	9.6	10.24	10.88	11.52	12.16	12.8	13.44	14.08	14.72	15.36	
34	7.48	8.16	8.84	9.52	10.2	10.88	11.56	12.24	12.92	13.6	14.28	14.96	15.64	16.32	
36	7.92	8.64	9.36	10.08	10.8	11.52	12.24	12.96	13.68	14.4	15.12	15.84	16.56	17.28	
38	8.36	9.12	9.88	10.64	11.4	12.16	12.92	13.68	14.44	15.2	15.96	16.72	17.48	18.24	
40	8.8	9.6	10.4	11.2	12	12.8	13.6	14.40	15.20	16	16.8	17.6	18.4	19.2	
42	9.24	10.08	10.92	11.76	12.6	13.44	14.28	15.12	15.96	16.8	17.64	18.48	19.32	20.16	
44	9.68	10.56	11.44	12.32	13.2	14.08	14.96	15.84	16.72	17.6	18.48	19.36	20.24	21.12	
46	10.12	11.04	11.96	12.88	13.8	14.72	15.64	16.56	17.48	18.4	19.32	20.24	21.16	22.08	
48	10.56	11.52	12.48	13.44	14.4	15.36	16.32	17.28	18.24	19.2	20.16	21.12	22.08	23.04	

### How to price protection plates

1) Look to see if the desired plate is in the the Stocked table. If it is, use this price shown.

2) If the plate is not a stocked plate,

a) Determine the hundred square inch size using the Door Plate Hundred Square Inch Sizing Chart above. If ordering in increments not shown on the chart, use the next larger size (height and/or width) shown in the chart.

Example: For a 6 1/2" x 33 1/2" plate, use 8 x 34 = 2.72 sq. inches.

b) Determine the list price for the height of plate and desired finish from the List Price (per 100 square inches) table.

Example: For a 6 1/2" height plate in US32D finish, use Under 8" column = \$17.00

For base plate pricing, multiply square inch size from part a) times the list price from b)

Example = 2.72 sq. inches X \$17.00 = \$46.24

3) If any options are desired, then add the list add per plate pricing to the base plate pricing.

For a 8402 8 X 34 US32D TK-TX, use the following.

Examples = 2.72 sq. inches X \$15.00 (base price) + \$20.00 (for UL) + \$14.00 (for TK-TX) = \$74.80

**Return Policy** - requires prior approval, consult factory.

HINGES

CONTINUOUS HINGES

PIVOTS

Numerical 1-059

Numerical 59-437

Numerical 438-1021



Numerical 1152-8190

Numerical 8200-9266

Lead time exception: \*\* Products are stocked and will typically ship in 3-5 days

Bold pricing indicates item is in stock and available for **Fast Track** and **ProXpress**

HINGES  
 CONTINUOUS HINGES  
 PIVOTS  
 Numerical 1-059  
 Numerical 59-437  
 Numerical 438-1021  
 Numerical 1152-8190  
 Numerical 8200-9266

MODEL	PULL CTC	SUBSTRATE	MODEL NUMBER	BHMA Finish	WEIGHT	Must Be Ordered in Multiple QTY	Multiple QTY	List Price	
								EACH	PACKAGE
<b>8700</b> <b>Greenwich Decorative Arc Straight Pull 3/4" Dia.</b> See page 64 for optional mounting types and pricing. 	9"	Brass	8700-09-605	605	-	-	1	\$242.20	-
			8700-09-613	613	-	-	1	242.20	-
			8700-09-619*	619	-	-	1	242.20	-
			8700-09-625*	625	-	-	1	242.20	-
			8700-09-626*	626	-	-	1	242.20	-
		8700-09-630	630	-	-	1	235.60	-	
	12"	Brass	8700-12-605	605	-	-	1	252.10	-
			8700-12-613	613	-	-	1	252.10	-
			8700-12-619*	619	-	-	1	252.10	-
			8700-12-625*	625	-	-	1	252.10	-
			8700-12-626*	626	-	-	1	252.10	-
		8700-12-630	630	-	-	1	276.00	-	
	18"	Brass	8700-18-605	605	-	-	1	290.30	-
			8700-18-613	613	-	-	1	290.30	-
			8700-18-619*	619	-	-	1	290.30	-
			8700-18-625*	625	-	-	1	290.30	-
			8700-18-626*	626	-	-	1	290.30	-
		8700-18-630	630	-	-	1	265.10	-	
	24"	Brass	8700-24-605	605	-	-	1	290.30	-
			8700-24-613	613	-	-	1	290.30	-
			8700-24-619*	619	-	-	1	290.30	-
			8700-24-625*	625	-	-	1	290.30	-
			8700-24-626*	626	-	-	1	290.30	-
		8700-24-630	630	-	-	1	265.10	-	
<b>8800</b> <b>Greenwich Decorative Arc Offset Pull 3/4" Dia.</b> See page 64 for optional mounting types and pricing. 	9"	Brass	8800-09-605	605	-	-	1	311.30	-
			8800-09-613	613	-	-	1	311.30	-
			8800-09-619*	619	-	-	1	311.30	-
			8800-09-625*	625	-	-	1	311.30	-
			8800-09-626*	626	-	-	1	311.30	-
		8800-09-630	630	-	-	1	301.30	-	
	12"	Brass	8800-12-605	605	-	-	1	330.30	-
			8800-12-613	613	-	-	1	330.30	-
			8800-12-619*	619	-	-	1	330.30	-
			8800-12-625*	625	-	-	1	330.30	-
			8800-12-626*	626	-	-	1	330.30	-
		8800-12-630	630	-	-	1	326.30	-	
	18"	Brass	8800-18-605	605	-	-	1	362.10	-
			8800-18-613	613	-	-	1	362.10	-
			8800-18-619*	619	-	-	1	362.10	-
			8800-18-625*	625	-	-	1	362.10	-
			8800-18-626*	626	-	-	1	362.10	-
		8800-18-630	630	-	-	1	351.40	-	
	24"	Brass	8800-24-605	605	-	-	1	444.40	-
			8800-24-613	613	-	-	1	444.40	-
			8800-24-619*	619	-	-	1	444.40	-
			8800-24-625*	625	-	-	1	444.40	-
			8800-24-626*	626	-	-	1	444.40	-
		8800-24-630	630	-	-	1	376.70	-	
<b>8848</b> <b>Latitude Decorative Straight Pull w/ Black Stand Offs - 1" Dia.</b> See page 64 for optional mounting types and pricing. 	12"	Brass	8848-12-605	605	-	-	1	602.40	-
			8848-12-613	613	-	-	1	602.40	-
			8848-12-619*	619	-	-	1	602.40	-
			8848-12-625*	625	-	-	1	602.40	-
			8848-12-626*	626	-	-	1	602.40	-
		8848-12-630	630	-	-	1	502.10	-	
	12"	Stainless Steel	8848-12-630	630	-	-	1	502.10	-
			8848-12-BLK*	-	-	-	1	602.40	-
			8848-12-605	605	-	-	1	602.40	-
			8848-12-613	613	-	-	1	602.40	-
			8848-12-619*	619	-	-	1	602.40	-
		8848-12-625*	625	-	-	1	602.40	-	
12"	Aluminum	8975-12-628	628	-	-	1	602.40	-	
		8975-12-613	613	-	-	1	602.40	-	
		8975-12-619*	619	-	-	1	602.40	-	
		8975-12-625*	625	-	-	1	602.40	-	
		8975-12-626*	626	-	-	1	602.40	-	
	8975-12-630	630	-	-	1	502.10	-		

Lead time exception: \*\* Products are stocked and will typically ship in 3-5 days  
 \*Finishes marked may date up to 4-5 weeks for shipment.

Bold pricing indicates item is in stock and available for **Fast Track** and **ProXpress**

MODEL	PUSH CTC	PULL CTC	SUBSTRATE	FINISH	MODEL NUMBER	DESCRIPTION	WEIGHT	ORDER QTY	BOX QTY	LIST PRICE			
<b>9100HD</b> <b>Push Bar, 1" Round,</b> <b>2-1/2" Projection</b> <b>Pull Plate</b>  Custom Sizing Available in 1" increments. Fractional increments available as Engineered Specials.  See page 64 for pricing  Antimicrobial Coating US26D-AM or US32D-AM available.  Standard with NS mounting;  See page 64 for optional mounting types and pricing.	28"		Brass	605	9100HD-28-US3					\$248.70			
				606	9100HD-28-US4			248.70					
				612	9100HD-28-US10			293.10					
				613	9100HD-28-US10B			293.10					
				619	9100HD-28-US15			293.10					
				625	9100HD-28-US26			256.70					
			626	9100HD-28-US26D			256.70						
			Stainless	629	9100HD-28-32			203.50					
				630	9100HD-28-32D			179.50					
				-	9100HD-28-643E/716			293.10					
				-	9100HD-28-BLK			248.70					
			316 Stainless	629-316	9100HD-28-32-316			234.30					
				630-316	9100HD-28-32D-316			206.70					
			33"		Brass	605	9100HD-33-US3						248.70
	606	9100HD-33-US4						248.70					
	612	9100HD-33-US10						293.10					
	613	9100HD-33-US10B						293.10					
	619	9100HD-33-US15						293.10					
	625	9100HD-33-US26						256.70					
	626	9100HD-33-US26D					256.70						
	Stainless	629			9100HD-33-32			273.50					
		630			9100HD-33-32D**			179.50					
		-			9100HD-33-643E/716			293.10					
		-			9100HD-33-BLK			248.70					
	316 Stainless	629-316			9100HD-33-32-316			314.80					
		630-316			9100HD-33-32D-316			206.70					
<b>9103EZHD</b> <b>Push / Pull Combo</b> <b>1" Round</b> <b>(8103EZ Pull + 9100 Push)</b>  Custom Sizing Available in 1" increments. Fractional increments available as Engineered Specials.  See page 64 for pricing  Antimicrobial Coating US26D-AM or US32D-AM available.  See page 64 for optional mounting types and pricing.	28"	8"			Brass	605	9103EZHD-28-8-US3					377.40	
						606	9103EZHD-28-8-US4			377.40			
						612	9103EZHD-28-8-US10			441.50			
						613	9103EZHD-28-8-US10B			441.50			
						619	9103EZHD-28-8-US15			441.50			
			625	9103EZHD-28-8-US26				393.30					
			626	9103EZHD-28-8-US26D			393.30						
			316 Stainless	629-316	9103EZHD-28-8-32-316			364.40					
				630-316	9103EZHD-28-8-32D-316			323.60					
				-	9103EZHD-28-8-643E/716			441.50					
				-	9103EZHD-28-8-BLK			377.40					
			28"	10"	Brass	605	9103EZHD-28-0-US3						356.20
						606	9103EZHD-28-0-US4			375.70			
						612	9103EZHD-28-0-US10			375.70			
	613	9103EZHD-28-0-US10B						375.70					
	619	9103EZHD-28-0-US15						375.70					
	625	9103EZHD-28-0-US26						375.70					
	626	9103EZHD-28-0-US26D					375.70						
	316 Stainless	629-316			9103EZHD-28-0-32-316			374.50					
		630-316			9103EZHD-28-0-32D-316			333.30					
		-			9103EZHD-28-0-643E/716			375.70					
		-	9103EZHD-28-0-BLK			356.20							
	28"	12"	Brass	605	9103EZHD-28-2-US3						372.20		
				606	9103EZHD-28-2-US4			372.20					
				612	9103EZHD-28-2-US10			432.50					
				613	9103EZHD-28-2-US10B			432.50					
619				9103EZHD-28-2-US15			432.50						
625				9103EZHD-28-2-US26			384.20						
626			9103EZHD-28-2-US26D			384.20							
316 Stainless			629-316	9103EZHD-28-2-32-316			384.40						
			630-316	9103EZHD-28-2-32D-316			342.90						
			-	9103EZHD-28-2-643E/716			432.50						
	-	9103EZHD-28-2-BLK			372.20								
33"	8"	Brass	605	9103EZHD-33-8-US3						377.40			
			606	9103EZHD-33-8-US4			377.40						
			612	9103EZHD-33-8-US10			441.50						
			613	9103EZHD-33-8-US10B			441.50						
			619	9103EZHD-33-8-US15			441.50						
			625	9103EZHD-33-8-US26			393.30						
		626	9103EZHD-33-8-US26D			393.30							
		316 Stainless	629-316	9103EZHD-33-8-32-316			444.90						
			630-316	9103EZHD-33-8-32D-316			323.60						
			-	9103EZHD-33-8-643E/716			441.50						
-	9103EZHD-33-8-BLK				377.40								
33"	10"	Brass	605	9103EZHD-33-0-US3						364.40			
			606	9103EZHD-33-0-US4			364.40						
			612	9103EZHD-33-0-US10			420.40						
			613	9103EZHD-33-0-US10B			420.40						
			619	9103EZHD-33-0-US15			375.70						
			625	9103EZHD-33-0-US26			376.60						
		626	9103EZHD-33-0-US26D			376.60							
		316 Stainless	629-316	9103EZHD-33-0-32-316			454.80						
			630-316	9103EZHD-33-0-32D-316			333.30						
			-	9103EZHD-33-0-643E/716			420.40						
-	9103EZHD-33-0-BLK				364.40								
33"	12"	Brass	605	9103EZHD-33-2-US3						372.20			
			606	9103EZHD-33-2-US4			372.20						
			612	9103EZHD-33-2-US10			432.50						
			613	9103EZHD-33-2-US10B			432.50						
			619	9103EZHD-33-2-US15			432.50						
			625	9103EZHD-33-2-US26			384.20						
		626	9103EZHD-33-2-US26D			384.20							
		316 Stainless	629-316	9103EZHD-33-2-32-316			464.70						
			630-316	9103EZHD-33-2-32D-316			342.90						
			-	9103EZHD-33-2-643E/716			432.50						
-	9103EZHD-33-2-BLK				372.20								

HINGES  
 CONTINUOUS HINGES  
 PIVOTS  
 Numerical 1-059  
 Numerical 59-437  
 Numerical 438-1021  
 Numerical 1152-8190  
 Numerical 8200-9266

Lead time exception: \*\* Products are stocked and will typically ship in 3-5 days

Bold pricing indicates item is in stock and available for **Fast Track** and **ProXpress**



HINGES  
 CONTINUOUS HINGES  
 PIVOTS  
 Numerical 1-059  
 Numerical 59-437  
 Numerical 438-1021  
 Numerical 1152-8190  
 Numerical 8200-9266

MODEL	PUSH CTC	PULL CTC	SUBSTRATE	FINISH	MODEL NUMBER	DESCRIPTION	WEIGHT	ORDER QTY	BOX QTY	LIST PRICE	
<b>9145EZHD</b> <b>Push / Pull Combo</b> <b>1" Round</b> (8145EZHD Pull + 9100HD Push) <i>Custom Sizing Available in 1" increments</i> <i>Fractional increments available as Engineered Specials</i>  See page 64 for pricing  <i>Antimicrobial Coating US26D-AM or US32D-AM available.</i>  See page 64 for optional mounting types and pricing.	28"	8"	Brass	605	9145EZHD-28-8-USB3					\$410.20	
				606	9145EZHD-28-8-US4			410.20			
				612	9145EZHD-28-8-US10			475.60			
				613	9145EZHD-28-8-US10B			475.60			
				619	9145EZHD-28-8-US15			475.60			
				625	9145EZHD-28-8-US26			426.30			
			626	9145EZHD-28-8-US26D			426.30				
			316 Stainless	629-316	9145EZHD-28-8-32-316			402.80			
				630-316	9145EZHD-28-8-32D-316			350.40			
				-	9145EZHD-28-8-643E/716			475.60			
	-	9145EZHD-28-8-BLK				410.20					
	28"	10"	Brass	605	9145EZHD-28-0-US3						422.60
				606	9145EZHD-28-0-US4			422.60			
				612	9145EZHD-28-0-US10			484.20			
				613	9145EZHD-28-0-US10B			484.20			
				619	9145EZHD-28-0-US15			484.20			
				625	9145EZHD-28-0-US26			439.10			
			626	9145EZHD-28-0-US26D			439.10				
			316 Stainless	629-316	9145EZHD-28-0-32-316			412.80			
				630-316	9145EZHD-28-0-32D-316			360.40			
				-	9145EZHD-28-0-643E/716			484.20			
	-	9145EZHD-28-0-BLK				422.60					
	28"	12"	Brass	605	9145EZHD-28-2-US3						431.30
				606	9145EZHD-28-2-US4			431.30			
				612	9145EZHD-28-2-US10			496.90			
				613	9145EZHD-28-2-US10B			496.90			
				619	9145EZHD-28-2-US15			496.90			
				625	9145EZHD-28-2-US26			452.10			
			626	9145EZHD-28-2-US26D			452.10				
			316 Stainless	629-316	9145EZHD-28-2-32-316			422.90			
				630-316	9145EZHD-28-2-32D-316			370.40			
				-	9145EZHD-28-2-643E/716			496.90			
	-	9145EZHD-28-2-BLK				431.30					
	28"	18"	Brass	605	9145EZHD-28-18-US3						486.20
				606	9145EZHD-28-18-US4			486.20			
				612	9145EZHD-28-18-US10			555.90			
				613	9145EZHD-28-18-US10B			555.90			
				619	9145EZHD-28-18-US15			555.90			
				625	9145EZHD-28-18-US26			506.60			
			626	9145EZHD-28-18-US26D			506.60				
			316 Stainless	629-316	9145EZHD-28-18-32-316			480.00			
				630-316	9145EZHD-28-18-32D-316			427.80			
				-	9145EZHD-28-18-643E/716			555.90			
	-	9145EZHD-28-18-BLK				486.20					
	33"	8"	Brass	605	9145EZHD-33-8-US3						410.20
				606	9145EZHD-33-8-US4			410.20			
				612	9145EZHD-33-8-US10			475.60			
				613	9145EZHD-33-8-US10B			475.60			
				619	9145EZHD-33-8-US15			475.60			
				625	9145EZHD-33-8-US26			426.30			
			626	9145EZHD-33-8-US26D			426.30				
			316 Stainless	629-316	9145EZHD-33-8-32-316			483.30			
				630-316	9145EZHD-33-8-32D-316			350.40			
				-	9145EZHD-33-8-643E/716			475.60			
	-	9145EZHD-33-8-BLK				410.20					
	33"	10"	Brass	605	9145EZHD-33-0-US3						422.60
				606	9145EZHD-33-0-US4			422.60			
				612	9145EZHD-33-0-US10			484.20			
				613	9145EZHD-33-0-US10B			484.20			
				619	9145EZHD-33-0-US15			484.20			
				625	9145EZHD-33-0-US26			439.10			
			626	9145EZHD-33-0-US26D			439.10				
			316 Stainless	629-316	9145EZHD-33-0-32-316			493.20			
				630-316	9145EZHD-33-0-32D-316			360.40			
				-	9145EZHD-33-0-643E/716			484.20			
	-	9145EZHD-33-0-BLK				422.60					
	33"	12"	Brass	605	9145EZHD-33-2-US3						431.30
				606	9145EZHD-33-2-US4			431.30			
				612	9145EZHD-33-2-US10			496.90			
				613	9145EZHD-33-2-US10B			496.90			
				619	9145EZHD-33-2-US15			496.90			
				625	9145EZHD-33-2-US26			452.10			
			626	9145EZHD-33-2-US26D			452.10				
			316 Stainless	629-316	9145EZHD-33-2-32-316			503.30			
				630-316	9145EZHD-33-2-32D-316			370.40			
				-	9145EZHD-33-2-643E/716			496.90			
	-	9145EZHD-33-2-BLK				431.30					
	33"	18"	Brass	605	9145EZHD-33-18-US3						486.20
				606	9145EZHD-33-18-US4			486.20			
				612	9145EZHD-33-18-US10			555.90			
				613	9145EZHD-33-18-US10B			555.90			
				619	9145EZHD-33-18-US15			555.90			
				625	9145EZHD-33-18-US26			506.60			
			626	9145EZHD-33-18-US26D			506.60				
			316 Stainless	629-316	9145EZHD-33-18-32-316			560.30			
				630-316	9145EZHD-33-18-32D-316			427.80			
				-	9145EZHD-33-18-643E/716			555.90			
	-	9145EZHD-33-18-BLK				486.20					

Lead time exception: \*\* Products are stocked and will typically ship in 3-5 days

Bold pricing indicates item is in stock and available for **Fast Track** and **ProXpress**

MODEL	PUSH CTC	PULL CTC	SUBSTRATE	FINISH	MODEL NUMBER	DESCRIPTION	WEIGHT	ORDER QTY	BOX QTY	LIST PRICE	
<b>9190HD</b> <b>Push / Pull Combo</b> <b>1" Round</b> (8190HD Pull + 9100HD PUSH)  Custom Sizing Available in 1/8" increments. Fractional increments available as Engineered Specials. See page 64 for pricing  Antimicrobial Coating US26D-AM or US32D-AM available.  See page 64 for optional mounting types and pricing.		28"	8"	Brass	605	9190HD-28-8-US3				\$384.20	
					606	9190HD-28-8-US4			384.20		
					612	9190HD-28-8-US10			448.60		
					613	9190HD-28-8-US10B			448.60		
					619	9190HD-28-8-US15			441.30		
				625	9190HD-28-8-US26			400.40			
				626	9190HD-28-8-US26D			400.40			
				Stainless	629	9190HD-28-8-US32			324.80		
					630	9190HD-28-8-US32D			280.80		
					-	9190HD-28-8-643E/716			448.60		
		-	9190HD-28-8-BLK				384.20				
		-									
		28"	10"	Brass	605	9190HD-28-0-US3					396.30
					606	9190HD-28-0-US4			396.30		
					612	9190HD-28-0-US10			456.30		
					613	9190HD-28-0-US10B			456.30		
					619	9190HD-28-0-US15			449.60		
				625	9190HD-28-0-US26			412.40			
				626	9190HD-28-0-US26D			412.40			
				Stainless	629	9190HD-28-0-US32			332.50		
					630	9190HD-28-0-US32D			288.80		
					-	9190HD-28-0-643E/716			456.30		
		-	9190HD-28-0-BLK				396.30				
		-									
		28"	12"	Brass	605	9190HD-28-2-US3					404.60
					606	9190HD-28-2-US4			404.60		
					612	9190HD-28-2-US10			468.70		
					613	9190HD-28-2-US10B			468.70		
					619	9190HD-28-2-US15			461.40		
				625	9190HD-28-2-US26			424.60			
				626	9190HD-28-2-US26D			424.60			
				Stainless	629	9190HD-28-2-US32			410.60		
					630	9190HD-28-2-US32D			296.50		
					-	9190HD-28-2-643E/716			468.70		
		-	9190HD-28-2-BLK				404.60				
		-									
		28"	18"	Brass	605	9190HD-28-18-US3					449.60
					606	9190HD-28-18-US4			449.60		
					612	9190HD-28-18-US10			517.60		
					613	9190HD-28-18-US10B			517.60		
					619	9190HD-28-18-US15			517.60		
				625	9190HD-28-18-US26			469.40			
				626	9190HD-28-18-US26D			469.40			
				Stainless	629	9190HD-28-18-US32			379.50		
					630	9190HD-28-18-US32D			335.40		
					-	9190HD-28-18-643E/716			517.60		
		-	9190HD-28-18-BLK				449.60				
		-									
		33"	8"	Brass	605	9190HD-33-8-US3					384.20
					606	9190HD-33-8-US4			384.20		
					612	9190HD-33-8-US10			448.60		
					613	9190HD-33-8-US10B			448.60		
					619	9190HD-33-8-US15			441.30		
				625	9190HD-33-8-US26			400.40			
				626	9190HD-33-8-US26D			400.40			
				Stainless	629	9190HD-33-8-US32			324.80		
					630	9190HD-33-8-US32D			280.80		
					-	9190HD-33-8-643E/716			449.60		
		-	9190HD-33-8-BLK				384.20				
		-									
		33"	10"	Brass	605	9190HD-33-0-US3					396.30
					606	9190HD-33-0-US4			396.30		
					612	9190HD-33-0-US10			456.30		
					613	9190HD-33-0-US10B			456.30		
					619	9190HD-33-0-US15			449.60		
				625	9190HD-33-0-US26			412.40			
				626	9190HD-33-0-US26D			412.40			
				Stainless	629	9190HD-33-0-US32			332.50		
					630	9190HD-33-0-US32D**			<b>288.80</b>		
					-	9190HD-33-0-643E/716			456.30		
		-	9190HD-33-0-BLK				396.30				
		-									
		33"	12"	Brass	605	9190HD-33-2-US3					404.60
					606	9190HD-33-2-US4			404.60		
					612	9190HD-33-2-US10			468.70		
					613	9190HD-33-2-US10B			468.70		
					619	9190HD-33-2-US15			461.40		
				625	9190HD-33-2-US26			424.60			
				626	9190HD-33-2-US26D			424.60			
				Stainless	629	9190HD-33-2-US32			410.60		
					630	9190HD-33-2-US32D			296.50		
					-	9190HD-33-2-643E/716			468.70		
		-	9190HD-33-2-BLK				404.60				
		-									
		33"	18"	Brass	605	9190HD-33-18-US3					449.60
					606	9190HD-33-18-US4			449.60		
					612	9190HD-33-18-US10			517.60		
					613	9190HD-33-18-US10B			517.60		
					619	9190HD-33-18-US15			517.60		
				625	9190HD-33-18-US26			469.40			
				626	9190HD-33-18-US26D			469.40			
				Stainless	629	9190HD-33-18-US32			449.30		
					630	9190HD-33-18-US32D			335.40		
					-	9190HD-33-18-643E/716			517.60		
		-	9190HD-33-18-BLK				449.60				
		-									

HINGES  
 CONTINUOUS HINGES  
 PIVOTS  
 Numerical 1-059  
 Numerical 59-437  
 Numerical 438-1021  
 Numerical 1152-8190  
 Numerical 8200-9266

Lead time exception: \*\* Products are stocked and will typically ship in 3-5 days

Bold pricing indicates item is in stock and available for **Fast Track** and **ProXpress**

HINGES  
 CONTINUOUS HINGES  
 PIVOTS  
 Numerical 1-059  
 Numerical 59-437  
 Numerical 438-1021  
 Numerical 1152-8190  
 Numerical 8200-9266

MODEL	PUSH CTC	PULL CTC	SUBSTRATE	FINISH	MODEL NUMBER	DESCRIPTION	WEIGHT	ORDER QTY	BOX QTY	LIST PRICE			
<b>9190EZHD</b> <b>Push / Pull Combo</b> <b>1" Round</b> (8190EZHD Pull + 9100HD Push)  <i>Custom Sizing Available in 1" increments</i>  <i>Fractional increments available as Engineered Specials</i>  See page 64 for pricing  <i>Antimicrobial Coating US26D-AM or US32D-AM available.</i>  See page 64 for optional mounting types and pricing.	28"	8"	Brass	605	9190EZHD-28-8-USB3					\$410.20			
				606	9190EZHD-28-8-US4			410.20					
				612	9190EZHD-28-8-US10			475.60					
				613	9190EZHD-28-8-US10B			475.60					
				619	9190EZHD-28-8-US15			475.60					
			625	9190EZHD-28-8-US26			426.30						
			626	9190EZHD-28-8-US26D			426.30						
			629-316	9190EZHD-28-8-32-316			402.80						
			630-316	9190EZHD-28-8-32D-316			350.40						
			-	9190EZHD-28-8-643E/716			475.60						
		-	9190EZHD-28-8-BLK			410.20							
		316 Stainless	629-316	9190EZHD-28-0-US3			422.60						
			630-316	9190EZHD-28-0-US4			422.60						
			-	9190EZHD-28-0-US10			484.20						
			-	9190EZHD-28-0-US10B			484.20						
			-	9190EZHD-28-0-US15			484.20						
			-	9190EZHD-28-0-US26			439.10						
			-	9190EZHD-28-0-US26D			439.10						
			629-316	9190EZHD-28-0-32-316			412.80						
			630-316	9190EZHD-28-0-32D-316			360.40						
	-		9190EZHD-28-0-643E/716			484.20							
	-	9190EZHD-28-0-BLK			422.60								
	28"	12"	Brass	605	9190EZHD-28-2-US3						431.30		
				606	9190EZHD-28-2-US4			431.30					
				612	9190EZHD-28-2-US10			496.90					
				613	9190EZHD-28-2-US10B			496.90					
				619	9190EZHD-28-2-US15			496.90					
			625	9190EZHD-28-2-US26			452.10						
			626	9190EZHD-28-2-US26D			452.10						
			629-316	9190EZHD-28-2-32-316			422.90						
			630-316	9190EZHD-28-2-32D-316			370.40						
			-	9190EZHD-28-2-643E/716			496.90						
		-	9190EZHD-28-2-BLK			431.30							
		316 Stainless	629-316	9190EZHD-28-2-32-316			422.90						
			630-316	9190EZHD-28-2-32D-316			370.40						
			-	9190EZHD-28-2-643E/716			496.90						
			-	9190EZHD-28-2-BLK			431.30						
			28"	18"	Brass	605	9190EZHD-28-18-US3						486.20
						606	9190EZHD-28-18-US4			486.20			
						612	9190EZHD-28-18-US10			555.90			
						613	9190EZHD-28-18-US10B			555.90			
						619	9190EZHD-28-18-US15			555.90			
	625				9190EZHD-28-18-US26			506.60					
	626	9190EZHD-28-18-US26D					506.60						
	629-316	9190EZHD-28-18-32-316					480.00						
	630-316	9190EZHD-28-18-32D-316					427.80						
	-	9190EZHD-28-18-643E/716					555.90						
	-	9190EZHD-28-18-BLK				486.20							
	316 Stainless	629-316		9190EZHD-28-18-32-316			480.00						
		630-316		9190EZHD-28-18-32D-316			427.80						
		-		9190EZHD-28-18-643E/716			555.90						
		-		9190EZHD-28-18-BLK			486.20						
		33"		8"	Brass	605	9190EZHD-33-8-US3						410.20
						606	9190EZHD-33-8-US4			410.20			
						612	9190EZHD-33-8-US10			475.60			
						613	9190EZHD-33-8-US10B			475.60			
						619	9190EZHD-33-8-US15			475.60			
			625		9190EZHD-33-8-US26			426.30					
	626		9190EZHD-33-8-US26D				426.30						
	629-316		9190EZHD-33-8-32-316				483.30						
	630-316		9190EZHD-33-8-32D-316				350.40						
	-		9190EZHD-33-8-643E/716				475.60						
	-		9190EZHD-33-8-BLK			410.20							
	316 Stainless		629-316	9190EZHD-33-8-32-316			483.30						
			630-316	9190EZHD-33-8-32D-316			350.40						
			-	9190EZHD-33-8-643E/716			475.60						
			-	9190EZHD-33-8-BLK			410.20						
			33"	10"	Brass	605	9190EZHD-33-0-US3						422.60
						606	9190EZHD-33-0-US4			422.60			
						612	9190EZHD-33-0-US10			484.20			
						613	9190EZHD-33-0-US10B			484.20			
						619	9190EZHD-33-0-US15			484.20			
		625			9190EZHD-33-0-US26			439.10					
	626	9190EZHD-33-0-US26D					439.10						
	629-316	9190EZHD-33-0-32-316					493.20						
	630-316	9190EZHD-33-0-32D-316					360.40						
	-	9190EZHD-33-0-643E/716					484.20						
	-	9190EZHD-33-0-BLK				422.60							
	316 Stainless	629-316		9190EZHD-33-0-32-316			493.20						
		630-316		9190EZHD-33-0-32D-316			360.40						
		-		9190EZHD-33-0-643E/716			484.20						
		-		9190EZHD-33-0-BLK			422.60						
		33"		12"	Brass	605	9190EZHD-33-2-US3						431.30
						606	9190EZHD-33-2-US4			431.30			
						612	9190EZHD-33-2-US10			496.90			
						613	9190EZHD-33-2-US10B			496.90			
						619	9190EZHD-33-2-US15			496.90			
			625		9190EZHD-33-2-US26			452.10					
	626		9190EZHD-33-2-US26D				452.10						
	629-316		9190EZHD-33-2-32-316				503.30						
	630-316		9190EZHD-33-2-32D-316				370.40						
	-		9190EZHD-33-2-643E/716				496.90						
	-		9190EZHD-33-2-BLK			431.30							
	316 Stainless		629-316	9190EZHD-33-2-32-316			503.30						
			630-316	9190EZHD-33-2-32D-316			370.40						
			-	9190EZHD-33-2-643E/716			496.90						
			-	9190EZHD-33-2-BLK			431.30						
			33"	18"	Brass	605	9190EZHD-33-18-US3						486.20
						606	9190EZHD-33-18-US4			486.20			
						612	9190EZHD-33-18-US10			555.90			
613						9190EZHD-33-18-US10B			555.90				
619						9190EZHD-33-18-US15			555.90				
625		9190EZHD-33-18-US26					506.60						
626	9190EZHD-33-18-US26D					506.60							
629-316	9190EZHD-33-18-32-316					560.30							
630-316	9190EZHD-33-18-32D-316					427.80							
-	9190EZHD-33-18-643E/716					555.90							
-	9190EZHD-33-18-BLK				486.20								
316 Stainless	629-316	9190EZHD-33-18-32-316				560.30							
	630-316	9190EZHD-33-18-32D-316				427.80							
	-	9190EZHD-33-18-643E/716				555.90							
	-	9190EZHD-33-18-BLK				486.20							

Lead time exception: \*\* Products are stocked and will typically ship in 3-5 days

Bold pricing indicates item is in stock and available for **Fast Track** and **ProXpress**

**Offset Long Pulls**

	Length	Pull CTC	FINISH	List
9264 (Round Tip) or 9264F (Flat Tip)	12"	8"	605	\$410.20
	12"	8"	606	410.20
	12"	8"	613	422.20
	12"	8"	619	422.20
	12"	8"	629-316	416.20
	12"	8"	630-316	349.80
	12"	8"	643E/716	422.20
	12"	8"	BLK	410.20
9264 (Round Tip) or 9264F (Flat Tip)	18"	12"	605	470.50
	18"	12"	606	470.50
	18"	12"	613	482.70
	18"	12"	619	482.70
	18"	12"	629-316	464.50
	18"	12"	630-316	380.00
	18"	12"	643E/716	482.70
	18"	12"	BLK	470.50
9264 (Round Tip) or 9264F (Flat Tip)	24"	18"	605	530.80
	24"	18"	606	530.80
	24"	18"	613	542.90
	24"	18"	619	542.90
	24"	18"	629-316	512.80
	24"	18"	630-316	410.20
	24"	18"	643E/716	542.90
	24"	18"	BLK	530.80
9264 (Round Tip) or 9264F (Flat Tip)	36"	20"	605	795.30
	36"	20"	606	829.00
	36"	20"	613	875.50
	36"	20"	619	875.50
	36"	20"	629-316	804.90
	36"	20"	630-316**	541.80
	36"	20"	643E/716	875.50
	36"	20"	BLK	829.00
9264 (Round Tip) or 9264F (Flat Tip)	72"	56"	605	974.20
	72"	56"	606	974.20
	72"	56"	613	1,013.00
	72"	56"	619	1,013.00
	72"	56"	629-316	945.80
	72"	56"	630-316	647.50
	72"	56"	BLK	974.20
	72"	56"	BLK	974.20

**Straight Long Pulls**

9266 (Round Tip) or 9266F (Flat Tip)	12"	8"	605	\$325.80
	12"	8"	606	325.80
	12"	8"	613	331.80
	12"	8"	619	331.80
	12"	8"	629-316	325.80
	12"	8"	630-316	259.40
	12"	8"	643E/716	331.80
	12"	8"	BLK	325.80
9266 (Round Tip) or 9266F (Flat Tip)	18"	12"	605	386.00
	18"	12"	606	386.00
	18"	12"	613	392.00
	18"	12"	619	392.00
	18"	12"	629-316	374.10
	18"	12"	630-316	289.50
	18"	12"	643E/716	392.00
	18"	12"	BLK	386.00
9266 (Round Tip) or 9266F (Flat Tip)	24"	18"	605	446.40
	24"	18"	606	446.40
	24"	18"	613	452.30
	24"	18"	619	452.30
	24"	18"	629-316	422.20
	24"	18"	630-316	319.70
	24"	18"	643E/716	452.30
	24"	18"	BLK	446.40
9266 (Round Tip) or 9266F (Flat Tip)	36"	20"	605	619.20
	36"	20"	606	645.50
	36"	20"	613	661.80
	36"	20"	619	661.80
	36"	20"	629-316	626.80
	36"	20"	630-316	453.10
	36"	20"	643E/716*	661.80
	36"	20"	BLK	645.50
9266 (Round Tip) or 9266F (Flat Tip)	72"	56"	605	789.70
	72"	56"	606	789.70
	72"	56"	613	798.80
	72"	56"	619	798.80
	72"	56"	629-316	767.80
	72"	56"	630-316	566.70
	72"	56"	BLK	789.70
	72"	56"	BLK	789.70

See Next Page for Long Pull Options Pricing

See page 64 for optional mounting types and pricing.

\* Max length for 643E/716 finish is 36"

- Custom Lengths, Center to Center, and Finishes
- Additional Mounting Brackets

**Lead time exception:** \*\* Products are stocked and will typically ship in 3-5 days

**Bold pricing indicates item is in stock and available for Fast Track and ProXpress**

# Long Pull Options

<b>Custom Lengths*</b>		<b>FINISH</b>	<b>List</b>
· Order in 1" increments. List price for 1" increments between 12" and 72" use next larger size list price.			
· Greater than 72", use list price add per inch charge per finish.		605, 606, BLK	\$64.00
		613, 619,	73.00
		629-316	76.00
		630-316	14.00
· If fractional lengths are required, use the following list adder. For pulls less than 72" long, use the next higher standard length price plus the list adder for pricing. For pulls greater than 72", use the 72" price plus the price add per inch plus the fractional list adder.			174.00
<b>Custom Center to Center*</b>		<b>FINISH</b>	<b>List</b>
· If not specified, standard center to center length for pulls 36" or longer, center to center length is 16" less than total pull length. Center to Center length must be specified for lengths less than 36"			
· For non standard center to center lengths or locations on standard length pulls, use the following list adder. Consult factory if the center to center length is less than half the total pull length. If the fractional custom length adder is being applied, then the custom center to center will not be applied			88.00
<b>Custom Finishes*</b>		<b>FINISH</b>	<b>List</b>
Custom painting & Antimicrobial Coating <i>US32D-AM only</i>	Contact customer service for size availability, pricing, and color approval. Additional lead time up to 6 weeks may be needed.		
*Return Policy - requires prior approval, consult factory			
<b>Optional Mounting Hardware</b>		<b>FINISH</b>	<b>List</b>
MB	Additional Mounting Bracket, list price adder per bracket <i>Unless specified, additional mounting brackets are centered on pull. Mounting Bracket and list adder are required for pulls over 96".</i>		156.00
See page 64 for optional mounting types and pricing.			

HINGES

CONTINUOUS HINGES

PIVOTS

Numerical 1-059

Numerical 59-437

Numerical 438-1021

Numerical 1152-8190

Numerical 8200-9266

**Lead time exception:** \*\* Products are stocked and will typically ship in 3-5 days

Bold pricing indicates item is in stock and available for **Fast Track** and **ProXpress**

**IVES ARCHITECTURAL HARDWARE - Parts Price List**

Description	Finish	Part No.	List Price Each
<b>3.5X3.5 HINGES Item 3CB1, 3PB1, 5BB1, 5PB1</b>			
3.5X3.5 Hinge Mtg Pkg	600(USP)	HGPART.1171	\$3.50
3.5X3.5 Hinge Mtg Pkg	630(US32D), 629(US32), 646/619(US15)	HGPART.1170	3.50
3.5X3.5 Hinge Mtg Pkg	632/605(US3), 633/606(US4)	HGPART.1173	3.50
3.5X3.5 Hinge Mtg Pkg	639(US10), 612 (US10)	HGPART.1174	3.50
3.5X3.5 Hinge Mtg Pkg	640/613(US10B), 641/614(US10A), 643/616(US11)	HGPART.1175	3.50
3.5X3.5 Hinge Mtg Pkg	651/625(US26), 652/626(US26D)	HGPART.1176	3.50
3.5X3.5 Hinge Mtg Pkg	BLK	HGPART.1172	3.50
<b>HINGES Item 3CB1, 3PB1, 3SP1, 5BB1, 5BB1SC, 5PB1 (4X4 Hinges or Larger)</b>			
Hinge Mtg Pkg	605(US3), 632(US3), 633(US4)	HGPART.1001	3.50
Hinge Mtg Pkg	639(US10)	HGPART.1002	3.50
Hinge Mtg Pkg	600(USP),630(US32D),651(US26)	HGPART.1003	3.50
Hinge Mtg Pkg	643(US11)	HGPART.1004	3.50
Hinge MS Security Mtg Pkg	-	HGPART.1005	24.10
Hinge MS Mtg Screws Pkg of 100 - Steel	600(USP)	HGPART.1026	6.40
Hinge MS Mtg Screws Pkg of 100 - Brass	605(US3)	HGPART.1008	12.80
Hinge MS Mtg Screws Pkg of 100 - Steel	632(US3)	HGPART.1018	6.40
Hinge MS Mtg Screws Pkg of 100 - Brass	606(US4)	HGPART.1032	12.80
Hinge MS Mtg Screws Pkg of 100 - Steel	633(US4)	HGPART.1035	6.40
Hinge MS Mtg Screws Pkg of 100 - Brass	612(US10)	HGPART.1010	12.80
Hinge MS Mtg Screws Pkg of 100 - Steel	639(US10)	HGPART.1019	6.40
Hinge MS Mtg Screws Pkg of 100 - Brass	613(US10B)	HGPART.1011	12.80
Hinge MS Mtg Screws Pkg of 100 - Steel	640(US10B)	HGPART.1020	6.40
Hinge MS Mtg Screws Pkg of 100 - Steel	641(US10A)	HGPART.1028	6.40
Hinge MS Mtg Screws Pkg of 100 - Steel	643(US11)	HGPART.1029	6.40
Hinge MS Mtg Screws Pkg of 100 - Brass	619(US15)	HGPART.1009	12.80
Hinge MS Mtg Screws Pkg of 100 - Steel	646(US15)	HGPART.1021	6.40
Hinge MS Mtg Screws Pkg of 100 - Brass	625(US26)	HGPART.1033	12.80
Hinge MS Mtg Screws Pkg of 100 - Steel	651(US26)	HGPART.1036	6.40
Hinge MS Mtg Screws Pkg of 100 - Brass	626(US26D)	HGPART.1034	12.80
Hinge MS Mtg Screws Pkg of 100 - Steel	652(US26D)	HGPART.1037	6.40
Hinge MS Mtg Screws Pkg of 100 - Stainless Steel	630(US32D)	HGPART.1016	12.80
Hinge WS Mtg Screws Pkg of 100 - Steel	600(USP)	HGPART.1027	6.40
Hinge WS Mtg Screws Pkg of 100 - Brass	605(US3)	HGPART.1012	25.40
Hinge WS Mtg Screws Pkg of 100 - Steel	632(US3)	HGPART.1022	6.40
Hinge WS Mtg Screws Pkg of 100 - Brass	606(US4)	HGPART.1038	27.10
Hinge WS Mtg Screws Pkg of 100 - Steel	633(US4)	HGPART.1041	6.40
Hinge WS Mtg Screws Pkg of 100 - Brass	612(US10)	HGPART.1014	27.10
Hinge WS Mtg Screws Pkg of 100 - Steel	639(US10)	HGPART.1023	6.40
Hinge WS Mtg Screws Pkg of 100 - Brass	613(US10B)	HGPART.1015	27.10
Hinge WS Mtg Screws Pkg of 100 - Steel	640(US10B)	HGPART.1024	6.40
Hinge WS Mtg Screws Pkg of 100 - Steel	641(US10A)	HGPART.1030	6.40
Hinge WS Mtg Screws Pkg of 100 - Steel	643(US11)	HGPART.1031	6.40
Hinge WS Mtg Screws Pkg of 100 - Brass	619(US15)	HGPART.1013	25.40
Hinge WS Mtg Screws Pkg of 100 - Steel	646(US15)	HGPART.1025	6.40
Hinge WS Mtg Screws Pkg of 100 - Brass	625(US26)	HGPART.1039	25.40
Hinge WS Mtg Screws Pkg of 100 - Steel	651(US26)	HGPART.1042	6.40
Hinge WS Mtg Screws Pkg of 100 - Brass	626(US26D)	HGPART.1040	25.40
Hinge WS Mtg Screws Pkg of 100 - Steel	652(US26D)	HGPART.1043	6.40
Hinge WS Mtg Screws Pkg of 100 - Stainless Steel	630(US32D)	HGPART.1017	25.40
<b>CONTINUOUS HINGES - GEARED</b>			
Chinge Geared Tek Scr Pkg Us28 (Pkg of 48)	US28	HGPART.1070	23.40
Chinge Geared Tek Scr Pkg 313AN, 315AN (Pkg of 48)	313AN, 315AN	HGPART.1071	23.40
Chinge Geared Tek/Wd Scr Pkg Us28 (24 Tek/24 Wood)	US28	HGPART.1102	23.40

Contact Ives Customer Service for pricing on additional sizes and finishes

Bold pricing indicates item is in stock and available for **Fast Track** and **ProXpress**



## IVES ARCHITECTURAL HARDWARE - Parts Price List

Description	Finish	Part No.	List Price Each
<b>CONTINUOUS HINGES - GEARED (Continued)</b>			
Chinge Geared Tek/Wd Scr Pkg 313AN, 315AN (24 Tek/24 Wood)	313AN, 315AN	HGPART.1103	\$23.40
Chinge Geared Wd Scr Pkg Us28 (Pkg of 48)	US28	HGPART.1068	23.40
Chinge Geared Wd Scr Pkg 313AN, 315AN (Pkg of 48)	313AN, 315AN	HGPART.1069	23.40
Chinge Geared Hm Sec Scr Pkg Us32D (Pkg of 24)	US32D	HGPART.1104	41.50
Chinge Geared Wd Sec Scr Pkg Us32D (Pkg of 24)	US32D	HGPART.1105	41.50
112HD TWP Panel Service Kit	US28	840737-28	293.00
112HD TWP Panel Service Kit	313AN, 315AN	840737-42	293.00
224HD TWP Panel Service Kit	US28	840738-28	293.00
224HD TWP Panel Service Kit	313AN, 315AN	840738-42	293.00
XY TWP CON Panel Service Kit	US28	HGPART.1159	345.00
XY TWP CON Panel Service Kit	313AN, 315AN	HGPART.1160	345.00
<b>CONTINUOUS HINGES - Pin &amp; Barrel</b>			
Chinge Pin & Barrel #10 X 1/2 Tek Screw SELF DRILL (Pkg of 54)	US32D	HGPART.1044	26.10
Chinge Pin & Barrel #10 X 1 Flat Head Wood Screw (Pkg of 27)	US32D	HGPART.1046	12.90
Chinge Pin & Barrel Adjustment Stud (Pkg of 27)	US32D	HGPART.1048	108.20
Chinge Pin & Barrel #10 X 3/4" Tek Screw (Pkg of 27)	US32D	HGPART.1050	22.10
Chinge Pin & Barrel 120" 1/2" TEK screw pkg		HGPART.1044	26.10
Chinge Pin & Barrel 120" Full Surface screw pkg (Pan Head TEK)		HGPART.1045	20.80
Chinge Pin & Barrel 120" wood screw pkg		HGPART.1046	12.80
Chinge Pin & Barrel 120" Full Surface cover clip pkg		HGPART.1047	43.70
Chinge Pin & Barrel 120" Adjustment stud (with machine screws) pkg		HGPART.1048	102.50
Chinge Pin & Barrel 120" Full Surface sexbolt pkg		HGPART.1049	102.50
Chinge Pin & Barrel 120" 3/4" TEK screw pkg		HGPART.1050	21.80
Chinge Pin & Barrel Replacment ETW Module	US32D	HGPART.1108	349.70
Chinge Pin & Barrel 83" Full Surface screw cover	US32D	HGPART.1109	90.20
Chinge Pin & Barrel 85" Full Surface screw cover	US32D	HGPART.1110	90.20
Chinge Pin & Barrel 95" Full Surface screw cover	US32D	HGPART.1111	103.70
Chinge Pin & Barrel 120" Full Surface screw cover	US32D	HGPART.1112	120.20
Chinge Pin & Barrel 120" hollow metal security screw pkg (Torx screws)		HGPART.1113	183.80
Chinge Pin & Barrel 120" hollow metal machine screw pkg		HGPART.1114	43.70
Chinge Pin & Barrel 120" wood door security screw pkg (wood Torx screws)		HGPART.1124	183.90
700CSTWP Panel Service Kit	US32D	HGPART.1153	949.00
<b>PIVOTS 7212/15/22/26/27 &amp; 7215F/26F/27F Top Pivot</b>			
7212/15/22/26/27 Top Bearing Leaf	US3	PVPART.1001	147.60
7212/15/22/26/27 Top Bearing Leaf	US4	PVPART.1002	147.60
7212/15/22/26/27 Top Bearing Leaf	US10	PVPART.1003	147.60
7212/15/22/26/27 Top Bearing Leaf	US10B	PVPART.1004	147.60
7212/15/22/26/27 Top Bearing Leaf	US26	PVPART.1005	147.60
7212/15/22/26/27 Top Bearing Leaf	US26D	PVPART.1006	126.50
7212/15/22/26/27 Top Bearing Leaf	SP4	PVPART.1007	90.90
7212/15/22/26/27 Top Bearing Leaf	SPI0	PVPART.1008	90.90
7212/15/22/26/27 Top Bearing Leaf	SP28	PVPART.1009	90.90
7212/15/22/26/27 Top Bearing Leaf	SP313	PVPART.1010	90.90
7212/15/22/26/27 Top Bearing Leaf	SPBLK	PVPART.1011	90.90
7212/15/22/26/27 Top Pin Leaf	US3	PVPART.1012	147.60
7212/15/22/26/27 Top Pin Leaf	US4	PVPART.1013	147.60
7212/15/22/26/27 Top Pin Leaf	US10	PVPART.1014	147.60
7212/15/22/26/27 Top Pin Leaf	US10B	PVPART.1015	147.60
7212/15/22/26/27 Top Pin Leaf	US26	PVPART.1016	147.60
7212/15/22/26/27 Top Pin Leaf	US26D	PVPART.1017	126.50

Contact Ives Customer Service for pricing on additional sizes and finishes

Bold pricing indicates item is in stock and available for **Fast Track** and **ProXpress**



**IVES ARCHITECTURAL HARDWARE - Parts Price List**

Description	Finish	Part No.	List Price Each
<b>PIVOTS 7212/15/22/26/27 &amp; 7215F/26F/27F Top Pivot (Continued)</b>			
7212/15/22/26/27 Top Pin Leaf	SP4	PVPART.1018	\$90.90
7212/15/22/26/27 Top Pin Leaf	SP10	PVPART.1019	90.90
7212/15/22/26/27 Top Pin Leaf	SP28	PVPART.1020	90.90
7212/15/22/26/27 Top Pin Leaf	SP313	PVPART.1021	90.90
7212/15/22/26/27 Top Pin Leaf	SPBLK	PVPART.1022	90.90
7215F/26F/27F Top Bearing Leaf	US3	PVPART.1227	261.50
7215F/26F/27F Top Bearing Leaf	US10	PVPART.1228	261.50
7215F/26F/27F Top Bearing Leaf	US32	PVPART.1229	261.50
7215F/26F/27F Top Bearing Leaf	US32D	PVPART.1230	226.00
7215F/26F/27F Top Bearing Leaf	SP4	PVPART.1231	190.20
7215F/26F/27F Top Bearing Leaf	SP10	PVPART.1232	190.20
7215F/26F/27F Top Bearing Leaf	SP28	PVPART.1233	190.20
7215F/26F/27F Top Bearing Leaf	SP313	PVPART.1234	190.20
7215F/26F/27F Top Bearing Leaf	SPBLK	PVPART.1235	190.20
7215F/26F/27F Top Pin Leaf	US3	PVPART.1236	261.50
7215F/26F/27F Top Pin Leaf	US10	PVPART.1237	261.50
7215F/26F/27F Top Pin Leaf	US32	PVPART.1238	261.50
7215F/26F/27F Top Pin Leaf	US32D	PVPART.1239	226.00
7215F/26F/27F Top Pin Leaf	SP4	PVPART.1240	190.20
7215F/26F/27F Top Pin Leaf	SP10	PVPART.1241	190.20
7215F/26F/27F Top Pin Leaf	SP28	PVPART.1242	190.20
7215F/26F/27F Top Pin Leaf	SP313	PVPART.1243	190.20
7215F/26F/27F Top Pin Leaf	SPBLK	PVPART.1244	190.20
7212/12V/15/22/26/27/44/45 Top Mounting Pkg	US3, US4, SP4	PVPART.1023	15.70
7212/12V/15/22/26/27/44/45 Top Mounting Pkg	US10, SP10	PVPART.1024	15.70
7212/12V/15/22/26/27/44/45 Top Mounting Pkg	US10B, SP313	PVPART.1025	15.70
7212/12V/15/22/26/27/44/45 Top Mounting Pkg	US26, US26D, SP28, US32, US32D	PVPART.1026	15.70
7212/12V/15/22/26/27/44/45 Top Mounting Pkg	SPBLK	PVPART.1027	15.70
7212/12V/15/22/26/27/44/45 Top Security Mtg Pkg	-	PVPART.1028	28.30
7212/12V/15/22/26/27/44/45 Top Wood Mtg Pkg	US3, US4, SP4	PVPART.1821	14.30
7212/12V/15/22/26/27/44/45 Top Wood Mtg Pkg	US10, SP10	PVPART.1822	14.30
7212/12V/15/22/26/27/44/45 Top Wood Mtg Pkg	US10B, SP313	PVPART.1823	14.30
7212/12V/15/22/26/27/44/45 Top Wood Mtg Pkg	US26, US26D, SP28, US32, US32D	PVPART.1824	14.30
7212/12V/15/22/26/27/44/45 Top Wood Mtg Pkg	SPBLK	PVPART.1825	14.30
7212/15/22/26/27/30/37/44/45 Top Pivot Pin	-	PVPART.1029	7.20
Pivot Set Screw (Pkg of 10)	-	PVPART.1030	5.80
Pivot Bushing	-	PVPART.1870	3.50
7212/15/22/26/27/30/37/44/45 Cap Screw	US3	PVPART.1032	22.70
7212/15/22/26/27/30/37/44/45 Cap Screw	US4	PVPART.1033	22.70
7212/15/22/26/27/30/37/44/45 Cap Screw	US10	PVPART.1034	22.70
7212/15/22/26/27/30/37/44/45 Cap Screw	US10B	PVPART.1035	22.70
7212/15/22/26/27/30/37/44/45 Cap Screw	US26, US32	PVPART.1036	22.70
7212/15/22/26/27/30/37/44/45 Cap Screw	US26D, US32D	PVPART.1037	22.70
7212/15/22/26/27/30/37/44/45 Cap Screw	SP4	PVPART.1038	22.70
7212/15/22/26/27/30/37/44/45 Cap Screw	SP10	PVPART.1039	22.70
7212/15/22/26/27/30/37/44/45 Cap Screw	SP28	PVPART.1040	22.70
7212/15/22/26/27/30/37/44/45 Cap Screw	SP313	PVPART.1041	22.70
7212/15/22/26/27/30/37/44/45 Cap Screw	SPBLK	PVPART.1042	22.70
<b>7212V Top Pivot</b>			
7212V Top Door Leaf - RH	US3	PVPART.1144	153.60
7212V Top Door Leaf - RH	US4	PVPART.1145	153.60
7212V Top Door Leaf - RH	US10	PVPART.1146	153.60
7212V Top Door Leaf - RH	US10B	PVPART.1147	153.60

Contact Ives Customer Service for pricing on additional sizes and finishes

Bold pricing indicates item is in stock and available for **Fast Track** and **ProXpress**

**IVES ARCHITECTURAL HARDWARE - Parts Price List**

Description	Finish	Part No.	List Price Each
<b>7212V Top Pivot (Continued)</b>			
7212V Top Door Leaf - RH	US26	PVPART.1148	\$153.60
7212V Top Door Leaf - RH	US26D	PVPART.1149	131.90
7212V Top Door Leaf - RH	SP4	PVPART.1150	100.70
7212V Top Door Leaf - RH	SP10	PVPART.1151	100.70
7212V Top Door Leaf - RH	SP28	PVPART.1152	100.70
7212V Top Door Leaf - RH	SP313	PVPART.1153	100.70
7212V Top Door Leaf - RH	SPBLK	PVPART.1154	100.70
7212V Top Jamb Leaf - RH	US3	PVPART.1155	153.60
7212V Top Jamb Leaf - RH	US4	PVPART.1156	153.60
7212V Top Jamb Leaf - RH	US10	PVPART.1157	153.60
7212V Top Jamb Leaf - RH	US10B	PVPART.1158	153.60
7212V Top Jamb Leaf - RH	US26	PVPART.1159	153.60
7212V Top Jamb Leaf - RH	US26D	PVPART.1160	131.90
7212V Top Jamb Leaf - RH	SP4	PVPART.1161	100.70
7212V Top Jamb Leaf - RH	SP10	PVPART.1162	100.70
7212V Top Jamb Leaf - RH	SP28	PVPART.1163	100.70
7212V Top Jamb Leaf - RH	SP313	PVPART.1164	100.70
7212V Top Jamb Leaf - RH	SPBLK	PVPART.1165	100.70
7212V Top Door Leaf - LH	US3	PVPART.1166	153.60
7212V Top Door Leaf - LH	US4	PVPART.1167	153.60
7212V Top Door Leaf - LH	US10	PVPART.1168	153.60
7212V Top Door Leaf - LH	US10B	PVPART.1169	153.60
7212V Top Door Leaf - LH	US26	PVPART.1170	153.60
7212V Top Door Leaf - LH	US26D	PVPART.1171	131.90
7212V Top Door Leaf - LH	SP4	PVPART.1172	100.70
7212V Top Door Leaf - LH	SP10	PVPART.1173	100.70
7212V Top Door Leaf - LH	SP28	PVPART.1174	100.70
7212V Top Door Leaf - LH	SP313	PVPART.1175	100.70
7212V Top Door Leaf - LH	SPBLK	PVPART.1176	100.70
7212V Top Jamb Leaf - LH	US3	PVPART.1177	153.60
7212V Top Jamb Leaf - LH	US4	PVPART.1178	153.60
7212V Top Jamb Leaf - LH	US10	PVPART.1179	153.60
7212V Top Jamb Leaf - LH	US10B	PVPART.1180	153.60
7212V Top Jamb Leaf - LH	US26	PVPART.1181	153.60
7212V Top Jamb Leaf - LH	US26D	PVPART.1182	131.90
7212V Top Jamb Leaf - LH	SP4	PVPART.1183	100.70
7212V Top Jamb Leaf - LH	SP10	PVPART.1184	100.70
7212V Top Jamb Leaf - LH	SP28	PVPART.1185	100.70
7212V Top Jamb Leaf - LH	SP313	PVPART.1186	100.70
7212V Top Jamb Leaf - LH	SPBLK	PVPART.1187	100.70
7212/12V/15/26/27/44/45 Top Mtg Pkg	US3, US4, SP4	PVPART.1023	15.70
7212/12V/15/26/27/44/45 Top Mtg Pkg	US10, SP10	PVPART.1024	15.70
7212/12V/15/26/27/44/45 Top Mtg Pkg	US10B, SP313	PVPART.1025	15.70
7212/12V/15/26/27/44/45 Top Mtg Pkg	US26, US26D, SP28	PVPART.1026	15.70
7212/12V/15/26/27/44/45 Top Mtg Pkg	SPBLK	PVPART.1027	15.70
7212/12V/15/26/27/44/45 Top Wood Mtg Pkg	US3, US4, SP4	PVPART.1821	14.30
7212/12V/15/26/27/44/45 Top Wood Mtg Pkg	US10, SP10	PVPART.1822	14.30
7212/12V/15/26/27/44/45 Top Wood Mtg Pkg	US10B, SP313	PVPART.1823	14.30
7212/12V/15/26/27/44/45 Top Wood Mtg Pkg	US26, US26D, SP28	PVPART.1824	14.30
7212/12V/15/26/27/44/45 Top Wood Mtg Pkg	SPBLK	PVPART.1825	14.30
7212/12V/15/26/27/44/45 Top Security Mtg Pkg	-	PVPART.1028	28.30
Pivot Set Screw (Pkg of 10)	-	PVPART.1030	5.80
7212/12V/22 Pivot Bearing	-	PVPART.1031	5.80

Contact Ives Customer Service for pricing on additional sizes and finishes

Bold pricing indicates item is in stock and available for **Fast Track** and **ProXpress**

**IVES ARCHITECTURAL HARDWARE - Parts Price List**

Description	Finish	Part No.	List Price Each
<b>7212V Top Pivot (Continued)</b>			
7212/12V/22 Pivot Bearing Pin	-	PVPART.1093	\$5.80
7212V Pivot Pin Cap	US3	PVPART.1194	15.70
7212V Pivot Pin Cap	US4	PVPART.1195	15.70
7212V Pivot Pin Cap	US10	PVPART.1196	15.70
7212V Pivot Pin Cap	US10B	PVPART.1197	15.70
7212V Pivot Pin Cap	US26	PVPART.1198	15.70
7212V Pivot Pin Cap	US26D	PVPART.1199	15.70
7212V Pivot Pin Cap	SP4	PVPART.1200	15.70
7212V Pivot Pin Cap	SP10	PVPART.1201	15.70
7212V Pivot Pin Cap	SP28	PVPART.1202	15.70
7212V Pivot Pin Cap	SP313	PVPART.1203	15.70
7212V Pivot Pin Cap	SPBLK	PVPART.1204	15.70
<b>7230F/37F Top Pivot</b>			
7230F/37F Top Bearing Leaf	US3	PVPART.1517	242.80
7230F/37F Top Bearing Leaf	US10	PVPART.1518	242.80
7230F/37F Top Bearing Leaf	US32	PVPART.1519	242.80
7230F/37F Top Bearing Leaf	US32D	PVPART.1520	226.00
7230F/37F Top Bearing Leaf	SP4	PVPART.1521	200.20
7230F/37F Top Bearing Leaf	SP10	PVPART.1522	200.20
7230F/37F Top Bearing Leaf	SP28	PVPART.1523	200.20
7230F/37F Top Bearing Leaf	SP313	PVPART.1524	200.20
7230F/37F Top Bearing Leaf	SPBLK	PVPART.1525	200.20
7230F/37F Top Pin Leaf	US3	PVPART.1526	242.80
7230F/37F Top Pin Leaf	US10	PVPART.1527	242.80
7230F/37F Top Pin Leaf	US32	PVPART.1528	242.80
7230F/37F Top Pin Leaf	US32D	PVPART.1529	226.00
7230F/37F Top Pin Leaf	SP4	PVPART.1530	200.20
7230F/37F Top Pin Leaf	SP10	PVPART.1531	200.20
7230F/37F Top Pin Leaf	SP28	PVPART.1532	200.20
7230F/37F Top Pin Leaf	SP313	PVPART.1533	200.20
7230F/37F Top Pin Leaf	SPBLK	PVPART.1534	200.20
7230F/37F Top Mounting Pkg	US3, SP4	PVPART.1535	22.70
7230F/37F Top Mounting Pkg	US10, SP10	PVPART.1536	22.70
7230F/37F Top Mounting Pkg	US32, US32D, SP28	PVPART.1537	22.70
7230F/37F Top Mounting Pkg	SP313	PVPART.1542	22.70
7230F/37F Top Mounting Pkg	SPBLK	PVPART.1543	22.70
7230F/37F Top Security Mounting Pkg	-	PVPART.1544	41.30
7230F/37F Top Wood Mtg Pkg	US3, SP4	PVPART.1841	17.80
7230F/37F Top Wood Mtg Pkg	US10, SP10	PVPART.1842	17.80
7230F/37F Top Wood Mtg Pkg	US32, US32D, SP28	PVPART.1843	17.80
7230F/37F Top Wood Mtg Pkg	SP313	PVPART.1844	17.80
7230F/37F Top Wood Mtg Pkg	SPBLK	PVPART.1845	17.80
7212/15/22/26/27/30/37/44/45 Top Pivot Pin	-	PVPART.1029	7.20
Pivot Set Screw (Pkg of 10)	-	PVPART.1030	5.80
Pivot Bushing	-	PVPART.1870	3.50
7212/15/22/26/27/30/37/44/45 Cap Screw	US3	PVPART.1032	22.70
7212/15/22/26/27/30/37/44/45 Cap Screw	US10	PVPART.1034	22.70
7212/15/22/26/27/30/37/44/45 Cap Screw	US32	PVPART.1036	22.70
7212/15/22/26/27/30/37/44/45 Cap Screw	US32D	PVPART.1037	22.70
7212/15/22/26/27/30/37/44/45 Cap Screw	SP4	PVPART.1038	22.70
7212/15/22/26/27/30/37/44/45 Cap Screw	SP10	PVPART.1039	22.70
7212/15/22/26/27/30/37/44/45 Cap Screw	SP28	PVPART.1040	22.70

Contact Ives Customer Service for pricing on additional sizes and finishes

Bold pricing indicates item is in stock and available for **Fast Track** and **ProXpress**

**IVES ARCHITECTURAL HARDWARE - Parts Price List**

Description	Finish	Part No.	List Price Each
<b>7230F/37F Top Pivot (Continued)</b>			
7212/15/22/26/27/30/37/44/45 Cap Screw	SP313	PVPART.1041	\$22.70
7212/15/22/26/27/30/37/44/45 Cap Screw	SPBLK	PVPART.1042	22.70
<b>7244F/45F Top Pivot</b>			
7244F/45F Top Bearing Leaf	US3	PVPART.1615	263.90
7244F/45F Top Bearing Leaf	US10	PVPART.1616	263.90
7244F/45F Top Bearing Leaf	US32	PVPART.1617	263.90
7244F/45F Top Bearing Leaf	US32D	PVPART.1618	253.00
7244F/45F Top Bearing Leaf	SP4	PVPART.1619	230.00
7244F/45F Top Bearing Leaf	SP10	PVPART.1620	230.00
7244F/45F Top Bearing Leaf	SP28	PVPART.1621	230.00
7244F/45F Top Bearing Leaf	SP313	PVPART.1622	230.00
7244F/45F Top Bearing Leaf	SPBLK	PVPART.1623	230.00
7244F/45F Top Pin Leaf	US3	PVPART.1624	263.90
7244F/45F Top Pin Leaf	US10	PVPART.1625	263.90
7244F/45F Top Pin Leaf	US32	PVPART.1626	263.90
7244F/45F Top Pin Leaf	US32D	PVPART.1627	253.00
7244F/45F Top Pin Leaf	SP4	PVPART.1628	230.00
7244F/45F Top Pin Leaf	SP10	PVPART.1629	230.00
7244F/45F Top Pin Leaf	SP28	PVPART.1630	230.00
7244F/45F Top Pin Leaf	SP313	PVPART.1631	230.00
7244F/45F Top Pin Leaf	SPBLK	PVPART.1632	230.00
7212/12V/15/26/27/44/45 Top Mounting Pkg	US3, SP4	PVPART.1023	15.70
7212/12V/15/26/27/44/45 Top Mounting Pkg	US10, SP10	PVPART.1024	15.70
7212/12V/15/26/27/44/45 Top Mounting Pkg	US32, US32D, SP28	PVPART.1026	15.70
7212/12V/15/26/27/44/45 Top Mounting Pkg	SP313	PVPART.1025	15.70
7212/12V/15/26/27/44/45 Top Mounting Pkg	SPBLK	PVPART.1027	15.70
7212/12V/15/26/27/44/45 Top Security Mtg Pkg	-	PVPART.1028	28.30
7212/12V/15/26/27/44/45 Top Wood Mtg Pkg	US3, SP4	PVPART.1821	14.30
7212/12V/15/26/27/44/45 Top Wood Mtg Pkg	US10, SP10	PVPART.1822	14.30
7212/12V/15/26/27/44/45 Top Wood Mtg Pkg	US32, US32D, SP28	PVPART.1824	14.30
7212/12V/15/26/27/44/45 Top Wood Mtg Pkg	SP313	PVPART.1823	14.30
7212/12V/15/26/27/44/45 Top Wood Mtg Pkg	SPBLK	PVPART.1825	14.30
7212/15/22/26/27/30/37/44/45 Top Pivot Pin	-	PVPART.1029	7.20
Pivot Set Screw (Pkg of 10)	-	PVPART.1030	5.80
Pivot Bushing	-	PVPART.1870	3.50
7212/15/22/26/27/30/37/44/45 Cover Cap Screw	US3	PVPART.1032	22.70
7212/15/22/26/27/30/37/44/45 Cover Cap Screw	US10	PVPART.1034	22.70
7212/15/22/26/27/30/37/44/45 Cover Cap Screw	US32	PVPART.1036	22.70
7212/15/22/26/27/30/37/44/45 Cover Cap Screw	US32D	PVPART.1037	22.70
7212/15/22/26/27/30/37/44/45 Cover Cap Screw	SP4	PVPART.1038	22.70
7212/15/22/26/27/30/37/44/45 Cover Cap Screw	SP10	PVPART.1039	22.70
7212/15/22/26/27/30/37/44/45 Cover Cap Screw	SP28	PVPART.1040	22.70
7212/15/22/26/27/30/37/44/45 Cover Cap Screw	SP313	PVPART.1041	22.70
7212/15/22/26/27/30/37/44/45 Cover Cap Screw	SPBLK	PVPART.1042	22.70
<b>7253/55/55J/56 Top Pivot</b>			
7253/55/55J/56 Top Door Leaf	-	PVPART.1705	200.20
7253/55/55J/56 Top Frame Leaf	US3	PVPART.1706	200.20
7253/55/55J/56 Top Frame Leaf	US4	PVPART.1707	200.20
7253/55/55J/56 Top Frame Leaf	US10	PVPART.1708	200.20
7253/55/55J/56 Top Frame Leaf	US10B	PVPART.1709	200.20
7253/55/55J/56 Top Frame Leaf	US26	PVPART.1710	200.20
7253/55/55J/56 Top Frame Leaf	US26D	PVPART.1711	200.20
7253/55/55J/56 Top Frame Leaf	SP4	PVPART.1712	173.30

Contact Ives Customer Service for pricing on additional sizes and finishes

Bold pricing indicates item is in stock and available for **Fast Track** and **ProXpress**

**IVES ARCHITECTURAL HARDWARE - Parts Price List**

Description	Finish	Part No.	List Price Each
<b>7253/55/55J/56 Top Pivot(Continued)</b>			
7253/55/55J/56 Top Frame Leaf	SP10	PVPART.1713	\$173.30
7253/55/55J/56 Top Frame Leaf	SP28	PVPART.1714	173.30
7253/55/55J/56 Top Frame Leaf	SP313	PVPART.1715	173.30
7253/55/55J/56 Top Frame Leaf	SPBLK	PVPART.1716	173.30
7253/55/55J/56 Top Finish Plate Pkg	US3	PVPART.1717	83.60
7253/55/55J/56 Top Finish Plate Pkg	US4	PVPART.1718	83.60
7253/55/55J/56 Top Finish Plate Pkg	US10	PVPART.1719	83.60
7253/55/55J/56 Top Finish Plate Pkg	US10B	PVPART.1720	83.60
7253/55/55J/56 Top Finish Plate Pkg	US26	PVPART.1721	83.60
7253/55/55J/56 Top Finish Plate Pkg	US26D	PVPART.1722	83.60
7253/55/55J/56 Top Finish Plate Pkg	SP4	PVPART.1723	52.50
7253/55/55J/56 Top Finish Plate Pkg	SP10	PVPART.1724	52.50
7253/55/55J/56 Top Finish Plate Pkg	SP28	PVPART.1725	52.50
7253/55/55J/56 Top Finish Plate Pkg	SP313	PVPART.1726	52.50
7253/55/55J/56 Top Finish Plate Pkg	SPBLK	PVPART.1727	52.50
7227/37/45/56/59 Finish Plate Screw (Pkg of 10)	-	PVPART.1335	2.10
7253/55/55J/56/59 Top Mounting Pkg	US3, US4, SP4	PVPART.1729	15.70
7253/55/55J/56/59 Top Mounting Pkg	US10, SP10	PVPART.1730	15.70
7253/55/55J/56/59 Top Mounting Pkg	US10B, SP313	PVPART.1731	15.70
7253/55/55J/56/59 Top Mounting Pkg	US26, US26D, SP28	PVPART.1732	15.70
7253/55/55J/56/59 Top Mounting Pkg	SPBLK	PVPART.1733	15.70
7253/55/55J/56/59 Top Security Mtg Pkg	-	PVPART.1734	21.30
7253/55/55J/56/59 Top Wood Mtg Pkg	US3, US4, SP4	PVPART.1859	10.00
7253/55/55J/56/59 Top Wood Mtg Pkg	US10, SP10	PVPART.1860	10.00
7253/55/55J/56/59 Top Wood Mtg Pkg	US10B, SP313	PVPART.1861	10.00
7253/55/55J/56/59 Top Wood Mtg Pkg	US26, US26D, SP28	PVPART.1862	10.00
7253/55/55J/56/59 Top Wood Mtg Pkg	SPBLK	PVPART.1863	10.00
<b>7259 Top Pivot</b>			
7259 Top Door Leaf	-	PVPART.1788	200.20
7259 Top Frame Leaf	US3	PVPART.1789	200.20
7259 Top Frame Leaf	US4	PVPART.1790	200.20
7259 Top Frame Leaf	US10	PVPART.1791	200.20
7259 Top Frame Leaf	US10B	PVPART.1792	200.20
7259 Top Frame Leaf	US26	PVPART.1793	200.20
7259 Top Frame Leaf	US26D	PVPART.1794	200.20
7259 Top Frame Leaf	SP4	PVPART.1795	173.30
7259 Top Frame Leaf	SP10	PVPART.1796	173.30
7259 Top Frame Leaf	SP28	PVPART.1797	173.30
7259 Top Frame Leaf	SP313	PVPART.1798	173.30
7259 Top Frame Leaf	SPBLK	PVPART.1799	173.30
7259 Top Finish Plate Pkg	US3	PVPART.1800	83.60
7259 Top Finish Plate Pkg	US4	PVPART.1801	83.60
7259 Top Finish Plate Pkg	US10	PVPART.1802	83.60
7259 Top Finish Plate Pkg	US10B	PVPART.1803	83.60
7259 Top Finish Plate Pkg	US26	PVPART.1804	83.60
7259 Top Finish Plate Pkg	US26D	PVPART.1805	83.60
7259 Top Finish Plate Pkg	SP4	PVPART.1806	52.50
7259 Top Finish Plate Pkg	SP10	PVPART.1807	52.50
7259 Top Finish Plate Pkg	SP28	PVPART.1808	52.50
7259 Top Finish Plate Pkg	SP313	PVPART.1809	52.50
7259 Top Finish Plate Pkg	SPBLK	PVPART.1810	52.50
7227/37/45/56/59 Finish Plate Screw (Pkg of 10)	-	PVPART.1335	2.10
7253/55/55J/56/59 Top Mounting Pkg	US3, US4, SP4	PVPART.1729	15.70

Contact Ives Customer Service for pricing on additional sizes and finishes

Bold pricing indicates item is in stock and available for **Fast Track** and **ProXpress**

**IVES ARCHITECTURAL HARDWARE - Parts Price List**

Description	Finish	Part No.	List Price Each
<b>7259 Top Pivot (Continued)</b>			
7253/55/55J/56/59 Top Mounting Pkg	US10, SP10	PVPART.1730	\$15.70
7253/55/55J/56/59 Top Mounting Pkg	US10B, SP313	PVPART.1731	15.70
7253/55/55J/56/59 Top Mounting Pkg	US26, US26D, SP28	PVPART.1732	15.70
7253/55/55J/56/59 Top Mounting Pkg	SPBLK	PVPART.1733	15.70
7253/55/55J/56/59 Top Security Mtg Pkg	-	PVPART.1734	21.30
7253/55/55J/56/59 Top Wood Mtg Pkg	US3, US4, SP4	PVPART.1859	10.00
7253/55/55J/56/59 Top Wood Mtg Pkg	US10, SP10	PVPART.1860	10.00
7253/55/55J/56/59 Top Wood Mtg Pkg	US10B, SP313	PVPART.1861	10.00
7253/55/55J/56/59 Top Wood Mtg Pkg	US26, US26D, SP28	PVPART.1862	10.00
7253/55/55J/56/59 Top Wood Mtg Pkg	SPBLK	PVPART.1863	10.00
<b>7212/12V/22 Intermediate Pivot</b>			
7212/12V/22 Int Door Leaf - RH	US3	PVPART.1094	169.10
7212/12V/22 Int Door Leaf - RH	US4	PVPART.1095	169.10
7212/12V/22 Int Door Leaf - RH	US10	PVPART.1096	169.10
7212/12V/22 Int Door Leaf - RH	US10B	PVPART.1097	169.10
7212/12V/22 Int Door Leaf - RH	US26	PVPART.1098	169.10
7212/12V/22 Int Door Leaf - RH	US26D	PVPART.1099	147.60
7212/12V/22 Int Door Leaf - RH	SP4	PVPART.1100	117.90
7212/12V/22 Int Door Leaf - RH	SP10	PVPART.1101	117.90
7212/12V/22 Int Door Leaf - RH	SP28	PVPART.1102	117.90
7212/12V/22 Int Door Leaf - RH	SP313	PVPART.1103	117.90
7212/12V/22 Int Door Leaf - RH	SPBLK	PVPART.1104	117.90
7212/12V/22 Int Jamb Leaf - RH	US3	PVPART.1105	169.10
7212/12V/22 Int Jamb Leaf - RH	US4	PVPART.1106	169.10
7212/12V/22 Int Jamb Leaf - RH	US10	PVPART.1107	169.10
7212/12V/22 Int Jamb Leaf - RH	US10B	PVPART.1108	169.10
7212/12V/22 Int Jamb Leaf - RH	US26	PVPART.1109	169.10
7212/12V/22 Int Jamb Leaf - RH	US26D	PVPART.1110	147.60
7212/12V/22 Int Jamb Leaf - RH	SP4	PVPART.1111	117.90
7212/12V/22 Int Jamb Leaf - RH	SP10	PVPART.1112	117.90
7212/12V/22 Int Jamb Leaf - RH	SP28	PVPART.1113	117.90
7212/12V/22 Int Jamb Leaf - RH	SP313	PVPART.1114	117.90
7212/12V/22 Int Jamb Leaf - RH	SPBLK	PVPART.1115	117.90
7212/12V/22 Int Door Leaf - LH	US3	PVPART.1116	169.10
7212/12V/22 Int Door Leaf - LH	US4	PVPART.1117	169.10
7212/12V/22 Int Door Leaf - LH	US10	PVPART.1118	169.10
7212/12V/22 Int Door Leaf - LH	US10B	PVPART.1119	169.10
7212/12V/22 Int Door Leaf - LH	US26	PVPART.1120	169.10
7212/12V/22 Int Door Leaf - LH	US26D	PVPART.1121	147.60
7212/12V/22 Int Door Leaf - LH	SP4	PVPART.1122	117.90
7212/12V/22 Int Door Leaf - LH	SP10	PVPART.1123	117.90
7212/12V/22 Int Door Leaf - LH	SP28	PVPART.1124	117.90
7212/12V/22 Int Door Leaf - LH	SP313	PVPART.1125	117.90
7212/12V/22 Int Door Leaf - LH	SPBLK	PVPART.1126	117.90
7212/12V/22 Int Jamb Leaf - LH	US3	PVPART.1127	169.10
7212/12V/22 Int Jamb Leaf - LH	US4	PVPART.1128	169.10
7212/12V/22 Int Jamb Leaf - LH	US10	PVPART.1129	169.10
7212/12V/22 Int Jamb Leaf - LH	US10B	PVPART.1130	169.10
7212/12V/22 Int Jamb Leaf - LH	US26	PVPART.1131	169.10
7212/12V/22 Int Jamb Leaf - LH	US26D	PVPART.1132	147.60
7212/12V/22 Int Jamb Leaf - LH	SP4	PVPART.1133	117.90
7212/12V/22 Int Jamb Leaf - LH	SP10	PVPART.1134	117.90
7212/12V/22 Int Jamb Leaf - LH	SP28	PVPART.1135	117.90

Contact Ives Customer Service for pricing on additional sizes and finishes

Bold pricing indicates item is in stock and available for **Fast Track** and **ProXpress**



**IVES ARCHITECTURAL HARDWARE - Parts Price List**

Description	Finish	Part No.	List Price Each
<b>7212/12V/22 Intermediate Pivot (Continued)</b>			
7212/12V/22 Int Jamb Leaf - LH	SP313	PVPART.1136	\$117.90
7212/12V/22 Int Jamb Leaf - LH	SPBLK	PVPART.1137	117.90
7212/12V/22 Int Mounting Pkg	US3, US4, SP4	PVPART.1138	14.30
7212/12V/22 Int Mounting Pkg	US10, SP10	PVPART.1139	14.30
7212/12V/22 Int Mounting Pkg	US10B, SP313	PVPART.1140	14.30
7212/12V/22 Int Mounting Pkg	US26, US26D, SP28	PVPART.1141	14.30
7212/12V/22 Int Mounting Pkg	SPBLK	PVPART.1142	14.30
7212/12V/22 Int Wood Mtg Pkg	US3, US4, SP4	PVPART.1831	10.50
7212/12V/22 Int Wood Mtg Pkg	US10, SP10	PVPART.1832	10.50
7212/12V/22 Int Wood Mtg Pkg	US10B, SP313	PVPART.1833	10.50
7212/12V/22 Int Wood Mtg Pkg	US26, US26D, SP28	PVPART.1834	10.50
7212/12V/22 Int Wood Mtg Pkg	SPBLK	PVPART.1835	10.50
7212/12V/22 Int Security Mtg Pkg	-	PVPART.1143	21.30
Pivot Set Screw (Pkg of 10)	-	PVPART.1030	5.80
7212/12V/22 Pivot Bearing	-	PVPART.1031	5.80
7212/12V/22 Pivot Bearing Pin	-	PVPART.1093	5.80
<b>7215/26/27 &amp; 7215F/26F/27F Intermediate Pivot</b>			
7215/26/27 Int Door Leaf - RH	US3	PVPART.1354	153.60
7215/26/27 Int Door Leaf - RH	US4	PVPART.1355	153.60
7215/26/27 Int Door Leaf - RH	US10	PVPART.1356	153.60
7215/26/27 Int Door Leaf - RH	US10B	PVPART.1357	153.60
7215/26/27 Int Door Leaf - RH	US26	PVPART.1358	153.60
7215/26/27 Int Door Leaf - RH	US26D	PVPART.1359	137.60
7215/26/27 Int Door Leaf - RH	SP4	PVPART.1360	126.50
7215/26/27 Int Door Leaf - RH	SP10	PVPART.1361	126.50
7215/26/27 Int Door Leaf - RH	SP28	PVPART.1362	126.50
7215/26/27 Int Door Leaf - RH	SP313	PVPART.1363	126.50
7215/26/27 Int Door Leaf - RH	SPBLK	PVPART.1364	126.50
7215/26/27 Int Jamb Leaf - RH	US3	PVPART.1365	153.60
7215/26/27 Int Jamb Leaf - RH	US4	PVPART.1366	153.60
7215/26/27 Int Jamb Leaf - RH	US10	PVPART.1367	153.60
7215/26/27 Int Jamb Leaf - RH	US10B	PVPART.1368	153.60
7215/26/27 Int Jamb Leaf - RH	US26	PVPART.1369	153.60
7215/26/27 Int Jamb Leaf - RH	US26D	PVPART.1370	137.60
7215/26/27 Int Jamb Leaf - RH	SP4	PVPART.1371	126.50
7215/26/27 Int Jamb Leaf - RH	SP10	PVPART.1372	126.50
7215/26/27 Int Jamb Leaf - RH	SP28	PVPART.1373	126.50
7215/26/27 Int Jamb Leaf - RH	SP313	PVPART.1374	126.50
7215/26/27 Int Jamb Leaf - RH	SPBLK	PVPART.1375	126.50
7215/26/27 Int Door Leaf - LH	US3	PVPART.1376	153.60
7215/26/27 Int Door Leaf - LH	US4	PVPART.1377	153.60
7215/26/27 Int Door Leaf - LH	US10	PVPART.1378	153.60
7215/26/27 Int Door Leaf - LH	US10B	PVPART.1379	153.60
7215/26/27 Int Door Leaf - LH	US26	PVPART.1380	153.60
7215/26/27 Int Door Leaf - LH	US26D	PVPART.1381	137.60
7215/26/27 Int Door Leaf - LH	SP4	PVPART.1382	126.50
7215/26/27 Int Door Leaf - LH	SP10	PVPART.1383	126.50
7215/26/27 Int Door Leaf - LH	SP28	PVPART.1384	126.50
7215/26/27 Int Door Leaf - LH	SP313	PVPART.1385	126.50
7215/26/27 Int Door Leaf - LH	SPBLK	PVPART.1386	126.50
7215/26/27 Int Jamb Leaf - LH	US3	PVPART.1387	153.60
7215/26/27 Int Jamb Leaf - LH	US4	PVPART.1388	153.60
7215/26/27 Int Jamb Leaf - LH	US10	PVPART.1389	153.60

Contact Ives Customer Service for pricing on additional sizes and finishes

Bold pricing indicates item is in stock and available for **Fast Track** and **ProXpress**



**IVES ARCHITECTURAL HARDWARE - Parts Price List**

Description	Finish	Part No.	List Price Each
<b>7215/26/27 &amp; 7215F/26F/27F Intermediate Pivot (Continued)</b>			
7215/26/27 Int Jamb Leaf - LH	US10B	PVPART.1390	\$153.60
7215/26/27 Int Jamb Leaf - LH	US26	PVPART.1391	153.60
7215/26/27 Int Jamb Leaf - LH	US26D	PVPART.1392	137.60
7215/26/27 Int Jamb Leaf - LH	SP4	PVPART.1393	126.50
7215/26/27 Int Jamb Leaf - LH	SPI0	PVPART.1394	126.50
7215/26/27 Int Jamb Leaf - LH	SP28	PVPART.1395	126.50
7215/26/27 Int Jamb Leaf - LH	SP313	PVPART.1396	126.50
7215/26/27 Int Jamb Leaf - LH	SPBLK	PVPART.1397	126.50
7215F/26F/27F Int Door Leaf - RH	US3	PVPART.1398	242.80
7215F/26F/27F Int Door Leaf - RH	US10	PVPART.1399	242.80
7215F/26F/27F Int Door Leaf - RH	US32	PVPART.1400	242.80
7215F/26F/27F Int Door Leaf - RH	US32D	PVPART.1401	231.40
7215F/26F/27F Int Door Leaf - RH	SP4	PVPART.1402	195.70
7215F/26F/27F Int Door Leaf - RH	SPI0	PVPART.1403	195.70
7215F/26F/27F Int Door Leaf - RH	SP28	PVPART.1404	195.70
7215F/26F/27F Int Door Leaf - RH	SP313	PVPART.1405	195.70
7215F/26F/27F Int Door Leaf - RH	SPBLK	PVPART.1406	195.70
7215F/26F/27F Int Jamb Leaf - RH	US3	PVPART.1407	242.80
7215F/26F/27F Int Jamb Leaf - RH	US10	PVPART.1408	242.80
7215F/26F/27F Int Jamb Leaf - RH	US32	PVPART.1409	242.80
7215F/26F/27F Int Jamb Leaf - RH	US32D	PVPART.1410	231.40
7215F/26F/27F Int Jamb Leaf - RH	SP4	PVPART.1411	195.70
7215F/26F/27F Int Jamb Leaf - RH	SPI0	PVPART.1412	195.70
7215F/26F/27F Int Jamb Leaf - RH	SP28	PVPART.1413	195.70
7215F/26F/27F Int Jamb Leaf - RH	SP313	PVPART.1414	195.70
7215F/26F/27F Int Jamb Leaf - RH	SPBLK	PVPART.1415	195.70
7215F/26F/27F Int Door Leaf - LH	US3	PVPART.1416	242.80
7215F/26F/27F Int Door Leaf - LH	US10	PVPART.1417	242.80
7215F/26F/27F Int Door Leaf - LH	US32	PVPART.1418	242.80
7215F/26F/27F Int Door Leaf - LH	US32D	PVPART.1419	231.40
7215F/26F/27F Int Door Leaf - LH	SP4	PVPART.1420	195.70
7215F/26F/27F Int Door Leaf - LH	SPI0	PVPART.1421	195.70
7215F/26F/27F Int Door Leaf - LH	SP28	PVPART.1422	195.70
7215F/26F/27F Int Door Leaf - LH	SP313	PVPART.1423	195.70
7215F/26F/27F Int Door Leaf - LH	SPBLK	PVPART.1424	195.70
7215F/26F/27F Int Jamb Leaf - LH	US3	PVPART.1425	242.80
7215F/26F/27F Int Jamb Leaf - LH	US10	PVPART.1426	242.80
7215F/26F/27F Int Jamb Leaf - LH	US32	PVPART.1427	242.80
7215F/26F/27F Int Jamb Leaf - LH	US32D	PVPART.1428	231.40
7215F/26F/27F Int Jamb Leaf - LH	SP4	PVPART.1429	195.70
7215F/26F/27F Int Jamb Leaf - LH	SPI0	PVPART.1430	195.70
7215F/26F/27F Int Jamb Leaf - LH	SP28	PVPART.1431	195.70
7215F/26F/27F Int Jamb Leaf - LH	SP313	PVPART.1432	195.70
7215F/26F/27F Int Jamb Leaf - LH	SPBLK	PVPART.1433	195.70
7215/26/27/30/37/44/45 Int Mounting Pkg	US3, US4, SP4	PVPART.1434	14.30
7215/26/27/30/37/44/45 Int Mounting Pkg	US10, SPI0	PVPART.1435	14.30
7215/26/27/30/37/44/45 Int Mounting Pkg	US10B, SP313	PVPART.1436	14.30
7215/26/27/30/37/44/45 Int Mounting Pkg	US26, US26D, US32, US32D, SP28	PVPART.1437	14.30
7215/26/27/30/37/44/45 Int Mounting Pkg	SPBLK	PVPART.1438	14.30
7215/26/27/30/37/44/45 Int Security Mtg Pkg	-	PVPART.1439	34.30
7215/26/27/30/37/44/45 Int Wood Mtg Pkg	US3, US4, SP4	PVPART.1836	15.70
7215/26/27/30/37/44/45 Int Wood Mtg Pkg	US10, SPI0	PVPART.1837	15.70

Contact Ives Customer Service for pricing on additional sizes and finishes

Bold pricing indicates item is in stock and available for **Fast Track** and **ProXpress**

**IVES ARCHITECTURAL HARDWARE - Parts Price List**

Description	Finish	Part No.	List Price Each
<b>7215/26/27 &amp; 7215F/26F/27F Intermediate Pivot (Continued)</b>			
7215/26/27/30/37/44/45 Int Wood Mtg Pkg	US10B, SP313	PVPART.1838	\$15.70
7215/26/27/30/37/44/45 Int Wood Mtg Pkg	US26, US26D, US32, US32D, SP28	PVPART.1839	15.70
7215/26/27/30/37/44/45 Int Wood Mtg Pkg	SPBLK	PVPART.1840	15.70
7212/15/22/26/27/30/37/44/45 Cap Screw	US3	PVPART.1032	22.70
7212/15/22/26/27/30/37/44/45 Cap Screw	US4	PVPART.1033	22.70
7212/15/22/26/27/30/37/44/45 Cap Screw	US10	PVPART.1034	22.70
7212/15/22/26/27/30/37/44/45 Cap Screw	US10B	PVPART.1035	22.70
7212/15/22/26/27/30/37/44/45 Cap Screw	US26, US32	PVPART.1036	22.70
7212/15/22/26/27/30/37/44/45 Cap Screw	US26D, US32D	PVPART.1037	22.70
7212/15/22/26/27/30/37/44/45 Cap Screw	SP4	PVPART.1038	22.70
7212/15/22/26/27/30/37/44/45 Cap Screw	SP10	PVPART.1039	22.70
7212/15/22/26/27/30/37/44/45 Cap Screw	SP28	PVPART.1040	22.70
7212/15/22/26/27/30/37/44/45 Cap Screw	SP313	PVPART.1041	22.70
7212/15/22/26/27/30/37/44/45 Cap Screw	SPBLK	PVPART.1042	22.70
7215/26/27 Pivot Ball	-	PVPART.1349	2.10
Pivot Bushing	-	PVPART.1870	3.50
Pivot Retainer Lock	-	PVPART.1353	8.50
Pivot Washer (Pkg of 10)	-	PVPART.1352	7.20
7215/26/27/30/37/44/45 Int Pivot Bearing Pin	-	PVPART.1847	14.30
<b>7230F/37F Intermediate Pivot</b>			
7230F/37F Int Door Leaf - RH	US3	PVPART.1565	263.90
7230F/37F Int Door Leaf - RH	US10	PVPART.1566	263.90
7230F/37F Int Door Leaf - RH	US32	PVPART.1567	263.90
7230F/37F Int Door Leaf - RH	US32D	PVPART.1568	253.00
7230F/37F Int Door Leaf - RH	SP4	PVPART.1569	217.20
7230F/37F Int Door Leaf - RH	SP10	PVPART.1570	217.20
7230F/37F Int Door Leaf - RH	SP28	PVPART.1571	217.20
7230F/37F Int Door Leaf - RH	SP313	PVPART.1572	217.20
7230F/37F Int Door Leaf - RH	SPBLK	PVPART.1573	217.20
7230F/37F Int Jamb Leaf - RH	US3	PVPART.1574	263.90
7230F/37F Int Jamb Leaf - RH	US10	PVPART.1575	263.90
7230F/37F Int Jamb Leaf - RH	US32	PVPART.1576	263.90
7230F/37F Int Jamb Leaf - RH	US32D	PVPART.1577	253.00
7230F/37F Int Jamb Leaf - RH	SP4	PVPART.1578	217.20
7230F/37F Int Jamb Leaf - RH	SP10	PVPART.1579	217.20
7230F/37F Int Jamb Leaf - RH	SP28	PVPART.1580	217.20
7230F/37F Int Jamb Leaf - RH	SP313	PVPART.1581	217.20
7230F/37F Int Jamb Leaf - RH	SPBLK	PVPART.1582	217.20
7230F/37F Int Door Leaf - LH	US3	PVPART.1583	263.90
7230F/37F Int Door Leaf - LH	US10	PVPART.1584	263.90
7230F/37F Int Door Leaf - LH	US32	PVPART.1585	263.90
7230F/37F Int Door Leaf - LH	US32D	PVPART.1586	253.00
7230F/37F Int Door Leaf - LH	SP4	PVPART.1587	217.20
7230F/37F Int Door Leaf - LH	SP10	PVPART.1588	217.20
7230F/37F Int Door Leaf - LH	SP28	PVPART.1589	217.20
7230F/37F Int Door Leaf - LH	SP313	PVPART.1590	217.20
7230F/37F Int Door Leaf - LH	SPBLK	PVPART.1591	217.20
7230F/37F Int Jamb Leaf - LH	US3	PVPART.1592	263.90
7230F/37F Int Jamb Leaf - LH	US10	PVPART.1593	263.90
7230F/37F Int Jamb Leaf - LH	US32	PVPART.1594	263.90
7230F/37F Int Jamb Leaf - LH	US32D	PVPART.1595	253.00
7230F/37F Int Jamb Leaf - LH	SP4	PVPART.1596	217.20
7230F/37F Int Jamb Leaf - LH	SP10	PVPART.1597	217.20

Contact Ives Customer Service for pricing on additional sizes and finishes

Bold pricing indicates item is in stock and available for **Fast Track** and **ProXpress**

**IVES ARCHITECTURAL HARDWARE - Parts Price List**

Description	Finish	Part No.	List Price Each
<b>7230F/37F Intermediate Pivot (Continued)</b>			
7230F/37F Int Jamb Leaf - LH	SP28	PVPART.1598	\$217.20
7230F/37F Int Jamb Leaf - LH	SP313	PVPART.1599	217.20
7230F/37F Int Jamb Leaf - LH	SPBLK	PVPART.1600	217.20
7215/26/27/30/37/44/45 Int Mounting Pkg	US3, SP4	PVPART.1434	14.30
7215/26/27/30/37/44/45 Int Mounting Pkg	US10, SP10	PVPART.1435	14.30
7215/26/27/30/37/44/45 Int Mounting Pkg	SP313	PVPART.1436	14.30
7215/26/27/30/37/44/45 Int Mounting Pkg	US32, US32D, SP28	PVPART.1437	14.30
7215/26/27/30/37/44/45 Int Mounting Pkg	SPBLK	PVPART.1438	14.30
7215/26/27/30/37/44/45 Int Security Mtg Pkg	-	PVPART.1439	34.30
7215/26/27/30/37/44/45 Int Wood Mtg Pkg	US3, US4	PVPART.1836	15.70
7215/26/27/30/37/44/45 Int Wood Mtg Pkg	US10, SP10	PVPART.1837	15.70
7215/26/27/30/37/44/45 Int Wood Mtg Pkg	SP313	PVPART.1838	15.70
7215/26/27/30/37/44/45 Int Wood Mtg Pkg	US32, US32D, SP28	PVPART.1839	15.70
7215/26/27/30/37/44/45 Int Wood Mtg Pkg	SPBLK	PVPART.1840	15.70
7212/15/22/26/27/30/37/44/45 Cap Screw	US3	PVPART.1032	22.70
7212/15/22/26/27/30/37/44/45 Cap Screw	US10	PVPART.1034	22.70
7212/15/22/26/27/30/37/44/45 Cap Screw	US32	PVPART.1036	22.70
7212/15/22/26/27/30/37/44/45 Cap Screw	US32D	PVPART.1037	22.70
7212/15/22/26/27/30/37/44/45 Cap Screw	SP4	PVPART.1038	22.70
7212/15/22/26/27/30/37/44/45 Cap Screw	SP10	PVPART.1039	22.70
7212/15/22/26/27/30/37/44/45 Cap Screw	SP28	PVPART.1040	22.70
7212/15/22/26/27/30/37/44/45 Cap Screw	SP313	PVPART.1041	22.70
7212/15/22/26/27/30/37/44/45 Cap Screw	SPBLK	PVPART.1042	22.70
7230/37/44/45 Intermediate Pivot Ball	-	PVPART.1607	2.10
Pivot Bushing	-	PVPART.1870	3.50
Pivot Retainer Lock	-	PVPART.1353	8.50
Pivot Washer (Pkg of 10)	-	PVPART.1352	7.20
7215/26/27/30/37/44/45 Int Pivot Bearing Pin	-	PVPART.1847	14.30
<b>7244F/45F Intermediate Pivot</b>			
7244F/45F Int Door Leaf - RH	US3	PVPART.1655	286.80
7244F/45F Int Door Leaf - RH	US10	PVPART.1656	286.80
7244F/45F Int Door Leaf - RH	US32	PVPART.1657	286.80
7244F/45F Int Door Leaf - RH	US32D	PVPART.1658	269.70
7244F/45F Int Door Leaf - RH	SP4	PVPART.1659	242.80
7244F/45F Int Door Leaf - RH	SP10	PVPART.1660	242.80
7244F/45F Int Door Leaf - RH	SP28	PVPART.1661	242.80
7244F/45F Int Door Leaf - RH	SP313	PVPART.1662	242.80
7244F/45F Int Door Leaf - RH	SPBLK	PVPART.1663	242.80
7244F/45F Int Jamb Leaf - RH	US3	PVPART.1664	286.80
7244F/45F Int Jamb Leaf - RH	US10	PVPART.1665	286.80
7244F/45F Int Jamb Leaf - RH	US32	PVPART.1666	286.80
7244F/45F Int Jamb Leaf - RH	US32D	PVPART.1667	269.70
7244F/45F Int Jamb Leaf - RH	SP4	PVPART.1668	242.80
7244F/45F Int Jamb Leaf - RH	SP10	PVPART.1669	242.80
7244F/45F Int Jamb Leaf - RH	SP28	PVPART.1670	242.80
7244F/45F Int Jamb Leaf - RH	SP313	PVPART.1671	242.80
7244F/45F Int Jamb Leaf - RH	SPBLK	PVPART.1672	242.80
7244F/45F Int Door Leaf - LH	US3	PVPART.1673	286.80
7244F/45F Int Door Leaf - LH	US10	PVPART.1674	286.80
7244F/45F Int Door Leaf - LH	US32	PVPART.1675	286.80
7244F/45F Int Door Leaf - LH	US32D	PVPART.1676	269.70
7244F/45F Int Door Leaf - LH	SP4	PVPART.1677	242.80

Contact Ives Customer Service for pricing on additional sizes and finishes

Bold pricing indicates item is in stock and available for **Fast Track** and **ProXpress**

**IVES ARCHITECTURAL HARDWARE - Parts Price List**

Description	Finish	Part No.	List Price Each
<b>7244F/45F Intermediate Pivot (Continued)</b>			
7244F/45F Int Door Leaf - LH	SP10	PVPART.1678	\$242.80
7244F/45F Int Door Leaf - LH	SP28	PVPART.1679	242.80
7244F/45F Int Door Leaf - LH	SP313	PVPART.1680	242.80
7244F/45F Int Door Leaf - LH	SPBLK	PVPART.1681	242.80
7244F/45F Int Jamb Leaf - LH	US3	PVPART.1682	286.80
7244F/45F Int Jamb Leaf - LH	US10	PVPART.1683	286.80
7244F/45F Int Jamb Leaf - LH	US32	PVPART.1684	286.80
7244F/45F Int Jamb Leaf - LH	US32D	PVPART.1685	269.70
7244F/45F Int Jamb Leaf - LH	SP4	PVPART.1686	242.80
7244F/45F Int Jamb Leaf - LH	SP10	PVPART.1687	242.80
7244F/45F Int Jamb Leaf - LH	SP28	PVPART.1688	242.80
7244F/45F Int Jamb Leaf - LH	SP313	PVPART.1689	242.80
7244F/45F Int Jamb Leaf - LH	SPBLK	PVPART.1690	242.80
7215/26/27/30/37/44/45 Int Mounting Pkg	US3, SP4	PVPART.1434	14.30
7215/26/27/30/37/44/45 Int Mounting Pkg	US10, SP10	PVPART.1435	14.30
7215/26/27/30/37/44/45 Int Mounting Pkg	SP313	PVPART.1436	14.30
7215/26/27/30/37/44/45 Int Mounting Pkg	US32, US32D, SP28	PVPART.1437	14.30
7215/26/27/30/37/44/45 Int Mounting Pkg	SPBLK	PVPART.1438	14.30
7215/26/27/30/37/44/45 Int Security Mtg Pkg	-	PVPART.1439	34.30
7215/26/27/30/37/44/45 Int Wood Mtg Pkg	US3, SP4	PVPART.1836	15.70
7215/26/27/30/37/44/45 Int Wood Mtg Pkg	US10, SP10	PVPART.1837	15.70
7215/26/27/30/37/44/45 Int Wood Mtg Pkg	SP313	PVPART.1838	15.70
7215/26/27/30/37/44/45 Int Wood Mtg Pkg	US32, US32D, SP28	PVPART.1839	15.70
7215/26/27/30/37/44/45 Int Wood Mtg Pkg	SPBLK	PVPART.1840	15.70
7212/15/22/26/27/30/37/44/45 Cap Screw	US3	PVPART.1032	22.70
7212/15/22/26/27/30/37/44/45 Cap Screw	US10	PVPART.1034	22.70
7212/15/22/26/27/30/37/44/45 Cap Screw	US32	PVPART.1036	22.70
7212/15/22/26/27/30/37/44/45 Cap Screw	US32D	PVPART.1037	22.70
7212/15/22/26/27/30/37/44/45 Cap Screw	SP4	PVPART.1038	22.70
7212/15/22/26/27/30/37/44/45 Cap Screw	SP10	PVPART.1039	22.70
7212/15/22/26/27/30/37/44/45 Cap Screw	SP28	PVPART.1040	22.70
7212/15/22/26/27/30/37/44/45 Cap Screw	SP313	PVPART.1041	22.70
7212/15/22/26/27/30/37/44/45 Cap Screw	SPBLK	PVPART.1042	22.70
7230/37/44/45 Intermediate Pivot Ball	-	PVPART.1607	2.10
Pivot Bushing	-	PVPART.1870	3.50
Pivot Retainer Lock	-	PVPART.1353	8.50
Pivot Washer (Pkg of 10)	-	PVPART.1352	7.20
7215/26/27/30/37/44/45 Int Pivot Bearing Pin	-	PVPART.1847	14.30
<b>7212 Bottom Pivot</b>			
7212/12V/22 Btm Door Leaf - RH	US3	PVPART.1043	153.60
7212/12V/22 Btm Door Leaf - RH	US4	PVPART.1044	153.60
7212/12V/22 Btm Door Leaf - RH	US10	PVPART.1045	153.60
7212/12V/22 Btm Door Leaf - RH	US10B	PVPART.1046	153.60
7212/12V/22 Btm Door Leaf - RH	US26	PVPART.1047	153.60
7212/12V/22 Btm Door Leaf - RH	US26D	PVPART.1048	131.90
7212/12V/22 Btm Door Leaf - RH	SP4	PVPART.1049	100.70
7212/12V/22 Btm Door Leaf - RH	SP10	PVPART.1050	100.70
7212/12V/22 Btm Door Leaf - RH	SP28	PVPART.1051	100.70
7212/12V/22 Btm Door Leaf - RH	SP313	PVPART.1052	100.70
7212/12V/22 Btm Door Leaf - RH	SPBLK	PVPART.1053	100.70
7212/12V Btm Jamb Leaf - RH	US3	PVPART.1054	153.60
7212/12V Btm Jamb Leaf - RH	US4	PVPART.1055	153.60
7212/12V Btm Jamb Leaf - RH	US10	PVPART.1056	153.60

Contact Ives Customer Service for pricing on additional sizes and finishes

Bold pricing indicates item is in stock and available for **Fast Track** and **ProXpress**

**IVES ARCHITECTURAL HARDWARE - Parts Price List**

Description	Finish	Part No.	List Price Each
<b>7212 Bottom Pivot (Continued)</b>			
7212/12V Btm Jamb Leaf - RH	US10B	PVPART.1057	\$153.60
7212/12V Btm Jamb Leaf - RH	US26	PVPART.1058	153.60
7212/12V Btm Jamb Leaf - RH	US26D	PVPART.1059	131.90
7212/12V Btm Jamb Leaf - RH	SP4	PVPART.1060	100.70
7212/12V Btm Jamb Leaf - RH	SP10	PVPART.1061	100.70
7212/12V Btm Jamb Leaf - RH	SP28	PVPART.1062	100.70
7212/12V Btm Jamb Leaf - RH	SP313	PVPART.1063	100.70
7212/12V Btm Jamb Leaf - RH	SPBLK	PVPART.1064	100.70
7212/12V/22 Btm Door Leaf - LH	US3	PVPART.1065	153.60
7212/12V/22 Btm Door Leaf - LH	US4	PVPART.1066	153.60
7212/12V/22 Btm Door Leaf - LH	US10	PVPART.1067	153.60
7212/12V/22 Btm Door Leaf - LH	US10B	PVPART.1068	153.60
7212/12V/22 Btm Door Leaf - LH	US26	PVPART.1069	153.60
7212/12V/22 Btm Door Leaf - LH	US26D	PVPART.1070	131.90
7212/12V/22 Btm Door Leaf - LH	SP4	PVPART.1071	100.70
7212/12V/22 Btm Door Leaf - LH	SP10	PVPART.1072	100.70
7212/12V/22 Btm Door Leaf - LH	SP28	PVPART.1073	100.70
7212/12V/22 Btm Door Leaf - LH	SP313	PVPART.1074	100.70
7212/12V/22 Btm Door Leaf - LH	SPBLK	PVPART.1075	100.70
7212/12V Btm Jamb Leaf - LH	US3	PVPART.1076	153.60
7212/12V Btm Jamb Leaf - LH	US4	PVPART.1077	153.60
7212/12V Btm Jamb Leaf - LH	US10	PVPART.1078	153.60
7212/12V Btm Jamb Leaf - LH	US10B	PVPART.1079	153.60
7212/12V Btm Jamb Leaf - LH	US26	PVPART.1080	153.60
7212/12V Btm Jamb Leaf - LH	US26D	PVPART.1081	131.90
7212/12V Btm Jamb Leaf - LH	SP4	PVPART.1082	100.70
7212/12V Btm Jamb Leaf - LH	SP10	PVPART.1083	100.70
7212/12V Btm Jamb Leaf - LH	SP28	PVPART.1084	100.70
7212/12V Btm Jamb Leaf - LH	SP313	PVPART.1085	100.70
7212/12V Btm Jamb Leaf - LH	SPBLK	PVPART.1086	100.70
7212/12V/15 Btm Mounting Pkg	US3, US4, SP4	PVPART.1087	15.70
7212/12V/15 Btm Mounting Pkg	US10, SP10	PVPART.1088	15.70
7212/12V/15 Btm Mounting Pkg	US10B, SP313	PVPART.1089	15.70
7212/12V/15 Btm Mounting Pkg	US26, US26D, SP28	PVPART.1090	15.70
7212/12V/15 Btm Mounting Pkg	SPBLK	PVPART.1091	15.70
7212/12V/15 Btm Security Mounting Pkg	-	PVPART.1092	28.30
7212/12V/15/22 Btm Wood Mtg Pkg	US3, US4, SP4	PVPART.1826	14.30
7212/12V/15/22 Btm Wood Mtg Pkg	US10, SP10	PVPART.1827	14.30
7212/12V/15/22 Btm Wood Mtg Pkg	US10B, SP313	PVPART.1828	14.30
7212/12V/15/22 Btm Wood Mtg Pkg	US26, US26D, SP28	PVPART.1829	14.30
7212/12V/15/22 Btm Wood Mtg Pkg	SPBLK	PVPART.1830	14.30
Pivot Set Screw (Pkg of 10)	-	PVPART.1030	5.80
7212/12V/22 Pivot Bearing	-	PVPART.1031	5.80
7212/12V/22 Pivot Bearing Pin	-	PVPART.1093	5.80
<b>7212V Bottom Pivot</b>			
7212/12V/22 Btm Door Leaf - RH	US3	PVPART.1043	153.60
7212/12V/22 Btm Door Leaf - RH	US4	PVPART.1044	153.60
7212/12V/22 Btm Door Leaf - RH	US10	PVPART.1045	153.60
7212/12V/22 Btm Door Leaf - RH	US10B	PVPART.1046	153.60
7212/12V/22 Btm Door Leaf - RH	US26	PVPART.1047	153.60
7212/12V/22 Btm Door Leaf - RH	US26D	PVPART.1048	131.90
7212/12V/22 Btm Door Leaf - RH	SP4	PVPART.1049	100.70
7212/12V/22 Btm Door Leaf - RH	SP10	PVPART.1050	100.70

Contact Ives Customer Service for pricing on additional sizes and finishes

Bold pricing indicates item is in stock and available for **Fast Track** and **ProXpress**

**IVES ARCHITECTURAL HARDWARE - Parts Price List**

Description	Finish	Part No.	List Price Each
<b>7212V Bottom Pivot (Continued)</b>			
7212/12V/22 Btm Door Leaf - RH	SP28	PVPART.1051	\$100.70
7212/12V/22 Btm Door Leaf - RH	SP313	PVPART.1052	100.70
7212/12V/22 Btm Door Leaf - RH	SPBLK	PVPART.1053	100.70
7212/12V Btm Jamb Leaf - RH	US3	PVPART.1054	153.60
7212/12V Btm Jamb Leaf - RH	US4	PVPART.1055	153.60
7212/12V Btm Jamb Leaf - RH	US10	PVPART.1056	153.60
7212/12V Btm Jamb Leaf - RH	US10B	PVPART.1057	153.60
7212/12V Btm Jamb Leaf - RH	US26	PVPART.1058	153.60
7212/12V Btm Jamb Leaf - RH	US26D	PVPART.1059	131.90
7212/12V Btm Jamb Leaf - RH	SP4	PVPART.1060	100.70
7212/12V Btm Jamb Leaf - RH	SP10	PVPART.1061	100.70
7212/12V Btm Jamb Leaf - RH	SP28	PVPART.1062	100.70
7212/12V Btm Jamb Leaf - RH	SP313	PVPART.1063	100.70
7212/12V Btm Jamb Leaf - RH	SPBLK	PVPART.1064	100.70
7212/12V/22 Btm Door Leaf - LH	US3	PVPART.1065	153.60
7212/12V/22 Btm Door Leaf - LH	US4	PVPART.1066	153.60
7212/12V/22 Btm Door Leaf - LH	US10	PVPART.1067	153.60
7212/12V/22 Btm Door Leaf - LH	US10B	PVPART.1068	153.60
7212/12V/22 Btm Door Leaf - LH	US26	PVPART.1069	153.60
7212/12V/22 Btm Door Leaf - LH	US26D	PVPART.1070	131.90
7212/12V/22 Btm Door Leaf - LH	SP4	PVPART.1071	100.70
7212/12V/22 Btm Door Leaf - LH	SP10	PVPART.1072	100.70
7212/12V/22 Btm Door Leaf - LH	SP28	PVPART.1073	100.70
7212/12V/22 Btm Door Leaf - LH	SP313	PVPART.1074	100.70
7212/12V/22 Btm Door Leaf - LH	SPBLK	PVPART.1075	100.70
7212/12V Btm Jamb Leaf - LH	US3	PVPART.1076	153.60
7212/12V Btm Jamb Leaf - LH	US4	PVPART.1077	153.60
7212/12V Btm Jamb Leaf - LH	US10	PVPART.1078	153.60
7212/12V Btm Jamb Leaf - LH	US10B	PVPART.1079	153.60
7212/12V Btm Jamb Leaf - LH	US26	PVPART.1080	153.60
7212/12V Btm Jamb Leaf - LH	US26D	PVPART.1081	131.90
7212/12V Btm Jamb Leaf - LH	SP4	PVPART.1082	100.70
7212/12V Btm Jamb Leaf - LH	SP10	PVPART.1083	100.70
7212/12V Btm Jamb Leaf - LH	SP28	PVPART.1084	100.70
7212/12V Btm Jamb Leaf - LH	SP313	PVPART.1085	100.70
7212/12V Btm Jamb Leaf - LH	SPBLK	PVPART.1086	100.70
7212/12V/15/22 Btm Mounting Pkg	US3, US4, SP4	PVPART.1087	15.70
7212/12V/15/22 Btm Mounting Pkg	US10, SP10	PVPART.1088	15.70
7212/12V/15/22 Btm Mounting Pkg	US10B, SP313	PVPART.1089	15.70
7212/12V/15/22 Btm Mounting Pkg	US26, US26D, SP28	PVPART.1090	15.70
7212/12V/15/22 Btm Mounting Pkg	SPBLK	PVPART.1091	15.70
7212/12V/15 Btm Security Mtg Pkg	-	PVPART.1092	28.30
7212/12V/15/22 Btm Wood Mtg Pkg	US3, US4, SP4	PVPART.1826	14.30
7212/12V/15/22 Btm Wood Mtg Pkg	US10, SP10	PVPART.1827	14.30
7212/12V/15/22 Btm Wood Mtg Pkg	US10B, SP313	PVPART.1828	14.30
7212/12V/15/22 Btm Wood Mtg Pkg	US26, US26D, SP28	PVPART.1829	14.30
7212/12V/15/22 Btm Wood Mtg Pkg	SPBLK	PVPART.1830	14.30
Pivot Set Screw (Pkg of 10)	-	PVPART.1030	5.80
7212/12V/22 Pivot Bearing	-	PVPART.1031	5.80
7212/12V/22 Pivot Bearing Pin	-	PVPART.1093	5.80
<b>7215 &amp; 7215F Bottom Pivot</b>			
7215 Btm Door Leaf - RH	US3	PVPART.1251	169.10
7215 Btm Door Leaf - RH	US4	PVPART.1252	169.10

Contact Ives Customer Service for pricing on additional sizes and finishes

Bold pricing indicates item is in stock and available for **Fast Track** and **ProXpress**



**IVES ARCHITECTURAL HARDWARE - Parts Price List**

Description	Finish	Part No.	List Price Each
<b>7215 &amp; 7215F Bottom Pivot (Continued)</b>			
7215 Btm Door Leaf - RH	US10	PVPART.1253	\$169.10
7215 Btm Door Leaf - RH	US10B	PVPART.1254	169.10
7215 Btm Door Leaf - RH	US26	PVPART.1255	169.10
7215 Btm Door Leaf - RH	US26D	PVPART.1256	157.70
7215 Btm Door Leaf - RH	SP4	PVPART.1257	171.80
7215 Btm Door Leaf - RH	SP10	PVPART.1258	171.80
7215 Btm Door Leaf - RH	SP28	PVPART.1259	171.80
7215 Btm Door Leaf - RH	SP313	PVPART.1260	171.80
7215 Btm Door Leaf - RH	SPBLK	PVPART.1261	171.80
7215 Btm Jamb Leaf - RH	US3	PVPART.1262	169.10
7215 Btm Jamb Leaf - RH	US4	PVPART.1263	169.10
7215 Btm Jamb Leaf - RH	US10	PVPART.1264	169.10
7215 Btm Jamb Leaf - RH	US10B	PVPART.1265	169.10
7215 Btm Jamb Leaf - RH	US26	PVPART.1266	169.10
7215 Btm Jamb Leaf - RH	US26D	PVPART.1267	157.70
7215 Btm Jamb Leaf - RH	SP4	PVPART.1268	171.80
7215 Btm Jamb Leaf - RH	SP10	PVPART.1269	171.80
7215 Btm Jamb Leaf - RH	SP28	PVPART.1270	171.80
7215 Btm Jamb Leaf - RH	SP313	PVPART.1271	171.80
7215 Btm Jamb Leaf - RH	SPBLK	PVPART.1272	171.80
7215 Btm Door Leaf - LH	US3	PVPART.1273	169.10
7215 Btm Door Leaf - LH	US4	PVPART.1274	169.10
7215 Btm Door Leaf - LH	US10	PVPART.1275	169.10
7215 Btm Door Leaf - LH	US10B	PVPART.1276	169.10
7215 Btm Door Leaf - LH	US26	PVPART.1277	169.10
7215 Btm Door Leaf - LH	US26D	PVPART.1278	157.70
7215 Btm Door Leaf - LH	SP4	PVPART.1279	171.80
7215 Btm Door Leaf - LH	SP10	PVPART.1280	171.80
7215 Btm Door Leaf - LH	SP28	PVPART.1281	171.80
7215 Btm Door Leaf - LH	SP313	PVPART.1282	171.80
7215 Btm Door Leaf - LH	SPBLK	PVPART.1283	171.80
7215 Btm Jamb Leaf - LH	US3	PVPART.1284	169.10
7215 Btm Jamb Leaf - LH	US4	PVPART.1285	169.10
7215 Btm Jamb Leaf - LH	US10	PVPART.1286	169.10
7215 Btm Jamb Leaf - LH	US10B	PVPART.1287	169.10
7215 Btm Jamb Leaf - LH	US26	PVPART.1288	169.10
7215 Btm Jamb Leaf - LH	US26D	PVPART.1289	157.70
7215 Btm Jamb Leaf - LH	SP4	PVPART.1290	171.80
7215 Btm Jamb Leaf - LH	SP10	PVPART.1291	171.80
7215 Btm Jamb Leaf - LH	SP28	PVPART.1292	171.80
7215 Btm Jamb Leaf - LH	SP313	PVPART.1293	171.80
7215 Btm Jamb Leaf - LH	SPBLK	PVPART.1294	171.80
7215F Btm Door Leaf - RH	US3	PVPART.1295	301.10
7215F Btm Door Leaf - RH	US10	PVPART.1296	301.10
7215F Btm Door Leaf - RH	US32	PVPART.1297	301.10
7215F Btm Door Leaf - RH	US32D	PVPART.1298	279.70
7215F Btm Door Leaf - RH	SP4	PVPART.1299	221.70
7215F Btm Door Leaf - RH	SP10	PVPART.1300	221.70
7215F Btm Door Leaf - RH	SP28	PVPART.1301	221.70
7215F Btm Door Leaf - RH	SP313	PVPART.1302	221.70
7215F Btm Door Leaf - RH	SPBLK	PVPART.1303	221.70
7215F Btm Jamb Leaf - RH	US3	PVPART.1304	301.10
7215F Btm Jamb Leaf - RH	US10	PVPART.1305	301.10

Contact Ives Customer Service for pricing on additional sizes and finishes

Bold pricing indicates item is in stock and available for **Fast Track** and **ProXpress**



**IVES ARCHITECTURAL HARDWARE - Parts Price List**

Description	Finish	Part No.	List Price Each
<b>7215 &amp; 7215F Bottom Pivot (Continued)</b>			
7215F Btm Jamb Leaf - RH	US32	PVPART.1306	\$301.10
7215F Btm Jamb Leaf - RH	US32D	PVPART.1307	279.70
7215F Btm Jamb Leaf - RH	SP4	PVPART.1308	221.70
7215F Btm Jamb Leaf - RH	SP10	PVPART.1309	221.70
7215F Btm Jamb Leaf - RH	SP28	PVPART.1310	221.70
7215F Btm Jamb Leaf - RH	SP313	PVPART.1311	221.70
7215F Btm Jamb Leaf - RH	SPBLK	PVPART.1312	221.70
7215F Btm Door Leaf - LH	US3	PVPART.1313	301.10
7215F Btm Door Leaf - LH	US10	PVPART.1314	301.10
7215F Btm Door Leaf - LH	US32	PVPART.1315	301.10
7215F Btm Door Leaf - LH	US32D	PVPART.1316	279.70
7215F Btm Door Leaf - LH	SP4	PVPART.1317	221.70
7215F Btm Door Leaf - LH	SP10	PVPART.1318	221.70
7215F Btm Door Leaf - LH	SP28	PVPART.1319	221.70
7215F Btm Door Leaf - LH	SP313	PVPART.1320	221.70
7215F Btm Door Leaf - LH	SPBLK	PVPART.1321	221.70
7215F Btm Jamb Leaf - LH	US3	PVPART.1322	301.10
7215F Btm Jamb Leaf - LH	US10	PVPART.1323	301.10
7215F Btm Jamb Leaf - LH	US32	PVPART.1324	301.10
7215F Btm Jamb Leaf - LH	US32D	PVPART.1325	279.70
7215F Btm Jamb Leaf - LH	SP4	PVPART.1326	221.70
7215F Btm Jamb Leaf - LH	SP10	PVPART.1327	221.70
7215F Btm Jamb Leaf - LH	SP28	PVPART.1328	221.70
7215F Btm Jamb Leaf - LH	SP313	PVPART.1329	221.70
7215F Btm Jamb Leaf - LH	SPBLK	PVPART.1330	221.70
7212/12V/15/22 Btm Mounting Pkg	US3, US4, SP4	PVPART.1087	15.70
7212/12V/15/22 Btm Mounting Pkg	US10, SP10	PVPART.1088	15.70
7212/12V/15/22 Btm Mounting Pkg	US10B, SP313	PVPART.1089	15.70
7212/12V/15/22 Btm Mounting Pkg	US26, US26D, US32, US32D, SP28	PVPART.1090	15.70
7212/12V/15/22 Btm Mounting Pkg	SPBLK	PVPART.1091	15.70
7212/12V/15/22 Btm Security Mtg Pkg	-	PVPART.1092	28.30
7212/12V/15/22 Btm Wood Mtg Pkg	US3, US4, SP4	PVPART.1826	14.30
7212/12V/15/22 Btm Wood Mtg Pkg	US10, SP10	PVPART.1827	14.30
7212/12V/15/22 Btm Wood Mtg Pkg	US10B, SP313	PVPART.1828	14.30
7212/12V/15/22 Btm Wood Mtg Pkg	US26, US26D, US32, US32D, SP28	PVPART.1829	14.30
7212/12V/15/22 Btm Wood Mtg Pkg	SPBLK	PVPART.1830	14.30
7212/15/22/26/27/30/37/44/45 Cap Screw	US3	PVPART.1032	22.70
7212/15/22/26/27/30/37/44/45 Cap Screw	US4	PVPART.1033	22.70
7212/15/22/26/27/30/37/44/45 Cap Screw	US10	PVPART.1034	22.70
7212/15/22/26/27/30/37/44/45 Cap Screw	US10B	PVPART.1035	22.70
7212/15/22/26/27/30/37/44/45 Cap Screw	US26, US32	PVPART.1036	22.70
7212/15/22/26/27/30/37/44/45 Cap Screw	US26D, US32D	PVPART.1037	22.70
7212/15/22/26/27/30/37/44/45 Cap Screw	SP4	PVPART.1038	22.70
7212/15/22/26/27/30/37/44/45 Cap Screw	SP10	PVPART.1039	22.70
7212/15/22/26/27/30/37/44/45 Cap Screw	SP28	PVPART.1040	22.70
7212/15/22/26/27/30/37/44/45 Cap Screw	SP313	PVPART.1041	22.70
7212/15/22/26/27/30/37/44/45 Cap Screw	SPBLK	PVPART.1042	22.70
7215/26/27 Pivot Ball	-	PVPART.1349	2.10
7215/15F Pivot Pin	-	PVPART.1350	10.00
Pivot Bearing Shaft	-	PVPART.1351	5.80
Pivot Washer (Pkg of 10)	-	PVPART.1352	7.20
Pivot Retainer Lock	-	PVPART.1353	8.50

Contact Ives Customer Service for pricing on additional sizes and finishes

Bold pricing indicates item is in stock and available for **Fast Track** and **ProXpress**

**IVES ARCHITECTURAL HARDWARE - Parts Price List**

Description	Finish	Part No.	List Price Each
<b>7222 Bottom Pivot</b>			
7212/12V/22 Btm Door Leaf - RH	US3	PVPART.1043	\$153.60
7212/12V/22 Btm Door Leaf - RH	US4	PVPART.1044	153.60
7212/12V/22 Btm Door Leaf - RH	US10	PVPART.1045	153.60
7212/12V/22 Btm Door Leaf - RH	US10B	PVPART.1046	153.60
7212/12V/22 Btm Door Leaf - RH	US26	PVPART.1047	153.60
7212/12V/22 Btm Door Leaf - RH	US26D	PVPART.1048	131.90
7212/12V/22 Btm Door Leaf - RH	SP4	PVPART.1049	100.70
7212/12V/22 Btm Door Leaf - RH	SP10	PVPART.1050	100.70
7212/12V/22 Btm Door Leaf - RH	SP28	PVPART.1051	100.70
7212/12V/22 Btm Door Leaf - RH	SP313	PVPART.1052	100.70
7212/12V/22 Btm Door Leaf - RH	SPBLK	PVPART.1053	100.70
7212/12V/22 Btm Door Leaf - LH	US3	PVPART.1065	153.60
7212/12V/22 Btm Door Leaf - LH	US4	PVPART.1066	153.60
7212/12V/22 Btm Door Leaf - LH	US10	PVPART.1067	153.60
7212/12V/22 Btm Door Leaf - LH	US10B	PVPART.1068	153.60
7212/12V/22 Btm Door Leaf - LH	US26	PVPART.1069	153.60
7212/12V/22 Btm Door Leaf - LH	US26D	PVPART.1070	131.90
7212/12V/22 Btm Door Leaf - LH	SP4	PVPART.1071	100.70
7212/12V/22 Btm Door Leaf - LH	SP10	PVPART.1072	100.70
7212/12V/22 Btm Door Leaf - LH	SP28	PVPART.1073	100.70
7212/12V/22 Btm Door Leaf - LH	SP313	PVPART.1074	100.70
7212/12V/22 Btm Door Leaf - LH	SPBLK	PVPART.1075	100.70
7222 Btm Cone Pkg	US3	PVPART.1440	142.10
7222 Btm Cone Pkg	US4	PVPART.1441	142.10
7222 Btm Cone Pkg	US10	PVPART.1442	142.10
7222 Btm Cone Pkg	US10B	PVPART.1443	142.10
7222 Btm Cone Pkg	US26	PVPART.1444	142.10
7222 Btm Cone Pkg	US26D	PVPART.1445	122.20
7222 Btm Cone Pkg	SP4	PVPART.1446	86.50
7222 Btm Cone Pkg	SP10	PVPART.1447	86.50
7222 Btm Cone Pkg	SP28	PVPART.1448	86.50
7222 Btm Cone Pkg	SP313	PVPART.1449	86.50
7222 Btm Cone Pkg	SPBLK	PVPART.1450	86.50
7222 Btm Mounting Pkg	-	PVPART.1451	25.40
7222 Security Mounting Pkg	-	PVPART.1452	14.30
Pivot Set Screw (Pkg of 10)	-	PVPART.1030	5.80
7212/12V/22 Pivot Bearing	-	PVPART.1031	5.80
7212/12V/22 Pivot Bearing Pin	-	PVPART.1093	5.80
<b>7226 &amp; 7226F Bottom Pivot</b>			
7226/26F/27/27F Bottom Door Leaf	-	PVPART.1334	155.90
7226 Bottom Base Pkg	US3	PVPART.1453	160.50
7226 Bottom Base Pkg	US4	PVPART.1454	160.50
7226 Bottom Base Pkg	US10	PVPART.1455	160.50
7226 Bottom Base Pkg	US10B	PVPART.1456	160.50
7226 Bottom Base Pkg	US26	PVPART.1457	160.50
7226 Bottom Base Pkg	US26D	PVPART.1458	147.60
7226 Bottom Base Pkg	SP4	PVPART.1459	131.90
7226 Bottom Base Pkg	SP10	PVPART.1460	131.90
7226 Bottom Base Pkg	SP28	PVPART.1461	131.90
7226 Bottom Base Pkg	SP313	PVPART.1462	131.90
7226 Bottom Base Pkg	SPBLK	PVPART.1463	131.90
7226F/44F Bottom Base Pkg	US3	PVPART.1640	316.70
7226F/44F Bottom Base Pkg	US10	PVPART.1641	316.70

Contact Ives Customer Service for pricing on additional sizes and finishes

Bold pricing indicates item is in stock and available for **Fast Track** and **ProXpress**

**IVES ARCHITECTURAL HARDWARE - Parts Price List**

Description	Finish	Part No.	List Price Each
<b>7226 &amp; 7226F Bottom Pivot (Continued)</b>			
7226F/44F Bottom Base Pkg	US32	PVPART.1642	\$316.70
7226F/44F Bottom Base Pkg	US32D	PVPART.1643	304.00
7226F/44F Bottom Base Pkg	SP4	PVPART.1644	269.70
7226F/44F Bottom Base Pkg	SP10	PVPART.1645	269.70
7226F/44F Bottom Base Pkg	SP28	PVPART.1646	269.70
7226F/44F Bottom Base Pkg	SP313	PVPART.1647	269.70
7226F/44F Bottom Base Pkg	SPBLK	PVPART.1648	269.70
7226/26F Bottom Mounting Pkg	US3, US4, SP4	PVPART.1464	43.90
7226/26F Bottom Mounting Pkg	US10, SP10	PVPART.1465	43.90
7226/26F Bottom Mounting Pkg	US10B, SP313	PVPART.1466	43.90
7226/26F Bottom Mounting Pkg	US26, US26D, SP28	PVPART.1467	43.90
7226/26F Bottom Mounting Pkg	SPBLK	PVPART.1468	43.90
7226/26F Security Mounting Pkg	-	PVPART.1469	34.30
7226/27/30F/37F/44F/45F Cover	US3	PVPART.1470	56.70
7226/27/30F/37F/44F/45F Cover	US4	PVPART.1471	56.70
7226/27/30F/37F/44F/45F Cover	US10	PVPART.1472	56.70
7226/27/30F/37F/44F/45F Cover	US10B	PVPART.1473	56.70
7226/27/30F/37F/44F/45F Cover	US26, US32	PVPART.1474	56.70
7226/27/30F/37F/44F/45F Cover	US26D, US32D	PVPART.1476	56.70
7226/27/30F/37F/44F/45F Cover	SP4	PVPART.1478	56.70
7226/27/30F/37F/44F/45F Cover	SP10	PVPART.1479	56.70
7226/27/30F/37F/44F/45F Cover	SP28	PVPART.1480	56.70
7226/27/30F/37F/44F/45F Cover	SP313	PVPART.1481	56.70
7226/27/30F/37F/44F/45F Cover	SPBLK	PVPART.1482	56.70
7226/27/30F/37F/44F/45F Cover Screw	US3	PVPART.1483	10.00
7226/27/30F/37F/44F/45F Cover Screw	US4, SP4	PVPART.1484	10.00
7226/27/30F/37F/44F/45F Cover Screw	US10, SP10	PVPART.1485	10.00
7226/27/30F/37F/44F/45F Cover Screw	US10B, SP313	PVPART.1486	10.00
7226/27/30F/37F/44F/45F Cover Screw	US26, US32	PVPART.1487	10.00
7226/27/30F/37F/44F/45F Cover Screw	US26D, US32D, SP28	PVPART.1488	10.00
7226/27/30F/37F/44F/45F Cover Screw	SPBLK	PVPART.1495	10.00
7226/27/37/44/45 Btm Pivot Bearing Pin	-	PVPART.1849	15.70
Pivot Set Screw (Pkg of 10)	-	PVPART.1030	5.80
<b>7227 &amp; 7227F Bottom Pivot</b>			
7226/26F/27/27F Bottom Door Leaf	-	PVPART.1334	155.90
7227/27F/45F Base Pkg	-	PVPART.1497	521.30
7227/37/45/56/59 Finish Plate Pkg	US3	PVPART.1498	113.60
7227/37/45/56/59 Finish Plate Pkg	US4	PVPART.1499	113.60
7227/37/45/56/59 Finish Plate Pkg	US10	PVPART.1500	113.60
7227/37/45/56/59 Finish Plate Pkg	US10B	PVPART.1501	113.60
7227/37/45/56/59 Finish Plate Pkg	US26, US32	PVPART.1502	113.60
7227/37/45/56/59 Finish Plate Pkg	US26D, US32D	PVPART.1503	103.60
7227/37/45/56/59 Finish Plate Pkg	SP4	PVPART.1506	95.10
7227/37/45/56/59 Finish Plate Pkg	SP10	PVPART.1507	95.10
7227/37/45/56/59 Finish Plate Pkg	SP28	PVPART.1508	95.10
7227/37/45/56/59 Finish Plate Pkg	SP313	PVPART.1509	95.10
7227/37/45/56/59 Finish Plate Pkg	SPBLK	PVPART.1510	95.10
7227/7237F Bottom Mounting Pkg	US3, US4, SP4	PVPART.1511	43.90
7227/7237F Bottom Mounting Pkg	US10, SP10	PVPART.1512	43.90
7227/7237F Bottom Mounting Pkg	US10B, SP313	PVPART.1513	43.90
7227/7237F Bottom Mounting Pkg		PVPART.1514	43.90
7227/7237F Bottom Mounting Pkg	SPBLK	PVPART.1515	43.90
7227/7237F Bottom Security Mounting Pkg	-	PVPART.1516	45.40
7226/27/30F/37F/44F/45F Cover	US3	PVPART.1470	56.70

Contact Ives Customer Service for pricing on additional sizes and finishes

Bold pricing indicates item is in stock and available for **Fast Track** and **ProXpress**

**IVES ARCHITECTURAL HARDWARE - Parts Price List**

Description	Finish	Part No.	List Price Each
<b>7227 &amp; 7227F Bottom Pivot (Continued)</b>			
7226/27/30F/37F/44F/45F Cover	US4	PVPART.1471	\$56.70
7226/27/30F/37F/44F/45F Cover	US10	PVPART.1472	56.70
7226/27/30F/37F/44F/45F Cover	US10B	PVPART.1473	56.70
7226/27/30F/37F/44F/45F Cover	US26, US32	PVPART.1474	56.70
7226/27/30F/37F/44F/45F Cover	US26D, US32D	PVPART.1476	56.70
7226/27/30F/37F/44F/45F Cover	SP4	PVPART.1478	56.70
7226/27/30F/37F/44F/45F Cover	SP10	PVPART.1479	56.70
7226/27/30F/37F/44F/45F Cover	SP28	PVPART.1480	56.70
7226/27/30F/37F/44F/45F Cover	SP313	PVPART.1481	56.70
7226/27/30F/37F/44F/45F Cover	SPBLK	PVPART.1482	56.70
7226/27/30F/37F/44F/45F Cover Screw	US3	PVPART.1483	10.00
7226/27/30F/37F/44F/45F Cover Screw	US4, SP4	PVPART.1484	10.00
7226/27/30F/37F/44F/45F Cover Screw	US10, SP10	PVPART.1485	10.00
7226/27/30F/37F/44F/45F Cover Screw	US10B, SP313	PVPART.1486	10.00
7226/27/30F/37F/44F/45F Cover Screw	US26, US32	PVPART.1487	10.00
7226/27/30F/37F/44F/45F Cover Screw	US26D, US32D, SP28	PVPART.1488	10.00
7226/27/30F/37F/44F/45F Cover Screw	SPBLK	PVPART.1495	10.00
7227/37/45/56/59 Finish Plate Screw (Pkg of 10)	-	PVPART.1335	2.10
7226/27/37/44/45 Btm Pivot Bearing Pin	-	PVPART.1849	15.70
Pivot Set Screw (Pkg of 10)	-	PVPART.1030	5.80
<b>7230F Bottom Pivot</b>			
7230F/37F Btm Door Leaf	-	PVPART.1545	173.30
7230F Btm Base Pkg	US3	PVPART.1546	316.70
7230F Btm Base Pkg	US10	PVPART.1547	316.70
7230F Btm Base Pkg	US32	PVPART.1548	316.70
7230F Btm Base Pkg	US32D	PVPART.1549	304.00
7230F Btm Base Pkg	SP4	PVPART.1550	269.70
7230F Btm Base Pkg	SP10	PVPART.1551	269.70
7230F Btm Base Pkg	SP28	PVPART.1552	269.70
7230F Btm Base Pkg	SP313	PVPART.1553	269.70
7230F Btm Base Pkg	SPBLK	PVPART.1554	269.70
7230F Btm Mounting Pkg	US3, SP4	PVPART.1555	46.90
7230F Btm Mounting Pkg	US10, SP10	PVPART.1556	46.90
7230F Btm Mounting Pkg	US32, US32D, SP28	PVPART.1557	46.90
7230F Btm Mounting Pkg	SP313	PVPART.1562	46.90
7230F Btm Mounting Pkg	SPBLK	PVPART.1563	46.90
7230F Btm Security Mtg Pkg	-	PVPART.1564	41.30
7226/27/30F/37F/44F/45F Cover	US3	PVPART.1470	56.70
7226/27/30F/37F/44F/45F Cover	US10	PVPART.1472	56.70
7226/27/30F/37F/44F/45F Cover	US32	PVPART.1474	56.70
7226/27/30F/37F/44F/45F Cover	US32D	PVPART.1476	56.70
7226/27/30F/37F/44F/45F Cover	SP4	PVPART.1478	56.70
7226/27/30F/37F/44F/45F Cover	SP10	PVPART.1479	56.70
7226/27/30F/37F/44F/45F Cover	SP28	PVPART.1480	56.70
7226/27/30F/37F/44F/45F Cover	SP313	PVPART.1481	56.70
7226/27/30F/37F/44F/45F Cover	SPBLK	PVPART.1482	56.70
7226/27/30F/37F/44F/45F Cover Screw	US3	PVPART.1483	10.00
7226/27/30F/37F/44F/45F Cover Screw	US10, SP10	PVPART.1485	10.00
7226/27/30F/37F/44F/45F Cover Screw	US32	PVPART.1487	10.00
7226/27/30F/37F/44F/45F Cover Screw	US32D, SP28	PVPART.1488	10.00
7226/27/30F/37F/44F/45F Cover Screw	SP4	PVPART.1484	10.00
7226/27/30F/37F/44F/45F Cover Screw	SP313	PVPART.1486	10.00
7226/27/30F/37F/44F/45F Cover Screw	SPBLK	PVPART.1495	10.00

Contact Ives Customer Service for pricing on additional sizes and finishes

Bold pricing indicates item is in stock and available for **Fast Track** and **ProXpress**

**IVES ARCHITECTURAL HARDWARE - Parts Price List**

Description	Finish	Part No.	List Price Each
<b>7230F Bottom Pivot (Continued)</b>			
7230F Pivot Bearing Pin	-	PVPART.1850	\$15.70
Pivot Set Screw (Pkg of 10)	-	PVPART.1030	5.80
<b>7237F Bottom Pivot</b>			
7230F/37F Btm Door Leaf	-	PVPART.1545	173.30
7237F Btm Base Pkg	-	PVPART.1608	521.30
7227/37/45/56/59 Finish Plate Pkg	US3	PVPART.1498	113.60
7227/37/45/56/59 Finish Plate Pkg	US10	PVPART.1500	113.60
7227/37/45/56/59 Finish Plate Pkg	US32	PVPART.1502	113.60
7227/37/45/56/59 Finish Plate Pkg	US32D	PVPART.1503	103.60
7227/37/45/56/59 Finish Plate Pkg	SP4	PVPART.1506	95.10
7227/37/45/56/59 Finish Plate Pkg	SP10	PVPART.1507	95.10
7227/37/45/56/59 Finish Plate Pkg	SP28	PVPART.1508	95.10
7227/37/45/56/59 Finish Plate Pkg	SP313	PVPART.1509	95.10
7227/37/45/56/59 Finish Plate Pkg	SPBLK	PVPART.1510	95.10
7227/7237F Btm Mounting Pkg	US3, SP4	PVPART.1511	43.90
7227/7237F Btm Mounting Pkg	US10, SP10	PVPART.1512	43.90
7227/7237F Btm Mounting Pkg	SP313	PVPART.1513	43.90
7227/7237F Btm Mounting Pkg	US32, US32D, SP28	PVPART.1514	43.90
7227/7237F Btm Mounting Pkg	SPBLK	PVPART.1515	43.90
7227/7237F Btm Security Mtg Pkg	-	PVPART.1516	45.40
7226/27/30F/37F/44F/45F Cover	US3	PVPART.1470	56.70
7226/27/30F/37F/44F/45F Cover	US10	PVPART.1472	56.70
7226/27/30F/37F/44F/45F Cover	US32	PVPART.1474	56.70
7226/27/30F/37F/44F/45F Cover	US32D	PVPART.1476	56.70
7226/27/30F/37F/44F/45F Cover	SP4	PVPART.1478	56.70
7226/27/30F/37F/44F/45F Cover	SP10	PVPART.1479	56.70
7226/27/30F/37F/44F/45F Cover	SP28	PVPART.1480	56.70
7226/27/30F/37F/44F/45F Cover	SP313	PVPART.1481	56.70
7226/27/30F/37F/44F/45F Cover	SPBLK	PVPART.1482	56.70
7226/27/30F/37F/44F/45F Cover Screw	US3	PVPART.1483	10.00
7226/27/30F/37F/44F/45F Cover Screw	US10, SP10	PVPART.1485	10.00
7226/27/30F/37F/44F/45F Cover Screw	US32	PVPART.1487	10.00
7226/27/30F/37F/44F/45F Cover Screw	US32D, SP28	PVPART.1488	10.00
7226/27/30F/37F/44F/45F Cover Screw	SP4	PVPART.1484	10.00
7226/27/30F/37F/44F/45F Cover Screw	SP313	PVPART.1486	10.00
7226/27/30F/37F/44F/45F Cover Screw	SPBLK	PVPART.1495	10.00
7227/37/45/56/59 Finish Plate Screw (Pkg of 10)	-	PVPART.1335	2.10
7226/27/37/44/45 Btm Pivot Bearing Pin	-	PVPART.1849	15.70
Pivot Set Screw (Pkg of 10)	-	PVPART.1030	5.80
<b>7244F Bottom Pivot</b>			
7244F/45F Bottom Door Leaf	-	PVPART.1639	173.30
7226/26F/44F Bottom Base Pkg	US3	PVPART.1640	316.70
7226/26F/44F Bottom Base Pkg	US10	PVPART.1641	316.70
7226/26F/44F Bottom Base Pkg	US32	PVPART.1642	316.70
7226/26F/44F Bottom Base Pkg	US32D	PVPART.1643	304.00
7226/26F/44F Bottom Base Pkg	SP4	PVPART.1644	269.70
7226/26F/44F Bottom Base Pkg	SP10	PVPART.1645	269.70
7226/26F/44F Bottom Base Pkg	SP28	PVPART.1646	269.70
7226/26F/44F Bottom Base Pkg	SP313	PVPART.1647	269.70
7226/26F/44F Bottom Base Pkg	SPBLK	PVPART.1648	269.70
7244F/7245F Bottom Mounting Pkg	US3, SP4	PVPART.1649	43.90
7244F/7245F Bottom Mounting Pkg	US10, SP10	PVPART.1650	43.90
7244F/7245F Bottom Mounting Pkg	US32, US32D, SP28	PVPART.1651	43.90

Contact Ives Customer Service for pricing on additional sizes and finishes

Bold pricing indicates item is in stock and available for **Fast Track** and **ProXpress**

**IVES ARCHITECTURAL HARDWARE - Parts Price List**

Parts

Description	Finish	Part No.	List Price Each
<b>7244F Bottom Pivot (Continued)</b>			
7244F/7245F Bottom Mounting Pkg	SP313	PVPART.1652	43.90
7244F/7245F Bottom Mounting Pkg	SPBLK	PVPART.1653	43.90
7244F/45F Bottom Security Mounting Pkg	-	PVPART.1654	38.20
7226/27/30F/37F/44F/45F Cover	US3	PVPART.1470	56.70
7226/27/30F/37F/44F/45F Cover	US10	PVPART.1472	56.70
7226/27/30F/37F/44F/45F Cover	US32	PVPART.1474	56.70
7226/27/30F/37F/44F/45F Cover	US32D	PVPART.1476	56.70
7226/27/30F/37F/44F/45F Cover	SP4	PVPART.1478	56.70
7226/27/30F/37F/44F/45F Cover	SP10	PVPART.1479	56.70
7226/27/30F/37F/44F/45F Cover	SP28	PVPART.1480	56.70
7226/27/30F/37F/44F/45F Cover	SP313	PVPART.1481	56.70
7226/27/30F/37F/44F/45F Cover	SPBLK	PVPART.1482	56.70
7226/27/30F/37F/44F/45F Cover Screw	US3	PVPART.1483	10.00
7226/27/30F/37F/44F/45F Cover Screw	US10, SP10	PVPART.1485	10.00
7226/27/30F/37F/44F/45F Cover Screw	US32	PVPART.1487	10.00
7226/27/30F/37F/44F/45F Cover Screw	US32D, SP28	PVPART.1488	10.00
7226/27/30F/37F/44F/45F Cover Screw	SP4	PVPART.1484	10.00
7226/27/30F/37F/44F/45F Cover Screw	SP313	PVPART.1486	10.00
7226/27/30F/37F/44F/45F Cover Screw	SPBLK	PVPART.1495	10.00
7226/27/37/44/45 Btm Pivot Bearing Pin	-	PVPART.1849	15.70
Pivot Set Screw (Pkg of 10)	-	PVPART.1030	5.80
<b>7245F Bottom Pivot</b>			
7244F/45F Bottom Door Leaf	-	PVPART.1639	173.30
72/27/27F/45F Bottom Base Pkg	-	PVPART.1497	521.30
7227/37/45/56/59 Finish Plate Pkg	US3	PVPART.1498	113.60
7227/37/45/56/59 Finish Plate Pkg	US10	PVPART.1500	113.60
7227/37/45/56/59 Finish Plate Pkg	US32	PVPART.1502	113.60
7227/37/45/56/59 Finish Plate Pkg	US32D	PVPART.1503	103.60
7227/37/45/56/59 Finish Plate Pkg	SP4	PVPART.1506	95.10
7227/37/45/56/59 Finish Plate Pkg	SP10	PVPART.1507	95.10
7227/37/45/56/59 Finish Plate Pkg	SP28	PVPART.1508	95.10
7227/37/45/56/59 Finish Plate Pkg	SP313	PVPART.1509	95.10
7227/37/45/56/59 Finish Plate Pkg	SPBLK	PVPART.1510	95.10
7244F/45F Bottom Mounting Pkg	US3, SP4	PVPART.1649	43.90
7244F/45F Bottom Mounting Pkg	US10, SP10	PVPART.1650	43.90
7244F/45F Bottom Mounting Pkg	US32, US32D, SP28	PVPART.1651	43.90
7244F/45F Bottom Mounting Pkg	SP313	PVPART.1652	43.90
7244F/45F Bottom Mounting Pkg	SPBLK	PVPART.1653	43.90
7245F Bottom Security Mtg Pkg	-	PVPART.1654	38.20
7226/27/30F/37F/44F/45F Cover	US3	PVPART.1470	56.70
7226/27/30F/37F/44F/45F Cover	US10	PVPART.1472	56.70
7226/27/30F/37F/44F/45F Cover	US32	PVPART.1474	56.70
7226/27/30F/37F/44F/45F Cover	US32D	PVPART.1476	56.70
7226/27/30F/37F/44F/45F Cover	SP4	PVPART.1478	56.70
7226/27/30F/37F/44F/45F Cover	SP10	PVPART.1479	56.70
7226/27/30F/37F/44F/45F Cover	SP28	PVPART.1480	56.70
7226/27/30F/37F/44F/45F Cover	SP313	PVPART.1481	56.70
7226/27/30F/37F/44F/45F Cover	SPBLK	PVPART.1482	56.70
7226/27/30F/37F/44F/45F Cover Screw	US3	PVPART.1483	10.00
7226/27/30F/37F/44F/45F Cover Screw	US10, SP10	PVPART.1485	10.00
7226/27/30F/37F/44F/45F Cover Screw	US32	PVPART.1487	10.00
7226/27/30F/37F/44F/45F Cover Screw	US32D, SP28	PVPART.1488	10.00
7226/27/30F/37F/44F/45F Cover Screw	SP4	PVPART.1484	10.00

Contact Ives Customer Service for pricing on additional sizes and finishes

Bold pricing indicates item is in stock and available for **Fast Track** and **ProXpress**



**IVES ARCHITECTURAL HARDWARE - Parts Price List**

Description	Finish	Part No.	List Price Each
<b>7245F Bottom Pivot (Continued)</b>			
7226/27/30F/37F/44F/45F Cover Screw	SP313	PVPART.1486	\$10.00
7226/27/30F/37F/44F/45F Cover Screw	SPBLK	PVPART.1495	10.00
7226/27/37/44/45 Btm Pivot Bearing Pin	-	PVPART.1849	15.70
Pivot Set Screw (Pkg of 10)	-	PVPART.1030	5.80
7227/37/45/56/59 Finish Plate Screw (Pkg of 10)	-	PVPART.1335	2.10
<b>7253 Bottom Pivot</b>			
7253 Btm Door Leaf	-	PVPART.1735	173.30
7253 Btm Base	US3	PVPART.1736	69.80
7253 Btm Base	US4	PVPART.1737	69.80
7253 Btm Base	US10	PVPART.1738	69.80
7253 Btm Base	US10B	PVPART.1739	69.80
7253 Btm Base	US26	PVPART.1740	69.80
7253 Btm Base	US26D	PVPART.1741	69.80
7253 Btm Base	SP4	PVPART.1742	61.00
7253 Btm Base	SP10	PVPART.1743	61.00
7253 Btm Base	SP28	PVPART.1744	61.00
7253 Btm Base	SP313	PVPART.1745	61.00
7253 Btm Base	SPBLK	PVPART.1746	61.00
7253 Bearing	-	PVPART.1704	22.70
7253 Btm Mounting Pkg	-	PVPART.1747	52.50
7253 Btm Security Mounting Pkg	-	PVPART.1748	10.00
<b>7255 Bottom Pivot</b>			
7255/55J Bottom Door Leaf	-	PVPART.1749	130.70
7255 Btm Base	US3	PVPART.1750	114.90
7255 Btm Base	US4	PVPART.1751	114.90
7255 Btm Base	US10	PVPART.1752	114.90
7255 Btm Base	US10B	PVPART.1753	114.90
7255 Btm Base	US26	PVPART.1754	114.90
7255 Btm Base	US26D	PVPART.1755	114.90
7255 Btm Base	SP4	PVPART.1756	109.50
7255 Btm Base	SP10	PVPART.1757	109.50
7255 Btm Base	SP28	PVPART.1758	109.50
7255 Btm Base	SP313	PVPART.1759	109.50
7255 Btm Base	SPBLK	PVPART.1760	109.50
7255 Btm Mounting Pkg	US3, US4, SP4	PVPART.1761	21.30
7255 Btm Mounting Pkg	US10, SP10	PVPART.1762	21.30
7255 Btm Mounting Pkg	US10B, SP313	PVPART.1763	21.30
7255 Btm Mounting Pkg	US26, US26D, SP28	PVPART.1764	21.30
7255 Btm Mounting Pkg	SPBLK	PVPART.1765	21.30
7255 Btm Security Mounting Pkg	-	PVPART.1766	24.10
<b>7255J Bottom Pivot</b>			
7255/55J Bottom Door Leaf	-	PVPART.1749	130.70
7255J Bottom Base	US3	PVPART.1767	114.90
7255J Bottom Base	US4	PVPART.1768	114.90
7255J Bottom Base	US10	PVPART.1769	114.90
7255J Bottom Base	US10B	PVPART.1770	114.90
7255J Bottom Base	US26	PVPART.1771	114.90
7255J Bottom Base	US26D	PVPART.1772	114.90
7255J Bottom Base	SP4	PVPART.1773	109.50
7255J Bottom Base	SP10	PVPART.1774	109.50
7255J Bottom Base	SP28	PVPART.1775	109.50
7255J Bottom Base	SP313	PVPART.1776	109.50
7255J Bottom Base	SPBLK	PVPART.1777	109.50

Contact Ives Customer Service for pricing on additional sizes and finishes

Bold pricing indicates item is in stock and available for **Fast Track** and **ProXpress**



**IVES ARCHITECTURAL HARDWARE - Parts Price List**

Description	Finish	Part No.	List Price Each
<b>7255J Bottom Pivot (Continued)</b>			
7255J Bottom Mounting Pkg	US3, US4, SP4	PVPART.1778	\$14.30
7255J Bottom Mounting Pkg	US10, SP10	PVPART.1779	14.30
7255J Bottom Mounting Pkg	US10B, SP313	PVPART.1780	14.30
7255J Bottom Mounting Pkg	US26, US26D, SP28	PVPART.1781	14.30
7255J Bottom Mounting Pkg	SPBLK	PVPART.1782	14.30
7255J Btm Security Mtg Pkg	-	PVPART.1783	21.30
7255J Bottom Wood Mtg Pkg	US3, US4, SP4	PVPART.1864	10.00
7255J Bottom Wood Mtg Pkg	US10, SP10	PVPART.1865	10.00
7255J Bottom Wood Mtg Pkg	US10B, SP313	PVPART.1866	10.00
7255J Bottom Wood Mtg Pkg	US26, US26D, SP28	PVPART.1867	10.00
7255J Bottom Wood Mtg Pkg	SPBLK	PVPART.1868	10.00
<b>7256 Bottom Pivot</b>			
7256 Btm Door Leaf	-	PVPART.1784	130.70
7256 Btm Base Pkg	-	PVPART.1785	478.50
7227/37/45/56/59 Finish Plate Pkg	US3	PVPART.1498	113.60
7227/37/45/56/59 Finish Plate Pkg	US4	PVPART.1499	113.60
7227/37/45/56/59 Finish Plate Pkg	US10	PVPART.1500	113.60
7227/37/45/56/59 Finish Plate Pkg	US10B	PVPART.1501	113.60
7227/37/45/56/59 Finish Plate Pkg	US26	PVPART.1502	113.60
7227/37/45/56/59 Finish Plate Pkg	US26D	PVPART.1503	103.60
7227/37/45/56/59 Finish Plate Pkg	SP4	PVPART.1506	95.10
7227/37/45/56/59 Finish Plate Pkg	SP10	PVPART.1507	95.10
7227/37/45/56/59 Finish Plate Pkg	SP28	PVPART.1508	95.10
7227/37/45/56/59 Finish Plate Pkg	SP313	PVPART.1509	95.10
7227/37/45/56/59 Finish Plate Pkg	SPBLK	PVPART.1510	95.10
7256 Btm Mounting Pkg	-	PVPART.1786	10.00
7256 Btm Security Mounting Pkg	-	PVPART.1787	14.30
7227/37/45/56/59 Finish Plate Screw (Pkg of 10)	-	PVPART.1335	2.10
<b>7259 Bottom Pivot</b>			
7259 Btm Door Leaf	-	PVPART.1817	261.50
7259 Btm Base Kit	-	PVPART.1818	695.80
7227/37/45/56/59 Finish Plate Pkg	US3	PVPART.1498	113.60
7227/37/45/56/59 Finish Plate Pkg	US4	PVPART.1499	113.60
7227/37/45/56/59 Finish Plate Pkg	US10	PVPART.1500	113.60
7227/37/45/56/59 Finish Plate Pkg	US10B	PVPART.1501	113.60
7227/37/45/56/59 Finish Plate Pkg	US26	PVPART.1502	113.60
7227/37/45/56/59 Finish Plate Pkg	US26D	PVPART.1503	103.60
7227/37/45/56/59 Finish Plate Pkg	SP4	PVPART.1506	95.10
7227/37/45/56/59 Finish Plate Pkg	SP10	PVPART.1507	95.10
7227/37/45/56/59 Finish Plate Pkg	SP28	PVPART.1508	95.10
7227/37/45/56/59 Finish Plate Pkg	SP313	PVPART.1509	95.10
7227/37/45/56/59 Finish Plate Pkg	SPBLK	PVPART.1510	95.10
7259 Btm Mounting Pkg	-	PVPART.1819	14.30
7259 Btm Security Mtg Pkg	-	PVPART.1820	31.20
<b>91105 Pocket Pivot</b>			
91105 Pocket Pivot Mtg Pkg	US3	PVPART.1188	21.30
91105 Pocket Pivot Mtg Pkg	US10	PVPART.1189	21.30
91105 Pocket Pivot Mtg Pkg	US32, US32D, USP	PVPART.1190	21.30
91105 Pocket Pivot Mtg Pkg	SP313	PVPART.1191	21.30
<b>AS18</b>			
AS18 Mounting Pkg	US3, US4	ASPART.1001	6.50
AS18 Mounting Pkg	US10	ASPART.1002	6.50
AS18 Mounting Pkg	US10B	ASPART.1003	6.50

Contact Ives Customer Service for pricing on additional sizes and finishes

Bold pricing indicates item is in stock and available for **Fast Track** and **ProXpress**

**IVES ARCHITECTURAL HARDWARE - Parts Price List**

Description	Finish	Part No.	List Price Each
<b>AS18 (Continued)</b>			
AS18 Mounting Pkg	US26, US26D	ASPART.1004	6.50
Silencer (Pkg of 10)	-	ASPART.1005	6.50
AS18 Security Mounting Pkg	-	ASPART.1006	13.00
<b>AS895</b>			
AS895 Mounting Pkg	US3, US4	ASPART.1007	6.50
AS895 Mounting Pkg	US10	ASPART.1008	6.50
AS895 Mounting Pkg	US10B	ASPART.1009	6.50
AS895 Mounting Pkg	US26, US26D	ASPART.1010	6.50
AS895 Security Mounting Pkg	-	ASPART.1011	13.00
<b>CBI</b>			
CBI Roller & Pin Pkg	-	CBPART.1001	6.50
CBI Mounting Pkg	US3, US4	CBPART.1002	16.70
CBI Mounting Pkg	US10	CBPART.1003	16.70
CBI Mounting Pkg	US10B	CBPART.1004	16.70
CBI Mounting Pkg	USP, US26, US26D	CBPART.1005	16.70
CBI Mounting Pkg	SPBLK	CBPART.1006	16.70
CBI Security Mounting Pkg	-	CBPART.1007	9.80
<b>CL11</b>			
CL11 Mounting Pkg	US3, US4	CLPART.1001	8.20
CL11 Mounting Pkg	US10	CLPART.1002	8.20
CL11 Mounting Pkg	US26D	CLPART.1003	8.20
CL11 Hook Pkg	US3	CLPART.1004	19.60
CL11 Hook Pkg	US4	CLPART.1005	16.70
CL11 Hook Pkg	US10	CLPART.1006	16.70
CL11 Hook Pkg	US26D	CLPART.1007	16.70
CL11 Security Mounting Pkg	-	CLPART.1008	16.70
<b>CL12</b>			
CL12 Mounting Pkg	US3, US4	CLPART.1009	8.20
CL12 Mounting Pkg	US10	CLPART.1010	8.20
CL12 Mounting Pkg	US26D	CLPART.1011	8.20
CL12 Hook Pkg	US3	CLPART.1012	19.60
CL12 Hook Pkg	US4	CLPART.1013	16.70
CL12 Hook Pkg	US10	CLPART.1014	16.70
CL12 Hook Pkg	US26D	CLPART.1015	16.70
CL12 Security Mounting Pkg	-	CLPART.1016	19.60
<b>CL14</b>			
CL14 Mounting Pkg	US3, US4	CLPART.1017	4.90
CL14 Mounting Pkg	US10	CLPART.1018	4.90
CL14 Mounting Pkg	US26D	CLPART.1019	4.90
CL14 Security Mounting Pkg	-	CLPART.1020	6.50
<b>CL21</b>			
CL21 Mounting Package	US26D	CLPART.1021	4.90
CL21 Hook Package	US26D	CLPART.1022	23.20
CL21 Security Mounting Package	-	CLPART.1023	6.50
<b>CL21A</b>			
CL21A Mounting Package	US3, US4	CLPART.1024	6.50
CL21A Mounting Package	US10	CLPART.1025	6.50
CL21A Mounting Package	US26, US26D	CLPART.1027	6.50
CL21A Hook Package	US3	CLPART.1028	23.20
CL21A Hook Package	US4	CLPART.1029	19.60
CL21A Hook Package	US10	CLPART.1030	19.60
CL21A Hook Package	US26	CLPART.1032	23.20
CL21A Hook Package	US26D	CLPART.1033	19.60

Contact Ives Customer Service for pricing on additional sizes and finishes

Bold pricing indicates item is in stock and available for **Fast Track** and **ProXpress**

**IVES ARCHITECTURAL HARDWARE - Parts Price List**

Description	Finish	Part No.	List Price Each
<b>CL21A (continued)</b>			
CL21A Security Mounting Package	-	CLPART.1034	\$13.00
<b>CL22</b>			
CL22 Mounting Pkg	US3, US4	CLPART.1035	6.50
CL22 Mounting Pkg	US10	CLPART.1036	6.50
CL22 Mounting Pkg	US26, US26D	CLPART.1038	6.50
CL22 Hook Pkg	US3	CLPART.1039	16.70
CL22 Hook Pkg	US4	CLPART.1040	13.00
CL22 Hook Pkg	US10	CLPART.1041	13.00
CL22 Hook Pkg	US26	CLPART.1043	16.70
CL22 Hook Pkg	US26D	CLPART.1044	13.00
CL22 Security Mounting Pkg	-	CLPART.1045	13.00
<b>COR7G/COR9G</b>			
COR7G/9G Nylon Roller & Bolt Pkg	US3,US4	CORPART.1001	24.60
COR7G/9G Nylon Roller & Bolt Pkg	US10	CORPART.1022	24.60
COR7G/9G Nylon Roller & Bolt Pkg	US10B	CORPART.1023	24.60
COR7G/9G Nylon Roller & Bolt Pkg	US26,US26D	CORPART.1024	24.60
COR7G/9G Rubber Roller & Pin Pkg	-	CORPART.1002	9.80
COR7G/9G Door Bracket Pkg	US3	CORPART.1003	29.50
COR7G/9G Door Bracket Pkg	US4	CORPART.1004	29.50
COR7G/9G Door Bracket Pkg	US10	CORPART.1005	29.50
COR7G/9G Door Bracket Pkg	US10B	CORPART.1006	29.50
COR7G/9G Door Bracket Pkg	US26	CORPART.1007	29.50
COR7G/9G Door Bracket Pkg	US26D	CORPART.1008	29.50
COR7G/9G Rub Plate Pkg	-	CORPART.1009	6.50
COR7G/9G Mounting Pkg	US3, US4	CORPART.1010	19.60
COR7G/9G Mounting Pkg	US10	CORPART.1011	19.60
COR7G/9G Mounting Pkg	US10B	CORPART.1012	19.60
COR7G/9G Mounting Pkg	US26, US26D	CORPART.1013	19.60
COR7G/9G Security Mounting Pkg	-	CORPART.1021	23.20
<b>COR32/COR42/COR52/COR60/COR72</b>			
COR32/42/52/60/72 Rub Plate (Pkg of 2)	-	CORPART.1014	11.10
COR32/42/52/60/72 Mounting Pkg	US28, US26D	CORPART.1018	11.10
COR32/42/52/60/72 Mounting Pkg	315AN	CORPART.1019	29.90
COR32/42/52/60/72 Security Mounting Pkg	-	CORPART.1020	39.70
<b>CS115</b>			
CS115/SB453/454/0454 Thru Bolt with Cap Nut Pkg (Set of 4)	US26D	09-340-626	9.50
Sex Bolt Pkg	US26D, US2C	09-351-604	17.50
<b>DP2</b>			
DP2 Plate Pkg	US3	DPPART.1001	13.00
DP2 Plate Pkg	US4	DPPART.1002	13.00
DP2 Plate Pkg	US10	DPPART.1003	13.00
DP2 Plate Pkg	US10B	DPPART.1004	13.00
DP2 Plate Pkg	US26	DPPART.1005	13.00
DP2 Plate Pkg	US26D	DPPART.1006	13.00
DP2 Mounting Pkg	US3, US4	DPPART.1007	4.90
DP2 Mounting Pkg	US10	DPPART.1008	4.90
DP2 Mounting Pkg	US10B	DPPART.1009	4.90
DP2 Mounting Pkg	US26, US26D	DPPART.1010	4.90
DP2 Security Mounting Pkg	-	DPPART.1011	6.50
<b>FB30 Series - Metal Door Automatic Flushbolt</b>			
FB30T Face Plate Pkg	US3	FBPART.1001	44.10
FB30T Face Plate Pkg	US4	FBPART.1002	44.10
FB30T Face Plate Pkg	US10	FBPART.1003	44.10
FB30T Face Plate Pkg	US10B	FBPART.1004	44.10

Contact Ives Customer Service for pricing on additional sizes and finishes

Bold pricing indicates item is in stock and available for **Fast Track** and **ProXpress**

**IVES ARCHITECTURAL HARDWARE - Parts Price List**

Description	Finish	Part No.	List Price Each
<b>FB30 Series - Metal Door Automatic Flushbolt (Continued)</b>			
FB30T Face Plate Pkg	US32	FBPART.1005	\$44.10
FB30T Face Plate Pkg	US32D	FBPART.1006	44.10
FB30T Face Plate Pkg	BLK	FBPART.1092	44.10
FB30B/50B Face Plate Pkg	US3	FBPART.1007	44.10
FB30B/50B Face Plate Pkg	US4	FBPART.1008	44.10
FB30B/50B Face Plate Pkg	US10	FBPART.1009	44.10
FB30B/50B Face Plate Pkg	US10B	FBPART.1010	44.10
FB30B/50B Face Plate Pkg	US32	FBPART.1011	44.10
FB30B/50B Face Plate Pkg	US32D	FBPART.1012	44.10
FB30B/50B Face Plate Pkg	BLK	FBPART.1093	44.10
FB30/50 Guide Pkg	-	FBPART.1013	8.20
FB30/40/50/60 Rub Plate & Shim Pkg	-	FBPART.1014	3.40
FB30/40/50B/60B Auxiliary Bolt	-	FBPART.1015	4.90
FB30/50 8 3/4" Rod & Bolt Tip Kit - 12"	-	FBPART.1016	13.00
FB30/50B Bolt Tip	-	FBPART.1017	13.00
FB30/50 8 3/4" - 12" Rod Only	-	FBPART.1018	6.50
FB30/50 7 1/2" Rod & Bolt Tip Kit - 9"	-	FBPART.1019	13.00
FB30/50 16 1/2" Rod & Bolt Tip Kit - 18"	-	FBPART.1020	13.00
FB30/50 22 1/2" Rod & Bolt Tip Kit - 24"	-	FBPART.1021	13.00
FB30/50 28 1/2" Rod & Bolt Tip Kit - 30"	-	FBPART.1022	13.00
FB30/50 34 1/2" Rod & Bolt Tip Kit - 36"	-	FBPART.1023	13.00
FB30/50 46 1/2" Rod & Bolt Tip Kit - 48"	-	FBPART.1024	13.00
FB30/40/50B/60B Strike Pkg	US3, US4	FBPART.1025	9.80
FB30/40/50B/60B Strike Pkg	US10	FBPART.1026	9.80
FB30/40/50B/60B Strike Pkg	US10B	FBPART.1027	9.80
FB30/40/50B/60B Strike Pkg	US32, US32D	FBPART.1028	9.80
FB30/40/50B/60B Strike Pkg	BLK	FBPART.1094	9.80
FB30/50 Mounting Pkg	US3, US4	FBPART.1029	23.20
FB30/50 Mounting Pkg	US10	FBPART.1030	23.20
FB30/50 Mounting Pkg	US10B	FBPART.1031	23.20
FB30/50 Mounting Pkg	US32, US32D	FBPART.1032	23.20
FB30/50 Mounting Pkg	BLK	FBPART.1095	23.20
FB30/50 Security Mounting Pkg	-	FBPART.1033	39.30
FB32/42/52/62 AFL Plug/Screw Pkg	-	FBPART.1034	5.80
FB32/42/52/62 Auxiliary Fire Latch	-	FBPART.1035	139.50
FB30/50 Retrofit Pkg	-	FBPART.1065	11.10
FB30/40/50/60 Face Plate Screws, Pkg 10	US3, US4	FBPART.1066	7.20
FB30/40/50/60 Face Plate Screws, Pkg 10	US10	FBPART.1067	7.20
FB30/40/50/60 Face Plate Screws, Pkg 10	US10B	FBPART.1068	7.20
FB30/40/50/60 Face Plate Screws, Pkg 10	US32, US32D	FBPART.1069	7.20
FB30/40/50/60 Face Plate Screws, Pkg 10	BLK	FBPART.1101	7.20
<b>FB40 Series - Wood Door Automatic Flushbolt</b>			
FB40T Face Plate Pkg	US3	FBPART.1036	44.10
FB40T Face Plate Pkg	US4	FBPART.1037	44.10
FB40T Face Plate Pkg	US10	FBPART.1038	44.10
FB40T Face Plate Pkg	US10B	FBPART.1039	44.10
FB40T Face Plate Pkg	US32	FBPART.1040	44.10
FB40T Face Plate Pkg	US32D	FBPART.1041	44.10
FB40T Face Plate Pkg	BLK	FBPART.1097	44.10
FB40B/60B Face Plate Pkg	US3	FBPART.1042	44.10
FB40B/60B Face Plate Pkg	US4	FBPART.1043	44.10
FB40B/60B Face Plate Pkg	US10	FBPART.1044	44.10
FB40B/60B Face Plate Pkg	US10B	FBPART.1045	44.10

Contact Ives Customer Service for pricing on additional sizes and finishes

Bold pricing indicates item is in stock and available for **Fast Track** and **ProXpress**

**IVES ARCHITECTURAL HARDWARE - Parts Price List**

Description	Finish	Part No.	List Price Each
<b>FB40 Series - Wood Door Automatic Flushbolt (Continued)</b>			
FB40B/60B Face Plate Pkg	US32	FBPART.1046	44.10
FB40B/60B Face Plate Pkg	US32D	FBPART.1047	44.10
FB40T Face Plate Pkg	BLK	FBPART.1097	44.10
FB30/40/50/60 Rub Plate & Shim Pkg	-	FBPART.1014	3.40
FB40/60 Guide Pkg	-	FBPART.1048	9.80
FB40/60 Cover	-	FBPART.1049	6.50
FB30/40/50B/60B Auxiliary Bolt	-	FBPART.1015	4.90
FB40/60B Rod & Bolt Tip Kit	-	FBPART.1050	9.80
FB40/60B Bolt Tip	-	FBPART.1051	4.90
FB40/60 Rod - 2 1/2"	-	FBPART.1052	4.90
FB30/40/50B/60B Strike Pkg	US3, US4	FBPART.1025	9.80
FB30/40/50B/60B Strike Pkg	US10	FBPART.1026	9.80
FB30/40/50B/60B Strike Pkg	US10B	FBPART.1027	9.80
FB30/40/50B/60B Strike Pkg	US32, US32D	FBPART.1028	9.80
FB30/40/50B/60B Strike Pkg	BLK	FBPART.1094	9.80
FB40/60 Mounting Pkg	US3, US4	FBPART.1053	23.20
FB40/60 Mounting Pkg	US10	FBPART.1054	23.20
FB40/60 Mounting Pkg	US10B	FBPART.1055	23.20
FB40/60 Mounting Pkg	US32, US32D	FBPART.1056	23.20
FB40/60 Mounting Pkg		FBPART.1099	23.20
FB40/60 Security Mounting Pkg	-	FBPART.1057	36.20
FB32/42/52/62 AFL Plug/Screw Pkg	-	FBPART.1034	5.80
FB32/42/52/62 Auxiliary Fire Latch	-	FBPART.1035	139.50
FB30/40/50/60 Face Plate Screws. Pkg 10	US3, US4	FBPART.1066	7.20
FB30/40/50/60 Face Plate Screws. Pkg 10	US10	FBPART.1067	7.20
FB30/40/50/60 Face Plate Screws. Pkg 10	US10B	FBPART.1068	7.20
FB30/40/50/60 Face Plate Screws. Pkg 10	US32, US32D	FBPART.1069	7.20
FB30/40/50/60 Face Plate Screws. Pkg 10	BLK	FBPART.1101	7.20
<b>FB50 Series - Metal Door Constant Latching Flushbolt</b>			
FB50T Face Plate Pkg	US3	FBPART.1058	44.10
FB50T Face Plate Pkg	US4	FBPART.1059	44.10
FB50T Face Plate Pkg	US10	FBPART.1060	44.10
FB50T Face Plate Pkg	US10B	FBPART.1061	44.10
FB50T Face Plate Pkg	US32	FBPART.1062	44.10
FB50T Face Plate Pkg	US32D	FBPART.1063	44.10
FB50T Face Plate Pkg	BLK	FBPART.1100	44.10
FB30B/50B Face Plate Pkg	US3	FBPART.1007	44.10
FB30B/50B Face Plate Pkg	US4	FBPART.1008	44.10
FB30B/50B Face Plate Pkg	US10	FBPART.1009	44.10
FB30B/50B Face Plate Pkg	US10B	FBPART.1010	44.10
FB30B/50B Face Plate Pkg	US32	FBPART.1011	44.10
FB30B/50B Face Plate Pkg	US32D	FBPART.1012	44.10
FB30B/50B Face Plate Pkg	BLK	FBPART.1093	44.10
FB30/50 Guide Pkg	-	FBPART.1013	8.20
FB30/40/50/60 Rub Plate & Shim Pkg	-	FBPART.1014	3.40
FB30/40/50B/60B Auxiliary Bolt	-	FBPART.1015	4.90
FB50T/60T Auxiliary Bolt	-	FBPART.1070	9.80
FB50T Rod & Bolt Tip Kit - 12"	-	FBPART.1071	14.60
FB50T Bolt Tip	-	FBPART.1072	8.20
FB30/50 8 3/4" Rod & Bolt Tip Kit - 12"	-	FBPART.1016	13.00
FB30/50B Bolt Tip	-	FBPART.1017	13.00
FB30/50 8 3/4" - 12" Rod Only	-	FBPART.1018	6.50
FB30/50 7 1/2" Rod & Bolt Tip Kit - 9"	-	FBPART.1019	13.00

Contact Ives Customer Service for pricing on additional sizes and finishes

Bold pricing indicates item is in stock and available for **Fast Track** and **ProXpress**

**IVES ARCHITECTURAL HARDWARE - Parts Price List**

Description	Finish	Part No.	List Price Each
<b>FB50 Series - Metal Door Constant Latching Flushbolt (Continued)</b>			
FB30/50 16 1/2" Rod & Bolt Tip Kit - 18"	-	FBPART.1020	13.00
FB30/50 22 1/2" Rod & Bolt Tip Kit - 24"	-	FBPART.1021	13.00
FB30/50 28 1/2" Rod & Bolt Tip Kit - 30"	-	FBPART.1022	13.00
FB30/50 34 1/2" Rod & Bolt Tip Kit - 36"	-	FBPART.1023	13.00
FB30/50 46 1/2" Rod & Bolt Tip Kit - 48"	-	FBPART.1024	13.00
FB30/40/50B/60B Strike Pkg	US3, US4	FBPART.1025	9.80
FB30/40/50B/60B Strike Pkg	US10	FBPART.1026	9.80
FB30/40/50B/60B Strike Pkg	US10B	FBPART.1027	9.80
FB30/40/50B/60B Strike Pkg	US32, US32D	FBPART.1028	9.80
FB30/40/50B/60B Strike Pkg	BLK	FBPART.1094	9.80
FB30/50 Mounting Pkg	US3, US4	FBPART.1029	23.20
FB30/50 Mounting Pkg	US10	FBPART.1030	23.20
FB30/50 Mounting Pkg	US10B	FBPART.1031	23.20
FB30/50 Mounting Pkg	US32, US32D	FBPART.1032	23.20
FB30/50 Mounting Pkg	BLK	FBPART.1095	23.20
FB30/50 Security Mounting Pkg	-	FBPART.1033	39.30
FB50T/60T Top Strike Pkg	US3	FBPART.1073	27.70
FB50T/60T Top Strike Pkg	US4	FBPART.1074	27.70
FB50T/60T Top Strike Pkg	US10	FBPART.1075	27.70
FB50T/60T Top Strike Pkg	US10B	FBPART.1076	27.70
FB50T/60T Top Strike Pkg	US32, US32D	FBPART.1077	27.70
FB50T/60T Top Strike Pkg	BLK	FBPART.1102	27.70
FB32/42/52/62 AFL Plug/Screw Pkg	-	FBPART.1034	5.80
FB32/42/52/62 Auxiliary Fire Latch	-	FBPART.1035	139.50
FB30/50 Retrofit Plate Pkg	-	FBPART.1065	11.10
FB30/40/50/60 Face Plate Screws. Pkg 10	US3, US4	FBPART.1066	7.20
FB30/40/50/60 Face Plate Screws. Pkg 10	US10	FBPART.1067	7.20
FB30/40/50/60 Face Plate Screws. Pkg 10	US10B	FBPART.1068	7.20
FB30/40/50/60 Face Plate Screws. Pkg 10	US32, US32D	FBPART.1069	7.20
FB30/40/50/60 Face Plate Screws. Pkg 10	BLK	FBPART.1101	7.20
<b>FB60 Series - Wood Door Constant Latching Flushbolt</b>			
FB60T Face Plate Pkg	US3	FBPART.1078	44.10
FB60T Face Plate Pkg	US4	FBPART.1079	44.10
FB60T Face Plate Pkg	US10	FBPART.1080	44.10
FB60T Face Plate Pkg	US10B	FBPART.1081	44.10
FB60T Face Plate Pkg	US32	FBPART.1082	44.10
FB60T Face Plate Pkg	US32D	FBPART.1083	44.10
FB60T Face Plate Pkg	BLK	FBPART.1103	44.10
FB40B/60B Face Plate Pkg	US3	FBPART.1042	44.10
FB40B/60B Face Plate Pkg	US4	FBPART.1043	44.10
FB40B/60B Face Plate Pkg	US10	FBPART.1044	44.10
FB40B/60B Face Plate Pkg	US10B	FBPART.1045	44.10
FB40B/60B Face Plate Pkg	US32	FBPART.1046	44.10
FB40B/60B Face Plate Pkg	US32D	FBPART.1047	44.10
FB40B/60B Face Plate Pkg	BLK	FBPART.1098	44.10
FB30/40/50/60 Rub Plate & Shim Pkg	-	FBPART.1014	3.40
FB40/60 Guide Pkg	-	FBPART.1048	9.80
FB40/60 Cover	-	FBPART.1049	6.50
FB30/40/50B/60B Auxiliary Bolt	-	FBPART.1015	4.90
FB50T/60T Auxiliary Bolt	-	FBPART.1070	9.80
FB60T Rod & Bolt Tip Kit	-	FBPART.1090	13.00
FB60T Bolt Tip	-	FBPART.1091	8.20
FB40/60B Rod & Bolt Tip Kit	-	FBPART.1050	9.80

Contact Ives Customer Service for pricing on additional sizes and finishes

Bold pricing indicates item is in stock and available for **Fast Track** and **ProXpress**



**IVES ARCHITECTURAL HARDWARE - Parts Price List**

Description	Finish	Part No.	List Price Each
<b>FB60 Series - Wood Door Constant Latching Flushbolt (Continued)</b>			
FB40/60B Bolt Tip	-	FBPART.1051	4.90
FB40/60 Rod - 2 1/2"	-	FBPART.1052	4.90
FB30/40/50B/60B Strike Pkg	US3, US4	FBPART.1025	9.80
FB30/40/50B/60B Strike Pkg	US10	FBPART.1026	9.80
FB30/40/50B/60B Strike Pkg	US10B	FBPART.1027	9.80
FB30/40/50B/60B Strike Pkg	US32, US32D	FBPART.1028	9.80
FB30/40/50B/60B Strike Pkg	BLK	FBPART.1094	9.80
FB40/60 Mounting Pkg	US3, US4	FBPART.1053	23.20
FB40/60 Mounting Pkg	US10	FBPART.1054	23.20
FB40/60 Mounting Pkg	US10B	FBPART.1055	23.20
FB40/60 Mounting Pkg	US32, US32D	FBPART.1056	23.20
FB40/60 Mounting Pkg	BLK	FBPART.1099	23.20
FB40/60 Security Mounting Pkg	-	FBPART.1057	36.20
FB50T/60T Top Strike Pkg	US3	FBPART.1073	27.70
FB50T/60T Top Strike Pkg	US4	FBPART.1074	27.70
FB50T/60T Top Strike Pkg	US10	FBPART.1075	27.70
FB50T/60T Top Strike Pkg	US10B	FBPART.1076	27.70
FB50T/60T Top Strike Pkg	US32, US32D	FBPART.1077	27.70
FB50T/60T Top Strike Pkg	BLK	FBPART.1102	27.70
FB32/42/52/62 AFL Plug/Screw Pkg	-	FBPART.1034	5.80
FB32/42/52/62 Auxiliary Fire Latch	-	FBPART.1035	139.50
FB30/40/50/60 Face Plate Screws. Pkg 10	US3, US4	FBPART.1066	7.20
FB30/40/50/60 Face Plate Screws. Pkg 10	US10	FBPART.1067	7.20
FB30/40/50/60 Face Plate Screws. Pkg 10	US10B	FBPART.1068	7.20
FB30/40/50/60 Face Plate Screws. Pkg 10	US32, US32D	FBPART.1069	7.20
FB30/40/50/60 Face Plate Screws. Pkg 10	BLK	FBPART.1101	7.20
<b>FB457//FB458 Metal Door Manual Flushbolt</b>			
Guide	-	09-135	2.50
Bolt Tip	-	09-176-604	5.70
Rod - 18"	-	09-161	6.80
Rod - 24"	-	09-162	6.80
Rod - 36"	-	09-172	6.80
Rod - 48"	-	09-173	6.80
<b>FS9</b>			
FS9 Hook Pkg	US3	FSPART.1001	57.40
FS9 Hook Pkg	US4	FSPART.1002	57.40
FS9 Hook Pkg	US10	FSPART.1003	57.40
FS9 Hook Pkg	US10B	FSPART.1004	49.30
FS9 Hook Pkg	US26	FSPART.1005	57.40
FS9 Hook Pkg	US26D	FSPART.1006	49.30
FS9 Mounting Pkg	US3, US4	FSPART.1007	6.50
FS9 Mounting Pkg	US10	FSPART.1008	6.50
FS9 Mounting Pkg	US10B	FSPART.1009	6.50
FS9 Mounting Pkg	US26, US26D	FSPART.1010	6.50
FS9 Security Mounting Pkg	-	FSPART.1011	9.80
FS9 Stud & Lead Anchor Pkg	-	FSPART.1012	9.80
<b>FS13/FS17</b>			
FS13/17 Rubber (Pkg of 6)	-	FSPART.1013	19.60
FS13/17 Mounting Pkg	US3, US4	FSPART.1014	3.40
FS13/17 Mounting Pkg	US10	FSPART.1015	3.40
FS13/17 Mounting Pkg	US10B	FSPART.1016	3.40
FS13/17 Mounting Pkg	US26, US26D	FSPART.1017	3.40

Contact Ives Customer Service for pricing on additional sizes and finishes

Bold pricing indicates item is in stock and available for **Fast Track** and **ProXpress**

**IVES ARCHITECTURAL HARDWARE - Parts Price List**

Description	Finish	Part No.	List Price Each
FS13/17 Security Mounting Pkg	-	FSPART.1018	3.40
<b>FS40/FS41/FS42/FS43</b>			
FS40 Strike Pkg	US3	FSPART.1019	34.50
FS40 Strike Pkg	US4	FSPART.1020	32.90
FS40 Strike Pkg	US10	FSPART.1021	32.90
FS40 Strike Pkg	US10B	FSPART.1022	41.10
FS40 Strike Pkg	US26	FSPART.1023	34.50
FS40 Strike Pkg	US26D	FSPART.1024	32.90
FS41 Strike Pkg	US3	FSPART.1034	34.50
FS41 Strike Pkg	US4	FSPART.1035	32.90
FS41 Strike Pkg	US10	FSPART.1036	32.90
FS41 Strike Pkg	US10B	FSPART.1037	41.10
FS41 Strike Pkg	US26	FSPART.1038	34.50
FS41 Strike Pkg	US26D	FSPART.1039	32.90
FS42 Strike Pkg	US3	FSPART.1040	34.50
FS42 Strike Pkg	US4	FSPART.1041	32.90
FS42 Strike Pkg	US10	FSPART.1042	32.90
FS42 Strike Pkg	US10B	FSPART.1043	41.10
FS42 Strike Pkg	US26	FSPART.1044	34.50
FS42 Strike Pkg	US26D	FSPART.1045	32.90
FS43 Strike Pkg	US3	FSPART.1046	34.50
FS43 Strike Pkg	US4	FSPART.1047	32.90
FS43 Strike Pkg	US10	FSPART.1048	32.90
FS43 Strike Pkg	US10B	FSPART.1049	41.10
FS43 Strike Pkg	US26	FSPART.1050	34.50
FS43 Strike Pkg	US26D	FSPART.1051	32.90
FS40/41/42/43 Strike Mounting Pkg	US3, US4	FSPART.1025	6.50
FS40/41/42/43 Strike Mounting Pkg	US10	FSPART.1026	6.50
FS40/41/42/43 Strike Mounting Pkg	US10B	FSPART.1027	6.50
FS40/41/42/43 Strike Mounting Pkg	US26, US26D	FSPART.1028	6.50
FS40/41/42/43 Body Mounting Pkg	US3, US4	FSPART.1029	6.50
FS40/41/42/43 Body Mounting Pkg	US10	FSPART.1030	6.50
FS40/41/42/43 Body Mounting Pkg	US10B	FSPART.1031	6.50
FS40/41/42/43 Body Mounting Pkg	US26, US26D	FSPART.1032	6.50
FS40/41/42/43 Security Mounting Pkg	-	FSPART.1033	23.20
<b>FS434</b>			
FS434 Rubber	-	09-318	4.70
<b>FS441</b>			
FS441/442/451 Rubber	-	09-315	2.50
<b>FS442</b>			
FS441/442/451 Rubber	-	09-315	2.50
<b>FS444/FS446/FS448/FS450</b>			
Rubber Tip, order in quantities of 100	-	09-316	2.50
<b>FS451</b>			
FS441/442/451 Rubber	-	09-315	2.50
<b>FS452</b>			
FS452/455	Rubber (Order in quantities of 100, Price per package of 100)	HRT (FSPART.1075)	<b>137.40</b>
<b>FS455</b>			
FS452/455	Rubber (Order in quantities of 100, Price per package of 100)	HRT (FSPART.1075)	<b>137.40</b>
<b>FS544/FS555</b>			
FS544/555 Rubber - Threaded (Pkg of 6)	-	FSPART.1052	19.60
FS544/555 Mounting Pkg	SP4	FSPART.1054	4.90

Contact Ives Customer Service for pricing on additional sizes and finishes

Bold pricing indicates item is in stock and available for **Fast Track** and **ProXpress**

## IVES ARCHITECTURAL HARDWARE - Parts Price List

Description	Finish	Part No.	List Price Each
<b>FS544/FS555 (continued)</b>			
FS544/555 Mounting Pkg	SP10	FSPART.1055	4.90
FS544/555 Mounting Pkg	SP313	FSPART.1056	4.90
FS544/555 Mounting Pkg	SP28	FSPART.1057	4.90
FS544/555 Mounting Pkg	SPBLK	FSPART.1058	4.90
FS544/555 Security Mounting Pkg	-	FSPART.1059	13.00
FS544/555 Rubber with Screw	-	FSPART.1074	3.40
<b>FS1153</b>			
FS1153 Rubber Pkg	-	FSPART.1060	3.40
FS1153 Mounting Pkg	US28	FSPART.1061	3.40
FS1153 Security Mounting Pkg	-	FSPART.1062	6.50
<b>FS1154</b>			
FS1154 Rubber Pkg	-	FSPART.1063	3.40
FS1154 Mounting Pkg	US3, US4	FSPART.1064	4.90
FS1154 Mounting Pkg	US10	FSPART.1065	4.90
FS1154 Mounting Pkg	US10B	FSPART.1066	4.90
FS1154 Mounting Pkg	US26, US26D	FSPART.1067	4.90
FS1154 Security Mounting Pkg	-	FSPART.1068	9.80
<b>LGI</b>			
LGI/7 Mounting Pkg	US32D, US2G	LGPART.1001	6.50
LGI/7 Mounting Pkg	USP	LGPART.1002	16.70
LGI/7 Mounting Pkg	US4	LGPART.1003	16.70
LGI/7 Mounting Pkg	US10	LGPART.1004	16.70
LGI/7 Mounting Pkg	SP313	LGPART.1005	16.70
<b>LG7</b>			
LGI/7 Mounting Pkg	US32D	LGPART.1001	6.50
<b>LG10</b>			
LG10/12/14 Mounting Pkg	US32D, USP	LGPART.1007	4.90
LG10/12/14 Security Mounting Pkg	-	LGPART.1008	13.00
<b>LG11</b>			
LG11/13 Mounting Pkg	US32D, SP313	LGPART.1009	4.90
LG11/13 Security Mounting Pkg	-	LGPART.1010	6.50
<b>LG12</b>			
LG10/12/14 Mounting Pkg	US32D, USP	LGPART.1007	4.90
LG10/12/14 Security Mounting Pkg	-	LGPART.1008	13.00
<b>LG13</b>			
LG11/13 Mounting Pkg	US32D, SP313	LGPART.1009	4.90
LG11/13 Security Mounting Pkg	-	LGPART.1010	6.50
<b>LG14</b>			
LG10/12/14 Mounting Pkg	US32D	LGPART.1007	4.90
LG10/12/14 Security Mounting Pkg	-	LGPART.1008	13.00
<b>MB1F/MB2F/MB3F/MB1V/MB2V/MB3V</b>			
MB1/2 AL Mounting Pkg	SPBLK	MBPART.1006	13.00
MB1/2 AL Security Mounting Pkg	-	MBPART.1007	13.00
MB1F/2F/3F/1V/2V/3V STL Mounting Pkg	SP28, USP	MBPART.1011	13.00
MB1F/2F/3F/1V/2V/3V STL Mounting Pkg	SPBLK	MBPART.1013	13.00
MB1F/2F/3F/1V/2V/3V STL Security Mtg Pkg	-	MBPART.1014	13.00
<b>RB470/RB471/RB472</b>			
RB470/471/472 Roller, Bushing & Rivet Pkg	US15, US26D	09-137-626	6.50
<b>RL30</b>			
RL30 Standard Strike Mtg Pkg	US3, US4	RLPART.1001	6.50
RL30 Standard Strike Mtg Pkg	US10	RLPART.1002	6.50
RL30 Standard Strike Mtg Pkg	US10B	RLPART.1003	6.50

Contact Ives Customer Service for pricing on additional sizes and finishes

Bold pricing indicates item is in stock and available for **Fast Track** and **ProXpress**

**IVES ARCHITECTURAL HARDWARE - Parts Price List**

Description	Finish	Part No.	List Price Each
<b>RL30 (Continued)</b>			
RL30 Standard Strike Mtg Pkg	US26, US26D	RLPART.1004	6.50
RL30 ASA Strike Mtg Pkg	US3, US4	RLPART.1005	9.80
RL30 ASA Strike Mtg Pkg	US10	RLPART.1006	9.80
RL30 ASA Strike Mtg Pkg	US10B	RLPART.1007	9.80
RL30 ASA Strike Mtg Pkg	US26, US26D	RLPART.1008	9.80
RL30 Standard Strike Security Mtg Pkg	-	RLPART.1009	13.00
RL30 ASA Strike Security Mtg Pkg	-	RLPART.1010	13.00
RL30 Strike Pkg	US3	RLPART.1011	19.60
RL30 Strike Pkg	US4	RLPART.1012	19.60
RL30 Strike Pkg	US10	RLPART.1013	19.60
RL30 Strike Pkg	US10B	RLPART.1014	19.60
RL30 Strike Pkg	US26	RLPART.1015	19.60
RL30 Strike Pkg	US26D	RLPART.1016	19.60
RL30/32/36 ASA Strike Pkg	US3	RLPART.1017	19.60
RL30/32/36 ASA Strike Pkg	US4	RLPART.1018	19.60
RL30/32/36 ASA Strike Pkg	US10	RLPART.1019	19.60
RL30/32/36 ASA Strike Pkg	US10B	RLPART.1020	19.60
RL30/32/36 ASA Strike Pkg	US26	RLPART.1021	19.60
RL30/32/36 ASA Strike Pkg	US26D	RLPART.1022	19.60
RL30/1152 Rubber Roller, Silencers & Pin Pkg	-	RLPART.1023	13.00
RL30/1152 Nylon Coated Brass Roller & Pin Pkg	-	RLPART.1024	13.00
RL30/1152 Nylon Roller & Pin Pkg	-	RLPART.1025	11.40
RL30/1152 Roller Pin	-	RLPART.1026	3.40
RL30/1152 Nylon Silencers (Pkg of 2)	-	RLPART.1027	1.40
<b>RL32</b>			
RL32/36 Standard Strike Mtg Pkg	US3, US4	RLPART.1028	6.50
RL32/36 Standard Strike Mtg Pkg	US10	RLPART.1029	6.50
RL32/36 Standard Strike Mtg Pkg	US10B	RLPART.1030	6.50
RL32/36 Standard Strike Mtg Pkg	US32, US32D	RLPART.1031	6.50
RL32/36 ASA Strike Mtg Pkg	US3, US4	RLPART.1032	9.80
RL32/36 ASA Strike Mtg Pkg	US10	RLPART.1033	9.80
RL32/36 ASA Strike Mtg Pkg	US10B	RLPART.1034	9.80
RL32/36 ASA Strike Mtg Pkg	US32, US32D	RLPART.1035	9.80
RL32/36 Standard Strike Security Mtg Pkg	-	RLPART.1036	13.00
RL32/36 ASA Strike Security Mtg Pkg	-	RLPART.1037	13.00
RL32/36 Strike Pkg	US3	RLPART.1038	19.60
RL32/36 Strike Pkg	US4	RLPART.1039	19.60
RL32/36 Strike Pkg	US10	RLPART.1040	19.60
RL32/36 Strike Pkg	US10B	RLPART.1041	19.60
RL32/36 Strike Pkg	US32	RLPART.1042	19.60
RL32/36 Strike Pkg	US32D	RLPART.1043	19.60
RL30/32/36 ASA Strike Pkg	US3	RLPART.1017	19.60
RL30/32/36 ASA Strike Pkg	US4	RLPART.1018	19.60
RL30/32/36 ASA Strike Pkg	US10	RLPART.1019	19.60
RL30/32/36 ASA Strike Pkg	US10B	RLPART.1020	19.60
RL30/32/36 ASA Strike Pkg	US26	RLPART.1021	19.60
RL30/32/36 ASA Strike Pkg	US26D	RLPART.1022	19.60
RL32 Nylon Roller & Pin Pkg	-	RLPART.1045	11.40
RL32 Roller Pin	-	RLPART.1046	3.40
<b>RL36</b>			
RL32/36 Standard Strike Mtg Pkg	US32D	RLPART.1031	6.50
RL32/36 ASA Strike Mtg Pkg	US32D	RLPART.1035	9.80
RL32/36 Standard Strike Security Mtg Pkg	-	RLPART.1036	13.00

Contact Ives Customer Service for pricing on additional sizes and finishes

Bold pricing indicates item is in stock and available for **Fast Track** and **ProXpress**

**IVES ARCHITECTURAL HARDWARE - Parts Price List**

Description	Finish	Part No.	List Price Each
<b>RL36 (Continued)</b>			
RL32/36 ASA Strike Security Mtg Pkg	-	RLPART.1037	\$13.00
RL32/36 Strike Pkg	US32D	RLPART.1043	19.60
RL30/32/36 ASA Strike Pkg	US26D	RLPART.1022	19.60
<b>RL38</b>			
RL38 Mounting Pkg	US32D	RLPART.1051	6.50
RL38 Security Mtg Pkg	-	RLPART.1053	13.00
<b>RL1152</b>			
RL1152 Mounting Pkg	US3, US4	RLPART.1054	6.50
RL1152 Mounting Pkg	US10	RLPART.1055	6.50
RL1152 Mounting Pkg	US10B	RLPART.1056	6.50
RL1152 Mounting Pkg	US26, US26D	RLPART.1057	6.50
RL1152 Security Mounting Pkg	-	RLPART.1058	13.00
RL1152 Strike Pkg	US3	RLPART.1059	19.60
RL1152 Strike Pkg	US4	RLPART.1060	19.60
RL1152 Strike Pkg	US10	RLPART.1061	19.60
RL1152 Strike Pkg	US10B	RLPART.1062	19.60
RL1152 Strike Pkg	US26	RLPART.1063	19.60
RL1152 Strike Pkg	US26D	RLPART.1064	19.60
RL30/1152 Rubber Roller, Silencers & Pin Pkg	-	RLPART.1023	13.00
RL30/1152 Brass Roller & Pin Pkg	-	RLPART.1024	13.00
RL30/1152 Nylon Roller & Pin Pkg	-	RLPART.1025	11.40
RL30/1152 Roller Pin	-	RLPART.1026	3.40
RL30/1152 Nylon Silencers (Pkg of 2)	-	RLPART.1027	1.40
<b>SB360</b>			
SB360 Mortise Strike Pkg	US2C	09-82-604	27.30
SB360 Sex Bolt Package (Set of 4)	US2C	09-350-604	22.40
<b>SB453</b>			
Thru Bolt with Cap Nut Pkg (Set of 4)	US26D, US2C	09-340-626	9.50
Sex Bolt Pkg	US26D, US2C	09-351-604	17.50
<b>SB1630/SB1640/SB1600M1/SB1600M2</b>			
SB1600 Top Strike Pkg	US2G	SBPART.1001	18.00
SB1600 Top Strike Pkg	US3	SBPART.1002	31.10
SB1600 Top Strike Pkg	US10B, SP313	SBPART.1003	31.10
SB1600 Top Strike Pkg	US26D, SP28	SBPART.1004	21.30
SB1600 Top Strike Pkg	SP4	SBPART.1015	31.10
SB1600 Top Strike Pkg	SP10	SBPART.1016	31.10
SB1600 Top Strike Pkg	SPBLK	SBPART.1019	31.10
SB1600 Bottom Strike Pkg	US2G	SBPART.1005	13.00
SB1600 Bottom Strike Pkg	US3	SBPART.1006	26.50
SB1600 Bottom Strike Pkg	US10B, SP313	SBPART.1007	26.50
SB1600 Bottom Strike Pkg	US26D, SP28	SBPART.1008	16.70
SB1600 Bottom Strike Pkg	SP4	SBPART.1020	26.50
SB1600 Bottom Strike Pkg	SP10	SBPART.1021	26.50
SB1600 Bottom Strike Pkg	SPBLK	SBPART.1024	26.50
SB1600 Bolt Mounting Pkg	-	SBPART.1009	6.50
SB1600 End Plug & Stud Pkg	-	SBPART.1010	9.80
SB1600 Security Mounting Pkg	-	SBPART.1011	13.00
SB1600 Lock Housing Pkg	US2G	SBPART.1033	24.60
SB1600 Lock Housing Pkg	US3	SBPART.1034	41.10
SB1600 Lock Housing Pkg	US10B	SBPART.1035	41.10
SB1600 Lock Housing Pkg	US26D	SBPART.1036	32.90
SB1600 Lock Housing Pkg	SP4	SBPART.1017	41.10
SB1600 Lock Housing Pkg	SP10	SBPART.1018	41.10

Contact Ives Customer Service for pricing on additional sizes and finishes

Bold pricing indicates item is in stock and available for **Fast Track** and **ProXpress**

## IVES ARCHITECTURAL HARDWARE - Parts Price List

Description	Finish	Part No.	List Price Each
<b>SB1630/SB1640/SB1600M1/SB1600M2 (Continued)</b>			
SB1600 Lock Housing Pkg	SP313	SBPART.1023	\$41.10
SB1600 Lock Housing Pkg	SP28	SBPART.1025	41.10
SB1600 Lock Housing Pkg	SPBLK	SBPART.1022	41.10
SB1600 Lock Cylinder - 1289	-	SBPART.1037	19.60
SB1600 Lock Cylinder - 1360	-	SBPART.1038	19.60
SB1600 Lock Cylinder - 1390	-	SBPART.1039	19.60
SB1600 Lock Cylinder - 1395	-	SBPART.1040	19.60
SB1600 Sex Bolt Pkg (Set of 3)	US26D, US26G,SP28	SBPART.1012	30.40
SB1600 Sex Bolt Pkg (Set of 3)	US3	SBPART.1013	30.40
SB1600 Sex Bolt Pkg (Set of 3)	US10B,SP313	SBPART.1014	30.40
SB1600 Sex Bolt Pkg (Set of 3)	SP4	SBPART.1028	30.40
SB1600 Sex Bolt Pkg (Set of 3)	SP10	SBPART.1029	30.40
SB1600 Sex Bolt Pkg (Set of 3)	SPBLK	SBPART.1032	30.40
<b>SR64</b>			
SR64 Installation Pin	-	SRPART.1001	1.40
SR64 Installation Pin (Pkg of 10)	-	SRPART.1002	16.70
<b>VR900/VR904/VR900-LLP/VR904-LLP</b>			
VR900 Mounting Pkg	US32D	VRPART.1001	9.80
VR900/910/910M Collar Pkg	US32D	VRPART.1002	32.90
<b>VR910DT/VR914DT/VR810DT/VR814DT</b>			
VR910/910M Mounting Pkg	US32D	VRPART.1003	9.80
<b>VR910DT/VR914DT/VR810NL/VR814NL</b>			
VR910/910M Mounting Pkg	US32D	VRPART.1003	9.80
VR910/910 Cylinder Mounting Pkg	US32D	VRPART.1004	21.30
VR900/910/910M Collar Pkg	US32D	VRPART.1002	32.90
<b>VR910M-DT/ VR914-DT</b>			
VR910/910M Mounting Pkg	US32D	VRPART.1003	9.80
<b>VR910M-NL / VR914M-NL</b>			
VR910/910M Mounting Pkg	US32D	VRPART.1003	9.80
VR900/910/910M Collar Pkg	US32D	VRPART.1002	32.90
<b>WS11</b>			
WS11/11X/20/33 Rubber (Pkg of 6)	-	WSPART.1001	19.60
WS11/33 Mounting Pkg	US3, US4	WSPART.1002	4.90
WS11/33 Mounting Pkg	US10	WSPART.1003	4.90
WS11/33 Mounting Pkg	US10B	WSPART.1004	4.90
WS11/33 Mounting Pkg	US26, US26D	WSPART.1005	4.90
WS11/33 Security Mounting Pkg	-	WSPART.1006	13.00
<b>WS11X</b>			
WS11/11X/20/33 Rubber (Pkg of 6)	-	WSPART.1001	19.60
WS11X/33X Mounting Pkg	US3, US4	WSPART.1029	8.20
WS11X/33X Mounting Pkg	US10	WSPART.1030	8.20
WS11X/33X Mounting Pkg	US10B	WSPART.1031	8.20
WS11X/33X Mounting Pkg	US26, US26D	WSPART.1032	8.20
WS11X/33X Security Mounting Pkg	-	WSPART.1033	11.40
<b>WS20</b>			
WS11/11X/20/33 Rubber (Pkg of 6)	-	WSPART.1001	19.60
WS20/20X Strike Pkg	US3	WSPART.1008	16.70
WS20/20X Strike Pkg	US4	WSPART.1009	16.70
WS20/20X Strike Pkg	US10	WSPART.1010	16.70
WS20/20X Strike Pkg	US10B	WSPART.1011	16.70
WS20/20X Strike Pkg	US26	WSPART.1012	16.70
WS20/20X Strike Pkg	US26D	WSPART.1013	16.70
WS20 Mounting Pkg	US3, US4	WSPART.1014	8.20
WS20 Mounting Pkg	US10	WSPART.1015	8.20

Contact Ives Customer Service for pricing on additional sizes and finishes

Bold pricing indicates item is in stock and available for **Fast Track** and **ProXpress**



**IVES ARCHITECTURAL HARDWARE - Parts Price List**

Description	Finish	Part No.	List Price Each
<b>WS20 (Continued)</b>			
WS20 Mounting Pkg	US10B	WSPART.1016	\$8.20
WS20 Mounting Pkg	US26, US26D	WSPART.1017	8.20
WS20 Security Mounting Pkg	-	WSPART.1018	16.70
<b>WS20X</b>			
WS11/11X/20/33 Rubber (Pkg of 6)	-	WSPART.1001	19.60
WS20/20X Strike Pkg	US3	WSPART.1008	16.70
WS20/20X Strike Pkg	US4	WSPART.1009	16.70
WS20/20X Strike Pkg	US10	WSPART.1010	16.70
WS20/20X Strike Pkg	US10B	WSPART.1011	16.70
WS20/20X Strike Pkg	US26	WSPART.1012	16.70
WS20/20X Strike Pkg	US26D	WSPART.1013	16.70
WS20X Mounting Pkg	US3, US4	WSPART.1019	13.00
WS20X Mounting Pkg	US10	WSPART.1020	13.00
WS20X Mounting Pkg	US10B	WSPART.1021	13.00
WS20X Mounting Pkg	US26, US26D	WSPART.1022	13.00
WS20X Security Mounting Pkg	-	WSPART.1023	19.60
<b>WS33</b>			
WS11/11X/20/33 Rubber (Pkg of 6)	-	WSPART.1001	19.60
WS11/33 Mounting Pkg	US3, US4	WSPART.1002	4.90
WS11/33 Mounting Pkg	US10	WSPART.1003	4.90
WS11/33 Mounting Pkg	US10B	WSPART.1004	4.90
WS11/33 Mounting Pkg	US26, US26D	WSPART.1005	4.90
WS11/33 Security Mounting Pkg	-	WSPART.1006	13.00
<b>WS33X</b>			
WS11/11X/20/33 Rubber (Pkg of 6)	-	WSPART.1001	19.60
WS11X/33X Mounting Pkg	US3, US4	WSPART.1029	8.20
WS11X/33X Mounting Pkg	US10	WSPART.1030	8.20
WS11X/33X Mounting Pkg	US10B	WSPART.1031	8.20
WS11X/33X Mounting Pkg	US26, US26D	WSPART.1032	8.20
WS11X/33X Security Mounting Pkg	-	WSPART.1033	11.40
<b>WS40</b>			
WS40 Hook Pkg	US3	WSPART.1034	18.00
WS40 Hook Pkg	US4	WSPART.1035	16.70
WS40 Hook Pkg	US10	WSPART.1036	16.70
WS40 Hook Pkg	US10B	WSPART.1037	16.70
WS40 Hook Pkg	US26	WSPART.1038	18.00
WS40 Hook Pkg	US26D	WSPART.1039	16.70
WS40 Hook Pkg	US28	WSPART.1040	14.60
WS40 Mounting Pkg	US3, US4	WSPART.1041	9.80
WS40 Mounting Pkg	US10	WSPART.1042	9.80
WS40 Mounting Pkg	US10B	WSPART.1043	9.80
WS40 Mounting Pkg	US26, US26D, US28	WSPART.1044	9.80
WS40 Security Mounting Pkg	-	WSPART.1045	19.60
<b>WS45</b>			
WS45 Hook Pkg	US3	WSPART.1046	86.80
WS45 Hook Pkg	US4	WSPART.1047	82.00
WS45 Hook Pkg	US10	WSPART.1048	82.00
WS45 Hook Pkg	US10B	WSPART.1049	82.00
WS45 Hook Pkg	US26	WSPART.1050	86.80
WS45 Hook Pkg	US26D	WSPART.1051	85.20
WS45 Mounting Pkg	US3, US4	WSPART.1052	9.80
WS45 Mounting Pkg	US10	WSPART.1053	9.80

Contact Ives Customer Service for pricing on additional sizes and finishes

Bold pricing indicates item is in stock and available for **Fast Track** and **ProXpress**

**IVES ARCHITECTURAL HARDWARE - Parts Price List**

Description	Finish	Part No.	List Price Each
<b>WS45 (Continued)</b>			
WS45 Mounting Pkg	US10B	WSPART.1054	\$9.80
WS45 Mounting Pkg	US26, US26D	WSPART.1055	9.80
WS45 Security Mounting Pkg	-	WSPART.1056	24.60
<b>WS45X</b>			
WS45X Hook Pkg	US3	WSPART.1057	91.80
WS45X Hook Pkg	US4	WSPART.1058	85.20
WS45X Hook Pkg	US10	WSPART.1059	85.20
WS45X Hook Pkg	US10B	WSPART.1060	85.20
WS45X Hook Pkg	US26	WSPART.1061	91.80
WS45X Hook Pkg	US26D	WSPART.1062	91.80
WS45X Mounting Pkg	US3, US4	WSPART.1063	16.70
WS45X Mounting Pkg	US10	WSPART.1064	16.70
WS45X Mounting Pkg	US10B	WSPART.1065	16.70
WS45X Mounting Pkg	US26, US26D	WSPART.1066	16.70
WS45X Security Mounting Pkg	-	WSPART.1067	24.60
<b>WS65</b>			
60-65/70/430	RT Rubber, order in quantities of 100 (Price per package of 100)	RT (WSPART.1075)	93.30
60-65/70/430	Black Rubber Tip, order in quantities of 100 (Price per package of 100)	WSPART.1089	93.30
<b>WS436/WS438</b>			
FS13/17 Security Mounting Pkg	-	FSPART.1018	3.40
<b>WS443</b>			
Rubber Tip, order in quantities of 100	-	09-316	2.50
<b>WS445</b>			
Rubber Tip, order in quantities of 100	-	09-316	2.50
<b>WS447</b>			
Rubber Tip, order in quantities of 100	-	09-316	2.50
<b>WS449</b>			
Rubber Tip, order in quantities of 100	-	09-316	2.50
<b>S48</b>			
S48/262/265/266 Strike Pkg	B3	09-40-605	5.90
S48/262/265/266 Strike Pkg	B10B	09-40-613	5.90
S48/262/265/266 Strike Pkg	B26D	09-40-626	5.90
<b>54</b>			
054/253 Mortise Strike Pkg	B3	09-22-605	9.60
054/253 Mortise Strike Pkg	B10B	09-22-613	9.60
054/253 Mortise Strike Pkg	B26D	09-22-626	9.60
<b>060/061</b>			
060/061	SRT Rubber, order in quantities of 100 (Price per package of 100)	SRT (WSPART.1076)	43.60
<b>60</b>			
60-65/70/430	RT Rubber, order in quantities of 100 (Price per package of 100)	RT (WSPART.1075)	93.30
60-65/70/430	Black Rubber Tip, order in quantities of 100 (Price per package of 100)	WSPART.1089	93.30
<b>61</b>			
60-65/70/430	RT Rubber, order in quantities of 100 (Price per package of 100)	RT (WSPART.1075)	93.30
60-65/70/430	Black Rubber Tip, order in quantities of 100 (Price per package of 100)	WSPART.1089	93.30
<b>62</b>			
60-65/70/430	RT Rubber, order in quantities of 100 (Price per package of 100)	RT (WSPART.1075)	93.30

Contact Ives Customer Service for pricing on additional sizes and finishes

Bold pricing indicates item is in stock and available for **Fast Track** and **ProXpress**

**IVES ARCHITECTURAL HARDWARE - Parts Price List**

Description	Finish	Part No.	List Price Each
60-65/70/430	Black Rubber Tip, order in quantities of 100 (Price per package of 100)	WSPART.1089	\$93.30
<b>64</b>			
60-65/70/430	RT Rubber, order in quantities of 100 (Price per package of 100)	RT (WSPART.1075)	93.30
60-65/70/430	Black Rubber Tip, order in quantities of 100 (Price per package of 100)	WSPART.1089	93.30
<b>69</b>			
69 Rubber Tip	(Price per package of 100)	09-310	87.00
<b>70</b>			
60-65/70/430	RT Rubber, order in quantities of 100 (Price per package of 100)	RT (WSPART.1075)	93.30
60-65/70/430	Black Rubber Tip, order in quantities of 100 (Price per package of 100)	WSPART.1089	93.30
<b>72/73</b>			
60-65/70/430	RT Rubber, order in quantities of 100 (Price per package of 100)	RT (WSPART.1075)	93.30
60-65/70/430	Black Rubber Tip, order in quantities of 100 (Price per package of 100)	WSPART.1089	93.30
<b>253</b>			
Angle Strike Pkg	B3	09-33-605	21.40
Angle Strike Pkg	B10B	09-33-613	21.40
Angle Strike Pkg	B26D	09-33-626	21.40
Mortise Strike Pkg	B3	09-22-605	9.60
Mortise Strike Pkg	B10B	09-22-613	9.60
Mortise Strike Pkg	B26D	09-22-626	9.60
<b>262</b>			
S48/262/265 Strike Pkg	B3	09-40-605	5.90
S48/262/265 Strike Pkg	B10B	09-40-613	5.90
S48/262/265 Strike Pkg	B26D	09-40-626	5.90
<b>265</b>			
S48/262/265 Strike Pkg	B3	09-40-605	5.90
S48/262/265 Strike Pkg	B10B	09-40-613	5.90
S48/262/265 Strike Pkg	B26D	09-40-626	5.90
<b>335</b>			
335 Strike & Mounting Pkg	B10B	09-45-613	7.20
335 Strike & Mounting Pkg	B15	09-45-619	7.20
<b>336</b>			
336 Strike & Mounting Pkg	B3	09-47-605	7.80
336 Strike & Mounting Pkg	B10B	09-47-613	7.80
336 Strike & Mounting Pkg	B26D	09-47-626	7.80
<b>347</b>			
347 Strike & Mounting Pkg	B3	09-53-605	7.20
347 Strike & Mounting Pkg	B10B	09-53-613	7.20
347 Strike & Mounting Pkg	B15	09-53-619	7.20
347 Strike & Mounting Pkg	B26	09-53-625	7.20
347 Strike & Mounting Pkg	B26D	09-53-626	7.20
<b>349</b>			
349 Strike & Mounting Pkg	B3	09-61-605	7.20
349 Strike & Mounting Pkg	B10B	09-61-613	7.20
349 Strike & Mounting Pkg	B26D	09-61-626	7.20
353/354 Angle Strike Pkg	B26D	09-33-626	21.40
353/354 Mortise Strike Pkg	B3	09-22-605	9.60
353/354 Mortise Strike Pkg	B10B	09-22-613	9.60
353/354 Mortise Strike Pkg	B26D	09-22-626	9.60
<b>430</b>			
60-65/70/430	RT Rubber, order in quantities of 100 (Price per package of 100)	RT (WSPART.1075)	93.30

Contact Ives Customer Service for pricing on additional sizes and finishes

Bold pricing indicates item is in stock and available for **Fast Track** and **ProXpress**

**IVES ARCHITECTURAL HARDWARE - Parts Price List**

Description	Finish	Part No.	List Price Each
60-65/70/430	Black Rubber Tip, order in quantities of 100 (Price per package of 100)	WSPART.1089	\$93.30
<b>482</b>			
482 Plate	B3	09-170-605	7.80
482 Plate	B10B	09-170-613	7.80
482 Plate	B15, B26D	09-170-626	7.80
482 SHIM 1/8 IN	B15, B26D	09-576-626	17.80
482 SHIM 3/8 IN	B15, B26D	09-577-626	28.20
<b>620</b>			
Sex Bolt Package (Set of 4)	B3, B-505	09-355-605	12.30
Sex Bolt Package (Set of 4)	B10B, B-613	09-355-613	14.80
Sex Bolt Package (Set of 4)	B15, B-619, B15A, B-620	09-355-626	14.80
<b>621</b>			
Sex Bolt Package (Set of 4)	B3	09-355-605	12.30
Sex Bolt Package (Set of 4)	B10B	09-355-613	14.80
Sex Bolt Package (Set of 4)	B15, B15A, B26, B26D, PA28	09-355-626	14.80
<b>U696</b>			
696-700-701 Viewer Cover	606	890312606	2.10
696-700-701 Viewer Cover	613	890312613	2.10
696-700-701 Viewer Cover	619	890312619	2.10
696-700-701 Viewer Cover	625	890312625	2.10
696-700-701 Viewer Cover	626	890312626	2.10
696-700-701 Viewer Cover	716	890312716	2.10
696-700-701 Viewer Cover	622	890312622	2.10
696-700-701 Viewer Extension	626	890314626	3.20
View Trim Washer	B4	09-241-606	0.30
View Trim Washer	B26D	09-241-626	0.30
<b>U698</b>			
698 Viewer Cover	605	890311605	2.70
698 Viewer Cover	619	890311619	2.70
698 Viewer Cover	625	890311625	2.70
698 Viewer Cover	626	890311626	2.70
698 Viewer Cover	716	890311716	2.70
698 Viewer Cover	622	890311622	2.70
698 Viewer Extension	626	890313626	4.30
<b>700</b>			
696-700-701 Viewer Cover	606	890312606	2.10
696-700-701 Viewer Cover	613	890312613	2.10
696-700-701 Viewer Cover	619	890312619	2.10
696-700-701 Viewer Cover	625	890312625	2.10
696-700-701 Viewer Cover	626	890312626	2.10
696-700-701 Viewer Cover	716	890312716	2.10
696-700-701 Viewer Cover	622	890312622	2.10
696-700-701 Viewer Extension	626	890314626	3.20
View Trim Washer	B4	09-241-606	0.30
View Trim Washer	B10B	09-241-613	0.30
View Trim Washer	B26D	09-241-626	0.30
<b>701</b>			
696-700-701 Viewer Cover	606	890312606	2.10
696-700-701 Viewer Cover	613	890312613	2.10
696-700-701 Viewer Cover	619	890312619	2.10
696-700-701 Viewer Cover	625	890312625	2.10
696-700-701 Viewer Cover	626	890312626	2.10
696-700-701 Viewer Cover	716	890312716	2.10
696-700-701 Viewer Cover	622	890312622	2.10
696-700-701 Viewer Extension	626	890314626	3.20
View Trim Washer	B4	09-241-606	0.30
View Trim Washer	B10B	09-241-613	0.30
View Trim Washer	B26D	09-241-626	0.30
<b>8112</b>			
Screw - #8 x 1" OPHSMS (Qty 6)	B26D	PULLPART.1060	3.50

Contact Ives Customer Service for pricing on additional sizes and finishes

Bold pricing indicates item is in stock and available for **Fast Track** and **ProXpress**

**IVES ARCHITECTURAL HARDWARE - Parts Price List**

Description	Finish	Part No.	List Price Each
<b>8121 (1 3/4" Door)</b>			
Screw - #8 x 1" OPHSMS (Qty 6)	B26D	PULLPART.1060	\$3.50
8121 Screw Pkg - K Mount	B26D	09-512-618	29.90
<b>8200/8300/8302/8303/8305/8311/8400 Plate Mounting Screws</b>			
Gasket	-	KPPART.10013	23.00
Screw - #6 x 5/8" UOPHSMS (Pkg 16)	B3, B4	09-282-632	0.50
Screw - #6 x 5/8" UOPHSMS (Pkg 16)	B10	09-282-639	0.50
Screw - #6 x 5/8" UOPHSMS (Pkg 16)	B10B, B-613, BRN	09-282-640	0.50
Screw - #6 x 5/8" UOPHSMS (Pkg 16)	B15, B26, B26D, S32, S32D, PA28, CLR	09-282-630	0.50
Screw - #6 x 5/8" TEK/TORX SMS (Pkg 16)	B3, B4	KPPART.10014	12.90
Screw - #6 x 5/8" TEK/TORX SMS (Pkg 16)	B10	KPPART.10015	12.90
Screw - #6 x 5/8" TEK/TORX SMS (Pkg 16)	B10B, B-613, BRN	KPPART.10016	12.90
Screw - #6 x 5/8" TEK/TORX SMS (Pkg 16)	B15, B26, B26D, S32, S32D, PA	KPPART.10017	12.90
<b>Pull Mounting Packages for 8105, 8111, 8305, 8311, 8700, 8800</b> Also used with Old Mtg Style Pulls (Non-HD) 8102, 8103, 8103EZ, 8190, 8302, 8303, 9100 See Page 64 for which options can be used with each model.			
Standard Mount 1.3/4" Door	B3, B4	09-469-605	6.40
Standard Mount 1.3/4" Door	B10	09-469-612	6.40
Standard Mount 1.3/4" Door	B10B	09-469-613	6.40
Standard Mount 1.3/4" Door	B15, B26, B26D, PA28, S32, S32D	09-469-603	6.40
Standard Mount 2" Door	B3, B4	PULLPART.1001	6.40
Standard Mount 2" Door	B10	PULLPART.1002	6.40
Standard Mount 2" Door	B10B	PULLPART.1003	6.40
Standard Mount 2" Door	B15, B26, B26D, PA28, S32, S32D	PULLPART.1004	6.40
F Mount 1.3/4" Door	-	09-464-603	3.50
F Mount 2" Door	-	PULLPART.1005	3.50
F Mount 2 1/4" Door	-	PULLPART.1006	3.50
G Mount	-	09-509-603	3.50
H / I / L Mount (combined pack)	-	09-510-603	38.20
J / N Mount (combined pack) 1.3/4" Door	-	09-508-603	13.30
J / N Mount (combined pack) 2" - 2 1/4" Door	-	09-294-603	13.30
M Mount 1 3/4" - 2" Door	B3	09-521-605	25.40
M Mount 1 3/4" - 2" Door	B4	09-521-606	25.40
M Mount 1 3/4" - 2" Door	B10	09-521-612	25.40
M Mount 1 3/4" - 2" Door	B10B	09-521-613	25.40
M Mount 1 3/4" - 2" Door	B26	09-521-625	25.40
M Mount 1 3/4" - 2" Door	B26D	09-521-626	25.40
M Mount 1 3/4" - 2" Door	S32	09-521-629	25.40
M Mount 1 3/4" - 2" Door	S32D	09-521-630	25.40
M Mount 1 3/4" - 2" Door	B15	09-521-619	25.40
M Mount 2 1/4" Door	S32D	PULLPART.1007	51.90
M Mount 2 1/4" Door	B3	PULLPART.1008	51.90
M Mount 2 1/4" Door	B4	PULLPART.1009	51.90
M Mount 2 1/4" Door	B10	PULLPART.1010	51.90
M Mount 2 1/4" Door	B10B	PULLPART.1011	51.90
M Mount 2 1/4" Door	B26	PULLPART.1012	51.90
M Mount 2 1/4" Door	S32	PULLPART.1013	51.90
M Mount 2 1/4" Door	B26d	PULLPART.1014	51.90
M Mount 2 1/4" Door	B15	PULLPART.1015	51.90
O Mount 1.3/4" Door	B3	09-523-605	21.30
O Mount 1.3/4" Door	B4	09-523-606	21.30
O Mount 1.3/4" Door	B10	09-523-612	21.30
O Mount 1.3/4" Door	B10B	09-523-613	21.30
O Mount 1.3/4" Door	B26	09-523-625	21.30
O Mount 1.3/4" Door	B26D	09-523-626	21.30
O Mount 1.3/4" Door	S32	09-523-629	21.30
O Mount 1.3/4" Door	S32D	09-523-630	21.30
O Mount 1.3/4" Door	B15	09-523-619	21.30
O Mount 2" Door	S32D	PULLPART.1016	43.60
O Mount 2" Door	B3	PULLPART.1017	43.60
O Mount 2" Door	B4	PULLPART.1018	43.60
O Mount 2" Door	B10	PULLPART.1019	43.60
O Mount 2" Door	B10B	PULLPART.1020	43.60

Contact Ives Customer Service for pricing on additional sizes and finishes

Bold pricing indicates item is in stock and available for **Fast Track** and **ProXpress**

**IVES ARCHITECTURAL HARDWARE - Parts Price List**

Description	Finish	Part No.	List Price Each
<b>Pull Mounting Packages for 8105, 8111, 8305, 8311, 8700, 8800</b> Also used with Old Mtg Style Pulls (Non-HD) 8102, 8103, 8103EZ, 8190, 8302, 8303, 9100 (Continued) See Page 64 for which options can be used with each model.			
O Mount 2" Door	B26	PULLPART.1021	\$43.60
O Mount 2" Door	S32	PULLPART.1022	43.60
O Mount 2" Door	B26D	PULLPART.1023	43.60
O Mount 2" Door	B15	PULLPART.1024	43.60
O Mount 2 1/4" Door	S32D	PULLPART.1025	43.60
O Mount 2 1/4" Door	B3	PULLPART.1026	43.60
O Mount 2 1/4" Door	B4	PULLPART.1027	43.60
O Mount 2 1/4" Door	B10	PULLPART.1028	43.60
O Mount 2 1/4" Door	B10B	PULLPART.1029	43.60
O Mount 2 1/4" Door	B26	PULLPART.1030	43.60
O Mount 2 1/4" Door	S32	PULLPART.1031	43.60
O Mount 2 1/4" Door	B26D	PULLPART.1032	43.60
O Mount 2 1/4" Door	B15	PULLPART.1033	43.60
* Type M and O mounting packs are sold in multiples of 1.			
<b>Pull HD Mounting Packages for 8102HD, 8302, 8372, 8373, 8975</b> See Page 64 for which options can be used with each model.			
5/16HD Standard Mount 1.1/2"-1.7/8" Door	B15,B26,26D	PULLPART.1063	6.40
5/16HD Standard Mount 1.1/2"-1.7/8" Door	B3	PULLPART.1064	6.40
5/16HD Standard Mount 1.1/2"-1.7/8" Door	B10	PULLPART.1065	6.40
5/16HD Standard Mount 1.1/2"-1.7/8" Door	B10B	PULLPART.1066	6.40
5/16HD Standard Mount 2-2.1/4" Door	B15,B26,B26D	PULLPART.1071	6.40
5/16HD Standard Mount 2-2.1/4" Door	B3	PULLPART.1072	6.40
5/16HD Standard Mount 2-2.1/4" Door	B10	PULLPART.1073	6.40
5/16HD Standard Mount 2-2.1/4" Door	B10B	PULLPART.1074	6.40
5/16HD G Mount	-	PULLPART.1079	3.50
5/16HD I Mount	-	PULLPART.1081	38.20
5/16HD J Mount 1.1/2"-1.7/8" Door	-	PULLPART.1085	13.30
5/16HD J Mount 2-2.1/4" Door	-	PULLPART.1086	13.30
5/16HD L Mount	-	PULLPART.1083	38.20
<b>Pull HD Mounting Packages for 8103HD, 8103EZHD, 8145EZHD, 8190HD, 8190EZHD, 8303, 9100HD, 9264, 9266, 8169, 8181, 8281, 8189, 8312, 8320, 8371, 8848</b> See Page 64 for which options can be used with each model.			
3/8HD Standard Mount 1.1/2"-1.7/8" Door	B15,B26,26D	PULLPART.1067	6.40
3/8HD Standard Mount 1.1/2"-1.7/8" Door	B3	PULLPART.1068	6.40
3/8HD Standard Mount 1.1/2"-1.7/8" Door	B10	PULLPART.1069	6.40
3/8HD Standard Mount 1.1/2"-1.7/8" Door	B10B	PULLPART.1070	6.40
3/8HD Standard Mount 2-2.1/4" Door	B15,B26,B26D	PULLPART.1075	6.40
3/8HD Standard Mount 2-2.1/4" Door	B3,B4	PULLPART.1076	6.40
3/8HD Standard Mount 2-2.1/4" Door	B10	PULLPART.1077	6.40
3/8HD Standard Mount 2-2.1/4" Door	B10B	PULLPART.1078	6.40
3/8HD A Mount	-	PULLPART.1200	38.20
3/8HD G Mount	-	PULLPART.1080	3.50
3/8HD I Mount	-	PULLPART.1082	38.20
3/8HD L Mount	-	PULLPART.1084	19.40
3/8HD N Mount 1.1/2"-1.7/8" Door	-	PULLPART.1087	13.30
3/8HD N Mount 2-2.1/4" Door	-	PULLPART.1088	13.30
3/8HD O Mount 1.1/2"-1.7/8" Door	B3	PULLPART.1089	21.30
3/8HD O Mount 1.1/2"-1.7/8" Door	US4	PULLPART.1090	21.30
3/8HD O Mount 1.1/2"-1.7/8" Door	US10	PULLPART.1091	21.30
3/8HD O Mount 1.1/2"-1.7/8" Door	US10B	PULLPART.1092	21.30
3/8HD O Mount 1.1/2"-1.7/8" Door	US15	PULLPART.1093	21.30
3/8HD O Mount 1.1/2"-1.7/8" Door	US26	PULLPART.1094	21.30
3/8HD O Mount 1.1/2"-1.7/8" Door	US26D	PULLPART.1095	21.30
3/8HD O Mount 1.1/2"-1.7/8" Door	US32	PULLPART.1096	21.30

Contact Ives Customer Service for pricing on additional sizes and finishes

Bold pricing indicates item is in stock and available for **Fast Track** and **ProXpress**

**IVES ARCHITECTURAL HARDWARE - Parts Price List**

Description	Finish	Part No.	List Price Each
<b>Pull HD Mounting Packages for 8103HD, 8103EZHD, 8145EZHD, 8190HD, 8190EZHD, 8303, 9100HD, 9264, 9266, 8169, 8181, 8281, 8189, 8312, 8320, 8371, 8848 (Continued)</b> See Page 64 for which options can be used with each model.			
3/8HD O Mount 1.1/2"-1.7/8" Door	US32D	PULLPART.1097	\$21.30
3/8HD O Mount 2-2.1/4" Door	US3	PULLPART.1098	43.70
3/8HD O Mount 2-2.1/4" Door	US4	PULLPART.1099	43.70
3/8HD O Mount 2-2.1/4" Door	US10	PULLPART.1100	43.70
3/8HD O Mount 2-2.1/4" Door	US10B	PULLPART.1101	43.70
3/8HD O Mount 2-2.1/4" Door	US15	PULLPART.1102	43.70
3/8HD O Mount 2-2.1/4" Door	US26	PULLPART.1103	43.70
3/8HD O Mount 2-2.1/4" Door	US26D	PULLPART.1104	43.70
3/8HD O Mount 2-2.1/4" Door	US32	PULLPART.1105	43.70
3/8HD O Mount 2-2.1/4" Door	US32D	PULLPART.1106	43.70
3/8HD P Mount	-	PULLPART.1201	47.30
3/8HD Q Mount 3/8"-5/8" Door	B3	PULLPART.1202	56.40
3/8HD Q Mount 3/8"-5/8" Door	US4	PULLPART.1203	56.40
3/8HD Q Mount 3/8"-5/8" Door	US10	PULLPART.1204	56.40
3/8HD Q Mount 3/8"-5/8" Door	US10B	PULLPART.1205	56.40
3/8HD Q Mount 3/8"-5/8" Door	US15	PULLPART.1206	56.40
3/8HD Q Mount 3/8"-5/8" Door	US26	PULLPART.1207	56.40
3/8HD Q Mount 3/8"-5/8" Door	US26D	PULLPART.1208	56.40
3/8HD Q Mount 3/8"-5/8" Door	US32	PULLPART.1209	56.40
3/8HD Q Mount 3/8"-5/8" Door	US32D	PULLPART.1210	56.40
3/8HD X Mount 1.1/2"-1.7/8" Door	B15,B26,26D	PULLPART.1211	43.70
3/8HD X Mount 1.1/2"-1.7/8" Door	B3	PULLPART.1212	43.70
3/8HD X Mount 1.1/2"-1.7/8" Door	B10	PULLPART.1213	43.70
3/8HD X Mount 1.1/2"-1.7/8" Door	B10B	PULLPART.1214	43.70
3/8HD X Mount 2-2.1/4" Door	B15,B26,B26D	PULLPART.1215	43.70
3/8HD X Mount 2-2.1/4" Door	B3,B4	PULLPART.1216	43.70
3/8HD X Mount 2-2.1/4" Door	B10	PULLPART.1217	43.70
3/8HD X Mount 2-2.1/4" Door	B10B	PULLPART.1218	43.70
<b>Old Mtg Style Push/Pull Combos (Non-HD) Mounting Packages for 9103EZ, 9190</b> See Page 64 for which options can be used with each model.			
NO Mount 1.3/4" Door	B3	09-525-605	53.40
NO Mount 1.3/4" Door	B4	09-525-606	53.40
NO Mount 1.3/4" Door	B10	09-525-612	53.40
NO Mount 1.3/4" Door	B10B	09-525-613	53.40
NO Mount 1.3/4" Door	B26	09-525-625	53.40
NO Mount 1.3/4" Door	B26D	09-525-626	53.40
NO Mount 1.3/4" Door	S32	09-525-629	53.40
NO Mount 1.3/4" Door	S32D	09-525-630	53.40
NO Mount 1.3/4" Door	B15	09-525-619	53.40
NO Mount 2" Door	B3	PULLPART.1042	53.40
NO Mount 2" Door	B4	PULLPART.1043	53.40
NO Mount 2" Door	B10	PULLPART.1044	53.40
NO Mount 2" Door	B10B	PULLPART.1045	53.40
NO Mount 2" Door	B26	PULLPART.1046	53.40
NO Mount 2" Door	B26D	PULLPART.1047	53.40
NO Mount 2" Door	S32	PULLPART.1048	53.40
NO Mount 2" Door	S32D	PULLPART.1049	53.40
NO Mount 2" Door	B15	PULLPART.1050	53.40
NO Mount 2 1/4" Door	B3	PULLPART.1051	53.40
NO Mount 2 1/4" Door	B4	PULLPART.1052	53.40
NO Mount 2 1/4" Door	B10	PULLPART.1053	53.40
NO Mount 2 1/4" Door	B10B	PULLPART.1054	53.40

Contact Ives Customer Service for pricing on additional sizes and finishes

Bold pricing indicates item is in stock and available for **Fast Track** and **ProXpress**



**IVES ARCHITECTURAL HARDWARE - Parts Price List**

Description	Finish	Part No.	List Price Each
<b>Old Mtg Style Push/Pull Combos (Non-HD) Mounting Packages for 9103EZ, 9190 (Continued)</b>			
See Page 64 for which options can be used with each model.			
NO Mount 2 1/4" Door	B26	PULLPART.1055	\$53.40
NO Mount 2 1/4" Door	B26D	PULLPART.1056	53.40
NO Mount 2 1/4" Door	S32	PULLPART.1057	53.40
NO Mount 2 1/4" Door	S32D	PULLPART.1058	53.40
NO Mount 2 1/4" Door	B15	PULLPART.1059	53.40
NS Mount 1.3/4" Door	B3,B4	09-524-605	30.80
NS Mount 1.3/4" Door	B15, B26, B26D, PA28, S32, S32D	09-524-630	30.80
NS Mount 1.3/4" Door	B10	09-524-612	30.80
NS Mount 1.3/4" Door	B10B	09-524-613	30.80
NS Mount 2" Door	B3,B4	PULLPART.1034	30.80
NS Mount 2" Door	B15, B26, B26D, PA28, S32, S32D	PULLPART.1035	30.80
NS Mount 2" Door	B10	PULLPART.1036	30.80
NS Mount 2" Door	B10B	PULLPART.1037	30.80
NS Mount 2" Door	B3,B4	PULLPART.1038	30.80
NS Mount 2" Door	B15, B26, B26D, PA28, S32, S32D	PULLPART.1039	30.80
NS Mount 2" Door	B10	PULLPART.1040	30.80
NS Mount 2" Door	B10B	PULLPART.1041	30.80
<b>Push/Pull Combo HD Mounting Packages for 9103EZHD, 9145EZHD, 9190HD, 9190EZHD</b>			
See Page 64 for which options can be used with each model.			
3/8HD NO Mount 1.1/2"-1.7/8" Door	US3	PULLPART.1115	53.40
3/8HD NO Mount 1.1/2"-1.7/8" Door	US4	PULLPART.1116	53.40
3/8HD NO Mount 1.1/2"-1.7/8" Door	US10	PULLPART.1117	53.40
3/8HD NO Mount 1.1/2"-1.7/8" Door	US10B	PULLPART.1118	53.40
3/8HD NO Mount 1.1/2"-1.7/8" Door	US15	PULLPART.1119	53.40
3/8HD NO Mount 1.1/2"-1.7/8" Door	US26	PULLPART.1120	53.40
3/8HD NO Mount 1.1/2"-1.7/8" Door	US26D	PULLPART.1121	53.40
3/8HD NO Mount 1.1/2"-1.7/8" Door	US32	PULLPART.1122	53.40
3/8HD NO Mount 1.1/2"-1.7/8" Door	US32D	PULLPART.1123	53.40
3/8HD NO Mount 2-2.1/4" Door	US3	PULLPART.1124	53.40
3/8HD NO Mount 2-2.1/4" Door	US4	PULLPART.1125	53.40
3/8HD NO Mount 2-2.1/4" Door	US10	PULLPART.1126	53.40
3/8HD NO Mount 2-2.1/4" Door	US10B	PULLPART.1127	53.40
3/8HD NO Mount 2-2.1/4" Door	US15	PULLPART.1128	53.40
3/8HD NO Mount 2-2.1/4" Door	US26	PULLPART.1129	53.40
3/8HD NO Mount 2-2.1/4" Door	US26D	PULLPART.1130	53.40
3/8HD NO Mount 2-2.1/4" Door	US32	PULLPART.1131	53.40
3/8HD NO Mount 2-2.1/4" Door	US32D	PULLPART.1132	53.40
3/8HD NS Mount 1.1/2"-1.7/8" Door	B15,B26,B26D	PULLPART.1107	30.80
3/8HD NS Mount 1.1/2"-1.7/8" Door	B3,B4	PULLPART.1108	30.80
3/8HD NS Mount 1.1/2"-1.7/8" Door	B10	PULLPART.1109	30.80
3/8HD NS Mount 1.1/2"-1.7/8" Door	B10B	PULLPART.1110	30.80
3/8HD NS Mount 2-2.1/4" Door	B15,B26,B26D	PULLPART.1111	30.80
3/8HD NS Mount 2-2.1/4" Door	B3,B4	PULLPART.1112	30.80
3/8HD NS Mount 2-2.1/4" Door	B10	PULLPART.1113	30.80
3/8HD NS Mount 2-2.1/4" Door	B10B	PULLPART.1114	30.80
3/8HD PQ Mount 3/8"-5/8" Door	US3	PULLPART.1219	98.20
3/8HD PQ Mount 3/8"-5/8" Door	US4	PULLPART.1220	98.20
3/8HD PQ Mount 3/8"-5/8" Door	US10	PULLPART.1221	98.20
3/8HD PQ Mount 3/8"-5/8" Door	US10B	PULLPART.1222	98.20
3/8HD PQ Mount 3/8"-5/8" Door	US15	PULLPART.1223	98.20
3/8HD PQ Mount 3/8"-5/8" Door	US26	PULLPART.1224	98.20
3/8HD PQ Mount 3/8"-5/8" Door	US26D	PULLPART.1225	98.20

Contact Ives Customer Service for pricing on additional sizes and finishes

Bold pricing indicates item is in stock and available for **Fast Track** and **ProXpress**

## IVES ARCHITECTURAL HARDWARE - Parts Price List

Description	Finish	Part No.	List Price Each
<b>Push/Pull Combo HD Mounting Packages for 9103EZHD, 9145EZHD, 9190HD, 9190EZHD (Continued)</b>			
See Page 64 for which options can be used with each model.			
3/8HD PQ Mount 3/8"-5/8" Door	US32	PULLPART.1226	98.20
3/8HD PQ Mount 3/8"-5/8" Door	US32D	PULLPART.1227	98.20

Contact Ives Customer Service for pricing on additional sizes and finishes

Bold pricing indicates item is in stock and available for **Fast Track** and **ProXpress**

# WARRANTY

**Ives** (the “Company”) warrants only to Customer that the products will be free from defects in material and workmanship for a period of 12 months from the date of shipment of products. Continuous hinges carry a Lifetime Warranty with exception of electrified continuous hinged which carry a 12 month Warranty from time of shipment. The Customer shall be obligated to promptly report any failure to conform to this warranty in writing to the Company within the warranty period provided above. Company’s sole obligation under this warranty is limited to repairing or replacing, at its option, the defective products.

**NO OTHER WARRANTIES, EXPRESS OR IMPLIED, ARE MADE WITH RESPECT TO THE PRODUCTS INCLUDING, BUT NOT LIMITED TO, ANY IMPLIED WARRANTY OF MERCHANTABILITY OR FITNESS FOR A PARTICULAR PURPOSE.**

The provisions of this limited warranty do not apply to products: (i) used for the purposes for which they are not designed or intended; (ii) which have been repaired or altered without Company’s prior written consent; (iii) which have been subjected to misuse, abuse, negligence, or accident; (iv) which have been improperly stored, installed, maintained, or operated; (v) which have been used in violation of written instructions provided by Company to Customer; (vi) which have been subjected to improper temperature, humidity, or other environmental conditions; (vii) which have been affected by normal wear and tear; or (viii) which, based on Company’s examination, do not disclose to Company’s satisfaction nonconformance to the warranty.

The following costs and expenses are not covered by the provisions of this limited warranty: (i) labor costs for the removal and reinstallation of products; (ii) shipping and freight expenses required to return products to Company; (iii) normal maintenance; and (iv) economic losses. In addition, the provisions of this warranty are not applicable to anything other than defects in Company’s material (products only) or workmanship.

**CONSUMER PRODUCTS.** With respect to “consumer products” as defined under the Magnuson-Moss Warranty Act (“MMWA”), the following statements are made. (a) Some states do not allow limitations on how long an implied warranty lasts, so the above limitation may not apply to you. **IF ANY IMPLIED WARRANTY IS PROVIDED UNDER THE MMWA, IT IS LIMITED TO THE DURATION OF THE WARRANTY PROVIDED ABOVE.** (b) Some states do not allow the exclusion or limitation of incidental or consequential damages, so the above limitation or exclusion may not apply to you. (c) This warranty gives you specific legal rights and you may also have other rights which vary from state to state.

## About Allegion

Allegion (NYSE: ALLE) creates peace of mind by pioneering safety and security. As a \$2 billion provider of security solutions for homes and businesses, Allegion employs more than 8,000 people and sells products in more than 120 countries across the world. Allegion comprises more than 25 global brands, including strategic brands CISA®, Interflex®, LCN®, Schlage® and Von Duprin®.

For more, visit [www.allegion.com](http://www.allegion.com)

KRYPTONITE ■ LCN ■  ■ STEELCRAFT ■ VON DUPRIN