

Marketing Bulletin

Brand/product	Ives
Date	Oct. 7, 2019
Subject	Quarterly Price Book Update Q4 2019
Contact	Emily Zentz

- Page 14: Corrected wording for CON feature. All TW4 and TW8 3 knuckle and 5 knuckle hinges are standard with the Allegion Connect 8-pin Connector.
- Page 21: Added note on 224 XY, (Handed with HT, TWP, EPT)
- Page 52: Removed 619 finish from 506, 507, 507B, 508, 508C, 509C, 510C, 510BC & 511BC. This finish is no longer available on Decorative Hooks.
- Page 53: Removed Z619E finish from 571 Coat & Hat Hooks. This finish is no longer available.
- Page 87: Removed 643E/716 finish from 9264 and 9264F in 72" only, max length is 36".
- Various Pages- Due to manufacturing capability and sale volume:
 - Removed 643e/716 finish from Decorative Pulls and marked various finishes as extended lead times as noted.
 - Removed various finish options from Decorative Flush pulls.



IVES

Price book 7

Effective December 1, 2018 • Rev 10/19



This price list supersedes and cancels all previous price lists. Prices shown are subject to change without notice.

Administrative Offices

Allegion Administrative Office
11819 N. Pennsylvania St.
Carmel, IN 46032
allegion.com/us

Placing orders

You can place orders with Allegion via the fax number or email listed below:

Fax#: 1-877-424-8494
Email: Order_lves@allegion.com

Customer Care

Our Customer Care Representatives are available for questions or assistance.
You can reach them at **877-671-7011** (Press 1 for Sales Support | Press 2 for Product Support | Press 3 for RSO) or through the email addresses listed below:

Sales Support

support@allegion.com

Technical Product Support

Hinges, O/H Stops, Accessories

Accessories_TechProdSupport@allegion.com

Request for Quote

Carolinas

(North Carolina, South Carolina, Virginia)
Carolinas.Quotes@allegion.com

Central

(Arkansas, Illinois, Iowa, Kansas, Missouri, Nebraska, Oklahoma)
Central.Quotes@allegion.com

Chicago

(Illinois-Northern, Wisconsin)
Chicago.Quotes@allegion.com

Florida

Florida.Quotes@allegion.com

Great Lakes

(New York, Pennsylvania)
GreatLakes.Quotes@allegion.com

Metro New York

Metro.Quotes@allegion.com

Michigan

Michigan.Quotes@allegion.com

Mid Atlantic North

(New York, Pennsylvania)
Mid.Atlantics.north.quotes@allegion.com

Mid Atlantic South

(Delaware, Maryland, New Jersey)
Mid.Atlantics.south.quotes@allegion.com

Midwest

(Indiana, Kentucky, Ohio, West Virginia)
Midwest.Quotes@allegion.com

Mountain States

(Colorado, Idaho, Montana, Nevada, Utah, Wyoming)
Mtn.States.Quotes@allegion.com

New England

(Connecticut, Main, Massachusetts, New Hampshire, Rhode Island, Vermont)
NewEngland.Quotes@allegion.com

North Central

(Minnesota, North Dakota, South Dakota)
NorthCentral.Quotes@allegion.com

Northern California

NoCal.Quotes@allegion.com

Northwest

(Alaska, Oregon, Washington)
Northwest.Quotes@allegion.com

South

(Alabama, Georgia, Louisiana, Mississippi, Tennessee)
South.Quotes@allegion.com

Southern California

(California-Southern, Hawaii)
SoCal.Quotes@allegion.com

Southwest

(Arizona, New Mexico)
Southwest.Quotes@allegion.com

Texas

Texas.Quotes@allegion.com

Terms and Conditions ii-v
How to use this book vi
Index by Product Number vii
Keys to Finishes viii-ix
Hinges..... 1-15
Continuous Hinge..... 16-23
Pivots24-26
Architectural Hardware.....27-88
Warranty Inside Back Cover

BAA/ARRA

For a list of available BAA/ARRA compliant products please contact your local RSO or Customer Care at 877-671-7011

Allegion General Terms and Conditions of Sale and Service

1. GENERAL/ACCEPTANCE. (a) This Agreement contains the only terms and conditions by which Company will quote and sell Deliverables to Customer; (b) The terms "purchase order" or "order" for the purposes of this Agreement include the term "request for quotation," as appropriate; (c) This Agreement supersedes all pre-printed or boilerplate terms and conditions set forth in any purchase order issued by Customer; (d) No reference herein to Customer's purchase order will in any way incorporate different or additional terms and conditions, all of which Company hereby expressly objects to; (e) **ANY ACCEPTANCE BY COMPANY OF CUSTOMER'S PURCHASE ORDER IS EXPRESSLY CONDITIONED ON THE CUSTOMER'S ASSENT TO AND ACCEPTANCE OF THE TERMS AND CONDITIONS CONTAINED IN THIS AGREEMENT;** (f) Company reserves the right to decline any order, in whole or in part, for any reason.

2. ORDERS.

a. **Order Processing.** When Customer wishes to place an order for Deliverables, it will deliver to Company a purchase order. All such purchase orders must (i) be in a written format acceptable to Company, (ii) be legible, (iii) include a purchase order number, (iv) include Customer's account number, invoice address, ship to address, shipping method, shipper's letter of instruction for international shipments, part number, pricing, and designated contact information, (v) include, if applicable, any special configuration ID numbers, necessary programming information, special factory instructions, and requested specifications regarding a particular finish, handing, design, backset, or strike, (vi) reference any applicable pricing discounts under an ongoing buying program or based on a written quote from Company, along with the applicable buying program number or quotation number, and (vii) not combine buying program and quoted product on the same order.

b. **Minimum Orders.** In the event the order value does not meet any required minimum net Deliverable value, Company may, at its sole discretion, (i) increase the quantity of items in the order to meet the minimum net Deliverable value requirement; (ii) apply a minimum order charge; (iii) reject the order, or (iv) waive the requirement, provided that the waiver of a requirement for one order shall not constitute a waiver of the requirement for any future orders.

c. **Acceptance of Purchase Orders.** Company will endeavor to (i) acknowledge receipt of each purchase order issued in accordance with this Agreement, and (ii) notify Customer whether Company accepts or rejects the purchase order. If Company fails to accept or reject a purchase order within a reasonable time period, such failure to respond will be deemed a rejection of the entire order. Orders that combine buying program and quoted product on the same order will be routed back to your local RSO office in order to review subject purchase order.

d. **Changes to Order/ Cancellation of Orders.** Additional terms and conditions regarding order changes and cancellations are available on the Allegion customer website, **WHICH TERMS ARE EXPRESSLY INCORPORATED HEREIN BY REFERENCE.** Unless otherwise provided herein, Customer acknowledges that (i) requesting a Change Order may cause a delay in the scheduled shipment date, a longer lead time or result in a new scheduled shipment date; (ii) Orders may not be changed after 48 hours of Company's order acknowledgment; (iii) After 48 hours of Company's order acknowledgment, all changes to an accepted purchase order will be subject to a Change Order charge of 25% of the net Deliverable value, plus the cost of labor and fabrication or raw material that Company incurred prior to the receipt of the Change Order from Customer, or that may be required due to the Change Order; (iv) the requested change may result in additional charges for labor, fabrication, and raw material, and (v) if Customer cancels an order or portion of an order that includes Deliverables that have been manufactured and prepped for shipping, a 45% restocking fee will apply. Notwithstanding the foregoing, Customer cannot change or cancel credential orders, reader orders, biometrics orders or any non-cataloged, special, Custom or nonstandard items once they have been placed. All cancelled orders for a Non Recurring Expense (NRE), credential orders, reader orders, biometrics orders, and/or Custom orders will be subject to a cancellation charge of 100% of the acknowledged price.

e. **Add-ons.** Add-on orders will not be accepted. Additions to orders will be entered as separate stand-alone orders and must qualify for all terms of sale, including discounts, on an individual basis.

f. **Fast-Track Orders.** No changes or cancellations will be accepted on the 24-Hour Fast Track Program. For 3-day Fast Track orders, changes and cancellations may only be requested by Customer within 24 hours of Company's order acknowledgment if the order has not shipped. For 5-Day Fast Track orders, changes and cancellations may only be requested by Customer if the order has not shipped and if the request is made to Company within 48 hours of Company's order acknowledgment. Return Material Authorization (RMA) for Deliverables must be processed through Fast Track Customer Service.

g. **Steelcraft Orders.** For all Steelcraft orders, changes or cancellations are allowed without penalty only if made within 48 hours of Company's order acknowledgment, and provided that the order has not shipped. Some exceptions do apply – please consult the factory. Changes are not allowed on Rapid Program orders after the order has been entered and acknowledged. After 48 hours of Company's order acknowledgment, all changes or cancellations are subject to a charge of 25% of the order. Unless otherwise specified by Company in writing, any changes to orders acknowledged by Company that affect the delivery date will be deemed a new order and will require acknowledgement by Company as provided in this Section. Additional products, features, terms and conditions regarding the Rapid Program are available on the Allegion customer website, **WHICH TERMS ARE EXPRESSLY INCORPORATED HEREIN BY REFERENCE.**

3. PRICES, INVOICES AND PAYMENT.

a. **Prices.** The prices in Company's Price Book are subject to change at any time, without notice to Customer. Company may charge Customer additional amounts if Customer requests special packing, marking, shipment, product modification, or engineering services. Oral prices specified by Company are null and void. Quote numbers must be referenced on Customer's purchase order in order for the Company's quoted pricing to apply. Orders that do not reference a quote number will receive buy program pricing or book net pricing. Quoted prices are for those specific products quoted for a specified job, and are subject to the Price Book in effect at the time Company receives the order.

b. **Taxes.** Prices do not include any present or future federal, state or local property, license, privilege, sales, use, excise, gross receipts or other like taxes or assessments which may result from transactions or any services performed in connection therewith. Any taxes, charges, or duties imposed by any governmental authority on the sale of Deliverables will be paid by Customer, in addition to the selling price specified by Company. Credits for U.S. sales tax applied to invoices will only be granted if valid exemption documentation is provided within 30-days of the invoice date and a case is initiated by customer service. Exemption documentation may be emailed to sales.tax.certificates@allegion.com, this e-mail address cannot be used to request a credit for sales tax charged all such requests must be made with customer service. All certificates sent to the e-mail address must include the following information: (1) Customer account number(s); (2) Customer name; and (3) Allegion brand(s) the certificate should be applied to.

c. **Payment Terms.** Company will deliver to Customer an invoice with each shipment of Deliverables hereunder. Customer will pay all invoiced amounts within 35 days of the invoice date (subject to any early pay discounts that may be offered to Customer by Company in its sole discretion). Customer will make all payments in United States dollars. Past due invoices will be subject to a late payment service charge of 1.5% per month on any overdue unpaid balance, equivalent to 18% per annum, or the maximum rate permitted by law, whichever is less. Customer shall reimburse Company for all costs of collection, including, without limitation, reasonable attorneys' fees, for any overdue amount owed by Customer to Company, and such collection costs shall also be subject to interest charges.

4. QUOTATIONS.

a. **Project Quotations.** Project or new construction quotes are restricted to the specific project quoted for the quantities, finishes, and series of Deliverables referenced on the quote. Company reserves the right to require proof of sale of Company products for any quoted project.

b. **Stock Quotations.** Deliverables fulfilling stock quotations may only be used for the following: i) Stocking of the Customer's shelves for small, quick-turn, discretionary projects, or ii) Sale to a general contractor or installer for new construction. Stock quotations may not be used for any project containing any Company no-substitution, specified products. Deliverables purchased under Stock Quotations cannot be redistributed to other Customer branch locations or re-sold to other resellers or used for aftermarket sales, end-user annual contracts or sold over the counter to any walk in trade.

c. **General.** All quotes are subject to this Agreement, unless otherwise specified by Company, and are subject to change at any time prior to Company's acceptance of a purchase order referencing the applicable quote number. Company, its representatives and employees reserve the right, in their sole discretion and for any reason, to refuse a Customer's request to quote a price other than the standard list price, regardless of whether Company or its representatives or employees have previously quoted discounted prices to the Customer on some or all of its orders. Customer's failure to comply with this Section 4 will be considered a material breach of this Agreement, and will entitle Company to immediately terminate any purchase orders and/or Customer's ability to distribute Company's products.

5. SECURITY INTEREST. Customer grants Company, and Company retains, a purchase money security interest and lien on any and all of Customer's rights, title and interest in each Deliverable sold by Company to Customer, wherever located, until the invoice for the applicable Deliverable(s) is paid in full, including any late charges and costs of collection. Customer authorizes Company to, and will assist Company in, taking all necessary steps to perfect and maintain Company's interest in such Deliverables.

6. CREDIT TERMS. Unless Customer pre-pays all of its purchase orders in advance, its purchase orders will be subject to the credit limit and other terms of credit ("Credit Terms") set forth in Company's credit application, which Credit Terms Customer acknowledges are subject to change by Company at any time. Company reserves the right to request payment in advance of shipment or any order or to request adequate assurances for Customer's payment of an order and may withhold or stop shipment, without any liability to Company, until Customer submits payment or adequate assurance of payment.

7. RESALE OF DELIVERABLES. Customer agrees and warrants that it will offer Company products in support of Company-written specifications and will maintain sufficient inventory to adequately support End Users, installers, and/or general contractors' needs. Company may implement an MSRP or a resale pricing programs at any time in its sole discretion. Failure to comply with such program(s) will be considered a material breach of this Agreement, and will entitle Company to immediately terminate any purchase order and/or Customer's ability to distribute Company's products. Customer shall, at its own expense, gain and maintain sufficient knowledge of the industry and products competitive with Deliverables so as to be able to (a) explain in detail to End Users, installers, and/or general contractors the differences between the Deliverables and competing products, (b) ensure that an adequate number of trained, capable and qualified technical personnel with sufficient knowledge of the Deliverables and who have obtained all necessary licenses and permits are available to assist End Users, installers, and/or general contractors, and (c) respond to such End Users, installers, and/or general contractors with respect to the general operation and use of the Deliverables including, but not limited to, (1) acting as a liaison between the End Users, installers and/or general contractors and Company in matters requiring Company participation, (2) providing general product information and configuration support on standard protocols and features, (3) collecting relevant technical problem identification information, and (4) posting and distributing any warranty information concerning the Products in accordance with Company's instructions. Customer is responsible for all service and support resulting from the re-sale of any Deliverable to End-Users, installers and/or general contractors, examples of which may include, but are not limited to, support activities such as installation, initialization, software set-up, training, trouble-shooting, technical support and field service. In the event Customer is unwilling or unable to perform said support activities, Company reserves the right to recover from Customer any and all expenses incurred by Company to resolve the afore-mentioned End-User, installer and/or general contractor issues. Technical product training is recommended for Customer in order to fully service and support Deliverables purchased from Company that are resold to End-Users, installers and/or general contractors.

8. DEFAULT. If Customer is in default of payment or otherwise with respect to any purchase order or other contract with Company, Company shall have the right, in addition to all other legal remedies and without prejudice to any of its right hereunder, to defer further shipments under that or any other purchase order until such default is corrected and to declare all outstanding bills of Customer to be immediately due and payable.

9. INSPECTION AND DELIVERY.

a. **Inspection.** Customer will inspect all Deliverables immediately after receiving them. Customer will be deemed to have accepted the Deliverables unless Customer notifies Company in writing of any nonconformance within 10 days of delivery and provides Company written evidence reasonably documenting that nonconformance. Inspection of Deliverables at Company's facility is not permitted.

b. **Delivery.** Delivery schedules for Deliverables are based upon current production capacities, material or component availability, and inventory, and may be changed by Company as conditions require. Delivery schedules for services are based upon Company's prompt receipt of, and prompt access to, Customer's equipment and all information necessary to complete the services. In no event will any delivery date be construed as falling within the meaning of "time is of the essence." Partial delivery shall be accepted by Customer and paid for at the price and on the terms stated herein. Any partial delivery shall constitute a separate sale, and payment shall be separately made when due. If any part of a delivery hereunder is not delivered by Company in accordance with Customer's purchase order, this Agreement shall not be affected thereby.

10. TITLE & RISK OF LOSS. Unless otherwise specified by Company, (i) where the Customer is located in the United States, all Deliverables will be sold "Uniform Commercial Code, FOB Origin, Company's factory"; and (ii) where the Customer is located outside of the United States, all Products will be sold "Ex-works, Company's factory (Incoterms 2010)." In either instance, title and risk of loss will pass to Customer upon delivery to the carrier at Company's factory, provided, however, as set forth herein, Company shall retain a security interest in the Deliverables until full payment has been made therefore, and Customer agrees, upon request, to do all things and acts necessary to protect Company's interest by adequately insuring the Deliverables against loss or damage from any cause and to have Company named as an additional insured. Customer will promptly provide Company with a copy of the relevant certificate of insurance upon Company's request.

11. SHIPPING.

a. **Freight Charges.** Company will ship all Deliverables in accordance with Company's freight shipment guidelines, which are set forth on the My Allegion Portal ("Freight Shipping Guidelines"), **WHICH TERMS ARE EXPRESSLY INCORPORATED HEREIN.**

b. **Rush Charges.** Expedited order options are available as set forth in Company's Freight Shipping Guidelines.

c. **Packing and Marking.** Company will pack, mark, and ship Deliverables according to its standard procedures for shipment, unless the parties agree, in writing, that Company will comply with any special instructions provided by Customer. Special instructions may result in an increased price.

d. **International Shipments.** For all international orders, a Shipper's letter of instruction must be submitted in writing with the order. Failure to do so will result in the order being rejected. Complete adherence to this order requirement will be strictly enforced. Company will not be held liable for any charges resulting from delays due to lack of complete required information being supplied.

e. Once received by the Company, a purchase order cannot be combined with any other order to increase average order size as it relates to Company's Freight Shipping Guidelines. However, for orders placed under Company's FastTrack 24 Hour/5 Day Program (available for Schlage, Von Duprin, LCN and Glynn-Johnson products); ii) FastTrack 24 Hour/3 Day Program (available for Ives products); or ProExpress (available for specific product lines stated in the ProExpress price book for Falcon, Ives, Glynn Johnson, LCN, Schlage and Von Duprin products), the applicable brands or product categories may, subject to certain order requirements identified by Company, be combined on a single order to increase average order size used in Company's Freight Shipping Guidelines.

12. CLAIMS. All claims must be submitted in writing to Company as follows: (i) All claims for prices must be submitted within thirty (30) days from the date of invoice; (ii) All claims regarding Deliverable quantity or incorrect orders must be submitted within ten (10) days from the date of delivery; (iii) All claims for damage to Deliverables (while in the care, custody, and control of Company) must be submitted within thirty (30) days from the date of invoice; (iv) All claims for loss or damage to Deliverables while in the care, custody, and/or control of a carrier will be the responsibility of Customer, unless otherwise agreed by the parties.

13. PRODUCT CHANGES. Company's product policy is one of ongoing update and revision, and accordingly, Company reserves the right to change, without notice, the design of, or the process of manufacturing, the Deliverables covered by this Agreement.

14. PRODUCT USAGE LIMITATION. Customer agrees: (i) not to sell or use a Deliverable in any manner contrary to the manner in which the Deliverable is intended to be used; and/or (ii) not to modify the design of any Deliverable for use with another product without the prior written consent of Company.

15. PRODUCT RETURNS. Unless otherwise agreed by the parties in writing, Deliverables that are correctly furnished by Company per the purchase order may not be returned unless Customer receives written authorization from Company. If returns are authorized by Company, a return merchandise authorization ("RMA") number must be provided by Company. Deliverables identified under such RMA must be returned to Company within 90 days of issuance of the RMA. Such RMA number and any accompanying RMA documents, the original invoice number, and a written explanation for the return must be included with the returned Deliverables in order for Company to inspect and approve a credit for the return. **For warranty returns,** a credit in the amount of the original purchase price will only be issued if, after Company's receipt and inspection of the returned Deliverables, Company confirms, in its sole discretion, the defect is valid and approves the return. **For non-warranty returns/convenience returns,** in the event Company approves such a return, in its sole discretion, the following shall apply: (a) the total amount of Deliverables requested to be returned shall be a minimum of \$250.00; (b) a credit will be made to Customer's account in the amount of the original purchase price less freight and a handling charge of 45% of the net material on the original invoice; and (c) only Deliverables that are new, current, standard, non-obsolete, non-specially manufactured, unused, in their original condition as at the time of sale by Company to Customer, in their original packaging and in Customer's inventory less than 180 days from the date of shipment by the Company, and not ordered as part of a master key solution may be considered by Company for return. Such credit will only be issued if, after Company's receipt and inspection of Deliverables, Company approves the return. The amount of final credit will be determined upon receipt at the factory and following Company's inspection and analysis of the condition of the returned material. Company retains the right to deny credit to anyone for any reason.

16. CONFIDENTIAL INFORMATION.

a. **Non-Use And Non-Disclosure.** Customer shall not use the Confidential Information of the Company except for the purpose of performing its obligations under this Agreement or exercising the rights granted herein (the "Purpose"). Customer shall protect Confidential Information of the Company from disclosure and unauthorized use in the same manner that it protects its own Confidential Information, but in no event shall such standard of care be less than reasonable care. Customer may disclose Confidential Information of the Company only to its employees who require such information for the Purpose and who are subject to confidentiality obligations at least as protective as those set forth herein.

b. **Proprietary Information and Advice.** (a) All designs, data, and specifications provided by Company are proprietary and may not be disclosed or reused by Customer without the prior written consent of Company; (b) Company assumes no obligation or liability for any advice given by Company, the results obtained, or damages incurred as a result of such advice, and all such advice is given and accepted at Customer's risk.

c. **Return.** Upon the termination or expiration of a purchase order or this Agreement or upon the request of the Company, the Customer agrees to end all further use of, to immediately return to the Company the original version of, and to delete or destroy all copies of, any and all Confidential Information of the Company.

17. TRADEMARKS. Except as agreed to by Company in writing, Customer agrees not to (a) use Company's name in any form of publicity; or (b) use, create, register or market, directly or indirectly, in whole or in part, Company's names, logos, brands, or any other trademarks, or names that are now or may hereafter be owned by Company, as part of Customer's corporate or business name, as part of an internet domain name, uniform resource locator (URL), or in any way connected with Customer's business, trade address or other designations. Upon termination of this Agreement or upon the request of company for any reason, any use of Company's trademarks or names will be immediately discontinued.

18. LIMITED WARRANTY.

COMPANY MAKES NO OTHER WARRANTIES EXCEPT THOSE STATED IN COMPANY'S LIMITED WARRANTY IN EFFECT ON THE DATE COMPANY ACCEPTS EACH APPLICABLE PURCHASE ORDER ("LIMITED WARRANTY"). THE LIMITED WARRANTY MAY BE FOUND IN THE APPLICABLE PRICE BOOK AND ON THE ALLEGION CUSTOMER WEBSITE, WHICH TERMS ARE EXPRESSLY INCORPORATED HEREIN BY REFERENCE. COMPANY WILL MAIL CUSTOMER A HARD COPY OF THIS WARRANTY UPON CUSTOMER'S WRITTEN REQUEST. IN THE EVENT THAT CERTAIN DELIVERABLE WARRANTIES ARE NOT FURNISHED BY THE COMPANY TO CUSTOMER, COMPANY WARRANTS ONLY TO CUSTOMER THAT THE DELIVERABLES WILL BE FREE FROM DEFECTS IN MATERIAL AND WORKMANSHIP FOR A PERIOD OF 12 MONTHS FROM THE DATE OF SHIPMENT OF THE DELIVERABLES. COMPANY'S SOLE OBLIGATION UNDER THIS WARRANTY IS LIMITED TO REPAIRING OR REPLACING, AT COMPANY'S OPTION, THE DEFECTIVE DELIVERABLE, PROVIDED WRITTEN NOTICE OF THE DEFECT OR NONCONFORMANCE IS PROVIDED BY CUSTOMER WITHIN 30 DAYS OF DISCOVERY OF THE DEFECT OR NONCONFORMANCE. COMPANY DISCLAIMS ALL OTHER WARRANTIES, EXPRESS OR IMPLIED, WITH RESPECT TO THE DELIVERABLES, INCLUDING BUT NOT LIMITED TO, ANY IMPLIED WARRANTIES OF NON-INFRINGEMENT, MERCHANTABILITY, OR FITNESS FOR A PARTICULAR PURPOSE.

a. **Exclusions.** The provisions of this Limited Warranty do not apply to Deliverables that: (A) are not the proper size for the application; (B) are not installed in accordance with Company's published installation instructions; (C) are installed with improper or incorrect parts and/or are used for purposes for which they are not designed or intended; (D) have been repaired or altered without the Company's prior written consent; (E) have been subjected to misuse, abuse, negligence or accident; (F) have been improperly stored, installed, maintained or operated; (G) have been used in violation of written instructions provided by Company to Customer; (H) have been subjected to improper temperature, humidity, or other environmental conditions, or (I) have been affected by normal wear and tear. In addition, the provisions of this Limited Warranty do not apply to any defects or issues with the design or performance of equipment or products not manufactured by Company, nor does it apply to any code compliance or permit requirements for the assembly, installation, erection or construction of any goods. Company is not responsible for loss or damage resulting from use of Deliverables in conjunction with parts or systems not manufactured by Company. Accessories or products furnished by the Company, but manufactured by others, shall carry whatever warranty the manufacturers have conveyed to the Company and which can be passed to Customer.

b. **Services.** Company warrants that its services will be free from defects in material and workmanship for a period of 12 months from the date of completion of the particular items of service. Company's sole obligation under this service warranty is limited to repair or reperformance, at its option of the service, provided however, if repair or reperformance is either impractical or impossible, the Company will refund to Customer that portion of the price paid to Company for any defective service, provided written notice of the defect or nonconformance is provided by Customer within 30 days of discovery of the nonconformance.

c. **Notification.** Customer agrees to immediately notify Company in writing if any claim is made against Customer for any damages caused by any modules, parts, products, service or other Deliverables which may be the direct result of any defect in the manufacture of such aforementioned products. Customer agrees to cooperate with Company and its counsel in the defense of such claim and Customer agrees not to settle such claim without Company's written consent. If Customer fails to notify Company of such claim or fails to cooperate in such defense as aforesaid, then Company shall be discharged from any obligations under this Section and shall have no further liability to Customer.

d. **Exceptions.** The following costs and expenses are not covered by the provisions of these limited warranties: (i) labor costs for the removal and reinstallation of Deliverables or other manufacturer's products; (ii) shipping and freight expenses required to return Deliverables to Company; (iii) normal maintenance; and (iv) economic losses. In addition, the provisions of this warranty are not applicable to anything other than defects in Company's material (products only) or workmanship.

19. LIMITATION OF REMEDIES.

CUSTOMER'S EXCLUSIVE AND SOLE REMEDY ON ACCOUNT OF, OR IN RESPECT OF, THE FURNISHING OF NON-CONFORMING DELIVERABLES, SHALL BE TO (A) SECURE REPAIR OR REPLACEMENT OF THE PRODUCTS; OR (B) SECURE REPAIR OR RE-PERFORMANCE OF THE SERVICES OR TO OBTAIN A REFUND OF THE PRICE PAID FOR THE DEFECTIVE SERVICE, ALL AT COMPANY'S OPTION. IN NO EVENT WILL THE COMPANY'S MAXIMUM LIABILITY EXCEED THE SELLING PRICE FOR THE DELIVERABLE. THE WARRANTY, OBLIGATIONS AND LIABILITIES OF COMPANY (INCLUDING ITS SUPPLIERS) AND THE RIGHTS AND REMEDIES OF CUSTOMER ARE EXCLUSIVE AND ARE IN LIEU OF AND CUSTOMER HEREBY WAIVES AND RELEASES ALL OTHER WARRANTIES, OBLIGATIONS, REPRESENTATIONS OR LIABILITIES EXPRESS OR IMPLIED ARISING BY LAW, IN CONTRACT, TORT (INCLUDING NEGLIGENCE OR STRICT LIABILITY) OR OTHERWISE, INCLUDING BUT NOT LIMITED TO (I) ANY IMPLIED WARRANTY OF MERCHANTABILITY OR FITNESS FOR A PARTICULAR PURPOSE OR ANY WARRANTY IMPLIED THROUGH COURSE OF PERFORMANCE, COURSE OF DEALING, OR USAGE OF TRADE OR (II) CLAIMS ARISING OUT OF THE NEGLIGENCE OF COMPANY OR COMPANY'S SUPPLIERS OR (III) ANY OTHER CLAIM ARISING OUT OF, CONNECTED WITH, OR RESULTING FROM THE PERFORMANCE OF COMPANY OR FROM THE DESIGN, MANUFACTURE, SALE, REPAIR, LEASE OR USE OF THE DELIVERABLE, OR ANY COMPONENT THEREOF, DELIVERED OR RENDERED HEREUNDER OR OTHERWISE.

20. INDEMNIFICATION AND LIMITATION OF LIABILITY. a. Customer shall indemnify, defend and hold Company, and its officers, directors, employees, customers, Affiliates, suppliers, users and agents, (collectively the "Indemnitees") harmless from and against any and all damages, claims, losses, expenses, costs, obligations, liabilities, including without limiting the generality of the foregoing, liabilities for court costs and attorneys' fees, suffered directly or indirectly by an Indemnitee by reason of, or arising out of any injury, death or loss to any person, or injury to any property (collectively, "Damages"), received or sustained by any person(s) or property, arising out of, occasioned by, attributable or related to i) any breach of any representation or warranty made by Customer, its officers, directors, employees, affiliates, users, agents, representatives or customers to Company or any third party, (ii) any failure by

Terms and Conditions

Customer to perform or fulfill any of its covenants, acts and/or omissions to Company or to any third party, or (iii) any litigation, proceeding or claim by any third party relating in any way to the obligations of Customer and/or the Deliverables sold by Company to Customer hereunder. Customer shall not consummate any settlement of any indemnified claim without the Indemnitees' prior written consent. Customer's obligation to indemnify Indemnitees will continue in full force and effect notwithstanding the termination or expiration of any order under this Agreement. In any claim against an Indemnitee by an employee of Customer or any subcontractor or anyone directly or indirectly employed by any of them or anyone for whose acts they may be liable, the indemnification obligations set forth in this Section shall not be limited in any way by or for Customer or any subcontractor under any applicable worker's compensation act, disability or other employee benefit act, or insurance coverage. This provision shall survive termination of any order or Agreement. **IN NO EVENT WILL COMPANY, ITS OFFICERS, DIRECTORS, EMPLOYEES, CUSTOMERS, AFFILIATES, USERS AND AGENTS, (NOR COMPANY'S SUPPLIERS) BE LIABLE FOR ANY INCIDENTAL, CONSEQUENTIAL, INDIRECT, SPECIAL, OR PUNITIVE DAMAGES OF ANY KIND OR NATURE UNDER ANY CIRCUMSTANCES INCLUDING, BUT NOT LIMITED TO, LOSS OF USE OF THE PRODUCTS, SERVICE INTERRUPTION, LOSS OF PROFITS, LOSS OF REVENUE, LOSS OF INTEREST, LOST GOODWILL, LOSS OF DATA, WORK STOPPAGE, IMPAIRMENT OF OTHER GOODS, LOSS BY REASON OF SHUTDOWN OR NON-OPERATION, INCREASED EXPENSES OF OPERATION, OR CLAIMS OF CUSTOMER'S CUSTOMERS, OR ANY OTHER LOSSES OR DAMAGES ARISING OUT OF ANY LACK OR LOSS OF USE OF THE DELIVERABLES WHETHER BASED ON CONTRACT, WARRANTY, TORT (INCLUDING, BUT NOT LIMITED TO, STRICT LIABILITY OR NEGLIGENCE), PATENT INFRINGEMENT, OR OTHERWISE, EVEN IF ADVISED OF THE POSSIBILITY OF SUCH DAMAGES.**

b) **INTELLECTUAL PROPERTY INDEMNITY.** Company makes no representation or warranty to the Customer that the Deliverables shall not infringe any intellectual property rights including, without limitations, claims arising from patent, copyright, trademark, trade secret, or other intellectual property infringement. Customer agrees to hold Company harmless from and defend the Company against any such claim of intellectual property infringement, including any Damages resulting from that claim, the cost of complying with any preliminary or permanent injunction, and all other costs of defense (including the attorneys' fees and costs), in connection with the foregoing.

c) To the extent that applicable law does not permit any limitations set out in this Agreement, such limitation shall not be applied or invoked. Nothing in this Agreement will be interpreted to disclaim liability of Company or the Indemnitees for gross negligence or willful misconduct. The limitations of remedy and liability herein shall not be interpreted to affect Company's obligations, if any, for claims for (i) property damage, (ii) personal injury, or (iii) wrongful death asserted by persons who are not parties to or beneficiaries of this Agreement. Further, the limitations of remedy and liability herein shall not be interpreted to limit Company's or Customer's right, if permitted by applicable law, to assert a claim for contribution among joint tortfeasors in connection with a claim by a person who is not a party to this Agreement.

21. CERTIFICATIONS. Certification of Deliverables for compliance with UL and ANSI standards are tested and performed by third-party independent laboratories. Any field modification or alteration of certified Deliverables will void certification and Company is not liable to Customer to certify any modified or altered Deliverable.

22. TERM FOR CLAIMS. NO ACTION ARISING OUT OF ANY CLAIMED BREACH OF THIS AGREEMENT BY COMPANY MAY BE BROUGHT BY CUSTOMER MORE THAN ONE (1) YEAR AFTER THE CAUSE OF ACTION HAS ARISEN.

23. CONSUMER PRODUCTS WITH RESPECT TO "CONSUMER PRODUCTS" AS DEFINED UNDER THE MAGNUSON-MOSS WARRANTY ACT ("MMWA"), THE FOLLOWING STATEMENTS ARE MADE. (A) SOME STATES OR LOCAL LAWS DO NOT ALLOW LIMITATIONS ON HOW LONG AN IMPLIED WARRANTY LASTS, SO THE ABOVE LIMITATION MAY NOT APPLY TO YOU; (B) IF ANY IMPLIED WARRANTY IS PROVIDED UNDER THE MMWA, IT IS LIMITED TO THE DURATION OF THE WARRANTY PROVIDED IN SECTION 18 ABOVE. (C) SOME STATES OR LOCAL LAWS DO NOT ALLOW THE EXCLUSION OR LIMITATION OF INCIDENTAL OR CONSEQUENTIAL DAMAGES, SO THE ABOVE LIMITATION OR EXCLUSION MAY NOT APPLY TO YOU; AND (D) THIS WARRANTY GIVES YOU SPECIFIC LEGAL RIGHTS AND YOU MAY ALSO HAVE OTHER RIGHTS WHICH VARY FROM STATE TO STATE OR LOCATION TO LOCATION.

24. FORCE MAJEURE/EXCUSABLE DELAY. Any delay or failure of Company to perform its obligations hereunder will be excused to the extent that it is caused by an event or occurrence beyond Company's control such as, by way of example and not by way of limitation, acts of God, acts by any governmental authority (whether valid or invalid), governmental laws and regulations not presently in effect, fires, floods, windstorms, explosions, riots, natural disasters, wars, sabotage, accidents, labor problems (including, without limitation, lockouts, strikes, and slowdowns) at Company's facility, its source plant or their suppliers, inability to obtain power, material, labor equipment, or transportation, or court injunction or order. The delivery date will be extended for a time equal to that of the delay and the schedule for Company's performance will be deemed adjusted to that effect.

25. ENTIRE AGREEMENT AND AMENDMENT. This Agreement, together with the attachments, exhibits, webpages, or supplements specifically referenced and incorporated herein, constitute the entire agreement between Company and Customer with respect to the matters contained herein and supersede all previous communications, representations, or agreements, either oral or written between Company and Customer. No agreement or understanding varying or expanding this Agreement will be binding upon either party unless it is in writing and signed by a duly authorized representative of each party hereto.

26. CONFLICTS. In the event of any conflict or inconsistency between the terms of any agreement, or any part of an agreement or the various documents (including, but not limited to, electronic documents) between Company and Customer, unless the parties agree otherwise in writing, the various components of the agreements shall be given the following precedence (in descending order of precedence): a) any master agreement or long term agreement between Company and Customer; b) any specific terms, conditions and/or warranties of the individual products or Deliverables; c) the terms and conditions of this Agreement, and d) any purchase order.

27. UNSATISFACTORY CREDIT/TERMINATION FOR INSOLVENCY OR DEFAULT. Customer shall furnish Company with statements evidencing Customer's financial condition as Company may, from time to time, reasonably request, and shall notify Company immediately of any and all events that may have a material adverse effect on Customer's business or financial

condition. If Company determines, in its sole discretion, that Customer's financial condition or creditworthiness is inadequate or unsatisfactory, then in addition to Company's other rights, Company may without liability or penalty, take any of the following actions: (i) modify the payment terms for any outstanding and/or future purchases; (ii) cancel any previously accepted orders; (iii) delay any further shipment of Deliverables to Customer; or (iv) any combination of the above.

Company may immediately terminate an order from Customer by giving written notice to Customer in the event of the happening of any of the following or any other comparable event: (i) insolvency of the Customer; (ii) filing of a petition in bankruptcy by or against the Customer; (iii) appointment of a receiver or trustee for the Customer; (iv) execution of an assignment for the benefit of creditors by the Customer, all of which will allow Company to demand reclamation of all affected orders; (v) Customer ceases or threatens to cease to trade; (vi) Company determines that Customer does not meet or no longer meets the credit requirements of Company or Customer's credit account is closed; (vii) any Customer violation of law, specifically including, without limitation, those laws set forth in this Agreement.

In the event of termination in accordance with this section, Company will not be obligated to accept any existing or additional orders from Customer and Company will be released from its obligation to deliver under orders accepted prior to such termination. The rejection or termination of any order by Company will not entitle Customer to any termination or severance compensation, or to any payment in respect to any goodwill established by Customer, or render Company liable for damages on account of the loss of prospective profits, or on account of any loss, expenditure, investment or obligation incurred or made by Customer.

No action taken under this Section 27 by Company (nor any failure of Company to act under this Section 27) will constitute a waiver by Company of any of its rights to enforce Customer's obligations, including the obligation of Customer to make payments as required under this Agreement. Upon termination of any order, all amounts owed by Customer to Company will become immediately due and payable, whether or not otherwise then due or payable.

28. CREDIT RISK ON RESALE OF DELIVERABLES. Customer is responsible for all credit risks with respect to, and for collecting payment for, all Deliverables sold to third parties (including End Users, installers, and/or general contractors) whether or not Customer has made full payment to Company for such Deliverables. The inability of Customer to collect payment for any Deliverable shall not affect Customer's obligation to pay Company for any Deliverable.

29. GOVERNING LAW; VENUE; AND EXPENSES. Any dispute or claim relating to this Agreement shall be governed by and construed according to the laws of the State of Indiana (excluding its conflict of laws principles); and not by the provisions of the 1980 United Nations Convention on the International Sale of Goods. Any disputes or claims shall be instituted and maintained in the courts of the State of Indiana. Customer consents to the exercise of jurisdiction over it by such courts and agrees that Indiana is not an inconvenient forum for any action arising from or relating to this Agreement. Customer agrees to pay for all expenses (including, but not limited to, collection costs, court costs and attorneys' fees) incurred by Company in enforcing the obligations of Customer under this Agreement.

30. RELATIONSHIP OF THE PARTIES. Nothing in this Agreement or any other document creates an employment, partnership, joint venture, or agency relationship between Company and Customer, including that of franchisee/franchisor. No party will have any power or authority to enter into any commitment on behalf of or otherwise bind the other party on any matter. No employee of Customer will be deemed to be an employee of Company. If any provision of this Agreement is deemed to create a franchise relationship or business opportunity between the Parties, then Company may terminate any purchase order or this Agreement or the Parties shall negotiate in good faith to modify this Agreement so as to effect the original intent of the Parties as closely as possible in a mutually acceptable manner in order that the transactions contemplated hereby are consummated as a reseller agreement and not a franchise or business opportunity agreement.

31. SETOFF. Customer does not have the right to setoff or to back charge against any amounts which become payable to Company under this Agreement or otherwise. Company will not accept responsibility for backcharges for the cost of material or labor by Customer or any third party.

32. ELECTRONIC COMMUNICATIONS AND ELECTRONIC SIGNATURES. Both parties expressly agree to electronic transactions and acknowledge that documents they sign electronically will bind them to the same extent as a paper signature. Customer represents and warrants to Company that only employees authorized to bind Customer legally shall electronically sign any document under this Agreement. Customer shall comply with any method of electronic communication/payment processing specified by Company, including electronic funds transfer, pay-on-receipt processes/systems, order transmission, releases, electronic signature, and electronic communication systems, including, without limitation, the use of electronic data interchange ("EDI") portals. Notwithstanding the foregoing, e-mails, even those containing a signature block of one of Company's representatives, shall not constitute a signed writing.

33. COMPLIANCE WITH APPLICABLE LAWS.

a. **General.** Company and Customer will comply with all applicable federal, state and municipal laws, regulations, codes, ordinances and orders that pertain to the Deliverables, including but not limited to full compliance with any applicable provisions of The Health Insurance Portability and Accountability Act. Where the Customer is located outside the United States, or where the customer intends to ship the product outside the United States, the Customer shall be responsible for compliance with all U.S. export laws, and for filing all U.S. Electronic Export Information, as applicable.

b. The Customer acknowledges and agrees that: (i) it shall not violate applicable laws and regulations in performing its duties under this Agreement; (ii) it does not and shall not engage in any conduct that shall violate any applicable anti-bribery or anti-corruption laws or regulations; (iii) it (and its owners, officers, directors, employees and agents) shall not pay, offer, promise or authorize the payment of, either directly or indirectly, anything of value (including but not limited to cash, gifts and entertainment) to (a) any government official or employee of any government; (b) any official or employee of any department, agency, or instrumentality of a government; (c) any employee of any corporation or entity owned or controlled by a government; (d) any family member of such officials or employees; (e) any political party, party official, or political candidate; or (f) any other persons, owners, officers, directors, employees and agents of any corporation or entity; to improperly or illegally assist in obtaining or retaining business (including but not limited to any contracts, avoidance of duties or reduction of tariffs, reduction of taxes or

to obtain money owed, or to obtain regulatory approval) or for the purpose of causing, soliciting or inducing the sale and purchase of the Deliverables by any party, and (iv) it has full knowledge of and will comply with the Company's Code of Conduct for Business Partners as set forth on the Allegion customer website. **WHICH IS HEREBY INCORPORATED BY REFERENCE.**

c. The Customer shall indemnify and hold the Company harmless from any claim, demand, expense or cost arising from any breach of this Article.

d. The Customer shall permit the Company to conduct an audit or review of the Customer's financial books and records and business operations at such other times that the Company considers it necessary to confirm compliance with this provision. Such audit may be conducted by representatives of the Company or, at the Company's sole discretion, by a certified public accounting firm selected by the Company. The Customer shall cooperate with any inquiries from the Company's Ethics & Compliance Group.

e. A violation of this provision constitutes a material breach of this Agreement and the Company may terminate any purchase order or this Agreement immediately, with no opportunity to cure, in accordance with Section 27 of this Agreement.

f. Notwithstanding the foregoing provisions of this Section 33, (i) Company is not responsible for obtaining or maintaining any permits for the performance of services or the verification or compliance with any code requirements relative to the performance of services, (ii) to the extent any sale of Deliverables pursuant to this Agreement may require approval of the U.S. Government, Company's obligations under this Agreement are conditioned upon the grant of such approval and upon compliance by Customer with any restrictions imposed by the U.S. Government in connection with such approval, and (iii) in the event the Deliverables are to be used in a nuclear facility, the Customer shall, prior to such use, arrange for insurance or governmental indemnity protecting Company against liability. The Customer hereby releases and agrees to indemnify Company and its suppliers for any nuclear damage including, but not limited to, loss of use, in any manner arising out of the nuclear incident, whether alleged to be due, in whole or in part by Company or its suppliers.

g. **No Inducements.** Each party represents to each other that neither it nor any person acting on its behalf has, in contravention of any applicable law, given or offered to give or will give or offer to give, any sum of money or other material consideration to any person, directly or indirectly, as an inducement to obtain business hereunder or to influence the granting of licenses or other governmental permissions to enter into this Agreement or perform obligations hereunder.

h. **Equal Employment Opportunity.** Company is a U.S. federal contractor that complies with Executive Order 11246, as amended, and applicable regulations in 41 CFR Parts 60-1 through 60-60, 29 U.S.C. § 793 and applicable regulations in 41 CFR § 60-741; and 38 U.S.C. § 4212 and applicable regulations in 41 CFR Part 60-250 and 60-300. **THE FOLLOWING PROVISIONS ARE INCORPORATED HEREIN BY REFERENCE:** Executive Order 11246, as amended by Executive Order 13672, and 41 CFR § 60-4.3(a); Executive Order 11701 and 41 CFR §§ 60-250.5(a), 60-300.5; Executive Order 11758 and 41 CFR § 60-741.5(a); U.S. immigration laws, including the L-1 Visa Reform Act of 2004 and the H-1B Visa Reform Act of 2004; and Executive Order 13496.

i. **Ethical Business Conduct.** Customer shall adopt and comply with Company's Business Partner Code of Conduct which is **EXPRESSLY INCORPORATED HEREIN BY REFERENCE.**

34. REPRESENTATIONS AND WARRANTIES. Customer represents, warrants and covenants to Company that: (a) it has the right, power, and authority to enter into this Agreement and fully perform its obligations hereunder; (b) it has all necessary rights in and to its respective Content and Marks for use within the scope of this Agreement, including the licenses granted herein; and (c) it complies, and at all times shall comply, with all laws, rules, and regulations in effect that are applicable to its performance under this Agreement, including obtaining all such approvals and/or permits as may be required hereunder.

35. NO THIRD-PARTY BENEFICIARY. Each party is entering into this Agreement solely based on the representations contained herein for its own purposes and not for the benefit of any third party.

36. NOTICES AND CHANGE OF ADDRESS. All notices or other communications under this Agreement shall be in writing and delivered in person, or sent by receipted courier, express mail, e-mail, or postage prepaid certified or registered mail, addressed to the party for whom it is intended, at the addresses set forth in this Agreement. Either party may change its address for notice by giving written notice to the other party. Any notice or other communication shall be deemed given no later than the date actually received. Notice by courier, express mail, certified mail, or registered mail shall be deemed given on the date it is officially recorded as delivered and, in the absence of such record of delivery, it shall be rebuttably presumed to have been delivered on the third Business Day after it was deposited. Notices sent by e-mail require tangible confirmation of receipt from addressee.

37. ASSIGNMENT. Customer may not assign this Agreement without the prior written consent of Company. Company may assign its rights and delegate its duties under this Agreement, without the prior consent of Customer, to an Affiliate, or to a third party in the event of a spin-off, merger, business combination, consolidation or sale of all, or substantially all, of its assets or business that are related to this Agreement. The rights and duties in this Agreement shall bind and inure to the benefit of any such assignee.

38. SEVERABILITY. If any provision of this Agreement is held to be invalid, illegal, or unenforceable under any statute, regulation, ordinance, executive order, or other rule of law, that provision will be deemed severed to the extent necessary to comply with such statute, regulation, ordinance, order, or rule. In the event such provision is deemed severed, the parties will negotiate in good faith to arrive at an alternative arrangement approximating the original business objective of the parties. The remaining terms and conditions of this Agreement will remain in effect.

39. NO IMPLIED WAIVER. The failure of either party at any time to require performance by the other party of any provision of this Agreement will in no way affect the right to require such performance at any time thereafter, nor will the waiver of either party of a breach of any provision of this Agreement constitute a waiver of any succeeding breach of the same or any other provision.

40. MISCELLANEOUS. (a) This Agreement does not make either party the agent or legal representative of the other party. Neither party is authorized to create any obligation on behalf of the other party including, but not limited to, the obligation for payment of any service or warranty obligation hereunder; (b) The rights and remedies herein reserved to Company are cumulative and additional to any other rights and remedies provided at law or equity; (c) The official text of this Agreement is in the English language. If this Agreement is translated into another language, the English text will govern any question with respect to interpretation;

(d) The headings in this Agreement are for convenience of reference only and do not affect the meaning of this Agreement in any manner.

DEFINITIONS.

Capitalized terms have the meanings set forth in this Section, or in the Section in which they first appear in this Agreement.

"Agreement" means these Allegion Terms and Conditions of Sale and Service, together with any applicable Country Supplement or Region Supplement provided by Company, and all of the documents referenced herein or therein.

"Affiliate" means any Person that directly or indirectly, through one or more intermediaries, controls, is controlled by, or is under common control with, the Company. The term "control" (including the terms "controlled by" and "under common control with") means the possession, directly or indirectly, of the power to direct or cause the direction of the management and policies of a Person, whether through the ownership of voting securities, by contract or otherwise.

"Business Day" means any day except Saturday, Sunday or any other day on which commercial banks located in the United States are authorized or required by Law to be closed for business.

"Company" means Schlage Lock Company, LLC or any subsidiary or affiliate thereof selling products that are part of the Allegion product portfolio. Schlage Lock Company and/or its subsidiary or affiliates will be severally but not jointly liable under the Agreement.

"Company Marks" refers to the Marks of Company.

"Confidential Information" shall mean any and all information provided by either party to the other party pertaining to the disclosing party's business. Confidential Information shall include, but not be limited to, any bidding lists, formulae for products, manufacturing processes, production techniques, packaging processes, methods, research materials, ideas, marketing plans and related materials, quality standards, test results and data, apparatus, engineering drawings, contract documents, computer software, hardware, or firmware, business activities information such as financial information, reports, projections, books and records, customer and supplier information, and operations, customer and supplier lists and data, specifications, know how, and other Proprietary Information or Trade Secrets (as defined herein) that either party may furnish to the other party. Confidential Information shall not include information that:

(a) is or becomes publicly known if such public knowledge or disclosure is not the result of any act or failure to act on the part of the receiving party; (b) is, at the time of disclosure, already known to the Receiving Party without utilizing the Confidential Information; (c) is information disclosed to the Receiving Party by a third party which is not to the Receiving Party's knowledge, after inquiry of the third party, under a duty of confidentiality to the Disclosing Party; or (d) is independently developed by the Receiving Party without the use of Confidential Information. The Receiving Party shall have the burden of proof as to prior knowledge and absence of breach. Confidential Information may be furnished in any tangible or intangible form including, but not limited to, writings, drawings, computer and other electronic media, logic diagrams, component specifications, graphs, prototypes, samples, or verbal communications and regardless of whether such information is marked or designated as "confidential." For the avoidance of doubt, all information, knowledge or data disclosed by Company to Customer, regardless of whether disclosed in written, tangible, oral, visual or other form, including, without limitation, sample products, equipment, software, or other objects or material, provided by Company to Customer, and all information, knowledge or data which was obtained by Customer from visits to Company's facilities, shall be considered "Confidential Information" under this Agreement.

"Content" means all information (including without limitation any text, music, sound, photographs, video, graphics, data or software), in any medium, on a particular Company Web page or Website or in Marketing Materials.

"Customer" means the purchaser of Deliverables from Company.

"Deliverables" means any good or service or both purchased by Customer from Company under these General Terms and Conditions of Sale and Service.

"End Users" means the purchaser that (a) has acquired a Deliverable from Customer for (i) its own and its Affiliate's/Affiliates' internal use and not for resale, remarketing or distribution or (ii) incorporation into its own products and (b) is an individual or entity, other than any federal, state or local agency, office or division.

"IP" means all intellectual property and industrial property rights comprising or relating to/ of the following: (a) Patents; (b) Trademarks; (c) internet domain names, whether or not Trademarks, registered by any authorized private registrar or Governmental Authority, web addresses, web pages, website and URLs; (d) works of authorship, expressions, designs and design registrations, whether or not copyrightable, including copyrights and copyrightable works, software and firmware, application programming interfaces, architecture, files, records, schematics, data, data files, and databases and other specifications and documentation; (e) Trade Secrets; and (f) all other intellectual property and industrial property rights, and all rights, interests and protections that are associated with, equivalent or similar to, or required for the exercise of, any of the foregoing, however arising, in each case whether registered or unregistered and including all registrations and applications for, and renewals or extensions of, such rights or forms of protection pursuant to the Laws of any jurisdiction throughout in any part of the world.

"Marketing Materials" means all marketing brochures, buckslips, pamphlets, emails, text, call scripts or other material, whether in printed format, audio or audiovisual format, or in any other format, that contain any (i) Content relating to the Company Deliverables or (ii) Company Marks.

"Marks" means collectively the domain names, trademarks, trade names, service marks, trade dress, logos, and the like used or provided by either party for use in connection with this Agreement.

"Patents" means all patents (including all reissues, divisionals, provisionals, continuations and continuations-in-part, re-examinations, renewals, substitutions and extensions thereof), patent applications, and other patent rights and any other Governmental Authority-issued indicia of invention ownership (including inventor's certificates, petty patents and patent utility models).

"Person" means a person or entity.

"Price Books" mean Company's current Price Book in effect for the applicable Deliverable being purchased by Customer.

"Trade Secrets" means and includes business or technical information of either party, including processes, formulas, devices, techniques, compilations and other material that a party attempts to maintain in secret and that derive commercial value for such party from not being generally known to the public or readily ascertainable through independent development or reverse engineering.

How to use this book

Products are shown in four groups; Hinges, Continuous Hinges, Pivots and Architectural Hardware. Each group is organized in numerical order and no longer in alpha/numerical. Particularly in the Architectural Hardware group, the products are organized by the part number regardless of the prefix or suffix. Example WS33X Wall Stop will be in numerical sequence of 33; CS115 Crash Stop numerical sequence 115.

For convenience there are a few exceptions where an accessory follows the associated product; example, the COR72 Coordinator is followed by MBI Mounting Bracket.

The service parts section of previous books has been changed. Service parts for many products have been listed with the product. A full list of available service parts may be obtained from the Ives website. You may also contact your local sales representative or Ives customer service for more assistance on the availability of service parts.

Information contained in the list price table:

Model: Column contains model family description and general catalog information

Substrate: Column contains material substrate information (i.e. aluminum, brass, steel)

Model Number: Column contains the model number and additional prefix for other distinguishing features or packaging type. Package type prefix (SP) descriptions are as follows:

SP – Slim Pack

Item Number: Item number field is UPC number or sku number, where available.

Weight: Contains the total weight of product in box quantity. Not all weights shown.

Order Quantity: Contains the minimum order quantity for identified product, if required.

Box Quantity : Number of items in master carton or special package type.

Markings Cartons: Markings (e.g., door locations, stock reference numbers) on individual product cartons will be provided with no charge.

Products available to mark include the following:

Architectural Hinges	Push/Pull Plates
Continuous Hinges	Protection Plates
Pivots	Coordinators
8000 Series Pulls	Flush Bolts
9000 Series Push bars/Pull combinations	Vandal Resistant Trim

Lead Times: Stocked products will typically ship within 3-5 days. Made to order products will have a standard lead time of 2-3 weeks, unless otherwise noted. See product pages for specific exceptions. Purchase orders that combine made-to-order and stocked items will be held and shipped together.

Numerical Index

Part No.	Page	Part No.	Page	Part No.	Page	Part No.	Page	Part No.	Page
hinges									
3PB1	1, 2	DP2	27	COR52	35	FS439	48	VR900	57
3CB1	3, 4	2	27	FB52	36	FS441	48	VR904	57
3CB1 HW	5	LG7	27	FB53	36	WS443	48	VR900LLP	57
3CB1 WT	6, 7	COR7G	27	054	36	FS444	48	VR904LLP	57
3SP1	7	07	28	059	36	WS445	48	VR910DT	57
5PB1	8	COR9G	28	59	37	FS446	48	VR914DT	57
5PB1	9-10	FS9	28	060	37	WS447	49	VR910NL	57
5BB1 HW	11	LG10	28	60	37	FS448	49	VR914NL	57
5BB1 SC	12	CL11	28	COR60	37	WS449	49	VR910M-DT	57
5BB1 HW SC	12	LG11	28	061	38	FS450	49	VR910M-NL	57
5BB1 WT	13, 14	WS11	28	61	38	FS452	49	919	57
1010	15	WS11X	29	61	38	FS452	49	950	57
1011	15	CL12	29	61	39	SB453	49	955	58
1012	15	LG12	29	FB61	39	SB453	50	960	58
1020	15	FS13	29	FB62	39	FS455	50	962	58
1021	15	LG13	29	63	39	FB457	50	990	58
continuous hinges									
600	16	CL14	29	64	39	FB458	50	991	58
602	16	LG14	29	SR64	39	RB470	50	RL1152	59
611	16	FS17	29	WS65	39	RB471	50	FS1153/FS1154	59
700	16	R14	29	SR65	39	RB472	50	SB1600M1	59
702	16	AS18	29	SR66	39	481	51	SB1600M2	59
705	16	FS18	29	066	40	482	51	SB1630	60
711	16	FL20	29	66	40	482 s	51	SB1640	60
715	16	WS20	29	69	40	482 s	51	3125	61
700CS	18	WS20X	30	70	40, 41	482 s	51	31251/31252	61
711CS	18	CL21/21A	30	71	41	FS495	51	8102HD	65
715CS	18	CL22	30	72	41	FS496	51	8103HD	65, 66
026XY	19	22	30	COR72	41	FS497	51	8103EZHD	66
027XY	19	25	30	73	41	FS544	51	8105	67
040XY	19	026	30, 31	90	41	FS555	51	8111	67
041XY	19	RL30	31	CS115	41	506	52	8112	67
045XY	19	RL30A	31	HB159	41	507	52	8121	68
046XY	19	FB31	31	218	42	507B	52	8145EZHD	68
053XY	20	COR32	31	221	42	508	52	8169	68
054XY	20	COR42	31	222	42	508C	52	8181	69
112HD	20	COR52	32	223	42	509C	52	8189	69
112XY	20	COR60	32	227	42	510C	52	8190HD	69
114XY	20	COR72	32	230	42	510BC	52	8190EZHD	70
157XY	20	FL20	32	253	43	511BC	52	8200	71
210XY	21	FL32	32	253	43	543	52	8281	72
224HD	21	FL44	32	253	43	543B	52	8302	72, 73
224XY	21	MB1	32	261	43	554	52	8303	74, 75
pivots									
7212	24	MB1F & MB1V	32	262	43	559B	53	8305	75, 76
7212V	24	MB2	32	262	43	571	53	8312	77
7215	24	MB2F & MB2V	32	265	43	572	53	8320	77
7215F	24	MB3F & MB3V	32	265	43	574	54	8311	77
7222	24	FB32	33	299	43, 44	575	54	8371	78
7226	24	COR32	33	325	44	580	54	8372	78
7226F	25	FL32	33	326	44	581	54, 55	8400	79, 80
7227	25	RL32	33	327	44	582	55	8700	82
7227F	25	RL32A	33	330	44	585/586	55	8800	82
7230F	25	FB33	33	335	44	601	55	8848	82
7237F	25	WS33	33	336	44	620	55	8975	82
7244F	25	WS33X	33	345	45	620	56	9100HD	83
7245F	26	RL36/36A	33	347	45	STK685	56	9103EZHD	83
7253	26	RL38	33	349	45	STK685L	56	9145EZHD	84
7255	26	40	33, 34	FB358	45	U696	56	9190HD	85
7255J	26	FS40	34	SB360	45	696-700-701	56	9190EZHD	86
7256	26	WS40	34	401/402CVX	45	696-700-701	56	9264	87
7259	26	FB41	34	WS404-CVX	46	698	56	9264F	87
91105F	26	FS41	34	405	46	698	56	9266	87
architectural hardware									
CB1	27	FL44	35	406/407CVX	46	698	56	9266F	87
DP1	27	WS45	35	406/407CCV	46	700	56		
LG1	27	WS45X	35	FS410	47	701	56		
		S48	35	411	47	VR810DT	57		
		FB51	35	430	47	VR814DT	57		
				FS434	47	VR810NL	57		
				R435	47	VR814NL	57		
				FS436	47	VR810NL-V	57		
				R437	47	VR814NL-V	57		
				FS438	48	AS895	57		

Key to Finishes

	IVES FINISH	ANSI/BHMA	US Number	Finish Description	Base Material
HINGES	A3	666	US3	Bright Brass, Clear Coat	Aluminum
	A4	667	US4	Satin Brass, Clear Coat	Aluminum
	A5		US5	Brass, Blackened, Satin Relieved	Aluminum
	A10	668	US10	Satin Bronze, Clear Coat	Aluminum
	A10B	703	US10B	Dark Bronze, Oil Rubbed	Aluminum
	A14	669	US14	Bright Nickel, Clear Coat	Aluminum
CONTINUOUS HINGES	A15	670	US15	Satin Nickel, clear Coat	Aluminum
	A26	672	US26	Bright Chrome	Aluminum
	A26D	702	US26D	Satin Chrome	Aluminum
	A-643E/716			Aged Bronze, Blackened, Edge Relieved	Aluminum
	A92	673		Aluminum Clear Coat	Aluminum
	A-BLK			Matte Black	Aluminum
	A-W			White	Aluminum
		627	US27	Satin Aluminum, Clear Coated	Aluminum
		441		Satin Stainless Anodized	Aluminum
		PA28	628	US28	Satin Aluminum, Clear Anodized
PIVOTS		688		Satin Brass Anodized	Aluminum
		709		Satin Bronze Anodized	Aluminum
		710	313AN	Dark Bronze Anodized	Aluminum
		711	315AN	Black Anodized	Aluminum
		712		Bright Chrome Anodized	Aluminum
		713		Satin Chrome Anodized	Aluminum
Numerical 1-059	B3	605	US3	Bright Brass, Clear Coat	Brass/Bronze
	B4	606	US4	Satin Brass, Clear Coat	Brass/Bronze
	B5	609	US5	Satin Brass, Blackened, Satin Relieved	Brass/Bronze
	B9	611	US9	Bright Bronze, Clear Coat	Brass/Bronze
	B10	612	US10	Satin Bronze, Clear Coat	Brass/Bronze
	B10B	613	US10B	Dark Bronze, Oil Rubbed	Brass/Bronze
		614	US10A	Satin Bronze, Relieved, Clear Coated	Brass/Bronze
		616	US11	Satin Bronze, Blackened, Clear Coated	Brass/Bronze
	B14	618	US14	Bright Nickel, Clear Coat	Brass/Bronze
	B15	619	US15	Satin Nickel, Clear Coat	Brass/Bronze
Numerical 59-437	B15A	620	US15A	Satin Nickel, Blackened, Satin Relieved	Brass/Bronze
	B26	625	US26	Bright Chrome	Brass/Bronze
	B26D	626	US26D	Satin Chrome	Brass/Bronze
	B-643E/716			Aged Bronze, Blackened, Edge Relieved	Brass/Bronze
	B-BLK	622		Matte Black	Brass/Bronze
		603	US2G	Zinc Plated	Steel
	F2C	604	US2C	Zinc Plated	Steel
	F3	632	US3	Bright Brass, Clear Coat	Steel
	F4	633	US4	Satin Brass, Clear Coat	Steel
	F5	638	US5	Satin Brass, Blackened, Satin Relieved	Steel
Numerical 438-1021	F10	639	US10	Satin Bronze, Clear Coat	Steel
	F10B	640	US10B	Dark Bronze, Oil Rubbed	Steel
		641	US10A	Oxidized Satin Bronze, Relieved, Clear Coated	Steel
		643	US11	Satin Bronze, Blackened, Relieved, Clear Coated	Steel
	F14	645	US14	Bright Nickel, Clear Coat	Steel
	F15	646	US15	Satin Nickel, Clear Coated	Steel
	F15A	647	US15A	Satin Nickel, Blackened, Relieved, Clear Coated	Steel
	F26	651	US26	Bright Chrome	Steel
	F26D	652	US26D	Satin Chrome	Steel
	F-643E/716			Aged Bronze, Blackened, Edge Relieved	Steel
Numerical 8200-9266	F-BLK	622		Matte Black	Steel
	F-W			White	Steel
	SP4			Dull Brass Painted	All
	SP10	691		Dull Bronze Painted	All

Key to Finishes

IVES FINISH	ANSI/BHMA	US Number	Finish Description	Base Material
SP28	689		Aluminum Painted	All
SP313	695		Dark Bronze Painted	All
SPBLK	622		Matte Black	All
USP	600	USP	Primed For Paint	All
US32	629	US32	Bright Stainless Steel	Stainless Steel
US32-316	629-316	US32-316	Bright Stainless Steel - 316 Series	Stainless Steel - 316
US32D	630	US32D	Satin Stainless Steel	Stainless Steel
US32D-316	630-316	US32D-316	Satin Stainless Steel - 316 Series	Stainless Steel - 316
US32D	654		Satin Stainless Steel	Stainless Steel
Z605	677	US3	Bright Brass, Clear Coat	Zinc
	678	US4	Satin Brass, Clear Coat	Zinc
Z609		US5	Satin Brass, Blackened, Satin Relieved	Zinc
Z613	704	US10B	Dark Bronze, Oil Rubbed	Zinc
Z619		US15	Satin Nickel, Clear Coat	Zinc
Z625	681	US26	Bright Chrome	Zinc
	682	US26D	Satin Chrome	Zinc
Z-643E/716			Aged Bronze, Blackened, Edge Relieved	Zinc
Z-BLK	676		Matte Black	Zinc
Z-W			White	Zinc
CLR			Clear	Plastic
BLK			Matte Black	Rubber or Plastic
WHT			White	Rubber or Plastic
GRY			Grey	Rubber
TAN			Tan	Rubber
BRN			Brown	Rubber

HINGES

CONTINUOUS
HINGES

PIVOTS

Numerical
1-059Numerical
59-437Numerical
438-1021Numerical
1152-8190Numerical
8200-9266

Custom Finishes

Optional powder coat finishes are available on many Ives products. To have a specific color matched and to determine powder coat availability please contact:

TIGER Drylac U.S.A., Inc.
1100 Commons Blvd.
Reading, PA 19605 USA
800-243-8148
www.tiger-coatings.us

Powder coat must be selected from Tiger Drylac **Series 38 or 49**.

Please specify **both** the full powder coat product number and the RAL number when placing your order.

Example: 49/15320 RAL 1015

Notes

HINGES
CONTINUOUS HINGES
PIVOTS
Numerical 1-059
Numerical 59-437
Numerical 438-1021
Numerical 1152-8190
Numerical 8200-9266

Contact Ives Customer Service for pricing on additional sizes and finishes

Bold pricing indicates item is in stock and available for **Fast Track** and **ProXpress**

DESCRIPTION	SIZE	STEEL BASED		BRASS / STAINLESS BASED		US REFERENCE	BOX	CASE	NOTES
		BHMA FINISH	LIST	BHMA FINISH	LIST				
 <p>Three Knuckle Plain Bearing Standard Weight</p> <p>For use on standard weight doors with medium frequency usage</p> <p>Available in: Steel w/Steel Pin Brass w/Brass Pin Stainless w/Stainless Pin</p> <p>Non-removable Pin (Steel and Stainless Steel Based 4.5 x 4.5 Hinges add \$4.25 all others add \$9.00 list)</p> <p>Packed with: Wood and machine screws</p> <p>Available options: SEC - Security Screws HT - Hospital tip RC - Round corners SH - Security Studs See page 14 for pricing</p>	3.5"x3.5" (89x89mm)	600	\$12.20	----	\$ ----	USP	3	24	
		632	17.90	605	62.50	US3	3	24	
		633	12.80	606	52.00	US4	3	24	
		639	13.60	612	48.50	US10	3	24	
		640	17.90	613	62.50	US10B	3	24	
		641	17.90	614	62.50	US10A	3	24	
		643	18.90	616	62.50	US11	3	24	
		F643E/716	18.90	B643E/716	62.50	US11E	3	24	
		646	18.90	619	62.50	US15	3	24	
		651	17.90	625	66.00	US26	3	24	
		652	15.00	626	59.00	US26D	3	24	652 finish Stocked
		F-BLK	13.60	B-BLK	48.50	US19	3	24	
		----	----	629	71.40	US32	3	24	
		----	----	630	68.60	US32D	3	24	
		4"x4" (102x102mm)	600	13.50	----	----	USP	3	24
	632	19.90	605	70.30	US3	3	24		
	633	14.10	606	58.40	US4	3	24		
	639	15.00	612	54.70	US10	3	24		
	640	19.90	613	70.40	US10B	3	24		
	641	19.90	614	70.40	US10A	3	24		
	643	20.90	616	70.40	US11	3	24		
	F643E/716	20.90	B643E/716	62.50	US11E	3	24		
	646	20.90	619	70.40	US15	3	24		
	651	19.90	625	74.20	US26	3	24		
	652	16.80	626	66.40	US26D	3	24		
	F-BLK	15.00	B-BLK	54.70	US19	3	24		
	----	----	629	80.50	US32	3	24		
	----	----	630	77.30	US32D	3	24		
	4.5"x4" (114x102mm)	600	7.30	----	----	USP	3	24	
	632	14.30	605	40.60	US3	3	24		
	633	7.30	606	33.90	US4	3	24		
	639	8.80	612	31.60	US10	3	24		
	640	12.90	613	40.60	US10B	3	24		
	641	13.80	614	40.60	US10A	3	24		
	643	14.30	616	40.60	US11	3	24		
	F643E/716	14.30	B643E/716	40.60	US11E	3	24		
	646	14.30	619	40.60	US15	3	24		
	651	14.30	625	42.80	US26	3	24		
	652	10.90	626	38.30	US26D	3	24	652 finish Stocked	
	F-BLK	8.80	B-BLK	31.60	US19	3	24		
	----	----	629	46.30	US32	3	24		
	----	----	630	45.00	US32D	3	24		
	4.5"x4.5" (114x114mm)	600	7.30	----	----	USP	3	24	
	632	14.30	605	40.60	US3	3	24		
	633	7.30	606	33.90	US4	3	24		
639	8.80	612	31.60	US10	3	24			
640	14.30	613	40.60	US10B	3	24			
641	14.30	614	40.60	US10A	3	24			
643	14.30	616	40.60	US11	3	24			
F643E/716	14.30	B643E/716	40.60	US11E	3	24			
646	14.30	619	40.60	US15	3	24			
651	14.30	625	42.80	US26	3	24			
652	8.30	626	38.30	US26D	3	24	652 finish Stocked		
F-BLK	8.80	B-BLK	31.60	US19	3	24			
----	----	629	46.30	US32	3	24			
----	----	630	45.00	US32D	3	24			

Note: Specify BHMA finish code when ordering.

 Indicates products that have EPD documentation available and meet LEED v4.

Contact Ives Customer Service for pricing on additional sizes and finishes

Bold pricing indicates item is in stock and available for **Fast Track** and **ProXpress**

HINGES
 CONTINUOUS HINGES
 PIVOTS
 Numerical 1-059
 Numerical 59-437
 Numerical 438-1021
 Numerical 1152-8190
 Numerical 8200-9266

HINGES
 CONTINUOUS HINGES
 PIVOTS
 Numerical 1-059
 Numerical 59-437
 Numerical 438-1021
 Numerical 1152-8190
 Numerical 8200-9266

DESCRIPTION	SIZE	STEEL BASED		BRASS / STAINLESS BASED		US REFERENCE	BOX	CASE	NOTES
		BHMA FINISH	LIST	BHMA FINISH	LIST				
 <p>3PB1</p> <p>Three Knuckle Plain Bearing Standard Weight</p> <p>For use on standard weight doors with medium frequency usage</p>	5"x4.5" (127x114mm)	600	\$34.70	----	\$ ----	USP	3	24	
		632	51.90	605	95.10	US3	3	24	
		633	36.80	606	79.10	US4	3	24	
		639	38.80	612	73.80	US10	3	24	
		640	51.90	613	95.10	US10B	3	24	
		641	51.90	614	95.10	US10A	3	24	
		643	53.90	616	95.10	US11	3	24	
		F643E/716	53.90	B643E/716	95.10	US11E	3	24	
		646	53.90	619	95.10	US15	3	24	
		651	51.90	625	100.20	US26	3	24	
		652	43.20	626	89.80	US26D	3	24	
		F-BLK	38.80	B-BLK	73.80	US19	3	24	
		----	----	629	108.70	US32	3	24	
		----	----	630	104.50	US32D	3	24	

Note: Specify BHMA finish code when ordering.

 Indicates products that have EPD documentation available and meet LEED v4.

Contact Ives Customer Service for pricing on additional sizes and finishes

Bold pricing indicates item is in stock and available for **Fast Track** and **ProXpress**

DESCRIPTION	SIZE	STEEL BASED		BRASS / STAINLESS BASED		US REFERENCE	BOX	CASE	NOTES
		BHMA FINISH	LIST	BHMA FINISH	LIST				
 <p>Three Knuckle Concealed Bearing Standard Weight</p> <p>For use on standard weight doors with medium frequency usage</p> <p>Available in: Steel w/Steel Pin Brass w/Brass Pin Stainless w/Stainless Pin</p> <p>Non-removable Pin (Steel and Stainless Steel Based 4.5 x 4.5 Hinges add \$4.25 all others add \$9.00 list)</p> <p>Packed with: Wood and machine screws</p> <p>Available options: SEC - Security Screws HT - Hospital tip RC - Round corners SH - Security Studs</p> <p>TW - Electric Thru Wire See page 14 for pricing and available sizes</p>	3.5"x3.5" (89x89mm)	600	\$27.90	----	\$ ----	USP	3	24	
		632	42.40	605	61.30	US3	3	24	
		633	30.00	606	50.90	US4	3	24	
		639	31.80	612	47.50	US10	3	24	
		640	42.40	613	61.30	US10B	3	24	
		641	42.40	614	61.30	US10A	3	24	
		643	44.20	616	61.30	US11	3	24	
		F643E/716	44.20	B643E/716	61.30	US11E	3	24	
		646	44.20	619	61.30	US15	3	24	
		651	42.40	625	64.70	US26	3	24	
		652	35.40	626	57.90	US26D	3	24	
		F-BLK	31.80	B-BLK	47.50	US19	3	24	
		----	----	629	70.10	US32	3	24	
		----	----	630	67.30	US32D	3	24	
		4"x4" (102x102mm)	600	30.20	----	----	USP	3	24
	632		45.50	605	69.00	US3	3	24	
	633		32.10	606	57.40	US4	3	24	
	639		34.20	612	53.70	US10	3	24	
	640		45.50	613	69.00	US10B	3	24	
	641		45.50	614	69.00	US10A	3	24	
	643		47.40	616	69.00	US11	3	24	
	F643E/716		47.40	B643E/716	69.00	US11E	3	24	
	646		47.40	619	69.00	US15	3	24	
	651		45.50	625	72.90	US26	3	24	
	652		38.00	626	65.20	US26D	3	24	
	F-BLK		34.20	B-BLK	53.70	US19	3	24	
	----		----	629	79.00	US32	3	24	
	----		----	630	75.90	US32D	3	24	630 finish Stocked
	4.5"x4" (114x102mm)		600	17.10	----	----	USP	3	24
		632	24.00	605	60.70	US3	3	24	
		633	17.10	606	50.50	US4	3	24	
		639	18.60	612	47.30	US10	3	24	
		640	17.10	613	60.70	US10B	3	24	640 finish Stocked
		641	17.10	614	60.70	US10A	3	24	
		643	24.00	616	60.70	US11	3	24	
		F643E/716	24.00	B643E/716	60.70	US11E	3	24	
		646	26.60	619	60.70	US15	3	24	646 finish Stocked
		651	24.00	625	64.30	US26	3	24	
		652	20.20	626	57.20	US26D	3	24	652 finish Stocked
		F-BLK	18.60	B-BLK	47.30	US19	3	24	
		----	----	629	69.60	US32	3	24	
		----	----	630	61.70	US32D	3	24	630 finish Stocked
4.5"x4.5" (114x114mm)		600	10.80	----	----	USP	3	24	600 finish Stocked
	632	24.00	605	67.40	US3	3	24		
	633	17.10	606	50.50	US4	3	24		
	639	18.60	612	47.30	US10	3	24	639 finish Stocked	
	640	22.70	613	63.60	US10B	3	24	640 & 613 finish Stocked	
	641	22.70	614	60.70	US10A	3	24	641 finish Stocked	
	643	22.70	616	60.70	US11	3	24	643 finish Stocked	
	F643E/716	22.70	B643E/716	60.70	US11E	3	24		
	646	22.70	619	50.30	US15	3	24	646 finish Stocked	
	651	22.70	625	64.30	US26	3	24	651 finish Stocked	
	652	13.30	626	54.00	US26D	3	24	652 & 626 finish Stocked	
	F-BLK	18.60	B-BLK	47.30	US19	3	24	F-BLK finish Stocked	
	----	----	629	69.60	US32	3	24		
	----	----	630	63.00	US32D	3	24	630 finish Stocked	

Note: Specify BHMA finish code when ordering.

 Indicates products that have EPD documentation available and meet LEED v4.

Contact Ives Customer Service for pricing on additional sizes and finishes

Bold pricing indicates item is in stock and available for **Fast Track** and **ProXpress**

HINGES
 CONTINUOUS HINGES
 PIVOTS
 Numerical 1-059
 Numerical 59-437
 Numerical 438-1021
 Numerical 1152-8190
 Numerical 8200-9266

DESCRIPTION	SIZE	STEEL BASED		BRASS / STAINLESS BASED		US REFERENCE	BOX	CASE	NOTES
		BHMA FINISH	LIST	BHMA FINISH	LIST				
 <p>Full Mortise Three Knuckle Concealed Bearing Standard Weight</p> <p>For use on standard weight doors with medium frequency usage</p> <p>Available in: Steel w/Steel Pin Brass w/Brass Pin Stainless w/Stainless Pin</p> <p>Non-removable Pin (Steel and Stainless Steel Based 4.5 x 4.5 Hinges add \$4.25 all others add \$9.00 list)</p> <p>Packed with: Wood and machine screws</p> <p>Available options: SEC - Security Screws HT - Hospital tip RC - Round corners SH - Security Studs TW - Electric Thru Wire See page 14 for pricing</p>	5"x4.5" (127x114mm)	600	\$25.60	----	\$ ----	USP	3	24	
		632	38.20	605	75.40	US3	3	24	
		633	26.90	606	63.00	US4	3	24	
		639	28.70	612	58.90	US10	3	24	
		640	38.20	613	75.40	US10B	3	24	
		641	38.20	614	75.40	US10A	3	24	
		643	39.70	616	75.40	US11	3	24	
		F643E/716	39.70	B643E/716	75.40	US11E	3	24	
		646	39.70	619	75.40	US15	3	24	
		651	38.20	625	79.80	US26	3	24	
		652	30.00	626	71.40	US26D	3	24	652 finish Stocked
		F-BLK	28.70	B-BLK	58.90	US19	3	24	
		----	----	629	86.60	US32	3	24	
		----	----	630	77.40	US32D	3	24	630 finish Stocked
	5"x5" (127x127mm)	600	45.60	----	----	USP	3	24	
		632	68.50	605	75.40	US3	3	24	
		633	48.60	606	63.00	US4	3	24	
		639	51.40	612	58.90	US10	3	24	
		640	68.50	613	75.40	US10B	3	24	
		641	68.50	614	75.40	US10A	3	24	
		643	71.40	616	75.40	US11	3	24	
		F643E/716	71.40	B643E/716	75.40	US11E	3	24	
		646	71.40	619	75.40	US15	3	24	
		651	68.50	625	79.80	US26	3	24	
		652	57.00	626	71.40	US26D	3	24	
		F-BLK	51.40	B-BLK	58.90	US19	3	24	
		----	----	629	86.60	US32	3	24	
		----	----	630	83.40	US32D	3	24	630 finish Stocked

Note: Specify BHMA finish code when ordering.

 Indicates products that have EPD documentation available and meet LEED v4.

Contact Ives Customer Service for pricing on additional sizes and finishes

Bold pricing indicates item is in stock and available for **Fast Track** and **ProXpress**

DESCRIPTION	SIZE	STEEL BASED		BRASS / STAINLESS BASED		US REFERENCE	BOX	CASE	NOTES
		BHMA FINISH	LIST	BHMA FINISH	LIST				
 <p>Full Mortise Three Knuckle Concealed Bearing Heavy Weight</p> <p>For use on heavy weight doors with medium frequency usage</p> <p>Available in: Steel w/Steel Pin Brass w/Brass Pin Stainless w/Stainless Pin</p> <p>Non-removable Pin (Steel and Stainless Steel Based 4.5 x 4.5 Hinges add \$4.25 all others add \$9.00 list)</p> <p>Packed with: Wood and machine screws</p> <p>Available options: SEC - Security Screws HT - Hospital tip RC - Round corners SH - Security Studs TW - Electric Thru Wire See page 14 for pricing</p>	4.5"x4" (114x102mm)	600	\$44.20	----	\$ ----	USP	3	24	
		632	56.80	605	111.90	US3	3	24	
		633	44.20	606	77.60	US4	3	24	
		639	47.00	612	72.20	US10	3	24	
		640	58.00	613	92.90	US10B	3	24	
		641	58.00	614	92.90	US10A	3	24	
		643	56.80	616	92.90	US11	3	24	
		F643E/716	56.80	B643E/716	92.90	US11E	3	24	
		646	60.30	619	71.70	US15	3	24	
		651	56.80	625	98.10	US26	3	24	
		652	45.60	626	88.00	US26D	3	24	652 finish Stocked
		F-BLK	47.00	B-BLK	72.20	US19	3	24	
		----	----	629	106.60	US32	3	24	
		----	----	630	96.60	US32D	3	24	630 finish Stocked
		4.5"x4.5" (114x114mm)	600	41.70	----	----	USP	3	24
	632		56.80	605	111.90	US3	3	24	
	633		44.20	606	77.60	US4	3	24	
	639		47.00	612	72.20	US10	3	24	
	640		58.00	613	92.90	US10B	3	24	640 finish Stocked
	641		58.00	614	92.90	US10A	3	24	
	643		56.80	616	92.90	US11	3	24	
	F643E/716		56.80	B643E/716	92.90	US11E	3	24	
	646		53.70	619	71.70	US15	3	24	646 finish Stocked
	651		56.80	625	98.10	US26	3	24	
	652		45.60	626	88.00	US26D	3	24	652 & 626 finish Stocked
	F-BLK		47.00	B-BLK	72.20	US19	3	24	
	----		----	629	106.60	US32	3	24	
	----		----	630	96.60	US32D	3	24	630 finish Stocked
	5"x4.5" (127x114mm)		600	51.10	----	----	USP	3	24
		632	66.90	605	126.50	US3	3	24	
		633	51.10	606	88.30	US4	3	24	
		639	54.00	612	82.40	US10	3	24	
		640	66.90	613	106.10	US10B	3	24	
		641	66.90	614	106.10	US10A	3	24	
		643	66.90	616	106.10	US11	3	24	
		F643E/716	66.90	B643E/716	106.10	US11E	3	24	
		646	69.30	619	84.90	US15	3	24	
		651	66.90	625	111.80	US26	3	24	
		652	52.40	626	100.40	US26D	3	24	652 finish Stocked
		F-BLK	54.00	B-BLK	82.40	US19	3	24	
		----	----	629	121.30	US32	3	24	
		----	----	630	110.10	US32D	3	24	630 finish Stocked
		5"x5" (127x127mm)	600	51.10	----	----	USP	3	24
	632		66.90	605	126.50	US3	3	24	
	633		51.10	606	88.30	US4	3	24	
639	54.00		612	82.40	US10	3	24		
640	66.90		613	106.10	US10B	3	24		
641	66.90		614	106.10	US10A	3	24		
643	66.90		616	106.10	US11	3	24		
F643E/716	66.90		B643E/716	106.10	US11E	3	24		
646	69.30		619	84.90	US15	3	24		
651	66.90		625	111.80	US26	3	24		
652	55.60		626	100.40	US26D	3	24		
F-BLK	54.00		B-BLK	82.40	US19	3	24		
----	----		629	121.30	US32	3	24		
----	----		630	116.70	US32D	3	24	630 finish Stocked	

Note: Specify BHMA finish code when ordering.

 Indicates products that have EPD documentation available and meet LEED v4.

Contact Ives Customer Service for pricing on additional sizes and finishes

Bold pricing indicates item is in stock and available for **Fast Track** and **ProXpress**

HINGES
 CONTINUOUS HINGES
 PIVOTS
 Numerical 1-059
 Numerical 59-437
 Numerical 438-1021
 Numerical 1152-8190
 Numerical 8200-9266

DESCRIPTION	SIZE	STEEL BASED		BRASS / STAINLESS BASED		US REFERENCE	BOX	CASE	NOTES
		BHMA FINISH	LIST	BHMA FINISH	LIST				
 <p>Three Knuckle Concealed Bearing Wide Throw Standard Weight</p> <p>For use on standard weight doors with medium frequency usage</p> <p>Available in: Steel w/Steel Pin</p> <p>Non-removable Pin (add \$9.00 List)</p> <p>Packed with: Wood and machine screws</p> <p>Available options: SEC - Security Screws HT - Hospital tip RC - Round corners SH - Security Studs TW - Electric Thru Wire See page 14 for pricing</p>	4.5"x5" (127x114mm)	600	\$137.90	----	\$ ----	USP	3	24	
		632	206.70	605	----	US3	3	24	
		633	146.30	606	----	US4	3	24	
		639	154.80	612	----	US10	3	24	
		640	206.70	613	----	US10B	3	24	
		641	206.70	614	----	US10A	3	24	
		643	215.40	616	----	US11	3	24	
		F643E/716	215.40	B643E/716	----	US11E	3	24	
		646	215.40	619	----	US15	3	24	
		651	206.70	625	----	US26	3	24	
		652	172.10	626	----	US26D	3	24	
		F-BLK	154.80	B-BLK	----	US19	3	24	
		----	----	629	----	US32	3	24	
		----	----	630	----	US32D	3	24	
		4.5"x6" (114x152mm)	600	145.60	----	----	USP	3	24
	632		218.50	605	----	US3	3	24	
	633		154.60	606	----	US4	3	24	
	639		163.80	612	----	US10	3	24	
	640		218.50	613	----	US10B	3	24	
	641		218.50	614	----	US10A	3	24	
	643		227.80	616	----	US11	3	24	
	F643E/716		227.80	B643E/716	----	US11E	3	24	
	646		227.80	619	----	US15	3	24	
	651		218.50	625	----	US26	3	24	
	652		181.90	626	----	US26D	3	24	
	F-BLK		163.80	B-BLK	----	US19	3	24	
	----		----	629	----	US32	3	24	
	----		----	630	----	US32D	3	24	
	5"x6" (127x152mm)		600	153.70	----	----	USP	3	24
		632	230.30	605	----	US3	3	24	
		633	163.20	606	----	US4	3	24	
		639	172.50	612	----	US10	3	24	
		640	230.30	613	----	US10B	3	24	
		641	230.30	614	----	US10A	3	24	
		643	240.00	616	----	US11	3	24	
		F643E/716	240.00	B643E/716	----	US11E	3	24	
		646	240.00	619	----	US15	3	24	
		651	230.30	625	----	US26	3	24	
		652	191.90	626	----	US26D	3	24	
		F-BLK	172.50	B-BLK	----	US19	3	24	
		----	----	629	----	US32	3	24	
		----	----	630	----	US32D	3	24	
		5"x7" (127x178mm)	600	157.50	----	----	USP	3	24
	632		236.30	605	----	US3	3	24	
	633		167.20	606	----	US4	3	24	
639	177.20		612	----	US10	3	24		
640	236.30		613	----	US10B	3	24		
641	236.30		614	----	US10A	3	24		
643	245.80		616	----	US11	3	24		
F643E/716	245.80		B643E/716	----	US11E	3	24		
646	245.80		619	----	US15	3	24		
651	236.30		625	----	US26	3	24		
652	196.90		626	----	US26D	3	24		
F-BLK	177.20		B-BLK	----	US19	3	24		
----	----		629	----	US32	3	24		
----	----		630	----	US32D	3	24		

Note: Specify BHMA finish code when ordering.

Contact Ives Customer Service for pricing on additional sizes and finishes

Bold pricing indicates item is in stock and available for **Fast Track** and **ProXpress**

HINGES
 CONTINUOUS HINGES
 PIVOTS
 Numerical 1-059
 Numerical 59-437
 Numerical 438-1021
 Numerical 1152-8190
 Numerical 8200-9266

DESCRIPTION	SIZE	STEEL BASED		BRASS / STAINLESS BASED		US REFERENCE	BOX	CASE	NOTES
		BHMA FINISH	LIST	BHMA FINISH	LIST				
3CBI WT  Three Knuckle Concealed Bearing Wide Throw Standard Weight For use on standard weight doors with medium frequency usage	5"x8" (127x204mm)	600	\$169.00	----	\$ ----	USP	3	24	
		632	254.00	605	----	US3	3	24	
		633	180.00	606	----	US4	3	24	
		639	190.50	612	----	US10	3	24	
		640	254.00	613	----	US10B	3	24	
		641	254.00	614	----	US10A	3	24	
		643	264.40	616	----	US11	3	24	
		F643E/716	264.40	B643E/716	----	US11E	3	24	
		646	264.40	619	----	US15	3	24	
		651	254.00	625	----	US26	3	24	
		652	211.60	626	----	US26D	3	24	
		F-BLK	190.50	B-BLK	----	US19	3	24	
		----	----	629	----	US32	3	24	
		----	----	630	----	US32D	3	24	

DESCRIPTION	SIZE	STEEL BASED		BRASS / STAINLESS BASED		US REFERENCE	BOX	CASE	NOTES		
		BHMA FINISH	LIST	BHMA FINISH	LIST						
3SP1  Spring Hinge Standard Weight UL listed for use on fire-rated doors Available in: Steel w/ Steel Pin Stainless w/ Stainless Pin Packed with: Wood and machine screws Available options: SEC - Security Screws RC - Round corners See page 14 for pricing	4"x4" (102x102mm)	600	\$19.30	----	\$	USP	3	24			
		632	27.60	605	----	US3	3	24	632 finish Stocked		
		633	22.10	606	----	US4	3	24	633 finish Stocked		
		639	24.90	612	----	US10	3	24			
		640	31.70	613	----	US10B	3	24	640 finish Stocked		
		641	30.30	614	----	US10A	3	24			
		643	27.60	616	----	US11	3	24			
		F643E/716	27.60	B643E/716	----	US11E	3	24			
		646	27.60	619	----	US15	3	24	646 finish Stocked		
		651	27.60	625	----	US26	3	24			
		652	24.90	626	----	US26D	3	24	652 finish Stocked		
		F-BLK	24.90	B-BLK	----	US19	3	24			
		----	----	629	----	US32	3	24			
		----	----	630	61.80	US32D	3	24	630 finish Stocked		
		4.5"x4" (114x102mm)	600	19.30	----	----	----	USP	3	24	
			632	27.60	605	----	----	US3	3	24	632 finish Stocked
			633	22.10	606	----	----	US4	3	24	
			639	24.90	612	----	----	US10	3	24	639 finish Stocked
	640		31.70	613	----	----	US10B	3	24	640 finish Stocked	
	641		30.30	614	----	----	US10A	3	24		
	643		27.60	616	----	----	US11	3	24		
	F643E/716		27.60	B643E/716	----	----	US11E	3	24		
	646		27.60	619	----	----	US15	3	24		
	651		27.60	625	----	----	US26	3	24		
	652		24.90	626	----	----	US26D	3	24	652 finish Stocked	
	F-BLK		24.90	B-BLK	----	----	US19	3	24		
	----		----	629	----	----	US32	3	24		
	----		----	630	61.80	US32D	3	24	630 finish Stocked		
	4.5"x4.5" (114x114mm)		600	18.50	----	----	----	USP	3	24	600 finish Stocked
			632	26.40	605	----	----	US3	3	24	632 finish Stocked
			633	21.20	606	----	----	US4	3	24	633 finish Stocked
			639	24.00	612	----	----	US10	3	24	639 finish Stocked
		640	30.40	613	----	----	US10B	3	24	640 finish Stocked	
		641	29.00	614	----	----	US10A	3	24	641 finish Stocked	
		643	26.40	616	----	----	US11	3	24	643 finish Stocked	
		F643E/716	26.40	B643E/716	----	----	US11E	3	24	643E finish Stocked	
		646	26.40	619	----	----	US15	3	24	646 finish Stocked	
		651	26.40	625	----	----	US26	3	24	651 finish Stocked	
		652	24.90	626	----	----	US26D	3	24	652 finish Stocked	
		F-BLK	24.00	B-BLK	----	----	US19	3	24	F-BLK finish Stocked	
	----	----	629	67.60	US32	3	24				
	----	----	630	70.10	US32D	3	24	630 finish Stocked			

Note: Specify BHMA finish code when ordering.

Lead time exception: Non-stocked Spring hinges and all Spring hinges with RC may take up to 10-12 weeks for shipment except 3SP1 4X4 652 RC-1/4

Contact Ives Customer Service for pricing on additional sizes and finishes

Bold pricing indicates item is in stock and available for **Fast Track** and **ProXpress**

DESCRIPTION	SIZE	STEEL BASED		BRASS / STAINLESS BASED		US REFERENCE	BOX	CASE	NOTES
		BHMA FINISH	LIST	BHMA FINISH	LIST				
 <p>Five Knuckle Plain Bearing Standard Weight</p> <p>For use on standard weight doors with low frequency usage</p> <p>Available in: Steel w/Steel Pin Brass w/Brass Pin Stainless w/Stainless Pin</p> <p>Non-removable Pin (Steel and Stainless Steel Based 4.5 x 4.5 Hinges add \$4.25 all others add \$9.00 list)</p> <p>Packed with: Wood and machine screws</p> <p>Available options: SEC - Security Screws HT - Hospital tip RC - Round corners SH - Security Studs See page 14 for pricing</p>	3.5"x3.5" (89x89mm)	600	\$7.00	----	\$ ----	USP	3	24	
		632	10.10	605	26.40	US3	3	24	
		633	7.50	606	21.80	US4	3	24	
		639	10.50	612	20.70	US10	3	24	
		640	10.50	613	26.40	US10B	3	24	
		641	10.50	614	26.40	US10A	3	24	
		643	10.80	616	26.40	US11	3	24	
		F643E/716	10.80	B643E/716	26.40	US11E	3	24	
		646	10.80	619	26.40	US15	3	24	
		651	10.50	625	27.80	US26	3	24	
		652	8.30	626	24.80	US26D	3	24	652 finish Stocked
		F-BLK	10.50	B-BLK	20.70	US19	3	24	
		----	----	629	30.10	US32	3	24	
		----	----	630	29.00	US32D	3	24	630 finish Stocked
		4"x4" (102x102mm)	600	\$8.00	----	----	USP	3	24
	632		12.10	605	30.20	US3	3	24	
	633		8.30	606	24.90	US4	3	24	
	639		8.90	612	23.50	US10	3	24	
	640		12.10	613	30.20	US10B	3	24	
	641		12.10	614	30.20	US10A	3	24	
	643		12.50	616	30.20	US11	3	24	
	F643E/716		12.50	B643E/716	30.20	US11E	3	24	
	646		12.50	619	30.20	US15	3	24	
	651		12.10	625	31.80	US26	3	24	
	652		10.00	626	28.40	US26D	3	24	652 finish Stocked
	F-BLK		8.90	B-BLK	23.50	US19	3	24	
	----		----	629	34.20	US32	3	24	
	----		----	630	33.10	US32D	3	24	630 finish Stocked
	4.5"x4" (114x102mm)		600	8.70	----	----	USP	3	24
		632	14.20	605	41.00	US3	3	24	
		633	7.30	606	35.10	US4	3	24	
		639	8.70	612	35.10	US10	3	24	
		640	13.90	613	41.00	US10B	3	24	
		641	13.90	614	38.40	US10A	3	24	
		643	14.20	616	38.40	US11	3	24	
		F643E/716	14.20	B643E/716	38.40	US11E	3	24	
		646	14.20	619	41.00	US15	3	24	
		651	14.20	625	47.10	US26	3	24	
		652	11.10	626	36.30	US26D	3	24	652 finish Stocked
		F-BLK	8.70	B-BLK	35.10	US19	3	24	
		----	----	629	43.70	US32	3	24	
		----	----	630	40.10	US32D	3	24	630 finish Stocked
		4.5"x4.5" (114x114mm)	600	5.50	----	----	USP	3	24
	632		13.70	605	41.00	US3	3	24	632 finish Stocked
	633		7.00	606	35.10	US4	3	24	633 finish Stocked
639	8.70		612	35.10	US10	3	24		
640	12.40		613	39.40	US10B	3	24	640 & 613 finish Stocked	
641	12.40		614	38.40	US10A	3	24	641 finish Stocked	
643	14.20		616	38.40	US11	3	24		
F643E/716	14.20		B643E/716	38.40	US11E	3	24		
646	13.70		619	41.00	US15	3	24	646 finish Stocked	
651	13.70		625	47.10	US26	3	24	651 finish Stocked	
652	8.30		626	36.30	US26D	3	24	652 & 626 finish Stocked	
F-BLK	8.70		B-BLK	35.10	US19	3	24		
----	----		629	43.70	US32	3	24		
----	----		630	40.10	US32D	3	24	630 finish Stocked	



Note: Specify BHMA finish code when ordering.

 Indicates products that have EPD documentation available and meet LEED v4.

Contact Ives Customer Service for pricing on additional sizes and finishes

Bold pricing indicates item is in stock and available for **Fast Track** and **ProXpress**

HINGES
 CONTINUOUS HINGES
 PIVOTS
 Numerical 1-059
 Numerical 59-437
 Numerical 438-1021
 Numerical 1152-8190
 Numerical 8200-9266

DESCRIPTION	SIZE	STEEL BASED		BRASS / STAINLESS BASED		US REFERENCE	BOX	CASE	NOTES	
		BHMA FINISH	LIST	BHMA FINISH	LIST					
 Five Knuckle Plain Bearing Standard Weight For use on standard weight doors with low frequency usage	5"x4.5" (127x114mm)	600	\$12.80	----	\$ ----	USP	3	24		
		632	19.50	605	59.30	US3	3	24		
		633	13.80	606	49.60	US4	3	24		
		639	14.30	612	46.10	US10	3	24		
		640	19.50	613	59.30	US10B	3	24		
		641	19.50	614	59.30	US10A	3	24		
		643	20.40	616	59.30	US11	3	24		
		F643E/716	20.40	B643E/716	59.30	US11E	3	24		
		646	20.40	619	59.30	US15	3	24		
		651	19.50	625	62.80	US26	3	24		
		652	16.40	626	56.20	US26D	3	24		
		F-BLK	14.30	B-BLK	46.10	US19	3	24		
		----	----	629	67.60	US32	3	24		
		----	----	630	64.90	US32D	3	24	630 finish Stocked	
 Five Knuckle Ball Bearing Standard Weight For use on standard weight doors with medium frequency usage Available in: Steel w/Steel Pin Brass w/Brass Pin Stainless w/Stainless Pin Non-removable Pin (Steel and Stainless Steel Based 4.5 x 4.5 Hinges add \$4.25 all others add \$9.00 list) Packed with: Wood and machine screws Available options: SEC - Security Screws HT - Hospital tip RC - Round corners SH - Security Studs TW - Electric Thru Wire See page 14 for pricing and available sizes	3.5"x3.5" (89x89mm)	600	10.30	----	\$ ----	USP	3	24		
		632	15.60	605	37.90	US3	3	24		
		633	11.20	606	31.60	US4	3	24		
		639	11.80	612	29.50	US10	3	24		
		640	15.60	613	37.90	US10B	3	24		
		641	15.60	614	37.90	US10A	3	24		
		643	16.40	616	37.90	US11	3	24		
		F643E/716	16.40	B643E/716	37.90	US11E	3	24		
		646	16.40	619	37.90	US15	3	24		
		651	15.60	625	39.90	US26	3	24		
		652	12.20	626	35.60	US26D	3	24	652 finish Stocked	
		F-BLK	11.80	B-BLK	29.50	US19	3	24		
	----	----	629	42.80	US32	3	24			
	----	----	630	38.60	US32D	3	24	630 finish Stocked		
	4"x4" (102x102mm)	600	9.70	----	----	USP	3	24	600 finish Stocked	
		632	15.60	605	36.70	US3	3	24		
		633	11.20	606	30.40	US4	3	24		
		639	11.80	612	28.50	US10	3	24		
		640	15.60	613	36.70	US10B	3	24		
		641	15.60	614	36.70	US10A	3	24		
		643	16.40	616	36.70	US11	3	24		
		F643E/716	16.40	B643E/716	36.70	US11E	3	24		
		646	16.40	619	36.70	US15	3	24		
		651	15.60	625	38.70	US26	3	24		
		652	12.20	626	34.70	US26D	3	24	652 finish Stocked	
		F-BLK	11.80	B-BLK	28.50	US19	3	24		
		----	----	629	41.60	US32	3	24		
		----	----	630	39.90	US32D	3	24	630 finish Stocked	
		4.5"x4" (114x102mm)	600	14.20	----	----	USP	3	24	
			632	20.30	605	48.60	US3	3	24	
			633	14.20	606	36.70	US4	3	24	
			639	16.10	612	36.70	US10	3	24	
	640		20.70	613	48.60	US10B	3	24		
	641		20.70	614	43.80	US10A	3	24		
	643		20.30	616	43.80	US11	3	24		
	F643E/716		20.30	B643E/716	43.80	US11E	3	24		
646	21.50		619	48.60	US15	3	24			
651	20.30		625	48.60	US26	3	24			
652	16.40		626	38.70	US26D	3	24	652 & 626 finish Stocked		
F-BLK	16.10		B-BLK	36.70	US19	3	24			
----	----		629	49.50	US32	3	24			
----	----		630	44.80	US32D	3	24	630 finish Stocked		

Note: Specify BHMA finish code when ordering.

 Indicates products that have EPD documentation available and meet LEED v4.

Contact Ives Customer Service for pricing on additional sizes and finishes

Bold pricing indicates item is in stock and available for **Fast Track** and **ProXpress**

HINGES
 CONTINUOUS HINGES
 PIVOTS
 Numerical 1-059
 Numerical 59-437
 Numerical 438-1021
 Numerical 1152-8190
 Numerical 8200-9266

DESCRIPTION	SIZE	STEEL BASED		BRASS / STAINLESS BASED		US REFERENCE	BOX	CASE	NOTES
		BHMA FINISH	LIST	BHMA FINISH	LIST				
 <p>Five Knuckle Ball Bearing Standard Weight</p> <p>For use on standard weight doors with medium frequency usage</p> <p>Available in: Steel w/Steel Pin Brass w/Brass Pin Stainless w/Stainless Pin</p> <p>Non-removable Pin (Steel and Stainless Steel Based 4.5 x 4.5 Hinges add \$4.25 all others add \$9.00 list)</p> <p>Packed with: Wood and machine screws</p> <p>Available options: SEC - Security Screws HT - Hospital tip RC - Round corners SH - Security Studs TW - Electric Thru Wire See page 14 for pricing</p>	4.5"x4.5" (114x114mm)	600	10.90	----	\$ ----	USP	3	24	600 finish Stocked
		632	19.00	605	45.70	US3	3	24	632 & 605 finish Stocked
		633	12.20	606	34.70	US4	3	24	633 & 606 finish Stocked
		639	15.20	612	34.70	US10	3	24	639 & 612 finish Stocked
		640	19.00	613	45.70	US10B	3	24	640 & 613 finish Stocked
		641	19.00	614	43.80	US10A	3	24	641 finish Stocked
		643	19.00	616	43.80	US11	3	24	643 finish Stocked
		F643E/716	19.50	B643E/716	43.80	US11E	3	24	F643 & B643E finish Stocked
		646	23.10	619	45.70	US15	3	24	646 & 619 finish Stocked
		651	19.00	625	45.70	US26	3	24	651 & 625 finish Stocked
		652	12.20	626	38.70	US26D	3	24	652 & 626 finish Stocked
		F-BLK	15.50	B-BLK	35.30	US19	3	24	FBLK & BBLK finish Stocked
	----	----	629	49.50	US32	3	24		
	----	----	630	44.80	US32D	3	24	630 finish Stocked	
	5"x4.5" (127x114mm)	600	21.70	----	----	USP	3	24	
		632	32.80	605	55.70	US3	3	24	
		633	23.30	606	46.10	US4	3	24	
		639	24.60	612	43.10	US10	3	24	
		640	32.80	613	55.70	US10B	3	24	640 finish Stocked
		641	32.80	614	55.70	US10A	3	24	
		643	34.20	616	55.70	US11	3	24	
		F643E/716	34.20	B643E/716	55.70	US11E	3	24	
		646	34.20	619	55.70	US15	3	24	
		651	32.80	625	58.50	US26	3	24	
		652	25.70	626	52.40	US26D	3	24	652 finish Stocked
		F-BLK	24.60	B-BLK	43.10	US19	3	24	
	----	----	629	62.90	US32	3	24		
	----	----	630	57.00	US32D	3	24	630 finish Stocked	
	5"x5" (127x127mm)	600	22.10	----	----	USP	3	24	
		632	33.40	605	57.60	US3	3	24	
		633	23.50	606	47.80	US4	3	24	
		639	24.80	612	44.60	US10	3	24	
		640	33.40	613	57.60	US10B	3	24	
		641	33.40	614	57.60	US10A	3	24	
		643	34.60	616	57.60	US11	3	24	
		F643E/716	34.60	B643E/716	57.60	US11E	3	24	
646		34.60	619	57.60	US15	3	24		
651		33.40	625	60.60	US26	3	24		
652		27.60	626	54.10	US26D	3	24	652 finish Stocked	
F-BLK		24.80	B-BLK	44.60	US19	3	24		
----	----	629	65.10	US32	3	24			
----	----	630	62.50	US32D	3	24	630 finish Stocked		

Note: Specify BHMA finish code when ordering.

 Indicates products that have EPD documentation available and meet LEED v4.

Contact Ives Customer Service for pricing on additional sizes and finishes

Bold pricing indicates item is in stock and available for **Fast Track** and **ProXpress**

DESCRIPTION	SIZE	STEEL BASED		BRASS / STAINLESS BASED		US REFERENCE	BOX	CASE	NOTES
		BHMA FINISH	LIST	BHMA FINISH	LIST				
 <p>5BB1 HW</p> <p>Five Knuckle Ball Bearing Heavy Weight</p> <p>For use on heavy weight doors with medium frequency usage</p> <p>Available in: Steel w/Steel Pin Brass w/Brass Pin Stainless w/Stainless Pin</p> <p>Non-removable Pin (Steel and Stainless Steel Based 4.5 x 4.5 Hinges add \$4.25 all others add \$9.00 list)</p> <p>Packed with: Wood and machine screws</p> <p>Available options: SEC - Security Screws HT - Hospital tip RC - Round corners SH - Security Studs TW - Electric Thru Wire See page 14 for pricing</p>	4.5"x4.5" (114x102mm)	600	\$25.40	----	\$ ----	USP	3	24	
		632	38.20	605	71.80	US3	3	24	
		633	26.90	606	59.70	US4	3	24	
		639	28.50	612	56.00	US10	3	24	
		640	38.20	613	71.80	US10B	3	24	
		641	38.20	614	71.80	US10A	3	24	
		643	39.70	616	71.80	US11	3	24	
		F643E/716	39.70	B643E/716	71.80	US11E	3	24	
		646	39.70	619	71.80	US15	3	24	
		651	38.20	625	75.90	US26	3	24	
		652	29.70	626	67.90	US26D	3	24	652 finish Stocked
		F-BLK	28.50	B-BLK	56.00	US19	3	24	
		----	----	629	81.20	US32	3	24	
		----	----	630	73.30	US32D	3	24	630 finish Stocked
		4.5"x4.5" (114x114mm)	600	32.50	----	----	USP	3	24
	632		42.10	605	71.80	US3	3	24	632 finish Stocked
	633		33.90	606	59.70	US4	3	24	633 finish Stocked
	639		35.40	612	56.00	US10	3	24	639 & 612 finish Stocked
	640		42.10	613	76.10	US10B	3	24	640 & 613 finish Stocked
	641		42.10	614	71.80	US10A	3	24	641 finish Stocked
	643		42.10	616	71.80	US11	3	24	643 finish Stocked
	F643E/716		42.80	B643E/716	71.80	US11E	3	24	
	646		42.10	619	70.50	US15	3	24	646 & 619 finish Stocked
	651		42.10	625	75.90	US26	3	24	651 & 625 finish Stocked
	652		35.40	626	63.90	US26D	3	24	652 & 626 finish Stocked
	F-BLK		36.20	B-BLK	56.00	US19	3	24	FBLK & BBLK finish Stocked
	----		----	629	81.20	US32	3	24	NRP also in FT and ProX
	----		----	630	73.30	US32D	3	24	630 finish Stocked
	5"x4.5" (127x114mm)		600	40.30	----	----	USP	3	24
		632	57.70	605	83.50	US3	3	24	
		633	41.80	606	69.80	US4	3	24	633 finish Stocked
		639	40.80	612	64.90	US10	3	24	
		640	49.00	613	83.50	US10B	3	24	640 & 613 finish Stocked
		641	52.10	614	83.50	US10A	3	24	
		643	41.80	616	83.50	US11	3	24	
		F643E/716	41.80	B643E/716	83.50	US11E	3	24	
		646	41.80	619	83.50	US15	3	24	646 finish Stocked
		651	41.80	625	88.20	US26	3	24	
		652	40.80	626	74.30	US26D	3	24	652 & 626 finish Stocked
		F-BLK	41.60	B-BLK	64.90	US19	3	24	
		----	----	629	94.70	US32	3	24	
		----	----	630	85.60	US32D	3	24	630 finish Stocked
		5"x5" (127x127mm)	600	41.60	----	----	USP	3	24
	632		62.20	605	96.80	US3	3	24	
	633		44.20	606	80.60	US4	3	24	
639	46.90		612	75.20	US10	3	24		
640	62.20		613	96.80	US10B	3	24	613 finish Stocked	
641	62.20		614	96.80	US10A	3	24		
643	65.10		616	96.80	US11	3	24		
F643E/716	65.10		B643E/716	96.80	US11E	3	24		
646	65.10		619	96.80	US15	3	24		
651	62.20		625	102.00	US26	3	24		
652	50.20		626	91.30	US26D	3	24	652 finish Stocked	
F-BLK	46.90		B-BLK	75.20	US19	3	24		
----	----		629	109.50	US32	3	24		
----	----		630	99.00	US32D	3	24	630 finish Stocked	



Note: Specify BHMA finish code when ordering.

 Indicates products that have EPD documentation available and meet LEED v4.

Contact Ives Customer Service for pricing on additional sizes and finishes

Bold pricing indicates item is in stock and available for **Fast Track** and **ProXpress**

HINGES
 CONTINUOUS HINGES
 PIVOTS
 Numerical 1-059
 Numerical 59-437
 Numerical 438-1021
 Numerical 1152-8190
 Numerical 8200-9266

DESCRIPTION	SIZE	STEEL BASED		BRASS / STAINLESS BASED		US REFERENCE	BOX	CASE	NOTES
		BHMA FINISH	LIST	BHMA FINISH	LIST				
 <p>Five Knuckle Ball Bearing Swing Clear Standard Weight</p> <p>For use on standard weight doors with medium frequency usage</p> <p>Available in: Steel w/ Steel Pin Square or Beveled Edge</p> <p>Non-removable Pin (add \$9.00 List)</p> <p>Packed with: Wood and machine screws</p> <p>Available options: SEC - Security Screws HT - Hospital tip SH - Security Studs TW - Electric Thru Wire See page 14 for pricing</p>	4.5" (114mm)	600	\$69.10	----	\$ ----	USP	3	24	
		632	81.20	605	----	US3	3	24	SC 632 finish Stocked
		633	69.10	606	----	US4	3	24	
		639	72.00	612	----	US10	3	24	
		640	81.20	613	----	US10B	3	24	SC 640 finish Stocked
		641	85.00	614	----	US10A	3	24	
		643	84.60	616	----	US11	3	24	
		F643E/716	84.60	B643E/716	----	US11E	3	24	
		646	84.60	619	----	US15	3	24	SC 646 finish Stocked
		651	81.20	625	----	US26	3	24	
		652	63.90	626	----	US26D	3	24	SC/BSC 652 finish Stocked
		F-BLK	72.00	B-BLK	----	US19	3	24	
	----	----	629	----	US32	3	24		
	----	----	630	94.40	US32D	3	24	SC/BSC 630 finish Stocked	
	5" (127mm)	600	69.10	----	----	USP	3	24	
		632	81.20	605	----	US3	3	24	
		633	69.10	606	----	US4	3	24	
		639	72.00	612	----	US10	3	24	
		640	81.20	613	----	US10B	3	24	SC/BSC 640 finish Stocked
		641	85.00	614	----	US10A	3	24	
		643	84.60	616	----	US11	3	24	
		F643E/716	84.60	B643E/716	----	US11E	3	24	
		646	84.60	619	----	US15	3	24	
		651	81.20	625	----	US26	3	24	
652		63.90	626	----	US26D	3	24	SC/BSC 652 finish Stocked	
F-BLK		72.00	B-BLK	----	US19	3	24		
----	----	629	----	US32	3	24			
----	----	630	110.00	US32D	3	24	SC 630 finish Stocked		
 <p>Five Knuckle Ball Bearing Swing Clear Heavyweight</p> <p>For use on heavy weight doors with medium frequency usage</p> <p>Available in: Steel w/ Steel Pin Square or Beveled Edge</p> <p>Non-removable Pin (add \$9.00 List)</p> <p>Packed with: Wood and machine screws</p> <p>Available options: SEC - Security Screws HT - Hospital tip SH - Security Studs TW - Electric Thru Wire See page 14 for pricing</p>	4.5" (114mm)	600	79.20	----	----	USP	3	24	
		632	98.50	605	----	US3	3	24	
		633	79.20	606	----	US4	3	24	
		639	87.70	612	----	US10	3	24	SC/BSC 639 finish Stocked
		640	98.50	613	----	US10B	3	24	SC/BSC 640 finish Stocked
		641	98.50	614	----	US10A	3	24	
		643	98.50	616	----	US11	3	24	
		F643E/716	98.50	B643E/716	----	US11E	3	24	
		646	102.80	619	----	US15	3	24	
		651	98.50	625	----	US26	3	24	
		652	77.40	626	----	US26D	3	24	SC/BSC 652 finish Stocked
		F-BLK	87.70	B-BLK	----	US19	3	24	
	----	----	629	----	US32	3	24		
	----	----	630	139.00	US32D	3	24	SC/BSC 630 finish Stocked	
	5" (127mm)	600	79.20	----	----	USP	3	24	
		632	98.50	605	----	US3	3	24	
		633	79.20	606	----	US4	3	24	
		639	87.70	612	----	US10	3	24	SC 639 finish Stocked
		640	98.50	613	----	US10B	3	24	SC 640 finish Stocked
		641	98.50	614	----	US10A	3	24	
		643	98.50	616	----	US11	3	24	
		F643E/716	98.50	B643E/716	----	US11E	3	24	
		646	102.80	619	----	US15	3	24	
		651	98.50	625	----	US26	3	24	
652		77.40	626	----	US26D	3	24	SC/BSC 652 finish Stocked	
F-BLK		87.70	B-BLK	----	US19	3	24		
----	----	629	----	US32	3	24			
----	----	630	166.80	US32D	3	24	SC/BSC 630 finish Stocked		

Note: Specify BHMA finish code when ordering.

Lead time exception: Non-stocked Swing Clear hinges and all hinges with HT or SH may take up to 10-12 weeks for shipment except 5BB1SC 4.5 652 HT, 5BB1HW-SC 4.5 652 HT, 5BB1HW-SC 5 652 HT, and 5BB1HW-BSC 5 652 HT,

Contact Ives Customer Service for pricing on additional sizes and finishes

Bold pricing indicates item is in stock and available for **Fast Track** and **ProXpress**

HINGES
 CONTINUOUS HINGES
 PIVOTS
 Numerical 1-059
 Numerical 59-437
 Numerical 438-1021
 Numerical 1152-8190
 Numerical 8200-9266

DESCRIPTION	SIZE	STEEL BASED		BRASS / STAINLESS BASED		US REFERENCE	BOX	CASE	NOTES
		BHMA FINISH	LIST	BHMA FINISH	LIST				
5BB1 WT  Five Knuckle Ball Bearing Wide Throw Standard Weight For use on standard weight doors with medium frequency usage Available in: Steel w/Steel Pin Non-removable Pin (add \$9.00 List) Packed with: Wood and machine screws Available options: SEC - Security Screws HT - Hospital tip RC - Round corners SH - Security Studs TW - Electric Thru Wire See page 14 for pricing	4.5"x5" (114x127mm)	600	17.40	----	\$ ----	USP	3	24	
		632	26.10	605	----	US3	3	24	
		633	18.20	606	----	US4	3	24	
		639	19.50	612	----	US10	3	24	
		640	26.10	613	----	US10B	3	24	
		641	26.10	614	----	US10A	3	24	
		643	26.90	616	----	US11	3	24	
		F643E/716	26.90	B643E/716	----	US11E	3	24	
		646	26.90	619	----	US15	3	24	
		651	26.10	625	----	US26	3	24	
		652	21.50	626	----	US26D	3	24	652 finish Stocked
		F-BLK	19.50	B-BLK	----	US19	3	24	
		----	----	629	----	US32	3	24	
		----	----	630	----	US32D	3	24	
	4.5"x6" (114x152mm)	600	46.10	----	----	USP	3	24	
		632	69.10	605	----	US3	3	24	
		633	49.00	606	----	US4	3	24	
		639	52.10	612	----	US10	3	24	
		640	69.10	613	----	US10B	3	24	
		641	69.10	614	----	US10A	3	24	
		643	72.00	616	----	US11	3	24	
		F643E/716	72.00	B643E/716	----	US11E	3	24	
		646	72.00	619	----	US15	3	24	
		651	69.10	625	----	US26	3	24	
		652	54.20	626	----	US26D	3	24	652 finish Stocked
		F-BLK	52.10	B-BLK	----	US19	3	24	
		----	----	629	----	US32	3	24	
		----	----	630	----	US32D	3	24	
	5"x6" (127x152mm)	600	62.20	----	----	USP	3	24	
		632	93.20	605	----	US3	3	24	
		633	66.00	606	----	US4	3	24	
		639	70.20	612	----	US10	3	24	
		640	93.20	613	----	US10B	3	24	
		641	93.20	614	----	US10A	3	24	
		643	97.20	616	----	US11	3	24	
		F643E/716	97.20	B643E/716	----	US11E	3	24	
		646	97.20	619	----	US15	3	24	
		651	93.20	625	----	US26	3	24	
		652	77.80	626	----	US26D	3	24	
		F-BLK	70.20	B-BLK	----	US19	3	24	
----		----	629	----	US32	3	24		
----		----	630	----	US32D	3	24		
5"x7" (127x178mm)	600	62.20	----	----	USP	3	24		
	632	93.20	605	----	US3	3	24		
	633	66.00	606	----	US4	3	24		
	639	70.20	612	----	US10	3	24		
	640	93.20	613	----	US10B	3	24		
	641	93.20	614	----	US10A	3	24		
	643	97.20	616	----	US11	3	24		
	F643E/716	97.20	B643E/716	----	US11E	3	24		
	646	97.20	619	----	US15	3	24		
	651	93.20	625	----	US26	3	24		
	652	77.80	626	----	US26D	3	24		
	F-BLK	70.20	B-BLK	----	US19	3	24		
	----	----	629	----	US32	3	24		
	----	----	630	----	US32D	3	24		

Note: Specify BHMA finish code when ordering.

Contact Ives Customer Service for pricing on additional sizes and finishes

Bold pricing indicates item is in stock and available for **Fast Track** and **ProXpress**

HINGES
 CONTINUOUS HINGES
 PIVOTS
 Numerical 1-059
 Numerical 59-437
 Numerical 438-1021
 Numerical 1152-8190
 Numerical 8200-9266

DESCRIPTION	SIZE	STEEL BASED		BRASS / STAINLESS BASED		US REFERENCE	BOX	CASE	NOTES
		BHMA FINISH	LIST	BHMA FINISH	LIST				
 <p>5BB1 WT Five Knuckle Ball Bearing Wide Throw Standard Weight For use on standard weight doors with medium frequency usage</p>	5"x8" (127x206mm)	600	\$62.20	----	\$----	USP	3	24	
		632	93.20	605	----	US3	3	24	
		633	66.00	606	----	US4	3	24	
		639	70.20	612	----	US10	3	24	
		640	93.20	613	----	US10B	3	24	
		641	93.20	614	----	US10A	3	24	
		643	97.20	616	----	US11	3	24	
		F643E/716	97.20	B643E/716	----	US11E	3	24	
		646	97.20	619	----	US15	3	24	
		651	93.20	625	----	US26	3	24	
		652	77.80	626	----	US26D	3	24	
		F-BLK	70.20	B-BLK	----	US19	3	24	
		----	----	629	----	US32	3	24	
		----	----	630	----	US32D	3	24	

Note: Specify BHMA finish code when ordering.

BAA 5BB1 Five Knuckle Ball Bearing Standard Weight Build in America (BAA) Non-removable Pin (NRP) add \$4.25 List	4.5"x4.5" (114x114mm)	652	\$13.50	626	----	US26D	3	24	
		----	----	630	\$49.10	US32D	3	24	
BAA 5BB1 HW Five Knuckle Ball Bearing Heavy Weight Build in America (BAA) Non-removable Pin (NRP) add \$4.25 List	4.5"x4.5" (114x114mm)	652	\$38.70	626	----	US26D	3	24	
		----	----	630	\$80.10	US32D	3	24	
	5"x4.5" (127x114mm)	652	\$44.50	626	----	US26D	3	24	
		----	----	630	\$93.70	US32D	3	24	
BAA 5BB1 HW BSC Five Knuckle Ball Bearing Heavy Weight Build in America (BAA) Swing Clear - Beveled Edge	4.5" (114mm)	652	\$84.60	626	----	US26D	3	24	

Additional Options Available for Most Hinges

HINGE ADDITION/MODIFICATION	SPECIFY	LIST ADD PER HINGE
Non-Removable Pin	NRP	Reference each hinge type
Round Corners (specify 1/4" or 5/8" radius)	RC 1/4" or RC 5/8"	\$6.00
Security Studs (Includes NRP)	SH	8.50
Hospital Tips*	HT	11.00
Security Screws Machine Only	SEC	26.50

* Hospital Tips and Thru-Wire options include pins that are non-removable. Additional NRP option is not required.

Electric Thru-Wire Options*

Listed under UL 634

TW4 - 4 Wire Thru Wire
 TW8 - 8 Wire Thru Wire
 MON - Monitor
 TW4M - 4 Wire Thru Wire with Monitor
 TW8M - 8 Wire Thru Wire with Monitor
 CON - Allegion Connect

All TW4 and TW8 3 knuckle and 5 knuckle hinges are standard with the Allegion Connect 8-pin Connector

- TW and MON not available for 3.5X3.5 hinges, contact technical support.
- MON not available for 4X4 or smaller hinges, contact technical support.
- Not available on 3PB1, 3SP1, or 5PB1 models
- Not available with Security Stud (SH) option
- Packed one hinge per box with machine and wood screws
- Through-wire hinges cycle tested to ensure durability. Ives warranty applies-12 months from date of shipment

MODEL NO.	BOX QTY	STEEL BASED		BRASS / STAINLESS BASED		ALLEGION CONNECT (CON)
		FULL MORTISE	SWING CLEAR	FULL MORTISE	SWING CLEAR	
*MON	1	323.00	-	382.00	-	N/A
TW4	1	310.00	618.00	366.00	725.00	N/C
TW4M	1	590.00	-	709.00	-	N/C
TW8	1	468.00	790.00	557.00	1,114.00	N/C
TW8M	1	790.00	-	843.00	-	N/C

For Stocked Electric Thru Wire Hinges, see pricing in the table below. Options above are List Add per Hinge.

 Indicates products that have EPD documentation available and meet LEED v4. *Bold pricing indicates item is in stock and available for Fast Track and ProXpress*

Stocked Electric Thru-Wire Hinges

The hinges in the table below come standard with Allegion Connect (CON) at no extra charge.

DESCRIPTION	SIZE	TW OPTION	STEEL BASED BHMA FINISH	LIST	BRASS / STAINLESS BASED BHMA FINISH	LIST	US REFERENCE	BOX	CASE
3CB1	4.5X4	TW8 CON	652	\$461.60	626	---	US26D	1	12
			---	---	630	---	US32D	1	12
	4.5X4.5	TW4 CON	652	\$306.00	626	---	US26D	1	12
			---	---	630	---	US32D	1	12
		TW8 CON	652	\$454.60	626	---	US26D	1	12
			---	---	630	\$589.60	US32D	1	12
3CB1 HW	4.5X4.5	TW8 CON	652	\$487.60	626	---	US26D	1	12
			---	---	630	\$623.80	US32D	1	12
	5X4.5	TW8 CON	652	\$520.40	626	---	US26D	1	12
			---	---	630	---	US32D	1	12
5BB1	4.5x4	TW8 CON	652	\$457.70	626	---	US26D	1	12
			---	---	630	---	US32D	1	12
	4.5x4.5	TW4 CON	652	\$304.80	626	\$385.00	US26D	1	12
			---	---	630	\$391.10	US32D	1	12
		TW8 CON	646	\$464.70	619	---	US15	1	12
			652	\$453.60	626	\$564.90	US26D	1	12
	5x4.5	TW8 CON	---	---	630	\$571.10	US32D	1	12
			652	\$467.30	626	---	US26D	1	12
		---	---	630	---	US32D	1	12	
		---	---	630	---	US32D	1	12	
5BB1 HW	4.5X4.5	TW4 CON	652	\$328.50	626	---	US26D	1	12
			---	---	630	\$420.20	US32D	1	12
		TW8 CON	652	\$477.20	626	\$620.90	US26D	1	12
			---	---	630	\$599.90	US32D	1	12
	5X4.5	TW4 CON	652	\$334.10	626	--	US26D	1	12
			---	---	630	---	US32D	1	12
		TW8 CON	652	\$482.70	626	---	US26D	1	12
			---	---	630	\$612.50	US32D	1	12

For all other Electric Thru Wire Hinges, see pricing in the table above.

Lead time exception: Non-Stocked Electric Thru Wire Hinges may take up to 4-5 weeks for shipment.

Residential Hinges

*Non rising pin standard. Hinge pin stop not recommended.

MODEL	SUBSTRATE	MODEL NUMBER	BHMA FINISH	WEIGHT	ORDER QTY	BOX QTY	LIST PRICE
1010* Residential Hinge 3.5" Square Corner	Steel	1010 F-619E	646			2	\$8.10
		1010 F-622E	-			2	8.10
		1010 F-625E	651			2	8.10
		1010 F-626E	652			2	8.10
		1010 F-716E	-			2	8.10
1011* Residential Hinge 3.5" 5/8" Radius Corner	Steel	1011F-605E	632			2	8.10
		1011F-619E	646			2	8.10
		1011 F-622E	-			2	8.10
		1011 F-625E	651			2	8.10
		1011 F-626E	652			2	8.10
1011F-716E	-			2	8.10		
1012* Residential Hinge 3.5" 1/4" Radius Corner	Steel	1012 F-619E	646			2	8.10
		1012 F-622E	-			2	8.10
		1012 F-625E	651			2	8.10
		1012 F-626E	652			2	8.10
		1012 F-716E	-			2	8.10
1020* Residential Hinge 4" Square Corner	Steel	1020 F-619E	646			2	8.70
		1020 F-622E	-			2	8.70
		1020 F-625E	651			2	8.70
		1020 F-626E	652			2	8.70
		1020 F-716E	-			2	8.70
1021* Residential Hinge 4" 5/8" Radius Corner	Steel	1021 F-619E	646			2	8.70
		1021 F-622E	-			2	8.70
		1021 F-625E	651			2	8.70
		1021 F-626E	652			2	8.70
		1021 F-716E	-			2	8.70

*Non rising pin standard. Hinge pin stop not recommended.







Contact Ives Customer Service for pricing on additional sizes and finishes

Bold pricing indicates item is in stock and available for **Fast Track** and **ProXpress**

HINGES
 CONTINUOUS HINGES
 PIVOTS
 Numerical 1-059
 Numerical 59-437
 Numerical 438-1021
 Numerical 1152-8190
 Numerical 8200-9266

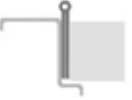
Continuous Hinges - Pin and Barrel

STEEL BASED

MODEL	DESCRIPTION	FINISH	LENGTH	BHMA FINISH	LIST	NOTES
600 UL Listed 	600 Concealed Hinge 1/8" Inset Non Handed	USP	83"	600	\$314.40	Stocked
			85"	600	395.20	
			95"	600	383.90	
			120"	600	474.50	Stocked
602 UL Listed 	602 Full Surface Flush Mount Handed when cut or modified	USP	83"	600	353.50	Stocked
			85"	600	412.40	
			95"	600	412.40	
			120"	600	555.70	
611 UL Listed 	611 Swing Clear No Inset, Handed when cut or modified Built in Edge Guard	USP	83"	600	555.20	
			85"	600	628.90	
			95"	600	628.90	
			120"	600	729.20	
700 UL Listed 	700 Concealed Hinge 1/8" Inset Non Handed	US32D	83"	630	556.70	Stocked, including HT and TWP
			85"	630	644.50	Stocked
			95"	630	644.50	Stocked
			120"	630	787.40	Stocked
702 UL Listed 	702 Full Surface Flush Mount Handed when cut or modified	US32D	83"	630	644.50	Stocked
			85"	630	764.90	
			95"	630	764.90	
			120"	630	1050.50	Stocked
705 UL Listed 	705 Concealed Hinge Handed when cut or modified Adjusta-Stud Fasteners	US32D	83"	630	726.40	Stocked, including HT
			85"	630	818.20	
			95"	630	818.20	Stocked
			120"	630	999.40	Stocked
711 UL Listed 	711 Swing Clear Flush Mounted Surface Hinge No Inset, Handed when cut or modified Built in Edge Guard	US32D	83"	630	624.70	Stocked
			85"	630	737.70	
			95"	630	716.50	
			120"	630	898.80	
715 UL Listed 	715 Concealed Hinge Flush Mounted, Half Wrap Handed when cut or modified Built in Edge Guard	US32D	83"	630	677.50	Stocked, including HT
			85"	630	765.20	Stocked
			95"	630	765.20	Stocked
			120"	630	949.00	

HINGES

CONTINUOUS HINGES

PIVOTS

Numerical 1-059

Numerical 59-437

Numerical 438-1021

Numerical 1152-8190

Numerical 8200-9266

Contact Ives Customer Service for pricing on additional sizes and finishes

Bold pricing indicates item is in stock and available for **Fast Track** and **ProXpress**

Pin & Barrel Continuous Hinges - Additional Offerings

Custom Processing*

Custom cut to length \$22.00 List add per hinge
 Custom painting colors Contact customer service for pricing and color approval. See Page ix for additional information.
 Additional lead time up to 6 weeks may be needed.
 Add pricing below to base pricing for the size needed.

\$1,132.00 Flat rate for hinge quantity less than 12 for Tiger/Drylac paint
 \$94.00 List add per hinge for each hinge greater than 12.

Dutch Door Prep \$139.00 List add per hinge
 Hospital Tips \$139.00 List add per hinge

* Return Policy - requires prior approval, consult factory

Electrical Modifications

EPT - Electrical Power Transfer prep \$120.00 List add per hinge
600, 700, 705, and 715

TW8 - Electric Through-Wire \$393.00 List add per hinge
600, 700, 705, and 715

CON - Allegion Connect \$54.00 List add per hinge (Must order with TW8 and add CON List Adder)
600, 700, 705, and 715

Standard cutout locations. Top Edge of Door to Centerline of cutout.

Consult factory for custom locations. Specify location from top edge of door to centerline of cutout.
TW8 location cannot be moved.

STD LENGTH	EPT	TW8
83"	30"	43-19/32"
85"	32"	45-17/32"
95"	42"	55-17/32"
120"	67"	80-17/32"

Optional Mounting Hardware

Standard Mounting Hardware \$0.00 No List Add
 Hollow Metal Self Drilling / Self Tapping Screws (TEK) for Door and Frame
 1/2 Wood Screws

Security Screws \$41.00 List add per hinge
 Hollow Metal Door and Frame Specify SECHM
 1/2 Wood, 1/2 Hollow Metal Specify SECWDHM
 Wood Door and Frame Specify SECWDWD

Wood Screws \$22.00 List add per hinge
 Wood Door and Frame Specify WD

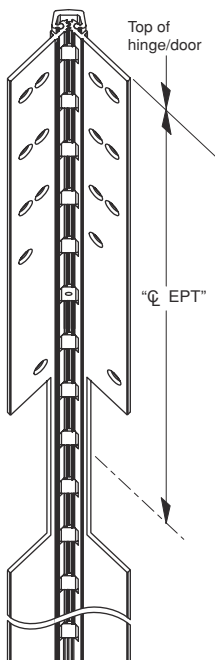

Ives Continuous Hinge - EPT Order Detail

(EPT's Measure from the top of the hinge to the centerline of the EPT Cutout)

Please supply the following information

_____ P/O Number



_____ Order #

_____ Length of Continuous Hinge

_____ Indicate RH or LH

_____ EPT Location

Note - EPT location is calculated from the TOP of the Hinge to the Centerline of the EPT cutout.

Model	Description	Lengths	List Price - Finishes Listed are for Aluminum Cover, Hinge leaves are Stainless Steel								
			441 (US32DAN)	600 (USP)	628 (US28)	688 (US4AN)	709 (US10AN)	710 (313AN)	711 (315AN)	712 (US26AN)	713 (US26DAN)
			Satin Stainless Anodized	Primed Paint	Clear Anodized	Satin Brass Anodized	Satin Bronze Anodized	Dark Bronze Anodized	Black Anodized	Buff Chrome Anodized	Satin Chrome Anodized
700CS  Stocked	700CS Stainless Steel Full Mortise Hinge w/ AL Cover	83"	717.30	770.70	643.40	717.30	717.30	670.80	670.80	717.30	717.30
		85"	817.30	869.20	743.30	817.30	817.30	769.20	769.20	817.30	817.30
		95"	836.70	888.60	762.80	836.70	836.70	782.30	782.30	836.70	836.70
		120"	1,089.70	1,142.90	1,015.60	1,089.70	1,089.70	1,041.60	1,041.60	1,089.70	1,089.70
	700CS w/ TWP Stainless Steel Full Mortise Hinge w/ AL Cover, and Thru Wire Panel	83"	1,406.30	1,429.50	1,372.60	1,406.30	1,406.30	1,384.30	1,384.30	1,406.30	1,406.30
		85"	1,406.30	1,429.50	1,372.60	1,406.30	1,406.30	1,384.30	1,384.30	1,406.30	1,406.30
		95"	1,406.30	1,429.50	1,372.60	1,406.30	1,406.30	1,384.30	1,384.30	1,406.30	1,406.30
		120"	1,406.30	1,429.50	1,372.60	1,406.30	1,406.30	1,384.30	1,384.30	1,406.30	1,406.30
711CS 	711CS Stainless Steel Swing Clear Hinge w/ AL Cover	83"	787.40	822.50	738.30	787.40	787.40	756.30	756.30	787.40	787.40
		85"	812.00	847.10	762.80	812.00	812.00	782.30	782.30	812.00	812.00
		95"	866.50	901.60	817.30	866.50	866.50	838.00	838.00	866.50	866.50
		120"	1,018.40	1,053.40	967.70	1,018.40	1,018.40	985.90	985.90	1,018.40	1,018.40
715CS 	715CS Stainless Steel Full Mortise Hinge w/ Edge Guard and w/ AL Cover	83"	834.20	894.00	751.10	834.20	834.20	782.30	782.30	834.20	834.20
		85"	945.70	1,005.40	861.50	945.70	945.70	889.90	889.90	945.70	945.70
		95"	966.40	1,024.80	882.20	966.40	966.40	912.00	912.00	966.40	966.40
		120"	1,259.50	1,319.40	1,175.20	1,259.50	1,259.50	1,205.40	1,205.40	1,259.50	1,259.50

Lead time exception: Non-Stocked 711CS and 715CS Pin & Barrel Hinges may take up to 4-5 weeks for shipment. Cut to Length, EPT cutouts, and optional mounting hardware of stocked hinges will ship in 2 weeks or less

CS Series Continuous Hinges - Additional Offering

Custom Processing*

Custom cut to length \$44.00 List add per hinge
 (All lengths = 13" from each end, TWP top only)

Custom painting colors Contact customer service for pricing and color approval. See Page ix for additional information. Additional lead time up to 6 weeks may be needed.
 Add pricing below to base 628 finish pricing for the size needed.
 \$1,132.00 Flat rate for hinge quantity less than 12 for Tiger/Drylac paint
 \$94.00 List add per hinge for each hinge greater than 12.

* Return Policy - requires prior approval, consult factory

Dutch Door Prep N/A List add per hinge
 Hospital Tips N/A List add per hinge

Electrical Modifications

EPT - Electrical Power Transfer prep \$120.00 List add per hinge
 700CS and 715CS
 TW8 - Electric Through-Wire N/A See above chart for hinge price with TWP (Thru Wire Panel)
 CON - Allegion Connect \$54.00 List add per hinge (Must order with TW8 and add CON List Adder)
 700CS only

Standard cutout locations. Top Edge of Door to Centerline of cutout.

Consult factory for custom locations. Specify location from top edge of door to centerline of cutout. TWP location cannot be moved.

STD LENGTH	EPT	TWP
83"	30"	43-13/16"
85"	32"	44-29/32"
95"	42"	55-9/32"
120"	67"	79-1/2"

Electrical Service Parts

700CS TWP Panel Service Kit \$921.00 List price

Optional Mounting Hardware

Standard Mounting Hardware \$0.00 No List Add
 Hollow Metal Self Drilling / Self Tapping Screws (TEK) for Door and Frame
 Security Screws \$41.00 List add per hinge
 Hollow Metal Door and Frame Specify SECHM
 Wood Screws \$22.00 List add per hinge
 Wood Door and Frame Specify WD

Contact Ives Customer Service for pricing on additional sizes and finishes

Bold pricing indicates item is in stock and available for **Fast Track** and **ProXpress**

Continuous Geared Hinges

Aluminum Based

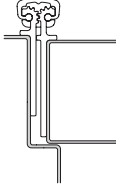
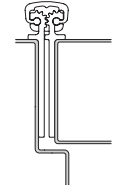
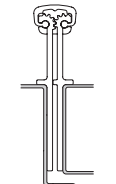
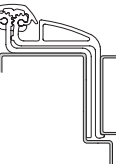
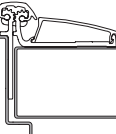
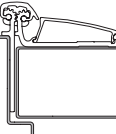
MODEL	DESCRIPTION	FINISH	LENGTH	BHMA FINISH	LIST	NOTES
026XY UL Listed 	026XY Heavy Duty Full Mortise - Narrow Frame Leaf, Wide Door Leaf 3/32" Inset Frame Leaf 1-9/16" Non Handed	US28	83"	628	254.60	
			85"	628	254.60	
			95"	628	309.70	
			119"	628	495.40	
		313AN	83"	710	316.50	
			85"	710	316.50	
			95"	710	406.10	
			119"	710	633.00	
		315AN	83"	711	364.00	
			85"	711	364.00	
			95"	711	466.80	
			119"	711	727.90	
027XY UL Listed 	027XY Heavy Duty Full Mortise - Wide Door Leaf Flush mounted, No inset Frame Leaf 1-7/8 " Non Handed	US28	83"	628	261.40	
			85"	628	261.40	
			95"	628	302.80	
			119"	628	488.60	
		313AN	83"	710	344.00	
			85"	710	344.00	
			95"	710	399.10	
			119"	710	626.20	
		315AN	83"	711	395.60	
			85"	711	395.60	
			95"	711	458.90	
			119"	711	720.10	
040XY UL Listed 	040XY Heavy Duty Full Mortise - Wide Throw Flush mounted, No inset Frame Leaf 1-11/16" Non Handed	US28	83"	628	447.30	
			85"	628	447.30	
			95"	628	550.40	
			119"	628	880.60	
		313AN	83"	710	584.90	
			85"	710	584.90	
			95"	710	701.70	
			119"	710	1,128.40	
		315AN	83"	711	672.60	
			85"	711	672.60	
			95"	711	807.00	
			119"	711	1,297.60	
041XY UL Listed 	041XY Heavy Duty Full Mortise - Swing Clear 1/16" inset Frame Leaf 1-7/8" Non Handed	US28	83"	628	495.40	
			85"	628	495.40	
			95"	628	591.60	
			119"	628	908.20	
		313AN	83"	710	653.70	
			85"	710	653.70	
			95"	710	784.30	
			119"	710	1,176.60	
		315AN	83"	711	751.70	
			85"	711	751.70	
			95"	711	901.90	
			119"	711	1,353.00	
045XY UL Listed 	045XY Heavy Duty Adjustable Half Surface 9/32" Inset Frame leaf 1-9/16" Non Handed	US28	83"	628	515.10	
			85"	628	515.10	
			95"	628	628.20	
			119"	628	942.20	
		313AN	83"	710	691.00	
			85"	710	691.00	
			95"	710	848.10	
			119"	710	1,256.40	
		315AN	83"	711	794.60	
			85"	711	794.60	
			95"	711	975.30	
			119"	711	1,444.80	
046XY UL Listed 	046XY Heavy Duty Adjustable Half Surface 9/32" Inset Frame leaf 1-7/8" Non Handed	US28	83"	628	552.80	
			85"	628	552.80	
			95"	628	678.50	
			119"	628	1,011.50	
		313AN	83"	710	741.30	
			85"	710	741.30	
			95"	710	904.60	
			119"	710	1,344.30	
		315AN	83"	711	852.40	
			85"	711	852.40	
			95"	711	1,040.30	
			119"	711	1,545.90	





Contact Ives Customer Service for pricing on additional sizes and finishes

Bold pricing indicates item is in stock and available for **Fast Track** and **ProXpress**

HINGES
 CONTINUOUS HINGES
 PIVOTS
 Numerical 1-059
 Numerical 59-437
 Numerical 438-1021
 Numerical 1152-8190
 Numerical 8200-9266

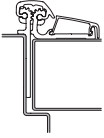
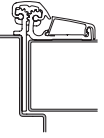
Continuous Geared Hinges

Aluminum Based

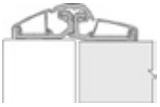

MODEL	DESCRIPTION	FINISH	LENGTH	BHMA FINISH	LIST	NOTES
053XY UL Listed 	053XY Heavy Duty Adjustable Half Surface 1/8" Inset Frame leaf 1-9/16" Non Handed	US28	83"	628	375.10	
			85"	628	375.10	
			95"	628	460.70	
			119"	628	710.70	
		313AN	83"	710	467.30	
			85"	710	467.30	
			95"	710	559.40	
			119"	710	947.70	
		315AN	83"	711	537.50	
			85"	711	537.50	
			95"	711	643.30	
			119"	711	1,089.80	
054XY UL Listed 	054XY Heavy Duty Adjustable Half Surface 1/8" Inset Frame leaf 1-7/8" Non Handed	US28	83"	628	401.50	
			85"	628	401.50	
			95"	628	473.80	
			119"	628	743.70	
		313AN	83"	710	480.40	
			85"	710	480.40	
			95"	710	572.60	
			119"	710	954.20	
		315AN	83"	711	552.40	
			85"	711	552.40	
			95"	711	658.50	
			119"	711	1,097.40	
112HD UL Listed 	112HD Heavy Duty Full Mortise No Inset, Non Handed Frame leaf 1-9/16"	US28	83"	628	186.30	Stocked
			85"	628	186.30	Stocked
			95"	628	232.20	Stocked
			120"	628	371.20	Stocked
		313AN	83"	710	240.50	Stocked
			85"	710	252.60	
			95"	710	300.30	Stocked
			120"	710	509.50	
112XY UL Listed 	112XY Heavy Duty Full Mortise - Narrow Frame Leaf, Narrow Door Leaf No Inset, Frame Leaf 1-9/16" Non Handed	US28	83"	628	233.90	Stocked, including TWP
			85"	628	233.90	
			95"	628	296.00	
			119"	628	467.90	
		313AN	83"	710	302.80	
			85"	710	302.80	
			95"	710	378.50	
			119"	710	612.40	
		315AN	83"	711	348.30	
			85"	711	348.30	
95"	711		435.20			
119"	711		704.30			
114XY UL Listed 	114XY Heavy Duty Full Mortise - Narrow Frame Leaf, Door Edge Protector 1/16" inset Frame Leaf 1-9/16" Non Handed	US28	83"	628	247.70	
			85"	628	247.70	
			95"	628	302.80	
			119"	628	488.60	
		313AN	83"	710	309.70	
			85"	710	309.70	
			95"	710	399.10	
			119"	710	626.20	
		315AN	83"	711	356.10	
			85"	711	356.10	
			95"	711	458.90	
			119"	711	720.10	
157XY UL Listed 	157XY Heavy Duty Adjustable Full Surface Center Pivot 1/16" Inset Non Handed	US28	83"	628	288.60	Stocked
			95"	628	378.60	
			119"	628	643.50	
		313AN	83"	710	346.00	
			95"	710	454.30	
			119"	710	710.80	
		315AN	83"	711	397.90	
			95"	711	522.50	
119"	711	817.50				

Contact Ives Customer Service for pricing on additional sizes and finishes

Bold pricing indicates item is in stock and available for **Fast Track** and **ProXpress**

Continuous Geared Hinges

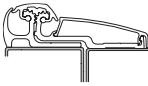
Aluminum Based

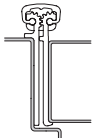
MODEL	DESCRIPTION	FINISH	LENGTH	BHMA FINISH	LIST	NOTES			
210XY UL Listed 	210XY Heavy Duty Adjustable Full Surface Swing Clear 1/32" Inset Non Handed	US28	83"	628	342.20				
			85"	628	342.20				
			95"	628	401.50				
			119"	628	697.60				
		313AN	83"	710	401.50				
			85"	710	401.50				
			95"	710	493.60				
			119"	710	763.30				
		315AN	83"	711	461.60				
			85"	711	461.60				
			95"	711	567.60				
			119"	711	877.90				
224HD UL Listed 	224HD Heavy Duty Full Mortise 1/16" Inset Non Handed	US28	83"	628	198.80	Stocked			
			85"	628	198.80	Stocked			
			95"	628	244.80	Stocked			
			120"	628	385.20				
		313AN	83"	710	247.50				
			85"	710	259.90				
			95"	710	330.00				
			120"	710	518.40				
			224XY UL Listed 	224XY Heavy Duty Full Mortise - Door Edge Protector 1/16" inset Frame Leaf 1-7/8" Non Handed (Handed with HT, TWP, EPT)	US28	83"	628	247.70	Stocked, including TWP
						85"	628	247.70	
95"	628	302.80							
119"	628	488.60							
313AN	83"	710			309.70	Stocked			
	85"	710			309.70				
	95"	710			399.10				
	119"	710			626.20				
315AN	83"	711	356.10						
	85"	711	356.10						
	95"	711	458.90						
	119"	711	720.10						

HINGES
 CONTINUOUS HINGES
 PIVOTS
 Numerical 1-059
 Numerical 59-437
 Numerical 438-1021
 Numerical 1152-8190
 Numerical 8200-9266

Contact Ives Customer Service for pricing on additional sizes and finishes

Bold pricing indicates item is in stock and available for **Fast Track** and **ProXpress**

Continuous Geared Hinges

Geared Hinges - Additional Offerings

Custom Processing*

Custom cut to length	HD Models	\$22.00	List add per hinge
	XY Models	\$44.00	List add per hinge
Custom painting and anodized colors		Contact customer service for pricing and color approval. See Page ix for additional information. Additional lead time up to 6 weeks may be needed.	
		Add pricing below to base 628 finish pricing for the size needed.	
		\$1,132.00	Flat rate for hinge quantity less than 12 for Tiger/Drylac paint
		\$94.00	List add per hinge for each hinge greater than 12.

* Return Policy - requires prior approval, consult factory

Hospital Tip (HT)

HT - Hospital Tip		\$139.00	List add per hinge
<i>026XY, 027XY, 040XY, 112XY, 114XY, 224XY, and 936HD only</i>			
(no additional list add for 936HD)			

Electrical Modifications

EPT - Electrical Power Transfer prep		\$120.00	List add per hinge
<i>026XY, 027XY, 112HD, 112XY, 114XY, 224HD, and 224XY only</i>			
TWP CON - Electric Through-Wire Panel with Allegion Connect		\$563.00	List add per hinge
<i>026XY, 027XY, 112XY, 114XY, and 224XY only</i>			

Standard cutout locations. Top Edge of Door to Centerline of cutout.

Consult factory for custom locations. Specify location from top edge of door to centerline of cutout.

STD LENGTH	HD	XY	XY
	EPT	EPT	TWP
83"	30"	30"	43.5"
85"	32"	32"	45.5"
95"	42"	42"	55.5"
119" (XY)	-	66"	79.5"
120" (HD)	67"	-	-

Electrical Service Parts

XY TWP Panel Service Kit		\$335.00	List price
<i>Same panel for all models (026XY, 027XY, 112XY, 114XY, 224XY)</i>			
<i>Use HGPART.1159 for US28, HGPART.1160 for 313AN</i>			
112HD TWP Panel Service Kit		\$284.00	List price
<i>Use 840737-28 for US28, 840737-42 for 313AN</i>			
224HD TWP Panel Service Kit		\$284.00	List price
<i>Use 840738-28 for US28, 84073842 for 313AN</i>			
112HD/224HD 6' Power Cable Kit for TW8 and TWP		\$402.00	List price
<i>Contains LH & RH cable - 840738-00</i>			

Optional Mounting Hardware

Standard Mounting Hardware		\$0.00	No List add
Hollow Metal Self Drilling / Self Tapping Screws (TEK) for Door and Frame			
Security Screws - Hex Pin Drive		\$41.00	List add per hinge
Hollow Metal Door and Frame			
1/2 Wood, 1/2 Hollow Metal			
Wood Door and Frame			
Wood Screws		\$22.00	List add per hinge
Wood Door and Frame			
1/2 Self Drill, Self Tap, 1/2 Wood			
Thread Forming Screws		\$22.00	List add per hinge
Hollow Metal Door and Frame			
1/2 Thread Forming, 1/2 Wood			
(Pilot holes required. Recommended for grout filled frame)			

Contact Ives Customer Service for pricing on additional sizes and finishes

Bold pricing indicates item is in stock and available for **Fast Track** and **ProXpress**

HINGES

CONTINUOUS HINGES

PIVOTS

Numerical
1-059

Numerical
59-437

Numerical
438-1021

Numerical
1152-8190

Numerical
8200-9266

MOUNTING HARDWARE

Standard Hardware Included - Hollow Metal Door and Frame		
Full Mortise Hinges	12-24 x 3/4" Steel Self Drilling/Self Tapping, Flat Head, Phillips Screw (TEK)	
Half Surface Hinges Includes 210XY	12-24 x 3/4" Steel Self Drilling/Self Tapping, Flat Head, Phillips Screw (TEK) 12-24 x 3/4" Steel Self Drilling/Self Tapping, Hex Head Screw (TEK)	
Full Surface Hinges 157XY Only	12-24 x 3/4" Steel Self Drilling/Self Tapping, Hex Head Screw (TEK)	
Security Screws - Hollow Metal Door and Frame (SECHM)		
Full Mortise Hinges 112HD and 224HD Only	12-24 x 3/4" Stainless Steel, Flat Head, Hex Pin Security Machine Screw	
Available as Accessory Parts Kit for Full Mortise XY Hinges (026XY, 027YX, 040XY, 041XY, 112XY, 112XY, 114XY, 224XY)		
Security Screws - 1/2 Wood, 1/2 Hollow Metal (SECWDHM)		
Full Mortise Hinges 112HD and 224HD Only	12-24 x 3/4" Stainless Steel, Flat Head, Hex Pin Security Machine Screw 12-24 x 3/4" Stainless Steel Socket, Flat Head, Hex Pin Security Wood Screw	
Available as Accessory Parts Kit for Full Mortise XY Hinges (026XY, 027YX, 040XY, 041XY, 112XY, 112XY, 114XY, 224XY)		
Security Screws - Wood Door and Frame (SECWDWD)		
Full Mortise Hinges 112HD and 224HD Only	12 X 1 1/4" Stainless Steel, Flat Head, Hex Pin Security Wood Screw	
Available as Accessory Parts Kit for Full Mortise XY Hinges (026XY, 027XY, 040XY, 041XY, 112XY, 114XY, 224XY)		
Wood Door and Frame (WD)		
Full Mortise Hinges	12 x 1-1/4" Flat Head, Phillips Screw	
Half Surface Hinges Includes 210XY	12 x 1-1/4" Flat Head, Phillips Screw 1/4 x 1-1/2" Hex Head Lag Screw	
Full Surface Hinges 157XY Only	1/4 x 1-1/2" Hex Head Lag Screw	
1/2 Self Drill, Self Tap 1/2 Wood (TEKWD)		
Full Mortise Hinges	12-24 x 3/4" Steel Self Drilling/Self Tapping, Flat Head, Phillips Screw (TEK)	12 x 1-1/4" Flat Head, Phillips Wood Screw
Half Surface Hinges	12-24 x 3/4" Steel Self Drilling/Self Tapping, Flat Head, Phillips Screw (TEK)	1/4 x 1-1/2" Hex Head, Lag Screw
Full Surface Hinges	12-24 x 3/4" Steel Self Drilling/Self Tapping, Hex Head Screw (TEK)	1/4 x 1-1/2" Hex Head, Lag Screw
Thread Forming- Hollow Metal Door and Frame (TF)		
Full Mortise Hinges 112HD and 224HD Only	12-24 x 3/4" Steel Thread Forming, Flat Head, Phillips Wood Screw	
Available as Accessory Parts Kit for Full Mortise XY Hinges (026XY, 027YX, 040XY, 041XY, 112XY, 112XY, 114XY, 224XY)		
Thread Forming - 1/2 Thread Forming Hollow Metal, 1/2 Wood (TFWD)		
Full Mortise Hinges 112HD and 224HD Only	12-24 x 3/4" Steel Thread Forming, Flat Head, Phillips Screw 12 x 1 1/4" Flat Head, Phillips Wood Screw	
Available as Accessory Parts Kit for Full Mortise XY Hinges (026XY, 027XY, 040XY, 041XY, 112XY, 114XY, 224XY)		

HINGES

CONTINUOUS
HINGES

PIVOTS

Numerical
1-059

Numerical
59-437

Numerical
438-1021

Numerical
1152-8190

Numerical
8200-9266

Templates and installation instructions available on line at www.allegion.com/us

Contact Ives Customer Service for pricing on additional sizes and finishes

Pivots

	MODEL	PART DESCRIPTION	POUND RATING	BOX QTY	US3	US4	US10	US10B	US15	US26 *US32	US26D *US32D	643e 716	SP28	SP10	BLK	SP313	SP4
HINGES	7212 3/4" Offset Pivot	7212 SET	200	1	427.50	427.50	427.50	427.50	427.50	427.50	390.40	427.50	248.30	248.30	248.30	248.30	248.30
		7212 TOP	-	1	248.30	248.30	248.30	248.30	248.30	248.30	213.70	248.30	151.40	151.40	151.40	151.40	151.40
		7212 BTM	200	1	260.20	260.20	260.20	260.20	260.20	260.20	223.00	260.20	169.90	169.90	169.90	169.90	169.90
		7212 INT	100	1	285.40	285.40	285.40	285.40	285.40	285.40	248.30	285.40	196.60	196.60	196.60	196.60	196.60
CONTINUOUS HINGES	7212V 3/4" Offset Pivot, Jamb Mount	7212V SET	200	1	444.70	444.70	444.70	444.70	444.70	444.70	408.80	444.70	338.40	338.40	338.40	338.40	338.40
		7212V TOP	-	1	260.20	260.20	260.20	260.20	260.20	260.20	223.00	260.20	169.90	169.90	169.90	169.90	169.90
		7212V INT	100	1	285.40	285.40	285.40	285.40	285.40	285.40	248.30	285.40	196.60	196.60	196.60	196.60	196.60
PIVOTS	7215 3/4" Offset Pivot	7215 SET	500	1	462.10	462.10	462.10	462.10	462.10	462.10	427.50	462.10	373.10	373.10	373.10	373.10	373.10
		7215 TOP	-	1	248.30	248.30	248.30	248.30	248.30	248.30	213.70	248.30	151.40	151.40	151.40	151.40	151.40
		7215 BTM	500	1	285.40	285.40	285.40	285.40	285.40	285.40	266.90	285.40	290.70	290.70	290.70	290.70	290.70
		7215 INT	100	1	260.20	260.20	260.20	260.20	260.20	260.20	231.10	260.20	213.70	213.70	213.70	213.70	213.70
		7215PT(TW4) INT	-	1	930.90	930.90	930.90	930.90	930.90	930.90	722.30	930.90	676.30	676.30	676.30	676.30	676.30
Numerical 1-059	7215F Fire Rated 3/4" Offset Pivot	7215F SET	500	1	729.00	-	729.00	-	-	729.00	691.50	729.00	568.40	568.40	568.40	568.40	568.40
		7215F TOP	-	1	436.80	-	436.80	-	-	436.80	383.60	436.80	320.00	320.00	320.00	320.00	320.00
		7215F BTM	500	1	508.60	-	508.60	-	-	508.60	471.20	508.60	373.10	373.10	373.10	373.10	373.10
		7215F INT	100	1	408.80	-	408.80	-	-	408.80	390.40	408.80	330.60	330.60	330.60	330.60	330.60
Numerical 59-437	7222 3/4" Offset Pivot	7222 SET	200	1	373.10	373.10	373.10	373.10	373.10	373.10	338.40	373.10	248.30	248.30	248.30	248.30	248.30
		7222 TOP	-	1	248.30	248.30	248.30	248.30	248.30	248.30	213.70	248.30	151.40	151.40	151.40	151.40	151.40
		7222 BTM	200	1	241.70	241.70	241.70	241.70	241.70	241.70	205.70	241.70	143.40	143.40	143.40	143.40	143.40
		7222 INT	100	1	285.40	285.40	285.40	285.40	285.40	285.40	248.30	285.40	196.60	196.60	196.60	196.60	196.60
Numerical 438-1021	7226 3/4" Offset Pivot	7226 SET	600	1	444.70	444.70	444.70	444.70	444.70	444.70	408.80	444.70	320.00	320.00	320.00	320.00	320.00
		7226 TOP	-	1	248.30	248.30	248.30	248.30	248.30	248.30	213.70	248.30	151.40	151.40	151.40	151.40	151.40
		7226 BTM	600	1	266.90	266.90	266.90	266.90	266.90	266.90	248.30	266.90	223.00	223.00	223.00	223.00	223.00
		7226 INT	100	1	260.20	260.20	260.20	260.20	260.20	260.20	231.10	260.20	213.70	213.70	213.70	213.70	213.70
		7226PT(TW4) INT	-	1	930.90	930.90	930.90	930.90	930.90	930.90	722.30	930.90	676.30	676.30	676.30	676.30	676.30

Lead time exception: The following Pivots are stocked.

7212 Set, US26D, 7215 Set US26D, 7222 Set US26D, 7226 Set US26D, 7212-7212V-7222 INT US26D, 7215-7226-7227 INT US26D, 7215-7226-7227 PT INT US26D

Non-Stocked PT INT pivots may take up to 4-5 weeks for shipment.

Pivots

MODEL	PART DESCRIPTION	POUND RATING	BOX QTY	US3	US4	US10	US10B	US15	US26 *US32	US26D *US32D	643e 716	SP28	SP10	BLK	SP313	SP4
7226F Fire Rated 3/4" Offset Pivot	7226F SET	600	1	640.00	-	640.00	-	-	640.00	605.40	640.00	515.20	515.20	515.20	515.20	515.20
	7226F TOP	-	1	436.80	-	436.80	-	-	436.80	383.60	436.80	320.00	320.00	320.00	320.00	320.00
	7226F BTM	600	1	454.10	-	454.10	-	-	454.10	390.40	454.10	366.50	366.50	366.50	366.50	366.50
	7226F INT	600	1	408.80	-	408.80	-	-	408.80	390.40	408.80	330.60	330.60	330.60	330.60	330.60
7227 3/4" Offset Pivot	7227 SET	700	1	747.40	747.40	747.40	747.40	747.40	747.40	711.80	747.40	622.60	622.60	622.60	622.60	622.60
	7227 TOP	-	1	248.30	248.30	248.30	248.30	248.30	248.30	213.70	248.30	151.40	151.40	151.40	151.40	151.40
	7227 BTM	700	1	675.70	675.70	675.70	675.70	675.70	675.70	605.40	675.70	560.40	560.40	560.40	560.40	560.40
	7227 INT	100	1	260.20	260.20	260.20	260.20	260.20	260.20	231.10	260.20	213.70	213.70	213.70	213.70	213.70
	7227PT(TW4) INT	-	1	930.90	930.90	930.90	930.90	930.90	930.90	722.30	930.90	676.30	676.30	676.30	676.30	676.30
7227F Fire Rated 3/4" Offset Pivot	7227F SET	700	1	941.30	-	941.30	-	-	941.30	905.60	941.30	799.30	799.30	799.30	799.30	799.30
	7227F TOP	-	1	436.80	-	436.80	-	-	436.80	383.60	436.80	320.00	320.00	320.00	320.00	320.00
	7227F BTM	700	1	675.70	-	675.70	-	-	675.70	605.40	675.70	560.40	560.40	560.40	560.40	560.40
	7227F INT	100	1	408.80	-	408.80	-	-	408.80	390.40	408.80	330.60	330.60	330.60	330.60	330.60
7230F Fire Rated 3/4" Offset Pivot	7230F SET	1000	1	799.30	-	799.30	-	-	799.30	763.30	799.30	675.70	675.70	675.70	675.70	675.70
	7230F TOP	-	1	408.80	-	408.80	-	-	408.80	383.60	408.80	330.60	330.60	330.60	330.60	330.60
	7230F BTM	1000	1	489.70	-	489.70	-	-	489.70	471.20	489.70	418.30	418.30	418.30	418.30	418.30
	7230F INT	100	1	444.70	-	444.70	-	-	444.70	427.50	444.70	366.50	366.50	366.50	366.50	366.50
7237F Fire Rated 3/4" Offset	7237F SET	1750	1	977.10	-	977.10	-	-	977.10	941.30	977.10	853.80	853.80	853.80	853.80	853.80
	7237F TOP	-	1	408.80	-	408.80	-	-	408.80	383.60	408.80	330.60	330.60	330.60	330.60	330.60
	7237F BTM	1750	1	675.70	-	675.70	-	-	675.70	657.20	675.70	613.50	613.50	613.50	613.50	613.50
	7237F INT	100	1	444.70	-	444.70	-	-	444.70	427.50	444.70	366.50	366.50	366.50	366.50	366.50
7244F Fire Rated 1-1/2" Offset Pivot	7244F SET	400	1	827.20	-	827.20	-	-	827.20	799.30	827.20	691.50	691.50	691.50	691.50	691.50
	7244F TOP	-	1	444.70	-	444.70	-	-	444.70	418.30	444.70	383.60	383.60	383.60	383.60	383.60
	7244F BTM	400	1	480.60	-	480.60	-	-	480.60	454.10	480.60	390.40	390.40	390.40	390.40	390.40
	7244F INT	100	1	480.60	-	480.60	-	-	480.60	454.10	480.60	400.90	400.90	400.90	400.90	400.90

Lead time exception: The following Pivots are stocked.

7230F Set US32D, 7230F-7237F INT US32D, 7215-7226-7227 PT INT US26D

Non-Stocked PT INT pivots may take up to 4-5 weeks for shipment.

HINGES

CONTINUOUS HINGES

PIVOTS

Numerical 1-059

Numerical 59-437

Numerical 438-1021

Numerical 1152-8190

Numerical 8200-9266

Contact Ives Customer Service for pricing on additional sizes and finishes

Bold pricing indicates item is in stock and available for **Fast Track** and **ProXpress**

Pivots

MODEL	PART DESCRIPTION	POUND RATING	BOX QTY	US3	US4	US10	US15	US10B	US26 *US32	US26D *US32D	643e 716	SP28	SP10	BLK	SP313	SP4	USP
7245F Fire Rated 1-1/2" Offset Pivot	7245FSET	500	1	1,066.10	-	1,066.10	-	-	1,066.10	1,030.40	1,066.10	941.30	941.30	941.30	941.30	941.30	-
	7245F TOP	-	1	444.70	-	444.70	-	-	444.70	418.30	444.70	383.60	383.60	383.60	383.60	383.60	-
	7245F BTM	500	1	747.40	-	747.40	-	-	747.40	729.00	747.40	657.20	657.20	657.20	657.20	657.20	-
	7245FINT	100	1	480.60	-	480.60	-	-	480.60	454.10	480.60	400.90	400.90	400.90	400.90	400.90	-
7253 1-1/2" Pivot Center Hung	7253SET	300	1	338.40	338.40	338.40	338.40	338.40	338.40	338.40	338.40	294.70	294.70	294.70	294.70	294.70	-
	7253 TOP	-	1	205.70	205.70	205.70	205.70	205.70	205.70	205.70	205.70	187.30	187.30	187.30	187.30	187.30	-
	7253 BTM	300	1	187.30	187.30	187.30	187.30	187.30	187.30	161.90	187.30	135.50	135.50	135.50	135.50	135.50	-
7255 1-1/2" Pivot Center Hung	7255SET	500	1	373.10	373.10	373.10	373.10	373.10	373.10	373.10	373.10	347.90	347.90	347.90	347.90	347.90	-
	7255 TOP	-	1	205.70	205.70	205.70	205.70	205.70	205.70	205.70	205.70	187.30	187.30	187.30	187.30	187.30	-
	7255 BTM	500	1	213.70	213.70	213.70	213.70	213.70	213.70	213.70	213.70	205.70	205.70	205.70	205.70	205.70	-
7255J 1-1/2" Pivot Center Hung	7255JSET	600	1	373.10	373.10	373.10	373.10	373.10	373.10	373.10	373.10	347.90	347.90	347.90	347.90	347.90	-
	7255J TOP	-	1	205.70	205.70	205.70	205.70	205.70	205.70	205.70	205.70	187.30	187.30	187.30	187.30	187.30	-
	7255J BTM	500	1	213.70	213.70	213.70	213.70	213.70	213.70	213.70	213.70	205.70	205.70	205.70	205.70	205.70	-
7256 1-1/2" Pivot Center Hung	7256SET	600	1	622.60	622.60	622.60	622.60	622.60	622.60	587.00	622.60	560.40	560.40	560.40	560.40	560.40	-
	7256 TOP	-	1	205.70	205.70	205.70	205.70	205.70	205.70	205.70	205.70	187.30	187.30	187.30	187.30	187.30	-
	7256 BTM	600	1	508.60	508.60	508.60	508.60	508.60	508.60	480.60	508.60	454.10	454.10	454.10	454.10	454.10	-
7259 1-1/2" Pivot Center Hung	7259SET	1000	1	1,119.10	1,119.10	1,119.10	1,119.10	1,119.10	1,119.10	1,082.00	1,119.10	1,047.40	1,047.40	1,047.40	1,047.40	1,047.40	-
	7259 TOP	-	1	436.80	436.80	436.80	436.80	436.80	436.80	373.10	436.80	312.00	312.00	312.00	312.00	312.00	-
	7259 BTM	1000	1	924.10	924.10	924.10	924.10	924.10	924.10	888.20	924.10	861.60	861.60	861.60	861.60	861.60	-
91105F Pocket Pivot E = Power Transfer	91105F	90	1	504.20	-	504.20	504.20	504.20	504.20	457.50	504.20	-	-	-	457.50	-	457.50
	E91105F	90	1	1,175.20	-	1,175.20	-	-	1,175.20	1,127.60	1,175.20	-	-	-	1,127.60	-	1,127.60

Lead time exception: The following Pivots are stocked.

7253 Set US26D and SP28, 7255 Set US26D and SP28, 7255J Set US26D, 91105F US32D, E91105 US32D

Non-Stocked E91105F pivots may take up to 4-5 weeks for shipment.

* Fire rated models US32 and US32D (stainless), all others US26 and US26D (brass)

Suffix Descriptions

BTM - Bottom Only

F - Fire Rated

INT - Intermediate Pivot Only







PT - Power Transfer, TW4 standard, TW* consult Factory for lead time.

SET - Top and Bottom Pivot

TOP - Top Only

V - Vertical Side Mount

(Weather Resistant) WP bearings available for 7215 26D and 7215F 32D bottom pivots at \$76 list add. Consult factory for lead time.

MODEL	SUBSTRATE	MODEL NUMBER	BHMA FINISH	WEIGHT	MUST BE ORDERED IN MULTIPLE QTY	MULTIPLE QTY	PACKED PER BOX	LIST PRICE	
								EACH	PACKAGE
CBI Carry Bar w/ Sex Bolts 	Steel	CBI USP	600	-	-	-	-	\$36.80	-
		CBI US3	632	-	-	-	-	56.30	-
		CBI US4	633	-	-	-	-	56.30	-
		CBI US10	639	-	-	-	-	56.30	-
		CBI US10B	640	-	-	-	-	56.30	-
		CBI US26	651	-	-	-	-	56.30	-
		CBI US26D**	652	-	-	-	-	56.30	-
		CBI BLK	-	-	-	-	-	36.80	-
DP1 Dust Proof Strike Threshold Only 	Brass	DP1 US3	605	-	-	1	-	29.30	-
		DP1 US4	606	-	-	1	-	29.30	-
		DP1 US10	612	-	-	1	-	29.30	-
		DP1 US10B **	613	-	-	1	-	29.30	-
		DP1 US26	625	-	-	1	-	29.30	-
		DP1 US26D **	626	-	-	1	-	29.30	-
LG1 Lock Guard with Security Pin Frame 	Steel	LG1 USP	600	-	-	1	-	24.70	-
		LG1 US2G**	603	-	-	1	-	20.20	-
		LG1 SP313	695	-	-	1	-	23.30	-
	Brass	LG1 US4	606	-	-	1	-	51.40	-
		LG1 US10	612	-	-	1	-	51.40	-
Stainless	LG1 US32D**	630	-	-	1	-	46.70	-	
MB1 Mounting Bracket	See Page 32								
DP2 Dust Proof Strike Floor and /or Threshold 	Brass	DP2 US3	605	-	-	1	-	36.90	-
		DP2 US4	606	-	-	1	-	36.90	-
		DP2 US10	612	-	-	1	-	36.90	-
		DP2 US10B **	613	-	-	1	-	36.90	-
		DP2 US15	619	-	-	1	-	36.90	-
		DP2 US26 **	625	-	-	1	-	36.90	-
		DP2 US26D **	626	-	-	1	-	36.90	-
		DP2 643E/716	-	-	-	1	-	36.90	-
DP2 BLK	622	-	-	1	-	36.90	-		
MB2 Mounting Bracket	See Page 32								
2 Elbow Cabinet Catch 	Aluminum	2A3**	666	0.9	-	1	20	4.30	-
		2A5	-	0.9	-	1	20	4.80	-
		2A14	669	0.9	-	1	20	4.80	-
		2A15	670	0.9	-	1	20	4.80	-
		2A26	672	0.9	-	1	20	4.80	-
		2A26D	702	0.9	-	1	20	4.80	-
		2A92**	673	0.9	-	1	20	4.30	-
		2A-643E/716	-	0.9	-	1	20	4.80	-
		2A-BLK	-	0.9	-	1	20	4.80	-
		SP2A3	666	37.5	Yes	25	25	-	107.00
		SP2A14	669	37.5	Yes	25	25	-	117.75
SP2A92**	673	37.5	Yes	25	25	-	107.00		
MB3 Mounting Bracket	See Page 32								
LG7 Lock Guard	Stainless	LG7 US32D**	630	-	-	1	-	46.70	-
COR7G Coordinator Gravity Arm 7" arm UL Listed 	Brass	COR7G US3	605	-	-	1	-	92.40	-
		COR7G US4	606	-	-	1	-	92.40	-
		COR7G US10	612	-	-	1	-	92.40	-
		COR7G US10B	613	-	-	1	-	92.40	-
		COR7G US26	625	-	-	1	-	124.70	-
		COR7G US26D**	626	-	-	1	-	76.80	-

HINGES

CONTINUOUS HINGES

PIVOTS

Numerical 1-059

Numerical 59-437

Numerical 438-1021







Numerical 1152-8190

Numerical 8200-9266

Lead time exception: ** Products are stocked and will typically ship in 3-5 days













Bold pricing indicates item is in stock and available for **Fast Track** and **ProXpress**

HINGES
 CONTINUOUS HINGES
 PIVOTS
 Numerical 1-059
 Numerical 59-437
 Numerical 438-1021
 Numerical 1152-8190
 Numerical 8200-9266

MODEL	SUBSTRATE	MODEL NUMBER	BHMA FINISH	WEIGHT	MUST BE ORDERED IN MULTIPLE QTY	MULTIPLE QTY	PACKED PER BOX	LIST PRICE		
								EACH	PACKAGE	
07 Window Lock 	Aluminum	07A3**	666	1.7	-	1	20	\$2.90	-	
		07A10B	703	1.7	-	-	1	20	3.20	-
		07A14	669	1.7	-	-	1	20	3.20	-
		07A15	670	1.7	-	-	1	20	3.20	-
		07A26	672	1.7	-	-	1	20	3.20	-
		07A26D	702	1.7	-	-	1	20	3.20	-
		07A92	673	1.7	-	-	1	20	2.90	-
		07A-643E/716	-	1.7	-	-	1	20	3.20	-
		07A-BLK	-	1.7	-	-	1	20	4.30	-
		07A-W	-	1.7	-	-	1	20	4.30	-
		SP07A3	666	65	Yes	25	25	-	-	72.25
		SP07A5	-	65	Yes	25	25	-	-	107.00
		SP07A14	669	65	Yes	25	25	-	-	80.25
		SP07A92	673	65	Yes	25	25	-	-	72.25
		SP07A-W	-	52	Yes	20	20	-	-	85.60
COR9G Coordinator Gravity Arm 9" arm UL Listed	Brass	COR9G US3	605	-	-	1	-	104.50	-	
		COR9G US4	606	-	-	1	-	104.50	-	
		COR9G US10	612	-	-	1	-	104.50	-	
		COR9G US10B	613	-	-	1	-	104.50	-	
		COR9G US26	625	-	-	1	-	124.70	-	
		COR9G US26D**	626	-	-	1	-	88.10	-	
FS9 Floor Stop 	Brass	FS9 US3	605	-	-	1	-	211.10	-	
		FS9 US4	606	-	-	1	-	211.10	-	
		FS9 US10	612	-	-	1	-	211.10	-	
		FS9 US10B	613	-	-	1	-	211.10	-	
		FS9 US26	625	-	-	1	-	211.10	-	
		FS9 US26D	626	-	-	1	-	180.90	-	
LG10 Lock Guard 	Stainless	LG10 US32D**	630	-	-	1	-	43.50	-	
	Steel	LG10 USP	600	-	-	1	-	29.60	-	
CL11 Cabinet Latch 	Brass	CL11 US3	605	-	-	1	-	47.50	-	
		CL11 US4	606	-	-	1	-	37.50	-	
		CL11 US10	612	-	-	1	-	37.50	-	
		CL11 US26D	626	-	-	1	-	37.50	-	
LG11 Lock Guard 	Stainless	LG11 US32D RH	630	-	-	1	-	51.40	-	
		LG11 US32D LH**	630	-	-	1	-	51.40	-	
	Steel	LG11 SP313 RH	695	-	-	1	-	38.80	-	
		LG11 SP313 LH	695	-	-	1	-	38.80	-	
WS11 Wall Stop for Drywall Mounting 	Brass	WS11 US3	605	-	-	1	-	47.00	-	
		WS11 US4	606	-	-	1	-	47.00	-	
		WS11 US10	612	-	-	1	-	47.00	-	
		WS11 US10B	613	-	-	1	-	47.00	-	
		WS11 US26	625	-	-	1	-	47.00	-	
		WS11 US26D**	626	-	-	1	-	45.70	-	

Lead time exception: ** Products are stocked and will typically ship in 3-5 days

Bold pricing indicates item is in stock and available for **Fast Track** and **ProXpress**

MODEL	SUBSTRATE	MODEL NUMBER	BHMA FINISH	WEIGHT	MUST BE ORDERED IN MULTIPLE QTY	MULTIPLE QTY	PACKED PER BOX	LIST PRICE	
								EACH	PACKAGE
WS11X Wall Stop for Masonry Mounting 	Brass	WS11X US3	605	-	-	1	-	\$50.10	-
		WS11X US4	606	-	-	1	-	50.10	-
		WS11X US10	612	-	-	1	-	50.10	-
		WS11X US10B	613	-	-	1	-	50.10	-
		WS11X US26	625	-	-	1	-	50.10	-
		WS11X US26D	626	-	-	1	-	48.50	-
CL12 Cabinet Latch 	Brass	CL12 US3	605	-	-	1	-	51.60	-
		CL12 US4**	606	-	-	1	-	45.60	-
		CL12 US10	612	-	-	1	-	45.60	-
		CL12 US26D **	626	-	-	1	-	45.60	-
LG12 Lock Guard - Narrow 	Stainless	LG12 US32D **	630	-	-	1	-	40.40	-
	Steel	LG12 USP	600	-	-	1	-	29.60	-
FS13 Floor Dome Stop 1" height 	Brass	FS13 US3	605	-	-	1	-	8.50	-
		FS13 US4	606	-	-	1	-	10.10	-
		FS13 US10	612	-	-	1	-	10.20	-
		FS13 US10B **	613	-	-	1	-	10.20	-
		FS13 US26	625	-	-	1	-	10.10	-
		FS13 US26D **	626	-	-	1	-	8.50	-
LG13 Lock Guard 	Stainless	LG13 US32D **	630	-	-	1	-	38.80	-
	Steel	LG13 USP	600	-	-	1	-	25.60	-
CL14 Cabinet Latch 	Brass	CL14 US3	605	-	-	1	-	47.30	-
		CL14 US4	606	-	-	1	-	39.70	-
		CL14 US10	612	-	-	1	-	39.70	-
		CL14 US26D **	626	-	-	1	-	39.70	-
LG14 Lock Guard 	Stainless	LG14 US32D **	630	-	-	1	-	63.80	-
FS17 Floor Dome Stop 1-11/32" height 	Brass	FS17 US3	605	-	-	1	-	9.40	-
		FS17 US4	606	-	-	1	-	11.40	-
		FS17 US10	612	-	-	1	-	11.70	-
		FS17 US10B	613	-	-	1	-	11.70	-
		FS17 US26	625	-	-	1	-	11.40	-
		FS17 US26D **	626	-	-	1	-	9.40	-
R14 Riser For FS13 and FS17 Dome Stops 5/16" Height 	Steel	R14 US3	605	-	-	1	-	7.20	-
		R14 US4	606	-	-	1	-	7.20	-
		R14 US10	612	-	-	1	-	8.00	-
		R14 US10B	613	-	-	1	-	8.00	-
		R14 US26	625	-	-	1	-	8.00	-
		R14 US26D **	626	-	-	1	-	9.30	-
AS18 Applied Stop 	Brass	AS18 US3	605	-	-	1	-	54.60	-
		AS18 US4	606	-	-	1	-	50.20	-
		AS18 US10	612	-	-	1	-	50.20	-
		AS18 US10B	613	-	-	1	-	54.60	-
		AS18 US26	625	-	-	1	-	54.60	-
		AS18 US26D **	626	-	-	1	-	54.60	-
FS18 Security Floor or Wall Stop 	Steel/	FS18S **	-	-	-	1	-	12.50	-
	Rubber	FS18L **	-	-	-	1	-	17.70	-
FL20 Filler Bar 	See page 32								
WS20 Manual Wall Stop and Holder for Drywall Mounting 	Brass	WS20 US3	605	-	-	1	-	85.00	-
		WS20 US4	606	-	-	1	-	85.00	-
		WS20 US10	612	-	-	1	-	85.00	-
		WS20 US10B	613	-	-	1	-	85.00	-
		WS20 US26	625	-	-	1	-	85.00	-
		WS20 US26D **	626	-	-	1	-	71.40	-
	Aluminum	WS20 US28	628	-	-	1	-	68.10	-

Lead time exception: ** Products are stocked and will typically ship in 3-5 days

Bold pricing indicates item is in stock and available for **Fast Track** and **ProXpress**

HINGES

CONTINUOUS
HINGES

PIVOTS

Numerical
1-059





Numerical
59-437

Numerical
438-1021

Numerical
1152-8190

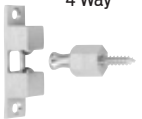
Numerical
8200-9266





HINGES
 CONTINUOUS HINGES
 PIVOTS
 Numerical 1-059
 Numerical 59-437
 Numerical 438-1021
 Numerical 1152-8190
 Numerical 8200-9266

MODEL	SUBSTRATE	MODEL NUMBER	BHMA FINISH	WEIGHT	MUST BE ORDERED IN MULTIPLE QTY	MULTIPLE QTY	PACKED PER BOX	LIST PRICE	
								EACH	PACKAGE
WS20X Manual Wall Stop and Holder for Masonry Mounting 	Brass	WS20X US3	605	-	-	1	-	88.00	-
		WS20X US4	606	-	-	1	-	88.00	-
		WS20X US10	612	-	-	1	-	88.00	-
		WS20X US10B	613	-	-	1	-	88.00	-
		WS20X US26	625	-	-	1	-	88.00	-
		WS20X US26D	626	-	-	1	-	76.00	-
	Aluminum	WS20X US28	628	-	-	1	-	72.30	-
CL21/21A Ball Catch 4 Way 	Brass	CL21 US26D	626	-	-	1	-	47.20	-
		CL21A US3	605	-	-	1	-	50.20	-
		CL21A US4	606	-	-	1	-	33.90	-
		CL21A US10	612	-	-	1	-	33.90	-
		CL21A US26	625	-	-	1	-	50.20	-
		CL21A US26D**	626	-	-	1	-	36.90	-
CL22 Ball Catch 3 Way 	Brass	CL22 US3	605	-	-	1	-	29.50	-
		CL22 US4	606	-	-	1	-	20.70	-
		CL22 US10	612	-	-	1	-	20.70	-
		CL22 US26	625	-	-	1	-	29.50	-
		CL22 US26D	626	-	-	1	-	24.90	-
22 Flush Pull 	Brass	22B3	605	1.1	-	1	20	3.50	-
		22B5	609	2.0	-	1	20	4.00	-
		22B10B**	613	1.3	-	1	20	4.00	-
		22B15**	619	1.6	-	1	20	3.90	-
		22B26	625	1.6	-	1	20	4.00	-
		22B26D**	626	1.1	-	1	20	4.00	-
		22B643E/716	-	1.1	-	1	20	4.00	-
		22B-BLK	622	1.1	-	1	20	4.00	-
SP22B3	605	50.0	Yes	25	25	-	89.50		
25 Screen Door Pull 	Aluminum	25A3	666	1.2	-	1	20	2.00	-
		25A92	673	1.2	-	1	20	2.00	-
		25A-BLK	-	1.2	-	1	20	2.90	-
		25A-W	-	1.2	-	1	20	2.90	-
		SP25A3	666	30.0	Yes	25	25	-	49.75
		SP25A92	673	30.0	Yes	25	25	-	49.75
026 Bar Window Lift 	Aluminum	026A3	666	1.9	-	1	10	2.00	-
		026A5	-	1.1	-	1	10	2.60	-
		026A14	669	1.8	-	1	10	2.60	-
		026A15	670	1.9	-	1	10	2.60	-
		026A26	672	1.9	-	1	10	2.60	-
		026A26D	702	1.9	-	1	10	2.60	-
		026A92	673	1.1	-	1	10	2.00	-
		026A-643E/716	-	1.1	-	1	10	2.60	-
		026A-BLK	-	1.4	-	1	10	3.10	-
		026A-W	-	1.4	-	1	10	3.10	-
		SP026A3	666	45.0	Yes	25	25	-	50.75
		SP026A5	-	45.0	Yes	25	25	-	64.25
		SP026A14	669	45.0	Yes	25	25	-	64.25
SP026A92	673	45.0	Yes	25	25	-	50.75		
		SP026A-W	-	-	Yes	20	20	-	62.00

Continued on next page.

Lead time exception: ** Products are stocked and will typically ship in 3-5 days

Bold pricing indicates item is in stock and available for **Fast Track** and **ProXpress**

MODEL	SUBSTRATE	MODEL NUMBER	BHMA FINISH	WEIGHT	MUST BE ORDERED IN MULTIPLE QTY	MULTIPLE QTY	PACKED PER BOX	LIST PRICE	
								EACH	PACKAGE
<i>Continued from previous page.</i> 026 Bar Window Lift 	Brass	026B3	605	-	-	1	10	9.10	
		026B5	609	-	-	1	10	11.00	
		026B15	619	-	-	1	10	11.20	
		026B26	625	-	-	1	10	11.20	
		026B26D	626	-	-	1	10	11.00	
		026B-643E/716	-	-	-	1	10	11.20	
		026B-BLK	622	-	-	1	10	11.20	
		SPO26B26	625	-	Yes	10	10	-	112.40
RL30 Nylon Roller 	Brass	RL30 US3	605	-	-	1	-	77.10	-
		RL30 US4	606	-	-	1	-	65.60	-
		RL30 US10	612	-	-	1	-	68.30	-
		RL30 US10B **	613	-	-	1	-	79.90	-
		RL30 US15	619	-	-	1	-	77.10	-
		RL30 US26	625	-	-	1	-	77.10	-
		RL30 US26D **	626	-	-	1	-	72.90	-
		RL30 643E/716	-	-	-	1	-	79.90	-
RL30 BLK	622	-	-	1	-	72.90	-		
RL30A Nylon Roller w/ASA Strike 	Brass	RL30-A US3	605	-	-	1	-	86.30	-
		RL30-A US4	606	-	-	1	-	74.90	-
		RL30-A US10	612	-	-	1	-	77.90	-
		RL30-A US10B	613	-	-	1	-	89.50	-
		RL30-A US26	625	-	-	1	-	86.30	-
		RL30-A US26D **	626	-	-	1	-	82.20	-
FB31 Automatic Flush Bolts, Metal Doors UL 3 Hour Top and Bottom Bolt P=Pair T=Top Bolt Only B=Bottom Bolt Only Optional Rod Lengths Available 18", 24", 36", 48" 12.60 List Add 	Steel	FB31P-12-MD US3	605	-	-	1	-	207.50	-
		FB31P-12-MD US4	606	-	-	1	-	207.50	-
		FB31P-12-MD US10	612	-	-	1	-	207.50	-
		FB31P-12-MD US10B **	613	-	-	1	-	207.50	-
	Stainless	FB31P-12-MD US32	629	-	-	1	-	207.50	-
		FB31P-12-MD US32D **	630	-	-	1	-	207.50	-
		FB31P-12-MD BLK	-	-	-	1	-	207.50	-
	Brass	FB31T-12-MD US3	605	-	-	1	-	109.50	-
		FB31T-12-MD US4	606	-	-	1	-	109.50	-
		FB31T-12-MD US10	612	-	-	1	-	109.50	-
		FB31T-12-MD US10B	613	-	-	1	-	109.50	-
	Stainless	FB31T-12-MD US32	629	-	-	1	-	109.50	-
		FB31T-12-MD US32D **	630	-	-	1	-	109.50	-
		FB31T-12-MD BLK	-	-	-	1	-	109.50	-
	Brass	FB31B-12-MD US3	605	-	-	1	-	109.50	-
		FB31B-12-MD US4	606	-	-	1	-	109.50	-
		FB31B12-MD US10	612	-	-	1	-	109.50	-
		FB31B-12-MD US10B	613	-	-	1	-	109.50	-
Stainless	FB31B-12-MD US32	629	-	-	1	-	109.50	-	
	FB31B-12-MD US32D**	630	-	-	1	-	109.50	-	
	FB31B-12-MD BLK	-	-	-	1	-	109.50	-	
COR32* Door Coordinator 32" Channel Length UL Listed *See note at page bottom for door prep charges.	Aluminum	COR32 US28	628	-	-	1	-	162.50	-
		COR32 315AN	711	-	-	1	-	217.00	-
		COR32 US26D	713	-	-	1	-	321.60	-
		COR32 US28w/FL20 **	628	-	-	1	-	178.10	-
COR42* Door Coordinator 42" Channel Length UL Listed *See note at page bottom for door prep charges.	Aluminum	COR42 US28**	628	-	-	1	-	174.90	-
		COR42 315AN	711	-	-	1	-	231.00	-
		COR42 US26D	713	-	-	1	-	341.80	-
		COR42 US28w/FL20**	628	-	-	1	-	190.50	-
		COR42 US28w/FL32	628	-	-	1	-	193.60	-
COR42 US28w/FL44	628	-	-	1	-	198.30	-		

* Special factory preparation for use with vertical rod exit devices available. **List Add \$139.00.**

Lead time exception: ** Products are stocked and will typically ship in 3-5 days

Bold pricing indicates item is in stock and available for Fast Track and ProXpress

HINGES

CONTINUOUS
HINGES

PIVOTS

Numerical
1-059

Numerical
59-437

Numerical
438-1021

Numerical
1152-8190

Numerical
8200-9266

HINGES

CONTINUOUS HINGES

PIVOTS





Numerical
1-059Numerical
59-437Numerical
438-1021Numerical
1152-8190Numerical
8200-9266

MODEL	SUBSTRATE	MODEL NUMBER	BHMA FINISH	WEIGHT	MUST BE ORDERED IN MULTIPLE QTY	MULTIPLE QTY	PACKED PER BOX	LIST PRICE	
								EACH	PACKAGE
COR52* Door Coordinator 52" Channel Length UL Listed <i>*See note at page bottom for door prep charges.</i>	Aluminum	COR52 US28	628	-	-	1	-	\$165.40	-
		COR52 315AN**	711	-	-	1	-	215.00	-
		COR52 US26D**	713	-	-	1	-	339.10	-
		COR52 US28w/FL20**	628	-	-	1	-	181.00	-
		COR52 US28w/FL32**	628	-	-	1	-	184.10	-
		COR52 US28w/FL44	628	-	-	1	-	188.80	-
COR60* Door Coordinator 60" Channel Length UL Listed <i>*See note at page bottom for door prep charges.</i>	Aluminum	COR60 US28**	628	-	-	1	-	193.00	-
		COR60 315AN	711	-	-	1	-	251.30	-
		COR60 US26D	713	-	-	1	-	365.10	-
		COR60 US28w/FL20**	628	-	-	1	-	208.60	-
		COR60 US28w/FL32**	628	-	-	1	-	211.70	-
		COR60 US28w/FL44	628	-	-	1	-	216.40	-
COR72* Door Coordinator 72" Channel Length UL Listed <i>*See note at page bottom for door prep charges.</i>	Aluminum	COR72 US28**	628	-	-	1	-	219.60	-
		COR72 315AN	711	-	-	1	-	302.90	-
		COR72 US26D	713	-	-	1	-	436.80	-
		COR72 US28w/FL20**	628	-	-	1	-	235.20	-
		COR72 US28w/FL32**	628	-	-	1	-	238.30	-
		COR72 US28w/FL44	628	-	-	1	-	243.00	-
FL20 Filler Bar 20" Length	Aluminum	FL20 US28**	628	-	-	1	-	15.60	-
		FL20 315AN**	711	-	-	1	-	50.20	-
		FL20 US26D**	713	-	-	1	-	73.50	-
FL32 Filler Bar 32" Length	Aluminum	FL32 US28**	628	-	-	1	-	18.70	-
		FL32 315AN	711	-	-	1	-	53.10	-
		FL32 US26D	713	-	-	1	-	79.60	-
FL44 Filler Bar 44" Length	Aluminum	FL44 US28	628	-	-	1	-	23.40	-
		FL44 315AN	711	-	-	1	-	57.70	-
		FL44 US26D	713	-	-	1	-	93.60	-
MB1 Mounting Bracket Stop Widths Over 2-1/2"	Aluminum	MB1 USP	600	-	-	1	-	22.40	-
		MB1 SP28**	689	-	-	1	-	31.90	-
		MB1 BLK**	-	-	-	1	-	31.90	-
MB1F & MB1V Mounting Bracket Stop Widths 1-1/2" - 2-1/4"	Steel	MB1F USP	600	-	-	1	-	57.70	-
		MB1F SP28**	689	-	-	1	-	57.70	-
		MB1F BLK	-	-	-	1	-	57.70	-
		MB1V USP	600	-	-	1	-	91.70	-
		MB1V SP28	689	-	-	1	-	91.70	-
		MB1V BLK	-	-	-	1	-	91.70	-
MB2 Mounting Bracket Stop Widths Up to 2-1/2"	Aluminum	MB2 USP	600	-	-	1	-	26.30	-
		MB2 SP28**	689	-	-	1	-	36.10	-
		MB2 BLK**	-	-	-	1	-	36.10	-
MB2F & MB2V Mounting Bracket Stop Widths 2-3/8" - 3-1/4"	Steel	MB2F USP	600	-	-	1	-	57.50	-
		MB2F SP28**	689	-	-	1	-	57.50	-
		MB2F BLK	-	-	-	1	-	57.50	-
		MB2V USP	600	-	-	1	-	91.80	-
		MB2V SP28	689	-	-	1	-	91.80	-
		MB2V BLK	-	-	-	1	-	91.80	-
MB3F & MB3V Mounting Bracket Stop Widths Over 3-3/8"	Steel	MB3F USP	600	-	-	1	-	57.50	-
		MB3F SP28**	689	-	-	1	-	57.50	-
		MB3F BLK	-	-	-	1	-	57.50	-
		MB3V USP	600	-	-	1	-	91.80	-
		MB3V SP28	689	-	-	1	-	91.80	-
		MB3V BLK	-	-	-	1	-	91.80	-

* Special factory preparation for use with vertical rod exit devices available. **List Add \$139.00.**

Lead time exception: ** Products are stocked and will typically ship in 3-5 days

Bold pricing indicates item is in stock and available for Fast Track and ProXpress

MODEL	SUBSTRATE	MODEL NUMBER	BHMA FINISH	WEIGHT	MUST BE ORDERED IN MULTIPLE QTY	MULTIPLE QTY	PACKED PER BOX	LIST PRICE		
								EACH	PACKAGE	
FB32 Automatic Flush Bolts, Metal Doors UL 3 Hour Top Bolt w/Auxiliary Fire Latch 	Brass	FB32-12-MD US3	605	-	-	1	-	\$207.50	-	
		FB32-12-MD US4	606	-	-	1	-	207.50	-	
		FB32-12-MD US10	612	-	-	1	-	207.50	-	
		FB32-12-MD US10B	613	-	-	1	-	207.50	-	
	Stainless	FB32-12-MD US32	629	-	-	1	-	207.50	-	
		FB32-12-MD US32D**	630	-	-	1	-	207.50	-	
FB32-12-MD BLK	-	-	-	-	1	-	207.50	-		
COR32 Door Coordinator	See page 31									
FL32 Filler Bar	See page 32									
RL32 Nylon Roller 		RL32 US3	605	-	-	1	-	104.20	-	
		RL32 US4	606	-	-	1	-	98.40	-	
		RL32 US10	612	-	-	1	-	102.30	-	
		RL32 US10B**	613	-	-	1	-	108.30	-	
		RL32 US15	619	-	-	1	-	104.20	-	
		RL32 US26	625	-	-	1	-	104.20	-	
		RL32 US26D**	626	-	-	1	-	98.40	-	
		RL32 643E/716	-	-	-	-	1	-	108.30	-
		RL32 BLK	-	-	-	-	1	-	104.20	-
RL32A Nylon Roller w/ASA Strike 	Brass	RL32-A US3	605	-	-	1	-	113.40	-	
		RL32-A US4	606	-	-	1	-	107.70	-	
		RL32-A US10	612	-	-	1	-	112.00	-	
		RL32-A US10B	613	-	-	1	-	117.90	-	
		RL32-A US26	625	-	-	1	-	113.40	-	
RL32-A US26D**	626	-	-	1	-	107.70	-			
FB33 Top Auto Flush Bolt w/Auxiliary Fire Latch Retrofit Plate 	Brass	FB33-12-MD US3	605	-	-	1	-	214.30	-	
		FB33-12-MD US4	606	-	-	1	-	214.30	-	
		FB33-12-MD US10	612	-	-	1	-	214.30	-	
		FB33-12-MD US10B	613	-	-	1	-	214.30	-	
	Stainless	FB33-12-MD US32	629	-	-	1	-	214.30	-	
		FB33-12-MD US32D	630	-	-	1	-	214.30	-	
FB33-12-MD BLK	-	-	-	-	1	-	214.30	-		
WS33 Wall Stop For Drywall Mounting	Brass	WS33 US26D**	626	-	-	1	-	56.60	-	
WS33X Wall Stop For Masonary Mounting	Brass	WS33X US26D	626	-	-	1	-	60.30	-	
RL36/36A Roller Latch Mortise	Stainless	RL36 US32D**	630	-	-	1	-	55.50	-	
		RL36-A US32D	630	-	-	1	-	65.20	-	
RL38 Roller Latch Surface Mount	Stainless	RL38 US32D**	630	-	-	1	-	52.40	-	
40 Decorative Light Duty Surface Bolt Packed with Universal and Mortise Strike 	Brass	40B3 3 IN	605	1.9	-	1	10	17.00	-	
		40B5 3 IN	609	1.9	-	1	10	17.00	-	
		40B10B 3 IN	613	1.9	-	1	10	17.80	-	
		40B15 3 IN	619	1.9	-	1	10	17.00	-	
		40B26 3 IN	625	1.9	-	1	10	17.80	-	
		40B26D 3 IN	626	1.9	-	1	10	17.80	-	
		40B643E/716 3 IN	-	1.9	-	1	10	17.80	-	
		40B-BLK 3 IN	622	1.9	-	1	10	17.80	-	
		40B3 4 IN	605	2.4	-	1	10	17.80	-	
		40B5 4 IN	609	2.4	-	1	10	17.90	-	
		40B10B 4 IN	613	2.4	-	1	10	18.70	-	
		40B15 4 IN	619	2.4	-	1	10	17.90	-	
		40B26 4 IN	625	2.4	-	1	10	18.70	-	
		40B26D 4 IN**	626	2.4	-	1	10	18.70	-	
40B643E/716 4 IN	-	2.4	-	1	10	18.70	-			
40B-BLK 4 IN	622	2.4	-	1	10	18.70	-			

Lead time exception: ** Products are stocked and will typically ship in 3-5 days

Bold pricing indicates item is in stock and available for **Fast Track** and **ProXpress**

HINGES

CONTINUOUS HINGES

PIVOTS

Numerical 1-059

Numerical 59-437

Numerical 438-1021

Numerical 1152-8190

Numerical 8200-9266

HINGES

CONTINUOUS HINGES

PIVOTS





Numerical 1-059

Numerical 59-437

Numerical 438-1021





Numerical 1152-8190

Numerical 8200-9266

MODEL	SUBSTRATE	MODEL NUMBER	BHMA FINISH	WEIGHT	MUST BE ORDERED IN MULTIPLE QTY	MULTIPLE QTY	PACKED PER BOX	LIST PRICE	
								EACH	PACKAGE
Continued from previous page. 40 Decorative Light Duty Surface Bolt Packed with Universal and Mortise Strike	Brass	40B3 6 IN	605	3.5	-	1	10	\$21.00	-
		40B5 6 IN	609	3.5	-	1	10	21.00	-
		40B10B 6 IN	613	3.5	-	1	10	21.80	-
		40B15 6 IN	619	3.5	-	1	10	21.00	-
		40B26 6 IN	625	3.5	-	1	10	21.80	-
		40B26D 6 IN	626	3.5	-	1	10	21.80	-
		40B643E/716 6 IN	-	3.5	-	1	10	21.80	-
FS40 Auto Floor Type Holder Floor Clearance 1/2" or less 	Brass	FS40 US3	605	-	-	1	-	89.10	-
		FS40 US4	606	-	-	1	-	66.60	-
		FS40 US10	612	-	-	1	-	89.10	-
		FS40 US10B	613	-	-	1	-	89.10	-
		FS40 US26	625	-	-	1	-	89.10	-
		FS40 US26D**	626	-	-	1	-	66.60	-
WS40 Automatic Wall Stop and Holder 	Brass	WS40 US3	605	-	-	1	-	119.50	-
		WS40 US4	606	-	-	1	-	119.50	-
		WS40 US10	612	-	-	1	-	119.50	-
		WS40 US10B	613	-	-	1	-	119.50	-
		WS40 US26	625	-	-	1	-	119.50	-
		WS40 US26D**	626	-	-	1	-	112.20	-
FB41 Automatic Flush Bolt Wood Door Top and Bottom Bolt UL Listed 90 Minutes P=Pair T=Top Bolt Only B=Bottom Bolt Only 	Brass	FB41P-WD US3	605	-	-	1	-	217.00	-
		FB41P-WD US4	606	-	-	1	-	217.00	-
		FB41P-WD US10	612	-	-	1	-	217.00	-
		FB41P-WD US10B**	613	-	-	1	-	217.00	-
	Stainless	FB41P-WD US32	629	-	-	1	-	217.00	-
		FB41P-WD US32D**	630	-	-	1	-	217.00	-
		FB41P-WD BLK	-	-	-	1	-	217.00	-
	Brass	FB41T-WD US3	605	-	-	1	-	113.50	-
		FB41T-WD US4	606	-	-	1	-	113.50	-
		FB41T-WD US10	612	-	-	1	-	113.50	-
		FB41T-WD US10B	613	-	-	1	-	113.50	-
	Stainless	FB41T-WD US32	629	-	-	1	-	113.50	-
		FB41T-WD US32D**	630	-	-	1	-	113.50	-
		FB41T-WD BLK	-	-	-	1	-	113.50	-
	Brass	FB41B-WD US3	605	-	-	1	-	113.50	-
		FB41B-WD US4	606	-	-	1	-	113.50	-
		FB41B-WD US10	612	-	-	1	-	113.50	-
		FB41B-WD US10B	613	-	-	1	-	113.50	-
Stainless	FB41B-WD US32	629	-	-	1	-	113.50	-	
	FB41B-WD US32D	630	-	-	1	-	113.50	-	
	FB41B-WD BLK	-	-	-	1	-	113.50	-	
FS41 Automatic Floor Type Holder Floor Clearance 9/16" to 1-1/16"	Brass	FS41 US3	605	-	-	1	-	92.70	-
		FS41 US4	606	-	-	1	-	70.50	-
		FS41 US10	612	-	-	1	-	92.70	-
		FS41 US10B	613	-	-	1	-	92.70	-
		FS41 US26	625	-	-	1	-	92.70	-
		FS41 US26D**	626	-	-	1	-	70.50	-
42 Pocket Door Bolt 	Brass	42B3	605	0.9	-	1	10	15.00	-
		42B4	606	0.9	-	1	10	15.00	-
		42B5	609	0.9	-	1	10	16.60	-
		42B10	612	0.9	-	1	10	17.30	-
		42B10B**	613	0.9	-	1	10	17.30	-
		42B15**	619	0.9	-	1	10	16.60	-
		42B26**	625	0.9	-	1	10	17.30	-
		42B26D**	626	0.9	-	1	10	17.30	-
		42B643E/716	-	0.9	-	1	10	17.30	-
42B-BLK	622	0.9	-	1	10	17.30	-		
COR42 Door Coordinator	See page 31								

Lead time exception: ** Products are stocked and will typically ship in 3-5 days

Bold pricing indicates item is in stock and available for Fast Track and ProXpress

MODEL	SUBSTRATE	MODEL NUMBER	BHMA FINISH	WEIGHT	MUST BE ORDERED IN MULTIPLE QTY	MULTIPLE QTY	PACKED PER BOX	LIST PRICE	
								EACH	PACKAGE
FB42 Automatic Flush Bolt Wood Door UL 20 Minutes Top Bolt w/ Auxiliary Fire Latch	Brass	FB42-WD US3	605	-	-	1	-	\$219.00	-
		FB42-WD US4	606	-	-	1	-	219.00	-
		FB42-WD US10	612	-	-	1	-	219.00	-
		FB42-WD US10B	613	-	-	1	-	219.00	-
	Stainless	FB42-WD US32	629	-	-	1	-	219.00	-
		FB42-WD US32D**	630	-	-	1	-	219.00	-
FS42 Automatic Floor Type Holder Floor Clearance 1-1/8" to 1-9/16"	Brass	FS42 US3	605	-	-	1	-	111.60	-
		FS42 US4	606	-	-	1	-	89.10	-
		FS42 US10	612	-	-	1	-	111.60	-
		FS42 US10B	613	-	-	1	-	111.60	-
		FS42 US26	625	-	-	1	-	111.60	-
		FS42 US26D	626	-	-	1	-	89.10	-
FS43 Automatic Floor Type Holder Floor Clearance 1-5/8" to 2-11/16"	Brass	FS43 US3	605	-	-	1	-	122.70	-
		FS43 US4	606	-	-	1	-	100.50	-
		FS43 US10	612	-	-	1	-	122.70	-
		FS43 US10B	613	-	-	1	-	122.70	-
		FS43 US26	625	-	-	1	-	122.70	-
		FS43 US26D**	626	-	-	1	-	100.50	-
FL44 Filler Bar	See page 32								
WS45 Automatic Wall Holder For Drywall Mounting 	Brass	WS45 US3	605	-	-	1	-	160.10	-
		WS45 US4	606	-	-	1	-	160.10	-
		WS45 US10	612	-	-	1	-	160.10	-
		WS45 US10B	613	-	-	1	-	160.10	-
		WS45 US15	619	-	-	1	-	160.10	-
		WS45 US26	625	-	-	1	-	160.10	-
		WS45 US26D**	626	-	-	1	-	156.20	-
		WS45 B643E/716	-	-	-	-	1	-	160.10
	WS45 BLK	622	-	-	1	-	160.10	-	
Aluminum	WS45 US28	628	-	-	1	-	126.00	-	
WS45X Automatic Wall Holder For Masonry Mounting 	Brass	WS45X US3	605	-	-	1	-	169.40	-
		WS45X US4	606	-	-	1	-	169.40	-
		WS45X US10	612	-	-	1	-	169.40	-
		WS45X US10B	613	-	-	1	-	169.40	-
		WS45X US15	619	-	-	1	-	169.40	-
		WS45X US26	625	-	-	1	-	169.40	-
		WS45X US26D	626	-	-	1	-	165.30	-
		WS45X B643E/716	-	-	-	-	1	-	169.40
	WS45X BLK	622	-	-	1	-	169.40	-	
Aluminum	WS45X US28	628	-	-	1	-	135.10	-	
S48 Mortise Bolt 	Brass	S48B3	605	2.6	-	1	10	20.00	-
		S48B5	609	2.6	-	1	10	24.10	-
		S48B10B	613	2.6	-	1	10	23.20	-
		S48B15	619	2.6	-	1	10	22.40	-
		S48B26	625	2.6	-	1	10	23.20	-
		S48B26D	626	2.6	-	1	10	23.20	-
S48 Strike Package	09-40-605		605	-	-	1	-	5.70	-
	09-40-613		613	-	-	1	-	5.70	-
	09-40-626		626	-	-	1	-	5.70	-
FB51 UL 3 Hour Constant Latching Top and Automatic Bottom Bolt, Metal Door P=Pair T=Top Bolt Only B=Bottom Bolt Only Optional Rod Lengths Available 18", 24", 36", 48" 12.60 List Add 	Brass	FB51P-12-MD US3	605	-	-	1	-	207.50	-
		FB51P-12-MD US4	606	-	-	1	-	207.50	-
		FB51P-12-MD US10	612	-	-	1	-	207.50	-
		FB51P-12-MD US10B**	613	-	-	1	-	207.50	-
	Stainless	FB51P-12-MD US32	629	-	-	1	-	207.50	-
		FB51P-12-MD US32D**	630	-	-	1	-	207.50	-
		FB51P-12-MD BLK	-	-	-	1	-	207.50	-
	Brass	FB51T-12-MD US3	605	-	-	1	-	108.30	-
		FB51T-12-MD US4	606	-	-	1	-	108.30	-
		FB51T-12-MD US10	612	-	-	1	-	108.30	-
		FB51T-12-MD US10B	613	-	-	1	-	108.30	-
	Stainless	FB51T-12-MD US32	629	-	-	1	-	108.30	-
FB51T-12-MD US32D**		630	-	-	1	-	108.30	-	
FB51T-12-MD BLK	-	-	-	1	-	108.30	-		
COR52 Door Coordinator	See page 32								

Lead time exception: ** Products are stocked and will typically ship in 3-5 days

Bold pricing indicates item is in stock and available for **Fast Track** and **ProXpress**

HINGES

CONTINUOUS HINGES

PIVOTS

Numerical 1-059



Numerical 59-437

Numerical 438-1021

Numerical 1152-8190



Numerical 8200-9266

HINGES
 CONTINUOUS HINGES
 PIVOTS
 Numerical 1-059
 Numerical 59-437
 Numerical 438-1021
 Numerical 1152-8190
 Numerical 8200-9266

MODEL	SUBSTRATE	MODEL NUMBER	BHMA FINISH	WEIGHT	MUST BE ORDERED IN MULTIPLE QTY	MULTIPLE QTY	PACKED PER BOX	LIST PRICE	
								EACH	PACKAGE
FB52 Flush Bolt UL 3 Hour Constant Latching Top w/ Auxiliary Fire Latch	Brass	FB52-12-MD US3	605	-	-	1	-	207.50	-
		FB52-12-MD US4	606	-	-	1	-	207.50	-
		FB52-12-MD US10	612	-	-	1	-	207.50	-
		FB52-12-MD US10B	613	-	-	1	-	207.50	-
	Stainless	FB52-12-MD US32	629	-	-	1	-	207.50	-
		FB52-12-MD US32D**	630	-	-	1	-	207.50	-
		FB52-12-MD BLK	-	-	-	1	-	207.50	-
FB53 UL 3 Hour Constant Latching Top w/ Auxiliary Fire Latch and Retrofit Plate	Brass	FB53-12-MD US3	605	-	-	1	-	214.30	-
		FB53-12-MD US4	606	-	-	1	-	214.30	-
		FB53-12-MD US10	612	-	-	1	-	214.30	-
		FB53-12-MD US10B	613	-	-	1	-	214.30	-
	Stainless	FB53-12-MD US32	629	-	-	1	-	214.30	-
		FB53-12-MD US32D	630	-	-	1	-	214.30	-
		FB53-12-MD BLK	-	-	-	1	-	214.30	-
054 Dutch Door Bolt 	Brass	054B3	605	2.3	-	1	5	49.20	-
		054B4	606	2.3	-	1	5	49.20	-
		054B10	612	2.3	-	1	5	44.80	-
		054B10B**	613	2.3	-	1	5	53.90	-
		054B15	619	2.3	-	1	5	55.90	-
		054B26	625	2.3	-	1	5	53.90	-
		054B26D**	626	2.3	-	1	5	49.20	-
059 Handrail Bracket 	Aluminum	059A3**	666	3.2	-	1	20	3.90	-
		059A5**	-	3.2	-	1	20	3.90	-
		059A10	668	3.2	-	1	20	3.90	-
		059A10B**	703	3.2	-	1	20	3.90	-
		059A14	669	3.2	-	1	20	3.90	-
		059A15**	670	3.2	-	1	20	3.90	-
		059A26	672	3.2	-	1	20	3.90	-
		059A26D	702	3.2	-	1	20	3.90	-
		059A92**	673	3.2	-	1	20	3.90	-
		059A-643E/716**	-	3.2	-	1	20	3.90	-
		059A-BLK**	-	3.3	-	1	20	5.20	-
		059A-W	-	3.3	-	1	20	5.20	-
		SP059A3	666	68.0	Yes	20	20	-	79.80
		SP059A5	-	68.0	Yes	20	20	-	79.80
	SP059A14	669	68.0	Yes	20	20	-	79.80	
	SP059A92	673	68.0	Yes	20	20	-	79.80	
	Brass	059B3	605	3.2	-	1	10	22.70	-
		059B5	609	3.2	-	1	10	31.40	-
		059B10B	613	3.2	-	1	10	25.90	-
		059B15	619	3.2	-	1	10	25.90	-
059B15A		620	3.2	-	1	10	25.90	-	
059B26		625	3.2	-	1	10	31.40	-	
059B26D		626	3.2	-	1	10	31.40	-	
059B-643E/716		-	3.2	-	1	10	25.90	-	
059B-BLK		622	3.2	-	1	10	25.90	-	
SP059B10B		613	37.0	Yes	10	10	-	267.20	
SP059B26	625	37.0	Yes	10	10	-	319.60		
Zinc	059Z-619E	-	-	-	1	20	6.00	-	

Lead time exception: ** Products are stocked and will typically ship in 3-5 days

Bold pricing indicates item is in stock and available for **Fast Track** and **ProXpress**

MODEL	SUBSTRATE	MODEL NUMBER	BHMA FINISH	WEIGHT	MUST BE ORDERED IN MULTIPLE QTY	MULTIPLE QTY	PACKED PER BOX	LIST PRICE	
								EACH	PACKAGE
59 Handrail Bracket 	Aluminum	59A3**	666	1.6	-	1	10	4.00	-
		59A5	-	2.1	-	1	10	5.10	-
		59A10B**	703	3.2	-	1	10	7.00	-
		59A14	669	2.1	-	1	10	5.10	-
		59A15**	670	2.0	-	1	10	5.10	-
		59A92**	673	3.2	-	1	10	4.00	-
		59A-643E/716**	-	2.0	-	1	10	5.10	-
		SP59A3	666	45.0	Yes	15	15	-	61.95
		SP59A5	-	45.0	Yes	15	15	-	75.30
		SP59A14	669	45.0	Yes	15	15	-	75.30
	SP59A92	673	45.0	Yes	15	15	-	61.95	
	Brass	59B3	605	3.8	-	1	10	23.90	-
		59B5	609	3.8	-	1	10	27.40	-
		59B15	619	3.8	-	1	10	27.40	-
		59B26	625	3.8	-	1	10	27.40	-
		59B26D	626	3.8	-	1	10	27.40	-
59B-643E/716		-	3.8	-	1	10	27.40	-	
SP59B3		605	41.0	Yes	10	10	-	238.30	
060 Flexible Door Stop 3" Projection 		Steel	060F3	632	1.1	-	1	20	1.30
	060F5		638	1.1	-	1	20	1.30	-
	060F10		639	1.1	-	1	20	1.30	-
	060F10B**		640	1.1	-	1	20	1.30	-
	060F14**		645	1.1	-	1	20	1.30	-
	060F15**		646	1.1	-	1	20	1.30	-
	060F26		651	1.1	-	1	20	1.30	-
	060F26D**		652	1.1	-	1	20	1.30	-
	060F-643E/716		-	1.1	-	1	20	1.30	-
	060F-BLK		-	1.1	-	1	20	1.30	-
	SPO60F3		632	145.0	Yes	50	50	-	63.50
	SPO60F5		638	145.0	Yes	50	50	-	63.50
	SPO60F10B		640	145.0	Yes	50	50	-	63.50
	SPO60F14		645	145.0	Yes	50	50	-	63.50
	SRT (WSPART.1076)		9	-	Yes	100	100	-	42.30
	60 Door Stop 3-3/4" Projection 		Aluminum	60A3	666	1.5	-	1	20
60A10B		703		1.5	-	1	20	5.20	-
60A14		669		1.5	-	1	20	3.70	-
60A15		670		1.5	-	1	20	3.70	-
60A26		672		1.5	-	1	20	3.70	-
60A26D		702		1.5	-	1	20	3.70	-
60A92**		673		1.5	-	1	20	3.70	-
60A-643E/716		-		1.5	-	1	20	5.20	-
60A-BLK		-		1.5	-	1	20	3.70	-
Brass		60B3		605	1.9	-	1	10	13.60
		60B4	606	1.9	-	1	10	13.60	-
		60B5	609	1.9	-	1	10	13.60	-
		60B10	612	1.9	-	1	10	17.80	-
		60B10B	613	1.9	-	1	10	17.80	-
		60B15	619	1.9	-	1	10	17.80	-
		60B26	625	1.9	-	1	10	17.80	-
	60B26D	626	1.9	-	1	10	17.80	-	
60B-643E/716	-	1.9	-	1	10	17.80	-		
60B-BLK	622	1.9	-	1	10	17.80	-		
60 Rubber Tips		RT (WSPART.1075)	-	-	Yes	100	100	-	90.60
COR60 Door Coordinator	See page 32								

HINGES

CONTINUOUS HINGES

PIVOTS

Numerical 1-059

Numerical 59-437

Numerical 438-1021



Numerical 1152-8190

Numerical 8200-9266

Lead time exception: ** Products are stocked and will typically ship in 3-5 days







Bold pricing indicates item is in stock and available for **Fast Track** and **ProXpress**

HINGES
CONTINUOUS HINGES
PIVOTS
Numerical 1-059
Numerical 59-437
Numerical 438-1021
Numerical 1152-8190
Numerical 8200-9266

MODEL	SUBSTRATE	MODEL NUMBER	BHMA FINISH	WEIGHT	MUST BE ORDERED IN MULTIPLE QTY	MULTIPLE QTY	PACKED PER BOX	LIST PRICE	
								EACH	PACKAGE
061 Flexible Door Stop 4" Projection 	Steel	061F3	632	1.4	-	1	20	\$1.40	-
		061F5	638	1.4	-	1	20	1.40	-
		061F10	639	1.4	-	1	20	1.40	-
		061F10B	640	1.4	-	1	20	1.40	-
		061F14	645	1.4	-	1	20	1.40	-
		061F15	646	1.4	-	1	20	1.40	-
		061F26	651	1.4	-	1	20	1.40	-
		061F26D**	652	1.4	-	1	20	1.40	-
		061F-643E/716	-	1.4	-	1	20	1.40	-
		061F-BLK	-	1.4	-	1	20	1.40	-
		061F-W	-	1.4	-	1	20	1.40	-
		SP061F3	632	47.5	Yes	25	25	-	35.00
		SP061F5	638	47.5	Yes	25	25	-	35.00
SP061F14	645	47.5	Yes	25	25	-	35.00		
Rubber Tip - Flexible Stops	Rubber	SRT (WSPART.1076)	-	-	Yes	100	100	-	42.30
61 Solid Door Stop 3-3/16" Projection  *Provided with Black Rubber Tip	Aluminum	61A3**	666	1.2	-	1	20	3.70	-
		61A5	-	1.2	-	1	20	3.70	-
		61A10	668	1.2	-	1	20	3.70	-
		61A10B**	703	1.2	-	1	20	3.70	-
		61A14**	669	1.2	-	1	20	3.70	-
		61A15**	670	1.2	-	1	20	3.70	-
		61A26	672	1.2	-	1	20	3.70	-
		61A26D	702	1.2	-	1	20	3.70	-
		61A92**	673	1.2	-	1	20	3.70	-
		*61A 643E/716**	-	1.2	-	1	20	3.70	-
		61A-BLK**	-	1.3	-	1	20	4.10	-
		61A-W**	-	1.3	-	1	20	4.10	-
		SP61A10B	703	42.5	Yes	25	25	-	99.25
		SP61A3	666	42.5	Yes	25	25	-	99.25
		SP61A5	-	42.5	Yes	25	25	-	99.25
		SP61A14	669	42.5	Yes	25	25	-	99.25
		SP61A92	673	42.5	Yes	25	25	-	99.25
		SP61A-BLK	-	20.0	Yes	10	10	-	42.20
SP61A-W	-	50.0	Yes	25	25	-	105.50		
61 Solid Door Stop 3-1/8" Projection 	Brass	61B3	605	1.4	-	1	10	13.60	-
		61B4	606	1.4	-	1	10	13.60	-
		61B5**	609	1.4	-	1	10	13.60	-
		61B10	612	1.4	-	1	10	17.80	-
		61B10B**	613	1.4	-	1	10	17.80	-
		61B15**	619	1.4	-	1	10	17.80	-
		61B15A	620	1.4	-	1	10	17.80	-
		61B26**	625	1.4	-	1	10	17.80	-
		61B26D**	626	1.4	-	1	10	13.60	-
		61B-643E/716	-	1.4	-	1	10	17.80	-
		61B-BLK	622	1.4	-	1	10	17.80	-
		SP61B 10B	613	-	Yes	10	10	-	184.00
		SP61B26 (WS.10347)	625	-	Yes	10	10	-	184.00

Lead time exception: ** Products are stocked and will typically ship in 3-5 days

Bold pricing indicates item is in stock and available for **Fast Track** and **ProXpress**

MODEL	SUBSTRATE	MODEL NUMBER	BHMA FINISH	WEIGHT	MUST BE ORDERED IN MULTIPLE QTY	MULTIPLE QTY	PACKED PER BOX	LIST PRICE		
								EACH	PACKAGE	
61 Solid Door Stop 3-3/16" Projection <i>Continued from previous page</i>	Zinc	61Z-619E	-	4.1	-	1	20	\$3.50	-	
		61Z-643E/716**	-	-	-	1	20	4.60	-	
61 Rubber Tips		RT (WSPART.1075)	-	-	Yes	100	100	-	90.60	
FB61 Flush Bolt for Wood Door UL 90 Minute Constant Latching Top and Automatic Bottom Bolt P=Pair (Top half w/automatic bottom bolt) T=Top Bolt Only 	Brass	FB61P-WD US3	605	-	-	1	-	219.00	-	
		FB61P-WD US4	606	-	-	1	-	219.00	-	
		FB61P-WD US10	612	-	-	1	-	219.00	-	
		FB61P-WD US10B	613	-	-	1	-	219.00	-	
	Stainless	FB61P-WD US32	629	-	-	1	-	219.00	-	
		FB61P-WD US32D**	630	-	-	1	-	219.00	-	
		FB61P-WD BLK	-	-	-	1	-	219.00	-	
	Brass	FB61T-WD US3	605	-	-	1	-	113.50	-	
		FB61T-WD US4	606	-	-	1	-	113.50	-	
		FB61T-WD US10	612	-	-	1	-	113.50	-	
		FB61T-WD US10B	613	-	-	1	-	113.50	-	
	Stainless	FB61T-WD US32	629	-	-	1	-	113.50	-	
		FB61T-WD US32D**	630	-	-	1	-	113.50	-	
		FB61T-WD BLK	-	-	-	1	-	113.50	-	
FB62 Flush Bolt for Wood Door UL 20 Minute Constant Latching Top w/Auxiliary Fire Latch	Brass	FB62-WD US3	605	-	-	1	-	219.00	-	
		FB62-WD US4	606	-	-	1	-	219.00	-	
		FB62-WD US10	612	-	-	1	-	219.00	-	
		FB62-WD US10B	613	-	-	1	-	219.00	-	
	Stainless	FB62-WD US32	629	-	-	1	-	219.00	-	
		FB62-WD US32D	630	-	-	1	-	219.00	-	
		FB62-WD BLK	-	-	1	-	219.00	-		
63 Flexible Door Stop 	Steel	63F-605E	632	2.7	-	1	20	1.20	-	
		63F-609E	638	2.7	-	1	20	1.20	-	
		63F-619E**	646	1.8	-	1	20	1.20	-	
		63F-625E	-	1.8	-	1	20	1.20	-	
		63F-626E	-	1.8	-	1	20	1.20	-	
		63F-643E/716**	-	1.8	-	1	20	1.20	-	
		63F-BLK	-	1.8	-	1	20	1.20	-	
		63F-W**	-	1.8	-	1	20	1.20	-	
				RT (WSPART.1075)	-	-	Yes	100	100	-
64 Door Stop 3-1/4" Projection 	Aluminum	64A3	666	2.3	-	1	20	3.20	-	
		64A10B	703	2.3	-	1	20	3.20	-	
		64A92	673	2.3	-	1	20	3.20	-	
	Brass	64B3	605	-	-	1	10	12.10	-	
		64B4	606	-	-	1	10	13.30	-	
		64B5	609	2.1	-	1	10	15.60	-	
		64B10	612	2.3	-	1	10	15.60	-	
		64B10B	613	2.3	-	1	10	15.60	-	
		64B15	619	2.3	-	1	10	15.60	-	
		64B26	625	2.3	-	1	10	15.60	-	
		64B26D	626	2.3	-	1	10	15.60	-	
		64B-643E/716	-	2.3	-	1	10	15.60	-	
		64B-BLK	622	2.3	-	1	10	15.60	-	
				RT (WSPART.1075)	-	-	Yes	100	100	-
SR64 Door Silencer - Hollow Metal 		SR64 GRY (100/pk)**	-	2.1	-	1	100	35.40	-	
		SR64 GRY - BULK (2500/pk)	-	-	-	1	2,500	537.10	-	
WS65 Wall Stop 	Aluminum	WS65 US3AL	666	2.8	-	1	20	5.10	-	
		WS65 US10AL	668	2.1	-	1	20	5.10	-	
		WS65 US10B-AL	703	2.8	-	1	20	5.10	-	
		WS65 US27**	673	-	-	1	20	5.10	-	
		SPWS65 US3AL	666	-	-	Yes	25	25	-	126.00
		SPWS65 US27	673	-	-	Yes	25	25	-	126.00
WS65 Rubber Tips		RT (WSPART.1075)	-	-	Yes	100	100	-	90.60	
SR65 Door Silencer - Wood 		SR65 GRY (100/pk)**	-	-	-	1	100	35.40	-	
SR66 Door Silencer - Adhesive 		SR66 BRN (100/pk)	-	-	-	1	100	35.40	-	
		SR66 GRY (100/pk)**	-	-	-	1	100	35.40	-	
		SR66 WHT (100/pk)	-	-	-	1	100	35.40	-	

Lead time exception: ** Products are stocked and will typically ship in 3-5 days

Bold pricing indicates item is in stock and available for **Fast Track** and **ProXpress**

HINGES
 CONTINUOUS HINGES
 PIVOTS
 Numerical 1-059
 Numerical 59-437
 Numerical 438-1021
 Numerical 1152-8190
 Numerical 8200-9266

HINGES

CONTINUOUS HINGES

PIVOTS





Numerical 1-059

Numerical 59-437

Numerical 438-1021







Numerical 1152-8190

Numerical 8200-9266

MODEL	SUBSTRATE	MODEL NUMBER	BHMA FINISH	WEIGHT	MUST BE ORDERED IN MULTIPLE QTY	MULTIPLE QTY	PACKED PER BOX	LIST PRICE	
								EACH	PACKAGE
066 Casement Fastener 	Aluminum	066A3 RS MS SS	666	-	-	1	10	\$6.70	-
		066A5 RS MS SS	-	-	-	1	10	6.70	-
		066A10B RS MS SS	703	-	-	1	10	6.70	-
		066A14 RS MS SS	669	-	-	1	10	6.70	-
		066A92 RS MS SS	673	-	-	1	10	6.70	-
	Brass	066B3 RS MS SS	605	-	-	1	10	29.70	-
		066B5 RS MS SS	609	-	-	1	10	35.70	-
		066B15 RS MS SS	619	-	-	1	10	37.10	-
		066B26 RS MS SS	625	-	-	1	10	35.70	-
		066B26D RS MS SS	626	-	-	1	10	35.70	-
66 Casement Fastener 	Aluminum	66A3 RS MS SS	666	-	-	1	10	7.80	-
		66A5 RS MS SS	-	-	-	1	10	7.80	-
		66A14 RS MS SS	669	-	-	1	10	7.80	-
		66A92 RS MS SS	673	-	-	1	10	7.80	-
	Brass	66B3 RS MS SS	605	-	-	1	10	36.30	-
		66B5 RS MS SS	609	-	-	1	10	36.30	-
		66B15 RS MS SS	619	-	-	1	10	36.30	-
		66B26 RS MS SS	625	-	-	1	10	36.30	-
		66B26D RS MS SS	626	-	-	1	10	36.30	-
		66B643E/716 RS MS SS	-	-	-	1	10	36.30	-
69 Hinge Pin Door Stop Door Opening Adjustments 70° - 100° 	Steel	69F3	632	2.6	-	1	20	4.80	-
		69F5	638	2.6	-	1	20	4.80	-
		69F10	639	2.6	-	1	20	4.80	-
		69F10B**	640	2.6	-	1	20	4.80	-
		69F14**	645	2.6	-	1	20	4.80	-
		69F15**	646	2.6	-	1	20	4.80	-
		69F15A	647	2.6	-	1	20	4.80	-
		69F26	651	2.6	-	1	20	4.80	-
		69F26D**	652	2.6	-	1	20	4.80	-
		69F-643E/716	-	2.6	-	1	20	4.80	-
		69F-BLK	-	2.6	-	1	20	4.80	-
		SP69F3	632	82.5	Yes	25	25	-	118.25
		SP69F5	635	82.5	Yes	25	25	-	118.25
		SP69F14	645	82.5	Yes	25	25	-	118.25
		69 Rubber Tip		09-310	-	-	Yes	100	100
70 Hinge Pin Door Stop Door Opening Adjustments 85° - 125°  *Provided with Black Rubber Tip Picture above for Brass and Zinc Substrates  Picture above for Aluminum Substrates <i>Continued on next page.</i>	Aluminum	70A3**	666	1.3	-	1	20	2.50	-
		70A4	667	1.3	-	1	20	2.50	-
		70A5**	-	1.3	-	1	20	2.90	-
		70A10	668	1.3	-	1	20	2.50	-
		70A10B**	703	1.3	-	1	20	2.90	-
		70A14**	669	1.3	-	1	20	2.90	-
		70A15**	670	1.3	-	1	20	2.90	-
		70A26	672	1.3	-	1	20	2.50	-
		70A26D	702	1.3	-	1	20	2.50	-
		70A92**	673	1.3	-	1	20	2.50	-
		*70A 643E/716**	-	1.3	-	1	20	2.90	-
		70A-BLK**	-	1.4	-	1	20	3.50	-
		70A-W**	-	1.4	-	1	20	3.50	-
		SP70A3	666	55.0	Yes	25	25	-	64.25
	SP70A5	-	55.0	Yes	25	25	-	73.50	
	SP70A10	668	55.0	Yes	25	25	-	64.25	
	SP70A92	673	55.0	Yes	25	25	-	64.25	
	Brass	70B3	605	1.4	-	1	10	12.50	-
		70B4	606	1.4	-	1	10	12.50	-
70B5		609	1.4	-	1	10	15.80	-	
70B10		612	1.4	-	1	10	15.80	-	
70B10B**		613	1.4	-	1	10	15.80	-	
70B15**		619	1.4	-	1	10	15.80	-	
70B26		625	1.4	-	1	10	15.80	-	
70B26D**	626	1.4	-	1	10	15.80	-		
		70B643E/716	-	1.4	-	1	10	15.80	-
		70B-BLK	622	1.4	-	1	10	15.80	-

Lead time exception: ** Products are stocked and will typically ship in 3-5 days

Bold pricing indicates item is in stock and available for **Fast Track** and **ProXpress**

MODEL	SUBSTRATE	MODEL NUMBER	BHMA FINISH	WEIGHT	MUST BE ORDERED IN MULTIPLE QTY	MULTIPLE QTY	PACKED PER BOX	LIST PRICE	
								EACH	PACKAGE
70 Hinge Pin Door Stop Door Opening Adjustments 85° - 125°  <i>Continued from previous page.</i>	Zinc	70Z-406E	-	-	-	1	10	\$3.50	-
		70Z-643E/716	-	-	-	1	20	3.50	-
70 Rubber Tips		RT (WSPART.1075)	-	-	Yes	100	100	-	90.60
71 Casement Adjuster 	Brass	71B3 10 IN	605	1.7	-	1	2	71.30	-
		71B3 12 IN	605	1.9	-	1	2	77.50	-
		71B26 10 IN	625	1.7	-	1	2	71.30	-
		71B26 12 IN	625	1.9	-	1	2	77.50	-
72 Door Saver Residential 	Zinc	72Z-605E	677	-	-	1	50	2.90	-
		72Z-609E	-	-	-	1	50	2.90	-
		72Z-613E	704	-	-	1	50	2.90	-
		72Z-619E **	-	-	-	1	50	2.90	-
		72Z-625E	681	-	-	1	50	2.90	-
		72Z-626E	682	-	-	1	50	2.90	-
		72Z-643E/716	-	-	-	1	50	2.90	-
		72Z-BLK	676	-	-	1	50	2.90	-
72Z-W	-	-	-	1	50	2.90	-		
72 Rubber Tips		RT (WSPART.1075)	-	-	Yes	100	100	-	90.60
COR72 Door Coordinator	See page 32								
73 Door Saver Residential 	Zinc	73Z-605E	677	-	-	1	25	5.70	-
		73Z-613E	704	-	-	1	25	5.70	-
		73Z-619E	-	-	-	1	25	5.70	-
		73Z-625E	681	-	-	1	25	5.70	-
73 Rubber Tips		RT (WSPART.1075)	-	-	Yes	100	100	-	90.60
90 Side Window Lock 	Aluminum	SP90A3	666	45.0	Yes	25	25	-	115.00
CS115 Crash Stop 	Steel	CS115 US10B 20 1/2 IN	613	5.0	-	1	5	52.50	-
		CS115 US10B 25 1/2 IN	613	5.5	-	1	5	56.00	-
		CS115 US10B 30 1/2 IN	613	6.0	-	1	5	62.10	-
		CS115 US26D 20 1/2 IN**	626	5.0	-	1	5	52.50	-
		CS115 US26D 25 1/2 IN**	626	5.5	-	1	5	56.00	-
CS115 US26D 30 1/2 IN**	626	6.0	-	1	5	62.10	-		
HB159 Handrail Bracket 	Aluminum	HB159 US3AL	666	3.8	-	1	5	17.90	-
		HB159 US27	673	3.8	-	1	5	17.90	-

HINGES
 CONTINUOUS HINGES
 PIVOTS
 Numerical 1-059
 Numerical 59-437
 Numerical 438-1021
 Numerical 1152-8190
 Numerical 8200-9266

Lead time exception: ** Products are stocked and will typically ship in 3-5 days







Bold pricing indicates item is in stock and available for **Fast Track** and **ProXpress**

HINGES

CONTINUOUS HINGES

PIVOTS





Numerical
1-059Numerical
59-437Numerical
438-1021Numerical
1152-8190Numerical
8200-9266

MODEL	SUBSTRATE	MODEL NUMBER	BHMA FINISH	WEIGHT	MUST BE ORDERED IN MULTIPLE QTY	MULTIPLE QTY	PACKED PER BOX	LIST PRICE	
								EACH	PACKAGE
218* Finger Pull 1" Diameter 	Brass	218B3	605	1.6	Yes	4	40	-	\$11.10
		218B5	609	1.6	Yes	4	40	-	21.20
		218B10	612	1.6	Yes	4	40	-	21.20
		218B10B	613	1.6	Yes	4	40	-	21.20
		218B15	619	1.6	Yes	4	40	-	11.10
		218B26	625	1.6	Yes	4	40	-	15.00
		218B26D	626	1.6	Yes	4	40	-	15.00
		218B-643E/716	-	1.6	Yes	4	40	-	15.00
218B-BLK	622	1.6	Yes	4	40	-	15.00		
221 Flush Pull 2-1/8" Diameter 	Brass	221B3	605	1.0	-	1	20	4.00	
		221B4	606	1.0	-	1	20	4.00	
		221B5	609	1.0	-	1	20	4.00	
		221B10	612	1.0	-	1	20	5.50	
		221B10B**	613	1.0	-	1	20	4.80	
		221B15**	619	1.0	-	1	20	4.60	
		221B26**	625	1.0	-	1	20	4.80	
		221B26D**	626	1.0	-	1	20	4.80	
221B-643E/716	716	1.0	-	1	20	4.80			
221B-BLK	622	1	-	1	20	4.80			
222 Flush Pull 3-1/8" High x 1-5/8" Wide x 7/16" 	Brass	222B3	605	1.5	-	1	10	23.40	-
		222B4	606	1.5	-	1	10	23.40	-
		222B5	609	1.5	-	1	10	26.80	-
		222B10	612	1.5	-	1	10	26.80	-
		222B10B**	613	1.5	-	1	10	26.80	-
		222B15**	619	1.5	-	1	10	25.90	-
		222B26	625	1.5	-	1	10	26.80	-
		222B26D**	626	1.5	-	1	10	26.80	-
222B-643E/716	-	1.5	-	1	10	26.80	-		
222B-BLK	622	1.5	-	1	10	26.80	-		
223 Flush Pull 3-9/16" High x 1-5/16" Wide x 1/2" Deep 	Brass	223B3	605	0.7	-	1	10	7.20	-
		223B4	606	0.7	-	1	10	7.20	-
		223B10	612	0.7	-	1	10	8.10	-
		223B10B**	613	0.7	-	1	10	8.10	-
		223B15**	619	0.7	-	1	10	7.70	-
		223B26	625	0.7	-	1	10	8.10	-
		223B26D	626	0.7	-	1	10	8.10	-
		223B-643E/716	-	0.7	-	1	10	8.10	-
223B-BLK	622	0.7	-	1	10	8.10	-		
227 Flush Pull 3-5/8" High x 1-3/4" Wide x 9/16" Deep 	Brass	227B3	605	1.0	-	1	10	10.70	-
		227B4	606	1.0	-	1	10	10.70	-
		227B5	609	1.0	-	1	10	11.90	-
		227B10	612	1.0	-	1	10	12.40	-
		227B10B**	613	1.0	-	1	10	12.40	-
		227B15**	619	1.0	-	1	10	11.90	-
		227B26	625	1.0	-	1	10	12.40	-
		227B26D**	626	1.0	-	1	10	12.40	-
227B-643E/716	-	1	-	1	10	12.40	-		
227B-BLK	622	1	-	1	10	12.40	-		
230 Door Edge Pull 	Brass	230B3	605	1.3	-	1	10	15.20	-
		230B4	606	1.3	-	1	10	15.20	-
		230B5	609	1.3	-	1	10	16.60	-
		230B10	612	1.3	-	1	10	15.20	-
		230B10B**	613	1.3	-	1	10	17.40	-
		230B15**	619	1.3	-	1	10	16.60	-
		230B26**	625	1.3	-	1	10	17.40	-
		230B26D**	626	1.3	-	1	10	17.40	-
230B-643E/716	-	1.3	-	1	10	17.40	-		
230B-BLK	622	1.3	-	1	10	17.40	-		

* NOTE: 218 Finger Pull priced at 4 per bag. Qty of 10 = 40 pieces.

Lead time exception: ** Products are stocked and will typically ship in 3-5 days

Bold pricing indicates item is in stock and available for **Fast Track** and **ProXpress**

MODEL	SUBSTRATE	MODEL NUMBER	BHMA FINISH	WEIGHT	MUST BE ORDERED IN MULTIPLE QTY	MULTIPLE QTY	PACKED PER BOX	LIST PRICE		
								EACH	PACKAGE	
253 Decorative Heavy Duty Surface Bolt 	Brass	253B3 8 IN US MS	605	-	-	1	5	70.20	-	
		253B10B 8 IN US MS	613	-	-	1	5	80.80	-	
		253B26D 8 IN US MS	626	-	-	1	5	80.80	-	
		253B3 12 IN US MS	605	-	-	1	5	92.30	-	
		253B10B 12 IN US MS	613	-	-	1	5	98.70	-	
		253B26D 12 IN US MS	626	-	-	1	5	98.70	-	
253 Mortise Strike Package	Brass	09-22-605	605	-	-	1	1	9.30	-	
		09-22-613	613	-	-	1	1	9.30	-	
		09-22-626	626	-	-	1	1	9.30	-	
253 Angle Strike Package	Brass	09-33-605	605	-	-	1	1	20.80	-	
		09-33-613	613	-	-	1	1	20.80	-	
		09-33-626	626	-	-	1	1	20.80	-	
261 Manual Flush Bolt 	Brass	261B3	605	2.4	-	1	10	21.40	-	
		261B5	609	2.4	-	1	10	23.50	-	
		261B10B	613	2.4	-	1	10	27.00	-	
		261B15	619	2.4	-	1	10	24.50	-	
		261B26	625	2.4	-	1	10	24.50	-	
		261B26D	626	2.4	-	1	10	24.50	-	
		SP261B3	605	3.8	-	Yes	15	15	-	\$322.80
		SP261B15	619	0.0	-	Yes	15	15	-	367.50
262 Manual Flush Bolt 	Brass	262B3	605	3.6	-	1	10	31.40	-	
		262B5	609	3.6	-	1	10	34.60	-	
		262B10B	613	3.6	-	1	10	36.10	-	
		262B15	619	3.6	-	1	10	36.10	-	
		262B26	625	3.6	-	1	10	36.10	-	
		262B26D**	626	3.6	-	1	10	36.10	-	
262 Strike Package		09-40-605	605	-	-	1	1	5.70	-	
		09-40-613	613	-	-	1	1	5.70	-	
		09-40-626	626	-	-	1	1	5.70	-	
265 Manual Flush Bolt 	Brass	265B3	605	2.1	-	1	10	24.40	-	
		265B5	609	2.1	-	1	10	26.80	-	
		265B10B	613	2.1	-	1	10	28.20	-	
		265B15	619	2.1	-	1	10	28.20	-	
		265B26	625	2.1	-	1	10	28.20	-	
		265B26D	626	2.1	-	1	10	28.20	-	
265 Strike Package		09-40-605	605	-	-	1	1	5.70	-	
		09-40-613	613	-	-	1	1	5.70	-	
		09-40-626	626	-	-	1	1	5.70	-	
299 Center Rescue Strike All Strikes Double Lip. Must be used with Center Hung Pivots. Strike Dimension Options: 7" Stk = 5 3/4" x 2 3/4" Frame 8" Stk = 6 3/4" x 2 3/4" Frame		299RS-7	630	-	-	1	-	55.00	-	
		299RS-8	630	-	-	1	-	55.00	-	
299 Offset Rescue Strike All Strikes Double Lip. Must be used with Center Hung Pivots. Strike Dimension Options: 7" Stk = 5 3/4" x 2 3/4" Frame 8" Stk = 6 3/4" x 2 3/4" Frame		299RB-7	630	-	-	1	-	55.00	-	
		299RB-8	630	-	-	1	-	55.00	-	
299 Rescue Emergency Stop (Stop Assembly Only)		299AL	630	-	-	1	-	116.50	-	
299 Rescue Center Emergency Stop Strike (Part) All Strikes Double Lip. Must be used with Center Hung Pivots. Strike Dimension Options: 7" Stk = 5 3/4" x 2 3/4" Frame 8" Stk = 6 3/4" x 2 3/4" Frame		299ES-7	630	-	-	1	-	73.30	-	
		299ES-8	630	-	-	1	-	73.30	-	

Lead time exception: ** Products are stocked and will typically ship in 3-5 days

Bold pricing indicates item is in stock and available for **Fast Track** and **ProXpress**







HINGES
 CONTINUOUS HINGES
 PIVOTS
 Numerical 1-059
 Numerical 59-437
 Numerical 438-1021
 Numerical 1152-8190
 Numerical 8200-9266

HINGES
 CONTINUOUS HINGES
 PIVOTS
 Numerical 1-059
 Numerical 59-437
 Numerical 438-1021
 Numerical 1152-8190
 Numerical 8200-9266

MODEL	SUBSTRATE	MODEL NUMBER	BHMA FINISH	WEIGHT	MUST BE ORDERED IN MULTIPLE QTY	MULTIPLE QTY	PACKED PER BOX	LIST PRICE	
								EACH	PACKAGE
299 Rescue Offset Emergency Stop Strike (Part) All Strikes Double Lip. Must be used with Center Hung Pivots. Strike Dimension Options: 7" Stk = 5 3/4" x 2 3/4" Frame 8" Stk = 6 3/4" x 2 3/4" Frame		299EB-7	630	-	-	1	-	\$73.30	-
		299EB-8	630	-	-	1	-	73.30	-
299 Rescue Center Emergency Strike Assembly All Strikes Double Lip. Must be used with Center Hung Pivots. Strike Dimension Options: 7" Stk = 5 3/4" x 2 3/4" Frame 8" Stk = 6 3/4" x 2 3/4" Frame		299AS-7**	630			1	-	189.80	-
		299AS-8	630	-	-	1	-	189.80	-
299 Rescue Offset Emergency Strike Assembly All Strikes Double Lip. Must be used with Center Hung Pivots. Strike Dimension Options: 7" Stk = 5 3/4" x 2 3/4" Frame 8" Stk = 6 3/4" x 2 3/4" Frame		299AB-7	630	-	-	1	-	189.80	-
		299AB-8	630	-	-	1	-	189.80	-
325 Magnetic Catch	Aluminum	325A3	666	1.9	-	1	20	3.30	-
		325A92**	673	1.9	-	1	20	3.30	-
326 Heavy Duty Magnetic Catch	Aluminum	326A3	666	3.0	-	1	10	9.20	-
		326A92**	673	3.0	-	1	10	9.20	-
327 Magnetic Catch Dual Triple Pole	Aluminum	327A3**	666	4.0	-	1	10	15.70	-
		327A92**	673	4.0	-	1	10	15.70	-
330 Double Roller Catch	Steel	330F2C	604	1.1	-	1	30	2.00	-
		SP330F2C	604	2.3	Yes	50	50	-	\$99.70
335 Roller Catch Adjustable	Brass	335B3	605	1.6	-	1	10	15.70	-
		335B5	609	1.6	-	1	10	18.70	-
		335B10	612	1.6	-	1	10	18.70	-
		335B10B**	613	1.6	-	1	10	18.70	-
		335B15**	619	1.6	-	1	10	19.60	-
		335B26**	625	1.6	-	1	10	18.70	-
		335B26D**	626	1.6	-	1	10	18.70	-
		335B-643E/716	-	1.6	-	1	10	18.70	-
335 Strike & Mounting Package		09-45-613	613	-	-	1	1	7.00	-
		09-45-619	619	-	-	1	1	7.00	-
336 Roller Catch Adjustable	Brass	336B3	605	1.6	-	1	10	14.30	-
		336B4	606	1.6	-	1	10	18.70	-
		336B5	609	1.6	-	1	10	18.70	-
		336B10	612	1.6	-	1	10	18.70	-
		336B10B**	613	1.6	-	1	10	18.70	-
		336B15	619	1.6	-	1	10	18.70	-
		336B26	625	1.6	-	1	10	18.70	-
		336B26D**	626	1.6	-	1	10	17.40	-
		336B-643E/716	-	1.6	-	1	10	18.70	-
336 Strike & Mounting Package		09-47-605	605	-	-	1	1	7.60	-
		09-47-613	613	-	-	1	1	7.60	-
		09-47-626	626	-	-	1	1	7.60	-

Lead time exception: ** Products are stocked and will typically ship in 3-5 days

Bold pricing indicates item is in stock and available for **Fast Track** and **ProXpress**

MODEL	SUBSTRATE	MODEL NUMBER	BHMA FINISH	WEIGHT	MUST BE ORDERED IN MULTIPLE QTY	MULTIPLE QTY	PACKED PER BOX	LIST PRICE	
								EACH	PACKAGE
345 Ball Catch 	Brass	345B3**	605	0.8	-	1	10	\$9.20	-
		345B5	609	0.8	-	1	10	10.10	-
		345B10	612	0.8	-	1	10	10.50	-
		345B10B	613	0.8	-	1	10	10.50	-
		345B15	619	0.8	-	1	10	10.80	-
		345B26	625	0.8	-	1	10	10.50	-
		345B26D	626	0.8	-	1	10	10.50	-
347 Ball Catch 	Brass	347B3**	605	1.9	-	1	10	13.70	-
		347B4	606	1.9	-	1	10	13.70	-
		347B5	609	1.9	-	1	10	14.80	-
		347B10	612	1.9	-	1	10	15.50	-
		347B10B**	613	1.9	-	1	10	15.50	-
		347B15**	619	1.9	-	1	10	14.80	-
		347B26**	625	1.9	-	1	10	15.50	-
		347B26D**	626	1.9	-	1	10	15.50	-
		347B-643E/716	-	1.9	-	1	10	15.50	-
		347B-BLK	622	1.9	-	1	10	15.50	-
347 Strike & Mounting Package		09-53-605	605	-	-	1	10	7.00	-
		09-53-613	613	-	-	1	10	7.00	-
		09-53-619	619	-	-	1	10	7.00	-
		09-53-625	625	-	-	1	10	7.00	-
		09-53-626	626	-	-	1	10	7.00	-
349 Ball Catch 	Brass	349B3	605	1.8	-	1	10	13.70	-
		349B4	606	1.8	-	1	10	13.70	-
		349B5	609	1.8	-	1	10	16.20	-
		349B10	612	1.8	-	1	10	16.20	-
		349B10B**	613	1.8	-	1	10	16.20	-
		349B15**	619	1.8	-	1	10	16.80	-
		349B26	625	1.8	-	1	10	16.20	-
		349B26D**	626	1.8	-	1	10	16.20	-
		349B-643E/716	-	1.8	-	1	10	16.20	-
		349B-BLK	622	1.8	-	1	10	16.20	-
349 Strike & Mounting Package		09-61-605	-	-	-	1	1	7.00	-
		09-61-613	-	-	-	1	1	7.00	-
		09-61-626	-	-	-	1	1	7.00	-
FB358 Manual Flush Bolt Wood Door UL 90 Minutes 	Brass	FB358 US3	605	1.7	-	1	2	40.30	-
		FB358 US4	606	1.7	-	1	2	40.30	-
		FB358 US10	612	1.7	-	1	2	40.30	-
		FB358 US10B**	613	1.7	-	1	2	40.30	-
		FB358 US15	619	1.8	-	1	5	40.30	-
		FB358 US26	625	1.7	-	1	2	40.30	-
		FB358 US26D**	626	1.7	-	1	2	40.30	-
		FB358 643E/716	-	1.7	-	1	2	40.30	-
		FB358 BLK	622	1.7	-	1	2	40.30	-
SB360 Surface Bolt Heavy Duty, UL Listed	Steel	SB360 US2C 12 IN**	604	3.5	-	1	1	119.20	-
SB360 - MS Strike Package		09-82-604	604	-	-	1	1	26.50	-
SB360 - SNB Package		09-350-604	604	-	-	1	1	21.70	-
401/402CVX Wall Bumper w/Plastic Anchor Convex Rubber, with drywall and masonry anchors. 	Brass	WS401/402 CVX US3	605	2.9	-	1	10	18.00	-
		WS401/402 CVX US4	606	2.9	-	1	10	20.80	-
		WS401/402 CVX US10	612	2.9	-	1	10	20.80	-
		WS401/402 CVX US10B	613	2.9	-	1	10	20.80	-
		WS401/402 CVX US15	619	2.9	-	1	10	20.80	-
		WS401/402 CVX US26	625	2.9	-	1	10	20.80	-
		WS401/402 CVX US26D**	626	2.9	-	1	10	20.80	-
401/402CCV Wall Bumper w/Plastic Anchor Concave Rubber, with drywall and masonry anchors. 	Brass	WS401/402 CCV US3	605	3.1	-	1	10	18.00	-
		WS401/402 CCV US4	606	3.1	-	1	10	20.80	-
		WS401/402 CCV US10	612	3.1	-	1	10	20.80	-
		WS401/402 CCV US10B**	613	3.1	-	1	10	20.80	-
		WS401/402 CCV US15	619	3.1	-	1	10	20.80	-
		WS401/402 CCV US26	625	3.1	-	1	10	20.80	-
		WS401/402 CCV US26D**	626	3.1	-	1	10	20.80	-

HINGES

CONTINUOUS HINGES

PIVOTS

Numerical 1-059

Numerical 59-437

Numerical 438-1021

Numerical 1152-8190

Numerical 8200-9266

Lead time exception: ** Products are stocked and will typically ship in 3-5 days

Bold pricing indicates item is in stock and available for **Fast Track** and **ProXpress**

HINGES

CONTINUOUS HINGES

PIVOTS





Numerical 1-059

Numerical 59-437

Numerical 438-1021





Numerical 1152-8190

Numerical 8200-9266

MODEL	SUBSTRATE	MODEL NUMBER	BHMA FINISH	WEIGHT	MUST BE ORDERED IN MULTIPLE QTY	MULTIPLE QTY	PACKED PER BOX	LIST PRICE	
								EACH	PACKAGE
WS404-CVX Small Wall Stop Convex Rubber 1" Base Diameter 	Brass	WS404 US3	605	1.0	-	1	20	\$6.30	-
		WS404 US4	606	1.0	-	1	20	7.50	-
		WS404 US5	609	1.0	-	1	20	7.50	-
		WS404 US10	612	1.0	-	1	20	7.50	-
		WS404 US10B	613	1.0	-	1	20	7.50	-
		WS404 US15	619	1.0	-	1	20	7.80	-
		WS404 US26	625	1.0	-	1	20	7.50	-
		WS404 US26D**	626	1.0	-	1	20	7.50	-
		WS404 643E/716	-	1	-	1	20	7.50	-
		WS404 BLK	622	1	-	1	20	7.50	-
405 Coat and Hat Hook 	Aluminum	405A3	666	1.5	-	1	20	2.70	-
		405A4	667	1.5	-	1	20	2.70	-
		405A5	-	1.5	-	1	20	2.70	-
		405A10	668	1.5	-	1	20	2.70	-
		405A10B	703	1.5	-	1	20	2.70	-
		405A14	669	1.5	-	1	20	2.70	-
		405A92**	673	1.5	-	1	20	2.70	-
406/407CVX Wall Stop w/Plastic Anchor Convex Rubber, with drywall and masonry anchors. 	Brass	WS406/407CVX US3	605	1.8	-	1	10	4.30	-
		WS406/407CVX US4	606	1.8	-	1	10	4.30	-
		WS406/407CVX US5	609	1.8	-	1	10	4.90	-
		WS406/407CVX US10	612	1.8	-	1	10	4.90	-
		WS406/407CVX US10B**	613	1.8	-	1	10	4.90	-
		WS406/407CVX US15**	619	1.8	-	1	10	4.90	-
		WS406/407CVX US26**	625	1.8	-	1	10	4.90	-
		WS406/407CVX US26D**	626	1.8	-	1	10	4.30	-
		WS406/407CVX 643E/716	-	1.8	-	1	10	4.90	-
		WS406/407CVX BLK	622	1.8	-	1	10	4.90	-
Stainless	WS406/407CVX US32D**	630	1.8	-	1	10	3.50	-	
406/407CCV Wall Stop w/Plastic Anchor Concave Rubber, with drywall and masonry anchors. 	Brass	WS406/407CCV US3**	605	2.0	-	1	10	4.30	-
		WS406/407CCV US4**	606	2.0	-	1	10	4.30	-
		WS406/407CCV US5	609	1.8	-	1	10	4.90	-
		WS406/407CCV US10**	612	2.0	-	1	10	4.90	-
		WS406/407CCV US10B**	613	2.0	-	1	10	4.90	-
		WS406/407CCV US15**	619	2.0	-	1	10	4.90	-
		WS406/407CCV US26**	625	2.0	-	1	10	4.90	-
		WS406/407CCV US26D**	626	2.0	-	1	10	4.30	-
		WS406/407CCV 643E/716	-	2	-	1	10	4.90	-
		WS406/407CCV BLK	622	2	-	1	10	4.90	-
Stainless	WS406/407CCV US32D**	630	2.0	-	1	10	3.50	-	

Lead time exception: ** Products are stocked and will typically ship in 3-5 days

Bold pricing indicates item is in stock and available for Fast Track and ProXpress

MODEL	SUBSTRATE	MODEL NUMBER	BHMA FINISH	WEIGHT	MUST BE ORDERED IN MULTIPLE QTY	MULTIPLE QTY	PACKED PER BOX	LIST PRICE		
								EACH	PACKAGE	
FS410 Universal Floor Dome Stop		FS410 US3	605	3.0		1		29.40	-	
		FS410 US15	619	3.0		1		24.90	-	
		FS410 US26	625	3.0		1		24.90	-	
		FS410 US26D**	626	3.0		1		24.90	-	
		FS410 643E/716	-	3.0		1		24.90	-	
		FS410 BLK	622	3.0		1		24.90	-	
411 Wall Stop Adhesive Back	Rubber	411R-W**	-	1.1	-	1	20	3.20	-	
430 Floor Door Stop 	Aluminum	SP430A3	666	1.9	Yes	25	25	-	74.00	
		SP430A5	-	1.9	Yes	25	25	-	77.00	
		SP430A14	669	1.9	Yes	25	25	-	77.00	
		SP430A92	673	1.9	Yes	25	25	-	74.00	
	Brass	430 US3	605	1.8	-	1	10	16.80	-	
		430 US4	606	1.8	-	1	10	15.50	-	
		430 US5	609	1.8	-	1	10	19.80	-	
		430 US10B	613	1.8	-	1	10	19.80	-	
		430 US15	619	1.8	-	1	10	20.80	-	
		430 US26	625	1.8	-	1	10	19.80	-	
430 US26D		626	1.8	-	1	10	19.80	-		
430 Rubber Tip	Rubber	RT (WSPART.1075)	-	-	Yes	100	100	-	90.60	
FS434 Angle Door Stop	Steel	FS434 US2C**	604	4.0	-	1	10	9.70	-	
FS434 Rubber Tip		09-318	-	-	-	1	1	4.60	-	
R435 Riser For 436 Door Stop 	Aluminum	R435 1/4 IN	-	2.1	-	1	20	6.80	-	
		R435 3/8 IN	-	2.6	-	1	20	6.80	-	
		R435 1/2 IN	-	2.9	-	1	20	6.80	-	
		R435 5/8 IN	-	3.3	-	1	20	6.80	-	
		R435 3/4 IN	-	3.2	-	1	20	6.80	-	
		R435 7/8 IN	-	3.2	-	1	20	6.80	-	
		R435 1 IN	-	3.1	-	1	20	6.80	-	
FS436 Floor Dome Stop 1" Height 	Brass	FS436 US3	605	2.2	-	1	10	7.20	-	
		FS436 US4	606	2.2	-	1	10	7.20	-	
		FS436 US5	609	2.2	-	1	10	7.20	-	
		FS436 US10	612	2.2	-	1	10	8.30	-	
		FS436 US10B**	613	2.2	-	1	10	8.30	-	
		FS436 US15**	619	2.2	-	1	10	8.30	-	
		FS436 US26**	625	2.2	-	1	10	7.50	-	
		FS436 US26D**	626	2.2	-	1	10	6.00	-	
		FS436 643E/716	-	2.2	-	1	10	8.20	-	
		FS436 BLK	622	2.2	-	1	10	8.20	-	
	SPFS436US26D	626	2.5	Yes	10	10	-	60.30		
	Aluminum	FS436 US28**	628	-	-	-	1	10	5.50	-
		SPFS436US28	628	-	-	Yes	15	15	-	82.35
R437 Riser For 438 Door Stop 	Aluminum	R437 1/4 IN	-	2.0	-	1	10	7.30	-	
		R437 3/8 IN	-	2.0	-	1	10	7.30	-	
		R437 1/2 IN	-	2.0	-	1	10	7.30	-	
		R437 5/8 IN	-	2.0	-	1	10	7.30	-	
		R437 3/4 IN	-	2.2	-	1	10	7.30	-	
		R437 1 IN	-	2.3	-	1	10	7.30	-	

HINGES
 CONTINUOUS HINGES
 PIVOTS
 Numerical 1-059
 Numerical 59-437
 Numerical 438-1021
 Numerical 1152-8190
 Numerical 8200-9266

Lead time exception: ** Products are stocked and will typically ship in 3-5 days

Bold pricing indicates item is in stock and available for **Fast Track** and **ProXpress**

HINGES

CONTINUOUS HINGES

PIVOTS







Numerical 1-059

Numerical 59-437

Numerical 438-1021







Numerical 1152-8190

Numerical 8200-9266

MODEL	SUBSTRATE	MODEL NUMBER	BHMA FINISH	WEIGHT	MUST BE ORDERED IN MULTIPLE QTY	MULTIPLE QTY	PACKED PER BOX	LIST PRICE		
								EACH	PACKAGE	
FS438 Floor Dome Stop 13/8" Height 	Brass	FS438 US3	605	2.7	-	1	10	\$8.50	-	
		FS438 US4	606	2.7	-	1	10	8.50	-	
		FS438 US5	609	2.7	-	1	10	8.50	-	
		FS438 US10	612	2.7	-	1	10	9.70	-	
		FS438 US10B**	613	2.7	-	1	10	9.70	-	
		FS438 US15	619	2.7	-	1	10	12.30	-	
		FS438 US26	625	2.7	-	1	10	9.10	-	
		FS438 US26D**	626	2.7	-	1	10	6.70	-	
		FS438 643E/716	-	2.7	-	1	10	9.70	-	
	FS438 BLK	622	2.7	-	1	10	9.70	-		
	Aluminum	FS438 US28**	628	1.6	-	1	10	6.60	-	
FS439 	Zinc	FS439 US3	677	2.2	-	1	10	12.50	-	
		FS439 US4	678	2.2	-	1	10	12.50	-	
		FS439 US10B**	704	2.2	-	1	10	13.50	-	
		FS439 US15	-	2.2	-	1	10	12.50	-	
		FS439 US26	681	2.2	-	1	10	13.50	-	
		FS439 US26D**	682	2.2	-	1	10	11.10	-	
		FS439 643E/716	-	2.2	-	1	10	13.50	-	
		FS439 BLK	676	2.2	-	1	10	13.50	-	
			Stainless	FS439 US32D**	630	2.2	-	1	10	18.20
	FS441 Floor Stop Now furnished with wood and masonry fasteners 	Brass	FS441 US3	605	1.1	-	1	2	24.90	-
FS441 US4			606	1.1	-	1	2	28.40	-	
FS441 US5			609	1.1	-	1	2	26.60	-	
FS441 US10			612	1.1	-	1	2	28.40	-	
FS441 US10B**			613	1.1	-	1	2	26.60	-	
FS441 US15			619	1.1	-	1	2	34.30	-	
FS441 US26			625	1.1	-	1	2	34.30	-	
FS441 US26D**			626	1.1	-	1	2	24.20	-	
FS441 643E/716			-	1.1	-	1	2	34.30	-	
FS441 BLK		622	1.1	-	1	2	26.60	-		
FS441 Rubber Tip		09-315	-	-	-	1	1	2.40	-	
WS443 Wall Door Stop for Masonry Mounting 	Brass	WS443 US3	605	1.5	-	1	2	38.60	-	
		WS443 US4	606	1.5	-	1	2	48.20	-	
		WS443 US10	612	1.5	-	1	2	46.50	-	
		WS443 US10B	613	1.5	-	1	2	46.50	-	
		WS443 US15	619	1.5	-	1	2	48.20	-	
		WS443 US26	625	1.5	-	1	2	46.50	-	
		WS443 US26D**	626	1.5	-	1	2	46.50	-	
		WS443 643E/716	-	1.5	-	1	2	48.20	-	
		WS443 BLK	622	1.5	-	1	2	46.50	-	
	WS443 Rubber Tip		09-316	-	-	-	1	1	2.40	-
FS444 Floor Stop for Masonry Mounting 	Brass	FS444 US3	605	2.0	-	1	2	29.50	-	
		FS444 US4	606	2.0	-	1	2	29.50	-	
		FS444 US10	612	2.0	-	1	2	29.50	-	
		FS444 US10B**	613	2.0	-	1	2	34.80	-	
		FS444 US15	619	2.0	-	1	2	37.80	-	
		FS444 US26	625	2.0	-	1	2	29.50	-	
		FS444 US26D**	626	2.0	-	1	2	28.40	-	
		FS444 643E/716	-	2.0	-	1	2	34.80	-	
		FS444 BLK	622	2.0	-	1	2	29.50	-	
	FS444 Rubber Tip		09-316	-	-	-	1	1	2.40	-
WS445 Wall Door Stop w/Heavy Duty Holder for Masonry Mounting 	Brass	WS445 US3	605	1.9	-	1	2	61.30	-	
		WS445 US4	606	1.9	-	1	2	73.60	-	
		WS445 US10	612	1.9	-	1	2	73.60	-	
		WS445 US10B	613	1.9	-	1	2	73.60	-	
		WS445 US15	619	1.9	-	1	2	76.50	-	
		WS445 US26	625	1.9	-	1	2	73.60	-	
		WS445 US26D**	626	1.9	-	1	2	73.60	-	
		WS445 643E/716	-	1.9	-	1	2	76.50	-	
		WS445 BLK	622	1.9	-	1	2	73.60	-	
	WS445 Rubber Tip		09-316	-	-	-	1	1	2.40	-
FS446 Floor Stop w/Heavy Duty Holder for Masonry Mounting 	Brass	FS446 US3	605	2.4	-	1	2	58.40	-	
		FS446 US4	606	2.4	-	1	2	58.40	-	
		FS446 US10	612	2.4	-	1	2	58.40	-	
		FS446 US10B**	613	2.4	-	1	2	52.00	-	
		FS446 US15	619	2.4	-	1	2	54.10	-	
		FS446 US26	625	2.4	-	1	2	58.40	-	
		FS446 US26D**	626	2.4	-	1	2	41.60	-	
		FS446 643E/716	-	2.4	-	1	2	58.40	-	
		FS446 BLK	622	2.4	-	1	2	58.40	-	
		Aluminum	FS446 US28	628	1.3	-	1	2	29.90	-
FS446 Rubber Tip		09-316	-	-	-	1	1	2.40	-	

Lead time exception: ** Products are stocked and will typically ship in 3-5 days

Bold pricing indicates item is in stock and available for Fast Track and ProXpress

MODEL	SUBSTRATE	MODEL NUMBER	BHMA FINISH	WEIGHT	MUST BE ORDERED IN MULTIPLE QTY	MULTIPLE QTY	PACKED PER BOX	LIST PRICE	
								EACH	PACKAGE
WS447 Heavy Duty Wall Door Stop for Drywall Mounting 	Brass	WS447 US3	605	1.3	-	1	2	\$35.10	-
		WS447 US4	606	1.3	-	1	2	42.20	-
		WS447 US10	612	1.3	-	1	2	42.20	-
		WS447 US10B	613	1.3	-	1	2	42.20	-
		WS447 US15	619	1.3	-	1	2	43.90	-
		WS447 US26	625	1.3	-	1	2	42.20	-
		WS447 US26D**	626	1.3	-	1	2	42.20	-
		WS447 643E/716	-	1.3	-	1	2	36.30	-
		WS447 BLK	622	1.3	-	1	2	34.90	-
WS447 Rubber Tip		09-316	-	-	-	1	1	2.40	-
FS448 Floor Door Stop Heavy Duty for Wood Mounting 	Brass	FS448 US3	605	1.9	-	1	2	33.10	-
		FS448 US4	606	1.9	-	1	2	33.10	-
		FS448 US5	609	1.9	-	1	2	38.40	-
		FS448 US10	612	1.9	-	1	2	33.10	-
		FS448 US10B**	613	1.9	-	1	2	32.00	-
		FS448 US15	619	1.9	-	1	2	41.60	-
		FS448 US26	625	1.9	-	1	2	41.60	-
		FS448 US26D**	626	1.9	-	1	2	33.10	-
		FS448 643E/716	-	1.9	-	1	2	41.60	-
	FS448 BLK	622	1.9	-	1	2	41.60	-	
FS448 Rubber Tip	Aluminum	FS448 US28	628	0.8	-	1	2	24.30	-
		09-316	-	-	-	1	1	2.40	-
WS449 Wall Door Stop w/Heavy Duty Holder for Drywall Mounting 	Brass	WS449 US3	605	1.6	-	1	2	58.50	-
		WS449 US4	606	1.6	-	1	2	70.20	-
		WS449 US10	612	1.6	-	1	2	70.20	-
		WS449 US10B	613	1.6	-	1	2	70.20	-
		WS449 US15	619	1.6	-	1	2	73.00	-
		WS449 US26	625	1.6	-	1	2	70.20	-
		WS449 US26D**	626	1.6	-	1	2	70.20	-
		WS449 643E/716	-	1.6	-	1	2	73.00	-
		WS449 BLK	622	1.6	-	1	2	70.20	-
	WS449 Rubber Tip	Aluminum	WS449 US28	628	0.9	-	1	2	49.00
		09-316	-	-	-	1	1	2.40	-
FS450 Floor Door Stop w/Heavy Duty Holder for Wood Mounting 	Brass	FS450 US3	605	2.2	-	1	2	62.10	-
		FS450 US4	606	2.2	-	1	2	62.10	-
		FS450 US10	612	2.2	-	1	2	62.10	-
		FS450 US10B	613	2.2	-	1	2	62.10	-
		FS450 US15	619	2.2	-	1	2	66.00	-
		FS450 US26	625	2.2	-	1	2	62.10	-
		FS450 US26D**	626	2.2	-	1	2	45.20	-
		FS450 643E/716	-	2.20	-	1	2	66.00	-
		FS450 BLK	622	2.2	-	1	2	62.10	-
	FS450 Rubber Tip	Aluminum	FS450 US28	628	1.1	-	1	2	33.60
		09-316	-	-	-	1	1	2.40	-
FS452 Kick Down Door Holder 4" 	Brass	FS452-4 US3	605	5.0	-	1	10	32.00	-
		FS452-4 US4	606	5.0	-	1	10	32.00	-
		FS452-4 US10	612	5.0	-	1	10	32.00	-
		FS452-4 US10B	613	5.0	-	1	10	33.80	-
		FS452-4 US15	619	5.0	-	1	10	43.80	-
		FS452-4 US26	625	5.0	-	1	10	47.50	-
		FS452-4 US26D**	626	5.0	-	1	10	30.80	-
		FS452-4 643E/716	-	5.0	-	1	10	43.80	-
		FS452-4 BLK	622	5.0	-	1	10	33.80	-
	FS452 Rubber Tips	Aluminum	FS452-4 US28	628	2.1	-	1	10	27.90
		HRT (FSPART.1075)	-	-	Yes	100	100	-	\$133.40
FS452 Kick Down Door Holder 5" 	Brass	FS452-5 US3	605	5.8	-	1	10	44.30	-
		FS452-5 US4	606	5.8	-	1	10	44.30	-
		FS452-5 US10	612	5.8	-	1	10	44.30	-
		FS452-5 US10B	613	5.8	-	1	10	44.30	-
		FS452-5 US15	619	5.8	-	1	10	49.90	-
		FS452-5 US26	625	5.8	-	1	10	55.50	-
		FS452-5 US26D**	626	5.8	-	1	10	38.20	-
		FS452-5 643E/716	-	5.8	-	1	10	49.90	-
		FS452-5 BLK	622	5.8	-	1	10	44.30	-
FS452 Rubber Tips		HRT (FSPART.1075)	-	-	Yes	100	100	-	133.40
SB453 Surface Bolt UL Listed 8" 	Steel	SB453US2C-8-TB**	604	5.4	-	1	5	43.40	-
		SB453US3-8-TB	632	5.8	-	1	5	43.40	-
		SB453US4-8-TB	633	5.8	-	1	5	43.40	-
		SB453US10-8-TB	639	5.4	-	1	5	52.30	-
		SB453US10B-8-TB	640	5.4	-	1	5	56.20	-
		SB453US15-8-TB**	646	5.4	-	1	5	56.20	-
		SB453US26D-8-TB	652	5.4	-	1	5	53.50	-
		SB453643E/716-8-TB**	-	5.4	-	1	5	56.20	-
		SB453BLK-8-TB	-	5.8	-	1	5	43.40	-

HINGES

CONTINUOUS HINGES

PIVOTS

Numerical 1-059

Numerical 59-437

Numerical 438-1021

Numerical 1152-8190

Numerical 8200-9266

Lead time exception: ** Products are stocked and will typically ship in 3-5 days

Bold pricing indicates item is in stock and available for **Fast Track** and **ProXpress**

HINGES

CONTINUOUS HINGES

PIVOTS







Numerical 1-059

Numerical 59-437

Numerical 438-1021







Numerical 1152-8190

Numerical 8200-9266

MODEL	SUBSTRATE	MODEL NUMBER	BHMA FINISH	WEIGHT	MUST BE ORDERED IN MULTIPLE QTY	MULTIPLE QTY	PACKED PER BOX	LIST PRICE	
								EACH	PACKAGE
SB453 Surface Bolt UL Listed 12"	Steel	SB453US2C 12-TB	604	6.6	-	1	5	\$54.80	-
		SB453US10 12-TB	639	6.6	-	1	5	58.50	-
		SB453US10B 12-TB	640	6.6	-	1	5	63.90	-
		SB453US15 12-TB	646	6.6	-	1	5	67.60	-
		SB453US26D 12-TB**	652	6.6	-	1	5	67.60	-
		SB453643E/716 12-TB	-	6.6	-	1	5	67.60	-
		SB453BLK 12-TB	-	6.6	-	1	5	67.60	-
SB453 Thrubolt with Cap Nut Pkg		09-340-626	626	-	-	1	1	9.20	-
SB453 Sex Bolt Pkg		09-351-604	604	-	-	1	1	17.00	-
FS455 4" Kick Down Door Holder 	Aluminum	FS455-4 US3AL	666	1.9	-	1	10	8.60	-
		FS455-4 US5AL	-	2.0	-	1	10	12.80	-
		FS455-4 US10AL	668	1.9	-	1	10	8.60	-
		FS455-4 US27**	673	1.9	-	1	10	8.60	-
		SPFS455-4 US3AL	666	46.5	Yes	15	15	-	\$128.25
		SPFS455-4 US5AL	-	46.5	Yes	15	15	-	194.85
		SPFS455-4 US27	673	46.5	Yes	15	15	-	128.25
	Brass	FS455-4 US3	605	4.6	-	1	10	34.80	-
		FS455-4 US4	606	4.6	-	1	10	34.80	-
		FS455-4 US5	609	4.6	-	1	10	41.70	-
		FS455-4 US10	612	4.6	-	1	10	34.80	-
		FS455-4 US10B**	613	4.6	-	1	10	41.70	-
		FS455-4 US15	619	4.6	-	1	10	42.70	-
		FS455-4 US26	625	4.6	-	1	10	41.70	-
		FS455-4 US26D**	626	4.6	-	1	10	41.70	-
FS455-4 643E/716		-	4.6	-	1	10	42.70	-	
FS455-4 BLK		622	4.6	-	1	10	41.70	-	
FS455 Rubber Tips		HRT (FSPART.1075)	-	-	Yes	100	100	-	133.40
FB457 Manual Flush Bolt UL 3 Hour Single Metal Door  Accessory Rod Lengths Available** 18", 24", 36", 48" 6.60 List Price	Brass	FB457-12 US3	605	2.0	-	1	12	29.90	-
		FB457-12 US4	606	2.0	-	1	12	29.90	-
		FB457-12 US10	612	2.0	-	1	12	29.90	-
		FB457-12 US10B**	613	2.0	-	1	12	29.90	-
		FB457-12 US15	619	2.0	-	1	12	29.90	-
		FB457-12 US26	625	2.0	-	1	12	29.90	-
		FB457-12 US26D**	626	2.0	-	1	12	29.90	-
		FB457-12 643E/716	-	2.0	-	1	12	29.90	-
		FB457-12 BLK	622	2.0	-	1	12	29.90	-
		FB457 Bolt Tips		09-176-604	-	-	-	1	1
FB457 Guide PKG		09-135	-	-	-	1	1	2.40	-
FB458 Manual Flush Bolt UL 3 Hour Single Metal Door  Accessory Rod Lengths Available** 18", 24", 36", 48" 6.60 List Price	Brass	FB458 US3 12 IN**	605	2.0	-	1	12	25.30	-
		FB458 US4 12 IN**	606	2.0	-	1	12	25.30	-
		FB458 US5 12 IN	609	2.0	-	1	12	25.30	-
		FB458 US10 12 IN**	612	2.0	-	1	12	25.30	-
		FB458 US10B 12 IN**	613	2.0	-	1	12	25.30	-
		FB458 US15 12 IN**	619	2.0	-	1	12	25.30	-
		FB458 US26 12 IN**	625	2.0	-	1	12	25.30	-
		FB458 US26D 12 IN**	626	2.0	-	1	12	23.50	-
		FB458 643E/716 12 IN	-	2.0	-	1	12	25.30	-
		FB458 BLK 12 IN	622	2.0	-	1	12	25.30	-
FB458 Bolt Tips		09-176-604	604	-	-	1	1	5.50	-
FB458 Guide PKG		09-135	-	-	-	1	1	2.40	-
RB470 Roller Bumper 2" Reach 	Brass	RB470 US3	605	0.9	-	1	2	33.30	-
		RB470 US26	625	0.9	-	1	2	41.70	-
		RB470 US26D	626	0.9	-	1	2	41.70	-
RB470 Large Roller PKG		09-137-626	626	-	-	1	1	6.30	-
RB471 Roller Bumper 4-1/2" Projection 	Brass	RB471 US3	605	1.0	-	1	2	31.50	-
		RB471 US4	606	1.0	-	1	2	37.80	-
		RB471 US26	625	1.0	-	1	2	37.80	-
		RB471 US26D**	626	1.0	-	1	2	37.80	-
RB472 Roller Bumper 6" Projection 	Brass	RB472 US3	605	1.1	-	1	2	33.40	-
		RB472 US4	606	1.1	-	1	2	39.80	-
		RB472 US10	612	1.1	-	1	2	39.80	-
		RB472 US10B	613	1.1	-	1	2	39.80	-
		RB472 US15	619	1.1	-	1	2	37.90	-
		RB472 US26	625	1.1	-	1	2	39.80	-
		RB472 US26D**	626	1.1	-	1	2	39.80	-
RB472 Large Roller PKG		09-137-626	626	-	-	1	1	6.30	-

Lead time exception: ** Products are stocked and will typically ship in 3-5 days

Bold pricing indicates item is in stock and available for **Fast Track** and **ProXpress**

MODEL	SUBSTRATE	MODEL NUMBER	BHMA FINISH	WEIGHT	MUST BE ORDERED IN MULTIPLE QTY	MULTIPLE QTY	PACKED PER BOX	LIST PRICE	
								EACH	PACKAGE
481 Chain Door Guard 	Brass	481B3	605	2.5	-	1	10	\$12.10	-
		481B26D	626	2.5	-	1	10	14.20	-
	Steel	481F3	632	2.3	-	1	10	6.70	-
		481F4	633	2.3	-	1	10	6.70	-
		481F5	638	2.3	-	1	10	7.60	-
		481F10	639	2.3	-	1	10	7.60	-
		481F15**	646	2.3	-	1	10	6.70	-
		481F26	651	2.3	-	1	10	6.70	-
		481F26D	652	2.3	-	1	10	6.70	-
481F-643E/716	-	1.2	-	1	10	7.80	-		
481F-BLK	-	2.3	-	1	10	7.60	-		
482 Door Guard 	Brass	482B3	605	5.0	-	1	5	33.50	-
		482B4	606	5.0	-	1	5	36.90	-
		482B10	612	5.0	-	1	5	36.90	-
		482B10B	613	5.0	-	1	5	36.90	-
		482B15	619	5.0	-	1	5	50.60	-
		482B26	625	5.0	-	1	5	36.90	-
		482B26D**	626	5.0	-	1	5	36.90	-
		482B643E/716	-	5.0	-	1	5	36.90	-
	482B-BLK	622	5.0	-	1	5	36.90	-	
	Zinc	482 Z605E	677	3.5	-	1	5	10.00	-
		482 Z609E	-	3.5	-	1	5	10.00	-
482 Z625E		681	3.5	-	1	5	11.80	-	
482 Z626E		682	3.5	-	1	5	11.80	-	
482 ▲ Plate		09-170-605	605	-	-	1	1	7.60	-
		09-170-613	613	-	-	1	1	7.60	-
		09-170-626	626	-	-	1	1	7.60	-
482 ▲ SHIM 1/8 In		09-576-626	626	-	-	1	1	17.30	-
482 ▲ SHIM 3/8 In		09-577-626	626	-	-	1	1	27.40	-
FS495 Auto Door Stop and Holder 3/8" Max Clearance Floor to Door 	Brass	FS495 US3	605	1.8	-	1	1	90.80	-
		FS495 US4	606	1.8	-	1	1	90.80	-
		FS495 US10	612	1.8	-	1	1	108.80	-
		FS495 US10B	613	1.8	-	1	1	108.80	-
		FS495 US26	625	1.8	-	1	1	108.80	-
		FS495 US26D**	626	1.8	-	1	1	90.80	-
FS496 Auto Door Stop and Holder 1" Max Clearance Floor to Door 	Brass	FS496 US3	605	1.5	-	1	1	103.60	-
		FS496 US10	612	1.5	-	-	1	103.60	-
		FS496 US10B	613	1.5	-	1	1	103.60	-
		FS496 US26	625	1.5	-	1	1	103.60	-
		FS496 US26D	626	1.5	-	1	1	103.60	-
FS497 Auto Door Stop and Holder 	Brass	FS497 US3	605	1.4	-	1	1	96.70	-
		FS497 US10	612	1.4	-	1	1	116.10	-
		FS497 US10B	613	1.4	-	1	1	116.10	-
		FS497 US26	625	1.4	-	1	1	116.10	-
		FS497 US26D	626	1.4	-	1	1	96.70	-
FS544 Kick Down Door Holder 4" 	Steel	FS544 SP4	706	-	-	1	-	12.80	-
		FS544 SPI0	691	-	-	1	-	12.80	-
		FS544 SP28**	689	-	-	1	-	12.80	-
		FS544 SP313	695	-	-	1	-	12.80	-
		FS544 BLK	-	-	-	1	-	12.80	-
FS555 Kick Down Door Holder 5" 	Steel	FS555 SP4	706	-	-	1	-	13.70	-
		FS555 SPI0	691	-	-	1	-	13.70	-
		FS555 SP28**	689	-	-	1	-	13.70	-
		FS555 SP313	695	-	-	1	-	13.70	-
		FS555 BLK	-	-	-	1	-	13.70	-

▲ Fits brass door guards only.

Lead time exception: ** Products are stocked and will typically ship in 3-5 days

Bold pricing indicates item is in stock and available for **Fast Track** and **ProXpress**

HINGES

CONTINUOUS HINGES

PIVOTS

Numerical 1-059

Numerical 59-437

Numerical 438-1021

Numerical 1152-8190

Numerical 8200-9266

HINGES

CONTINUOUS HINGES

PIVOTS









Numerical 1-059

Numerical 59-437

Numerical 438-1021



Numerical 1152-8190

Numerical 8200-9266

MODEL	SUBSTRATE	MODEL NUMBER	BHMA FINISH	WEIGHT	MUST BE ORDERED IN MULTIPLE QTY	MULTIPLE QTY	PACKED PER BOX	LIST PRICE	
								EACH	PACKAGE
506 Plymouth, Curved Double Coat Hook - Surface Mount 	Brass	506-605	605	-	-	1	20	\$12.20	-
		506-613	613	-	-	1	20	12.20	-
		506-625	625	-	-	1	20	12.20	-
		506-626	626	-	-	1	20	9.80	-
		506-643E/716	-	-	-	1	20	12.20	-
		506-BLK	622	-	-	1	20	12.20	-
507 Rhodes, Parallel Double Coat Hook - Surface Mount 	Brass	507-605	605	-	-	1	20	28.20	-
		507-613	613	-	-	1	20	29.60	-
		507-625	625	-	-	1	20	29.60	-
		507-626	626	-	-	1	20	23.30	-
		507-643E/716	-	-	-	1	20	29.60	-
		507-BLK	622	-	-	1	20	29.60	-
507B Rhodes Single Coat Hook - Surface Mount	Brass	507B-605	605	-	-	1	50	28.20	-
		507B-613	613	-	-	1	50	29.60	-
		507B-625	625	-	-	1	50	29.60	-
		507B-626	626	-	-	1	50	23.30	-
		507B-643E/716	-	-	-	1	50	29.60	-
		507B-BLK	622	-	-	1	50	29.60	-
508 Greenwich, Wide Body Double Coat Hook - Surface Mount 	Brass	508-605	605	-	-	1	8	75.00	-
		508-613	613	-	-	1	8	77.50	-
		508-625	625	-	-	1	8	77.50	-
		508-626	626	-	-	1	8	60.30	-
		508-643E/716	-	-	-	1	8	77.50	-
		508-BLK	622	-	-	1	8	77.50	-
508C Greenwich, Wide Body Double Coat Hook - Concealed Mount 	Brass	508C-605	605	-	-	1	8	146.40	-
		508C-613	613	-	-	1	8	152.60	-
		508C-619	619	-	-	1	8	142.60	-
		508C-625	625	-	-	1	8	142.60	-
		508C-626	626	-	-	1	8	116.80	-
		508C-643E/716	-	-	-	1	8	152.60	-
508C-BLK	622	-	-	1	8	152.60	-		
509C Tubular, Double Coat Hook - Concealed Mount 	Brass	509C-605	605	-	-	1	5	122.90	-
		509C-613	613	-	-	1	5	128.00	-
		509C-625	625	-	-	1	5	128.00	-
		509C-626	626	-	-	1	5	98.30	-
		509C-643E/716	-	-	-	1	5	128.00	-
		509C-BLK	622	-	-	1	5	128.00	-
510C Latitude, Angled Double Coat Hook - Concealed Mount 	Brass	510C-605	605	-	-	1	4	122.90	-
		510C-613	613	-	-	1	4	128.00	-
		510C-625	625	-	-	1	4	128.00	-
		510C-626	626	-	-	1	4	98.30	-
		510C-643E/716	-	-	-	1	4	128.00	-
		510C-BLK	622	-	-	1	4	128.00	-
510BC Latitude, Angled Single Coat Hook - Concealed Mount 	Brass	510BC-605	605	-	-	1	8	87.20	-
		510BC-613	613	-	-	1	8	91.10	-
		510BC-625	625	-	-	1	8	91.10	-
		510BC-626	626	-	-	1	8	70.10	-
		510BC-643E/716	-	-	-	1	8	91.10	-
		510BC-BLK	622	-	-	1	8	91.10	-
511BC Century, Wide Single Coat Hook - Concealed Mount	Brass	511BC-605	605	-	-	1	50	21.00	-
		511BC-613	613	-	-	1	50	21.00	-
		511BC-625	625	-	-	1	50	21.00	-
		511BC-626	626	-	-	1	50	15.90	-
		511BC-643E/716	-	-	-	1	50	21.00	-
		511BC-BLK	622	-	-	1	50	21.00	-
543 Camelot, J Curve, Double Coat Hook - Surface Mount 	Stainless	543-629	629	-	-	1	10	11.10	-
		543-630	630	-	-	1	10	11.10	-
543B Camelot, J Curve, Single Coat Hook - Surface Mount	Stainless	543B-629	629	-	-	1	10	9.80	-
		543B-630	630	-	-	1	10	9.80	-
554 Century, Wave Double Coat Hook - Surface Mount	Brass	554-605	605	-	-	1	10	30.70	-
		554-619	619	-	-	1	10	30.70	-
		554-625	625	-	-	1	10	24.60	-
		554-626	626	-	-	1	10	24.60	-
		554-643E/716	-	-	-	1	10	30.70	-
		554-BLK	622	-	-	1	10	30.70	-

Lead time exception: ** Products are stocked and will typically ship in 3-5 days

Bold pricing indicates item is in stock and available for Fast Track and ProXpress

MODEL	SUBSTRATE	MODEL NUMBER	BHMA FINISH	WEIGHT	MUST BE ORDERED IN MULTIPLE QTY	MULTIPLE QTY	PACKED PER BOX	LIST PRICE	
								EACH	PACKAGE
558B Orbit 1" J Curve w/ Bumper Single Coat Hook - Surface Mount	Brass	558B-605	605	-	-	1	20	\$100.80	-
		558B-613	613	-	-	1	20	105.70	-
		558B-619	619	-	-	1	20	100.80	-
		558B-625	625	-	-	1	20	105.70	-
		558B-626	626	-	-	1	20	81.10	-
		558B-643E/716	-	-	-	1	20	105.70	-
		558B-BLK	622	-	-	1	20	100.80	-
559B Tubular, w/ Disc Single Coat Hook - Surface Mount	Brass	559B-605	605	-	-	1	40	23.30	-
		559B-613	613	-	-	1	40	23.30	-
		559B-619	619	-	-	1	40	23.30	-
		559B-625	625	-	-	1	40	23.30	-
		559B-626	626	-	-	1	40	18.50	-
		559B-643E/716	-	-	-	1	40	23.30	-
571 Coat and Hat Hook 	Aluminum	571A3**	666	1.3	-	1	20	1.30	-
		571A5	-	1.3	-	1	20	1.90	-
		571A10	668	1.3	-	1	20	1.30	-
		571A14**	669	1.3	-	1	20	1.90	-
		571A15**	670	1.3	-	1	20	1.90	-
		571A26	672	1.3	-	1	20	1.90	-
		571A26D	702	1.3	-	1	20	1.80	-
		571A92**	673	1.3	-	1	20	1.30	-
		571A-643E/716**	-	1.3	-	1	20	2.60	-
		571A-BLK	-	1.4	-	1	20	2.60	-
		571A-W	-	1.4	-	1	20	2.60	-
		SP571A3	666	47.5	Yes	25	25	-	\$34.25
		SP571A5	-	47.5	Yes	25	25	-	46.75
		SP571A14	669	47.5	Yes	25	25	-	48.25
	SP571A92	673	47.5	Yes	25	25	-	34.25	
	SP571A-W	-	47.5	Yes	25	25	-	65.50	
	Brass	571B3	605	1.5	-	-	10	8.70	-
		571B4	606	1.5	-	-	10	10.30	-
		571B5	609	1.5	-	-	10	10.30	-
		571B10B**	613	1.5	-	1	10	10.30	-
571B15**		619	1.5	-	1	10	10.90	-	
571B26		625	1.5	-	1	10	10.30	-	
571B26D**		626	1.5	-	1	10	10.30	-	
571B-643E/716		-	1.5	-	1	10	10.30	-	
571B-BLK		622	1.5	-	1	10	10.30	-	
SP571B26		625	24	Yes	10	10	-	107.40	
572 Coat and Hat Hook 	Aluminum	572A3	666	1.9	-	1	20	4.30	-
		572A5	-	1.9	-	1	20	4.50	-
		572A10	668	1.9	-	1	20	4.50	-
		572A10B	703	0.0	-	1	20	4.50	-
		572A14	669	1.9	-	1	20	4.50	-
		572A15	670	1.9	-	1	20	4.50	-
		572A92	673	1.9	-	1	20	4.30	-
	Brass	572B3	605	1.1	-	1	10	11.80	-
		572B4	606	1.1	-	1	10	11.80	-
		572B5	609	1.1	-	1	10	14.90	-
		572B10	612	1.1	-	1	10	11.80	-
		572B10B	613	1.1	-	1	10	14.30	-
		572B15	619	1.1	-	1	10	14.90	-
		572B26	625	1.1	-	1	10	14.30	-
572B26D**	626	1.1	-	1	10	14.30	-		

HINGES

CONTINUOUS
HINGES





PIVOTS

Numerical
1-059Numerical
59-437Numerical
438-1021Numerical
1152-8190Numerical
8200-9266

Lead time exception: ** Products are stocked and will typically ship in 3-5 days

Bold pricing indicates item is in stock and available for **Fast Track** and **ProXpress**





HINGES
 CONTINUOUS HINGES
 PIVOTS
 Numerical 1-059
 Numerical 59-437
 Numerical 438-1021
 Numerical 1152-8190
 Numerical 8200-9266

MODEL	SUBSTRATE	MODEL NUMBER	BHMA FINISH	WEIGHT	MUST BE ORDERED IN MULTIPLE QTY	MULTIPLE QTY	PACKED PER BOX	LIST PRICE	
								EACH	PACKAGE
574 Coat and Hat Hook 	Aluminum	574A3	666	1.6	-	1	10	8.60	-
		574A26	672	1.6	-	1	10	8.60	-
		574A92	673	0.0	-	1	10	8.60	-
	Brass	574B3	605	4.1	-	1	10	29.60	-
		574B4	606	0.0	-	1	10	29.60	-
		574B10	612	0.0	-	1	10	35.30	-
		574B10B	613	4.1	-	1	10	35.30	-
		574B15	619	0.0	-	1	10	38.90	-
		574B26	625	4.1	-	1	10	35.30	-
574B26D**	626	4.1	-	1	10	35.30	-		
575 Coat and Hat Hook 	Aluminum	575A3	666	1.4	-	1	10	5.20	-
		575A10B	703	1.4	-	1	10	5.80	-
		575A92	673	1.4	-	1	10	5.20	-
580 Ceiling Hook 	Aluminum	580A3	666	1.8	-	1	20	3.00	-
		580A5	-	0.0	-	1	20	3.20	-
		580A10	668	1.8	-	1	20	3.20	-
		580A14	669	1.8	-	1	20	3.20	-
		580A15	670	0.0	-	1	20	3.20	-
		580A26	672	1.8	-	1	20	3.20	-
		580A26D	702	1.8	-	1	20	3.20	-
		580A92**	673	1.8	-	1	20	3.00	-
		580A-643E/716**	-	0.0	-	1	20	3.20	-
		580A-BLK	-	0.0	-	1	20	3.20	-
		SP580A14	669	60.0	Yes	25	25	-	81.00
		SP580A3	666	60.0	Yes	25	25	-	75.00
		SP580A92	673	60.0	Yes	25	25	-	75.00
581 Wardrobe Hook 	Aluminum	581A3	666	0.9	-	1	20	1.70	-
		581A5	-	0.9	-	1	20	1.90	-
		581A14	669	0.8	-	1	20	1.90	-
		581A15	670	0.9	-	1	20	1.90	-
		581A26	672	0.9	-	1	20	1.90	-
		581A26D	702	0.9	-	1	20	1.90	-
		581A92**	673	0.90	-	1	20	1.70	-
		581A-643E/716	-	0.90	-	1	20	1.90	-
		581A-BLK	-	0.90	-	1	20	2.50	-
		581A-W	-	0.90	-	1	20	2.50	-
		SP581A3	666	120.0	Yes	50	50	-	81.50
		SP581A5	-	120.0	Yes	50	50	-	93.50
		SP581A14	669	120.0	Yes	50	50	-	93.50
		SP581A92	673	2.4	Yes	50	50	-	81.50
	Brass	581B3	605	0.8	-	1	10	5.90	-
		581B4	606	0.0	-	1	10	6.20	-
		581B5	609	0.8	-	1	10	7.10	-
		581B10	612	0.0	-	1	10	7.20	-
		581B10B	613	0.8	-	1	10	7.10	-
		581B15	619	0.8	-	1	10	7.30	-
		581B26	625	0.8	-	1	10	7.10	-
581B26D**		626	0.8	-	1	10	7.10	-	
581B-643E/716	-	-	-	1	10	7.30	-		
581B-BLK	622	-	-	1	10	7.10	-		

Continued on next page.

Lead time exception: ** Products are stocked and will typically ship in 3-5 days

Bold pricing indicates item is in stock and available for **Fast Track** and **ProXpress**

MODEL	SUBSTRATE	MODEL NUMBER	BHMA FINISH	WEIGHT	MUST BE ORDERED IN MULTIPLE QTY	MULTIPLE QTY	PACKED PER BOX	LIST PRICE	
								EACH	PACKAGE
581 Wardrobe Hook <i>Continued from previous page.</i> 	Brass	SP581B26	625	27.0	Yes	10	10	-	\$69.90
	Zinc**	581Z-619E	-	2.6	-	1	20	\$5.20	-
582 Wardrobe Hook 	Aluminum	582A3	666	1.0	-	1	20	1.90	-
		582A5	-	1.0	-	1	20	2.00	-
		582A10	668	1.0	-	1	20	2.00	-
		582A14**	669	1.0	-	1	20	2.00	-
		582A15	670	1.0	-	1	20	2.00	-
		582A26	672	1.0	-	1	20	2.00	-
		582A26D	702	1.0	-	1	20	2.00	-
		582A92**	673	1.0	-	1	20	1.90	-
		582A-643E/716	-	1.0	-	1	20	2.00	-
		582A-BLK	-	1.0	-	1	20	2.70	-
		582A-W**	-	1.0	-	1	20	2.70	-
		SP582A3	666	42.5	Yes	25	25	-	46.75
		SP582A5	-	42.5	Yes	25	25	-	49.75
		SP582A14	669	42.5	Yes	25	25	-	49.75
	SP582A92	673	42.5	Yes	25	25	-	46.75	
	SP582A-W	-	35.0	Yes	25	25	-	68.50	
	Brass	582B3	605	1.2	-	1	10	7.80	-
		582B4	606	1.2	-	1	10	8.70	-
		582B5	609	1.2	-	1	10	8.70	-
		582B10	612	1.2	-	1	10	9.30	-
582B10B		613	1.2	-	1	10	9.30	-	
582B15**		619	1.2	-	1	10	9.60	-	
582B26		625	1.2	-	1	10	9.30	-	
582B26D**		626	1.2	-	1	10	9.30	-	
582B-643E/716		-	1.2	-	1	10	9.60	-	
582B-BLK		622	1.2	-	1	10	9.30	-	
SP582B26		625	12.0	Yes	10	10	-	97.50	
Zinc		582Z-619E	-	4.7	-	1	20	5.20	-
585/586 Closet Pole Socket 	Steel	SP585F3	632	50.0	Yes	25	25	-	40.25
	Plastic	SP586P**	-	32.0	Yes	20	20	-	25.60
601 Mail Slot Sleeve 	Brass	60113/4 IN**	630	0.4	-	1	1	19.90	-
620 Letter Box Plate Magazine Open Back Plate Spring-Loaded Front Plate 	Brass	620B3	605	1.5	-	1	1	81.70	-
		620B5	609	1.5	-	1	1	100.80	-
		620B15	619	1.5	-	1	1	98.00	-
		620B26	625	1.5	-	1	1	98.00	-
		620B26D**	626	1.5	-	1	1	98.00	-
		620B-643E/716	-	3.3	-	1	1	98.00	-
		620B-BLK	622	3.3	-	1	1	98.00	-
	Aluminum	620PA28**	628	0.6	-	1	1	51.00	-

HINGES

CONTINUOUS HINGES

PIVOTS

Numerical 1-059

Numerical 59-437

Numerical 438-1021

Numerical 1152-8190

Numerical 8200-9266

Lead time exception: ** Products are stocked and will typically ship in 3-5 days

Bold pricing indicates item is in stock and available for **Fast Track** and **ProXpress**

HINGES

CONTINUOUS HINGES

PIVOTS



Numerical 1-059

Numerical 59-437

Numerical 438-1021



Numerical 1152-8190

Numerical 8200-9266

MODEL	SUBSTRATE	MODEL NUMBER	BHMA FINISH	WEIGHT	MUST BE ORDERED IN MULTIPLE QTY	MULTIPLE QTY	PACKED PER BOX	LIST PRICE	
								EACH	PACKAGE
620 Sex Bolt PKG		09-355-605	605	-	-	1	1	\$11.90	-
		09-355-613	613	-	-	1	1	14.40	-
		09-355-626	626	-	-	1	1	14.40	-
STK685 Double Acting Strike Custom Made Specify Jamb width when ordering	Brass	STK685 US3	605	-	-	1	-	307.10	-
		STK685 US4	606	-	-	1	-	307.10	-
		STK685 US10	612	-	-	1	-	307.10	-
		STK685 US10B	613	-	-	1	-	307.10	-
		STK685 US26	625	-	-	1	-	307.10	-
		STK685 US26D	626	-	-	1	-	307.10	-
STK685L Double Acting Strike, Custom Made Specify Dimple Location and Jamb Width when ordering	Brass	STK685L US3	605	-	-	1	-	307.10	-
		STK685L US4	606	-	-	1	-	307.10	-
		STK685L US10	612	-	-	1	-	307.10	-
		STK685L US10B	613	-	-	1	-	307.10	-
		STK685L US26	625	-	-	1	-	307.10	-
		STK685L US26D	626	-	-	1	-	307.10	-
U696 Door Viewer, 150° UL Listed 90 Min	Brass	U696B4	606	0.5	-	1	10	17.10	-
		U696B10B	613	0.5	-	1	10	17.10	-
		U696B15	619	0.5	-	1	10	17.10	-
		U696B26	625	0.5	-	1	10	17.10	-
		U696B26D**	626	0.5	-	1	10	17.10	-
		U696B-643E/716	-	0.5	-	1	10	17.10	-
		U696B-BLK	622	0.5	-	1	10	17.10	-
696-700-701 Viewer Cover	Brass	890312606	606	-	-	1	1	2.00	-
		890312613	613	-	-	1	1	2.00	-
		890312619	619	-	-	1	1	2.00	-
		890312625	625	-	-	1	1	2.00	-
		890312626	626	-	-	1	1	2.00	-
		890312716	716	-	-	1	1	2.00	-
		890312622	622	-	-	1	1	2.00	-
696-700-701 Viewer Extension	Brass	890314626	626	-	-	1	1	3.10	-
698 Door Viewer, 190° For Doors 1-3/8" to 2-1/8" U = UL Listed 90 Min P = Plastic Lens 	Brass	698B3	605	0.8	-	1	10	20.10	-
		698B26D**	626	0.8	-	1	10	20.10	-
		698P-B643E/716**	-	0.8	-	1	10	20.10	-
		U698B3**	605	0.8	-	1	10	24.10	-
		U698B15	619	0.8	-	1	10	24.10	-
		U698B26	625	0.8	-	1	10	24.10	-
		U698B26D**	626	0.8	-	1	10	24.10	-
		U698B-643E/716	-	0.8	-	1	10	24.10	-
		U698B-BLK	622	0.8	-	1	10	24.10	-
698 Viewer Cover	Brass	890311605	605	-	-	1	1	2.60	-
		890311619	619	-	-	1	1	2.60	-
		890311625	625	-	-	1	1	2.60	-
		890311626	626	-	-	1	1	2.60	-
		890311716	716	-	-	1	1	2.60	-
		890311622	622	-	-	1	1	2.60	-
698 Viewer Extension	Brass	890313626	626	-	-	1	1	4.20	-
700 Door Viewer, 120° For Doors 1-3/8" to 2-1/16" U = UL Listed 90 Min 	Brass	700B4	606	0.5	-	1	10	8.60	-
		700B26D**	626	0.5	-	1	10	8.60	-
		U700B4	606	0.5	-	1	10	11.70	-
		U700B10B	613	0.5	-	1	10	11.70	-
		U700B15	619	0.5	-	1	10	11.70	-
		U700B26	625	0.5	-	1	10	11.70	-
		U700B26D**	626	0.5	-	1	10	11.70	-
		U700B-643E/716	-	0.5	-	1	10	11.70	-
U700B-BLK	622	0.5	-	1	10	11.70	-		
700 Trim Washer		09-241-606	606	-	-	1	1	0.30	-
		09-241-613	613	-	-	1	1	0.30	-
		09-241-626	626	-	-	1	1	0.30	-
701 Door Viewer, 120° For Doors 2-1/8" to 2-5/8" U = UL Listed 90 Min 	Brass	701B4	606	0.8	-	1	10	9.40	-
		701B10B	613	0.8	-	1	10	9.40	-
		701B26D	626	0.8	-	1	10	9.40	-
		U701B4	606	0.8	-	1	10	13.50	-
		U701B10B	613	0.8	-	1	10	13.50	-
		U701B15	619	0.8	-	1	10	13.50	-
		U701B26	625	0.8	-	1	10	13.50	-
		U701B26D	626	0.5	-	1	10	13.50	-
		U701B-643E/716	-	0.8	-	1	10	13.50	-
U701B-BLK	622	0.8	-	1	10	13.50	-		

Lead time exception: ** Products are stocked and will typically ship in 3-5 days





Bold pricing indicates item is in stock and available for Fast Track and ProXpress

MODEL	SUBSTRATE	MODEL NUMBER	BHMA FINISH	WEIGHT	MUST BE ORDERED IN MULTIPLE QTY	MULTIPLE QTY	PACKED PER BOX	LIST PRICE	
								EACH	PACKAGE
VR810DT/VR814DT Vandal Resistant Trim Use w/Falcon XX, 18 and 25 Series Exit Devices	Stainless	VR810-DT US32D	630	-	-	1	1	\$301.50	-
		VR814-DT US32D	630	-	-	1	1	301.50	-
VR810NL/VR814NL Vandal Resistant Trim Use w/Falcon XX, and 18 Series Rim Exit Devices	Stainless	VR810-NL RHR US32D	630	-	-	1	1	301.50	-
		VR810-NL LHR US32D	630	-	-	1	1	301.50	-
		VR814-NL RHR US32D	630	-	-	1	1	301.50	-
		VR814-NL LHR US32D	630	-	-	1	1	301.50	-
VR810NL-V/VR814NL-V Vandal Resistant Trim Use w/ Falcon XX-V, and w/ 25-R (Rim) and 25-V (surface vertical) devices	Stainless	VR810-NL-V US32D	630	-	-	1	1	301.50	-
		VR814-NL-V US32D	630	-	-	1	1	301.50	-
AS895 Applied Stop 	Brass	AS895 US3	605	-	-	1	1	54.60	-
		AS895 US4	606	-	-	1	1	50.20	-
		AS895 US10	612	-	-	1	1	50.80	-
		AS895 US10B	613	-	-	1	1	54.60	-
		AS895 US26	625	-	-	1	1	54.60	-
		AS895 US26D	626	-	-	1	1	54.60	-
VR900/VR904 Vandal Resistant Trim Use w/Mortise Locks Outswing Doors	Stainless	VR900 LHR US32D	630	-	-	1	1	301.50	-
		VR900 RHR US32D**	630	-	-	1	1	301.50	-
		VR904 LHR US32D	630	-	-	1	1	301.50	-
		VR904 RHR US32D	630	-	-	1	1	301.50	-
VR900LLP/VR904LLP Vandal Resistant Trim Use w/Mortise Locks Inswing Doors LLP = Less Lock Protectors	Stainless	VR900-LLP LH US32D	630	-	-	1	1	301.50	-
		VR900-LLP RH US32D	630	-	-	1	1	301.50	-
		VR904-LLP LH US32D	630	-	-	1	1	301.50	-
		VR904-LLP RH US32D	630	-	-	1	1	301.50	-
VR910DT/VR914DT Vandal Resistant Trim Use w/Von Duprin 98/99 Series Rim and Verticle Exit Devices	Stainless	VR910-DT US32D**	630	-	-	1	1	301.50	-
		VR914-DT US32D	630	-	-	1	1	301.50	-
VR910NL/VR914NL Vandal Resistant Trim Use w/Von Duprin 98/99 Series Rim and Verticle Exit Devices	Stainless	VR910-NL US32D**	630	-	-	1	1	301.50	-
		VR914-NL US32D**	630	-	-	1	1	301.50	-
VR910M-DT/VR914M-DT Vandal Resistant Trim Use w/Von Duprin 98/9975 Series Mortise Exit Devices	Stainless	VR910M-DT US32D	630	-	-	1	1	301.50	-
		VR914M-DT US32D	630	-	-	1	1	301.50	-
VR910M-NL/VR914M-NL Vandal Resistant Trim Use w/Von Duprin 98/9975 Series Mortise Exit Devices	Stainless	VR910M-NL LHR US32D	630	-	-	1	1	301.50	-
		VR910M-NL RHR US32D	630	-	-	1	1	301.50	-
		VR914M-NL LHR US32D	630	-	-	1	1	301.50	-
		VR914M-NL RHR US32D	630	-	-	1	1	301.50	-
919 Flush Pull, Oval 4-23/32" High X 1-19/22" Wide x 15/32" Deep 	Brass	919-626	626	-	-	1	2	76.00	-
950 Flush Pull, Rectangular 3-3/4" High X 2-7/8" Wide x 11/16" Deep 	Brass	950-605	605	-	-	1	2	85.20	-
		950-613	613	-	-	1	2	89.00	-
		950-619	619	-	-	1	2	85.20	-
		950-625	625	-	-	1	2	85.20	-
		950-626**	626	-	-	1	2	68.20	-

HINGES
 CONTINUOUS HINGES
 PIVOTS
 Numerical 1-059
 Numerical 59-437
 Numerical 438-1021
 Numerical 1152-8190
 Numerical 8200-9266





Lead time exception: ** Products are stocked and will typically ship in 3-5 days

Bold pricing indicates item is in stock and available for **Fast Track** and **ProXpress**

	MODEL	SUBSTRATE	MODEL NUMBER	BHMA FINISH	WEIGHT	MUST BE ORDERED IN MULTIPLE QTY	MULTIPLE QTY	PACKED PER BOX	LIST PRICE		
									EACH	PACKAGE	
HINGES	955 Flush Pull, Rectangular 4-5/8" High X 3-29/32" Wide x 1-3/16" Deep 	Brass	955-613	613	-	-	1	2	144.10	-	
			955-626	626	-	-	1	2	110.10	-	
CONTINUOUS HINGES	960 Flush Pull, Rectangular 3-1/16" High X 1-7/8" Wide x 9/16" Deep 	Brass	960-605	605	-	-	1	2	38.10	-	
			960-613	613	-	-	1	2	39.30	-	
			960-619	619	-	-	1	2	38.10	-	
			960-625	625	-	-	1	2	38.10	-	
			960-626	626	-	-	1	2	30.10	-	
PIVOTS	962 Flush Pull, Rectangular Black Inset 3-15/16" High X 2-7/16" Wide x 19/32" Deep	Brass	962-613	613	-	-	1	2	81.10	-	
			962-626	626	-	-	1	2	62.80	-	
Numerical 1-059	990 Sliding Door Pull Doors 1-1/8" to 1-1/2" 	Aluminum	990A3	666	-	-	1	10	8.30	-	
			990A5	-	-	-	1	10	8.30	-	
			990A14	669	-	-	1	10	8.30	-	
			990A15**	670	-	-	1	10	9.20	-	
			990A26D	702	-	-	1	10	8.30	-	
			990A-643E/716	-	-	-	1	10	8.30	-	
		Brass	990B3	605	1.9	-	-	1	5	12.60	-
			990B-613**	613	1.9	-	-	1	5	14.60	-
			990B-619**	619	1.9	-	-	1	5	14.60	-
			990B26**	625	1.9	-	-	1	5	14.60	-
			990B26D	626	1.9	-	-	1	5	14.60	-
			990B-643E/716**	-	1.9	-	-	1	5	14.60	-
			990B-BLK	622	1.9	-	-	1	5	14.60	-
			Numerical 59-437	991 Sliding Door Pull Privacy Doors 1-1/8" to 1-1/2" Thumb Turn on One Side Emergency Turn on Other Side 	Aluminum	991A3	666	-	-	1	10
991A5	-	-				-	1	10	9.70	-	
991A14	669	-				-	1	10	11.20	-	
991A15**	670	-				-	1	10	11.20	-	
991A26D	702	-				-	1	10	11.20	-	
991A-643E/716	-	-				-	1	10	11.20	-	
Brass	991B3**	605			2.3	-	-	1	5	17.80	-
	991B-613**	613			2.3	-	-	1	5	20.30	-
	991B-619**	619			2.3	-	-	1	5	20.30	-
	991B26**	625			2.3	-	-	1	5	20.30	-
Numerical 438-1021			991B26D	626	2.3	-	1	5	20.30	-	
			991B-643E/716**	-	2.3	-	1	5	20.30	-	
			991B-BLK	622	2.3	-	-	1	5	20.30	-
Numerical 1152-8190											
Numerical 8200-9266											

Lead time exception: ** Products are stocked and will typically ship in 3-5 days

Bold pricing indicates item is in stock and available for **Fast Track** and **ProXpress**

MODEL	SUBSTRATE	MODEL NUMBER	BHMA FINISH	WEIGHT	MUST BE ORDERED IN MULTIPLE QTY	MULTIPLE QTY	PACKED PER BOX	LIST PRICE	
								EACH	PACKAGE
RL1152 Combination Roller Latch/Applied Stop 	Brass	RL1152 US3	605	-	-	-	-	\$148.30	-
		RL1152 US4	606	-	-	-	-	140.50	-
		RL1152 US10	612	-	-	-	-	140.50	-
		RL1152 US10B	613	-	-	-	-	148.30	-
		RL1152 US15	619	-	-	-	-	148.30	-
		RL1152 US26	625	-	-	-	-	148.30	-
		RL1152 US26D**	626	-	-	-	-	145.10	-
		RL1152 643E/716	-	-	-	-	-	148.30	-
		RL1152 BLK	622	-	-	-	-	148.30	-
FS1153/FS1154 Plunger Type Door Holder 	Aluminum	FS1153 US28**	628	-	-	-	-	52.00	-
	Brass	FS1154 US3	605	-	-	-	-	93.60	-
		FS1154 US4	606	-	-	-	-	93.60	-
		FS1154 US10	612	-	-	-	-	93.60	-
		FS1154 US10B	613	-	-	-	-	93.60	-
		FS1154 US26	625	-	-	-	-	93.60	-
		FS1154 US26D**	626	-	-	-	-	93.60	-
SB1600M1 Handle Up 1 1/2" Steel Bolt B-Packed w/Mortise Strikes T-Packed w/Universal Strikes L-Locking Version* UL Listed 	Steel	SB1600M1-B SP28	689	-	-	-	-	132.60	-
		SB1600M1-B SP10	691	-	-	-	-	140.20	-
		SB1600M1-B BLK	-	-	-	-	-	140.20	-
		SB1600M1-B SP313	695	-	-	-	-	132.60	-
		SB1600M1-B SP4	706	-	-	-	-	140.20	-
		SB1600M1-T SP10	691	-	-	-	-	140.20	-
		SB1600M1-T SP28	689	-	-	-	-	132.60	-
		SB1600M1-T SP313	695	-	-	-	-	132.60	-
		SB1600M1-T BLK	-	-	-	-	-	140.20	-
		SB1600M1-T SP4	706	-	-	-	-	140.20	-
		SB1600M1-BL SP10	691	-	-	-	-	186.30	-
		SB1600M1-BL SP28	689	-	-	-	-	193.10	-
		SB1600M1-BL SP313	695	-	-	-	-	193.10	-
		SB1600M1-BL BLK	-	-	-	-	-	193.90	-
		SB1600M1-BL SP4	706	-	-	-	-	186.30	-
		SB1600M1-TL SP10	691	-	-	-	-	193.90	-
		SB1600M1-TL SP28	689	-	-	-	-	193.90	-
		SB1600M1-TL SP313	695	-	-	-	-	186.30	-
		SB1600M1-TL BLK	-	-	-	-	-	186.30	-
		SB1600M1-TL SP4	706	-	-	-	-	193.90	-
SB1600M2 Handle Up 1 1/2" Steel Bolt B-Packed w/Mortise Strikes T-Packed w/Universal Strikes L-Locking Version* UL Listed 	Steel	SB1600M2-B SP4	706	-	-	-	-	140.20	-
		SB1600M2-B SP10	691	-	-	-	-	140.20	-
		SB1600M2-B SP28	689	-	-	-	-	132.60	-
		SB1600M2-B SP313	695	-	-	-	-	132.60	-
		SB1600M2-B BLK	-	-	-	-	-	140.20	-
		SB1600M2-BL SP4	706	-	-	-	-	193.90	-
		SB1600M2-T SP10	691	-	-	-	-	140.20	-
		SB1600M2-T SP28	689	-	-	-	-	132.60	-
		SB1600M2-T SP313	695	-	-	-	-	132.60	-
		SB1600M2-T BLK	-	-	-	-	-	140.20	-
		SB1600M2-T SP4	706	-	-	-	-	140.20	-
		SB1600M2-BL SP10	691	-	-	-	-	193.90	-
		SB1600M2-BL SP28	689	-	-	-	-	193.10	-
		SB1600M2-BL SP313	695	-	-	-	-	193.10	-
		SB1600M2-BL BLK	-	-	-	-	-	193.90	-
		SB1600M2-TL SP4	706	-	-	-	-	193.90	-
		SB1600M2-TL SP10	691	-	-	-	-	193.90	-
		SB1600M2-TL SP28	689	-	-	-	-	193.10	-
		SB1600M2-TL SP313	695	-	-	-	-	193.10	-
		SB1600M2-TL BLK	-	-	-	-	-	193.90	-



* Lock default code = 1289. Alternative Codes: 1360/1390/1395.

Lead time exception: ** Products are stocked and will typically ship in 3-5 days

Bold pricing indicates item is in stock and available for **Fast Track** and **ProXpress**

HINGES
 CONTINUOUS HINGES
 PIVOTS
 Numerical 1-059
 Numerical 59-437
 Numerical 438-1021
 Numerical 1152-8190
 Numerical 8200-9266



HINGES
 CONTINUOUS HINGES
 PIVOTS
 Numerical 1-059
 Numerical 59-437
 Numerical 438-1021
 Numerical 1152-8190
 Numerical 8200-9266

MODEL	SUBSTRATE	MODEL NUMBER	BHMA FINISH	WEIGHT	MUST BE ORDERED IN MULTIPLE QTY	MULTIPLE QTY	PACKED PER BOX	LIST PRICE	
								EACH	PACKAGE
SB1630 8" Steel Bolts B-Packed w/Mortise Strikes T-Packed w/Universal Strikes L-Locking Version* UL Listed 	Steel	SB1630-B US2G	603	-	-	-	-	\$44.80	-
		SB1630-B US10B	640	-	-	-	-	103.30	-
		SB1630-B US26D	652	-	-	-	-	63.90	-
		SB1630-T US2G	603	-	-	-	-	49.80	-
		SB1630-T US10B	640	-	-	-	-	108.30	-
		SB1630-T US26D	652	-	-	-	-	70.20	-
		SB1630-BL US2G	603	-	-	-	-	96.90	-
		SB1630-BL US10B	640	-	-	-	-	139.10	-
		SB1630-BL US26D	652	-	-	-	-	116.10	-
		SB1630-TL US2G	603	-	-	-	-	80.50	-
		SB1630-TL US10B	640	-	-	-	-	146.80	-
		SB1630-TL US26D	652	-	-	-	-	126.30	-
		SB1630-TB US2G	603	-	-	-	-	59.00	-
		SB1630-TB US10B	640	-	-	-	-	122.40	-
		SB1630-TB US26D	652	-	-	-	-	81.60	-
		SB1630-TBL US2G	603	-	-	-	-	93.10	-
SB1630-TBL US10B	640	-	-	-	-	158.00	-		
SB1630-TBL US26D	652	-	-	-	-	139.10	-		
SB1640 8" Steel Bolts B-Packed w/Mortise Strikes T-Packed w/Universal Strikes L-Locking Version* 	Brass	SB1640-B US3	605	-	-	-	-	126.30	-
		SB1640-B US10B	613	-	-	-	-	126.30	-
		SB1640-B US26D	626	-	-	-	-	113.60	-
		SB1640-T US3	605	-	-	-	-	132.60	-
		SB1640-T US10B	613	-	-	-	-	132.60	-
		SB1640-T US26D	626	-	-	-	-	122.40	-
		SB1640-BL US3	605	-	-	-	-	168.40	-
		SB1640-BL US10B	613	-	-	-	-	168.40	-
		SB1640-BL US26D	626	-	-	-	-	155.70	-
		SB1640-TL US3	605	-	-	-	-	177.30	-
SB1640-TL US10B	613	-	-	-	-	177.30	-		
SB1640-TL US26D	626	-	-	-	-	163.30	-		

* Lock default code = 1289. Alternative Codes: 1360/1390/1395.

Lead time exception: ** Products are stocked and will typically ship in 3-5 days

Bold pricing indicates item is in stock and available for **Fast Track** and **ProXpress**

MODEL	SUBSTRATE	MODEL NUMBER	VIEW NUMBER & FINISH	BHMA FINISH	WEIGHT	MUST BE ORDERED IN			LIST PRICE	
						MULTIPLE QTY	MULTIPLE QTY	PACKED PER BOX	EACH	PACKAGE
3125 Door Knocker 	Brass	02-3125-605	-	605	1	-	-	1	\$28.60	-
		02-3125-609	-	609	1	-	-	1	33.70	-
		02-3125-619	-	619	1	-	-	1	33.70	-
		02-3125-625	-	625	1	-	-	1	33.70	-
		02-3125-626	-	626	1	-	-	1	28.60	-
		02-3125-643E/716	-	-	1	-	-	1	33.70	-
		02-3125-BLK	-	622	1	-	-	1	33.70	-
31251/31252 Knocker/Viewer Available w/UL Viewer Only 	Brass	02-31251U-605	U700 w 606 viewer	605	-	-	-	1	41.60	-
		02-31251U-619	U700 w 619 viewer	619	-	-	-	1	47.40	-
		02-31251U-625	U700 w 625 viewer	625	-	-	-	1	47.40	-
		02-31251U-626	U700 w 626 viewer	626	-	-	-	1	47.40	-
		02-31251U-643E/716	U700 w 10B viewer	-	-	-	-	1	39.40	-
		02-31251U-BLK	U700 w BLK viewer	622	-	-	-	1	47.40	-
		02-31252U-605	U701 w 606 viewer	605	-	-	-	1	43.30	-
		02-31252U-619	U701 w 619 viewer	619	-	-	-	1	49.40	-
		02-31252U-625	U701 w 625 viewer	625	-	-	-	1	49.40	-
		02-31252U-626**	U701 w 626 viewer	626	-	-	-	1	49.40	-
		02-31252U-643E/716	U701 w 10B viewer	-	-	-	-	1	41.30	-
		02-31252U-BLK	U701 w BLK viewer	622	-	-	-	1	49.40	-

HINGES
 CONTINUOUS HINGES
 PIVOTS
 Numerical 1-059
 Numerical 59-437
 Numerical 438-1021
 Numerical 1152-8190
 Numerical 8200-9266

Lead time exception: ** Products are stocked and will typically ship in 3-5 days Bold pricing indicates item is in stock and available for **Fast Track** and **ProXpress**

8100/8300/9100/9200 Series Pulls

8169/8181/8281/8189/8312/8320/8371/8372/8373/8700/8800/8848/8975 - Decorative Series

Mounting Methods

HINGES
 CONTINUOUS HINGES
 PIVOTS
 Numerical 1-059
 Numerical 59-437
 Numerical 438-1021
 Numerical 1152-8190
 Numerical 8200-9266

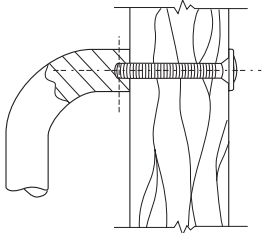
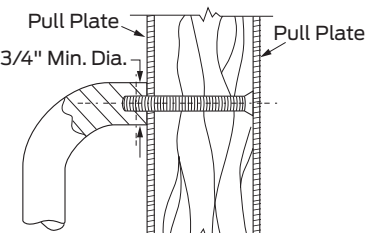
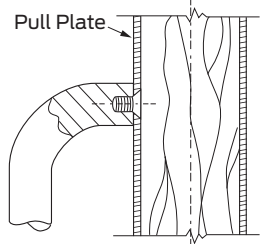
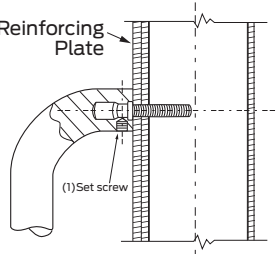
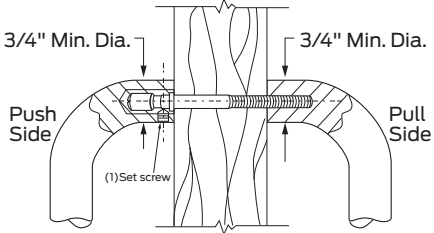
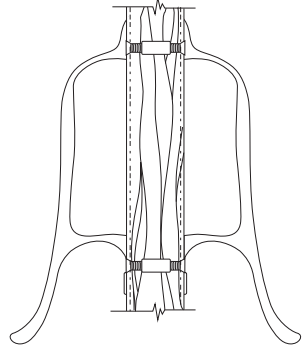
<p>Type Standard Mount</p>  <p>Standard Mounting</p>	<p>Type F Mount</p>  <p>Wood Doors Concealed Pull Mounting With Push Plate</p>	<p>Type G Mount</p>  <p>Concealed Pull Plate Mounting</p>
<p>Type L Mount</p>  <p>Reinforced Hollow Metal Door Concealed Pull Mounting</p>	<p>Type J or N Mount</p>  <p>Back to Back "Two-Anchor" Wood or Metal Door</p>	 <p>Back to Back Pull Mounting</p>

Lead time exception: ** Products are stocked and will typically ship in 3-5 days

Bold pricing indicates item is in stock and available for **Fast Track** and **ProXpress**

8100/8300/9100/9200 Series Pulls

8169/8181/8281/8189/8312/8320/8371/8372/8373/8700/8800/8848/8975 - Decorative Series

Mounting Methods

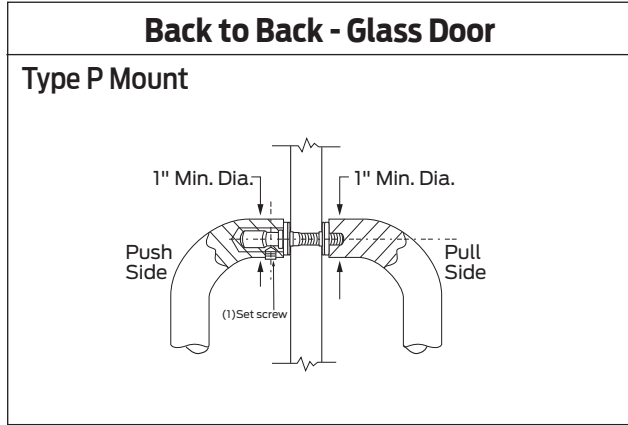
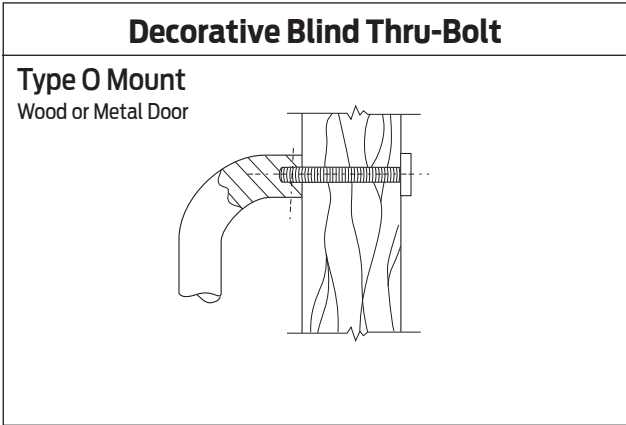

HINGES
CONTINUOUS HINGES
PIVOTS
Numerical 1-059
Numerical 59-437
Numerical 438-1021
Numerical 1152-8190
Numerical 8200-9266

*Lead time exception: ** Products are stocked and will typically ship in 3-5 days*

*Bold pricing indicates item is in stock and available for **Fast Track** and **ProXpress***

8100/8200/8300/9100/9200 - Series

8169/8181/8281/8189/8312/8320/8371/8372/8373/8700/8800/8848/8975 - Decorative Series

Special Pricing Information

- Through bolt fasteners are for standard 1-3/4" thick doors.
- Specify door thickness if other than standard. \$25 List Add for door thicknesses greater than 2 1/4".
- All screws are furnished standard as Phillips Head Drive.
- For fasteners other than shown contact our Customer Service Department for availability.

	Suffix		List Add	
Optional Mounting Types:	No Suffix Req'd	Standard (Provided with all single pulls unless other mount noted.)	8102HD, 8103HD, 8103EZHD, 8105, 8111-5, 8145EZHD, 8190HD, 8190EZHD, 8302, 8303, 8305, 8311, 9100HD, 9264, 9266 <i>8169, 8181, 8281, 8189, 8312, 8320, 8371, 8372, 8373, 8700, 8800, 8848, 8975</i>	No Additional Charge
	A	Concealed (One side, Aluminum)	8103HD, 8103EZHD, 8145EZHD, 8190HD, 8190EZHD, 8303, 9100HD, 9264, 9266 <i>8169, 8181, 8281, 8189, 8312, 8320, 8371, 8848, 8975</i>	18.00
	F	Countersunk Thru Bolt	8102HD, 8103HD, 8103EZHD, 8105, 8111-5, 8145EZHD, 8190HD, 8190EZHD, 8302, 8303, 8305, 8311, 9100HD <i>8169, 8181, 8281, 8189, 8312, 8320, 8371, 8372, 8373, 8700, 8800, 8848, 8975</i>	No Additional Charge
	G	Concealed Pull Plate	8102, 8103, 8111, 8300, 8302, 8303, 8311	No Additional Charge
	I	Concealed (One Side, Wood Door)	8102HD, 8103HD, 8103EZHD, 8145EZHD, 8190HD, 8190EZHD, 8302, 8303, 9100HD, 9264, 9266 <i>8169, 8181, 8281, 8189, 8312, 8320, 8371, 8372, 8373, 8700, 8800, 8848, 8975</i>	13.00
	J*	Back to Back (Wood/Hollow Metal - 3/4" Round and Flat)	8102HD, 8302 <i>8372, 8373, 8700, 8800</i>	26.00
	K*	Back to Back (8121)	8121	9.00
	L	Concealed (One Side, Hollow Metal)	8103HD, 8103EZHD, 8145EZHD, 8190HD, 8190EZHD, 8303, 9100HD, 9264, 9266 <i>8169, 8181, 8281, 8189, 8312, 8320, 8371, 8372, 8373, 8700, 8800, 8848, 8975</i>	18.00
	N*	Back to Back (Wood/Hollow Metal - 1" Round)	8103HD, 8103EZHD, 8145EZHD, 8190HD, 8190EZHD, 8303, 9100HD, 9264, 9266 <i>8169, 8181, 8281, 8189, 8312, 8320, 8371, 8848, 8975</i>	26.00
	NO	Push Bar and Pull - Back to Back & Decorative Blind Thru Bolt (Wood/Hollow Metal)	9100HD, 9103EZHD, 9145EZHD, 9190HD, 9190EZHD	39.00
	NS	Push Bar and Pull - Back to Back & Standard (Wood/Hollow Metal)	9100HD, 9103EZHD, 9145EZHD, 9190HD, 9190EZHD	No Additional Charge
	O	Decorative Blind Thru Bolt (Wood/Hollow Metal)	8103HD, 8103EZHD, 8145EZHD, 8190HD, 8190EZHD, 9100HD, 9264, 9266 <i>8169, 8181, 8281, 8189, 8312, 8320, 8371, 8848, 8975</i>	30.00
	P*	Back to Back (1/2" Glass)	8103HD, 8103EZHD, 8145EZHD, 8190HD, 8190EZHD, 9100HD, 9264, 9266 <i>8169, 8181, 8281, 8189, 8312, 8320, 8371, 8848, 8975</i>	31.00
	PQ	Push Bar and Pull - Back to Back and Decorative Blind Thru Bolt (1/2" Glass)	9100HD, 9103EZHD, 9145EZHD, 9190HD, 9190EZHD	65.00
	Q	Decorative Blind Thru Bolt (1/2" Glass)	8103HD, 8103EZHD, 8145EZHD, 8190HD, 8190EZHD, 9100HD, 9264, 9266 <i>8169, 8181, 8281, 8189, 8312, 8320, 8371, 8848, 8975</i>	42.00
	X	Security Thru Bolt with Std. Washer.	8103HD, 8103EZHD, 8145EZHD, 8190HD, 8190EZHD, 8303, 9100HD, 9264, 9266 <i>8169, 8181, 8281, 8189, 8312, 8320, 8371, 8848, 8975</i>	50.00 - 613/US10B 32.00 all other Finishes
	Prefix			
	*	PR	Order as pair with model numbers (e.g. - PR8103EZ)	Double the list price for single unit and add mounting price from above.
		SGL	Single pull model machined for back to back application.	Based on mounting
	Model			
Optional Custom Lengths: (available in 1" increments, fractional increments available as engineered specials)		For lengths <28"		Same as 28" List Price
	9100HD, 9103EZHD, 9145EZHD, 9190HD, 9190EZHD	For lengths >28" and <33"		Same as 33" List Price
		For lengths >33"		9.00/additional inch
		Fractional increments available as engineered specials. List Add in addition to custom length pricing		169.00 List Add
Optional Finish	AM	Anti-microbial Coating - US26D or US32D finishes only		37.00
Optional Cut-Outs:	CFC	Cut for cylinder on 8200/8300 Series Push or Pull Plates (1-1/4" diameter)		6.50
	CFT	Cut for Thumbturn on 8200/8300 Series Push or Pull Plates (3/8" diameter)		7.50
Plates ordered for cut-out for cylinder or thumbturn, cutout is positioned 2" from top and centered in the plate width, up to 4" wide plates. For plates over 4" in width, cut-out is located 2" from edge. Please specify Door Handing LH or RH when ordering plates wider than 4".				
	Model	Description		List Add
Optional Plate:	8300	For plate pierced for Pull, order 8300 Series Specify Center to Center dimension (5-1/4", 6", 8", 10"), Finish, and Plate Size		(to 8200 list price) 2.50

Lead time exception: ** Products are stocked and will typically ship in 3-5 days

Bold pricing indicates item is in stock and available for **Fast Track** and **ProXpress**

HINGES

CONTINUOUS HINGES

PIVOTS

Numerical 1-059

Numerical 59-437

Numerical 438-1021

Numerical 1152-8190

Numerical 8200-9266

MODEL	PULL CTC	SUBSTRATE	MODEL NUMBER	BHMA FINISH	WEIGHT	MUST BE ORDERED IN MULTIPLE QTY	MULTIPLE QTY	PACKED PER BOX	LIST PRICE	
									EACH	PACKAGE
8102HD Straight Door Pull 3/4" Round, 1-1/2" Clearance Antimicrobial Coating US26D-AM or US32D-AM available. See page 64 for optional mounting types and pricing.	6"	Brass	8102HD-6 US3	605	-	-	1	-	\$50.30	-
			8102HD-6 US4	606	-	-	1	-	50.30	-
			8102HD-6 US10	612	-	-	1	-	57.40	-
			8102HD-6 US10B	613	-	-	1	-	59.40	-
			8102HD-6 US15	619	-	-	1	-	59.40	-
			8102HD-6 US26	625	-	-	1	-	56.60	-
		8102HD-6 US26D	626	-	-	1	-	50.30	-	
		Aluminum	8102HD-6 US28	628	-	-	1	-	20.10	-
		Stainless	8102HD-6 US32D**	630	-	-	1	-	30.40	-
	8102HD-6 643E/716		-	-	-	1	-	59.40	-	
	8102HD-6 BLK		-	-	-	1	-	50.30	-	
	8"	Brass	8102HD-8 US3	605	-	-	1	-	56.60	-
			8102HD-8 US4	606	-	-	1	-	56.60	-
			8102HD-8 US10	612	-	-	1	-	64.90	-
			8102HD-8 US10B	613	-	-	1	-	67.10	-
			8102HD-8 US15	619	-	-	1	-	67.10	-
			8102HD-8 US26	625	-	-	1	-	62.90	-
		8102HD-8 US26D	626	-	-	1	-	56.60	-	
		Aluminum	8102HD-8 US28	628	-	-	1	-	20.90	-
		Stainless	8102HD-8 US32D	630	-	-	1	-	34.30	-
			8102HD-8 643E/716	-	-	-	1	-	67.10	-
			8102HD-8 BLK	-	-	-	1	-	56.60	-
		10"	Brass	8102HD-0 US3	605	-	-	1	-	66.10
	8102HD-0 US4			606	-	-	1	-	66.10	-
	8102HD-0 US10			612	-	-	1	-	76.20	-
	8102HD-0 US10B			613	-	-	1	-	78.20	-
	8102HD-0 US15			619	-	-	1	-	78.20	-
8102HD-0 US26	625			-	-	1	-	64.50	-	
8102HD-0 US26D	626		-	-	1	-	64.90	-		
Aluminum	8102HD-0 US28		628	-	-	1	-	22.30	-	
Stainless	8102HD-0 US32D		630	-	-	1	-	40.20	-	
	8102HD-0 643E/716		-	-	-	1	-	78.20	-	
	8102HD-0 BLK		-	-	-	1	-	66.10	-	
8103HD Straight Door Pull 1" Round, 1-1/2" Clearance Antimicrobial Coating US26D-AM or US32D-AM available. See page 64 for optional mounting types and pricing.	8"		Brass	8103HD-8 US3	605	-	-	1	-	100.50
		8103HD-8 US4		606	-	-	1	-	100.50	-
		8103HD-8 US10		612	-	-	1	-	113.10	-
		8103HD-8 US10B		613	-	-	1	-	117.20	-
		8103HD-8 US15		619	-	-	1	-	117.20	-
		8103HD-8 US26		625	-	-	1	-	107.00	-
		8103HD-8 US26D	626	-	-	1	-	100.90	-	
		Aluminum	8103HD-8 US28	628	-	-	1	-	29.10	-
		Stainless	8103HD-8 US32	629	-	-	1	-	72.30	-
			8103HD-8 US32D	630	-	-	1	-	59.70	-
			8103HD-8 643E/716	-	-	-	1	-	117.20	-
		8103HD-8 BLK	-	-	-	1	-	100.50	-	
	10"	Brass	8103HD-0 US3	605	-	-	1	-	111.00	-
			8103HD-0 US4	606	-	-	1	-	111.00	-
			8103HD-0 US10	612	-	-	1	-	127.70	-
			8103HD-0 US10B	613	-	-	1	-	127.70	-
			8103HD-0 US15	619	-	-	1	-	132.00	-
			8103HD-0 US26	625	-	-	1	-	117.20	-
		8103HD-0 US26D	626	-	-	1	-	111.00	-	
		Aluminum	8103HD-0 US28	628	-	-	1	-	30.60	-
		Stainless	8103HD-0 US32	629	-	-	1	-	80.30	-
			8103HD-0 US32D**	630	-	-	1	-	67.00	-
			8103HD-0 643E/716	-	-	-	1	-	127.70	-
		8103HD-0 BLK	-	-	-	1	-	111.00	-	

Continued on next page.

Lead time exception: ** Products are stocked and will typically ship in 3-5 days

Bold pricing indicates item is in stock and available for **Fast Track** and **ProXpress**

HINGES
 CONTINUOUS HINGES
 PIVOTS
 Numerical 1-059
 Numerical 59-437
 Numerical 438-1021
 Numerical 1152-8190
 Numerical 8200-9266

HINGES

CONTINUOUS HINGES

PIVOTS



Numerical 1-059

Numerical 59-437

Numerical 438-1021

Numerical 1152-8190

Numerical 8200-9266

MODEL	PULL CTC	SUBSTRATE	MODEL NUMBER	BHMA FINISH	WEIGHT	MUST BE ORDERED IN MULTIPLE QTY	MULTIPLE QTY	PACKED PER BOX	LIST PRICE			
									EACH	PACKAGE		
8103HD Straight Door Pull 1" Round, 1-1/2" Clearance 	12"	Brass	8103HD-2 US3	605	-	-	1	-	\$121.30	-		
			8103HD-2 US4	606	-	-	1	-	121.30	-		
			8103HD-2 US10	612	-	-	1	-	142.20	-		
			8103HD-2 US10B	613	-	-	1	-	144.60	-		
			8103HD-2 US15	619	-	-	1	-	144.60	-		
			8103HD-2 US26	625	-	-	1	-	128.90	-		
			8103HD-2 US26D	626	-	-	1	-	123.60	-		
		Aluminum	8103HD-2 US28	628	-	-	1	-	32.20	-		
		Stainless	8103HD-2 US32	629	-	-	1	-	88.10	-		
			8103HD-2 US32D	630	-	-	1	-	77.10	-		
8103HD-2 643E/716	-		-	-	1	-	144.60	-				
			8103HD-2 BLK	-	-	-	1	121.30	-			
8103EZHD Straight Door Pull 1" Round, 2-1/2" Clearance Antimicrobial Coating US26D-AM or US32D-AM available. See page 64 for optional mounting types and pricing. 	8"	Brass	8103EZHD-8 US3	605	-	-	1	-	109.40	-		
			8103EZHD-8 US4	606	-	-	1	-	109.40	-		
			8103EZHD-8 US10	612	-	-	1	-	121.70	-		
			8103EZHD-8 US10B	613	-	-	1	-	125.70	-		
			8103EZHD-8 US15	619	-	-	1	-	125.70	-		
			8103EZHD-8 US26	625	-	-	1	-	115.30	-		
			8103EZHD-8 US26D	626	-	-	1	-	109.60	-		
			Aluminum	8103EZHD-8 US28	628	-	-	1	-	39.10	-	
		316 Stainless	8103EZHD-8 US32	629-316	-	-	1	-	95.90	-		
			8103EZHD-8 US32D	630-316	-	-	1	-	83.60	-		
			8103EZHD-8 643E/716	-	-	-	1	-	125.70	-		
			8103EZHD-8 BLK	-	-	-	1	-	109.40	-		
			10"	Brass	8103EZHD-0 US3	605	-	-	1	-	119.60	-
					8103EZHD-0 US4	606	-	-	1	-	119.60	-
	8103EZHD-0 US10	612			-	-	1	-	136.30	-		
	8103EZHD-0 US10B	613			-	-	1	-	140.50	-		
	8103EZHD-0 US15	619			-	-	1	-	140.50	-		
	8103EZHD-0 US26	625			-	-	1	-	125.70	-		
	Aluminum	8103EZHD-0 US26D	626	-	-	1	-	119.60	-			
	316 Stainless	8103EZHD-0 US28	628	-	-	1	-	40.90	-			
		8103EZHD-0 32-316	629-316	-	-	1	-	105.20	-			
		8103EZHD-0 32D-316	630-316	-	-	1	-	92.60	-			
		8103EZHD-0 643E/716	-	-	-	1	-	140.50	-			
		8103EZHD-0 BLK	-	-	-	1	-	119.60	-			
	12"	Brass	8103EZHD-2 US3	605	-	-	1	-	129.90	-		
			8103EZHD-2 US4	606	-	-	1	-	129.90	-		
			8103EZHD-2 US10	612	-	-	1	-	151.00	-		
			8103EZHD-2 US10B	613	-	-	1	-	153.10	-		
8103EZHD-2 US15			619	-	-	1	-	153.10	-			
8103EZHD-2 US26			625	-	-	1	-	137.60	-			
8103EZHD-2 US26D			626	-	-	1	-	132.30	-			
Aluminum			8103EZHD-2 US28	628	-	-	1	-	42.60	-		
316 Stainless		8103EZHD-2 32-316	629-316	-	-	1	-	114.40	-			
		8103EZHD-2 32D-316	630-316	-	-	1	-	101.40	-			
		8103EZHD-2 643E/716	-	-	-	1	-	153.10	-			
		8103EZHD-2 BLK	-	-	-	1	-	129.90	-			

Lead time exception: ** Products are stocked and will typically ship in 3-5 days

Bold pricing indicates item is in stock and available for **Fast Track** and **ProXpress**



MODEL	PULL CTC	SUBSTRATE	MODEL NUMBER	BHMA FINISH	WEIGHT	MUST BE ORDERED IN MULTIPLE QTY	MULTIPLE QTY	PACKED PER BOX	LIST PRICE	
									EACH	PACKAGE
8105 Straight Door Pull 1" Flattened 1/2 Round, 1-1/2" Clearance Antimicrobial Coating US26D-AM or US32D-AM available. See page 64 for optional mounting types and pricing.	6"	Brass	8105-6 US3	605	-	-	1	-	\$54.80	-
			8105-6 US4	606	-	-	1	-	54.80	-
			8105-6 US10	612	-	-	1	-	67.30	-
			8105-6 US10B	613	-	-	1	-	69.10	-
			8105-6 US15	619	-	-	1	-	69.10	-
			8105-6 US26	625	-	-	1	-	55.20	-
			8105-6 US26D	626	-	-	1	-	50.40	-
		Aluminum	8105-6 US28	628	-	-	1	-	22.90	-
		Stainless	8105-6 US32D	630	-	-	1	-	41.80	-
	8105-6 643E/716		-	-	-	1	-	69.10	-	
	8105-6 BLK		-	-	-	1	-	54.80	-	
	8"	Brass	8105-8 US3	605	-	-	1	-	85.20	-
			8105-8 US4	606	-	-	1	-	85.20	-
			8105-8 US10	612	-	-	1	-	92.60	-
			8105-8 US10B	613	-	-	1	-	92.60	-
			8105-8 US15	619	-	-	1	-	92.60	-
			8105-8 US26	625	-	-	1	-	88.80	-
			8105-8 US26D	626	-	-	1	-	88.80	-
		Aluminum	8105-8 US28	628	-	-	1	-	28.60	-
		Stainless	8105-8 US32D	630	-	-	1	-	61.00	-
	8105-8 643E/716		-	-	-	1	-	92.60	-	
8105-8 BLK	-		-	-	1	-	85.20	-		
10"	Brass	8105-0 US3	605	-	-	1	-	92.60	-	
		8105-0 US4	606	-	-	1	-	92.60	-	
		8105-0 US10	612	-	-	1	-	103.60	-	
		8105-0 US10B	613	-	-	1	-	103.60	-	
		8105-0 US15	619	-	-	1	-	103.60	-	
		8105-0 US26	625	-	-	1	-	96.30	-	
		8105-0 US26D	626	-	-	1	-	96.30	-	
	Aluminum	8105-0 US28	628	-	-	1	-	29.50	-	
	Stainless	8105-0 US32D	630	-	-	1	-	68.60	-	
8105-0 643E/716		-	-	-	1	-	103.60	-		
8105-0 BLK		-	-	-	1	-	92.60	-		
8111 Door Pull 1-3/16" Projection Antimicrobial Coating US26D-AM or US32D-AM available. See page 64 for optional mounting types and pricing.	5" (Actual CTC = 5-1/4")	Brass	8111-5 US3	605	-	-	1	-	51.90	-
			8111-5 US4	606	-	-	1	-	51.90	-
			8111-5 US10	612	-	-	1	-	58.00	-
			8111-5 US10B	613	-	-	1	-	58.00	-
			8111-5 US15	619	-	-	1	-	58.00	-
			8111-5 US26	625	-	-	1	-	51.90	-
			8111-5 US26D	626	-	-	1	-	55.50	-
		Aluminum	8111-5 US28	628	-	-	1	-	32.30	-
		Stainless	8111-5 US32D	630	-	-	1	-	48.00	-
			8111-5 643E/716	613	-	-	1	-	58.00	-
			8111-5 BLK	605	-	-	1	-	51.90	-
8112 Door Pull 2-3/16" Antimicrobial Coating US26D-AM available. Surface Mounted	5"	Brass	8112-5 US26D**	626	-	-	1	-	40.60	-

HINGES
 CONTINUOUS HINGES
 PIVOTS
 Numerical 1-059
 Numerical 59-437
 Numerical 438-1021
 Numerical 1152-8190
 Numerical 8200-9266

Lead time exception: ** Products are stocked and will typically ship in 3-5 days



Bold pricing indicates item is in stock and available for **Fast Track** and **ProXpress**

HINGES
 CONTINUOUS HINGES
 PIVOTS
 Numerical 1-059
 Numerical 59-437
 Numerical 438-1021
 Numerical 1152-8190
 Numerical 8200-9266

MODEL	PULL CTC	SUBSTRATE	MODEL NUMBER	BHMA FINISH	WEIGHT	MUST BE ORDERED IN MULTIPLE QTY	MULTIPLE QTY	PACKED PER BOX	LIST PRICE	
									EACH	PACKAGE
8121 Door Pull 3-1/2" Antimicrobial Coating US26D-AM available. Surface Mounted  See page 64 for optional mounting types and pricing.	5"	Brass	8121-5 US26D	626	-	-	1	-	\$59.10	-
			8145EZHD-8 US3	605	-	-	1	-	125.00	-
8145EZHD 45 Offset Door Pull 1" Round, 2-1/2" Clearance Antimicrobial Coating US26D-AM or US32D-AM available. See page 64 for optional mounting types and pricing.	8"	Brass	8145EZHD-8 US4	606	-	-	1	-	125.00	-
			8145EZHD-8 US10	612	-	-	1	-	144.30	-
			8145EZHD-8 US10B	613	-	-	1	-	144.30	-
			8145EZHD-8 US15	619	-	-	1	-	144.30	-
			8145EZHD-8 US26	625	-	-	1	-	132.50	-
			8145EZHD-8 US26D	626	-	-	1	-	132.50	-
	316 Stainless	8145EZHD-8 32-316	629-316	-	-	1	-	131.50	-	
		8145EZHD-8 32D-316	630-316	-	-	1	-	108.40	-	
		8145EZHD-8 643E/716	-	-	-	1	-	144.30	-	
		8145EZHD-8 BLK	-	-	-	1	-	125.00	-	
	10"	Brass	8145EZHD-0 US3	605	-	-	1	-	136.40	-
			8145EZHD-0 US4	606	-	-	1	-	136.40	-
			8145EZHD-0 US10	612	-	-	1	-	152.40	-
			8145EZHD-0 US10B	613	-	-	1	-	152.40	-
			8145EZHD-0 US15	619	-	-	1	-	152.40	-
			8145EZHD-0 US26	625	-	-	1	-	144.30	-
	316 Stainless	8145EZHD-0 US26D	626	-	-	1	-	144.30	-	
		8145EZHD-0 32-316	629-316	-	-	1	-	140.70	-	
		8145EZHD-0 32D-316	630-316	-	-	1	-	117.70	-	
		8145EZHD-0 643E/716	-	-	-	1	-	152.40	-	
	12"	Brass	8145EZHD-2 US3	605	-	-	1	-	144.30	-
			8145EZHD-2 US4	606	-	-	1	-	144.30	-
			8145EZHD-2 US10	612	-	-	1	-	164.00	-
			8145EZHD-2 US10B	613	-	-	1	-	164.00	-
8145EZHD-2 US15			619	-	-	1	-	164.00	-	
8145EZHD-2 US26			625	-	-	1	-	156.40	-	
316 Stainless	8145EZHD-2 US26D	626	-	-	1	-	156.40	-		
	8145EZHD-2 32-316	629-316	-	-	1	-	150.00	-		
	8145EZHD-2 32D-316	630-316	-	-	1	-	127.00	-		
	8145EZHD-2 643E/716	-	-	-	1	-	164.00	-		
18"	Brass	8145EZHD-2 BLK	-	-	-	1	-	144.30	-	
		8145EZHD-18 US3	605	-	-	1	-	195.30	-	
		8145EZHD-18 US4	606	-	-	1	-	195.30	-	
		8145EZHD-18 US10	612	-	-	1	-	218.70	-	
		8145EZHD-18 US10B	613	-	-	1	-	218.70	-	
		8145EZHD-18 US15	619	-	-	1	-	218.70	-	
316 Stainless	8145EZHD-18 US26	625	-	-	1	-	206.80	-		
	8145EZHD-18 US26D	626	-	-	1	-	206.80	-		
	8145EZHD-18 32-316	629-316	-	-	1	-	202.90	-		
	8145EZHD-18 32D-316	630-316	-	-	1	-	180.10	-		
8169 Tubular Decorative C Shaped Pull 1" Dia. See page 64 for optional mounting types and pricing. 	10"	Brass	8169-10-605	605	-	-	1	-	298.60	-
			8169-10-613	613	-	-	1	-	298.60	-
			8169-10-619*	619	-	-	1	-	298.60	-
			8169-10-625*	625	-	-	1	-	298.60	-
			8169-10-626*	626	-	-	1	-	298.60	-
			8169-10-630	630	-	-	1	-	265.50	-
	12"	Brass	8169-10-BLK	-	-	-	1	-	298.60	-
			8169-12-605	605	-	-	1	-	391.60	-
			8169-12-613*	613	-	-	1	-	391.60	-
			8169-12-619*	619	-	-	1	-	391.60	-
			8169-12-625*	625	-	-	1	-	391.60	-
			8169-12-626*	626	-	-	1	-	391.60	-
Stainless	8169-12-630	630	-	-	1	-	274.70	-		
	8169-12-BLK*	-	-	-	1	-	391.60	-		

Lead time exception: ** Products are stocked and will typically ship in 3-5 days
 *Finishes marked may date up to 4-5 weeks for shipment.

Bold pricing indicates item is in stock and available for **Fast Track** and **ProXpress**

MODEL	PULL CTC	SUBSTRATE	MODEL NUMBER	BHMA FINISH	WEIGHT	MUST BE ORDERED IN MULTIPLE QTY	MULTIPLE QTY	PACKED PER BOX	LIST PRICE		
									EACH	PACKAGE	
8181 Georgian Decorative Offset Pull 3/4" Dia. See page 64 for optional mounting types and pricing. 	12"	Brass	8181-12-605	605	-	-	1	-	474.80	-	
			8181-12-613	613	-	-	1	-	474.80	-	
			8181-12-619*	619	-	-	1	-	474.80	-	
			8181-12-625*	625	-	-	1	-	474.80	-	
			8181-12-626*	626	-	-	1	-	474.80	-	
		Aluminum	8181-12-628*	628	-	-	1	-	446.40	-	
		Stainless	8181-12-630	630	-	-	1	-	457.70	-	
			8181-12-BLK*	-	-	-	1	-	474.80	-	
	16"	Brass	8181-16-605	605	-	-	1	-	532.60	-	
			8181-16-613	613	-	-	1	-	532.60	-	
			8181-16-619*	619	-	-	1	-	532.60	-	
			8181-16-625*	625	-	-	1	-	532.60	-	
			8181-16-626*	626	-	-	1	-	532.60	-	
		Aluminum	8181-16-628*	628	-	-	1	-	533.30	-	
		Stainless	8181-16-630	630	-	-	1	-	532.60	-	
			8181-16-BLK*	-	-	-	1	-	532.60	-	
	18"	Brass	8181-18-605	605	-	-	1	-	561.60	-	
			8181-18-613	613	-	-	1	-	561.60	-	
			8181-18-619*	619	-	-	1	-	561.60	-	
			8181-18-625*	625	-	-	1	-	561.60	-	
			8181-18-626*	626	-	-	1	-	561.60	-	
		Aluminum	8181-18-628*	628	-	-	1	-	562.20	-	
		Stainless	8181-18-630	630	-	-	1	-	561.60	-	
			8181-18-BLK*	-	-	-	1	-	561.60	-	
8189 Athens Decorative Offset Long Pull - 1 1/4" Dia. See page 64 for optional mounting types and pricing. Custom lengths available as engineered special. 	19 13/16"	Brass	8189-19-605*	605	-	-	1	-	1201.50	-	
			8189-19-613*	613	-	-	1	-	1249.40	-	
			8189-19-619*	619	-	-	1	-	1327.40	-	
			8189-19-625*	625	-	-	1	-	1327.40	-	
			8189-19-626*	626	-	-	1	-	1327.40	-	
		Stainless	8189-19-630*	630	-	-	1	-	754.10	-	
			8189-19-BLK*	-	-	-	1	-	1327.40	-	
8190HD 90° Offset Door Pull 1" Round, 2-1/4" Clearance Antimicrobial Coating US26D-AM or US32D-AM available. See page 64 for optional mounting types and pricing. 	8"	Brass	8190HD-8 US3	605	-	-	1	-	118.40	-	
			8190HD-8 US4	606	-	-	1	-	118.40	-	
			8190HD-8 US10	612	-	-	1	-	136.90	-	
			8190HD-8 US10B	613	-	-	1	-	136.90	-	
			8190HD-8 US15	619	-	-	1	-	136.90	-	
			8190HD-8 US26	625	-	-	1	-	125.60	-	
			8190HD-8 US26D	626	-	-	1	-	125.60	-	
		Stainless	8190HD-8 US32	629	-	-	1	-	105.40	-	
			8190HD-8 US32D	630	-	-	1	-	87.00	-	
			8190HD-8 643E/716	-	-	-	1	-	136.90	-	
			8190HD-8 BLK	-	-	-	1	-	118.40	-	
	10"	Brass	8190HD-0 US3	605	-	-	1	-	129.40	-	
			8190HD-0 US4	606	-	-	1	-	129.40	-	
			8190HD-0 US10	612	-	-	1	-	144.30	-	
			8190HD-0 US10B**	613	-	-	1	-	138.60	-	
			8190HD-0 US15	619	-	-	1	-	144.30	-	
			8190HD-0 US26	625	-	-	1	-	136.90	-	
			8190HD-0 US26D**	626	-	-	1	-	131.20	-	
		Stainless	8190HD-0 US32	629	-	-	1	-	112.80	-	
			8190HD-0 US32D**	630	-	-	1	-	90.50	-	
			8190HD-0 643E/716	-	-	-	1	-	138.60	-	
			8190HD-0 BLK	-	-	-	1	-	129.40	-	
	12"	Brass	8190HD-2 US3	605	-	-	1	-	136.90	-	
			8190HD-2 US4	606	-	-	1	-	136.90	-	
			8190HD-2 US10	612	-	-	1	-	155.40	-	
			8190HD-2 US10B	613	-	-	1	-	155.40	-	
			8190HD-2 US15	619	-	-	1	-	155.40	-	
			8190HD-2 US26	625	-	-	1	-	148.20	-	
8190HD-2 US26D			626	-	-	1	-	148.20	-		
Stainless		8190HD-2 US32	629	-	-	1	-	120.40	-		
		8190HD-2 US32D**	630	-	-	1	-	97.60	-		
		8190HD-2 643E/716	-	-	-	1	-	155.40	-		
		8190HD-2 BLK	-	-	-	1	-	136.90	-		
18"	Brass	8190HD-18 US3	605	-	-	1	-	185.00	-		
		8190HD-18 US4	606	-	-	1	-	185.00	-		
		8190HD-18 US10	612	-	-	1	-	207.30	-		
		8190HD-18 US10B	613	-	-	1	-	207.30	-		
		8190HD-18 US15	619	-	-	1	-	207.30	-		
		8190HD-18 US26	625	-	-	1	-	196.00	-		
		8190HD-18 US26D	626	-	-	1	-	196.00	-		
	Stainless	8190HD-18 US32	629	-	-	1	-	162.60	-		
		8190HD-18 US32D	630	-	-	1	-	138.60	-		
		8190HD-18 643E/716	-	-	-	1	-	207.30	-		
		8190HD-18 BLK	-	-	-	1	-	185.00	-		

HINGES
 CONTINUOUS HINGES
 PIVOTS
 Numerical 1-059
 Numerical 59-437
 Numerical 438-1021
 Numerical 1152-8190
 Numerical 8200-9266

Lead time exception: ** Products are stocked and will typically ship in 3-5 days

*Finishes marked may date up to 4-5 weeks for shipment.

Bold pricing indicates item is in stock and available for **Fast Track** and **ProXpress**

Additional 8190 Pulls Available in Fast Track and ProXpress				
MODELNUMBER	DESCRIPTION	SIZE	FINISH	Price
8190HD-0	90 Degree Offset Door Pull 1-3/4" (Mounting Type O)	10"	US32D	\$120.50
8190HD-2	90 Degree Offset Door Pull 1-3/4" (Mounting Type O)	12"	US32D	127.60

MODEL	PULL CTC	SUBSTRATE	MODEL NUMBER	BHMA FINISH	WEIGHT	MUST BE ORDERED IN MULTIPLE QTY	MULTIPLE QTY	PACKED PER BOX	LIST PRICE	
									EACH	PACKAGE
8190EZHD 90 Offset Door Pull 1" Round, 2-1/2" Clearance Antimicrobial Coating US26D-AM or US32D-AM available. See page 64 for optional mounting types and pricing.	8"	Brass	8190EZHD-8 US3	605	-	-	1	-	\$125.00	-
			8190EZHD-8 US4	606	-	-	1	-	125.00	-
			8190EZHD-8 US10	612	-	-	1	-	144.30	-
			8190EZHD-8 US10B	613	-	-	1	-	144.30	-
			8190EZHD-8 US15	619	-	-	1	-	144.30	-
			8190EZHD-8 US26	625	-	-	1	-	132.50	-
		8190EZHD-8 US26D	626	-	-	1	-	132.50	-	
		316 Stainless	8190EZHD-8 32-316	629-316	-	-	1	-	131.50	-
			8190EZHD-8 32D-316	630-316	-	-	1	-	108.40	-
			8190EZHD-8 643E/716	-	-	-	-	-	144.30	-
			8190EZHD-8 BLK	-	-	-	-	-	125.00	-
		10"	Brass	8190EZHD-0 US3	605	-	-	1	-	136.40
	8190EZHD-0 US4			606	-	-	1	-	136.40	-
	8190EZHD-0 US10			612	-	-	1	-	152.40	-
	8190EZHD-0 US10B			613	-	-	1	-	152.40	-
	8190EZHD-0 US15			619	-	-	1	-	152.40	-
	8190EZHD-0 US26			625	-	-	1	-	144.30	-
	8190EZHD-0 US26D		626	-	-	1	-	144.30	-	
	316 Stainless		8190EZHD-0 32-316	629-316	-	-	1	-	140.70	-
			8190EZHD-0 32D-316	630-316	-	-	1	-	117.70	-
			8190EZHD-0 643E/716	-	-	-	-	-	152.40	-
			8190EZHD-0 BLK	-	-	-	-	-	136.40	-
	12"		Brass	8190EZHD-2 US3	605	-	-	1	-	144.30
		8190EZHD-2 US4		606	-	-	1	-	144.30	-
8190EZHD-2 US10		612		-	-	1	-	164.00	-	
8190EZHD-2 US10B		613		-	-	1	-	164.00	-	
8190EZHD-2 US15		619		-	-	1	-	164.00	-	
8190EZHD-2 US26		625		-	-	1	-	156.40	-	
8190EZHD-2 US26D		626	-	-	1	-	156.40	-		
316 Stainless		8190EZHD-2 32-316	629-316	-	-	1	-	150.00	-	
		8190EZHD-2 32D-316	630-316	-	-	1	-	127.00	-	
		8190EZHD-2 643E/716	-	-	-	-	-	164.00	-	
		8190EZHD-2 BLK	-	-	-	-	-	144.30	-	
18"		Brass	8190EZHD-18 US3	605	-	-	1	-	195.30	-
	8190EZHD-18 US4		606	-	-	1	-	195.30	-	
	8190EZHD-18 US10		612	-	-	1	-	218.70	-	
	8190EZHD-18 US10B		613	-	-	1	-	218.70	-	
	8190EZHD-18 US15		619	-	-	1	-	218.70	-	
	8190EZHD-18 US26		625	-	-	1	-	206.80	-	
	8190EZHD-18 US26D	626	-	-	1	-	206.80	-		
	316 Stainless	8190EZHD-18 32-316	629-316	-	-	1	-	202.90	-	
		8190EZHD-18 32D-316	630-316	-	-	1	-	180.10	-	
		8190EZHD-18 643E/716	-	-	-	-	-	218.70	-	
		8190EZHD-18 BLK	-	-	-	-	-	195.30	-	

Lead time exception: ** Products are stocked and will typically ship in 3-5 days

Bold pricing indicates item is in stock and available for **Fast Track** and **ProXpress**

HINGES
 CONTINUOUS HINGES
 PIVOTS
 Numerical 1-059
 Numerical 59-437
 Numerical 438-1021
 Numerical 1152-8190
 Numerical 8200-9266

MODEL	PLATE SIZE	SUBSTRATE	MODEL NUMBER	BHMA FINISH	WEIGHT	MUST BE ORDERED IN MULTIPLE QTY	MULTIPLE QTY	PACKED PER BOX	LIST PRICE	
									EACH	PACKAGE
8200 Push Plate Antimicrobial Coating Available Specify US26D AM or US32D AM See page 64 for pricing.	3x12" (89x306mm)	Brass	8200 US3	605	-	-	-	-	\$22.10	-
			8200 US4	606	-	-	-	-	22.10	-
			8200 US10	612	-	-	-	-	24.70	-
			8200 US10B	613	-	-	-	-	27.60	-
			8200 US15	619	-	-	-	-	27.60	-
			8200 US26	625	-	-	-	-	27.60	-
			8200 US26D	626	-	-	-	-	27.60	-
		Aluminum	8200 US28	628	-	-	-	-	13.90	-
		Stainless	8200 US32D	630	-	-	-	-	13.60	-
	8200 BLK		-	-	-	-	-	22.10	-	
	3.5x15" (89x381mm)	Brass	8200 US3	605	-	-	-	-	24.30	-
			8200 US4	606	-	-	-	-	24.70	-
			8200 US10	612	-	-	-	-	29.10	-
			8200 US10B**	613	-	-	-	-	30.00	-
			8200 US15	619	-	-	-	-	30.00	-
			8200 US26	625	-	-	-	-	29.10	-
			8200 US26D	626	-	-	-	-	28.50	-
		Aluminum	8200 US28	628	-	-	-	-	11.40	-
		Stainless	8200 US32D**	630	-	-	-	-	14.00	-
			8200 BLK	-	-	-	-	-	24.30	-
	4x16" (102x408mm)	Brass	8200 US3	605	-	-	-	-	28.50	-
			8200 US4**	606	-	-	-	-	28.50	-
			8200 US10	612	-	-	-	-	32.60	-
			8200 US10B**	613	-	-	-	-	33.90	-
			8200 US15	619	-	-	-	-	33.90	-
			8200 US26	625	-	-	-	-	33.30	-
		8200 US26D**	626	-	-	-	-	32.60	-	
		Aluminum	8200 US28**	628	-	-	-	-	10.80	-
		Stainless	8200 US32D**	630	-	-	-	-	16.30	-
	8200 BLK		-	-	-	-	-	28.50	-	
	6x16" (153x408mm)	Brass	8200 US3	605	-	-	-	-	45.80	-
			8200 US4	606	-	-	-	-	45.80	-
			8200 US10	612	-	-	-	-	51.10	-
			8200 US10B	613	-	-	-	-	54.40	-
8200 US15			619	-	-	-	-	55.50	-	
8200 US26			625	-	-	-	-	48.60	-	
8200 US26D		626	-	-	-	-	48.60	-		
Aluminum		8200 US28	628	-	-	-	-	13.90	-	
Stainless		8200 US32D**	630	-	-	-	-	22.30	-	
		8200 BLK	-	-	-	-	-	45.80	-	
8x16" (204x408mm)	Brass	8200 US3	605	-	-	-	-	56.60	-	
		8200 US4	606	-	-	-	-	56.60	-	
		8200 US10	612	-	-	-	-	65.10	-	
		8200 US10B	613	-	-	-	-	69.40	-	
		8200 US15	619	-	-	-	-	69.40	-	
		8200 US26	625	-	-	-	-	63.70	-	
	8200 US26D	626	-	-	-	-	63.70	-		
	Aluminum	8200 US28	628	-	-	-	-	17.30	-	
	Stainless	8200 US32D**	630	-	-	-	-	31.10	-	
		8200 BLK	-	-	-	-	-	56.60	-	

HINGES
 CONTINUOUS HINGES
 PIVOTS
 Numerical 1-059
 Numerical 59-437
 Numerical 438-1021
 Numerical 1152-8190
 Numerical 8200-9266

Lead time exception: ** Products are stocked and will typically ship in 3-5 days

Bold pricing indicates item is in stock and available for **Fast Track** and **ProXpress**

MODEL	PULL CTC	PLATE SIZE	SUBSTRATE	MODEL NUMBER	BHMA FINISH	WEIGHT	MUST BE ORDERED IN			LIST PRICE		
							MULTIPLE QTY	MULTIPLE QTY	PACKED PER BOX	EACH	PACKAGE	
8281 Georgian Decorative Straight Pull 1" Dia. with 1 1/4" Dia. Grip See page 64 for optional mounting types and pricing. 	12"		Brass	8281-12-605	605	-	-	1		\$944.50	-	
				8281-12-613	613	-	-	1		982.20	-	
				8281-12-619*	619	-	-	1		755.50	-	
				8281-12-625*	625	-	-	1		755.50	-	
				8281-12-626*	626	-	-	1		755.50	-	
				8281-12-628*	628	-	-	1		389.90	-	
			Aluminum	8281-12-630	630	-	-	1		755.50	-	
				8281-12-BLK*	-	-	-	1		755.50	-	
				Stainless Steel	8281-16-605	605	-	-	1		974.90	-
					8281-16-613	613	-	-	1		1,013.80	-
					8281-16-619*	619	-	-	1		780.00	-
					8281-16-625*	625	-	-	1		780.00	-
	8281-16-626*	626	-		-	1		780.00	-			
	8281-16-628*	628	-		-	1		404.70	-			
	16"	Brass	8281-16-630	630	-	-	1		780.00	-		
			8281-16-BLK*	-	-	-	1		780.00	-		
			Aluminum	8281-18-605	605	-	-	1		990.20	-	
				8281-18-613	613	-	-	1		1,029.70	-	
				8281-18-619*	619	-	-	1		792.10	-	
				8281-18-625*	625	-	-	1		792.10	-	
		8281-18-626*		626	-	-	1		792.10	-		
		8281-18-628*		628	-	-	1		411.80	-		
		Stainless Steel	8281-18-630	630	-	-	1		792.10	-		
			8281-18-643E/716	-	-	-	1		1,029.70	-		
8281-18-BLK*			-	-	-	1		792.10	-			
18"			Brass	8302-6 US3	605	-	-	-	-	81.00	-	
	8302-6 US4			606	-	-	-	-	81.00	-		
	8302-6 US10			612	-	-	-	-	92.70	-		
	8302-6 US10B	613		-	-	-	-	96.30	-			
	8302-6 US15	619		-	-	-	-	96.30	-			
	8302-6 US26	625		-	-	-	-	91.70	-			
	Aluminum	8302-6 US26D	626	-	-	-	-	85.30	-			
		8302-6 US28	628	-	-	-	-	35.50	-			
		8302-6 US32D	630	-	-	-	-	48.50	-			
		8302-6 643E/716	-	-	-	-	-	96.30	-			
		8302-6 BLK	-	-	-	-	-	81.00	-			
		6"	Brass	8302-6 US3	605	-	-	-	-	85.30	-	
8302-6 US4	606			-	-	-	-	85.30	-			
8302-6 US10	612			-	-	-	-	96.70	-			
8302-6 US10B	613			-	-	-	-	100.40	-			
8302-6 US15	619			-	-	-	-	100.40	-			
8302-6 US26	625			-	-	-	-	96.10	-			
Aluminum	8302-6 US26D		626	-	-	-	-	89.30	-			
	8302-6 US28		628	-	-	-	-	35.00	-			
	8302-6 US32D**		630	-	-	-	-	50.60	-			
	8302-6 643E/716		-	-	-	-	-	100.40	-			
	8302-6 BLK		-	-	-	-	-	85.30	-			
	6"		Brass	8302-6 US3	605	-	-	-	-	102.00	-	
8302-6 US4		606		-	-	-	-	102.00	-			
8302-6 US10		612		-	-	-	-	114.70	-			
8302-6 US10B		613		-	-	-	-	121.20	-			
8302-6 US15		619		-	-	-	-	121.20	-			
8302-6 US26		625		-	-	-	-	111.40	-			
Aluminum		8302-6 US26D	626	-	-	-	-	104.80	-			
		8302-6 US28	628	-	-	-	-	37.90	-			
		8302-8 US32D	630	-	-	-	-	59.00	-			
		8302-6 643E/716	-	-	-	-	-	121.20	-			
		8302-6 BLK	-	-	-	-	-	102.00	-			
		8"	Brass	8302-8 US3	605	-	-	-	-	87.60	-	
8302-8 US4	606			-	-	-	-	87.60	-			
8302-8 US10	612			-	-	-	-	100.60	-			
8302-8 US10B	613			-	-	-	-	104.60	-			
8302-8 US15	619			-	-	-	-	104.60	-			
8302-8 US26	625			-	-	-	-	98.50	-			
Aluminum	8302-8 US26D		626	-	-	-	-	91.70	-			
	8302-8 US28		628	-	-	-	-	34.90	-			
	8302-8 US32D**		630	-	-	-	-	52.80	-			
	8302-8 643E/716		-	-	-	-	-	104.60	-			
	8302-8 BLK		-	-	-	-	-	87.60	-			

Continued on next page.

Lead time exception: ** Products are stocked and will typically ship in 3-5 days
*Finishes marked may date up to 4-5 weeks for shipment.

Bold pricing indicates item is in stock and available for Fast Track and ProXpress

MODEL	PULL CTC	PLATE SIZE	SUBSTRATE	MODEL NUMBER	BHMA FINISH	WEIGHT	MUST BE ORDERED IN			LIST PRICE	
							MULTIPLE QTY	MULTIPLE QTY	PACKED PER BOX	EACH	PACKAGE
8302 Pull Plate See page 64 for optional mounting types and pricing. Continued from previous page.	8"	4x16" (102x408mm)	Brass	8302-8 US3	605	-	-	-	-	\$91.70	-
				8302-8 US4	606	-	-	-	-	91.70	-
				8302-8 US10	612	-	-	-	-	105.00	-
				8302-8 US10B	613	-	-	-	-	104.20	-
				8302-8 US15	619	-	-	-	-	108.60	-
				8302-8 US26	625	-	-	-	-	102.80	-
			8302-8 US26D	626	-	-	-	-	96.10	-	
			Aluminum	8302-8 US28	628	-	-	-	-	35.60	-
			Stainless	8302-8 US32D**	630	-	-	-	-	54.90	-
				8302-8 643E/716	-	-	-	-	-	104.20	-
				8302-8 BLK	-	-	-	-	-	91.70	-
			8"	6x16" (153x408mm)	Brass	8302-8 US3	605	-	-	-	-
	8302-8 US4	606				-	-	-	-	108.50	-
	8302-8 US10	612				-	-	-	-	122.80	-
	8302-8 US10B	613				-	-	-	-	129.50	-
	8302-8 US15	619				-	-	-	-	129.50	-
	8302-8 US26	625				-	-	-	-	117.90	-
	8302-8 US26D	626			-	-	-	-	111.40	-	
	Aluminum	8302-8 US28			628	-	-	-	-	38.50	-
	Stainless	8302-8 US32D			630	-	-	-	-	63.50	-
		8302-8 643E/716			-	-	-	-	-	129.50	-
		8302-8 BLK			-	-	-	-	-	108.50	-
	10"	3.5x15" (89x381mm)			Brass	8302-0 US3	605	-	-	-	-
			8302-0 US4	606		-	-	-	-	97.80	-
			8302-0 US10	612		-	-	-	-	112.60	-
			8302-0 US10B	613		-	-	-	-	116.40	-
			8302-0 US15	619		-	-	-	-	116.40	-
			8302-0 US26	625		-	-	-	-	100.30	-
			8302-0 US26D	626	-	-	-	-	100.60	-	
			Aluminum	8302-0 US28	628	-	-	-	-	37.90	-
			Stainless	8302-0 US32D	630	-	-	-	-	59.10	-
				8302-0 643E/716	-	-	-	-	-	116.40	-
				8302-0 BLK	-	-	-	-	-	97.80	-
			10"	4x16" (102x408mm)	Brass	8302-0 US3	605	-	-	-	-
	8302-0 US4	606				-	-	-	-	102.10	-
	8302-0 US10	612				-	-	-	-	117.00	-
	8302-0 US10B	613				-	-	-	-	120.50	-
	8302-0 US15	619				-	-	-	-	120.50	-
	8302-0 US26	625				-	-	-	-	104.60	-
	8302-0 US26D	626			-	-	-	-	105.00	-	
	Aluminum	8302-0 US28			628	-	-	-	-	37.20	-
	Stainless	8302-0 US32D**			630	-	-	-	-	61.20	-
		8302-0 643E/716			-	-	-	-	-	120.50	-
		8302-0 BLK			-	-	-	-	-	102.10	-
	10"	6x16" (153x408mm)			Brass	8302-0 US3	605	-	-	-	-
			8302-0 US4	606		-	-	-	-	118.80	-
			8302-0 US10	612		-	-	-	-	134.80	-
			8302-0 US10B	613		-	-	-	-	141.30	-
8302-0 US15			619	-		-	-	-	141.30	-	
8302-0 US26			625	-		-	-	-	119.70	-	
8302-0 US26D			626	-	-	-	-	120.20	-		
Aluminum			8302-0 US28	628	-	-	-	-	40.10	-	
Stainless			8302-0 US32D**	630	-	-	-	-	67.00	-	
			8302-0 643E/716	-	-	-	-	-	141.30	-	
			8302-0 BLK	-	-	-	-	-	118.80	-	



HINGES
 CONTINUOUS HINGES
 PIVOTS
 Numerical 1-059
 Numerical 59-437
 Numerical 438-1021
 Numerical 1152-8190
 Numerical 8200-9266

Lead time exception: ** Products are stocked and will typically ship in 3-5 days

Bold pricing indicates item is in stock and available for **Fast Track** and **ProXpress**

HINGES

CONTINUOUS HINGES

PIVOTS

Numerical 1-059

Numerical 59-437

Numerical 438-1021

Numerical 1152-8190



Numerical 8200-9266

MODEL	PULL CTC	PLATE SIZE	SUBSTRATE	MODEL NUMBER	BHMA FINISH	WEIGHT	MUST BE ORDERED IN			LIST PRICE	
							MULTIPLE QTY	MULTIPLE QTY	PACKED PER BOX	EACH	PACKAGE
8303 Pull Plate Antimicrobial Coating US26D-AM or US32D-AM available. See page 64 for optional mounting types and pricing.	8"	3.5x15" (89x381mm)	Brass	8303-8 US3	605	-	-	-	-	\$134.40	-
				8303-8 US4	606	-	-	-	-	134.40	-
				8303-8 US10	612	-	-	-	-	152.20	-
				8303-8 US10B	613	-	-	-	-	157.80	-
				8303-8 US15	619	-	-	-	-	157.80	-
				8303-8 US26	625	-	-	-	-	145.50	-
			8303-8 US26D	626	-	-	-	-	138.90	-	
			Aluminum	8303-8 US28	628	-	-	-	-	45.00	-
			Stainless	8303-8 US32D	630	-	-	-	-	83.00	-
		8303-8 643E/716	-	-	-	-	-	157.80	-		
		8303-8 BLK	-	-	-	-	-	134.40	-		
	8"	4x16" (102x408mm)	Brass	8303-8 US3	605	-	-	-	-	138.60	-
				8303-8 US4	606	-	-	-	-	138.60	-
				8303-8 US10	612	-	-	-	-	156.20	-
				8303-8 US10B	613	-	-	-	-	161.90	-
				8303-8 US15	619	-	-	-	-	161.90	-
				8303-8 US26	625	-	-	-	-	149.70	-
			8303-8 US26D	626	-	-	-	-	143.30	-	
Aluminum			8303-8 US28	628	-	-	-	-	44.40	-	
Stainless			8303-8 US32D**	630	-	-	-	-	81.90	-	
	8303-8 643E/716	-	-	-	-	-	161.90	-			
	8303-8 BLK	-	-	-	-	-	138.60	-			
8"	6x16" (153x408mm)	Brass	8303-8 US3	605	-	-	-	-	155.40	-	
			8303-8 US4	606	-	-	-	-	155.40	-	
			8303-8 US10	612	-	-	-	-	174.20	-	
			8303-8 US10B	613	-	-	-	-	182.60	-	
			8303-8 US15	619	-	-	-	-	182.60	-	
			8303-8 US26	625	-	-	-	-	164.90	-	
		8303-8 US26D	626	-	-	-	-	158.40	-		
		Aluminum	8303-8 US28	628	-	-	-	-	47.30	-	
		Stainless	8303-8 US32D	630	-	-	-	-	91.40	-	
	8303-8 643E/716	-	-	-	-	-	182.60	-			
	8303-8 BLK	-	-	-	-	-	155.40	-			
10"	3.5x15" (89x381mm)	Brass	8303-0 US3	605	-	-	-	-	145.60	-	
			8303-0 US4	606	-	-	-	-	145.60	-	
			8303-0 US10	612	-	-	-	-	167.60	-	
			8303-0 US10B	613	-	-	-	-	169.10	-	
			8303-0 US15	619	-	-	-	-	173.70	-	
			8303-0 US26	625	-	-	-	-	156.20	-	
		8303-0 US26D	626	-	-	-	-	149.80	-		
		Aluminum	8303-0 US28	628	-	-	-	-	46.80	-	
		Stainless	8303-0 US32D	630	-	-	-	-	87.50	-	
	8303-0 643E/716	-	-	-	-	-	169.10	-			
	8303-0 BLK	-	-	-	-	-	145.60	-			
10"	4x16" (102x408mm)	Brass	8303-0 US3	605	-	-	-	-	149.80	-	
			8303-0 US4	606	-	-	-	-	149.80	-	
			8303-0 US10	612	-	-	-	-	171.80	-	
			8303-0 US10B	613	-	-	-	-	166.10	-	
			8303-0 US15	619	-	-	-	-	177.70	-	
			8303-0 US26	625	-	-	-	-	160.60	-	
		8303-0 US26D	626	-	-	-	-	154.00	-		
		Aluminum	8303-0 US28	628	-	-	-	-	46.00	-	
		Stainless	8303-0 US32D**	630	-	-	-	-	89.60	-	
	8303-0 643E/716	-	-	-	-	-	166.10	-			
	8303-0 BLK	-	-	-	-	-	149.80	-			

Continued on next page.

Lead time exception: ** Products are stocked and will typically ship in 3-5 days

Bold pricing indicates item is in stock and available for Fast Track and ProXpress

MODEL	PULL CTC	PLATE SIZE	SUBSTRATE	MODEL NUMBER	BHMA FINISH	WEIGHT	MUST BE ORDERED IN			LIST PRICE			
							MULTIPLE QTY	MULTIPLE QTY	PACKED PER BOX	EACH	PACKAGE		
8303 Pull Plate <i>Continued from previous page.</i> 	10"	6x16" (153x408mm)	Brass	8303-0 US3	605	-	-	-	-	\$166.60	-		
				8303-0 US4	606	-	-	-	-	166.60	-		
				8303-0 US10	612	-	-	-	-	189.70	-		
				8303-0 US10B	613	-	-	-	-	194.00	-		
				8303-0 US15	619	-	-	-	-	198.60	-		
				8303-0 US26	625	-	-	-	-	175.70	-		
				8303-0 US26D	626	-	-	-	-	169.40	-		
			Aluminum	8303-0 US28	628	-	-	-	-	48.90	-		
			Stainless	8303-0 US32D**	630	-	-	-	-	95.40	-		
				8303-0 643E/716	-	-	-	-	-	194.00	-		
8303-0 BLK	-	-		-	-	-	166.60	-					
8305 Pull Plate Antimicrobial Coating US26D-AM or US32D-AM available. See page 64 for optional mounting types and pricing. 	6"	3.5x15" (89x381mm)	Brass	8305-6 US3	605	-	-	-	-	85.70	-		
				8305-6 US4	606	-	-	-	-	85.70	-		
				8305-6 US10	612	-	-	-	-	103.30	-		
				8305-6 US10B	613	-	-	-	-	106.70	-		
				8305-6 US15	619	-	-	-	-	106.70	-		
				8305-6 US26	625	-	-	-	-	90.40	-		
				8305-6 US26D	626	-	-	-	-	85.40	-		
			Aluminum	8305-6 US28	628	-	-	-	-	38.50	-		
			Stainless	8305-6 US32D	630	-	-	-	-	61.40	-		
				8305-6 643E/716	-	-	-	-	-	106.70	-		
				8305-6 BLK	-	-	-	-	-	85.70	-		
			6"	4x16" (102x408mm)	Brass	8305-6 US3	605	-	-	-	-	90.00	-
						8305-6 US4	606	-	-	-	-	90.00	-
						8305-6 US10	612	-	-	-	-	107.50	-
						8305-6 US10B	613	-	-	-	-	110.70	-
	8305-6 US15	619				-	-	-	-	110.70	-		
	8305-6 US26	625				-	-	-	-	94.60	-		
	8305-6 US26D	626				-	-	-	-	89.60	-		
	Aluminum	8305-6 US28			628	-	-	-	-	38.00	-		
	Stainless	8305-6 US32D			630	-	-	-	-	61.10	-		
		8305-6 643E/716			-	-	-	-	-	110.70	-		
		8305-6 BLK			-	-	-	-	-	90.00	-		
	6"	6x16" (153x408mm)			Brass	8305-6 US3	605	-	-	-	-	106.70	-
						8305-6 US4	606	-	-	-	-	106.80	-
						8305-6 US10	612	-	-	-	-	125.70	-
						8305-6 US10B	613	-	-	-	-	131.70	-
			8305-6 US15	619		-	-	-	-	131.70	-		
			8305-6 US26	625		-	-	-	-	109.90	-		
			8305-6 US26D	626		-	-	-	-	105.00	-		
			Aluminum	8305-6 US28	628	-	-	-	-	40.90	-		
Stainless			8305-6 US32D	630	-	-	-	-	69.90	-			
			8305-6 643E/716	-	-	-	-	-	131.70	-			
			8305-6 BLK	-	-	-	-	-	106.80	-			
8"			3.5x15" (89x381mm)	Brass	8305-8 US3	605	-	-	-	-	117.90	-	
					8305-8 US4	606	-	-	-	-	117.90	-	
					8305-8 US10	612	-	-	-	-	130.00	-	
					8305-8 US10B	613	-	-	-	-	131.60	-	
	8305-8 US15	619			-	-	-	-	131.60	-			
	8305-8 US26	625			-	-	-	-	126.20	-			
	8305-8 US26D	626			-	-	-	-	126.20	-			
	Aluminum	8305-8 US28		628	-	-	-	-	44.50	-			
	Stainless	8305-8 US32D		630	-	-	-	-	81.90	-			
		8305-8 643E/716		-	-	-	-	-	131.60	-			
		8305-8 BLK		-	-	-	-	-	117.90	-			

HINGES
 CONTINUOUS HINGES
 PIVOTS
 Numerical 1-059
 Numerical 59-437
 Numerical 438-1021
 Numerical 1152-8190
 Numerical 8200-9266

Lead time exception: ** Products are stocked and will typically ship in 3-5 days

Bold pricing indicates item is in stock and available for **Fast Track** and **ProXpress**

HINGES

CONTINUOUS HINGES

PIVOTS

Numerical 1-059

Numerical 59-437

Numerical 438-1021



Numerical 1152-8190

Numerical 8200-9266

MODEL	PULL CTC	PLATE SIZE	SUBSTRATE	MODEL NUMBER	BHMA FINISH	WEIGHT	MUST BE ORDERED IN MULTIPLE			LIST PRICE	
							QTY	QTY	PER BOX	EACH	PACKAGE
8305 Pull Plate Continued from previous page. 	8"	4x16" (102x408mm)	Brass	8305-8 US3	605	-	-	-	-	\$122.30	-
				8305-8 US4	606	-	-	-	-	122.30	-
				8305-8 US10	612	-	-	-	-	134.40	-
				8305-8 US10B	613	-	-	-	-	135.70	-
				8305-8 US15	619	-	-	-	-	135.70	-
				8305-8 US26	625	-	-	-	-	130.20	-
			8305-8 US26D	626	-	-	-	-	130.20	-	
			Aluminum	8305-8 US28	628	-	-	-	-	43.90	-
			Stainless	8305-8 US32D**	630	-	-	-	-	80.70	-
		8305-8 643E/716	-	-	-	-	-	135.70	-		
		8305-8 BLK	-	-	-	-	-	122.30	-		
	8"	6x16" (153x408mm)	Brass	8305-8 US3	605	-	-	-	-	138.90	-
				8305-8 US4	606	-	-	-	-	138.90	-
				8305-8 US10	612	-	-	-	-	152.40	-
				8305-8 US10B	613	-	-	-	-	156.40	-
				8305-8 US15	619	-	-	-	-	156.40	-
				8305-8 US26	625	-	-	-	-	145.60	-
			8305-8 US26D	626	-	-	-	-	145.60	-	
Aluminum			8305-8 US28	628	-	-	-	-	46.90	-	
Stainless			8305-8 US32D	630	-	-	-	-	90.20	-	
	8305-8 643E/716	-	-	-	-	-	156.40	-			
	8305-8 BLK	-	-	-	-	-	138.90	-			
10"	3.5x15" (89x381mm)	Brass	8305-0 US3	605	-	-	-	-	125.90	-	
			8305-0 US4	606	-	-	-	-	125.90	-	
			8305-0 US10	612	-	-	-	-	141.80	-	
			8305-0 US10B	613	-	-	-	-	143.40	-	
			8305-0 US15	619	-	-	-	-	143.40	-	
			8305-0 US26	625	-	-	-	-	134.20	-	
		8305-0 US26D	626	-	-	-	-	134.20	-		
		Aluminum	8305-0 US28	628	-	-	-	-	45.60	-	
		Stainless	8305-0 US32D	630	-	-	-	-	89.90	-	
	8305-0 643E/716	-	-	-	-	-	143.40	-			
	8305-0 BLK	-	-	-	-	-	125.90	-			
10"	4x16" (102x408mm)	Brass	8305-0 US3	605	-	-	-	-	130.00	-	
			8305-0 US4	606	-	-	-	-	130.00	-	
			8305-0 US10	612	-	-	-	-	146.10	-	
			8305-0 US10B	613	-	-	-	-	147.40	-	
			8305-0 US15	619	-	-	-	-	147.40	-	
			8305-0 US26	625	-	-	-	-	138.40	-	
		8305-0 US26D	626	-	-	-	-	138.40	-		
		Aluminum	8305-0 US28	628	-	-	-	-	44.90	-	
		Stainless	8305-0 US32D**	630	-	-	-	-	88.30	-	
	8305-0 643E/716	-	-	-	-	-	147.40	-			
	8305-0 BLK	-	-	-	-	-	130.00	-			
10"	6x16" (153x408mm)	Brass	8305-0 US3	605	-	-	-	-	146.80	-	
			8305-0 US4	606	-	-	-	-	146.80	-	
			8305-0 US10	612	-	-	-	-	164.10	-	
			8305-0 US10B	613	-	-	-	-	168.20	-	
			8305-0 US15	619	-	-	-	-	168.20	-	
			8305-0 US26	625	-	-	-	-	153.50	-	
		8305-0 US26D	626	-	-	-	-	153.50	-		
		Aluminum	8305-0 US28	628	-	-	-	-	47.70	-	
		Stainless	8305-0 US32D	630	-	-	-	-	98.10	-	
	8305-0 643E/716	-	-	-	-	-	168.20	-			
	8305-0 BLK	-	-	-	-	-	146.80	-			

Lead time exception: ** Products are stocked and will typically ship in 3-5 days

Bold pricing indicates item is in stock and available for **Fast Track** and **ProXpress**

MODEL	PULL CTC	PLATE SIZE	SUBSTRATE	MODEL NUMBER	BHMA FINISH	WEIGHT	MUST BE ORDERED IN			LIST PRICE				
							MULTIPLE QTY	MULTIPLE QTY	PACKED PER BOX	EACH	PACKAGE			
8311 Pull Plate Antimicrobial Coating US26D-AM or US32D-AM available. See page 64 for optional mounting types and pricing. 	5" (Actual CTC = 5-1/4")	3.5x15" (89x381mm)	Brass	8311-5 US3	605	-	-	-	-	\$82.60	-			
				8311-5 US4	606	-	-	-	-	82.60	-			
				8311-5 US10	612	-	-	-	-	93.30	-			
				8311-5 US10B	613	-	-	-	-	94.80	-			
				8311-5 US15	619	-	-	-	-	94.80	-			
				8311-5 US26	625	-	-	-	-	86.90	-			
			8311-5 US26D	626	-	-	-	-	90.70	-				
			Aluminum	8311-5 US28	628	-	-	-	-	48.60	-			
			Stainless	8311-5 US32D	630	-	-	-	-	68.10	-			
				8311-5 643E/716	-	-	-	-	-	94.80	-			
				8311-5 BLK	-	-	-	-	-	82.60	-			
			5" (Actual CTC = 5-1/4")	4x16" (102x408mm)	Brass	8311-5 US3	605	-	-	-	-	86.90	-	
	8311-5 US4	606				-	-	-	-	86.90	-			
	8311-5 US10	612				-	-	-	-	97.60	-			
	8311-5 US10B	613				-	-	-	-	98.90	-			
	8311-5 US15	619				-	-	-	-	98.90	-			
	8311-5 US26	625				-	-	-	-	91.10	-			
	8311-5 US26D	626			-	-	-	-	94.90	-				
	Aluminum	8311-5 US28			628	-	-	-	-	47.80	-			
	Stainless	8311-5 US32D			630	-	-	-	-	67.40	-			
		8311-5 643E/716			-	-	-	-	-	98.90	-			
		8311-5 BLK			-	-	-	-	-	86.90	-			
	5" (Actual CTC = 5-1/4")	6x16" (153x408mm)			Brass	8311-5 US3	605	-	-	-	-	103.50	-	
			8311-5 US4	606		-	-	-	-	103.50	-			
8311-5 US10			612	-		-	-	-	115.50	-				
8311-5 US10B			613	-		-	-	-	119.70	-				
8311-5 US15			619	-		-	-	-	119.70	-				
8311-5 US26			625	-		-	-	-	106.30	-				
8311-5 US26D			626	-	-	-	-	110.20	-					
Aluminum			8311-5 US28	628	-	-	-	-	50.70	-				
Stainless			8311-5 US32D	630	-	-	-	-	76.50	-				
			8311-5 643E/716	-	-	-	-	-	119.70	-				
			8311-5 BLK	-	-	-	-	-	103.50	-				
8312 Plymouth Decorative Curved Pull - 1" Dia. See page 64 for optional mounting types and pricing. 			12"		Brass	8312-12-605	605	-	-	1	345.30	-		
	8312-12-613	613				-	-	1	419.30	-				
	8312-12-619*	619				-	-	1	419.30	-				
	8312-12-625*	625				-	-	1	419.30	-				
	8312-12-626*	626				-	-	1	419.30	-				
	Stainless Steel	8312-12-630			630	-	-	1	974.90	-				
		8312-12-BLK*			-	-	-	1	419.30	-				
		8320 Plymouth Decorative Curved Pull - 1 1/4" Dia. See page 64 for optional mounting types and pricing. 			20"		Brass	8320-20-605	605	-	-	1	641.30	-
								8320-20-613	613	-	-	1	690.70	-
								8320-20-619*	619	-	-	1	690.70	-
8320-20-625*	625		-	-				1	690.70	-				
8320-20-626*	626		-	-				1	690.70	-				
Stainless Steel	8320-20-630	630	-	-	1	1,096.90	-							
	8320-20-BLK*	-	-	-	1	690.70	-							

HINGES

CONTINUOUS HINGES

PIVOTS

Numerical 1-059

Numerical 59-437

Numerical 438-1021

Numerical 1152-8190

Numerical 8200-9266

Lead time exception: ** Products are stocked and will typically ship in 3-5 days
 *Finishes marked may date up to 4-5 weeks for shipment.

Bold pricing indicates item is in stock and available for **Fast Track** and **ProXpress**

HINGES

CONTINUOUS HINGES

PIVOTS



Numerical 1-059

Numerical 59-437

Numerical 438-1021

Numerical 1152-8190

Numerical 8200-9266

MODEL	PULL CTC	PLATE SIZE	SUBSTRATE	MODEL NUMBER	BHMA FINISH	WEIGHT	MUST BE ORDERED IN			LIST PRICE	
							MULTIPLE QTY	MULTIPLE QTY	PACKED PER BOX	EACH	PACKAGE
8371 Addison Decorative Flat Tip, Straight Pull 1" Dia. See page 64 for optional mounting types and pricing. 	12"		Brass	8371-12-605	605	-	-	1	-	\$780.00	-
				8371-12-613	613	-	-	1	-	780.00	-
				8371-12-619*	619	-	-	1	-	780.00	-
				8371-12-625*	625	-	-	1	-	780.00	-
				8371-12-626*	626	-	-	1	-	779.90	-
				8371-12-BLK*	622	-	-	1	-	780.00	-
	18"		Brass	8371-18-605	605	-	-	1	-	823.80	-
				8371-18-613	613	-	-	1	-	823.80	-
				8371-18-619*	619	-	-	1	-	823.80	-
				8371-18-625*	625	-	-	1	-	823.80	-
				8371-18-626*	626	-	-	1	-	823.80	-
				8371-18-BLK*	622	-	-	1	-	823.80	-
	24"		Brass	8371-24-605	605	-	-	1	-	853.20	-
				8371-24-613	613	-	-	1	-	853.20	-
				8371-24-619*	619	-	-	1	-	853.20	-
				8371-24-625*	625	-	-	1	-	853.20	-
				8371-24-626*	626	-	-	1	-	853.20	-
				8371-24-BLK*	622	-	-	1	-	853.20	-
8372 Camelot Decorative Steeple Tip, Straight Pull 1" Dia. See page 64 for optional mounting types and pricing. 	12"		Brass	8372-12-605	605	-	-	1	-	780.00	-
				8372-12-613	613	-	-	1	-	780.00	-
				8372-12-619*	619	-	-	1	-	780.00	-
				8372-12-625*	625	-	-	1	-	780.00	-
				8372-12-626*	626	-	-	1	-	779.90	-
				8372-12-BLK*	622	-	-	1	-	780.00	-
	18"		Brass	8372-18-605	605	-	-	1	-	823.80	-
				8372-18-613	613	-	-	1	-	823.80	-
				8372-18-619*	619	-	-	1	-	823.80	-
				8372-18-625*	625	-	-	1	-	823.80	-
				8372-18-626*	626	-	-	1	-	823.80	-
				8372-18-BLK*	622	-	-	1	-	823.80	-
	24"		Brass	8372-24-605	605	-	-	1	-	853.20	-
				8372-24-613	613	-	-	1	-	853.20	-
				8372-24-619*	619	-	-	1	-	853.20	-
				8372-24-625*	625	-	-	1	-	853.20	-
				8372-24-626*	626	-	-	1	-	853.20	-
				8372-24-BLK*	622	-	-	1	-	853.20	-
8373 Brookshire Decorative Acorn Tip, Straight Pull 1" Dia. See page 64 for optional mounting types and pricing. 	12"		Brass	8373-12-605	605	-	-	1	-	780.00	-
				8373-12-613	613	-	-	1	-	780.00	-
				8373-12-619*	619	-	-	1	-	780.00	-
				8373-12-625*	625	-	-	1	-	780.00	-
				8373-12-626*	626	-	-	1	-	779.90	-
				8373-12-BLK*	622	-	-	1	-	780.00	-
	18"		Brass	8373-18-605	605	-	-	1	-	823.80	-
				8373-18-613	613	-	-	1	-	823.80	-
				8373-18-619*	619	-	-	1	-	823.80	-
				8373-18-625*	625	-	-	1	-	823.80	-
				8373-18-626*	626	-	-	1	-	823.80	-
				8373-18-BLK*	622	-	-	1	-	823.80	-
	24"		Brass	8373-24-605	605	-	-	1	-	853.20	-
				8373-24-613	613	-	-	1	-	853.20	-
				8373-24-619*	619	-	-	1	-	853.20	-
				8373-24-625*	625	-	-	1	-	853.20	-
				8373-24-626*	626	-	-	1	-	853.20	-
				8373-24-BLK*	622	-	-	1	-	853.20	-

Lead time exception: ** Products are stocked and will typically ship in 3-5 days

*Finishes marked may date up to 4-5 weeks for shipment.

Bold pricing indicates item is in stock and available for **Fast Track** and **ProXpress**

8400 Protection Plates Stocked Protection Plates

All protection plates come standard with 4 Beveled Edges and Counter Sunk Holes (B-CS) at no extra charge.

MODEL	SUBSTRATE	FINISH	PLATE SIZE	WEIGHT	MUST BE ORDERED IN MULTIPLE QTY	MUTIPLE QTY	PACKED PER BOX	LIST PRICE			
								EACH	PACKAGE		
8400	Aluminum	US28	8X34	---	---	---	---	\$33.52	---		
		Plastic	P-BLK	10 X 34	---	---	---	---	35.40	---	
	CLR		8 X 34	---	---	---	---	28.30	---		
	Brass	US3	6X34	---	---	---	---	---	87.63	---	
			8X34	---	---	---	---	---	110.33	---	
			10X34	---	---	---	---	---	137.91	---	
		US10	8X34	---	---	---	---	---	---	123.67	---
			10X34	---	---	---	---	---	---	154.59	---
		US10B	4X35	---	---	---	---	---	---	70.30	---
			6X34	---	---	---	---	---	---	99.58	---
			8X34	---	---	---	---	---	---	123.67	---
			8X35	---	---	---	---	---	---	130.95	---
			10X34	---	---	---	---	---	---	154.59	---
			10X34.5	---	---	---	---	---	---	163.69	---
			10X35	---	---	---	---	---	---	163.69	---
		US15	10X40	---	---	---	---	---	---	181.87	---
			10X46	---	---	---	---	---	---	209.15	---
			6X34	---	---	---	---	---	---	99.58	---
			8X34	---	---	---	---	---	---	126.28	---
			10X34	---	---	---	---	---	---	111.88	---
		Stainless	US32	US32D	4X34	---	---	---	---	21.49	---
	4X35			---	---	---	---	---	22.75	---	
	US32D		4X41	---	---	---	---	---	---	26.54	---
			4X47	---	---	---	---	---	---	30.32	---
			6X30	---	---	---	---	---	---	28.43	---
			6X34	---	---	---	---	---	---	32.23	---
			6X35	---	---	---	---	---	---	34.12	---
			8X22	---	---	---	---	---	---	24.64	---
			8X26	---	---	---	---	---	---	29.13	---
			8X28	---	---	---	---	---	---	31.36	---
			8X30	---	---	---	---	---	---	33.60	---
			8X32	---	---	---	---	---	---	35.83	---
			8X34	---	---	---	---	---	---	38.07	---
			8X34.5	---	---	---	---	---	---	40.33	---
			8X35	---	---	---	---	---	---	40.33	---
			8X36	---	---	---	---	---	---	40.33	---
			8X38	---	---	---	---	---	---	42.56	---
			8X40	---	---	---	---	---	---	44.80	---
			8X41	---	---	---	---	---	---	47.04	---
			8X42	---	---	---	---	---	---	47.04	---
			8X46	---	---	---	---	---	---	51.52	---
			8X47	---	---	---	---	---	---	53.77	---
			10X17	---	---	---	---	---	---	30.81	---
			10X22	---	---	---	---	---	---	30.81	---
			10X23	---	---	---	---	---	---	33.60	---
			10X26	---	---	---	---	---	---	36.40	---
			10X28	---	---	---	---	---	---	39.20	---
			10X29	---	---	---	---	---	---	42.01	---
			10X30	---	---	---	---	---	---	42.01	---
			10X31	---	---	---	---	---	---	44.80	---
10X32	---		---	---	---	---	---	44.80	---		
10X33	---		---	---	---	---	---	47.60	---		
10X34	---	---	---	---	---	---	47.60	---			
10X34.5	---	---	---	---	---	---	50.40	---			
10X35	---	---	---	---	---	---	50.40	---			
10X36	---	---	---	---	---	---	50.40	---			
10X37	---	---	---	---	---	---	53.19	---			
10X38	---	---	---	---	---	---	53.19	---			
10X39	---	---	---	---	---	---	55.99	---			
10X40	---	---	---	---	---	---	55.99	---			
10X40.5	---	---	---	---	---	---	58.80	---			
10X41	---	---	---	---	---	---	58.80	---			
10X42	---	---	---	---	---	---	58.80	---			
10X42.5	---	---	---	---	---	---	61.59	---			
10X43	---	---	---	---	---	---	61.59	---			
10X44	---	---	---	---	---	---	61.59	---			
10X46	---	---	---	---	---	---	64.39	---			
10X46.5	---	---	---	---	---	---	67.20	---			
10X47	---	---	---	---	---	---	67.20	---			
12X28	---	---	---	---	---	---	47.04	---			
12X34	---	---	---	---	---	---	57.13	---			

HINGES
 CONTINUOUS HINGES
 PIVOTS
 Numerical 1-059
 Numerical 59-437
 Numerical 438-1021
 Numerical 1152-8190
 Numerical 8200-9266

Bold pricing indicates item is in stock and available for Fast Track and ProXpress

8400 Protection Plates Stocked Protection Plates (continued)

All protection plates come standard with 4 Beveled Edges and Counter Sunk Holes (B-CS) at no extra charge.

MODEL	SUBSTRATE	FINISH	PLATE SIZE	WEIGHT	MUST BE ORDERED IN MULTIPLE QTY	MULTIPLE QTY	PACKED PER BOX	LIST PRICE				
								EACH	PACKAGE			
8400 continued	Stainless continued	US32D continued	12X35	---	---	---	---	\$60.48	---			
			12X40	---	---	---	---	67.20	---			
			12X42	---	---	---	---	70.56	---			
			12X46	---	---	---	---	77.28	---			
			16X34	---	---	---	---	76.15	---			
			16X40	---	---	---	---	89.59	---			
			16X46	---	---	---	---	103.04	---			
			18X34	---	---	---	---	92.99	---			
			24X34	---	---	---	---	123.99	---			
			30X34	---	---	---	---	155.00	---			
			30X35	---	---	---	---	164.12	---			
			30X40	---	---	---	---	182.35	---			
			32X34	---	---	---	---	165.34	---			
			34X34	---	---	---	---	175.66	---			
			34X35	---	---	---	---	186.00	---			
			34X36	---	---	---	---	186.00	---			
			34X40	---	---	---	---	206.67	---			
			34X46	---	---	---	---	237.67	---			
			8402	Stainless	US32D	10X34	---	---	---	---	65.55	---
						34X34	---	---	---	---	193.61	---
34X46	---	---				---	---	255.61	---			

For all other Protection Plates, see pricing in the table below.

8400 Protection Plate (List Price (Per 100 Square Inches))

FINISH	SUBSTRATE	MAX SIZE	UNDER 8"	8" ≤ 16"	OVER 16" ≤ 36"	OVER 36" ≤ 48"
US32D	Stainless	48 x 48"	\$16.50	\$14.60	\$15.80	\$15.80
US32	Stainless	48 x 48"	36.20	34.30	35.00	35.00
BLK	Stainless	24 x 48"	36.20	34.30	35.00	35.00
US3	Brass	24 x 48"	44.80	42.30	55.90	NA
US4	Brass	24 x 48"	44.80	42.30	55.90	NA
US10	Brass	24 x 48"	49.90	47.40	62.40	NA
US10B	Brass	36 x 48"	50.80	47.40	62.40	NA
US15	Brass	24 x 48"	50.80	48.40	62.40	NA
US26	Brass	36 x 48"	49.10	46.80	62.40	NA
US26D	Brass	24 x 48"	49.10	46.80	62.40	NA
US28	Aluminum	48 x 48"	15.20	12.70	13.90	13.90
Clear	Plastic	48 x 48"	13.70	10.90	12.40	12.40
P-BLK	Plastic	48 x 48"	13.70	10.90	12.40	12.40
654	Satin Stainless Steel	48 x 48"	14.00	12.60	13.70	13.70

Kickplates must be ordered in 1/2" increments

8400 Options

MODEL	DESCRIPTION	SIZE	LIST ADD PER PLATE
B-CS	Hand Bevel Four Edges (B4E) and Counter Sunk Holes		Standard
B-NH	No Mounting Holes - US32D, US32, US3, US4, US28, Clear, Black only		28.00
B-NHA	No Mounting Holes with Adhesive - US32D, US32, US3, US4, US28, Clear, Black only	12" and under	28.00
		over 12" up to 24"	57.00
TK-TX	Includes Self Drilling Tek Screws and Torx Brand Security Screws (package of 16 each)		14.00
ERS	Prepped for Extra Row of Screws (For extra mounting hole option, customer must specify location and quantity of holes required)		Consult Factory

MODEL	DESCRIPTION	SIZE	LIST ADD PER PLATE
8401	Gasket Tape Kit (sold separately)	Fits 8" x 34"	\$22.00 ea.
8402	UL Label Kickplate (not available on plastic kickplates)		19.00 ea.

Lead time exception: ** Products are stocked and will typically ship in 3-5 days

Bold pricing indicates item is in stock and available for **Fast Track** and **ProXpress**

Door Plate Hundred Square Inch Sizing Chart

		width													
height		22	24	26	28	30	32	34	36	38	40	42	44	46	48
4	0.88	0.96	1.04	1.12	1.2	1.28	1.36	1.44	1.52	1.6	1.68	1.76	1.84	1.92	
6	1.32	1.44	1.56	1.68	1.8	1.92	2.04	2.16	2.28	2.4	2.52	2.64	2.76	2.88	
8	1.76	1.92	2.08	2.24	2.4	2.56	2.72	2.88	3.04	3.2	3.36	3.52	3.68	3.84	
10	2.2	2.4	2.6	2.8	3	3.2	3.4	3.60	3.80	4	4.2	4.4	4.6	4.8	
12	2.64	2.88	3.12	3.36	3.6	3.84	4.08	4.32	4.56	4.8	5.04	5.28	5.52	5.76	
14	3.08	3.36	3.64	3.92	4.2	4.48	4.76	5.04	5.32	5.6	5.88	6.16	6.44	6.72	
16	3.52	3.84	4.16	4.48	4.8	5.12	5.44	5.76	6.08	6.4	6.72	7.04	7.36	7.68	
18	3.96	4.32	4.68	5.04	5.4	5.76	6.12	6.48	6.84	7.2	7.56	7.92	8.28	8.64	
20	4.4	4.8	5.2	5.6	6	6.4	6.8	7.20	7.60	8	8.4	8.8	9.2	9.6	
22	4.84	5.28	5.72	6.16	6.6	7.04	7.48	7.92	8.36	8.8	9.24	9.68	10.12	10.56	
24	5.28	5.76	6.24	6.72	7.2	7.68	8.16	8.64	9.12	9.6	10.08	10.56	11.04	11.52	
26	5.72	6.24	6.76	7.28	7.8	8.32	8.84	9.36	9.88	10.4	10.92	11.44	11.96	12.48	
28	6.16	6.72	7.28	7.84	8.4	8.96	9.52	10.08	10.64	11.2	11.76	12.32	12.88	13.44	
30	6.6	7.2	7.8	8.4	9	9.6	10.2	10.80	11.40	12	12.6	13.2	13.8	14.4	
32	7.04	7.68	8.32	8.96	9.6	10.24	10.88	11.52	12.16	12.8	13.44	14.08	14.72	15.36	
34	7.48	8.16	8.84	9.52	10.2	10.88	11.56	12.24	12.92	13.6	14.28	14.96	15.64	16.32	
36	7.92	8.64	9.36	10.08	10.8	11.52	12.24	12.96	13.68	14.4	15.12	15.84	16.56	17.28	
38	8.36	9.12	9.88	10.64	11.4	12.16	12.92	13.68	14.44	15.2	15.96	16.72	17.48	18.24	
40	8.8	9.6	10.4	11.2	12	12.8	13.6	14.40	15.20	16	16.8	17.6	18.4	19.2	
42	9.24	10.08	10.92	11.76	12.6	13.44	14.28	15.12	15.96	16.8	17.64	18.48	19.32	20.16	
44	9.68	10.56	11.44	12.32	13.2	14.08	14.96	15.84	16.72	17.6	18.48	19.36	20.24	21.12	
46	10.12	11.04	11.96	12.88	13.8	14.72	15.64	16.56	17.48	18.4	19.32	20.24	21.16	22.08	
48	10.56	11.52	12.48	13.44	14.4	15.36	16.32	17.28	18.24	19.2	20.16	21.12	22.08	23.04	

How to price protection plates

1) Look to see if the desired plate is in the the Stocked table. If it is, use this price shown.

2) If the plate is not a stocked plate,

a) Determine the hundred square inch size using the Door Plate Hundred Square Inch Sizing Chart above. If ordering in increments not shown on the chart, use the next larger size (height and/or width) shown in the chart.

Example: For a 6 1/2" x 33 1/2" plate, use 8 x 34 = 2.72 sq. inches.

b) Determine the list price for the height of plate and desired finish from the List Price (per 100 square inches) table.

Example: For a 6 1/2" height plate in US32D finish, use Under 8" column = \$16.50

For base plate pricing, multiply square inch size from part a) times the list price from b)

Example = 2.72 sq. inches X \$16.50 = \$44.88

3) If any options are desired, then add the list add per plate pricing to the base plate pricing.

For a 8402 8 X 34 US32D TK-TX, use the following.

Examples = 2.72 sq. inches X \$14.60 (base price) + \$19 (for UL) + \$14 (for TK-TX) = \$72.71

Return Policy - requires prior approval, consult factory.

HINGES

CONTINUOUS HINGES

PIVOTS

Numerical 1-059

Numerical 59-437

Numerical 438-1021





Numerical 1152-8190

Numerical 8200-9266

Lead time exception: ** Products are stocked and will typically ship in 3-5 days



Bold pricing indicates item is in stock and available for **Fast Track** and **ProXpress**

HINGES
 CONTINUOUS HINGES
 PIVOTS
 Numerical 1-059
 Numerical 59-437
 Numerical 438-1021
 Numerical 1152-8190
 Numerical 8200-9266

MODEL	PULL CTC	SUBSTRATE	MODEL NUMBER	BHMA Finish	WEIGHT	Must Be Ordered in Multiple QTY	Multiple QTY	List Price	
								EACH	PACKAGE
8700 Greenwich Decorative Arc Straight Pull 3/4" Dia. See page 64 for optional mounting types and pricing. 	9"	Brass	8700-09-605	605	-	-	1	\$235.10	-
			8700-09-613	613	-	-	1	235.10	-
			8700-09-619*	619	-	-	1	235.10	-
			8700-09-625*	625	-	-	1	235.10	-
			8700-09-626*	626	-	-	1	235.10	-
		Stainless Steel	8700-09-630	630	-	-	1	228.70	-
	8700-09-BLK*	-	-	-	-	1	235.10	-	
	12"	Brass	8700-12-605	605	-	-	1	244.80	-
			8700-12-613	613	-	-	1	244.80	-
			8700-12-619*	619	-	-	1	244.80	-
			8700-12-625*	625	-	-	1	244.80	-
			8700-12-626*	626	-	-	1	244.80	-
		Stainless Steel	8700-12-630	630	-	-	1	268.00	-
	8700-12-BLK*	-	-	-	-	1	244.80	-	
	18"	Brass	8700-18-605	605	-	-	1	281.80	-
			8700-18-613	613	-	-	1	281.80	-
			8700-18-619*	619	-	-	1	281.80	-
			8700-18-625*	625	-	-	1	281.80	-
			8700-18-626*	626	-	-	1	281.80	-
		Stainless Steel	8700-18-630	630	-	-	1	257.40	-
	8700-18-BLK*	-	-	-	-	1	281.80	-	
	24"	Brass	8700-24-605	605	-	-	1	281.80	-
			8700-24-613	613	-	-	1	281.80	-
			8700-24-619*	619	-	-	1	281.80	-
8700-24-625*			625	-	-	1	281.80	-	
8700-24-626*			626	-	-	1	281.80	-	
Stainless Steel		8700-24-630	630	-	-	1	257.40	-	
8700-24-BLK*	-	-	-	-	1	281.80	-		
8800 Greenwich Decorative Arc Offset Pull 3/4" Dia. See page 64 for optional mounting types and pricing. 	9"	Brass	8800-09-605	605	-	-	1	302.20	-
			8800-09-613	613	-	-	1	302.20	-
			8800-09-619*	619	-	-	1	302.20	-
			8800-09-625*	625	-	-	1	302.20	-
			8800-09-626*	626	-	-	1	302.20	-
		Stainless Steel	8800-09-630	630	-	-	1	292.50	-
	8800-09-BLK*	-	-	-	-	1	302.20	-	
	12"	Brass	8800-12-605	605	-	-	1	320.70	-
			8800-12-613	613	-	-	1	320.70	-
			8800-12-619*	619	-	-	1	320.70	-
			8800-12-625*	625	-	-	1	320.70	-
			8800-12-626*	626	-	-	1	320.70	-
		Stainless Steel	8800-12-630	630	-	-	1	316.80	-
	8800-12-BLK*	-	-	-	-	1	320.70	-	
	18"	Brass	8800-18-605	605	-	-	1	351.60	-
			8800-18-613	613	-	-	1	351.60	-
			8800-18-619*	619	-	-	1	351.60	-
			8800-18-625*	625	-	-	1	351.60	-
			8800-18-626*	626	-	-	1	351.60	-
		Stainless Steel	8800-18-630	630	-	-	1	341.20	-
	8800-18-BLK*	-	-	-	-	1	351.60	-	
	24"	Brass	8800-24-605	605	-	-	1	431.50	-
			8800-24-613	613	-	-	1	431.50	-
			8800-24-619*	619	-	-	1	431.50	-
8800-24-625*			625	-	-	1	431.50	-	
8800-24-626*			626	-	-	1	431.50	-	
Stainless Steel		8800-24-630	630	-	-	1	365.70	-	
8800-24-BLK*	-	-	-	-	1	431.50	-		
8848 Latitude Decorative Straight Pull w/ Black Stand Offs - 1" Dia. See page 64 for optional mounting types and pricing. 	12"	Brass	8848-12-605	605	-	-	1	584.90	-
			8848-12-613	613	-	-	1	584.90	-
			8848-12-619*	619	-	-	1	584.90	-
			8848-12-625*	625	-	-	1	584.90	-
			8848-12-626*	626	-	-	1	584.90	-
		Stainless Steel	8848-12-630	630	-	-	1	487.50	-
			8848-12-BLK*	-	-	-	1	584.90	-
8975 Rhodes Decorative Straight Pull - 1 1/4" w x 1/2" thick. See page 64 for optional mounting types and pricing. 	12"	Aluminum	8975-12-628	628	-	-	1	584.90	-

Lead time exception: ** Products are stocked and will typically ship in 3-5 days
 *Finishes marked may date up to 4-5 weeks for shipment.

Bold pricing indicates item is in stock and available for **Fast Track** and **ProXpress**

MODEL	PUSH CTC	PULL CTC	SUBSTRATE	FINISH	MODEL NUMBER	DESCRIPTION	WEIGHT	ORDER QTY	BOX QTY	LIST PRICE		
<p>9100HD Push Bar, 1" Round, 2-1/2" Projection Pull Plate</p> <p>Custom Sizing Available in 1" increments. Fractional increments available as Engineered Specials.</p> <p>See page 64 for pricing</p> <p>Antimicrobial Coating US26D-AM or US32D-AM available.</p> <p>Standard with NS mounting; See page 64 for optional mounting types and pricing.</p> 	28"		Brass	605	9100HD-28-US3					241.50		
				606	9100HD-28-US4			241.50				
				612	9100HD-28-US10			284.60				
				613	9100HD-28-US10B			284.60				
				619	9100HD-28-US15			284.60				
				625	9100HD-28-US26			249.20				
			626	9100HD-28-US26D			249.20					
			Stainless	629	9100HD-28-32			197.60				
				630	9100HD-28-32D			174.30				
				-	9100HD-28-643E/716			284.60				
				-	9100HD-28-BLK			241.50				
				316 Stainless	629-316	9100HD-28-32-316			227.50			
	630-316	9100HD-28-32D-316					200.70					
	33"	Brass		605	9100HD-33-US3						241.50	
				606	9100HD-33-US4			241.50				
				612	9100HD-33-US10			284.60				
				613	9100HD-33-US10B			284.60				
				619	9100HD-33-US15			284.60				
				625	9100HD-33-US26			249.20				
		626	9100HD-33-US26D			249.20						
		Stainless	629	9100HD-33-32			265.50					
			630	9100HD-33-32D**			174.30					
			-	9100HD-33-643E/716			284.60					
			-	9100HD-33-BLK			241.50					
316 Stainless			629-316	9100HD-33-32-316			305.60					
			630-316	9100HD-33-32D-316			200.70					
<p>9103EZHD Push / Pull Combo 1" Round (8103EZ Pull + 9100 Push)</p> <p>Custom Sizing Available in 1" increments. Fractional increments available as Engineered Specials.</p> <p>See page 64 for pricing</p> <p>Antimicrobial Coating US26D-AM or US32D-AM available.</p> <p>See page 64 for optional mounting types and pricing.</p> 		28"	8"	Brass	605	9103EZHD-28-8-US3					366.40	
					606	9103EZHD-28-8-US4			366.40			
					612	9103EZHD-28-8-US10			428.60			
					613	9103EZHD-28-8-US10B			428.60			
					619	9103EZHD-28-8-US15			428.60			
	625				9103EZHD-28-8-US26			381.80				
	626			9103EZHD-28-8-US26D			381.80					
	316 Stainless			629-316	9103EZHD-28-8-32-316			353.80				
				630-316	9103EZHD-28-8-32D-316			314.20				
				-	9103EZHD-28-8-643E/716			428.60				
				-	9103EZHD-28-8-BLK			366.40				
				316 Stainless	629-316	9103EZHD-28-0-32-316			363.60			
		630-316	9103EZHD-28-0-32D-316				323.60					
	28"	10"	Brass	605	9103EZHD-28-0-US3						345.80	
				606	9103EZHD-28-0-US4			364.80				
				612	9103EZHD-28-0-US10			364.80				
				613	9103EZHD-28-0-US10B			364.80				
				619	9103EZHD-28-0-US15			364.80				
				625	9103EZHD-28-0-US26			364.80				
			626	9103EZHD-28-0-US26D			364.80					
			316 Stainless	629-316	9103EZHD-28-0-32-316			363.60				
				630-316	9103EZHD-28-0-32D-316			323.60				
				-	9103EZHD-28-0-643E/716			364.80				
				-	9103EZHD-28-0-BLK			345.80				
				28"	12"	Brass	605	9103EZHD-28-2-US3				
	606	9103EZHD-28-2-US4							361.40			
	612	9103EZHD-28-2-US10						419.90				
	613	9103EZHD-28-2-US10B						419.90				
	619	9103EZHD-28-2-US15						419.90				
	625	9103EZHD-28-2-US26						373.00				
	626	9103EZHD-28-2-US26D					373.00					
	316 Stainless	629-316	9103EZHD-28-2-32-316					373.20				
		630-316	9103EZHD-28-2-32D-316					332.90				
		-	9103EZHD-28-2-643E/716					419.90				
		-	9103EZHD-28-2-BLK					361.40				
		33"	8"			Brass	605	9103EZHD-33-8-US3				
				606	9103EZHD-33-8-US4				366.40			
	612			9103EZHD-33-8-US10				428.60				
	613			9103EZHD-33-8-US10B				428.60				
	619			9103EZHD-33-8-US15				428.60				
	625			9103EZHD-33-8-US26				381.80				
	626			9103EZHD-33-8-US26D			381.80					
	316 Stainless			629-316	9103EZHD-33-8-32-316			431.90				
				630-316	9103EZHD-33-8-32D-316			314.20				
				-	9103EZHD-33-8-643E/716			428.60				
				-	9103EZHD-33-8-BLK			366.40				
				33"	10"	Brass	605	9103EZHD-33-0-US3				
		606	9103EZHD-33-0-US4						353.80			
612	9103EZHD-33-0-US10						408.20					
613	9103EZHD-33-0-US10B						408.20					
619	9103EZHD-33-0-US15						364.80					
625	9103EZHD-33-0-US26						365.60					
626	9103EZHD-33-0-US26D					365.60						
316 Stainless	629-316	9103EZHD-33-0-32-316					441.60					
	630-316	9103EZHD-33-0-32D-316					323.60					
	-	9103EZHD-33-0-643E/716					408.20					
	-	9103EZHD-33-0-BLK					353.80					
	33"	12"	Brass			605	9103EZHD-33-2-US3					
				606	9103EZHD-33-2-US4			361.40				
612				9103EZHD-33-2-US10			419.90					
613				9103EZHD-33-2-US10B			419.90					
619				9103EZHD-33-2-US15			419.90					
625				9103EZHD-33-2-US26			373.00					
626			9103EZHD-33-2-US26D			373.00						
316 Stainless			629-316	9103EZHD-33-2-32-316			451.20					
			630-316	9103EZHD-33-2-32D-316			332.90					
			-	9103EZHD-33-2-643E/716			419.90					
			-	9103EZHD-33-2-BLK			361.40					

HINGES

CONTINUOUS
HINGES

PIVOTS

Numerical
1-059Numerical
59-437Numerical
438-1021Numerical
1152-8190Numerical
8200-9266

Lead time exception: ** Products are stocked and will typically ship in 3-5 days

Bold pricing indicates item is in stock and available for **Fast Track** and **ProXpress**

HINGES
CONTINUOUS
HINGES
PIVOTS
Numerical
1-059
Numerical
59-437
Numerical
438-1021
Numerical
1152-8190
Numerical
8200-9266

MODEL	PUSH CTC	PULL CTC	SUBSTRATE	FINISH	MODEL NUMBER	DESCRIPTION	WEIGHT	ORDER QTY	BOX QTY	LIST PRICE
9145EZHD Push / Pull Combo 1" Round (8145EZHD Pull + 9100HD Push) <i>Custom Sizing Available in 1" increments</i> <i>Fractional increments available as Engineered Specials</i>	28"	8"	Brass	605	9145EZHD-28-8-USB3					\$398.30
				606	9145EZHD-28-8-US4			398.30		
				612	9145EZHD-28-8-US10			461.70		
				613	9145EZHD-28-8-US10B			461.70		
				619	9145EZHD-28-8-US15			461.70		
				625	9145EZHD-28-8-US26			413.90		
			626	9145EZHD-28-8-US26D			413.90			
			629-316	9145EZHD-28-8-32-316			391.10			
			630-316	9145EZHD-28-8-32D-316			340.20			
			-	9145EZHD-28-8-643E/716			461.70			
			-	9145EZHD-28-8-BLK			398.30			
			See page 64 for pricing	28"	10"	Brass	605	9145EZHD-28-0-US3		
606	9145EZHD-28-0-US4						410.30			
612	9145EZHD-28-0-US10						470.10			
613	9145EZHD-28-0-US10B						470.10			
619	9145EZHD-28-0-US15						470.10			
625	9145EZHD-28-0-US26						426.30			
626	9145EZHD-28-0-US26D					426.30				
629-316	9145EZHD-28-0-32-316					400.80				
630-316	9145EZHD-28-0-32D-316					349.90				
-	9145EZHD-28-0-643E/716					470.10				
-	9145EZHD-28-0-BLK					410.30				
See page 64 for optional mounting types and pricing.	28"	12"	Brass			605	9145EZHD-28-2-US3			
606				9145EZHD-28-2-US4			418.70			
612				9145EZHD-28-2-US10			482.40			
613				9145EZHD-28-2-US10B			482.40			
619				9145EZHD-28-2-US15			482.40			
625				9145EZHD-28-2-US26			438.90			
626			9145EZHD-28-2-US26D			438.90				
629-316			9145EZHD-28-2-32-316			410.60				
630-316			9145EZHD-28-2-32D-316			359.60				
-			9145EZHD-28-2-643E/716			482.40				
-			9145EZHD-28-2-BLK			418.70				
28"			18"	Brass	605	9145EZHD-28-18-US3				
	606	9145EZHD-28-18-US4					472.00			
	612	9145EZHD-28-18-US10					539.70			
	613	9145EZHD-28-18-US10B					539.70			
	619	9145EZHD-28-18-US15					539.70			
	625	9145EZHD-28-18-US26					491.80			
	626	9145EZHD-28-18-US26D				491.80				
	629-316	9145EZHD-28-18-32-316				466.00				
	630-316	9145EZHD-28-18-32D-316				415.30				
	-	9145EZHD-28-18-643E/716				539.70				
	-	9145EZHD-28-18-BLK				472.00				
	33"	8"		Brass	605	9145EZHD-33-8-US3				
606			9145EZHD-33-8-US4				398.30			
612			9145EZHD-33-8-US10				461.70			
613			9145EZHD-33-8-US10B				461.70			
619			9145EZHD-33-8-US15				461.70			
625			9145EZHD-33-8-US26				413.90			
626			9145EZHD-33-8-US26D			413.90				
629-316			9145EZHD-33-8-32-316			469.20				
630-316			9145EZHD-33-8-32D-316			340.20				
-			9145EZHD-33-8-643E/716			461.70				
-			9145EZHD-33-8-BLK			398.30				
33"			10"	Brass	605	9145EZHD-33-0-US3				
	606	9145EZHD-33-0-US4					410.30			
	612	9145EZHD-33-0-US10					470.10			
	613	9145EZHD-33-0-US10B					470.10			
	619	9145EZHD-33-0-US15					470.10			
	625	9145EZHD-33-0-US26					426.30			
	626	9145EZHD-33-0-US26D				426.30				
	629-316	9145EZHD-33-0-32-316				478.80				
	630-316	9145EZHD-33-0-32D-316				349.90				
	-	9145EZHD-33-0-643E/716				470.10				
	-	9145EZHD-33-0-BLK				410.30				
	33"	12"		Brass	605	9145EZHD-33-2-US3				
606			9145EZHD-33-2-US4				418.70			
612			9145EZHD-33-2-US10				482.40			
613			9145EZHD-33-2-US10B				482.40			
619			9145EZHD-33-2-US15				482.40			
625			9145EZHD-33-2-US26				438.90			
626			9145EZHD-33-2-US26D			438.90				
629-316			9145EZHD-33-2-32-316			488.60				
630-316			9145EZHD-33-2-32D-316			359.60				
-			9145EZHD-33-2-643E/716			482.40				
-			9145EZHD-33-2-BLK			418.70				
33"			18"	Brass	605	9145EZHD-33-18-US3				
	606	9145EZHD-33-18-US4					472.00			
	612	9145EZHD-33-18-US10					539.70			
	613	9145EZHD-33-18-US10B					539.70			
	619	9145EZHD-33-18-US15					539.70			
	625	9145EZHD-33-18-US26					491.80			
	626	9145EZHD-33-18-US26D				491.80				
	629-316	9145EZHD-33-18-32-316				544.00				
	630-316	9145EZHD-33-18-32D-316				415.30				
	-	9145EZHD-33-18-643E/716				539.70				
	-	9145EZHD-33-18-BLK				472.00				

Lead time exception: ** Products are stocked and will typically ship in 3-5 days

Bold pricing indicates item is in stock and available for **Fast Track** and **ProXpress**

MODEL	PUSH CTC	PULL CTC	SUBSTRATE	FINISH	MODEL NUMBER	DESCRIPTION	WEIGHT	ORDER QTY	BOX QTY	LIST PRICE	
9190HD Push / Pull Combo 1" Round (8190HD Pull + 9100HD PUSH) Custom Sizing Available in 1" increments. Fractional increments available as Engineered Specials. See page 64 for pricing Antimicrobial Coating US26D-AM or US32D-AM available. See page 64 for optional mounting types and pricing.	28"	8"	Brass	605	9190HD-28-8-US3					\$373.00	
				606	9190HD-28-8-US4				373.00		
				612	9190HD-28-8-US10				435.50		
				613	9190HD-28-8-US10B				435.50		
				619	9190HD-28-8-US15				428.40		
			625	9190HD-28-8-US26				388.70			
			626	9190HD-28-8-US26D				388.70			
			Stainless	629	9190HD-28-8-US32				315.30		
				630	9190HD-28-8-US32D				272.60		
				-	9190HD-28-8-643E/716				435.50		
	-	9190HD-28-8-BLK					373.00				
	605	9190HD-28-0-US3					384.80				
	28"	10"	Brass	606	9190HD-28-0-US4						384.80
				612	9190HD-28-0-US10						443.00
				613	9190HD-28-0-US10B				443.00		
				619	9190HD-28-0-US15				436.50		
				625	9190HD-28-0-US26				400.40		
			626	9190HD-28-0-US26D				400.40			
			Stainless	629	9190HD-28-0-US32				322.80		
				630	9190HD-28-0-US32D				280.40		
				-	9190HD-28-0-643E/716				443.00		
				-	9190HD-28-0-BLK				384.80		
	605	9190HD-28-2-US3					392.80				
	28"	12"	Brass	606	9190HD-28-2-US4						392.80
				612	9190HD-28-2-US10						455.00
				613	9190HD-28-2-US10B				455.00		
				619	9190HD-28-2-US15				448.00		
				625	9190HD-28-2-US26				412.20		
			626	9190HD-28-2-US26D				412.20			
			Stainless	629	9190HD-28-2-US32				398.60		
				630	9190HD-28-2-US32D				287.90		
				-	9190HD-28-2-643E/716				455.00		
				-	9190HD-28-2-BLK				392.80		
	605	9190HD-28-18-US3					436.50				
	28"	18"	Brass	606	9190HD-28-18-US4						436.50
				612	9190HD-28-18-US10						502.50
				613	9190HD-28-18-US10B				502.50		
				619	9190HD-28-18-US15				502.50		
				625	9190HD-28-18-US26				455.70		
			626	9190HD-28-18-US26D				455.70			
			Stainless	629	9190HD-28-18-US32				368.40		
				630	9190HD-28-18-US32D				325.60		
				-	9190HD-28-18-643E/716				502.50		
				-	9190HD-28-18-BLK				436.50		
	605	9190HD-33-8-US3					373.00				
	33"	8"	Brass	606	9190HD-33-8-US4						373.00
				612	9190HD-33-8-US10						435.50
				613	9190HD-33-8-US10B				435.50		
				619	9190HD-33-8-US15				428.40		
				625	9190HD-33-8-US26				388.70		
			626	9190HD-33-8-US26D				388.70			
			Stainless	629	9190HD-33-8-US32				315.30		
				630	9190HD-33-8-US32D				272.60		
				-	9190HD-33-8-643E/716				436.50		
				-	9190HD-33-8-BLK				373.00		
	605	9190HD-33-0-US3					384.80				
	33"	10"	Brass	606	9190HD-33-0-US4						384.80
				612	9190HD-33-0-US10						443.00
				613	9190HD-33-0-US10B				443.00		
				619	9190HD-33-0-US15				436.50		
				625	9190HD-33-0-US26				400.40		
			626	9190HD-33-0-US26D				400.40			
			Stainless	629	9190HD-33-0-US32				322.80		
				630	9190HD-33-0-US32D**				280.40		
				-	9190HD-33-0-643E/716				443.00		
				-	9190HD-33-0-BLK				384.80		
	605	9190HD-33-2-US3					392.80				
	33"	12"	Brass	606	9190HD-33-2-US4						392.80
				612	9190HD-33-2-US10						455.00
				613	9190HD-33-2-US10B				455.00		
				619	9190HD-33-2-US15				448.00		
				625	9190HD-33-2-US26				412.20		
			626	9190HD-33-2-US26D				412.20			
			Stainless	629	9190HD-33-2-US32				398.60		
				630	9190HD-33-2-US32D				287.90		
				-	9190HD-33-2-643E/716				455.00		
				-	9190HD-33-2-BLK				392.80		
	605	9190HD-33-18-US3					436.50				
	33"	18"	Brass	606	9190HD-33-18-US4						436.50
				612	9190HD-33-18-US10						502.50
				613	9190HD-33-18-US10B				502.50		
				619	9190HD-33-18-US15				502.50		
				625	9190HD-33-18-US26				455.70		
			626	9190HD-33-18-US26D				455.70			
			Stainless	629	9190HD-33-18-US32				436.20		
				630	9190HD-33-18-US32D				325.60		
				-	9190HD-33-18-643E/716				502.50		
				-	9190HD-33-18-BLK				436.50		

Lead time exception: ** Products are stocked and will typically ship in 3-5 days

Bold pricing indicates item is in stock and available for **Fast Track** and **ProXpress**

HINGES
 CONTINUOUS HINGES
 PIVOTS
 Numerical 1-059
 Numerical 59-437
 Numerical 438-1021
 Numerical 1152-8190
 Numerical 8200-9266



HINGES

CONTINUOUS
HINGES

PIVOTS

Numerical
1-059Numerical
59-437Numerical
438-1021Numerical
1152-8190Numerical
8200-9266

MODEL	PUSH CTC	PULL CTC	SUBSTRATE	FINISH	MODEL NUMBER	DESCRIPTION	WEIGHT	ORDER QTY	BOX QTY	LIST PRICE		
9190EZHD Push / Pull Combo 1" Round (8190EZHD Pull + 9100HD Push) <i>Custom Sizing Available in 1" increments</i> <i>Fractional increments available as Engineered Specials</i> See page 64 for pricing <i>Antimicrobial Coating US26D-AM or US32D-AM available.</i> See page 64 for optional mounting types and pricing.	28"	8"	Brass	605	9190EZHD-28-8-USB3					\$398.30		
				606	9190EZHD-28-8-US4				398.30			
				612	9190EZHD-28-8-US10				461.70			
				613	9190EZHD-28-8-US10B				461.70			
				619	9190EZHD-28-8-US15				461.70			
				625	9190EZHD-28-8-US26				413.90			
			626	9190EZHD-28-8-US26D				413.90				
			316 Stainless	629-316	9190EZHD-28-8-32-316				391.10			
				630-316	9190EZHD-28-8-32D-316				340.20			
		-		9190EZHD-28-8-643E/716				461.70				
		-	9190EZHD-28-8-BLK				398.30					
		28"	10"	Brass	605	9190EZHD-28-0-US3						410.30
					606	9190EZHD-28-0-US4				410.30		
					612	9190EZHD-28-0-US10				470.10		
					613	9190EZHD-28-0-US10B				470.10		
					619	9190EZHD-28-0-US15				470.10		
					625	9190EZHD-28-0-US26				426.30		
				626	9190EZHD-28-0-US26D				426.30			
	316 Stainless			629-316	9190EZHD-28-0-32-316				400.80			
				630-316	9190EZHD-28-0-32D-316				349.90			
			-	9190EZHD-28-0-643E/716				470.10				
	-		9190EZHD-28-0-BLK				410.30					
	28"		12"	Brass	605	9190EZHD-28-2-US3						418.70
					606	9190EZHD-28-2-US4				418.70		
					612	9190EZHD-28-2-US10				482.40		
					613	9190EZHD-28-2-US10B				482.40		
					619	9190EZHD-28-2-US15				482.40		
					625	9190EZHD-28-2-US26				438.90		
				626	9190EZHD-28-2-US26D				438.90			
		316 Stainless		629-316	9190EZHD-28-2-32-316				410.60			
				630-316	9190EZHD-28-2-32D-316				359.60			
			-	9190EZHD-28-2-643E/716				482.40				
		-	9190EZHD-28-2-BLK				418.70					
		28"	18"	Brass	605	9190EZHD-28-18-US3						472.00
					606	9190EZHD-28-18-US4				472.00		
					612	9190EZHD-28-18-US10				539.70		
					613	9190EZHD-28-18-US10B				539.70		
					619	9190EZHD-28-18-US15				539.70		
					625	9190EZHD-28-18-US26				491.80		
				626	9190EZHD-28-18-US26D				491.80			
	316 Stainless			629-316	9190EZHD-28-18-32-316				466.00			
				630-316	9190EZHD-28-18-32D-316				415.30			
-			9190EZHD-28-18-643E/716				539.70					
-	9190EZHD-28-18-BLK					472.00						
33"	8"		Brass	605	9190EZHD-33-8-US3						398.30	
				606	9190EZHD-33-8-US4				398.30			
				612	9190EZHD-33-8-US10				461.70			
				613	9190EZHD-33-8-US10B				461.70			
				619	9190EZHD-33-8-US15				461.70			
				625	9190EZHD-33-8-US26				413.90			
			626	9190EZHD-33-8-US26D				413.90				
		316 Stainless	629-316	9190EZHD-33-8-32-316				469.20				
			630-316	9190EZHD-33-8-32D-316				340.20				
	-		9190EZHD-33-8-643E/716				461.70					
	-	9190EZHD-33-8-BLK				398.30						
	33"	10"	Brass	605	9190EZHD-33-0-US3						410.30	
				606	9190EZHD-33-0-US4				410.30			
				612	9190EZHD-33-0-US10				470.10			
				613	9190EZHD-33-0-US10B				470.10			
				619	9190EZHD-33-0-US15				470.10			
				625	9190EZHD-33-0-US26				426.30			
			626	9190EZHD-33-0-US26D				426.30				
316 Stainless			629-316	9190EZHD-33-0-32-316				478.80				
			630-316	9190EZHD-33-0-32D-316				349.90				
		-	9190EZHD-33-0-643E/716				470.10					
-		9190EZHD-33-0-BLK				410.30						
33"		12"	Brass	605	9190EZHD-33-2-US3						418.70	
				606	9190EZHD-33-2-US4				418.70			
				612	9190EZHD-33-2-US10				482.40			
				613	9190EZHD-33-2-US10B				482.40			
				619	9190EZHD-33-2-US15				482.40			
				625	9190EZHD-33-2-US26				438.90			
			626	9190EZHD-33-2-US26D				438.90				
	316 Stainless		629-316	9190EZHD-33-2-32-316				488.60				
			630-316	9190EZHD-33-2-32D-316				359.60				
		-	9190EZHD-33-2-643E/716				482.40					
	-	9190EZHD-33-2-BLK				418.70						
	33"	18"	Brass	605	9190EZHD-33-18-US3						472.00	
				606	9190EZHD-33-18-US4				472.00			
				612	9190EZHD-33-18-US10				539.70			
				613	9190EZHD-33-18-US10B				539.70			
				619	9190EZHD-33-18-US15				539.70			
				625	9190EZHD-33-18-US26				491.80			
			626	9190EZHD-33-18-US26D				491.80				
316 Stainless			629-316	9190EZHD-33-18-32-316				544.00				
			630-316	9190EZHD-33-18-32D-316				415.30				
		-	9190EZHD-33-18-643E/716				539.70					
-		9190EZHD-33-18-BLK				472.00						

Lead time exception: ** Products are stocked and will typically ship in 3-5 days

Bold pricing indicates item is in stock and available for Fast Track and ProXpress

Offset Long Pulls

	Length	Pull CTC	FINISH	List
9264 (Round Tip) or 9264F (Flat Tip)	12"	8"	605	\$398.30
	12"	8"	606	398.30
	12"	8"	613	409.90
	12"	8"	619	409.90
	12"	8"	629-316	404.10
	12"	8"	630-316	339.60
	12"	8"	643E/716	409.90
	12"	8"	BLK	398.30
9264 (Round Tip) or 9264F (Flat Tip)	18"	12"	605	456.80
	18"	12"	606	456.80
	18"	12"	613	468.60
	18"	12"	619	468.60
	18"	12"	629-316	451.00
	18"	12"	630-316	368.90
	18"	12"	643E/716	468.60
	18"	12"	BLK	456.80
9264 (Round Tip) or 9264F (Flat Tip)	24"	18"	605	515.30
	24"	18"	606	515.30
	24"	18"	613	527.10
	24"	18"	619	527.10
	24"	18"	629-316	497.90
	24"	18"	630-316	398.30
	24"	18"	643E/716	527.10
	24"	18"	BLK	515.30
9264 (Round Tip) or 9264F (Flat Tip)	36"	20"	605	772.10
	36"	20"	606	804.90
	36"	20"	613	850.00
	36"	20"	619	850.00
	36"	20"	629-316	781.50
	36"	20"	630-316**	526.00
	36"	20"	643E/716	850.00
	36"	20"	BLK	804.90
9264 (Round Tip) or 9264F (Flat Tip)	72"	56"	605	945.80
	72"	56"	606	945.80
	72"	56"	613	983.50
	72"	56"	619	983.50
	72"	56"	629-316	918.30
	72"	56"	630-316	628.60
	72"	56"	BLK	945.80

Straight Long Pulls

9266 (Round Tip) or 9266F (Flat Tip)	12"	8"	605	\$316.30
	12"	8"	606	316.30
	12"	8"	613	322.10
	12"	8"	619	322.10
	12"	8"	629-316	316.30
	12"	8"	630-316	251.80
	12"	8"	643E/716	322.10
	12"	8"	BLK	316.30
9266 (Round Tip) or 9266F (Flat Tip)	18"	12"	605	374.80
	18"	12"	606	374.80
	18"	12"	613	380.60
	18"	12"	619	380.60
	18"	12"	629-316	363.20
	18"	12"	630-316	281.10
	18"	12"	643E/716	380.60
	18"	12"	BLK	374.80
9266 (Round Tip) or 9266F (Flat Tip)	24"	18"	605	433.40
	24"	18"	606	433.40
	24"	18"	613	439.10
	24"	18"	619	439.10
	24"	18"	629-316	409.90
	24"	18"	630-316	310.40
	24"	18"	643E/716	439.10
	24"	18"	BLK	433.40
9266 (Round Tip) or 9266F (Flat Tip)	36"	20"	605	601.20
	36"	20"	606	626.70
	36"	20"	613	642.50
	36"	20"	619	642.50
	36"	20"	629-316	608.50
	36"	20"	630-316	439.90
	36"	20"	643E/716*	642.50
	36"	20"	BLK	626.70
9266 (Round Tip) or 9266F (Flat Tip)	72"	56"	605	766.70
	72"	56"	606	766.70
	72"	56"	613	775.50
	72"	56"	619	775.50
	72"	56"	629-316	745.40
	72"	56"	630-316	550.20
	72"	56"	BLK	766.70

See Next Page for Long Pull Options Pricing

See page 64 for optional mounting types and pricing.

* Max length for 643E/716 finish is 36"

- Custom Lengths, Center to Center, and Finishes
- Additional Mounting Brackets

HINGES

CONTINUOUS HINGES

PIVOTS

Numerical 1-059

Numerical 59-437

Numerical 438-1021

Numerical 1152-8190

Numerical 8200-9266

Lead time exception: ** Products are stocked and will typically ship in 3-5 days

Bold pricing indicates item is in stock and available for Fast Track and ProXpress

Long Pull Options

Custom Lengths*		FINISH	List
· Order in 1" increments. List price for 1" increments between 12" and 72" use next larger size list price.			
· Greater than 72", use list price add per inch charge per finish.		605, 606, BLK	\$62.00
		613, 619,	71.00
		629-316	74.00
		630-316	14.00
· If fractional lengths are required, use the following list adder. For pulls less than 72" long, use the next higher standard length price plus the list adder for pricing. For pulls greater than 72", use the 72" price plus the price add per inch plus the fractional list adder.			169.00
Custom Center to Center*		FINISH	List
· If not specified, standard center to center length for pulls 36" or longer, center to center length is 16" less than total pull length. Center to Center length must be specified for lengths less than 36"			
· For non standard center to center lengths or locations on standard length pulls, use the following list adder. Consult factory if the center to center length is less than half the total pull length. If the fractional custom length adder is being applied, then the custom center to center will not be applied			85.00
Custom Finishes*		FINISH	List
Custom painting & Antimicrobial Coating <i>US32D-AM only</i>	Contact customer service for size availability, pricing, and color approval. Additional lead time up to 6 weeks may be needed.		
*Return Policy - requires prior approval, consult factory			
Optional Mounting Hardware		FINISH	List
MB	Additional Mounting Bracket, list price adder per bracket <i>Unless specified, additional mounting brackets are centered on pull. Mounting Bracket and list adder are required for pulls over 96".</i>		151.00
See page 64 for optional mounting types and pricing.			

HINGES

CONTINUOUS HINGES

PIVOTS

Numerical 1-059

Numerical 59-437

Numerical 438-1021

Numerical 1152-8190

Numerical 8200-9266

Lead time exception: ** Products are stocked and will typically ship in 3-5 days

Bold pricing indicates item is in stock and available for **Fast Track** and **ProXpress**

IVES ARCHITECTURAL HARDWARE - Parts Price List

Description	Finish	Part No.	List Price Each
3.5X3.5 HINGES Item 3CB1, 3PB1, 5BB1, 5PB1			
3.5X3.5 Hinge Mtg Pkg	600(USP)	HGPART.1171	\$3.40
3.5X3.5 Hinge Mtg Pkg	630(US32D), 629(US32), 646/619(US15)	HGPART.1170	3.40
3.5X3.5 Hinge Mtg Pkg	632/605(US3), 633/606(US4)	HGPART.1173	3.40
3.5X3.5 Hinge Mtg Pkg	639(US10), 612 (US10)	HGPART.1174	3.40
3.5X3.5 Hinge Mtg Pkg	640/613(US10B), 641/614(US10A), 643/616(US11)	HGPART.1175	3.40
3.5X3.5 Hinge Mtg Pkg	651/625(US26), 652/626(US26D)	HGPART.1176	3.40
3.5X3.5 Hinge Mtg Pkg	BLK	HGPART.1172	3.40
HINGES Item 3CB1, 3PB1, 3SP1, 5BB1, 5BB1SC, 5PB1 (4X4 Hinges or Larger)			
Hinge Mtg Pkg	605(US3), 632(US3), 633(US4)	HGPART.1001	3.40
Hinge Mtg Pkg	639(US10)	HGPART.1002	3.40
Hinge Mtg Pkg	600(USP),630(US32D),651(US26)	HGPART.1003	3.40
Hinge Mtg Pkg	643(US11)	HGPART.1004	3.40
Hinge Security Mtg Pkg	-	HGPART.1005	23.40
Hinge MS Mtg Screws Pkg of 100 - Steel	600(USP)	HGPART.1026	6.20
Hinge MS Mtg Screws Pkg of 100 - Brass	605(US3)	HGPART.1008	12.40
Hinge MS Mtg Screws Pkg of 100 - Steel	632(US3)	HGPART.1018	6.20
Hinge MS Mtg Screws Pkg of 100 - Brass	606(US4)	HGPART.1032	12.40
Hinge MS Mtg Screws Pkg of 100 - Steel	633(US4)	HGPART.1035	6.20
Hinge MS Mtg Screws Pkg of 100 - Brass	612(US10)	HGPART.1010	12.40
Hinge MS Mtg Screws Pkg of 100 - Steel	639(US10)	HGPART.1019	6.20
Hinge MS Mtg Screws Pkg of 100 - Brass	613(US10B)	HGPART.1011	12.40
Hinge MS Mtg Screws Pkg of 100 - Steel	640(US10B)	HGPART.1020	6.20
Hinge MS Mtg Screws Pkg of 100 - Steel	641(US10A)	HGPART.1028	6.20
Hinge MS Mtg Screws Pkg of 100 - Steel	643(US11)	HGPART.1029	6.20
Hinge MS Mtg Screws Pkg of 100 - Brass	619(US15)	HGPART.1009	12.40
Hinge MS Mtg Screws Pkg of 100 - Steel	646(US15)	HGPART.1021	6.20
Hinge MS Mtg Screws Pkg of 100 - Brass	625(US26)	HGPART.1033	12.40
Hinge MS Mtg Screws Pkg of 100 - Steel	651(US26)	HGPART.1036	6.20
Hinge MS Mtg Screws Pkg of 100 - Brass	626(US26D)	HGPART.1034	12.40
Hinge MS Mtg Screws Pkg of 100 - Steel	652(US26D)	HGPART.1037	6.20
Hinge MS Mtg Screws Pkg of 100 - Stainless Steel	630(US32D)	HGPART.1016	12.40
Hinge WS Mtg Screws Pkg of 100 - Steel	600(USP)	HGPART.1027	6.20
Hinge WS Mtg Screws Pkg of 100 - Brass	605(US3)	HGPART.1012	24.70
Hinge WS Mtg Screws Pkg of 100 - Steel	632(US3)	HGPART.1022	6.20
Hinge WS Mtg Screws Pkg of 100 - Brass	606(US4)	HGPART.1038	26.30
Hinge WS Mtg Screws Pkg of 100 - Steel	633(US4)	HGPART.1041	6.20
Hinge WS Mtg Screws Pkg of 100 - Brass	612(US10)	HGPART.1014	26.30
Hinge WS Mtg Screws Pkg of 100 - Steel	639(US10)	HGPART.1023	6.20
Hinge WS Mtg Screws Pkg of 100 - Brass	613(US10B)	HGPART.1015	26.30
Hinge WS Mtg Screws Pkg of 100 - Steel	640(US10B)	HGPART.1024	6.20
Hinge WS Mtg Screws Pkg of 100 - Steel	641(US10A)	HGPART.1030	6.20
Hinge WS Mtg Screws Pkg of 100 - Steel	643(US11)	HGPART.1031	6.20
Hinge WS Mtg Screws Pkg of 100 - Brass	619(US15)	HGPART.1013	24.70
Hinge WS Mtg Screws Pkg of 100 - Steel	646(US15)	HGPART.1025	6.20
Hinge WS Mtg Screws Pkg of 100 - Brass	625(US26)	HGPART.1039	24.70
Hinge WS Mtg Screws Pkg of 100 - Steel	651(US26)	HGPART.1042	6.20
Hinge WS Mtg Screws Pkg of 100 - Brass	626(US26D)	HGPART.1040	24.70
Hinge WS Mtg Screws Pkg of 100 - Steel	652(US26D)	HGPART.1043	6.20
Hinge WS Mtg Screws Pkg of 100 - Stainless Steel	630(US32D)	HGPART.1017	24.70
CONTINUOUS HINGES - GEARED			
Chinge Geared Tek Scr Pkg Us28 (Pkg of 48)	US28	HGPART.1070	22.70
Chinge Geared Tek Scr Pkg 313AN, 315AN (Pkg of 48)	313AN, 315AN	HGPART.1071	22.70
Chinge Geared Tek/Wd Scr Pkg Us28 (24 Tek/24 Wood)	US28	HGPART.1102	22.70

Contact Ives Customer Service for pricing on additional sizes and finishes

Bold pricing indicates item is in stock and available for **Fast Track** and **ProXpress**

IVES ARCHITECTURAL HARDWARE - Parts Price List

Description	Finish	Part No.	List Price Each
CONTINUOUS HINGES - GEARED (Continued)			
Chinge Geared Tek/Wd Scr Pkg 313AN, 315AN (24 Tek/24 Wood)	313AN, 315AN	HGPART.1103	\$22.70
Chinge Geared Wd Scr Pkg Us28 (Pkg of 48)	US28	HGPART.1068	22.70
Chinge Geared Wd Scr Pkg 313AN, 315AN (Pkg of 48)	313AN, 315AN	HGPART.1069	22.70
Chinge Geared Hm Sec Scr Pkg Us32D (Pkg of 24)	US32D	HGPART.1104	40.30
Chinge Geared Wd Sec Scr Pkg Us32D (Pkg of 24)	US32D	HGPART.1105	40.30
112HD TWP Panel Service Kit	US28	840737-28	284.00
112HD TWP Panel Service Kit	313AN, 315AN	840737-42	284.00
224HD TWP Panel Service Kit	US28	840738-28	284.00
224HD TWP Panel Service Kit	313AN, 315AN	840738-42	284.00
XY TWP CON Panel Service Kit	US28	HGPART.1159	335.00
XY TWP CON Panel Service Kit	313AN, 315AN	HGPART.1160	335.00
CONTINUOUS HINGES - Pin & Barrel			
Chinge Pin & Barrel #10 X 1/2 Tek Screw SELF DRILL (Pkg of 54)	US32D	HGPART.1044	25.30
Chinge Pin & Barrel #10 X 1 Flat Head Wood Screw (Pkg of 27)	US32D	HGPART.1046	12.50
Chinge Pin & Barrel Adjustment Stud (Pkg of 27)	US32D	HGPART.1048	105.00
Chinge Pin & Barrel #10 X 3/4" Tek Screw (Pkg of 27)	US32D	HGPART.1050	21.50
Chinge Pin & Barrel 120" 1/2" TEK screw pkg		HGPART.1044	25.30
Chinge Pin & Barrel 120" Full Surface screw pkg (Pan Head TEK)		HGPART.1045	20.20
Chinge Pin & Barrel 120" wood screw pkg		HGPART.1046	12.40
Chinge Pin & Barrel 120" Full Surface cover clip pkg		HGPART.1047	42.40
Chinge Pin & Barrel 120" Adjustment stud (with machine screws) pkg		HGPART.1048	99.50
Chinge Pin & Barrel 120" Full Surface sexbolt pkg		HGPART.1049	99.50
Chinge Pin & Barrel 120" 3/4" TEK screw pkg		HGPART.1050	21.20
Chinge Pin & Barrel Replacment ETW Module	US32D	HGPART.1108	339.50
Chinge Pin & Barrel 83" Full Surface screw cover	US32D	HGPART.1109	87.60
Chinge Pin & Barrel 85" Full Surface screw cover	US32D	HGPART.1110	87.60
Chinge Pin & Barrel 95" Full Surface screw cover	US32D	HGPART.1111	100.70
Chinge Pin & Barrel 120" Full Surface screw cover	US32D	HGPART.1112	116.70
Chinge Pin & Barrel 120" hollow metal security screw pkg (Torx screws)		HGPART.1113	178.40
Chinge Pin & Barrel 120" hollow metal machine screw pkg		HGPART.1114	42.40
Chinge Pin & Barrel 120" wood door security screw pkg (wood Torx screws)		HGPART.1124	178.50
700CSTWP Panel Service Kit	US32D	HGPART.1153	921.00
PIVOTS 7212/15/22/26/27 & 7215F/26F/27F Top Pivot			
7212/15/22/26/27 Top Bearing Leaf	US3	PVPART.1001	143.30
7212/15/22/26/27 Top Bearing Leaf	US4	PVPART.1002	143.30
7212/15/22/26/27 Top Bearing Leaf	US10	PVPART.1003	143.30
7212/15/22/26/27 Top Bearing Leaf	US10B	PVPART.1004	143.30
7212/15/22/26/27 Top Bearing Leaf	US26	PVPART.1005	143.30
7212/15/22/26/27 Top Bearing Leaf	US26D	PVPART.1006	122.80
7212/15/22/26/27 Top Bearing Leaf	SP4	PVPART.1007	88.30
7212/15/22/26/27 Top Bearing Leaf	SPI0	PVPART.1008	88.30
7212/15/22/26/27 Top Bearing Leaf	SP28	PVPART.1009	88.30
7212/15/22/26/27 Top Bearing Leaf	SP313	PVPART.1010	88.30
7212/15/22/26/27 Top Bearing Leaf	SPBLK	PVPART.1011	88.30
7212/15/22/26/27 Top Pin Leaf	US3	PVPART.1012	143.30
7212/15/22/26/27 Top Pin Leaf	US4	PVPART.1013	143.30
7212/15/22/26/27 Top Pin Leaf	US10	PVPART.1014	143.30
7212/15/22/26/27 Top Pin Leaf	US10B	PVPART.1015	143.30
7212/15/22/26/27 Top Pin Leaf	US26	PVPART.1016	143.30
7212/15/22/26/27 Top Pin Leaf	US26D	PVPART.1017	122.80

Contact Ives Customer Service for pricing on additional sizes and finishes

Bold pricing indicates item is in stock and available for **Fast Track** and **ProXpress**

IVES ARCHITECTURAL HARDWARE - Parts Price List

Description	Finish	Part No.	List Price Each
PIVOTS 7212/15/22/26/27 & 7215F/26F/27F Top Pivot (Continued)			
7212/15/22/26/27 Top Pin Leaf	SP4	PVPART.1018	\$88.30
7212/15/22/26/27 Top Pin Leaf	SP10	PVPART.1019	88.30
7212/15/22/26/27 Top Pin Leaf	SP28	PVPART.1020	88.30
7212/15/22/26/27 Top Pin Leaf	SP313	PVPART.1021	88.30
7212/15/22/26/27 Top Pin Leaf	SPBLK	PVPART.1022	88.30
7215F/26F/27F Top Bearing Leaf	US3	PVPART.1227	253.90
7215F/26F/27F Top Bearing Leaf	US10	PVPART.1228	253.90
7215F/26F/27F Top Bearing Leaf	US32	PVPART.1229	253.90
7215F/26F/27F Top Bearing Leaf	US32D	PVPART.1230	219.40
7215F/26F/27F Top Bearing Leaf	SP4	PVPART.1231	184.70
7215F/26F/27F Top Bearing Leaf	SP10	PVPART.1232	184.70
7215F/26F/27F Top Bearing Leaf	SP28	PVPART.1233	184.70
7215F/26F/27F Top Bearing Leaf	SP313	PVPART.1234	184.70
7215F/26F/27F Top Bearing Leaf	SPBLK	PVPART.1235	184.70
7215F/26F/27F Top Pin Leaf	US3	PVPART.1236	253.90
7215F/26F/27F Top Pin Leaf	US10	PVPART.1237	253.90
7215F/26F/27F Top Pin Leaf	US32	PVPART.1238	253.90
7215F/26F/27F Top Pin Leaf	US32D	PVPART.1239	219.40
7215F/26F/27F Top Pin Leaf	SP4	PVPART.1240	184.70
7215F/26F/27F Top Pin Leaf	SP10	PVPART.1241	184.70
7215F/26F/27F Top Pin Leaf	SP28	PVPART.1242	184.70
7215F/26F/27F Top Pin Leaf	SP313	PVPART.1243	184.70
7215F/26F/27F Top Pin Leaf	SPBLK	PVPART.1244	184.70
7212/12V/15/22/26/27/44/45 Top Mounting Pkg	US3, US4, SP4	PVPART.1023	15.20
7212/12V/15/22/26/27/44/45 Top Mounting Pkg	US10, SP10	PVPART.1024	15.20
7212/12V/15/22/26/27/44/45 Top Mounting Pkg	US10B, SP313	PVPART.1025	15.20
7212/12V/15/22/26/27/44/45 Top Mounting Pkg	US26, US26D, SP28, US32, US32D	PVPART.1026	15.20
7212/12V/15/22/26/27/44/45 Top Mounting Pkg	SPBLK	PVPART.1027	15.20
7212/12V/15/22/26/27/44/45 Top Security Mtg Pkg	-	PVPART.1028	27.50
7212/12V/15/22/26/27/44/45 Top Wood Mtg Pkg	US3, US4, SP4	PVPART.1821	13.90
7212/12V/15/22/26/27/44/45 Top Wood Mtg Pkg	US10, SP10	PVPART.1822	13.90
7212/12V/15/22/26/27/44/45 Top Wood Mtg Pkg	US10B, SP313	PVPART.1823	13.90
7212/12V/15/22/26/27/44/45 Top Wood Mtg Pkg	US26, US26D, SP28, US32, US32D	PVPART.1824	13.90
7212/12V/15/22/26/27/44/45 Top Wood Mtg Pkg	SPBLK	PVPART.1825	13.90
7212/15/22/26/27/30/37/44/45 Top Pivot Pin	-	PVPART.1029	7.00
Pivot Set Screw (Pkg of 10)	-	PVPART.1030	5.60
Pivot Bushing	-	PVPART.1870	3.40
7212/15/22/26/27/30/37/44/45 Cap Screw	US3	PVPART.1032	22.00
7212/15/22/26/27/30/37/44/45 Cap Screw	US4	PVPART.1033	22.00
7212/15/22/26/27/30/37/44/45 Cap Screw	US10	PVPART.1034	22.00
7212/15/22/26/27/30/37/44/45 Cap Screw	US10B	PVPART.1035	22.00
7212/15/22/26/27/30/37/44/45 Cap Screw	US26, US32	PVPART.1036	22.00
7212/15/22/26/27/30/37/44/45 Cap Screw	US26D, US32D	PVPART.1037	22.00
7212/15/22/26/27/30/37/44/45 Cap Screw	SP4	PVPART.1038	22.00
7212/15/22/26/27/30/37/44/45 Cap Screw	SP10	PVPART.1039	22.00
7212/15/22/26/27/30/37/44/45 Cap Screw	SP28	PVPART.1040	22.00
7212/15/22/26/27/30/37/44/45 Cap Screw	SP313	PVPART.1041	22.00
7212/15/22/26/27/30/37/44/45 Cap Screw	SPBLK	PVPART.1042	22.00
7212V Top Pivot			
7212V Top Door Leaf - RH	US3	PVPART.1144	149.10
7212V Top Door Leaf - RH	US4	PVPART.1145	149.10
7212V Top Door Leaf - RH	US10	PVPART.1146	149.10
7212V Top Door Leaf - RH	US10B	PVPART.1147	149.10

Contact Ives Customer Service for pricing on additional sizes and finishes

Bold pricing indicates item is in stock and available for **Fast Track** and **ProXpress**

IVES ARCHITECTURAL HARDWARE - Parts Price List

Description	Finish	Part No.	List Price Each
7212V Top Pivot (Continued)			
7212V Top Door Leaf - RH	US26	PVPART.1148	149.10
7212V Top Door Leaf - RH	US26D	PVPART.1149	128.10
7212V Top Door Leaf - RH	SP4	PVPART.1150	97.80
7212V Top Door Leaf - RH	SP10	PVPART.1151	97.80
7212V Top Door Leaf - RH	SP28	PVPART.1152	97.80
7212V Top Door Leaf - RH	SP313	PVPART.1153	97.80
7212V Top Door Leaf - RH	SPBLK	PVPART.1154	97.80
7212V Top Jamb Leaf - RH	US3	PVPART.1155	149.10
7212V Top Jamb Leaf - RH	US4	PVPART.1156	149.10
7212V Top Jamb Leaf - RH	US10	PVPART.1157	149.10
7212V Top Jamb Leaf - RH	US10B	PVPART.1158	149.10
7212V Top Jamb Leaf - RH	US26	PVPART.1159	149.10
7212V Top Jamb Leaf - RH	US26D	PVPART.1160	128.10
7212V Top Jamb Leaf - RH	SP4	PVPART.1161	97.80
7212V Top Jamb Leaf - RH	SP10	PVPART.1162	97.80
7212V Top Jamb Leaf - RH	SP28	PVPART.1163	97.80
7212V Top Jamb Leaf - RH	SP313	PVPART.1164	97.80
7212V Top Jamb Leaf - RH	SPBLK	PVPART.1165	97.80
7212V Top Door Leaf - LH	US3	PVPART.1166	149.10
7212V Top Door Leaf - LH	US4	PVPART.1167	149.10
7212V Top Door Leaf - LH	US10	PVPART.1168	149.10
7212V Top Door Leaf - LH	US10B	PVPART.1169	149.10
7212V Top Door Leaf - LH	US26	PVPART.1170	149.10
7212V Top Door Leaf - LH	US26D	PVPART.1171	128.10
7212V Top Door Leaf - LH	SP4	PVPART.1172	97.80
7212V Top Door Leaf - LH	SP10	PVPART.1173	97.80
7212V Top Door Leaf - LH	SP28	PVPART.1174	97.80
7212V Top Door Leaf - LH	SP313	PVPART.1175	97.80
7212V Top Door Leaf - LH	SPBLK	PVPART.1176	97.80
7212V Top Jamb Leaf - LH	US3	PVPART.1177	149.10
7212V Top Jamb Leaf - LH	US4	PVPART.1178	149.10
7212V Top Jamb Leaf - LH	US10	PVPART.1179	149.10
7212V Top Jamb Leaf - LH	US10B	PVPART.1180	149.10
7212V Top Jamb Leaf - LH	US26	PVPART.1181	149.10
7212V Top Jamb Leaf - LH	US26D	PVPART.1182	128.10
7212V Top Jamb Leaf - LH	SP4	PVPART.1183	97.80
7212V Top Jamb Leaf - LH	SP10	PVPART.1184	97.80
7212V Top Jamb Leaf - LH	SP28	PVPART.1185	97.80
7212V Top Jamb Leaf - LH	SP313	PVPART.1186	97.80
7212V Top Jamb Leaf - LH	SPBLK	PVPART.1187	97.80
7212/12V/15/26/27/44/45 Top Mtg Pkg	US3, US4, SP4	PVPART.1023	15.20
7212/12V/15/26/27/44/45 Top Mtg Pkg	US10, SP10	PVPART.1024	15.20
7212/12V/15/26/27/44/45 Top Mtg Pkg	US10B, SP313	PVPART.1025	15.20
7212/12V/15/26/27/44/45 Top Mtg Pkg	US26, US26D, SP28	PVPART.1026	15.20
7212/12V/15/26/27/44/45 Top Mtg Pkg	SPBLK	PVPART.1027	15.20
7212/12V/15/26/27/44/45 Top Wood Mtg Pkg	US3, US4, SP4	PVPART.1821	13.90
7212/12V/15/26/27/44/45 Top Wood Mtg Pkg	US10, SP10	PVPART.1822	13.90
7212/12V/15/26/27/44/45 Top Wood Mtg Pkg	US10B, SP313	PVPART.1823	13.90
7212/12V/15/26/27/44/45 Top Wood Mtg Pkg	US26, US26D, SP28	PVPART.1824	13.90
7212/12V/15/26/27/44/45 Top Wood Mtg Pkg	SPBLK	PVPART.1825	13.90
7212/12V/15/26/27/44/45 Top Security Mtg Pkg	-	PVPART.1028	27.50
Pivot Set Screw (Pkg of 10)	-	PVPART.1030	5.60
7212/12V/22 Pivot Bearing	-	PVPART.1031	5.60

Contact Ives Customer Service for pricing on additional sizes and finishes

Bold pricing indicates item is in stock and available for **Fast Track** and **ProXpress**

IVES ARCHITECTURAL HARDWARE - Parts Price List

Description	Finish	Part No.	List Price Each
7212V Top Pivot (Continued)			
7212/12V/22 Pivot Bearing Pin	-	PVPART.1093	5.60
7212V Pivot Pin Cap	US3	PVPART.1194	15.20
7212V Pivot Pin Cap	US4	PVPART.1195	15.20
7212V Pivot Pin Cap	US10	PVPART.1196	15.20
7212V Pivot Pin Cap	US10B	PVPART.1197	15.20
7212V Pivot Pin Cap	US26	PVPART.1198	15.20
7212V Pivot Pin Cap	US26D	PVPART.1199	15.20
7212V Pivot Pin Cap	SP4	PVPART.1200	15.20
7212V Pivot Pin Cap	SP10	PVPART.1201	15.20
7212V Pivot Pin Cap	SP28	PVPART.1202	15.20
7212V Pivot Pin Cap	SP313	PVPART.1203	15.20
7212V Pivot Pin Cap	SPBLK	PVPART.1204	15.20
7230F/37F Top Pivot			
7230F/37F Top Bearing Leaf	US3	PVPART.1517	235.70
7230F/37F Top Bearing Leaf	US10	PVPART.1518	235.70
7230F/37F Top Bearing Leaf	US32	PVPART.1519	235.70
7230F/37F Top Bearing Leaf	US32D	PVPART.1520	219.40
7230F/37F Top Bearing Leaf	SP4	PVPART.1521	194.40
7230F/37F Top Bearing Leaf	SP10	PVPART.1522	194.40
7230F/37F Top Bearing Leaf	SP28	PVPART.1523	194.40
7230F/37F Top Bearing Leaf	SP313	PVPART.1524	194.40
7230F/37F Top Bearing Leaf	SPBLK	PVPART.1525	194.40
7230F/37F Top Pin Leaf	US3	PVPART.1526	235.70
7230F/37F Top Pin Leaf	US10	PVPART.1527	235.70
7230F/37F Top Pin Leaf	US32	PVPART.1528	235.70
7230F/37F Top Pin Leaf	US32D	PVPART.1529	219.40
7230F/37F Top Pin Leaf	SP4	PVPART.1530	194.40
7230F/37F Top Pin Leaf	SP10	PVPART.1531	194.40
7230F/37F Top Pin Leaf	SP28	PVPART.1532	194.40
7230F/37F Top Pin Leaf	SP313	PVPART.1533	194.40
7230F/37F Top Pin Leaf	SPBLK	PVPART.1534	194.40
7230F/37F Top Mounting Pkg	US3, SP4	PVPART.1535	22.00
7230F/37F Top Mounting Pkg	US10, SP10	PVPART.1536	22.00
7230F/37F Top Mounting Pkg	US32, US32D, SP28	PVPART.1537	22.00
7230F/37F Top Mounting Pkg	SP313	PVPART.1542	22.00
7230F/37F Top Mounting Pkg	SPBLK	PVPART.1543	22.00
7230F/37F Top Security Mounting Pkg	-	PVPART.1544	40.10
7230F/37F Top Wood Mtg Pkg	US3, SP4	PVPART.1841	17.30
7230F/37F Top Wood Mtg Pkg	US10, SP10	PVPART.1842	17.30
7230F/37F Top Wood Mtg Pkg	US32, US32D, SP28	PVPART.1843	17.30
7230F/37F Top Wood Mtg Pkg	SP313	PVPART.1844	17.30
7230F/37F Top Wood Mtg Pkg	SPBLK	PVPART.1845	17.30
7212/15/22/26/27/30/37/44/45 Top Pivot Pin	-	PVPART.1029	7.00
Pivot Set Screw (Pkg of 10)	-	PVPART.1030	5.60
Pivot Bushing	-	PVPART.1870	3.40
7212/15/22/26/27/30/37/44/45 Cap Screw	US3	PVPART.1032	22.00
7212/15/22/26/27/30/37/44/45 Cap Screw	US10	PVPART.1034	22.00
7212/15/22/26/27/30/37/44/45 Cap Screw	US32	PVPART.1036	22.00
7212/15/22/26/27/30/37/44/45 Cap Screw	US32D	PVPART.1037	22.00
7212/15/22/26/27/30/37/44/45 Cap Screw	SP4	PVPART.1038	22.00
7212/15/22/26/27/30/37/44/45 Cap Screw	SP10	PVPART.1039	22.00
7212/15/22/26/27/30/37/44/45 Cap Screw	SP28	PVPART.1040	22.00

Contact Ives Customer Service for pricing on additional sizes and finishes

Bold pricing indicates item is in stock and available for **Fast Track** and **ProXpress**

IVES ARCHITECTURAL HARDWARE - Parts Price List

Description	Finish	Part No.	List Price Each
7230F/37F Top Pivot (Continued)			
7212/15/22/26/27/30/37/44/45 Cap Screw	SP313	PVPART.1041	22.00
7212/15/22/26/27/30/37/44/45 Cap Screw	SPBLK	PVPART.1042	22.00
7244F/45F Top Pivot			
7244F/45F Top Bearing Leaf	US3	PVPART.1615	256.20
7244F/45F Top Bearing Leaf	US10	PVPART.1616	256.20
7244F/45F Top Bearing Leaf	US32	PVPART.1617	256.20
7244F/45F Top Bearing Leaf	US32D	PVPART.1618	245.60
7244F/45F Top Bearing Leaf	SP4	PVPART.1619	223.30
7244F/45F Top Bearing Leaf	SP10	PVPART.1620	223.30
7244F/45F Top Bearing Leaf	SP28	PVPART.1621	223.30
7244F/45F Top Bearing Leaf	SP313	PVPART.1622	223.30
7244F/45F Top Bearing Leaf	SPBLK	PVPART.1623	223.30
7244F/45F Top Pin Leaf	US3	PVPART.1624	256.20
7244F/45F Top Pin Leaf	US10	PVPART.1625	256.20
7244F/45F Top Pin Leaf	US32	PVPART.1626	256.20
7244F/45F Top Pin Leaf	US32D	PVPART.1627	245.60
7244F/45F Top Pin Leaf	SP4	PVPART.1628	223.30
7244F/45F Top Pin Leaf	SP10	PVPART.1629	223.30
7244F/45F Top Pin Leaf	SP28	PVPART.1630	223.30
7244F/45F Top Pin Leaf	SP313	PVPART.1631	223.30
7244F/45F Top Pin Leaf	SPBLK	PVPART.1632	223.30
7212/12V/15/26/27/44/45 Top Mounting Pkg	US3, SP4	PVPART.1023	15.20
7212/12V/15/26/27/44/45 Top Mounting Pkg	US10, SP10	PVPART.1024	15.20
7212/12V/15/26/27/44/45 Top Mounting Pkg	US32, US32D, SP28	PVPART.1026	15.20
7212/12V/15/26/27/44/45 Top Mounting Pkg	SP313	PVPART.1025	15.20
7212/12V/15/26/27/44/45 Top Mounting Pkg	SPBLK	PVPART.1027	15.20
7212/12V/15/26/27/44/45 Top Security Mtg Pkg	-	PVPART.1028	27.50
7212/12V/15/26/27/44/45 Top Wood Mtg Pkg	US3, SP4	PVPART.1821	13.90
7212/12V/15/26/27/44/45 Top Wood Mtg Pkg	US10, SP10	PVPART.1822	13.90
7212/12V/15/26/27/44/45 Top Wood Mtg Pkg	US32, US32D, SP28	PVPART.1824	13.90
7212/12V/15/26/27/44/45 Top Wood Mtg Pkg	SP313	PVPART.1823	13.90
7212/12V/15/26/27/44/45 Top Wood Mtg Pkg	SPBLK	PVPART.1825	13.90
7212/15/22/26/27/30/37/44/45 Top Pivot Pin	-	PVPART.1029	7.00
Pivot Set Screw (Pkg of 10)	-	PVPART.1030	5.60
Pivot Bushing	-	PVPART.1870	3.40
7212/15/22/26/27/30/37/44/45 Cover Cap Screw	US3	PVPART.1032	22.00
7212/15/22/26/27/30/37/44/45 Cover Cap Screw	US10	PVPART.1034	22.00
7212/15/22/26/27/30/37/44/45 Cover Cap Screw	US32	PVPART.1036	22.00
7212/15/22/26/27/30/37/44/45 Cover Cap Screw	US32D	PVPART.1037	22.00
7212/15/22/26/27/30/37/44/45 Cover Cap Screw	SP4	PVPART.1038	22.00
7212/15/22/26/27/30/37/44/45 Cover Cap Screw	SP10	PVPART.1039	22.00
7212/15/22/26/27/30/37/44/45 Cover Cap Screw	SP28	PVPART.1040	22.00
7212/15/22/26/27/30/37/44/45 Cover Cap Screw	SP313	PVPART.1041	22.00
7212/15/22/26/27/30/37/44/45 Cover Cap Screw	SPBLK	PVPART.1042	22.00
7253/55/55J/56 Top Pivot			
7253/55/55J/56 Top Door Leaf	-	PVPART.1705	194.40
7253/55/55J/56 Top Frame Leaf	US3	PVPART.1706	194.40
7253/55/55J/56 Top Frame Leaf	US4	PVPART.1707	194.40
7253/55/55J/56 Top Frame Leaf	US10	PVPART.1708	194.40
7253/55/55J/56 Top Frame Leaf	US10B	PVPART.1709	194.40
7253/55/55J/56 Top Frame Leaf	US26	PVPART.1710	194.40
7253/55/55J/56 Top Frame Leaf	US26D	PVPART.1711	194.40
7253/55/55J/56 Top Frame Leaf	SP4	PVPART.1712	168.30

Contact Ives Customer Service for pricing on additional sizes and finishes

Bold pricing indicates item is in stock and available for **Fast Track** and **ProXpress**

IVES ARCHITECTURAL HARDWARE - Parts Price List

Description	Finish	Part No.	List Price Each
7253/55/55J/56 Top Pivot(Continued)			
7253/55/55J/56 Top Frame Leaf	SP10	PVPART.1713	168.30
7253/55/55J/56 Top Frame Leaf	SP28	PVPART.1714	168.30
7253/55/55J/56 Top Frame Leaf	SP313	PVPART.1715	168.30
7253/55/55J/56 Top Frame Leaf	SPBLK	PVPART.1716	168.30
7253/55/55J/56 Top Finish Plate Pkg	US3	PVPART.1717	81.20
7253/55/55J/56 Top Finish Plate Pkg	US4	PVPART.1718	81.20
7253/55/55J/56 Top Finish Plate Pkg	US10	PVPART.1719	81.20
7253/55/55J/56 Top Finish Plate Pkg	US10B	PVPART.1720	81.20
7253/55/55J/56 Top Finish Plate Pkg	US26	PVPART.1721	81.20
7253/55/55J/56 Top Finish Plate Pkg	US26D	PVPART.1722	81.20
7253/55/55J/56 Top Finish Plate Pkg	SP4	PVPART.1723	51.00
7253/55/55J/56 Top Finish Plate Pkg	SP10	PVPART.1724	51.00
7253/55/55J/56 Top Finish Plate Pkg	SP28	PVPART.1725	51.00
7253/55/55J/56 Top Finish Plate Pkg	SP313	PVPART.1726	51.00
7253/55/55J/56 Top Finish Plate Pkg	SPBLK	PVPART.1727	51.00
7227/37/45/56/59 Finish Plate Screw (Pkg of 10)	-	PVPART.1335	2.00
7253/55/55J/56/59 Top Mounting Pkg	US3, US4, SP4	PVPART.1729	15.20
7253/55/55J/56/59 Top Mounting Pkg	US10, SP10	PVPART.1730	15.20
7253/55/55J/56/59 Top Mounting Pkg	US10B, SP313	PVPART.1731	15.20
7253/55/55J/56/59 Top Mounting Pkg	US26, US26D, SP28	PVPART.1732	15.20
7253/55/55J/56/59 Top Mounting Pkg	SPBLK	PVPART.1733	15.20
7253/55/55J/56/59 Top Security Mtg Pkg	-	PVPART.1734	20.70
7253/55/55J/56/59 Top Wood Mtg Pkg	US3, US4, SP4	PVPART.1859	9.70
7253/55/55J/56/59 Top Wood Mtg Pkg	US10, SP10	PVPART.1860	9.70
7253/55/55J/56/59 Top Wood Mtg Pkg	US10B, SP313	PVPART.1861	9.70
7253/55/55J/56/59 Top Wood Mtg Pkg	US26, US26D, SP28	PVPART.1862	9.70
7253/55/55J/56/59 Top Wood Mtg Pkg	SPBLK	PVPART.1863	9.70
7259 Top Pivot			
7259 Top Door Leaf	-	PVPART.1788	194.40
7259 Top Frame Leaf	US3	PVPART.1789	194.40
7259 Top Frame Leaf	US4	PVPART.1790	194.40
7259 Top Frame Leaf	US10	PVPART.1791	194.40
7259 Top Frame Leaf	US10B	PVPART.1792	194.40
7259 Top Frame Leaf	US26	PVPART.1793	194.40
7259 Top Frame Leaf	US26D	PVPART.1794	194.40
7259 Top Frame Leaf	SP4	PVPART.1795	168.30
7259 Top Frame Leaf	SP10	PVPART.1796	168.30
7259 Top Frame Leaf	SP28	PVPART.1797	168.30
7259 Top Frame Leaf	SP313	PVPART.1798	168.30
7259 Top Frame Leaf	SPBLK	PVPART.1799	168.30
7259 Top Finish Plate Pkg	US3	PVPART.1800	81.20
7259 Top Finish Plate Pkg	US4	PVPART.1801	81.20
7259 Top Finish Plate Pkg	US10	PVPART.1802	81.20
7259 Top Finish Plate Pkg	US10B	PVPART.1803	81.20
7259 Top Finish Plate Pkg	US26	PVPART.1804	81.20
7259 Top Finish Plate Pkg	US26D	PVPART.1805	81.20
7259 Top Finish Plate Pkg	SP4	PVPART.1806	51.00
7259 Top Finish Plate Pkg	SP10	PVPART.1807	51.00
7259 Top Finish Plate Pkg	SP28	PVPART.1808	51.00
7259 Top Finish Plate Pkg	SP313	PVPART.1809	51.00
7259 Top Finish Plate Pkg	SPBLK	PVPART.1810	51.00
7227/37/45/56/59 Finish Plate Screw (Pkg of 10)	-	PVPART.1335	2.00
7253/55/55J/56/59 Top Mounting Pkg	US3, US4, SP4	PVPART.1729	15.20

Contact Ives Customer Service for pricing on additional sizes and finishes

Bold pricing indicates item is in stock and available for **Fast Track** and **ProXpress**

IVES ARCHITECTURAL HARDWARE - Parts Price List

Description	Finish	Part No.	List Price Each
7259 Top Pivot (Continued)			
7253/55/55J/56/59 Top Mounting Pkg	US10, SP10	PVPART.1730	15.20
7253/55/55J/56/59 Top Mounting Pkg	US10B, SP313	PVPART.1731	15.20
7253/55/55J/56/59 Top Mounting Pkg	US26, US26D, SP28	PVPART.1732	15.20
7253/55/55J/56/59 Top Mounting Pkg	SPBLK	PVPART.1733	15.20
7253/55/55J/56/59 Top Security Mtg Pkg	-	PVPART.1734	20.70
7253/55/55J/56/59 Top Wood Mtg Pkg	US3, US4, SP4	PVPART.1859	9.70
7253/55/55J/56/59 Top Wood Mtg Pkg	US10, SP10	PVPART.1860	9.70
7253/55/55J/56/59 Top Wood Mtg Pkg	US10B, SP313	PVPART.1861	9.70
7253/55/55J/56/59 Top Wood Mtg Pkg	US26, US26D, SP28	PVPART.1862	9.70
7253/55/55J/56/59 Top Wood Mtg Pkg	SPBLK	PVPART.1863	9.70
7212/12V/22 Intermediate Pivot			
7212/12V/22 Int Door Leaf - RH	US3	PVPART.1094	164.20
7212/12V/22 Int Door Leaf - RH	US4	PVPART.1095	164.20
7212/12V/22 Int Door Leaf - RH	US10	PVPART.1096	164.20
7212/12V/22 Int Door Leaf - RH	US10B	PVPART.1097	164.20
7212/12V/22 Int Door Leaf - RH	US26	PVPART.1098	164.20
7212/12V/22 Int Door Leaf - RH	US26D	PVPART.1099	143.30
7212/12V/22 Int Door Leaf - RH	SP4	PVPART.1100	114.50
7212/12V/22 Int Door Leaf - RH	SP10	PVPART.1101	114.50
7212/12V/22 Int Door Leaf - RH	SP28	PVPART.1102	114.50
7212/12V/22 Int Door Leaf - RH	SP313	PVPART.1103	114.50
7212/12V/22 Int Door Leaf - RH	SPBLK	PVPART.1104	114.50
7212/12V/22 Int Jamb Leaf - RH	US3	PVPART.1105	164.20
7212/12V/22 Int Jamb Leaf - RH	US4	PVPART.1106	164.20
7212/12V/22 Int Jamb Leaf - RH	US10	PVPART.1107	164.20
7212/12V/22 Int Jamb Leaf - RH	US10B	PVPART.1108	164.20
7212/12V/22 Int Jamb Leaf - RH	US26	PVPART.1109	164.20
7212/12V/22 Int Jamb Leaf - RH	US26D	PVPART.1110	143.30
7212/12V/22 Int Jamb Leaf - RH	SP4	PVPART.1111	114.50
7212/12V/22 Int Jamb Leaf - RH	SP10	PVPART.1112	114.50
7212/12V/22 Int Jamb Leaf - RH	SP28	PVPART.1113	114.50
7212/12V/22 Int Jamb Leaf - RH	SP313	PVPART.1114	114.50
7212/12V/22 Int Jamb Leaf - RH	SPBLK	PVPART.1115	114.50
7212/12V/22 Int Door Leaf - LH	US3	PVPART.1116	164.20
7212/12V/22 Int Door Leaf - LH	US4	PVPART.1117	164.20
7212/12V/22 Int Door Leaf - LH	US10	PVPART.1118	164.20
7212/12V/22 Int Door Leaf - LH	US10B	PVPART.1119	164.20
7212/12V/22 Int Door Leaf - LH	US26	PVPART.1120	164.20
7212/12V/22 Int Door Leaf - LH	US26D	PVPART.1121	143.30
7212/12V/22 Int Door Leaf - LH	SP4	PVPART.1122	114.50
7212/12V/22 Int Door Leaf - LH	SP10	PVPART.1123	114.50
7212/12V/22 Int Door Leaf - LH	SP28	PVPART.1124	114.50
7212/12V/22 Int Door Leaf - LH	SP313	PVPART.1125	114.50
7212/12V/22 Int Door Leaf - LH	SPBLK	PVPART.1126	114.50
7212/12V/22 Int Jamb Leaf - LH	US3	PVPART.1127	164.20
7212/12V/22 Int Jamb Leaf - LH	US4	PVPART.1128	164.20
7212/12V/22 Int Jamb Leaf - LH	US10	PVPART.1129	164.20
7212/12V/22 Int Jamb Leaf - LH	US10B	PVPART.1130	164.20
7212/12V/22 Int Jamb Leaf - LH	US26	PVPART.1131	164.20
7212/12V/22 Int Jamb Leaf - LH	US26D	PVPART.1132	143.30
7212/12V/22 Int Jamb Leaf - LH	SP4	PVPART.1133	114.50
7212/12V/22 Int Jamb Leaf - LH	SP10	PVPART.1134	114.50
7212/12V/22 Int Jamb Leaf - LH	SP28	PVPART.1135	114.50

Contact Ives Customer Service for pricing on additional sizes and finishes

Bold pricing indicates item is in stock and available for **Fast Track** and **ProXpress**

IVES ARCHITECTURAL HARDWARE - Parts Price List

Description	Finish	Part No.	List Price Each
7212/12V/22 Intermediate Pivot (Continued)			
7212/12V/22 Int Jamb Leaf - LH	SP313	PVPART.1136	114.50
7212/12V/22 Int Jamb Leaf - LH	SPBLK	PVPART.1137	114.50
7212/12V/22 Int Mounting Pkg	US3, US4, SP4	PVPART.1138	13.90
7212/12V/22 Int Mounting Pkg	US10, SP10	PVPART.1139	13.90
7212/12V/22 Int Mounting Pkg	US10B, SP313	PVPART.1140	13.90
7212/12V/22 Int Mounting Pkg	US26, US26D, SP28	PVPART.1141	13.90
7212/12V/22 Int Mounting Pkg	SPBLK	PVPART.1142	13.90
7212/12V/22 Int Wood Mtg Pkg	US3, US4, SP4	PVPART.1831	10.20
7212/12V/22 Int Wood Mtg Pkg	US10, SP10	PVPART.1832	10.20
7212/12V/22 Int Wood Mtg Pkg	US10B, SP313	PVPART.1833	10.20
7212/12V/22 Int Wood Mtg Pkg	US26, US26D, SP28	PVPART.1834	10.20
7212/12V/22 Int Wood Mtg Pkg	SPBLK	PVPART.1835	10.20
7212/12V/22 Int Security Mtg Pkg	-	PVPART.1143	20.70
Pivot Set Screw (Pkg of 10)	-	PVPART.1030	5.60
7212/12V/22 Pivot Bearing	-	PVPART.1031	5.60
7212/12V/22 Pivot Bearing Pin	-	PVPART.1093	5.60
7215/26/27 & 7215F/26F/27F Intermediate Pivot			
7215/26/27 Int Door Leaf - RH	US3	PVPART.1354	149.10
7215/26/27 Int Door Leaf - RH	US4	PVPART.1355	149.10
7215/26/27 Int Door Leaf - RH	US10	PVPART.1356	149.10
7215/26/27 Int Door Leaf - RH	US10B	PVPART.1357	149.10
7215/26/27 Int Door Leaf - RH	US26	PVPART.1358	149.10
7215/26/27 Int Door Leaf - RH	US26D	PVPART.1359	133.60
7215/26/27 Int Door Leaf - RH	SP4	PVPART.1360	122.80
7215/26/27 Int Door Leaf - RH	SP10	PVPART.1361	122.80
7215/26/27 Int Door Leaf - RH	SP28	PVPART.1362	122.80
7215/26/27 Int Door Leaf - RH	SP313	PVPART.1363	122.80
7215/26/27 Int Door Leaf - RH	SPBLK	PVPART.1364	122.80
7215/26/27 Int Jamb Leaf - RH	US3	PVPART.1365	149.10
7215/26/27 Int Jamb Leaf - RH	US4	PVPART.1366	149.10
7215/26/27 Int Jamb Leaf - RH	US10	PVPART.1367	149.10
7215/26/27 Int Jamb Leaf - RH	US10B	PVPART.1368	149.10
7215/26/27 Int Jamb Leaf - RH	US26	PVPART.1369	149.10
7215/26/27 Int Jamb Leaf - RH	US26D	PVPART.1370	133.60
7215/26/27 Int Jamb Leaf - RH	SP4	PVPART.1371	122.80
7215/26/27 Int Jamb Leaf - RH	SP10	PVPART.1372	122.80
7215/26/27 Int Jamb Leaf - RH	SP28	PVPART.1373	122.80
7215/26/27 Int Jamb Leaf - RH	SP313	PVPART.1374	122.80
7215/26/27 Int Jamb Leaf - RH	SPBLK	PVPART.1375	122.80
7215/26/27 Int Door Leaf - LH	US3	PVPART.1376	149.10
7215/26/27 Int Door Leaf - LH	US4	PVPART.1377	149.10
7215/26/27 Int Door Leaf - LH	US10	PVPART.1378	149.10
7215/26/27 Int Door Leaf - LH	US10B	PVPART.1379	149.10
7215/26/27 Int Door Leaf - LH	US26	PVPART.1380	149.10
7215/26/27 Int Door Leaf - LH	US26D	PVPART.1381	133.60
7215/26/27 Int Door Leaf - LH	SP4	PVPART.1382	122.80
7215/26/27 Int Door Leaf - LH	SP10	PVPART.1383	122.80
7215/26/27 Int Door Leaf - LH	SP28	PVPART.1384	122.80
7215/26/27 Int Door Leaf - LH	SP313	PVPART.1385	122.80
7215/26/27 Int Door Leaf - LH	SPBLK	PVPART.1386	122.80
7215/26/27 Int Jamb Leaf - LH	US3	PVPART.1387	149.10
7215/26/27 Int Jamb Leaf - LH	US4	PVPART.1388	149.10
7215/26/27 Int Jamb Leaf - LH	US10	PVPART.1389	149.10

Contact Ives Customer Service for pricing on additional sizes and finishes

Bold pricing indicates item is in stock and available for **Fast Track** and **ProXpress**

IVES ARCHITECTURAL HARDWARE - Parts Price List

Description	Finish	Part No.	List Price Each
7215/26/27 & 7215F/26F/27F Intermediate Pivot (Continued)			
7215/26/27 Int Jamb Leaf - LH	US10B	PVPART.1390	149.10
7215/26/27 Int Jamb Leaf - LH	US26	PVPART.1391	149.10
7215/26/27 Int Jamb Leaf - LH	US26D	PVPART.1392	133.60
7215/26/27 Int Jamb Leaf - LH	SP4	PVPART.1393	122.80
7215/26/27 Int Jamb Leaf - LH	SP10	PVPART.1394	122.80
7215/26/27 Int Jamb Leaf - LH	SP28	PVPART.1395	122.80
7215/26/27 Int Jamb Leaf - LH	SP313	PVPART.1396	122.80
7215/26/27 Int Jamb Leaf - LH	SPBLK	PVPART.1397	122.80
7215F/26F/27F Int Door Leaf - RH	US3	PVPART.1398	235.70
7215F/26F/27F Int Door Leaf - RH	US10	PVPART.1399	235.70
7215F/26F/27F Int Door Leaf - RH	US32	PVPART.1400	235.70
7215F/26F/27F Int Door Leaf - RH	US32D	PVPART.1401	224.70
7215F/26F/27F Int Door Leaf - RH	SP4	PVPART.1402	190.00
7215F/26F/27F Int Door Leaf - RH	SP10	PVPART.1403	190.00
7215F/26F/27F Int Door Leaf - RH	SP28	PVPART.1404	190.00
7215F/26F/27F Int Door Leaf - RH	SP313	PVPART.1405	190.00
7215F/26F/27F Int Door Leaf - RH	SPBLK	PVPART.1406	190.00
7215F/26F/27F Int Jamb Leaf - RH	US3	PVPART.1407	235.70
7215F/26F/27F Int Jamb Leaf - RH	US10	PVPART.1408	235.70
7215F/26F/27F Int Jamb Leaf - RH	US32	PVPART.1409	235.70
7215F/26F/27F Int Jamb Leaf - RH	US32D	PVPART.1410	224.70
7215F/26F/27F Int Jamb Leaf - RH	SP4	PVPART.1411	190.00
7215F/26F/27F Int Jamb Leaf - RH	SP10	PVPART.1412	190.00
7215F/26F/27F Int Jamb Leaf - RH	SP28	PVPART.1413	190.00
7215F/26F/27F Int Jamb Leaf - RH	SP313	PVPART.1414	190.00
7215F/26F/27F Int Jamb Leaf - RH	SPBLK	PVPART.1415	190.00
7215F/26F/27F Int Door Leaf - LH	US3	PVPART.1416	235.70
7215F/26F/27F Int Door Leaf - LH	US10	PVPART.1417	235.70
7215F/26F/27F Int Door Leaf - LH	US32	PVPART.1418	235.70
7215F/26F/27F Int Door Leaf - LH	US32D	PVPART.1419	224.70
7215F/26F/27F Int Door Leaf - LH	SP4	PVPART.1420	190.00
7215F/26F/27F Int Door Leaf - LH	SP10	PVPART.1421	190.00
7215F/26F/27F Int Door Leaf - LH	SP28	PVPART.1422	190.00
7215F/26F/27F Int Door Leaf - LH	SP313	PVPART.1423	190.00
7215F/26F/27F Int Door Leaf - LH	SPBLK	PVPART.1424	190.00
7215F/26F/27F Int Jamb Leaf - LH	US3	PVPART.1425	235.70
7215F/26F/27F Int Jamb Leaf - LH	US10	PVPART.1426	235.70
7215F/26F/27F Int Jamb Leaf - LH	US32	PVPART.1427	235.70
7215F/26F/27F Int Jamb Leaf - LH	US32D	PVPART.1428	224.70
7215F/26F/27F Int Jamb Leaf - LH	SP4	PVPART.1429	190.00
7215F/26F/27F Int Jamb Leaf - LH	SP10	PVPART.1430	190.00
7215F/26F/27F Int Jamb Leaf - LH	SP28	PVPART.1431	190.00
7215F/26F/27F Int Jamb Leaf - LH	SP313	PVPART.1432	190.00
7215F/26F/27F Int Jamb Leaf - LH	SPBLK	PVPART.1433	190.00
7215/26/27/30/37/44/45 Int Mounting Pkg	US3, US4, SP4	PVPART.1434	13.90
7215/26/27/30/37/44/45 Int Mounting Pkg	US10, SP10	PVPART.1435	13.90
7215/26/27/30/37/44/45 Int Mounting Pkg	US10B, SP313	PVPART.1436	13.90
7215/26/27/30/37/44/45 Int Mounting Pkg	US26, US26D, US32, US32D, SP28	PVPART.1437	13.90
7215/26/27/30/37/44/45 Int Mounting Pkg	SPBLK	PVPART.1438	13.90
7215/26/27/30/37/44/45 Int Security Mtg Pkg	-	PVPART.1439	33.30
7215/26/27/30/37/44/45 Int Wood Mtg Pkg	US3, US4, SP4	PVPART.1836	15.20
7215/26/27/30/37/44/45 Int Wood Mtg Pkg	US10, SP10	PVPART.1837	15.20

Contact Ives Customer Service for pricing on additional sizes and finishes

Bold pricing indicates item is in stock and available for **Fast Track** and **ProXpress**

IVES ARCHITECTURAL HARDWARE - Parts Price List

Description	Finish	Part No.	List Price Each
7215/26/27 & 7215F/26F/27F Intermediate Pivot (Continued)			
7215/26/27/30/37/44/45 Int Wood Mtg Pkg	US10B, SP313	PVPART.1838	15.20
7215/26/27/30/37/44/45 Int Wood Mtg Pkg	US26, US26D, US32, US32D, SP28	PVPART.1839	15.20
7215/26/27/30/37/44/45 Int Wood Mtg Pkg	SPBLK	PVPART.1840	15.20
7212/15/22/26/27/30/37/44/45 Cap Screw	US3	PVPART.1032	22.00
7212/15/22/26/27/30/37/44/45 Cap Screw	US4	PVPART.1033	22.00
7212/15/22/26/27/30/37/44/45 Cap Screw	US10	PVPART.1034	22.00
7212/15/22/26/27/30/37/44/45 Cap Screw	US10B	PVPART.1035	22.00
7212/15/22/26/27/30/37/44/45 Cap Screw	US26, US32	PVPART.1036	22.00
7212/15/22/26/27/30/37/44/45 Cap Screw	US26D, US32D	PVPART.1037	22.00
7212/15/22/26/27/30/37/44/45 Cap Screw	SP4	PVPART.1038	22.00
7212/15/22/26/27/30/37/44/45 Cap Screw	SP10	PVPART.1039	22.00
7212/15/22/26/27/30/37/44/45 Cap Screw	SP28	PVPART.1040	22.00
7212/15/22/26/27/30/37/44/45 Cap Screw	SP313	PVPART.1041	22.00
7212/15/22/26/27/30/37/44/45 Cap Screw	SPBLK	PVPART.1042	22.00
7215/26/27 Pivot Ball	-	PVPART.1349	2.00
Pivot Bushing	-	PVPART.1870	3.40
Pivot Retainer Lock	-	PVPART.1353	8.30
Pivot Washer (Pkg of 10)	-	PVPART.1352	7.00
7215/26/27/30/37/44/45 Int Pivot Bearing Pin	-	PVPART.1847	13.90
7230F/37F Intermediate Pivot			
7230F/37F Int Door Leaf - RH	US3	PVPART.1565	256.20
7230F/37F Int Door Leaf - RH	US10	PVPART.1566	256.20
7230F/37F Int Door Leaf - RH	US32	PVPART.1567	256.20
7230F/37F Int Door Leaf - RH	US32D	PVPART.1568	245.60
7230F/37F Int Door Leaf - RH	SP4	PVPART.1569	210.90
7230F/37F Int Door Leaf - RH	SP10	PVPART.1570	210.90
7230F/37F Int Door Leaf - RH	SP28	PVPART.1571	210.90
7230F/37F Int Door Leaf - RH	SP313	PVPART.1572	210.90
7230F/37F Int Door Leaf - RH	SPBLK	PVPART.1573	210.90
7230F/37F Int Jamb Leaf - RH	US3	PVPART.1574	256.20
7230F/37F Int Jamb Leaf - RH	US10	PVPART.1575	256.20
7230F/37F Int Jamb Leaf - RH	US32	PVPART.1576	256.20
7230F/37F Int Jamb Leaf - RH	US32D	PVPART.1577	245.60
7230F/37F Int Jamb Leaf - RH	SP4	PVPART.1578	210.90
7230F/37F Int Jamb Leaf - RH	SP10	PVPART.1579	210.90
7230F/37F Int Jamb Leaf - RH	SP28	PVPART.1580	210.90
7230F/37F Int Jamb Leaf - RH	SP313	PVPART.1581	210.90
7230F/37F Int Jamb Leaf - RH	SPBLK	PVPART.1582	210.90
7230F/37F Int Door Leaf - LH	US3	PVPART.1583	256.20
7230F/37F Int Door Leaf - LH	US10	PVPART.1584	256.20
7230F/37F Int Door Leaf - LH	US32	PVPART.1585	256.20
7230F/37F Int Door Leaf - LH	US32D	PVPART.1586	245.60
7230F/37F Int Door Leaf - LH	SP4	PVPART.1587	210.90
7230F/37F Int Door Leaf - LH	SP10	PVPART.1588	210.90
7230F/37F Int Door Leaf - LH	SP28	PVPART.1589	210.90
7230F/37F Int Door Leaf - LH	SP313	PVPART.1590	210.90
7230F/37F Int Door Leaf - LH	SPBLK	PVPART.1591	210.90
7230F/37F Int Jamb Leaf - LH	US3	PVPART.1592	256.20
7230F/37F Int Jamb Leaf - LH	US10	PVPART.1593	256.20
7230F/37F Int Jamb Leaf - LH	US32	PVPART.1594	256.20
7230F/37F Int Jamb Leaf - LH	US32D	PVPART.1595	245.60
7230F/37F Int Jamb Leaf - LH	SP4	PVPART.1596	210.90
7230F/37F Int Jamb Leaf - LH	SP10	PVPART.1597	210.90

Contact Ives Customer Service for pricing on additional sizes and finishes

Bold pricing indicates item is in stock and available for **Fast Track** and **ProXpress**

IVES ARCHITECTURAL HARDWARE - Parts Price List

Description	Finish	Part No.	List Price Each
7230F/37F Intermediate Pivot (Continued)			
7230F/37F Int Jamb Leaf - LH	SP28	PVPART.1598	210.90
7230F/37F Int Jamb Leaf - LH	SP313	PVPART.1599	210.90
7230F/37F Int Jamb Leaf - LH	SPBLK	PVPART.1600	210.90
7215/26/27/30/37/44/45 Int Mounting Pkg	US3, SP4	PVPART.1434	13.90
7215/26/27/30/37/44/45 Int Mounting Pkg	US10, SP10	PVPART.1435	13.90
7215/26/27/30/37/44/45 Int Mounting Pkg	SP313	PVPART.1436	13.90
7215/26/27/30/37/44/45 Int Mounting Pkg	US32, US32D, SP28	PVPART.1437	13.90
7215/26/27/30/37/44/45 Int Mounting Pkg	SPBLK	PVPART.1438	13.90
7215/26/27/30/37/44/45 Int Security Mtg Pkg	-	PVPART.1439	33.30
7215/26/27/30/37/44/45 Int Wood Mtg Pkg	US3, US4	PVPART.1836	15.20
7215/26/27/30/37/44/45 Int Wood Mtg Pkg	US10, SP10	PVPART.1837	15.20
7215/26/27/30/37/44/45 Int Wood Mtg Pkg	SP313	PVPART.1838	15.20
7215/26/27/30/37/44/45 Int Wood Mtg Pkg	US32, US32D, SP28	PVPART.1839	15.20
7215/26/27/30/37/44/45 Int Wood Mtg Pkg	SPBLK	PVPART.1840	15.20
7212/15/22/26/27/30/37/44/45 Cap Screw	US3	PVPART.1032	22.00
7212/15/22/26/27/30/37/44/45 Cap Screw	US10	PVPART.1034	22.00
7212/15/22/26/27/30/37/44/45 Cap Screw	US32	PVPART.1036	22.00
7212/15/22/26/27/30/37/44/45 Cap Screw	US32D	PVPART.1037	22.00
7212/15/22/26/27/30/37/44/45 Cap Screw	SP4	PVPART.1038	22.00
7212/15/22/26/27/30/37/44/45 Cap Screw	SP10	PVPART.1039	22.00
7212/15/22/26/27/30/37/44/45 Cap Screw	SP28	PVPART.1040	22.00
7212/15/22/26/27/30/37/44/45 Cap Screw	SP313	PVPART.1041	22.00
7212/15/22/26/27/30/37/44/45 Cap Screw	SPBLK	PVPART.1042	22.00
7230/37/44/45 Intermediate Pivot Ball	-	PVPART.1607	2.00
Pivot Bushing	-	PVPART.1870	3.40
Pivot Retainer Lock	-	PVPART.1353	8.30
Pivot Washer (Pkg of 10)	-	PVPART.1352	7.00
7215/26/27/30/37/44/45 Int Pivot Bearing Pin	-	PVPART.1847	13.90
7244F/45F Intermediate Pivot			
7244F/45F Int Door Leaf - RH	US3	PVPART.1655	278.40
7244F/45F Int Door Leaf - RH	US10	PVPART.1656	278.40
7244F/45F Int Door Leaf - RH	US32	PVPART.1657	278.40
7244F/45F Int Door Leaf - RH	US32D	PVPART.1658	261.80
7244F/45F Int Door Leaf - RH	SP4	PVPART.1659	235.70
7244F/45F Int Door Leaf - RH	SP10	PVPART.1660	235.70
7244F/45F Int Door Leaf - RH	SP28	PVPART.1661	235.70
7244F/45F Int Door Leaf - RH	SP313	PVPART.1662	235.70
7244F/45F Int Door Leaf - RH	SPBLK	PVPART.1663	235.70
7244F/45F Int Jamb Leaf - RH	US3	PVPART.1664	278.40
7244F/45F Int Jamb Leaf - RH	US10	PVPART.1665	278.40
7244F/45F Int Jamb Leaf - RH	US32	PVPART.1666	278.40
7244F/45F Int Jamb Leaf - RH	US32D	PVPART.1667	261.80
7244F/45F Int Jamb Leaf - RH	SP4	PVPART.1668	235.70
7244F/45F Int Jamb Leaf - RH	SP10	PVPART.1669	235.70
7244F/45F Int Jamb Leaf - RH	SP28	PVPART.1670	235.70
7244F/45F Int Jamb Leaf - RH	SP313	PVPART.1671	235.70
7244F/45F Int Jamb Leaf - RH	SPBLK	PVPART.1672	235.70
7244F/45F Int Door Leaf - LH	US3	PVPART.1673	278.40
7244F/45F Int Door Leaf - LH	US10	PVPART.1674	278.40
7244F/45F Int Door Leaf - LH	US32	PVPART.1675	278.40
7244F/45F Int Door Leaf - LH	US32D	PVPART.1676	261.80
7244F/45F Int Door Leaf - LH	SP4	PVPART.1677	235.70

Contact Ives Customer Service for pricing on additional sizes and finishes

Bold pricing indicates item is in stock and available for **Fast Track** and **ProXpress**

IVES ARCHITECTURAL HARDWARE - Parts Price List

Description	Finish	Part No.	List Price Each
7244F/45F Intermediate Pivot (Continued)			
7244F/45F Int Door Leaf - LH	SP10	PVPART.1678	235.70
7244F/45F Int Door Leaf - LH	SP28	PVPART.1679	235.70
7244F/45F Int Door Leaf - LH	SP313	PVPART.1680	235.70
7244F/45F Int Door Leaf - LH	SPBLK	PVPART.1681	235.70
7244F/45F Int Jamb Leaf - LH	US3	PVPART.1682	278.40
7244F/45F Int Jamb Leaf - LH	US10	PVPART.1683	278.40
7244F/45F Int Jamb Leaf - LH	US32	PVPART.1684	278.40
7244F/45F Int Jamb Leaf - LH	US32D	PVPART.1685	261.80
7244F/45F Int Jamb Leaf - LH	SP4	PVPART.1686	235.70
7244F/45F Int Jamb Leaf - LH	SP10	PVPART.1687	235.70
7244F/45F Int Jamb Leaf - LH	SP28	PVPART.1688	235.70
7244F/45F Int Jamb Leaf - LH	SP313	PVPART.1689	235.70
7244F/45F Int Jamb Leaf - LH	SPBLK	PVPART.1690	235.70
7215/26/27/30/37/44/45 Int Mounting Pkg	US3, SP4	PVPART.1434	13.90
7215/26/27/30/37/44/45 Int Mounting Pkg	US10, SP10	PVPART.1435	13.90
7215/26/27/30/37/44/45 Int Mounting Pkg	SP313	PVPART.1436	13.90
7215/26/27/30/37/44/45 Int Mounting Pkg	US32, US32D, SP28	PVPART.1437	13.90
7215/26/27/30/37/44/45 Int Mounting Pkg	SPBLK	PVPART.1438	13.90
7215/26/27/30/37/44/45 Int Security Mtg Pkg	-	PVPART.1439	33.30
7215/26/27/30/37/44/45 Int Wood Mtg Pkg	US3, SP4	PVPART.1836	15.20
7215/26/27/30/37/44/45 Int Wood Mtg Pkg	US10, SP10	PVPART.1837	15.20
7215/26/27/30/37/44/45 Int Wood Mtg Pkg	SP313	PVPART.1838	15.20
7215/26/27/30/37/44/45 Int Wood Mtg Pkg	US32, US32D, SP28	PVPART.1839	15.20
7215/26/27/30/37/44/45 Int Wood Mtg Pkg	SPBLK	PVPART.1840	15.20
7212/15/22/26/27/30/37/44/45 Cap Screw	US3	PVPART.1032	22.00
7212/15/22/26/27/30/37/44/45 Cap Screw	US10	PVPART.1034	22.00
7212/15/22/26/27/30/37/44/45 Cap Screw	US32	PVPART.1036	22.00
7212/15/22/26/27/30/37/44/45 Cap Screw	US32D	PVPART.1037	22.00
7212/15/22/26/27/30/37/44/45 Cap Screw	SP4	PVPART.1038	22.00
7212/15/22/26/27/30/37/44/45 Cap Screw	SP10	PVPART.1039	22.00
7212/15/22/26/27/30/37/44/45 Cap Screw	SP28	PVPART.1040	22.00
7212/15/22/26/27/30/37/44/45 Cap Screw	SP313	PVPART.1041	22.00
7212/15/22/26/27/30/37/44/45 Cap Screw	SPBLK	PVPART.1042	22.00
7230/37/44/45 Intermediate Pivot Ball	-	PVPART.1607	2.00
Pivot Bushing	-	PVPART.1870	3.40
Pivot Retainer Lock	-	PVPART.1353	8.30
Pivot Washer (Pkg of 10)	-	PVPART.1352	7.00
7215/26/27/30/37/44/45 Int Pivot Bearing Pin	-	PVPART.1847	13.90
7212 Bottom Pivot			
7212/12V/22 Btm Door Leaf - RH	US3	PVPART.1043	149.10
7212/12V/22 Btm Door Leaf - RH	US4	PVPART.1044	149.10
7212/12V/22 Btm Door Leaf - RH	US10	PVPART.1045	149.10
7212/12V/22 Btm Door Leaf - RH	US10B	PVPART.1046	149.10
7212/12V/22 Btm Door Leaf - RH	US26	PVPART.1047	149.10
7212/12V/22 Btm Door Leaf - RH	US26D	PVPART.1048	128.10
7212/12V/22 Btm Door Leaf - RH	SP4	PVPART.1049	97.80
7212/12V/22 Btm Door Leaf - RH	SP10	PVPART.1050	97.80
7212/12V/22 Btm Door Leaf - RH	SP28	PVPART.1051	97.80
7212/12V/22 Btm Door Leaf - RH	SP313	PVPART.1052	97.80
7212/12V/22 Btm Door Leaf - RH	SPBLK	PVPART.1053	97.80
7212/12V Btm Jamb Leaf - RH	US3	PVPART.1054	149.10
7212/12V Btm Jamb Leaf - RH	US4	PVPART.1055	149.10
7212/12V Btm Jamb Leaf - RH	US10	PVPART.1056	149.10

Contact Ives Customer Service for pricing on additional sizes and finishes

Bold pricing indicates item is in stock and available for **Fast Track** and **ProXpress**

IVES ARCHITECTURAL HARDWARE - Parts Price List

Description	Finish	Part No.	List Price Each
7212 Bottom Pivot (Continued)			
7212/12V Btm Jamb Leaf - RH	US10B	PVPART.1057	149.10
7212/12V Btm Jamb Leaf - RH	US26	PVPART.1058	149.10
7212/12V Btm Jamb Leaf - RH	US26D	PVPART.1059	128.10
7212/12V Btm Jamb Leaf - RH	SP4	PVPART.1060	97.80
7212/12V Btm Jamb Leaf - RH	SP10	PVPART.1061	97.80
7212/12V Btm Jamb Leaf - RH	SP28	PVPART.1062	97.80
7212/12V Btm Jamb Leaf - RH	SP313	PVPART.1063	97.80
7212/12V Btm Jamb Leaf - RH	SPBLK	PVPART.1064	97.80
7212/12V/22 Btm Door Leaf - LH	US3	PVPART.1065	149.10
7212/12V/22 Btm Door Leaf - LH	US4	PVPART.1066	149.10
7212/12V/22 Btm Door Leaf - LH	US10	PVPART.1067	149.10
7212/12V/22 Btm Door Leaf - LH	US10B	PVPART.1068	149.10
7212/12V/22 Btm Door Leaf - LH	US26	PVPART.1069	149.10
7212/12V/22 Btm Door Leaf - LH	US26D	PVPART.1070	128.10
7212/12V/22 Btm Door Leaf - LH	SP4	PVPART.1071	97.80
7212/12V/22 Btm Door Leaf - LH	SP10	PVPART.1072	97.80
7212/12V/22 Btm Door Leaf - LH	SP28	PVPART.1073	97.80
7212/12V/22 Btm Door Leaf - LH	SP313	PVPART.1074	97.80
7212/12V/22 Btm Door Leaf - LH	SPBLK	PVPART.1075	97.80
7212/12V Btm Jamb Leaf - LH	US3	PVPART.1076	149.10
7212/12V Btm Jamb Leaf - LH	US4	PVPART.1077	149.10
7212/12V Btm Jamb Leaf - LH	US10	PVPART.1078	149.10
7212/12V Btm Jamb Leaf - LH	US10B	PVPART.1079	149.10
7212/12V Btm Jamb Leaf - LH	US26	PVPART.1080	149.10
7212/12V Btm Jamb Leaf - LH	US26D	PVPART.1081	128.10
7212/12V Btm Jamb Leaf - LH	SP4	PVPART.1082	97.80
7212/12V Btm Jamb Leaf - LH	SP10	PVPART.1083	97.80
7212/12V Btm Jamb Leaf - LH	SP28	PVPART.1084	97.80
7212/12V Btm Jamb Leaf - LH	SP313	PVPART.1085	97.80
7212/12V Btm Jamb Leaf - LH	SPBLK	PVPART.1086	97.80
7212/12V/15 Btm Mounting Pkg	US3, US4, SP4	PVPART.1087	15.20
7212/12V/15 Btm Mounting Pkg	US10, SP10	PVPART.1088	15.20
7212/12V/15 Btm Mounting Pkg	US10B, SP313	PVPART.1089	15.20
7212/12V/15 Btm Mounting Pkg	US26, US26D, SP28	PVPART.1090	15.20
7212/12V/15 Btm Mounting Pkg	SPBLK	PVPART.1091	15.20
7212/12V/15 Btm Security Mounting Pkg	-	PVPART.1092	27.50
7212/12V/15/22 Btm Wood Mtg Pkg	US3, US4, SP4	PVPART.1826	13.90
7212/12V/15/22 Btm Wood Mtg Pkg	US10, SP10	PVPART.1827	13.90
7212/12V/15/22 Btm Wood Mtg Pkg	US10B, SP313	PVPART.1828	13.90
7212/12V/15/22 Btm Wood Mtg Pkg	US26, US26D, SP28	PVPART.1829	13.90
7212/12V/15/22 Btm Wood Mtg Pkg	SPBLK	PVPART.1830	13.90
Pivot Set Screw (Pkg of 10)	-	PVPART.1030	5.60
7212/12V/22 Pivot Bearing	-	PVPART.1031	5.60
7212/12V/22 Pivot Bearing Pin	-	PVPART.1093	5.60
7212V Bottom Pivot			
7212/12V/22 Btm Door Leaf - RH	US3	PVPART.1043	149.10
7212/12V/22 Btm Door Leaf - RH	US4	PVPART.1044	149.10
7212/12V/22 Btm Door Leaf - RH	US10	PVPART.1045	149.10
7212/12V/22 Btm Door Leaf - RH	US10B	PVPART.1046	149.10
7212/12V/22 Btm Door Leaf - RH	US26	PVPART.1047	149.10
7212/12V/22 Btm Door Leaf - RH	US26D	PVPART.1048	128.10
7212/12V/22 Btm Door Leaf - RH	SP4	PVPART.1049	97.80
7212/12V/22 Btm Door Leaf - RH	SP10	PVPART.1050	97.80

Contact Ives Customer Service for pricing on additional sizes and finishes

Bold pricing indicates item is in stock and available for **Fast Track** and **ProXpress**

IVES ARCHITECTURAL HARDWARE - Parts Price List

Description	Finish	Part No.	List Price Each
7212V Bottom Pivot (Continued)			
7212/12V/22 Btm Door Leaf - RH	SP28	PVPART.1051	97.80
7212/12V/22 Btm Door Leaf - RH	SP313	PVPART.1052	97.80
7212/12V/22 Btm Door Leaf - RH	SPBLK	PVPART.1053	97.80
7212/12V Btm Jamb Leaf - RH	US3	PVPART.1054	149.10
7212/12V Btm Jamb Leaf - RH	US4	PVPART.1055	149.10
7212/12V Btm Jamb Leaf - RH	US10	PVPART.1056	149.10
7212/12V Btm Jamb Leaf - RH	US10B	PVPART.1057	149.10
7212/12V Btm Jamb Leaf - RH	US26	PVPART.1058	149.10
7212/12V Btm Jamb Leaf - RH	US26D	PVPART.1059	128.10
7212/12V Btm Jamb Leaf - RH	SP4	PVPART.1060	97.80
7212/12V Btm Jamb Leaf - RH	SP10	PVPART.1061	97.80
7212/12V Btm Jamb Leaf - RH	SP28	PVPART.1062	97.80
7212/12V Btm Jamb Leaf - RH	SP313	PVPART.1063	97.80
7212/12V Btm Jamb Leaf - RH	SPBLK	PVPART.1064	97.80
7212/12V/22 Btm Door Leaf - LH	US3	PVPART.1065	149.10
7212/12V/22 Btm Door Leaf - LH	US4	PVPART.1066	149.10
7212/12V/22 Btm Door Leaf - LH	US10	PVPART.1067	149.10
7212/12V/22 Btm Door Leaf - LH	US10B	PVPART.1068	149.10
7212/12V/22 Btm Door Leaf - LH	US26	PVPART.1069	149.10
7212/12V/22 Btm Door Leaf - LH	US26D	PVPART.1070	128.10
7212/12V/22 Btm Door Leaf - LH	SP4	PVPART.1071	97.80
7212/12V/22 Btm Door Leaf - LH	SP10	PVPART.1072	97.80
7212/12V/22 Btm Door Leaf - LH	SP28	PVPART.1073	97.80
7212/12V/22 Btm Door Leaf - LH	SP313	PVPART.1074	97.80
7212/12V/22 Btm Door Leaf - LH	SPBLK	PVPART.1075	97.80
7212/12V Btm Jamb Leaf - LH	US3	PVPART.1076	149.10
7212/12V Btm Jamb Leaf - LH	US4	PVPART.1077	149.10
7212/12V Btm Jamb Leaf - LH	US10	PVPART.1078	149.10
7212/12V Btm Jamb Leaf - LH	US10B	PVPART.1079	149.10
7212/12V Btm Jamb Leaf - LH	US26	PVPART.1080	149.10
7212/12V Btm Jamb Leaf - LH	US26D	PVPART.1081	128.10
7212/12V Btm Jamb Leaf - LH	SP4	PVPART.1082	97.80
7212/12V Btm Jamb Leaf - LH	SP10	PVPART.1083	97.80
7212/12V Btm Jamb Leaf - LH	SP28	PVPART.1084	97.80
7212/12V Btm Jamb Leaf - LH	SP313	PVPART.1085	97.80
7212/12V Btm Jamb Leaf - LH	SPBLK	PVPART.1086	97.80
7212/12V/15/22 Btm Mounting Pkg	US3, US4, SP4	PVPART.1087	15.20
7212/12V/15/22 Btm Mounting Pkg	US10, SP10	PVPART.1088	15.20
7212/12V/15/22 Btm Mounting Pkg	US10B, SP313	PVPART.1089	15.20
7212/12V/15/22 Btm Mounting Pkg	US26, US26D, SP28	PVPART.1090	15.20
7212/12V/15/22 Btm Mounting Pkg	SPBLK	PVPART.1091	15.20
7212/12V/15 Btm Security Mtg Pkg	-	PVPART.1092	27.50
7212/12V/15/22 Btm Wood Mtg Pkg	US3, US4, SP4	PVPART.1826	13.90
7212/12V/15/22 Btm Wood Mtg Pkg	US10, SP10	PVPART.1827	13.90
7212/12V/15/22 Btm Wood Mtg Pkg	US10B, SP313	PVPART.1828	13.90
7212/12V/15/22 Btm Wood Mtg Pkg	US26, US26D, SP28	PVPART.1829	13.90
7212/12V/15/22 Btm Wood Mtg Pkg	SPBLK	PVPART.1830	13.90
Pivot Set Screw (Pkg of 10)	-	PVPART.1030	5.60
7212/12V/22 Pivot Bearing	-	PVPART.1031	5.60
7212/12V/22 Pivot Bearing Pin	-	PVPART.1093	5.60
7215 & 7215F Bottom Pivot			
7215 Btm Door Leaf - RH	US3	PVPART.1251	164.20
7215 Btm Door Leaf - RH	US4	PVPART.1252	164.20

Contact Ives Customer Service for pricing on additional sizes and finishes

Bold pricing indicates item is in stock and available for **Fast Track** and **ProXpress**

IVES ARCHITECTURAL HARDWARE - Parts Price List

Description	Finish	Part No.	List Price Each
7215 & 7215F Bottom Pivot (Continued)			
7215 Btm Door Leaf - RH	US10	PVPART.1253	164.20
7215 Btm Door Leaf - RH	US10B	PVPART.1254	164.20
7215 Btm Door Leaf - RH	US26	PVPART.1255	164.20
7215 Btm Door Leaf - RH	US26D	PVPART.1256	153.10
7215 Btm Door Leaf - RH	SP4	PVPART.1257	166.80
7215 Btm Door Leaf - RH	SP10	PVPART.1258	166.80
7215 Btm Door Leaf - RH	SP28	PVPART.1259	166.80
7215 Btm Door Leaf - RH	SP313	PVPART.1260	166.80
7215 Btm Door Leaf - RH	SPBLK	PVPART.1261	166.80
7215 Btm Jamb Leaf - RH	US3	PVPART.1262	164.20
7215 Btm Jamb Leaf - RH	US4	PVPART.1263	164.20
7215 Btm Jamb Leaf - RH	US10	PVPART.1264	164.20
7215 Btm Jamb Leaf - RH	US10B	PVPART.1265	164.20
7215 Btm Jamb Leaf - RH	US26	PVPART.1266	164.20
7215 Btm Jamb Leaf - RH	US26D	PVPART.1267	153.10
7215 Btm Jamb Leaf - RH	SP4	PVPART.1268	166.80
7215 Btm Jamb Leaf - RH	SP10	PVPART.1269	166.80
7215 Btm Jamb Leaf - RH	SP28	PVPART.1270	166.80
7215 Btm Jamb Leaf - RH	SP313	PVPART.1271	166.80
7215 Btm Jamb Leaf - RH	SPBLK	PVPART.1272	166.80
7215 Btm Door Leaf - LH	US3	PVPART.1273	164.20
7215 Btm Door Leaf - LH	US4	PVPART.1274	164.20
7215 Btm Door Leaf - LH	US10	PVPART.1275	164.20
7215 Btm Door Leaf - LH	US10B	PVPART.1276	164.20
7215 Btm Door Leaf - LH	US26	PVPART.1277	164.20
7215 Btm Door Leaf - LH	US26D	PVPART.1278	153.10
7215 Btm Door Leaf - LH	SP4	PVPART.1279	166.80
7215 Btm Door Leaf - LH	SP10	PVPART.1280	166.80
7215 Btm Door Leaf - LH	SP28	PVPART.1281	166.80
7215 Btm Door Leaf - LH	SP313	PVPART.1282	166.80
7215 Btm Door Leaf - LH	SPBLK	PVPART.1283	166.80
7215 Btm Jamb Leaf - LH	US3	PVPART.1284	164.20
7215 Btm Jamb Leaf - LH	US4	PVPART.1285	164.20
7215 Btm Jamb Leaf - LH	US10	PVPART.1286	164.20
7215 Btm Jamb Leaf - LH	US10B	PVPART.1287	164.20
7215 Btm Jamb Leaf - LH	US26	PVPART.1288	164.20
7215 Btm Jamb Leaf - LH	US26D	PVPART.1289	153.10
7215 Btm Jamb Leaf - LH	SP4	PVPART.1290	166.80
7215 Btm Jamb Leaf - LH	SP10	PVPART.1291	166.80
7215 Btm Jamb Leaf - LH	SP28	PVPART.1292	166.80
7215 Btm Jamb Leaf - LH	SP313	PVPART.1293	166.80
7215 Btm Jamb Leaf - LH	SPBLK	PVPART.1294	166.80
7215F Btm Door Leaf - RH	US3	PVPART.1295	292.30
7215F Btm Door Leaf - RH	US10	PVPART.1296	292.30
7215F Btm Door Leaf - RH	US32	PVPART.1297	292.30
7215F Btm Door Leaf - RH	US32D	PVPART.1298	271.60
7215F Btm Door Leaf - RH	SP4	PVPART.1299	215.20
7215F Btm Door Leaf - RH	SP10	PVPART.1300	215.20
7215F Btm Door Leaf - RH	SP28	PVPART.1301	215.20
7215F Btm Door Leaf - RH	SP313	PVPART.1302	215.20
7215F Btm Door Leaf - RH	SPBLK	PVPART.1303	215.20
7215F Btm Jamb Leaf - RH	US3	PVPART.1304	292.30
7215F Btm Jamb Leaf - RH	US10	PVPART.1305	292.30

Contact Ives Customer Service for pricing on additional sizes and finishes

Bold pricing indicates item is in stock and available for **Fast Track** and **ProXpress**

IVES ARCHITECTURAL HARDWARE - Parts Price List

Description	Finish	Part No.	List Price Each
7215 & 7215F Bottom Pivot (Continued)			
7215F Btm Jamb Leaf - RH	US32	PVPART.1306	292.30
7215F Btm Jamb Leaf - RH	US32D	PVPART.1307	271.60
7215F Btm Jamb Leaf - RH	SP4	PVPART.1308	215.20
7215F Btm Jamb Leaf - RH	SP10	PVPART.1309	215.20
7215F Btm Jamb Leaf - RH	SP28	PVPART.1310	215.20
7215F Btm Jamb Leaf - RH	SP313	PVPART.1311	215.20
7215F Btm Jamb Leaf - RH	SPBLK	PVPART.1312	215.20
7215F Btm Door Leaf - LH	US3	PVPART.1313	292.30
7215F Btm Door Leaf - LH	US10	PVPART.1314	292.30
7215F Btm Door Leaf - LH	US32	PVPART.1315	292.30
7215F Btm Door Leaf - LH	US32D	PVPART.1316	271.60
7215F Btm Door Leaf - LH	SP4	PVPART.1317	215.20
7215F Btm Door Leaf - LH	SP10	PVPART.1318	215.20
7215F Btm Door Leaf - LH	SP28	PVPART.1319	215.20
7215F Btm Door Leaf - LH	SP313	PVPART.1320	215.20
7215F Btm Door Leaf - LH	SPBLK	PVPART.1321	215.20
7215F Btm Jamb Leaf - LH	US3	PVPART.1322	292.30
7215F Btm Jamb Leaf - LH	US10	PVPART.1323	292.30
7215F Btm Jamb Leaf - LH	US32	PVPART.1324	292.30
7215F Btm Jamb Leaf - LH	US32D	PVPART.1325	271.60
7215F Btm Jamb Leaf - LH	SP4	PVPART.1326	215.20
7215F Btm Jamb Leaf - LH	SP10	PVPART.1327	215.20
7215F Btm Jamb Leaf - LH	SP28	PVPART.1328	215.20
7215F Btm Jamb Leaf - LH	SP313	PVPART.1329	215.20
7215F Btm Jamb Leaf - LH	SPBLK	PVPART.1330	215.20
7212/12V/15/22 Btm Mounting Pkg	US3, US4, SP4	PVPART.1087	15.20
7212/12V/15/22 Btm Mounting Pkg	US10, SP10	PVPART.1088	15.20
7212/12V/15/22 Btm Mounting Pkg	US10B, SP313	PVPART.1089	15.20
7212/12V/15/22 Btm Mounting Pkg	US26, US26D, US32, US32D, SP28	PVPART.1090	15.20
7212/12V/15/22 Btm Mounting Pkg	SPBLK	PVPART.1091	15.20
7212/12V/15/22 Btm Security Mtg Pkg	-	PVPART.1092	27.50
7212/12V/15/22 Btm Wood Mtg Pkg	US3, US4, SP4	PVPART.1826	13.90
7212/12V/15/22 Btm Wood Mtg Pkg	US10, SP10	PVPART.1827	13.90
7212/12V/15/22 Btm Wood Mtg Pkg	US10B, SP313	PVPART.1828	13.90
7212/12V/15/22 Btm Wood Mtg Pkg	US26, US26D, US32, US32D, SP28	PVPART.1829	13.90
7212/12V/15/22 Btm Wood Mtg Pkg	SPBLK	PVPART.1830	13.90
7212/15/22/26/27/30/37/44/45 Cap Screw	US3	PVPART.1032	22.00
7212/15/22/26/27/30/37/44/45 Cap Screw	US4	PVPART.1033	22.00
7212/15/22/26/27/30/37/44/45 Cap Screw	US10	PVPART.1034	22.00
7212/15/22/26/27/30/37/44/45 Cap Screw	US10B	PVPART.1035	22.00
7212/15/22/26/27/30/37/44/45 Cap Screw	US26, US32	PVPART.1036	22.00
7212/15/22/26/27/30/37/44/45 Cap Screw	US26D, US32D	PVPART.1037	22.00
7212/15/22/26/27/30/37/44/45 Cap Screw	SP4	PVPART.1038	22.00
7212/15/22/26/27/30/37/44/45 Cap Screw	SP10	PVPART.1039	22.00
7212/15/22/26/27/30/37/44/45 Cap Screw	SP28	PVPART.1040	22.00
7212/15/22/26/27/30/37/44/45 Cap Screw	SP313	PVPART.1041	22.00
7212/15/22/26/27/30/37/44/45 Cap Screw	SPBLK	PVPART.1042	22.00
7215/26/27 Pivot Ball	-	PVPART.1349	2.00
7215/15F Pivot Pin	-	PVPART.1350	9.70
Pivot Bearing Shaft	-	PVPART.1351	5.60
Pivot Washer (Pkg of 10)	-	PVPART.1352	7.00
Pivot Retainer Lock	-	PVPART.1353	8.30

Contact Ives Customer Service for pricing on additional sizes and finishes

Bold pricing indicates item is in stock and available for **Fast Track** and **ProXpress**

IVES ARCHITECTURAL HARDWARE - Parts Price List

Description	Finish	Part No.	List Price Each
7222 Bottom Pivot			
7212/12V/22 Btm Door Leaf - RH	US3	PVPART.1043	149.10
7212/12V/22 Btm Door Leaf - RH	US4	PVPART.1044	149.10
7212/12V/22 Btm Door Leaf - RH	US10	PVPART.1045	149.10
7212/12V/22 Btm Door Leaf - RH	US10B	PVPART.1046	149.10
7212/12V/22 Btm Door Leaf - RH	US26	PVPART.1047	149.10
7212/12V/22 Btm Door Leaf - RH	US26D	PVPART.1048	128.10
7212/12V/22 Btm Door Leaf - RH	SP4	PVPART.1049	97.80
7212/12V/22 Btm Door Leaf - RH	SP10	PVPART.1050	97.80
7212/12V/22 Btm Door Leaf - RH	SP28	PVPART.1051	97.80
7212/12V/22 Btm Door Leaf - RH	SP313	PVPART.1052	97.80
7212/12V/22 Btm Door Leaf - RH	SPBLK	PVPART.1053	97.80
7212/12V/22 Btm Door Leaf - LH	US3	PVPART.1065	149.10
7212/12V/22 Btm Door Leaf - LH	US4	PVPART.1066	149.10
7212/12V/22 Btm Door Leaf - LH	US10	PVPART.1067	149.10
7212/12V/22 Btm Door Leaf - LH	US10B	PVPART.1068	149.10
7212/12V/22 Btm Door Leaf - LH	US26	PVPART.1069	149.10
7212/12V/22 Btm Door Leaf - LH	US26D	PVPART.1070	128.10
7212/12V/22 Btm Door Leaf - LH	SP4	PVPART.1071	97.80
7212/12V/22 Btm Door Leaf - LH	SP10	PVPART.1072	97.80
7212/12V/22 Btm Door Leaf - LH	SP28	PVPART.1073	97.80
7212/12V/22 Btm Door Leaf - LH	SP313	PVPART.1074	97.80
7212/12V/22 Btm Door Leaf - LH	SPBLK	PVPART.1075	97.80
7222 Btm Cone Pkg	US3	PVPART.1440	138.00
7222 Btm Cone Pkg	US4	PVPART.1441	138.00
7222 Btm Cone Pkg	US10	PVPART.1442	138.00
7222 Btm Cone Pkg	US10B	PVPART.1443	138.00
7222 Btm Cone Pkg	US26	PVPART.1444	138.00
7222 Btm Cone Pkg	US26D	PVPART.1445	118.60
7222 Btm Cone Pkg	SP4	PVPART.1446	84.00
7222 Btm Cone Pkg	SP10	PVPART.1447	84.00
7222 Btm Cone Pkg	SP28	PVPART.1448	84.00
7222 Btm Cone Pkg	SP313	PVPART.1449	84.00
7222 Btm Cone Pkg	SPBLK	PVPART.1450	84.00
7222 Btm Mounting Pkg	-	PVPART.1451	24.70
7222 Security Mounting Pkg	-	PVPART.1452	13.90
Pivot Set Screw (Pkg of 10)	-	PVPART.1030	5.60
7212/12V/22 Pivot Bearing	-	PVPART.1031	5.60
7212/12V/22 Pivot Bearing Pin	-	PVPART.1093	5.60
7226 & 7226F Bottom Pivot			
7226/26F/27/27F Bottom Door Leaf	-	PVPART.1334	151.40
7226 Bottom Base Pkg	US3	PVPART.1453	155.80
7226 Bottom Base Pkg	US4	PVPART.1454	155.80
7226 Bottom Base Pkg	US10	PVPART.1455	155.80
7226 Bottom Base Pkg	US10B	PVPART.1456	155.80
7226 Bottom Base Pkg	US26	PVPART.1457	155.80
7226 Bottom Base Pkg	US26D	PVPART.1458	143.30
7226 Bottom Base Pkg	SP4	PVPART.1459	128.10
7226 Bottom Base Pkg	SP10	PVPART.1460	128.10
7226 Bottom Base Pkg	SP28	PVPART.1461	128.10
7226 Bottom Base Pkg	SP313	PVPART.1462	128.10
7226 Bottom Base Pkg	SPBLK	PVPART.1463	128.10
7226F/44F Bottom Base Pkg	US3	PVPART.1640	307.50
7226F/44F Bottom Base Pkg	US10	PVPART.1641	307.50

Contact Ives Customer Service for pricing on additional sizes and finishes

Bold pricing indicates item is in stock and available for **Fast Track** and **ProXpress**

IVES ARCHITECTURAL HARDWARE - Parts Price List

Description	Finish	Part No.	List Price Each
7226 & 7226F Bottom Pivot (Continued)			
7226F/44F Bottom Base Pkg	US32	PVPART.1642	307.50
7226F/44F Bottom Base Pkg	US32D	PVPART.1643	295.10
7226F/44F Bottom Base Pkg	SP4	PVPART.1644	261.80
7226F/44F Bottom Base Pkg	SP10	PVPART.1645	261.80
7226F/44F Bottom Base Pkg	SP28	PVPART.1646	261.80
7226F/44F Bottom Base Pkg	SP313	PVPART.1647	261.80
7226F/44F Bottom Base Pkg	SPBLK	PVPART.1648	261.80
7226/26F Bottom Mounting Pkg	US3, US4, SP4	PVPART.1464	42.60
7226/26F Bottom Mounting Pkg	US10, SP10	PVPART.1465	42.60
7226/26F Bottom Mounting Pkg	US10B, SP313	PVPART.1466	42.60
7226/26F Bottom Mounting Pkg	US26, US26D, SP28	PVPART.1467	42.60
7226/26F Bottom Mounting Pkg	SPBLK	PVPART.1468	42.60
7226/26F Security Mounting Pkg	-	PVPART.1469	33.30
7226/27/30F/37F/44F/45F Cover	US3	PVPART.1470	55.00
7226/27/30F/37F/44F/45F Cover	US4	PVPART.1471	55.00
7226/27/30F/37F/44F/45F Cover	US10	PVPART.1472	55.00
7226/27/30F/37F/44F/45F Cover	US10B	PVPART.1473	55.00
7226/27/30F/37F/44F/45F Cover	US26, US32	PVPART.1474	55.00
7226/27/30F/37F/44F/45F Cover	US26D, US32D	PVPART.1476	55.00
7226/27/30F/37F/44F/45F Cover	SP4	PVPART.1478	55.00
7226/27/30F/37F/44F/45F Cover	SP10	PVPART.1479	55.00
7226/27/30F/37F/44F/45F Cover	SP28	PVPART.1480	55.00
7226/27/30F/37F/44F/45F Cover	SP313	PVPART.1481	55.00
7226/27/30F/37F/44F/45F Cover	SPBLK	PVPART.1482	55.00
7226/27/30F/37F/44F/45F Cover Screw	US3	PVPART.1483	9.70
7226/27/30F/37F/44F/45F Cover Screw	US4, SP4	PVPART.1484	9.70
7226/27/30F/37F/44F/45F Cover Screw	US10, SP10	PVPART.1485	9.70
7226/27/30F/37F/44F/45F Cover Screw	US10B, SP313	PVPART.1486	9.70
7226/27/30F/37F/44F/45F Cover Screw	US26, US32	PVPART.1487	9.70
7226/27/30F/37F/44F/45F Cover Screw	US26D, US32D, SP28	PVPART.1488	9.70
7226/27/30F/37F/44F/45F Cover Screw	SPBLK	PVPART.1495	9.70
7226/27/37/44/45 Btm Pivot Bearing Pin	-	PVPART.1849	15.20
Pivot Set Screw (Pkg of 10)	-	PVPART.1030	5.60
7227 & 7227F Bottom Pivot			
7226/26F/27/27F Bottom Door Leaf	-	PVPART.1334	151.40
7227/27F/45F Base Pkg	-	PVPART.1497	506.10
7227/37/45/56/59 Finish Plate Pkg	US3	PVPART.1498	110.30
7227/37/45/56/59 Finish Plate Pkg	US4	PVPART.1499	110.30
7227/37/45/56/59 Finish Plate Pkg	US10	PVPART.1500	110.30
7227/37/45/56/59 Finish Plate Pkg	US10B	PVPART.1501	110.30
7227/37/45/56/59 Finish Plate Pkg	US26, US32	PVPART.1502	110.30
7227/37/45/56/59 Finish Plate Pkg	US26D, US32D	PVPART.1503	100.60
7227/37/45/56/59 Finish Plate Pkg	SP4	PVPART.1506	92.30
7227/37/45/56/59 Finish Plate Pkg	SP10	PVPART.1507	92.30
7227/37/45/56/59 Finish Plate Pkg	SP28	PVPART.1508	92.30
7227/37/45/56/59 Finish Plate Pkg	SP313	PVPART.1509	92.30
7227/37/45/56/59 Finish Plate Pkg	SPBLK	PVPART.1510	92.30
7227/7237F Bottom Mounting Pkg	US3, US4, SP4	PVPART.1511	42.60
7227/7237F Bottom Mounting Pkg	US10, SP10	PVPART.1512	42.60
7227/7237F Bottom Mounting Pkg	US10B, SP313	PVPART.1513	42.60
7227/7237F Bottom Mounting Pkg		PVPART.1514	42.60
7227/7237F Bottom Mounting Pkg	SPBLK	PVPART.1515	42.60
7227/7237F Bottom Security Mounting Pkg	-	PVPART.1516	44.10
7226/27/30F/37F/44F/45F Cover	US3	PVPART.1470	55.00

Contact Ives Customer Service for pricing on additional sizes and finishes

Bold pricing indicates item is in stock and available for **Fast Track** and **ProXpress**

IVES ARCHITECTURAL HARDWARE - Parts Price List

Description	Finish	Part No.	List Price Each
7227 & 7227F Bottom Pivot (Continued)			
7226/27/30F/37F/44F/45F Cover	US4	PVPART.1471	55.00
7226/27/30F/37F/44F/45F Cover	US10	PVPART.1472	55.00
7226/27/30F/37F/44F/45F Cover	US10B	PVPART.1473	55.00
7226/27/30F/37F/44F/45F Cover	US26, US32	PVPART.1474	55.00
7226/27/30F/37F/44F/45F Cover	US26D, US32D	PVPART.1476	55.00
7226/27/30F/37F/44F/45F Cover	SP4	PVPART.1478	55.00
7226/27/30F/37F/44F/45F Cover	SP10	PVPART.1479	55.00
7226/27/30F/37F/44F/45F Cover	SP28	PVPART.1480	55.00
7226/27/30F/37F/44F/45F Cover	SP313	PVPART.1481	55.00
7226/27/30F/37F/44F/45F Cover	SPBLK	PVPART.1482	55.00
7226/27/30F/37F/44F/45F Cover Screw	US3	PVPART.1483	9.70
7226/27/30F/37F/44F/45F Cover Screw	US4, SP4	PVPART.1484	9.70
7226/27/30F/37F/44F/45F Cover Screw	US10, SP10	PVPART.1485	9.70
7226/27/30F/37F/44F/45F Cover Screw	US10B, SP313	PVPART.1486	9.70
7226/27/30F/37F/44F/45F Cover Screw	US26, US32	PVPART.1487	9.70
7226/27/30F/37F/44F/45F Cover Screw	US26D, US32D, SP28	PVPART.1488	9.70
7226/27/30F/37F/44F/45F Cover Screw	SPBLK	PVPART.1495	9.70
7227/37/45/56/59 Finish Plate Screw (Pkg of 10)	-	PVPART.1335	2.00
7226/27/37/44/45 Btm Pivot Bearing Pin	-	PVPART.1849	15.20
Pivot Set Screw (Pkg of 10)	-	PVPART.1030	5.60
7230F Bottom Pivot			
7230F/37F Btm Door Leaf	-	PVPART.1545	168.30
7230F Btm Base Pkg	US3	PVPART.1546	307.50
7230F Btm Base Pkg	US10	PVPART.1547	307.50
7230F Btm Base Pkg	US32	PVPART.1548	307.50
7230F Btm Base Pkg	US32D	PVPART.1549	295.10
7230F Btm Base Pkg	SP4	PVPART.1550	261.80
7230F Btm Base Pkg	SP10	PVPART.1551	261.80
7230F Btm Base Pkg	SP28	PVPART.1552	261.80
7230F Btm Base Pkg	SP313	PVPART.1553	261.80
7230F Btm Base Pkg	SPBLK	PVPART.1554	261.80
7230F Btm Mounting Pkg	US3, SP4	PVPART.1555	45.50
7230F Btm Mounting Pkg	US10, SP10	PVPART.1556	45.50
7230F Btm Mounting Pkg	US32, US32D, SP28	PVPART.1557	45.50
7230F Btm Mounting Pkg	SP313	PVPART.1562	45.50
7230F Btm Mounting Pkg	SPBLK	PVPART.1563	45.50
7230F Btm Security Mtg Pkg	-	PVPART.1564	40.10
7226/27/30F/37F/44F/45F Cover	US3	PVPART.1470	55.00
7226/27/30F/37F/44F/45F Cover	US10	PVPART.1472	55.00
7226/27/30F/37F/44F/45F Cover	US32	PVPART.1474	55.00
7226/27/30F/37F/44F/45F Cover	US32D	PVPART.1476	55.00
7226/27/30F/37F/44F/45F Cover	SP4	PVPART.1478	55.00
7226/27/30F/37F/44F/45F Cover	SP10	PVPART.1479	55.00
7226/27/30F/37F/44F/45F Cover	SP28	PVPART.1480	55.00
7226/27/30F/37F/44F/45F Cover	SP313	PVPART.1481	55.00
7226/27/30F/37F/44F/45F Cover	SPBLK	PVPART.1482	55.00
7226/27/30F/37F/44F/45F Cover Screw	US3	PVPART.1483	9.70
7226/27/30F/37F/44F/45F Cover Screw	US10, SP10	PVPART.1485	9.70
7226/27/30F/37F/44F/45F Cover Screw	US32	PVPART.1487	9.70
7226/27/30F/37F/44F/45F Cover Screw	US32D, SP28	PVPART.1488	9.70
7226/27/30F/37F/44F/45F Cover Screw	SP4	PVPART.1484	9.70
7226/27/30F/37F/44F/45F Cover Screw	SP313	PVPART.1486	9.70
7226/27/30F/37F/44F/45F Cover Screw	SPBLK	PVPART.1495	9.70

Contact Ives Customer Service for pricing on additional sizes and finishes

Bold pricing indicates item is in stock and available for **Fast Track** and **ProXpress**

IVES ARCHITECTURAL HARDWARE - Parts Price List

Description	Finish	Part No.	List Price Each
7230F Bottom Pivot (Continued)			
7230F Pivot Bearing Pin	-	PVPART.1850	15.20
Pivot Set Screw (Pkg of 10)	-	PVPART.1030	5.60
7237F Bottom Pivot			
7230F/37F Btm Door Leaf	-	PVPART.1545	168.30
7237F Btm Base Pkg	-	PVPART.1608	506.10
7227/37/45/56/59 Finish Plate Pkg	US3	PVPART.1498	110.30
7227/37/45/56/59 Finish Plate Pkg	US10	PVPART.1500	110.30
7227/37/45/56/59 Finish Plate Pkg	US32	PVPART.1502	110.30
7227/37/45/56/59 Finish Plate Pkg	US32D	PVPART.1503	100.60
7227/37/45/56/59 Finish Plate Pkg	SP4	PVPART.1506	92.30
7227/37/45/56/59 Finish Plate Pkg	SP10	PVPART.1507	92.30
7227/37/45/56/59 Finish Plate Pkg	SP28	PVPART.1508	92.30
7227/37/45/56/59 Finish Plate Pkg	SP313	PVPART.1509	92.30
7227/37/45/56/59 Finish Plate Pkg	SPBLK	PVPART.1510	92.30
7227/7237F Btm Mounting Pkg	US3, SP4	PVPART.1511	42.60
7227/7237F Btm Mounting Pkg	US10, SP10	PVPART.1512	42.60
7227/7237F Btm Mounting Pkg	SP313	PVPART.1513	42.60
7227/7237F Btm Mounting Pkg	US32, US32D, SP28	PVPART.1514	42.60
7227/7237F Btm Mounting Pkg	SPBLK	PVPART.1515	42.60
7227/7237F Btm Security Mtg Pkg	-	PVPART.1516	44.10
7226/27/30F/37F/44F/45F Cover	US3	PVPART.1470	55.00
7226/27/30F/37F/44F/45F Cover	US10	PVPART.1472	55.00
7226/27/30F/37F/44F/45F Cover	US32	PVPART.1474	55.00
7226/27/30F/37F/44F/45F Cover	US32D	PVPART.1476	55.00
7226/27/30F/37F/44F/45F Cover	SP4	PVPART.1478	55.00
7226/27/30F/37F/44F/45F Cover	SP10	PVPART.1479	55.00
7226/27/30F/37F/44F/45F Cover	SP28	PVPART.1480	55.00
7226/27/30F/37F/44F/45F Cover	SP313	PVPART.1481	55.00
7226/27/30F/37F/44F/45F Cover	SPBLK	PVPART.1482	55.00
7226/27/30F/37F/44F/45F Cover Screw	US3	PVPART.1483	9.70
7226/27/30F/37F/44F/45F Cover Screw	US10, SP10	PVPART.1485	9.70
7226/27/30F/37F/44F/45F Cover Screw	US32	PVPART.1487	9.70
7226/27/30F/37F/44F/45F Cover Screw	US32D, SP28	PVPART.1488	9.70
7226/27/30F/37F/44F/45F Cover Screw	SP4	PVPART.1484	9.70
7226/27/30F/37F/44F/45F Cover Screw	SP313	PVPART.1486	9.70
7226/27/30F/37F/44F/45F Cover Screw	SPBLK	PVPART.1495	9.70
7227/37/45/56/59 Finish Plate Screw (Pkg of 10)	-	PVPART.1335	2.00
7226/27/37/44/45 Btm Pivot Bearing Pin	-	PVPART.1849	15.20
Pivot Set Screw (Pkg of 10)	-	PVPART.1030	5.60
7244F Bottom Pivot			
7244F/45F Bottom Door Leaf	-	PVPART.1639	168.30
7226/26F/44F Bottom Base Pkg	US3	PVPART.1640	307.50
7226/26F/44F Bottom Base Pkg	US10	PVPART.1641	307.50
7226/26F/44F Bottom Base Pkg	US32	PVPART.1642	307.50
7226/26F/44F Bottom Base Pkg	US32D	PVPART.1643	295.10
7226/26F/44F Bottom Base Pkg	SP4	PVPART.1644	261.80
7226/26F/44F Bottom Base Pkg	SP10	PVPART.1645	261.80
7226/26F/44F Bottom Base Pkg	SP28	PVPART.1646	261.80
7226/26F/44F Bottom Base Pkg	SP313	PVPART.1647	261.80
7226/26F/44F Bottom Base Pkg	SPBLK	PVPART.1648	261.80
7244F/7245F Bottom Mounting Pkg	US3, SP4	PVPART.1649	42.60
7244F/7245F Bottom Mounting Pkg	US10, SP10	PVPART.1650	42.60
7244F/7245F Bottom Mounting Pkg	US32, US32D, SP28	PVPART.1651	42.60

Contact Ives Customer Service for pricing on additional sizes and finishes

Bold pricing indicates item is in stock and available for **Fast Track** and **ProXpress**

IVES ARCHITECTURAL HARDWARE - Parts Price List

Description	Finish	Part No.	List Price Each
7244F Bottom Pivot (Continued)			
7244F/7245F Bottom Mounting Pkg	SP313	PVPART.1652	42.60
7244F/7245F Bottom Mounting Pkg	SPBLK	PVPART.1653	42.60
7244F/45F Bottom Security Mounting Pkg	-	PVPART.1654	37.10
7226/27/30F/37F/44F/45F Cover	US3	PVPART.1470	55.00
7226/27/30F/37F/44F/45F Cover	US10	PVPART.1472	55.00
7226/27/30F/37F/44F/45F Cover	US32	PVPART.1474	55.00
7226/27/30F/37F/44F/45F Cover	US32D	PVPART.1476	55.00
7226/27/30F/37F/44F/45F Cover	SP4	PVPART.1478	55.00
7226/27/30F/37F/44F/45F Cover	SP10	PVPART.1479	55.00
7226/27/30F/37F/44F/45F Cover	SP28	PVPART.1480	55.00
7226/27/30F/37F/44F/45F Cover	SP313	PVPART.1481	55.00
7226/27/30F/37F/44F/45F Cover	SPBLK	PVPART.1482	55.00
7226/27/30F/37F/44F/45F Cover Screw	US3	PVPART.1483	9.70
7226/27/30F/37F/44F/45F Cover Screw	US10, SP10	PVPART.1485	9.70
7226/27/30F/37F/44F/45F Cover Screw	US32	PVPART.1487	9.70
7226/27/30F/37F/44F/45F Cover Screw	US32D, SP28	PVPART.1488	9.70
7226/27/30F/37F/44F/45F Cover Screw	SP4	PVPART.1484	9.70
7226/27/30F/37F/44F/45F Cover Screw	SP313	PVPART.1486	9.70
7226/27/30F/37F/44F/45F Cover Screw	SPBLK	PVPART.1495	9.70
7226/27/37/44/45 Btm Pivot Bearing Pin	-	PVPART.1849	15.20
Pivot Set Screw (Pkg of 10)	-	PVPART.1030	5.60
7245F Bottom Pivot			
7244F/45F Bottom Door Leaf	-	PVPART.1639	168.30
72/27/27F/45F Bottom Base Pkg	-	PVPART.1497	506.10
7227/37/45/56/59 Finish Plate Pkg	US3	PVPART.1498	110.30
7227/37/45/56/59 Finish Plate Pkg	US10	PVPART.1500	110.30
7227/37/45/56/59 Finish Plate Pkg	US32	PVPART.1502	110.30
7227/37/45/56/59 Finish Plate Pkg	US32D	PVPART.1503	100.60
7227/37/45/56/59 Finish Plate Pkg	SP4	PVPART.1506	92.30
7227/37/45/56/59 Finish Plate Pkg	SP10	PVPART.1507	92.30
7227/37/45/56/59 Finish Plate Pkg	SP28	PVPART.1508	92.30
7227/37/45/56/59 Finish Plate Pkg	SP313	PVPART.1509	92.30
7227/37/45/56/59 Finish Plate Pkg	SPBLK	PVPART.1510	92.30
7244F/45F Bottom Mounting Pkg	US3, SP4	PVPART.1649	42.60
7244F/45F Bottom Mounting Pkg	US10, SP10	PVPART.1650	42.60
7244F/45F Bottom Mounting Pkg	US32, US32D, SP28	PVPART.1651	42.60
7244F/45F Bottom Mounting Pkg	SP313	PVPART.1652	42.60
7244F/45F Bottom Mounting Pkg	SPBLK	PVPART.1653	42.60
7245F Bottom Security Mtg Pkg	-	PVPART.1654	37.10
7226/27/30F/37F/44F/45F Cover	US3	PVPART.1470	55.00
7226/27/30F/37F/44F/45F Cover	US10	PVPART.1472	55.00
7226/27/30F/37F/44F/45F Cover	US32	PVPART.1474	55.00
7226/27/30F/37F/44F/45F Cover	US32D	PVPART.1476	55.00
7226/27/30F/37F/44F/45F Cover	SP4	PVPART.1478	55.00
7226/27/30F/37F/44F/45F Cover	SP10	PVPART.1479	55.00
7226/27/30F/37F/44F/45F Cover	SP28	PVPART.1480	55.00
7226/27/30F/37F/44F/45F Cover	SP313	PVPART.1481	55.00
7226/27/30F/37F/44F/45F Cover	SPBLK	PVPART.1482	55.00
7226/27/30F/37F/44F/45F Cover Screw	US3	PVPART.1483	9.70
7226/27/30F/37F/44F/45F Cover Screw	US10, SP10	PVPART.1485	9.70
7226/27/30F/37F/44F/45F Cover Screw	US32	PVPART.1487	9.70
7226/27/30F/37F/44F/45F Cover Screw	US32D, SP28	PVPART.1488	9.70
7226/27/30F/37F/44F/45F Cover Screw	SP4	PVPART.1484	9.70

Contact Ives Customer Service for pricing on additional sizes and finishes

Bold pricing indicates item is in stock and available for **Fast Track** and **ProXpress**

IVES ARCHITECTURAL HARDWARE - Parts Price List

Description	Finish	Part No.	List Price Each
7245F Bottom Pivot (Continued)			
7226/27/30F/37F/44F/45F Cover Screw	SP313	PVPART.1486	9.70
7226/27/30F/37F/44F/45F Cover Screw	SPBLK	PVPART.1495	9.70
7226/27/37/44/45 Btm Pivot Bearing Pin	-	PVPART.1849	15.20
Pivot Set Screw (Pkg of 10)	-	PVPART.1030	5.60
7227/37/45/56/59 Finish Plate Screw (Pkg of 10)	-	PVPART.1335	2.00
7253 Bottom Pivot			
7253 Btm Door Leaf	-	PVPART.1735	168.30
7253 Btm Base	US3	PVPART.1736	67.80
7253 Btm Base	US4	PVPART.1737	67.80
7253 Btm Base	US10	PVPART.1738	67.80
7253 Btm Base	US10B	PVPART.1739	67.80
7253 Btm Base	US26	PVPART.1740	67.80
7253 Btm Base	US26D	PVPART.1741	67.80
7253 Btm Base	SP4	PVPART.1742	59.20
7253 Btm Base	SP10	PVPART.1743	59.20
7253 Btm Base	SP28	PVPART.1744	59.20
7253 Btm Base	SP313	PVPART.1745	59.20
7253 Btm Base	SPBLK	PVPART.1746	59.20
7253 Bearing	-	PVPART.1704	22.00
7253 Btm Mounting Pkg	-	PVPART.1747	51.00
7253 Btm Security Mounting Pkg	-	PVPART.1748	9.70
7255 Bottom Pivot			
7255/55J Bottom Door Leaf	-	PVPART.1749	126.90
7255 Btm Base	US3	PVPART.1750	111.60
7255 Btm Base	US4	PVPART.1751	111.60
7255 Btm Base	US10	PVPART.1752	111.60
7255 Btm Base	US10B	PVPART.1753	111.60
7255 Btm Base	US26	PVPART.1754	111.60
7255 Btm Base	US26D	PVPART.1755	111.60
7255 Btm Base	SP4	PVPART.1756	106.30
7255 Btm Base	SP10	PVPART.1757	106.30
7255 Btm Base	SP28	PVPART.1758	106.30
7255 Btm Base	SP313	PVPART.1759	106.30
7255 Btm Base	SPBLK	PVPART.1760	106.30
7255 Btm Mounting Pkg	US3, US4, SP4	PVPART.1761	20.70
7255 Btm Mounting Pkg	US10, SP10	PVPART.1762	20.70
7255 Btm Mounting Pkg	US10B, SP313	PVPART.1763	20.70
7255 Btm Mounting Pkg	US26, US26D, SP28	PVPART.1764	20.70
7255 Btm Mounting Pkg	SPBLK	PVPART.1765	20.70
7255 Btm Security Mounting Pkg	-	PVPART.1766	23.40
7255J Bottom Pivot			
7255/55J Bottom Door Leaf	-	PVPART.1749	126.90
7255J Bottom Base	US3	PVPART.1767	111.60
7255J Bottom Base	US4	PVPART.1768	111.60
7255J Bottom Base	US10	PVPART.1769	111.60
7255J Bottom Base	US10B	PVPART.1770	111.60
7255J Bottom Base	US26	PVPART.1771	111.60
7255J Bottom Base	US26D	PVPART.1772	111.60
7255J Bottom Base	SP4	PVPART.1773	106.30
7255J Bottom Base	SP10	PVPART.1774	106.30
7255J Bottom Base	SP28	PVPART.1775	106.30
7255J Bottom Base	SP313	PVPART.1776	106.30
7255J Bottom Base	SPBLK	PVPART.1777	106.30

Contact Ives Customer Service for pricing on additional sizes and finishes

Bold pricing indicates item is in stock and available for **Fast Track** and **ProXpress**

IVES ARCHITECTURAL HARDWARE - Parts Price List

Description	Finish	Part No.	List Price Each
7255J Bottom Pivot (Continued)			
7255J Bottom Mounting Pkg	US3, US4, SP4	PVPART.1778	13.90
7255J Bottom Mounting Pkg	US10, SP10	PVPART.1779	13.90
7255J Bottom Mounting Pkg	US10B, SP313	PVPART.1780	13.90
7255J Bottom Mounting Pkg	US26, US26D, SP28	PVPART.1781	13.90
7255J Bottom Mounting Pkg	SPBLK	PVPART.1782	13.90
7255J Btm Security Mtg Pkg	-	PVPART.1783	20.70
7255J Bottom Wood Mtg Pkg	US3, US4, SP4	PVPART.1864	9.70
7255J Bottom Wood Mtg Pkg	US10, SP10	PVPART.1865	9.70
7255J Bottom Wood Mtg Pkg	US10B, SP313	PVPART.1866	9.70
7255J Bottom Wood Mtg Pkg	US26, US26D, SP28	PVPART.1867	9.70
7255J Bottom Wood Mtg Pkg	SPBLK	PVPART.1868	9.70
7256 Bottom Pivot			
7256 Btm Door Leaf	-	PVPART.1784	126.90
7256 Btm Base Pkg	-	PVPART.1785	464.60
7227/37/45/56/59 Finish Plate Pkg	US3	PVPART.1498	110.30
7227/37/45/56/59 Finish Plate Pkg	US4	PVPART.1499	110.30
7227/37/45/56/59 Finish Plate Pkg	US10	PVPART.1500	110.30
7227/37/45/56/59 Finish Plate Pkg	US10B	PVPART.1501	110.30
7227/37/45/56/59 Finish Plate Pkg	US26	PVPART.1502	110.30
7227/37/45/56/59 Finish Plate Pkg	US26D	PVPART.1503	100.60
7227/37/45/56/59 Finish Plate Pkg	SP4	PVPART.1506	92.30
7227/37/45/56/59 Finish Plate Pkg	SP10	PVPART.1507	92.30
7227/37/45/56/59 Finish Plate Pkg	SP28	PVPART.1508	92.30
7227/37/45/56/59 Finish Plate Pkg	SP313	PVPART.1509	92.30
7227/37/45/56/59 Finish Plate Pkg	SPBLK	PVPART.1510	92.30
7256 Btm Mounting Pkg	-	PVPART.1786	9.70
7256 Btm Security Mounting Pkg	-	PVPART.1787	13.90
7227/37/45/56/59 Finish Plate Screw (Pkg of 10)	-	PVPART.1335	2.00
7259 Bottom Pivot			
7259 Btm Door Leaf	-	PVPART.1817	253.90
7259 Btm Base Kit	-	PVPART.1818	675.50
7227/37/45/56/59 Finish Plate Pkg	US3	PVPART.1498	110.30
7227/37/45/56/59 Finish Plate Pkg	US4	PVPART.1499	110.30
7227/37/45/56/59 Finish Plate Pkg	US10	PVPART.1500	110.30
7227/37/45/56/59 Finish Plate Pkg	US10B	PVPART.1501	110.30
7227/37/45/56/59 Finish Plate Pkg	US26	PVPART.1502	110.30
7227/37/45/56/59 Finish Plate Pkg	US26D	PVPART.1503	100.60
7227/37/45/56/59 Finish Plate Pkg	SP4	PVPART.1506	92.30
7227/37/45/56/59 Finish Plate Pkg	SP10	PVPART.1507	92.30
7227/37/45/56/59 Finish Plate Pkg	SP28	PVPART.1508	92.30
7227/37/45/56/59 Finish Plate Pkg	SP313	PVPART.1509	92.30
7227/37/45/56/59 Finish Plate Pkg	SPBLK	PVPART.1510	92.30
7259 Btm Mounting Pkg	-	PVPART.1819	13.90
7259 Btm Security Mtg Pkg	-	PVPART.1820	30.30
91105 Pocket Pivot			
91105 Pocket Pivot Mtg Pkg	US3	PVPART.1188	20.70
91105 Pocket Pivot Mtg Pkg	US10	PVPART.1189	20.70
91105 Pocket Pivot Mtg Pkg	US32, US32D, USP	PVPART.1190	20.70
91105 Pocket Pivot Mtg Pkg	SP313	PVPART.1191	20.70
AS18			
AS18 Mounting Pkg	US3, US4	ASPART.1001	6.30
AS18 Mounting Pkg	US10	ASPART.1002	6.30
AS18 Mounting Pkg	US10B	ASPART.1003	6.30

Contact Ives Customer Service for pricing on additional sizes and finishes

Bold pricing indicates item is in stock and available for **Fast Track** and **ProXpress**

IVES ARCHITECTURAL HARDWARE - Parts Price List

Description	Finish	Part No.	List Price Each
AS18 (Continued)			
AS18 Mounting Pkg	US26, US26D	ASPART.1004	6.30
Silencer (Pkg of 10)	-	ASPART.1005	6.30
AS18 Security Mounting Pkg	-	ASPART.1006	12.60
AS895			
AS895 Mounting Pkg	US3, US4	ASPART.1007	6.30
AS895 Mounting Pkg	US10	ASPART.1008	6.30
AS895 Mounting Pkg	US10B	ASPART.1009	6.30
AS895 Mounting Pkg	US26, US26D	ASPART.1010	6.30
AS895 Security Mounting Pkg	-	ASPART.1011	12.60
CBI			
CBI Roller & Pin Pkg	-	CBPART.1001	6.30
CBI Mounting Pkg	US3, US4	CBPART.1002	16.20
CBI Mounting Pkg	US10	CBPART.1003	16.20
CBI Mounting Pkg	US10B	CBPART.1004	16.20
CBI Mounting Pkg	USP, US26, US26D	CBPART.1005	16.20
CBI Mounting Pkg	SPBLK	CBPART.1006	16.20
CBI Security Mounting Pkg	-	CBPART.1007	9.50
CL11			
CL11 Mounting Pkg	US3, US4	CLPART.1001	8.00
CL11 Mounting Pkg	US10	CLPART.1002	8.00
CL11 Mounting Pkg	US26D	CLPART.1003	8.00
CL11 Hook Pkg	US3	CLPART.1004	19.00
CL11 Hook Pkg	US4	CLPART.1005	16.20
CL11 Hook Pkg	US10	CLPART.1006	16.20
CL11 Hook Pkg	US26D	CLPART.1007	16.20
CL11 Security Mounting Pkg	-	CLPART.1008	16.20
CL12			
CL12 Mounting Pkg	US3, US4	CLPART.1009	8.00
CL12 Mounting Pkg	US10	CLPART.1010	8.00
CL12 Mounting Pkg	US26D	CLPART.1011	8.00
CL12 Hook Pkg	US3	CLPART.1012	19.00
CL12 Hook Pkg	US4	CLPART.1013	16.20
CL12 Hook Pkg	US10	CLPART.1014	16.20
CL12 Hook Pkg	US26D	CLPART.1015	16.20
CL12 Security Mounting Pkg	-	CLPART.1016	19.00
CL14			
CL14 Mounting Pkg	US3, US4	CLPART.1017	4.80
CL14 Mounting Pkg	US10	CLPART.1018	4.80
CL14 Mounting Pkg	US26D	CLPART.1019	4.80
CL14 Security Mounting Pkg	-	CLPART.1020	6.30
CL21			
CL21 Mounting Package	US26D	CLPART.1021	4.80
CL21 Hook Package	US26D	CLPART.1022	22.50
CL21 Security Mounting Package	-	CLPART.1023	6.30
CL21A			
CL21A Mounting Package	US3, US4	CLPART.1024	6.30
CL21A Mounting Package	US10	CLPART.1025	6.30
CL21A Mounting Package	US26, US26D	CLPART.1027	6.30
CL21A Hook Package	US3	CLPART.1028	22.50
CL21A Hook Package	US4	CLPART.1029	19.00
CL21A Hook Package	US10	CLPART.1030	19.00
CL21A Hook Package	US26	CLPART.1032	22.50
CL21A Hook Package	US26D	CLPART.1033	19.00

Contact Ives Customer Service for pricing on additional sizes and finishes

Bold pricing indicates item is in stock and available for **Fast Track** and **ProXpress**

IVES ARCHITECTURAL HARDWARE - Parts Price List

Description	Finish	Part No.	List Price Each
CL21A (continued)			
CL21A Security Mounting Package	-	CLPART.1034	12.60
CL22			
CL22 Mounting Pkg	US3, US4	CLPART.1035	6.30
CL22 Mounting Pkg	US10	CLPART.1036	6.30
CL22 Mounting Pkg	US26, US26D	CLPART.1038	6.30
CL22 Hook Pkg	US3	CLPART.1039	16.20
CL22 Hook Pkg	US4	CLPART.1040	12.60
CL22 Hook Pkg	US10	CLPART.1041	12.60
CL22 Hook Pkg	US26	CLPART.1043	16.20
CL22 Hook Pkg	US26D	CLPART.1044	12.60
CL22 Security Mounting Pkg	-	CLPART.1045	12.60
COR7G/COR9G			
COR7G/9G Nylon Roller & Bolt Pkg	US3,US4	CORPART.1001	23.90
COR7G/9G Nylon Roller & Bolt Pkg	US10	CORPART.1022	23.90
COR7G/9G Nylon Roller & Bolt Pkg	US10B	CORPART.1023	23.90
COR7G/9G Nylon Roller & Bolt Pkg	US26,US26D	CORPART.1024	23.90
COR7G/9G Rubber Roller & Pin Pkg	-	CORPART.1002	9.50
COR7G/9G Door Bracket Pkg	US3	CORPART.1003	28.60
COR7G/9G Door Bracket Pkg	US4	CORPART.1004	28.60
COR7G/9G Door Bracket Pkg	US10	CORPART.1005	28.60
COR7G/9G Door Bracket Pkg	US10B	CORPART.1006	28.60
COR7G/9G Door Bracket Pkg	US26	CORPART.1007	28.60
COR7G/9G Door Bracket Pkg	US26D	CORPART.1008	28.60
COR7G/9G Rub Plate Pkg	-	CORPART.1009	6.30
COR7G/9G Mounting Pkg	US3, US4	CORPART.1010	19.00
COR7G/9G Mounting Pkg	US10	CORPART.1011	19.00
COR7G/9G Mounting Pkg	US10B	CORPART.1012	19.00
COR7G/9G Mounting Pkg	US26, US26D	CORPART.1013	19.00
COR7G/9G Security Mounting Pkg	-	CORPART.1021	22.50
COR32/COR42/COR52/COR60/COR72			
COR32/42/52/60/72 Rub Plate (Pkg of 2)	-	CORPART.1014	10.80
COR32/42/52/60/72 Mounting Pkg	US28, US26D	CORPART.1018	10.80
COR32/42/52/60/72 Mounting Pkg	315AN	CORPART.1019	29.00
COR32/42/52/60/72 Security Mounting Pkg	-	CORPART.1020	38.50
CS115			
CS115/SB453/454/0454 Thru Bolt with Cap Nut Pkg (Set of 4)	US26D	09-340-626	9.20
Sex Bolt Pkg	US26D, US2C	09-351-604	17.00
DP2			
DP2 Plate Pkg	US3	DPPART.1001	12.60
DP2 Plate Pkg	US4	DPPART.1002	12.60
DP2 Plate Pkg	US10	DPPART.1003	12.60
DP2 Plate Pkg	US10B	DPPART.1004	12.60
DP2 Plate Pkg	US26	DPPART.1005	12.60
DP2 Plate Pkg	US26D	DPPART.1006	12.60
DP2 Mounting Pkg	US3, US4	DPPART.1007	4.80
DP2 Mounting Pkg	US10	DPPART.1008	4.80
DP2 Mounting Pkg	US10B	DPPART.1009	4.80
DP2 Mounting Pkg	US26, US26D	DPPART.1010	4.80
DP2 Security Mounting Pkg	-	DPPART.1011	6.30
FB30 Series - Metal Door Automatic Flushbolt			
FB30T Face Plate Pkg	US3	FBPART.1001	42.80
FB30T Face Plate Pkg	US4	FBPART.1002	42.80
FB30T Face Plate Pkg	US10	FBPART.1003	42.80
FB30T Face Plate Pkg	US10B	FBPART.1004	42.80

Contact Ives Customer Service for pricing on additional sizes and finishes

Bold pricing indicates item is in stock and available for **Fast Track** and **ProXpress**

IVES ARCHITECTURAL HARDWARE - Parts Price List

Description	Finish	Part No.	List Price Each
FB30 Series - Metal Door Automatic Flushbolt (Continued)			
FB30T Face Plate Pkg	US32	FBPART.1005	42.80
FB30T Face Plate Pkg	US32D	FBPART.1006	42.80
FB30T Face Plate Pkg	BLK	FBPART.1092	42.80
FB30B/50B Face Plate Pkg	US3	FBPART.1007	42.80
FB30B/50B Face Plate Pkg	US4	FBPART.1008	42.80
FB30B/50B Face Plate Pkg	US10	FBPART.1009	42.80
FB30B/50B Face Plate Pkg	US10B	FBPART.1010	42.80
FB30B/50B Face Plate Pkg	US32	FBPART.1011	42.80
FB30B/50B Face Plate Pkg	US32D	FBPART.1012	42.80
FB30B/50B Face Plate Pkg	BLK	FBPART.1093	42.80
FB30/50 Guide Pkg	-	FBPART.1013	8.00
FB30/40/50/60 Rub Plate & Shim Pkg	-	FBPART.1014	3.30
FB30/40/50B/60B Auxiliary Bolt	-	FBPART.1015	4.80
FB30/50 8 3/4" Rod & Bolt Tip Kit - 12"	-	FBPART.1016	12.60
FB30/50B Bolt Tip	-	FBPART.1017	12.60
FB30/50 8 3/4" - 12" Rod Only	-	FBPART.1018	6.30
FB30/50 7 1/2" Rod & Bolt Tip Kit - 9"	-	FBPART.1019	12.60
FB30/50 16 1/2" Rod & Bolt Tip Kit - 18"	-	FBPART.1020	12.60
FB30/50 22 1/2" Rod & Bolt Tip Kit - 24"	-	FBPART.1021	12.60
FB30/50 28 1/2" Rod & Bolt Tip Kit - 30"	-	FBPART.1022	12.60
FB30/50 34 1/2" Rod & Bolt Tip Kit - 36"	-	FBPART.1023	12.60
FB30/50 46 1/2" Rod & Bolt Tip Kit - 48"	-	FBPART.1024	12.60
FB30/40/50B/60B Strike Pkg	US3, US4	FBPART.1025	9.50
FB30/40/50B/60B Strike Pkg	US10	FBPART.1026	9.50
FB30/40/50B/60B Strike Pkg	US10B	FBPART.1027	9.50
FB30/40/50B/60B Strike Pkg	US32, US32D	FBPART.1028	9.50
FB30/40/50B/60B Strike Pkg	BLK	FBPART.1094	9.50
FB30/50 Mounting Pkg	US3, US4	FBPART.1029	22.50
FB30/50 Mounting Pkg	US10	FBPART.1030	22.50
FB30/50 Mounting Pkg	US10B	FBPART.1031	22.50
FB30/50 Mounting Pkg	US32, US32D	FBPART.1032	22.50
FB30/50 Mounting Pkg	BLK	FBPART.1095	22.50
FB30/50 Security Mounting Pkg	-	FBPART.1033	38.20
FB32/42/52/62 AFL Plug/Screw Pkg	-	FBPART.1034	5.60
FB32/42/52/62 Auxiliary Fire Latch	-	FBPART.1035	135.40
FB30/50 Retrofit Pkg	-	FBPART.1065	10.80
FB30/40/50/60 Face Plate Screws, Pkg 10	US3, US4	FBPART.1066	7.00
FB30/40/50/60 Face Plate Screws, Pkg 10	US10	FBPART.1067	7.00
FB30/40/50/60 Face Plate Screws, Pkg 10	US10B	FBPART.1068	7.00
FB30/40/50/60 Face Plate Screws, Pkg 10	US32, US32D	FBPART.1069	7.00
FB30/40/50/60 Face Plate Screws, Pkg 10	BLK	FBPART.1101	7.00
FB40 Series - Wood Door Automatic Flushbolt			
FB40T Face Plate Pkg	US3	FBPART.1036	42.80
FB40T Face Plate Pkg	US4	FBPART.1037	42.80
FB40T Face Plate Pkg	US10	FBPART.1038	42.80
FB40T Face Plate Pkg	US10B	FBPART.1039	42.80
FB40T Face Plate Pkg	US32	FBPART.1040	42.80
FB40T Face Plate Pkg	US32D	FBPART.1041	42.80
FB40T Face Plate Pkg	BLK	FBPART.1097	42.80
FB40B/60B Face Plate Pkg	US3	FBPART.1042	42.80
FB40B/60B Face Plate Pkg	US4	FBPART.1043	42.80
FB40B/60B Face Plate Pkg	US10	FBPART.1044	42.80
FB40B/60B Face Plate Pkg	US10B	FBPART.1045	42.80

Contact Ives Customer Service for pricing on additional sizes and finishes

Bold pricing indicates item is in stock and available for **Fast Track** and **ProXpress**

IVES ARCHITECTURAL HARDWARE - Parts Price List

Description	Finish	Part No.	List Price Each
FB40 Series - Wood Door Automatic Flushbolt (Continued)			
FB40B/60B Face Plate Pkg	US32	FBPART.1046	42.80
FB40B/60B Face Plate Pkg	US32D	FBPART.1047	42.80
FB40T Face Plate Pkg	BLK	FBPART.1097	42.80
FB30/40/50/60 Rub Plate & Shim Pkg	-	FBPART.1014	3.30
FB40/60 Guide Pkg	-	FBPART.1048	9.50
FB40/60 Cover	-	FBPART.1049	6.30
FB30/40/50B/60B Auxiliary Bolt	-	FBPART.1015	4.80
FB40/60B Rod & Bolt Tip Kit	-	FBPART.1050	9.50
FB40/60B Bolt Tip	-	FBPART.1051	4.80
FB40/60 Rod - 2 1/2"	-	FBPART.1052	4.80
FB30/40/50B/60B Strike Pkg	US3, US4	FBPART.1025	9.50
FB30/40/50B/60B Strike Pkg	US10	FBPART.1026	9.50
FB30/40/50B/60B Strike Pkg	US10B	FBPART.1027	9.50
FB30/40/50B/60B Strike Pkg	US32, US32D	FBPART.1028	9.50
FB30/40/50B/60B Strike Pkg	BLK	FBPART.1094	9.50
FB40/60 Mounting Pkg	US3, US4	FBPART.1053	22.50
FB40/60 Mounting Pkg	US10	FBPART.1054	22.50
FB40/60 Mounting Pkg	US10B	FBPART.1055	22.50
FB40/60 Mounting Pkg	US32, US32D	FBPART.1056	22.50
FB40/60 Mounting Pkg		FBPART.1099	22.50
FB40/60 Security Mounting Pkg	-	FBPART.1057	35.10
FB32/42/52/62 AFL Plug/Screw Pkg	-	FBPART.1034	5.60
FB32/42/52/62 Auxiliary Fire Latch	-	FBPART.1035	135.40
FB30/40/50/60 Face Plate Screws. Pkg 10	US3, US4	FBPART.1066	7.00
FB30/40/50/60 Face Plate Screws. Pkg 10	US10	FBPART.1067	7.00
FB30/40/50/60 Face Plate Screws. Pkg 10	US10B	FBPART.1068	7.00
FB30/40/50/60 Face Plate Screws. Pkg 10	US32, US32D	FBPART.1069	7.00
FB30/40/50/60 Face Plate Screws. Pkg 10	BLK	FBPART.1101	7.00
FB50 Series - Metal Door Constant Latching Flushbolt			
FB50T Face Plate Pkg	US3	FBPART.1058	42.80
FB50T Face Plate Pkg	US4	FBPART.1059	42.80
FB50T Face Plate Pkg	US10	FBPART.1060	42.80
FB50T Face Plate Pkg	US10B	FBPART.1061	42.80
FB50T Face Plate Pkg	US32	FBPART.1062	42.80
FB50T Face Plate Pkg	US32D	FBPART.1063	42.80
FB50T Face Plate Pkg	BLK	FBPART.1100	42.80
FB30B/50B Face Plate Pkg	US3	FBPART.1007	42.80
FB30B/50B Face Plate Pkg	US4	FBPART.1008	42.80
FB30B/50B Face Plate Pkg	US10	FBPART.1009	42.80
FB30B/50B Face Plate Pkg	US10B	FBPART.1010	42.80
FB30B/50B Face Plate Pkg	US32	FBPART.1011	42.80
FB30B/50B Face Plate Pkg	US32D	FBPART.1012	42.80
FB30B/50B Face Plate Pkg	BLK	FBPART.1093	42.80
FB30/50 Guide Pkg	-	FBPART.1013	8.00
FB30/40/50/60 Rub Plate & Shim Pkg	-	FBPART.1014	3.30
FB30/40/50B/60B Auxiliary Bolt	-	FBPART.1015	4.80
FB50T/60T Auxiliary Bolt	-	FBPART.1070	9.50
FB50T Rod & Bolt Tip Kit - 12"	-	FBPART.1071	14.20
FB50T Bolt Tip	-	FBPART.1072	8.00
FB30/50 8 3/4" Rod & Bolt Tip Kit - 12"	-	FBPART.1016	12.60
FB30/50B Bolt Tip	-	FBPART.1017	12.60
FB30/50 8 3/4" - 12" Rod Only	-	FBPART.1018	6.30
FB30/50 7 1/2" Rod & Bolt Tip Kit - 9"	-	FBPART.1019	12.60

Contact Ives Customer Service for pricing on additional sizes and finishes

Bold pricing indicates item is in stock and available for **Fast Track** and **ProXpress**

IVES ARCHITECTURAL HARDWARE - Parts Price List

Description	Finish	Part No.	List Price Each
FB50 Series - Metal Door Constant Latching Flushbolt (Continued)			
FB30/50 16 1/2" Rod & Bolt Tip Kit - 18"	-	FBPART.1020	12.60
FB30/50 22 1/2" Rod & Bolt Tip Kit - 24"	-	FBPART.1021	12.60
FB30/50 28 1/2" Rod & Bolt Tip Kit - 30"	-	FBPART.1022	12.60
FB30/50 34 1/2" Rod & Bolt Tip Kit - 36"	-	FBPART.1023	12.60
FB30/50 46 1/2" Rod & Bolt Tip Kit - 48"	-	FBPART.1024	12.60
FB30/40/50B/60B Strike Pkg	US3, US4	FBPART.1025	9.50
FB30/40/50B/60B Strike Pkg	US10	FBPART.1026	9.50
FB30/40/50B/60B Strike Pkg	US10B	FBPART.1027	9.50
FB30/40/50B/60B Strike Pkg	US32, US32D	FBPART.1028	9.50
FB30/40/50B/60B Strike Pkg	BLK	FBPART.1094	9.50
FB30/50 Mounting Pkg	US3, US4	FBPART.1029	22.50
FB30/50 Mounting Pkg	US10	FBPART.1030	22.50
FB30/50 Mounting Pkg	US10B	FBPART.1031	22.50
FB30/50 Mounting Pkg	US32, US32D	FBPART.1032	22.50
FB30/50 Mounting Pkg	BLK	FBPART.1095	22.50
FB30/50 Security Mounting Pkg	-	FBPART.1033	38.20
FB50T/60T Top Strike Pkg	US3	FBPART.1073	26.90
FB50T/60T Top Strike Pkg	US4	FBPART.1074	26.90
FB50T/60T Top Strike Pkg	US10	FBPART.1075	26.90
FB50T/60T Top Strike Pkg	US10B	FBPART.1076	26.90
FB50T/60T Top Strike Pkg	US32, US32D	FBPART.1077	26.90
FB50T/60T Top Strike Pkg	BLK	FBPART.1102	26.90
FB32/42/52/62 AFL Plug/Screw Pkg	-	FBPART.1034	5.60
FB32/42/52/62 Auxiliary Fire Latch	-	FBPART.1035	135.40
FB30/50 Retrofit Plate Pkg	-	FBPART.1065	10.80
FB30/40/50/60 Face Plate Screws. Pkg 10	US3, US4	FBPART.1066	7.00
FB30/40/50/60 Face Plate Screws. Pkg 10	US10	FBPART.1067	7.00
FB30/40/50/60 Face Plate Screws. Pkg 10	US10B	FBPART.1068	7.00
FB30/40/50/60 Face Plate Screws. Pkg 10	US32, US32D	FBPART.1069	7.00
FB30/40/50/60 Face Plate Screws. Pkg 10	BLK	FBPART.1101	7.00
FB60 Series - Wood Door Constant Latching Flushbolt			
FB60T Face Plate Pkg	US3	FBPART.1078	42.80
FB60T Face Plate Pkg	US4	FBPART.1079	42.80
FB60T Face Plate Pkg	US10	FBPART.1080	42.80
FB60T Face Plate Pkg	US10B	FBPART.1081	42.80
FB60T Face Plate Pkg	US32	FBPART.1082	42.80
FB60T Face Plate Pkg	US32D	FBPART.1083	42.80
FB60T Face Plate Pkg	BLK	FBPART.1103	42.80
FB40B/60B Face Plate Pkg	US3	FBPART.1042	42.80
FB40B/60B Face Plate Pkg	US4	FBPART.1043	42.80
FB40B/60B Face Plate Pkg	US10	FBPART.1044	42.80
FB40B/60B Face Plate Pkg	US10B	FBPART.1045	42.80
FB40B/60B Face Plate Pkg	US32	FBPART.1046	42.80
FB40B/60B Face Plate Pkg	US32D	FBPART.1047	42.80
FB40B/60B Face Plate Pkg	BLK	FBPART.1098	42.80
FB30/40/50/60 Rub Plate & Shim Pkg	-	FBPART.1014	3.30
FB40/60 Guide Pkg	-	FBPART.1048	9.50
FB40/60 Cover	-	FBPART.1049	6.30
FB30/40/50B/60B Auxiliary Bolt	-	FBPART.1015	4.80
FB50T/60T Auxiliary Bolt	-	FBPART.1070	9.50
FB60T Rod & Bolt Tip Kit	-	FBPART.1090	12.60
FB60T Bolt Tip	-	FBPART.1091	8.00
FB40/60B Rod & Bolt Tip Kit	-	FBPART.1050	9.50

Contact Ives Customer Service for pricing on additional sizes and finishes

Bold pricing indicates item is in stock and available for **Fast Track** and **ProXpress**

IVES ARCHITECTURAL HARDWARE - Parts Price List

Description	Finish	Part No.	List Price Each
FB60 Series - Wood Door Constant Latching Flushbolt (Continued)			
FB40/60B Bolt Tip	-	FBPART.1051	4.80
FB40/60 Rod - 2 1/2"	-	FBPART.1052	4.80
FB30/40/50B/60B Strike Pkg	US3, US4	FBPART.1025	9.50
FB30/40/50B/60B Strike Pkg	US10	FBPART.1026	9.50
FB30/40/50B/60B Strike Pkg	US10B	FBPART.1027	9.50
FB30/40/50B/60B Strike Pkg	US32, US32D	FBPART.1028	9.50
FB30/40/50B/60B Strike Pkg	BLK	FBPART.1094	9.50
FB40/60 Mounting Pkg	US3, US4	FBPART.1053	22.50
FB40/60 Mounting Pkg	US10	FBPART.1054	22.50
FB40/60 Mounting Pkg	US10B	FBPART.1055	22.50
FB40/60 Mounting Pkg	US32, US32D	FBPART.1056	22.50
FB40/60 Mounting Pkg	BLK	FBPART.1099	22.50
FB40/60 Security Mounting Pkg	-	FBPART.1057	35.10
FB50T/60T Top Strike Pkg	US3	FBPART.1073	26.90
FB50T/60T Top Strike Pkg	US4	FBPART.1074	26.90
FB50T/60T Top Strike Pkg	US10	FBPART.1075	26.90
FB50T/60T Top Strike Pkg	US10B	FBPART.1076	26.90
FB50T/60T Top Strike Pkg	US32, US32D	FBPART.1077	26.90
FB50T/60T Top Strike Pkg	BLK	FBPART.1102	26.90
FB32/42/52/62 AFL Plug/Screw Pkg	-	FBPART.1034	5.60
FB32/42/52/62 Auxiliary Fire Latch	-	FBPART.1035	135.40
FB30/40/50/60 Face Plate Screws. Pkg 10	US3, US4	FBPART.1066	7.00
FB30/40/50/60 Face Plate Screws. Pkg 10	US10	FBPART.1067	7.00
FB30/40/50/60 Face Plate Screws. Pkg 10	US10B	FBPART.1068	7.00
FB30/40/50/60 Face Plate Screws. Pkg 10	US32, US32D	FBPART.1069	7.00
FB30/40/50/60 Face Plate Screws. Pkg 10	BLK	FBPART.1101	7.00
FB457//FB458 Metal Door Manual Flushbolt			
Guide	-	09-135	2.40
Bolt Tip	-	09-176-604	5.50
Rod - 18"	-	09-161	6.60
Rod - 24"	-	09-162	6.60
Rod - 36"	-	09-172	6.60
Rod - 48"	-	09-173	6.60
FS9			
FS9 Hook Pkg	US3	FSPART.1001	55.70
FS9 Hook Pkg	US4	FSPART.1002	55.70
FS9 Hook Pkg	US10	FSPART.1003	55.70
FS9 Hook Pkg	US10B	FSPART.1004	47.90
FS9 Hook Pkg	US26	FSPART.1005	55.70
FS9 Hook Pkg	US26D	FSPART.1006	47.90
FS9 Mounting Pkg	US3, US4	FSPART.1007	6.30
FS9 Mounting Pkg	US10	FSPART.1008	6.30
FS9 Mounting Pkg	US10B	FSPART.1009	6.30
FS9 Mounting Pkg	US26, US26D	FSPART.1010	6.30
FS9 Security Mounting Pkg	-	FSPART.1011	9.50
FS9 Stud & Lead Anchor Pkg	-	FSPART.1012	9.50
FS13/FS17			
FS13/17 Rubber (Pkg of 6)	-	FSPART.1013	19.00
FS13/17 Mounting Pkg	US3, US4	FSPART.1014	3.30
FS13/17 Mounting Pkg	US10	FSPART.1015	3.30
FS13/17 Mounting Pkg	US10B	FSPART.1016	3.30
FS13/17 Mounting Pkg	US26, US26D	FSPART.1017	3.30

Contact Ives Customer Service for pricing on additional sizes and finishes

Bold pricing indicates item is in stock and available for **Fast Track** and **ProXpress**

IVES ARCHITECTURAL HARDWARE - Parts Price List

Description	Finish	Part No.	List Price Each
FS13/17 Security Mounting Pkg	-	FSPART.1018	3.30
FS40/FS41/FS42/FS43			
FS40 Strike Pkg	US3	FSPART.1019	33.50
FS40 Strike Pkg	US4	FSPART.1020	31.90
FS40 Strike Pkg	US10	FSPART.1021	31.90
FS40 Strike Pkg	US10B	FSPART.1022	39.90
FS40 Strike Pkg	US26	FSPART.1023	33.50
FS40 Strike Pkg	US26D	FSPART.1024	31.90
FS41 Strike Pkg	US3	FSPART.1034	33.50
FS41 Strike Pkg	US4	FSPART.1035	31.90
FS41 Strike Pkg	US10	FSPART.1036	31.90
FS41 Strike Pkg	US10B	FSPART.1037	39.90
FS41 Strike Pkg	US26	FSPART.1038	33.50
FS41 Strike Pkg	US26D	FSPART.1039	31.90
FS42 Strike Pkg	US3	FSPART.1040	33.50
FS42 Strike Pkg	US4	FSPART.1041	31.90
FS42 Strike Pkg	US10	FSPART.1042	31.90
FS42 Strike Pkg	US10B	FSPART.1043	39.90
FS42 Strike Pkg	US26	FSPART.1044	33.50
FS42 Strike Pkg	US26D	FSPART.1045	31.90
FS43 Strike Pkg	US3	FSPART.1046	33.50
FS43 Strike Pkg	US4	FSPART.1047	31.90
FS43 Strike Pkg	US10	FSPART.1048	31.90
FS43 Strike Pkg	US10B	FSPART.1049	39.90
FS43 Strike Pkg	US26	FSPART.1050	33.50
FS43 Strike Pkg	US26D	FSPART.1051	31.90
FS40/41/42/43 Strike Mounting Pkg	US3, US4	FSPART.1025	6.30
FS40/41/42/43 Strike Mounting Pkg	US10	FSPART.1026	6.30
FS40/41/42/43 Strike Mounting Pkg	US10B	FSPART.1027	6.30
FS40/41/42/43 Strike Mounting Pkg	US26, US26D	FSPART.1028	6.30
FS40/41/42/43 Body Mounting Pkg	US3, US4	FSPART.1029	6.30
FS40/41/42/43 Body Mounting Pkg	US10	FSPART.1030	6.30
FS40/41/42/43 Body Mounting Pkg	US10B	FSPART.1031	6.30
FS40/41/42/43 Body Mounting Pkg	US26, US26D	FSPART.1032	6.30
FS40/41/42/43 Security Mounting Pkg	-	FSPART.1033	22.50
FS434			
FS434 Rubber	-	09-318	4.60
FS441			
FS441/442/451 Rubber	-	09-315	2.40
FS442			
FS441/442/451 Rubber	-	09-315	2.40
FS444/FS446/FS448/FS450			
Rubber Tip, order in quantities of 100	-	09-316	2.40
FS451			
FS441/442/451 Rubber	-	09-315	2.40
FS452			
FS452/455	Rubber (Order in quantities of 100, Price per package of 100)	HRT (FSPART.1075)	133.40
FS455			
FS452/455	Rubber (Order in quantities of 100, Price per package of 100)	HRT (FSPART.1075)	133.40
FS544/FS555			
FS544/555 Rubber - Threaded (Pkg of 6)	-	FSPART.1052	19.00
FS544/555 Mounting Pkg	SP4	FSPART.1054	4.80

Contact Ives Customer Service for pricing on additional sizes and finishes

Bold pricing indicates item is in stock and available for **Fast Track** and **ProXpress**

IVES ARCHITECTURAL HARDWARE - Parts Price List

Description	Finish	Part No.	List Price Each
FS544/FS555 (continued)			
FS544/555 Mounting Pkg	SP10	FSPART.1055	4.80
FS544/555 Mounting Pkg	SP313	FSPART.1056	4.80
FS544/555 Mounting Pkg	SP28	FSPART.1057	4.80
FS544/555 Mounting Pkg	SPBLK	FSPART.1058	4.80
FS544/555 Security Mounting Pkg	-	FSPART.1059	12.60
FS544/555 Rubber with Screw	-	FSPART.1074	3.30
FS1153			
FS1153 Rubber Pkg	-	FSPART.1060	3.30
FS1153 Mounting Pkg	US28	FSPART.1061	3.30
FS1153 Security Mounting Pkg	-	FSPART.1062	6.30
FS1154			
FS1154 Rubber Pkg	-	FSPART.1063	3.30
FS1154 Mounting Pkg	US3, US4	FSPART.1064	4.80
FS1154 Mounting Pkg	US10	FSPART.1065	4.80
FS1154 Mounting Pkg	US10B	FSPART.1066	4.80
FS1154 Mounting Pkg	US26, US26D	FSPART.1067	4.80
FS1154 Security Mounting Pkg	-	FSPART.1068	9.50
LGI			
LGI/7 Mounting Pkg	US32D, US2G	LGPART.1001	6.30
LGI/7 Mounting Pkg	USP	LGPART.1002	16.20
LGI/7 Mounting Pkg	US4	LGPART.1003	16.20
LGI/7 Mounting Pkg	US10	LGPART.1004	16.20
LGI/7 Mounting Pkg	SP313	LGPART.1005	16.20
LG7			
LGI/7 Mounting Pkg	US32D	LGPART.1001	6.30
LG10			
LG10/12/14 Mounting Pkg	US32D, USP	LGPART.1007	4.80
LG10/12/14 Security Mounting Pkg	-	LGPART.1008	12.60
LG11			
LG11/13 Mounting Pkg	US32D, SP313	LGPART.1009	4.80
LG11/13 Security Mounting Pkg	-	LGPART.1010	6.30
LG12			
LG10/12/14 Mounting Pkg	US32D, USP	LGPART.1007	4.80
LG10/12/14 Security Mounting Pkg	-	LGPART.1008	12.60
LG13			
LG11/13 Mounting Pkg	US32D, SP313	LGPART.1009	4.80
LG11/13 Security Mounting Pkg	-	LGPART.1010	6.30
LG14			
LG10/12/14 Mounting Pkg	US32D	LGPART.1007	4.80
LG10/12/14 Security Mounting Pkg	-	LGPART.1008	12.60
MB1F/MB2F/MB3F/MB1V/MB2V/MB3V			
MB1/2 AL Mounting Pkg	SPBLK	MBPART.1006	12.60
MB1/2 AL Security Mounting Pkg	-	MBPART.1007	12.60
MB1F/2F/3F/1V/2V/3V STL Mounting Pkg	SP28, USP	MBPART.1011	12.60
MB1F/2F/3F/1V/2V/3V STL Mounting Pkg	SPBLK	MBPART.1013	12.60
MB1F/2F/3F/1V/2V/3V STL Security Mtg Pkg	-	MBPART.1014	12.60
RB470/RB471/RB472			
RB470/471/472 Roller, Bushing & Rivet Pkg	US15, US26D	09-137-626	6.30
RL30			
RL30 Standard Strike Mtg Pkg	US3, US4	RLPART.1001	6.30
RL30 Standard Strike Mtg Pkg	US10	RLPART.1002	6.30
RL30 Standard Strike Mtg Pkg	US10B	RLPART.1003	6.30

Contact Ives Customer Service for pricing on additional sizes and finishes

Bold pricing indicates item is in stock and available for **Fast Track** and **ProXpress**

IVES ARCHITECTURAL HARDWARE - Parts Price List

Description	Finish	Part No.	List Price Each
RL30 (Continued)			
RL30 Standard Strike Mtg Pkg	US26, US26D	RLPART.1004	6.30
RL30 ASA Strike Mtg Pkg	US3, US4	RLPART.1005	9.50
RL30 ASA Strike Mtg Pkg	US10	RLPART.1006	9.50
RL30 ASA Strike Mtg Pkg	US10B	RLPART.1007	9.50
RL30 ASA Strike Mtg Pkg	US26, US26D	RLPART.1008	9.50
RL30 Standard Strike Security Mtg Pkg	-	RLPART.1009	12.60
RL30 ASA Strike Security Mtg Pkg	-	RLPART.1010	12.60
RL30 Strike Pkg	US3	RLPART.1011	19.00
RL30 Strike Pkg	US4	RLPART.1012	19.00
RL30 Strike Pkg	US10	RLPART.1013	19.00
RL30 Strike Pkg	US10B	RLPART.1014	19.00
RL30 Strike Pkg	US26	RLPART.1015	19.00
RL30 Strike Pkg	US26D	RLPART.1016	19.00
RL30/32/36 ASA Strike Pkg	US3	RLPART.1017	19.00
RL30/32/36 ASA Strike Pkg	US4	RLPART.1018	19.00
RL30/32/36 ASA Strike Pkg	US10	RLPART.1019	19.00
RL30/32/36 ASA Strike Pkg	US10B	RLPART.1020	19.00
RL30/32/36 ASA Strike Pkg	US26	RLPART.1021	19.00
RL30/32/36 ASA Strike Pkg	US26D	RLPART.1022	19.00
RL30/1152 Rubber Roller, Silencers & Pin Pkg	-	RLPART.1023	12.60
RL30/1152 Nylon Coated Brass Roller & Pin Pkg	-	RLPART.1024	12.60
RL30/1152 Nylon Roller & Pin Pkg	-	RLPART.1025	11.10
RL30/1152 Roller Pin	-	RLPART.1026	3.30
RL30/1152 Nylon Silencers (Pkg of 2)	-	RLPART.1027	1.40
RL32			
RL32/36 Standard Strike Mtg Pkg	US3, US4	RLPART.1028	6.30
RL32/36 Standard Strike Mtg Pkg	US10	RLPART.1029	6.30
RL32/36 Standard Strike Mtg Pkg	US10B	RLPART.1030	6.30
RL32/36 Standard Strike Mtg Pkg	US32, US32D	RLPART.1031	6.30
RL32/36 ASA Strike Mtg Pkg	US3, US4	RLPART.1032	9.50
RL32/36 ASA Strike Mtg Pkg	US10	RLPART.1033	9.50
RL32/36 ASA Strike Mtg Pkg	US10B	RLPART.1034	9.50
RL32/36 ASA Strike Mtg Pkg	US32, US32D	RLPART.1035	9.50
RL32/36 Standard Strike Security Mtg Pkg	-	RLPART.1036	12.60
RL32/36 ASA Strike Security Mtg Pkg	-	RLPART.1037	12.60
RL32/36 Strike Pkg	US3	RLPART.1038	19.00
RL32/36 Strike Pkg	US4	RLPART.1039	19.00
RL32/36 Strike Pkg	US10	RLPART.1040	19.00
RL32/36 Strike Pkg	US10B	RLPART.1041	19.00
RL32/36 Strike Pkg	US32	RLPART.1042	19.00
RL32/36 Strike Pkg	US32D	RLPART.1043	19.00
RL30/32/36 ASA Strike Pkg	US3	RLPART.1017	19.00
RL30/32/36 ASA Strike Pkg	US4	RLPART.1018	19.00
RL30/32/36 ASA Strike Pkg	US10	RLPART.1019	19.00
RL30/32/36 ASA Strike Pkg	US10B	RLPART.1020	19.00
RL30/32/36 ASA Strike Pkg	US26	RLPART.1021	19.00
RL30/32/36 ASA Strike Pkg	US26D	RLPART.1022	19.00
RL32 Nylon Roller & Pin Pkg	-	RLPART.1045	11.10
RL32 Roller Pin	-	RLPART.1046	3.30
RL36			
RL32/36 Standard Strike Mtg Pkg	US32D	RLPART.1031	6.30
RL32/36 ASA Strike Mtg Pkg	US32D	RLPART.1035	9.50
RL32/36 Standard Strike Security Mtg Pkg	-	RLPART.1036	12.60

Contact Ives Customer Service for pricing on additional sizes and finishes

Bold pricing indicates item is in stock and available for **Fast Track** and **ProXpress**

IVES ARCHITECTURAL HARDWARE - Parts Price List

Description	Finish	Part No.	List Price Each
RL36 (Continued)			
RL32/36 ASA Strike Security Mtg Pkg	-	RLPART.1037	12.60
RL32/36 Strike Pkg	US32D	RLPART.1043	19.00
RL30/32/36 ASA Strike Pkg	US26D	RLPART.1022	19.00
RL38			
RL38 Mounting Pkg	US32D	RLPART.1051	6.30
RL38 Security Mtg Pkg	-	RLPART.1053	12.60
RL1152			
RL1152 Mounting Pkg	US3, US4	RLPART.1054	6.30
RL1152 Mounting Pkg	US10	RLPART.1055	6.30
RL1152 Mounting Pkg	US10B	RLPART.1056	6.30
RL1152 Mounting Pkg	US26, US26D	RLPART.1057	6.30
RL1152 Security Mounting Pkg	-	RLPART.1058	12.60
RL1152 Strike Pkg	US3	RLPART.1059	19.00
RL1152 Strike Pkg	US4	RLPART.1060	19.00
RL1152 Strike Pkg	US10	RLPART.1061	19.00
RL1152 Strike Pkg	US10B	RLPART.1062	19.00
RL1152 Strike Pkg	US26	RLPART.1063	19.00
RL1152 Strike Pkg	US26D	RLPART.1064	19.00
RL30/1152 Rubber Roller, Silencers & Pin Pkg	-	RLPART.1023	12.60
RL30/1152 Brass Roller & Pin Pkg	-	RLPART.1024	12.60
RL30/1152 Nylon Roller & Pin Pkg	-	RLPART.1025	11.10
RL30/1152 Roller Pin	-	RLPART.1026	3.30
RL30/1152 Nylon Silencers (Pkg of 2)	-	RLPART.1027	1.40
SB360			
SB360 Mortise Strike Pkg	US2C	09-82-604	26.50
SB360 Sex Bolt Package (Set of 4)	US2C	09-350-604	21.70
SB453			
Thru Bolt with Cap Nut Pkg (Set of 4)	US26D, US2C	09-340-626	9.20
Sex Bolt Pkg	US26D, US2C	09-351-604	17.00
SBI630/SBI640/SBI600M1/SBI600M2			
SBI600 Top Strike Pkg	US2G	SBPART.1001	17.50
SBI600 Top Strike Pkg	US3	SBPART.1002	30.20
SBI600 Top Strike Pkg	US10B, SP313	SBPART.1003	30.20
SBI600 Top Strike Pkg	US26D, SP28	SBPART.1004	20.70
SBI600 Top Strike Pkg	SP4	SBPART.1015	30.20
SBI600 Top Strike Pkg	SP10	SBPART.1016	30.20
SBI600 Top Strike Pkg	SPBLK	SBPART.1019	30.20
SBI600 Bottom Strike Pkg	US2G	SBPART.1005	12.60
SBI600 Bottom Strike Pkg	US3	SBPART.1006	25.70
SBI600 Bottom Strike Pkg	US10B, SP313	SBPART.1007	25.70
SBI600 Bottom Strike Pkg	US26D, SP28	SBPART.1008	16.20
SBI600 Bottom Strike Pkg	SP4	SBPART.1020	25.70
SBI600 Bottom Strike Pkg	SP10	SBPART.1021	25.70
SBI600 Bottom Strike Pkg	SPBLK	SBPART.1024	25.70
SBI600 Bolt Mounting Pkg	-	SBPART.1009	6.30
SBI600 End Plug & Stud Pkg	-	SBPART.1010	9.50
SBI600 Security Mounting Pkg	-	SBPART.1011	12.60
SBI600 Lock Housing Pkg	US2G	SBPART.1033	23.90
SBI600 Lock Housing Pkg	US3	SBPART.1034	39.90
SBI600 Lock Housing Pkg	US10B	SBPART.1035	39.90
SBI600 Lock Housing Pkg	US26D	SBPART.1036	31.90
SBI600 Lock Housing Pkg	SP4	SBPART.1017	39.90
SBI600 Lock Housing Pkg	SP10	SBPART.1018	39.90

Contact Ives Customer Service for pricing on additional sizes and finishes

Bold pricing indicates item is in stock and available for **Fast Track** and **ProXpress**

IVES ARCHITECTURAL HARDWARE - Parts Price List

Description	Finish	Part No.	List Price Each
SB1630/SB1640/SB1600M1/SB1600M2 (Continued)			
SB1600 Lock Housing Pkg	SP313	SBPART.1023	39.90
SB1600 Lock Housing Pkg	SP28	SBPART.1025	39.90
SB1600 Lock Housing Pkg	SPBLK	SBPART.1022	39.90
SB1600 Lock Cylinder - 1289	-	SBPART.1037	19.00
SB1600 Lock Cylinder - 1360	-	SBPART.1038	19.00
SB1600 Lock Cylinder - 1390	-	SBPART.1039	19.00
SB1600 Lock Cylinder - 1395	-	SBPART.1040	19.00
SB1600 Sex Bolt Pkg (Set of 3)	US26D, US26G,SP28	SBPART.1012	29.50
SB1600 Sex Bolt Pkg (Set of 3)	US3	SBPART.1013	29.50
SB1600 Sex Bolt Pkg (Set of 3)	US10B,SP313	SBPART.1014	29.50
SB1600 Sex Bolt Pkg (Set of 3)	SP4	SBPART.1028	29.50
SB1600 Sex Bolt Pkg (Set of 3)	SP10	SBPART.1029	29.50
SB1600 Sex Bolt Pkg (Set of 3)	SPBLK	SBPART.1032	29.50
SR64			
SR64 Installation Pin	-	SRPART.1001	1.40
SR64 Installation Pin (Pkg of 10)	-	SRPART.1002	16.20
VR900/VR904/VR900-LLP/VR904-LLP			
VR900 Mounting Pkg	US32D	VRPART.1001	9.50
VR900/910/910M Collar Pkg	US32D	VRPART.1002	31.90
VR910DT/VR914DT/VR810DT/VR814DT			
VR910/910M Mounting Pkg	US32D	VRPART.1003	9.50
VR910DT/VR914DT/VR810NL/VR814NL			
VR910/910M Mounting Pkg	US32D	VRPART.1003	9.50
VR910/910 Cylinder Mounting Pkg	US32D	VRPART.1004	20.70
VR900/910/910M Collar Pkg	US32D	VRPART.1002	31.90
VR910M-DT/ VR914-DT			
VR910/910M Mounting Pkg	US32D	VRPART.1003	9.50
VR910M-NL / VR914M-NL			
VR910/910M Mounting Pkg	US32D	VRPART.1003	9.50
VR900/910/910M Collar Pkg	US32D	VRPART.1002	31.90
WS11			
WS11/11X/20/33 Rubber (Pkg of 6)	-	WSPART.1001	19.00
WS11/33 Mounting Pkg	US3, US4	WSPART.1002	4.80
WS11/33 Mounting Pkg	US10	WSPART.1003	4.80
WS11/33 Mounting Pkg	US10B	WSPART.1004	4.80
WS11/33 Mounting Pkg	US26, US26D	WSPART.1005	4.80
WS11/33 Security Mounting Pkg	-	WSPART.1006	12.60
WS11X			
WS11/11X/20/33 Rubber (Pkg of 6)	-	WSPART.1001	19.00
WS11X/33X Mounting Pkg	US3, US4	WSPART.1029	8.00
WS11X/33X Mounting Pkg	US10	WSPART.1030	8.00
WS11X/33X Mounting Pkg	US10B	WSPART.1031	8.00
WS11X/33X Mounting Pkg	US26, US26D	WSPART.1032	8.00
WS11X/33X Security Mounting Pkg	-	WSPART.1033	11.10
WS20			
WS11/11X/20/33 Rubber (Pkg of 6)	-	WSPART.1001	19.00
WS20/20X Strike Pkg	US3	WSPART.1008	16.20
WS20/20X Strike Pkg	US4	WSPART.1009	16.20
WS20/20X Strike Pkg	US10	WSPART.1010	16.20
WS20/20X Strike Pkg	US10B	WSPART.1011	16.20
WS20/20X Strike Pkg	US26	WSPART.1012	16.20
WS20/20X Strike Pkg	US26D	WSPART.1013	16.20
WS20 Mounting Pkg	US3, US4	WSPART.1014	8.00
WS20 Mounting Pkg	US10	WSPART.1015	8.00

Contact Ives Customer Service for pricing on additional sizes and finishes

Bold pricing indicates item is in stock and available for **Fast Track** and **ProXpress**

IVES ARCHITECTURAL HARDWARE - Parts Price List

Description	Finish	Part No.	List Price Each
WS20 (Continued)			
WS20 Mounting Pkg	US10B	WSPART.1016	8.00
WS20 Mounting Pkg	US26, US26D	WSPART.1017	8.00
WS20 Security Mounting Pkg	-	WSPART.1018	16.20
WS20X			
WS11/11X/20/33 Rubber (Pkg of 6)	-	WSPART.1001	19.00
WS20/20X Strike Pkg	US3	WSPART.1008	16.20
WS20/20X Strike Pkg	US4	WSPART.1009	16.20
WS20/20X Strike Pkg	US10	WSPART.1010	16.20
WS20/20X Strike Pkg	US10B	WSPART.1011	16.20
WS20/20X Strike Pkg	US26	WSPART.1012	16.20
WS20/20X Strike Pkg	US26D	WSPART.1013	16.20
WS20X Mounting Pkg	US3, US4	WSPART.1019	12.60
WS20X Mounting Pkg	US10	WSPART.1020	12.60
WS20X Mounting Pkg	US10B	WSPART.1021	12.60
WS20X Mounting Pkg	US26, US26D	WSPART.1022	12.60
WS20X Security Mounting Pkg	-	WSPART.1023	19.00
WS33			
WS11/11X/20/33 Rubber (Pkg of 6)	-	WSPART.1001	19.00
WS11/33 Mounting Pkg	US3, US4	WSPART.1002	4.80
WS11/33 Mounting Pkg	US10	WSPART.1003	4.80
WS11/33 Mounting Pkg	US10B	WSPART.1004	4.80
WS11/33 Mounting Pkg	US26, US26D	WSPART.1005	4.80
WS11/33 Security Mounting Pkg	-	WSPART.1006	12.60
WS33X			
WS11/11X/20/33 Rubber (Pkg of 6)	-	WSPART.1001	19.00
WS11X/33X Mounting Pkg	US3, US4	WSPART.1029	8.00
WS11X/33X Mounting Pkg	US10	WSPART.1030	8.00
WS11X/33X Mounting Pkg	US10B	WSPART.1031	8.00
WS11X/33X Mounting Pkg	US26, US26D	WSPART.1032	8.00
WS11X/33X Security Mounting Pkg	-	WSPART.1033	11.10
WS40			
WS40 Hook Pkg	US3	WSPART.1034	17.50
WS40 Hook Pkg	US4	WSPART.1035	16.20
WS40 Hook Pkg	US10	WSPART.1036	16.20
WS40 Hook Pkg	US10B	WSPART.1037	16.20
WS40 Hook Pkg	US26	WSPART.1038	17.50
WS40 Hook Pkg	US26D	WSPART.1039	16.20
WS40 Hook Pkg	US28	WSPART.1040	14.20
WS40 Mounting Pkg	US3, US4	WSPART.1041	9.50
WS40 Mounting Pkg	US10	WSPART.1042	9.50
WS40 Mounting Pkg	US10B	WSPART.1043	9.50
WS40 Mounting Pkg	US26, US26D, US28	WSPART.1044	9.50
WS40 Security Mounting Pkg	-	WSPART.1045	19.00
WS45			
WS45 Hook Pkg	US3	WSPART.1046	84.30
WS45 Hook Pkg	US4	WSPART.1047	79.60
WS45 Hook Pkg	US10	WSPART.1048	79.60
WS45 Hook Pkg	US10B	WSPART.1049	79.60
WS45 Hook Pkg	US26	WSPART.1050	84.30
WS45 Hook Pkg	US26D	WSPART.1051	82.70
WS45 Mounting Pkg	US3, US4	WSPART.1052	9.50
WS45 Mounting Pkg	US10	WSPART.1053	9.50

Contact Ives Customer Service for pricing on additional sizes and finishes

Bold pricing indicates item is in stock and available for **Fast Track** and **ProXpress**

IVES ARCHITECTURAL HARDWARE - Parts Price List

Description	Finish	Part No.	List Price Each
WS45 (Continued)			
WS45 Mounting Pkg	US10B	WSPART.1054	9.50
WS45 Mounting Pkg	US26, US26D	WSPART.1055	9.50
WS45 Security Mounting Pkg	-	WSPART.1056	23.90
WS45X			
WS45X Hook Pkg	US3	WSPART.1057	89.10
WS45X Hook Pkg	US4	WSPART.1058	82.70
WS45X Hook Pkg	US10	WSPART.1059	82.70
WS45X Hook Pkg	US10B	WSPART.1060	82.70
WS45X Hook Pkg	US26	WSPART.1061	89.10
WS45X Hook Pkg	US26D	WSPART.1062	89.10
WS45X Mounting Pkg	US3, US4	WSPART.1063	16.20
WS45X Mounting Pkg	US10	WSPART.1064	16.20
WS45X Mounting Pkg	US10B	WSPART.1065	16.20
WS45X Mounting Pkg	US26, US26D	WSPART.1066	16.20
WS45X Security Mounting Pkg	-	WSPART.1067	23.90
WS65			
60-65/70/430	RT Rubber, order in quantities of 100 (Price per package of 100)	RT (WSPART.1075)	90.60
60-65/70/430	Black Rubber Tip, order in quantities of 100 (Price per package of 100)	WSPART.1089	90.60
WS436/WS438			
FS13/17 Security Mounting Pkg	-	FSPART.1018	3.30
WS443			
Rubber Tip, order in quantities of 100	-	09-316	2.40
WS445			
Rubber Tip, order in quantities of 100	-	09-316	2.40
WS447			
Rubber Tip, order in quantities of 100	-	09-316	2.40
WS449			
Rubber Tip, order in quantities of 100	-	09-316	2.40
S48			
S48/262/265/266 Strike Pkg	B3	09-40-605	5.70
S48/262/265/266 Strike Pkg	B10B	09-40-613	5.70
S48/262/265/266 Strike Pkg	B26D	09-40-626	5.70
54			
054/253 Mortise Strike Pkg	B3	09-22-605	9.30
054/253 Mortise Strike Pkg	B10B	09-22-613	9.30
054/253 Mortise Strike Pkg	B26D	09-22-626	9.30
060/061			
060/061	SRT Rubber, order in quantities of 100 (Price per package of 100)	SRT (WSPART.1076)	42.30
60			
60-65/70/430	RT Rubber, order in quantities of 100 (Price per package of 100)	RT (WSPART.1075)	90.60
60-65/70/430	Black Rubber Tip, order in quantities of 100 (Price per package of 100)	WSPART.1089	90.60
61			
60-65/70/430	RT Rubber, order in quantities of 100 (Price per package of 100)	RT (WSPART.1075)	90.60
60-65/70/430	Black Rubber Tip, order in quantities of 100 (Price per package of 100)	WSPART.1089	90.60
62			
60-65/70/430	RT Rubber, order in quantities of 100 (Price per package of 100)	RT (WSPART.1075)	90.60

Contact Ives Customer Service for pricing on additional sizes and finishes

Bold pricing indicates item is in stock and available for **Fast Track** and **ProXpress**

IVES ARCHITECTURAL HARDWARE - Parts Price List

Description	Finish	Part No.	List Price Each
60-65/70/430	Black Rubber Tip, order in quantities of 100 (Price per package of 100)	WSPART.1089	90.60
64			
60-65/70/430	RT Rubber, order in quantities of 100 (Price per package of 100)	RT (WSPART.1075)	90.60
60-65/70/430	Black Rubber Tip, order in quantities of 100 (Price per package of 100)	WSPART.1089	90.60
69			
69 Rubber Tip	(Price per package of 100)	09-310	84.50
70			
60-65/70/430	RT Rubber, order in quantities of 100 (Price per package of 100)	RT (WSPART.1075)	90.60
60-65/70/430	Black Rubber Tip, order in quantities of 100 (Price per package of 100)	WSPART.1089	90.60
72/73			
60-65/70/430	RT Rubber, order in quantities of 100 (Price per package of 100)	RT (WSPART.1075)	90.60
60-65/70/430	Black Rubber Tip, order in quantities of 100 (Price per package of 100)	WSPART.1089	90.60
253			
Angle Strike Pkg	B3	09-33-605	20.80
Angle Strike Pkg	B10B	09-33-613	20.80
Angle Strike Pkg	B26D	09-33-626	20.80
Mortise Strike Pkg	B3	09-22-605	9.30
Mortise Strike Pkg	B10B	09-22-613	9.30
Mortise Strike Pkg	B26D	09-22-626	9.30
262			
S48/262/265 Strike Pkg	B3	09-40-605	5.70
S48/262/265 Strike Pkg	B10B	09-40-613	5.70
S48/262/265 Strike Pkg	B26D	09-40-626	5.70
265			
S48/262/265 Strike Pkg	B3	09-40-605	5.70
S48/262/265 Strike Pkg	B10B	09-40-613	5.70
S48/262/265 Strike Pkg	B26D	09-40-626	5.70
335			
335 Strike & Mounting Pkg	B10B	09-45-613	7.00
335 Strike & Mounting Pkg	B15	09-45-619	7.00
336			
336 Strike & Mounting Pkg	B3	09-47-605	7.60
336 Strike & Mounting Pkg	B10B	09-47-613	7.60
336 Strike & Mounting Pkg	B26D	09-47-626	7.60
347			
347 Strike & Mounting Pkg	B3	09-53-605	7.00
347 Strike & Mounting Pkg	B10B	09-53-613	7.00
347 Strike & Mounting Pkg	B15	09-53-619	7.00
347 Strike & Mounting Pkg	B26	09-53-625	7.00
347 Strike & Mounting Pkg	B26D	09-53-626	7.00
349			
349 Strike & Mounting Pkg	B3	09-61-605	7.00
349 Strike & Mounting Pkg	B10B	09-61-613	7.00
349 Strike & Mounting Pkg	B26D	09-61-626	7.00
353/354 Angle Strike Pkg	B26D	09-33-626	20.80
353/354 Mortise Strike Pkg	B3	09-22-605	9.30
353/354 Mortise Strike Pkg	B10B	09-22-613	9.30
353/354 Mortise Strike Pkg	B26D	09-22-626	9.30
430			
60-65/70/430	RT Rubber, order in quantities of 100 (Price per package of 100)	RT (WSPART.1075)	90.60

Contact Ives Customer Service for pricing on additional sizes and finishes

Bold pricing indicates item is in stock and available for **Fast Track** and **ProXpress**

IVES ARCHITECTURAL HARDWARE - Parts Price List

Description	Finish	Part No.	List Price Each
60-65/70/430	Black Rubber Tip, order in quantities of 100 (Price per package of 100)	WSPART.1089	90.60
482			
482 Plate	B3	09-170-605	7.60
482 Plate	B10B	09-170-613	7.60
482 Plate	B15, B26D	09-170-626	7.60
482 SHIM 1/8 IN	B15, B26D	09-576-626	17.30
482 SHIM 3/8 IN	B15, B26D	09-577-626	27.40
620			
Sex Bolt Package (Set of 4)	B3, B-505	09-355-605	11.90
Sex Bolt Package (Set of 4)	B10B, B-613	09-355-613	14.40
Sex Bolt Package (Set of 4)	B15, B-619, B15A, B-620	09-355-626	14.40
621			
Sex Bolt Package (Set of 4)	B3	09-355-605	11.90
Sex Bolt Package (Set of 4)	B10B	09-355-613	14.40
Sex Bolt Package (Set of 4)	B15, B15A, B26, B26D, PA28	09-355-626	14.40
U696			
696-700-701 Viewer Cover	606	890312606	2.00
696-700-701 Viewer Cover	613	890312613	2.00
696-700-701 Viewer Cover	619	890312619	2.00
696-700-701 Viewer Cover	625	890312625	2.00
696-700-701 Viewer Cover	626	890312626	2.00
696-700-701 Viewer Cover	716	890312716	2.00
696-700-701 Viewer Cover	622	890312622	2.00
696-700-701 Viewer Extension	626	890314626	3.10
View Trim Washer	B4	09-241-606	0.30
View Trim Washer	B26D	09-241-626	0.30
U698			
698 Viewer Cover	605	890311605	2.60
698 Viewer Cover	619	890311619	2.60
698 Viewer Cover	625	890311625	2.60
698 Viewer Cover	626	890311626	2.60
698 Viewer Cover	716	890311716	2.60
698 Viewer Cover	622	890311622	2.60
698 Viewer Extension	626	890313626	4.20
700			
696-700-701 Viewer Cover	606	890312606	2.00
696-700-701 Viewer Cover	613	890312613	2.00
696-700-701 Viewer Cover	619	890312619	2.00
696-700-701 Viewer Cover	625	890312625	2.00
696-700-701 Viewer Cover	626	890312626	2.00
696-700-701 Viewer Cover	716	890312716	2.00
696-700-701 Viewer Cover	622	890312622	2.00
696-700-701 Viewer Extension	626	890314626	3.10
View Trim Washer	B4	09-241-606	0.30
View Trim Washer	B10B	09-241-613	0.30
View Trim Washer	B26D	09-241-626	0.30
701			
696-700-701 Viewer Cover	606	890312606	2.00
696-700-701 Viewer Cover	613	890312613	2.00
696-700-701 Viewer Cover	619	890312619	2.00
696-700-701 Viewer Cover	625	890312625	2.00
696-700-701 Viewer Cover	626	890312626	2.00
696-700-701 Viewer Cover	716	890312716	2.00
696-700-701 Viewer Cover	622	890312622	2.00
696-700-701 Viewer Extension	626	890314626	3.10
View Trim Washer	B4	09-241-606	0.30
View Trim Washer	B10B	09-241-613	0.30
View Trim Washer	B26D	09-241-626	0.30
8112			
Screw - #8 x 1" OPHSMS (Qty 6)	B26D	PULLPART.1060	3.40

Contact Ives Customer Service for pricing on additional sizes and finishes

Bold pricing indicates item is in stock and available for **Fast Track** and **ProXpress**

IVES ARCHITECTURAL HARDWARE - Parts Price List

Description	Finish	Part No.	List Price Each
8121 (1 3/4" Door)			
Screw - #8 x 1" OPHSMS (Qty 6)	B26D	PULLPART.1060	3.40
8121 Screw Pkg - K Mount	B26D	09-512-618	29.00
8200/8300/8302/8303/8305/8311/8400 Plate Mounting Screws			
Gasket	-	KPPART.10013	22.00
Screw - #6 x 5/8" UOPHSMS (Pkg 16)	B3, B4	09-282-632	0.50
Screw - #6 x 5/8" UOPHSMS (Pkg 16)	B10	09-282-639	0.50
Screw - #6 x 5/8" UOPHSMS (Pkg 16)	B10B, B-613, BRN	09-282-640	0.50
Screw - #6 x 5/8" UOPHSMS (Pkg 16)	B15, B26, B26D, S32, S32D, PA28, CLR	09-282-630	0.50
Screw - #6 x 5/8" TEK/TORX SMS (Pkg 16)	B3, B4	KPPART.10014	12.50
Screw - #6 x 5/8" TEK/TORX SMS (Pkg 16)	B10	KPPART.10015	12.50
Screw - #6 x 5/8" TEK/TORX SMS (Pkg 16)	B10B, B-613, BRN	KPPART.10016	12.50
Screw - #6 x 5/8" TEK/TORX SMS (Pkg 16)	B15, B26, B26D, S32, S32D, PA	KPPART.10017	12.50
Pull Mounting Packages for 8105, 8111, 8305, 8311, 8700, 8800 Also used with Old Mtg Style Pulls (Non-HD) 8102, 8103, 8103EZ, 8190, 8302, 8303, 9100 See Page 64 for which options can be used with each model.			
Standard Mount 1.3/4" Door	B3, B4	09-469-605	6.20
Standard Mount 1.3/4" Door	B10	09-469-612	6.20
Standard Mount 1.3/4" Door	B10B	09-469-613	6.20
Standard Mount 1.3/4" Door	B15, B26, B26D, PA28, S32, S32D	09-469-603	6.20
Standard Mount 2" Door	B3, B4	PULLPART.1001	6.20
Standard Mount 2" Door	B10	PULLPART.1002	6.20
Standard Mount 2" Door	B10B	PULLPART.1003	6.20
Standard Mount 2" Door	B15, B26, B26D, PA28, S32, S32D	PULLPART.1004	6.20
F Mount 1.3/4" Door	-	09-464-603	3.40
F Mount 2" Door	-	PULLPART.1005	3.40
F Mount 2 1/4" Door	-	PULLPART.1006	3.40
G Mount	-	09-509-603	3.40
H / I / L Mount (combined pack)	-	09-510-603	37.10
J / N Mount (combined pack) 1.3/4" Door	-	09-508-603	12.90
J / N Mount (combined pack) 2" - 2 1/4" Door	-	09-294-603	12.90
M Mount 1 3/4" - 2" Door	B3	09-521-605	24.70
M Mount 1 3/4" - 2" Door	B4	09-521-606	24.70
M Mount 1 3/4" - 2" Door	B10	09-521-612	24.70
M Mount 1 3/4" - 2" Door	B10B	09-521-613	24.70
M Mount 1 3/4" - 2" Door	B26	09-521-625	24.70
M Mount 1 3/4" - 2" Door	B26D	09-521-626	24.70
M Mount 1 3/4" - 2" Door	S32	09-521-629	24.70
M Mount 1 3/4" - 2" Door	S32D	09-521-630	24.70
M Mount 1 3/4" - 2" Door	B15	09-521-619	24.70
M Mount 2 1/4" Door	S32D	PULLPART.1007	50.40
M Mount 2 1/4" Door	B3	PULLPART.1008	50.40
M Mount 2 1/4" Door	B4	PULLPART.1009	50.40
M Mount 2 1/4" Door	B10	PULLPART.1010	50.40
M Mount 2 1/4" Door	B10B	PULLPART.1011	50.40
M Mount 2 1/4" Door	B26	PULLPART.1012	50.40
M Mount 2 1/4" Door	S32	PULLPART.1013	50.40
M Mount 2 1/4" Door	B26d	PULLPART.1014	50.40
M Mount 2 1/4" Door	B15	PULLPART.1015	50.40
O Mount 1.3/4" Door	B3	09-523-605	20.70
O Mount 1.3/4" Door	B4	09-523-606	20.70
O Mount 1.3/4" Door	B10	09-523-612	20.70
O Mount 1.3/4" Door	B10B	09-523-613	20.70
O Mount 1.3/4" Door	B26	09-523-625	20.70
O Mount 1.3/4" Door	B26D	09-523-626	20.70
O Mount 1.3/4" Door	S32	09-523-629	20.70
O Mount 1.3/4" Door	S32D	09-523-630	20.70
O Mount 1.3/4" Door	B15	09-523-619	20.70
O Mount 2" Door	S32D	PULLPART.1016	42.30
O Mount 2" Door	B3	PULLPART.1017	42.30
O Mount 2" Door	B4	PULLPART.1018	42.30
O Mount 2" Door	B10	PULLPART.1019	42.30
O Mount 2" Door	B10B	PULLPART.1020	42.30

Contact Ives Customer Service for pricing on additional sizes and finishes

Bold pricing indicates item is in stock and available for **Fast Track** and **ProXpress**

IVES ARCHITECTURAL HARDWARE - Parts Price List

Description	Finish	Part No.	List Price Each
Pull Mounting Packages for 8105, 8111, 8305, 8311, 8700, 8800 Also used with Old Mtg Style Pulls (Non-HD) 8102, 8103, 8103EZ, 8190, 8302, 8303, 9100 (Continued) See Page 64 for which options can be used with each model.			
O Mount 2" Door	B26	PULLPART.1021	42.30
O Mount 2" Door	S32	PULLPART.1022	42.30
O Mount 2" Door	B26D	PULLPART.1023	42.30
O Mount 2" Door	B15	PULLPART.1024	42.30
O Mount 2 1/4" Door	S32D	PULLPART.1025	42.30
O Mount 2 1/4" Door	B3	PULLPART.1026	42.30
O Mount 2 1/4" Door	B4	PULLPART.1027	42.30
O Mount 2 1/4" Door	B10	PULLPART.1028	42.30
O Mount 2 1/4" Door	B10B	PULLPART.1029	42.30
O Mount 2 1/4" Door	B26	PULLPART.1030	42.30
O Mount 2 1/4" Door	S32	PULLPART.1031	42.30
O Mount 2 1/4" Door	B26D	PULLPART.1032	42.30
O Mount 2 1/4" Door	B15	PULLPART.1033	42.30
* Type M and O mounting packs are sold in multiples of 1.			
Pull HD Mounting Packages for 8102HD, 8302, 8372, 8373, 8975 See Page 64 for which options can be used with each model.			
5/16HD Standard Mount 1.1/2"-1.7/8" Door	B15,B26,26D	PULLPART.1063	6.20
5/16HD Standard Mount 1.1/2"-1.7/8" Door	B3	PULLPART.1064	6.20
5/16HD Standard Mount 1.1/2"-1.7/8" Door	B10	PULLPART.1065	6.20
5/16HD Standard Mount 1.1/2"-1.7/8" Door	B10B	PULLPART.1066	6.20
5/16HD Standard Mount 2-2.1/4" Door	B15,B26,B26D	PULLPART.1071	6.20
5/16HD Standard Mount 2-2.1/4" Door	B3	PULLPART.1072	6.20
5/16HD Standard Mount 2-2.1/4" Door	B10	PULLPART.1073	6.20
5/16HD Standard Mount 2-2.1/4" Door	B10B	PULLPART.1074	6.20
5/16HD G Mount	-	PULLPART.1079	3.40
5/16HD I Mount	-	PULLPART.1081	37.10
5/16HD J Mount 1.1/2"-1.7/8" Door	-	PULLPART.1085	12.90
5/16HD J Mount 2-2.1/4" Door	-	PULLPART.1086	12.90
5/16HD L Mount	-	PULLPART.1083	37.10
Pull HD Mounting Packages for 8103HD, 8103EZHD, 8145EZHD, 8190HD, 8190EZHD, 8303, 9100HD, 9264, 9266, 8169, 8181, 8281, 8189, 8312, 8320, 8371, 8848 See Page 64 for which options can be used with each model.			
3/8HD Standard Mount 1.1/2"-1.7/8" Door	B15,B26,26D	PULLPART.1067	6.20
3/8HD Standard Mount 1.1/2"-1.7/8" Door	B3	PULLPART.1068	6.20
3/8HD Standard Mount 1.1/2"-1.7/8" Door	B10	PULLPART.1069	6.20
3/8HD Standard Mount 1.1/2"-1.7/8" Door	B10B	PULLPART.1070	6.20
3/8HD Standard Mount 2-2.1/4" Door	B15,B26,B26D	PULLPART.1075	6.20
3/8HD Standard Mount 2-2.1/4" Door	B3,B4	PULLPART.1076	6.20
3/8HD Standard Mount 2-2.1/4" Door	B10	PULLPART.1077	6.20
3/8HD Standard Mount 2-2.1/4" Door	B10B	PULLPART.1078	6.20
3/8HD A Mount	-	PULLPART.1200	37.10
3/8HD G Mount	-	PULLPART.1080	3.40
3/8HD I Mount	-	PULLPART.1082	37.10
3/8HD L Mount	-	PULLPART.1084	18.80
3/8HD N Mount 1.1/2"-1.7/8" Door	-	PULLPART.1087	12.90
3/8HD N Mount 2-2.1/4" Door	-	PULLPART.1088	12.90
3/8HD O Mount 1.1/2"-1.7/8" Door	B3	PULLPART.1089	20.70
3/8HD O Mount 1.1/2"-1.7/8" Door	US4	PULLPART.1090	20.70
3/8HD O Mount 1.1/2"-1.7/8" Door	US10	PULLPART.1091	20.70
3/8HD O Mount 1.1/2"-1.7/8" Door	US10B	PULLPART.1092	20.70
3/8HD O Mount 1.1/2"-1.7/8" Door	US15	PULLPART.1093	20.70
3/8HD O Mount 1.1/2"-1.7/8" Door	US26	PULLPART.1094	20.70
3/8HD O Mount 1.1/2"-1.7/8" Door	US26D	PULLPART.1095	20.70
3/8HD O Mount 1.1/2"-1.7/8" Door	US32	PULLPART.1096	20.70

Contact Ives Customer Service for pricing on additional sizes and finishes

Bold pricing indicates item is in stock and available for **Fast Track** and **ProXpress**

IVES ARCHITECTURAL HARDWARE - Parts Price List

Description	Finish	Part No.	List Price Each
Pull HD Mounting Packages for 8103HD, 8103EZHD, 8145EZHD, 8190HD, 8190EZHD, 8303, 9100HD, 9264, 9266, 8169, 8181, 8281, 8189, 8312, 8320, 8371, 8848 (Continued) See Page 64 for which options can be used with each model.			
3/8HD O Mount 1.1/2"-1.7/8" Door	US32D	PULLPART.1097	20.70
3/8HD O Mount 2-2.1/4" Door	US3	PULLPART.1098	42.40
3/8HD O Mount 2-2.1/4" Door	US4	PULLPART.1099	42.40
3/8HD O Mount 2-2.1/4" Door	US10	PULLPART.1100	42.40
3/8HD O Mount 2-2.1/4" Door	US10B	PULLPART.1101	42.40
3/8HD O Mount 2-2.1/4" Door	US15	PULLPART.1102	42.40
3/8HD O Mount 2-2.1/4" Door	US26	PULLPART.1103	42.40
3/8HD O Mount 2-2.1/4" Door	US26D	PULLPART.1104	42.40
3/8HD O Mount 2-2.1/4" Door	US32	PULLPART.1105	42.40
3/8HD O Mount 2-2.1/4" Door	US32D	PULLPART.1106	42.40
3/8HD P Mount	-	PULLPART.1201	45.90
3/8HD Q Mount 3/8"-5/8" Door	B3	PULLPART.1202	54.80
3/8HD Q Mount 3/8"-5/8" Door	US4	PULLPART.1203	54.80
3/8HD Q Mount 3/8"-5/8" Door	US10	PULLPART.1204	54.80
3/8HD Q Mount 3/8"-5/8" Door	US10B	PULLPART.1205	54.80
3/8HD Q Mount 3/8"-5/8" Door	US15	PULLPART.1206	54.80
3/8HD Q Mount 3/8"-5/8" Door	US26	PULLPART.1207	54.80
3/8HD Q Mount 3/8"-5/8" Door	US26D	PULLPART.1208	54.80
3/8HD Q Mount 3/8"-5/8" Door	US32	PULLPART.1209	54.80
3/8HD Q Mount 3/8"-5/8" Door	US32D	PULLPART.1210	54.80
3/8HD X Mount 1.1/2"-1.7/8" Door	B15,B26,26D	PULLPART.1211	42.40
3/8HD X Mount 1.1/2"-1.7/8" Door	B3	PULLPART.1212	42.40
3/8HD X Mount 1.1/2"-1.7/8" Door	B10	PULLPART.1213	42.40
3/8HD X Mount 1.1/2"-1.7/8" Door	B10B	PULLPART.1214	42.40
3/8HD X Mount 2-2.1/4" Door	B15,B26,B26D	PULLPART.1215	42.40
3/8HD X Mount 2-2.1/4" Door	B3,B4	PULLPART.1216	42.40
3/8HD X Mount 2-2.1/4" Door	B10	PULLPART.1217	42.40
3/8HD X Mount 2-2.1/4" Door	B10B	PULLPART.1218	42.40
Old Mtg Style Push/Pull Combos (Non-HD) Mounting Packages for 9103EZ, 9190 See Page 64 for which options can be used with each model.			
NO Mount 1.3/4" Door	B3	09-525-605	51.80
NO Mount 1.3/4" Door	B4	09-525-606	51.80
NO Mount 1.3/4" Door	B10	09-525-612	51.80
NO Mount 1.3/4" Door	B10B	09-525-613	51.80
NO Mount 1.3/4" Door	B26	09-525-625	51.80
NO Mount 1.3/4" Door	B26D	09-525-626	51.80
NO Mount 1.3/4" Door	S32	09-525-629	51.80
NO Mount 1.3/4" Door	S32D	09-525-630	51.80
NO Mount 1.3/4" Door	B15	09-525-619	51.80
NO Mount 2" Door	B3	PULLPART.1042	51.80
NO Mount 2" Door	B4	PULLPART.1043	51.80
NO Mount 2" Door	B10	PULLPART.1044	51.80
NO Mount 2" Door	B10B	PULLPART.1045	51.80
NO Mount 2" Door	B26	PULLPART.1046	51.80
NO Mount 2" Door	B26D	PULLPART.1047	51.80
NO Mount 2" Door	S32	PULLPART.1048	51.80
NO Mount 2" Door	S32D	PULLPART.1049	51.80
NO Mount 2" Door	B15	PULLPART.1050	51.80
NO Mount 2 1/4" Door	B3	PULLPART.1051	51.80
NO Mount 2 1/4" Door	B4	PULLPART.1052	51.80
NO Mount 2 1/4" Door	B10	PULLPART.1053	51.80
NO Mount 2 1/4" Door	B10B	PULLPART.1054	51.80

Contact Ives Customer Service for pricing on additional sizes and finishes

Bold pricing indicates item is in stock and available for **Fast Track** and **ProXpress**

IVES ARCHITECTURAL HARDWARE - Parts Price List

Description	Finish	Part No.	List Price Each
Old Mtg Style Push/Pull Combos (Non-HD) Mounting Packages for 9103EZ, 9190 (Continued)			
See Page 64 for which options can be used with each model.			
NO Mount 2 1/4" Door	B26	PULLPART.1055	51.80
NO Mount 2 1/4" Door	B26D	PULLPART.1056	51.80
NO Mount 2 1/4" Door	S32	PULLPART.1057	51.80
NO Mount 2 1/4" Door	S32D	PULLPART.1058	51.80
NO Mount 2 1/4" Door	B15	PULLPART.1059	51.80
NS Mount 1.3/4" Door	B3,B4	09-524-605	29.90
NS Mount 1.3/4" Door	B15, B26, B26D, PA28, S32, S32D	09-524-630	29.90
NS Mount 1.3/4" Door	B10	09-524-612	29.90
NS Mount 1.3/4" Door	B10B	09-524-613	29.90
NS Mount 2" Door	B3,B4	PULLPART.1034	29.90
NS Mount 2" Door	B15, B26, B26D, PA28, S32, S32D	PULLPART.1035	29.90
NS Mount 2" Door	B10	PULLPART.1036	29.90
NS Mount 2" Door	B10B	PULLPART.1037	29.90
NS Mount 2" Door	B3,B4	PULLPART.1038	29.90
NS Mount 2" Door	B15, B26, B26D, PA28, S32, S32D	PULLPART.1039	29.90
NS Mount 2" Door	B10	PULLPART.1040	29.90
NS Mount 2" Door	B10B	PULLPART.1041	29.90
Push/Pull Combo HD Mounting Packages for 9103EZHD, 9145EZHD, 9190HD, 9190EZHD			
See Page 64 for which options can be used with each model.			
3/8HD NO Mount 1.1/2"-1.7/8" Door	US3	PULLPART.1115	51.80
3/8HD NO Mount 1.1/2"-1.7/8" Door	US4	PULLPART.1116	51.80
3/8HD NO Mount 1.1/2"-1.7/8" Door	US10	PULLPART.1117	51.80
3/8HD NO Mount 1.1/2"-1.7/8" Door	US10B	PULLPART.1118	51.80
3/8HD NO Mount 1.1/2"-1.7/8" Door	US15	PULLPART.1119	51.80
3/8HD NO Mount 1.1/2"-1.7/8" Door	US26	PULLPART.1120	51.80
3/8HD NO Mount 1.1/2"-1.7/8" Door	US26D	PULLPART.1121	51.80
3/8HD NO Mount 1.1/2"-1.7/8" Door	US32	PULLPART.1122	51.80
3/8HD NO Mount 1.1/2"-1.7/8" Door	US32D	PULLPART.1123	51.80
3/8HD NO Mount 2-2.1/4" Door	US3	PULLPART.1124	51.80
3/8HD NO Mount 2-2.1/4" Door	US4	PULLPART.1125	51.80
3/8HD NO Mount 2-2.1/4" Door	US10	PULLPART.1126	51.80
3/8HD NO Mount 2-2.1/4" Door	US10B	PULLPART.1127	51.80
3/8HD NO Mount 2-2.1/4" Door	US15	PULLPART.1128	51.80
3/8HD NO Mount 2-2.1/4" Door	US26	PULLPART.1129	51.80
3/8HD NO Mount 2-2.1/4" Door	US26D	PULLPART.1130	51.80
3/8HD NO Mount 2-2.1/4" Door	US32	PULLPART.1131	51.80
3/8HD NO Mount 2-2.1/4" Door	US32D	PULLPART.1132	51.80
3/8HD NS Mount 1.1/2"-1.7/8" Door	B15,B26,B26D	PULLPART.1107	29.90
3/8HD NS Mount 1.1/2"-1.7/8" Door	B3,B4	PULLPART.1108	29.90
3/8HD NS Mount 1.1/2"-1.7/8" Door	B10	PULLPART.1109	29.90
3/8HD NS Mount 1.1/2"-1.7/8" Door	B10B	PULLPART.1110	29.90
3/8HD NS Mount 2-2.1/4" Door	B15,B26,B26D	PULLPART.1111	29.90
3/8HD NS Mount 2-2.1/4" Door	B3,B4	PULLPART.1112	29.90
3/8HD NS Mount 2-2.1/4" Door	B10	PULLPART.1113	29.90
3/8HD NS Mount 2-2.1/4" Door	B10B	PULLPART.1114	29.90
3/8HD PQ Mount 3/8"-5/8" Door	US3	PULLPART.1219	95.30
3/8HD PQ Mount 3/8"-5/8" Door	US4	PULLPART.1220	95.30
3/8HD PQ Mount 3/8"-5/8" Door	US10	PULLPART.1221	95.30
3/8HD PQ Mount 3/8"-5/8" Door	US10B	PULLPART.1222	95.30
3/8HD PQ Mount 3/8"-5/8" Door	US15	PULLPART.1223	95.30
3/8HD PQ Mount 3/8"-5/8" Door	US26	PULLPART.1224	95.30
3/8HD PQ Mount 3/8"-5/8" Door	US26D	PULLPART.1225	95.30

Contact Ives Customer Service for pricing on additional sizes and finishes

Bold pricing indicates item is in stock and available for **Fast Track** and **ProXpress**

Notes

Description	Finish	Part No.	List Price Each
Push/Pull Combo HD Mounting Packages for 9103EZHD, 9145EZHD, 9190HD, 9190EZHD (Continued)			
See Page 64 for which options can be used with each model.			
3/8HD PQ Mount 3/8"-5/8" Door	US32	PULLPART.1226	95.30
3/8HD PQ Mount 3/8"-5/8" Door	US32D	PULLPART.1227	95.30

Contact Ives Customer Service for pricing on additional sizes and finishes

Bold pricing indicates item is in stock and available for **Fast Track** and **ProXpress**

WARRANTY

Ives (the “Company”) warrants only to Customer that the products will be free from defects in material and workmanship for a period of 12 months from the date of shipment of products. Continuous hinges carry a Lifetime Warranty with exception of electrified continuous hinged which carry a 12 month Warranty from time of shipment. The Customer shall be obligated to promptly report any failure to conform to this warranty in writing to the Company within the warranty period provided above. Company’s sole obligation under this warranty is limited to repairing or replacing, at its option, the defective products.

NO OTHER WARRANTIES, EXPRESS OR IMPLIED, ARE MADE WITH RESPECT TO THE PRODUCTS INCLUDING, BUT NOT LIMITED TO, ANY IMPLIED WARRANTY OF MERCHANTABILITY OR FITNESS FOR A PARTICULAR PURPOSE.

The provisions of this limited warranty do not apply to products: (i) used for the purposes for which they are not designed or intended; (ii) which have been repaired or altered without Company’s prior written consent; (iii) which have been subjected to misuse, abuse, negligence, or accident; (iv) which have been improperly stored, installed, maintained, or operated; (v) which have been used in violation of written instructions provided by Company to Customer; (vi) which have been subjected to improper temperature, humidity, or other environmental conditions; (vii) which have been affected by normal wear and tear; or (viii) which, based on Company’s examination, do not disclose to Company’s satisfaction nonconformance to the warranty.

The following costs and expenses are not covered by the provisions of this limited warranty: (i) labor costs for the removal and reinstallation of products; (ii) shipping and freight expenses required to return products to Company; (iii) normal maintenance; and (iv) economic losses. In addition, the provisions of this warranty are not applicable to anything other than defects in Company’s material (products only) or workmanship.

CONSUMER PRODUCTS. With respect to “consumer products” as defined under the Magnuson-Moss Warranty Act (“MMWA”), the following statements are made. (a) Some states do not allow limitations on how long an implied warranty lasts, so the above limitation may not apply to you. **IF ANY IMPLIED WARRANTY IS PROVIDED UNDER THE MMWA, IT IS LIMITED TO THE DURATION OF THE WARRANTY PROVIDED ABOVE.** (b) Some states do not allow the exclusion or limitation of incidental or consequential damages, so the above limitation or exclusion may not apply to you. (c) This warranty gives you specific legal rights and you may also have other rights which vary from state to state.

About Allegion

Allegion (NYSE: ALLE) creates peace of mind by pioneering safety and security. As a \$2 billion provider of security solutions for homes and businesses, Allegion employs more than 8,000 people and sells products in more than 120 countries across the world. Allegion comprises more than 25 global brands, including strategic brands CISA®, Interflex®, LCN®, Schlage® and Von Duprin®.

For more, visit www.allegion.com

KRYPTONITE ■ LCN ■  ■ STEELCRAFT ■ VON DUPRIN