



DOOR HARDWARE

PRICE BOOK #13

Effective 4/1/2018

webmaster@hagerco.com
orders@hagerco.com

139 Victor Street
Saint Louis, MO 63104

800-325-9995 (main phone)
314-772-4400 (local phone)
800-782-0149 (main fax)
314-772-0744 (local fax)

Part # 5-500-2018



One Family. One Brand. One Vision.™
www.hagerco.com

CONTACT INFORMATION

Corporate Office

139 Victor Street
St. Louis, Missouri 63104
800-325-9995 (Sales and Service)
800-255-3590 (Main Office)
314-772-4400 (Local Main Office)
800-782-0149 (Fax)
314-772-0744 (Local Fax)
webmaster@hagerco.com
orders@hagerco.com
www.hagerco.com

Montgomery Plant

150 Folmar Parkway
Montgomery, AL 36105
334-284-4700 (Main Phone)

Montgomery Distribution Center

200 County Court
Montgomery, AL 36105
334-288-0432 (Main Phone)

SoCal Office

12440 Firestone Boulevard, Suite 310
Norwalk, CA 90650
855-557-0010 (Main Phone)

Canada Office

P.O. Box 124
Kitchener, Ontario N2G 3W9
800-255-3590 (Main Phone)
800-552-1926 (Main Fax)

A CLEANER, GREENER PRICE BOOK

- Our Printer** uses sophisticated ink-mixing technology that reduces VOCs and reduces ink waste to less than one percent. They consistently recycle, reuse, and reduce both paper and ink consumption.
- Our Inks** are soy-based, reducing harmful VOCs and preventing harmful chemicals from entering the wastewater system.
- Our Company** is concerned about how our company and products affect the environment. As a result, we've taken steps to minimize our impact—and we're continually reviewing ways to do more. Throughout the production of this Price Book, we made every effort to recycle and use both sides of the paper.



General Information

TERMS AND CONDITIONS

General

Prices indicated will be in effect from the date on the cover and are subject to change without notice. If, under any law now or hereafter passed, the seller is required to pay a tax on sales or an excise tax, the amount of these taxes will be added to the invoice value. We shall not be responsible for any loss or damage resulting from delay in filling orders caused by fire, flood, strikes, differences with workmen, government regulations, accidents, transportation delays, shortages of materials, or other causes beyond our control. Should raw material prices rise substantially, it may become necessary to add a surcharge by material type at the time of shipment. Orders are processed in order of receipt, but lead times will vary in relation to production specifications. Errors or omissions in published prices are subject to correction.

Payments

Accounts are net 30 days, or 1% for cash if paid within 15 days following the date of invoice. Cash discounts do not apply to credit card payments. Accounts unpaid at expiration of 60 days from the date of invoice will be subject to a late payment charge of 1-1/2% per month of the total balance. Also, accounts unpaid after 60 days will be subject to C.O.D. shipments. Accounts unpaid after 90 days will be placed for collection. All collection charges, attorney fees, and court costs will be added to the amount due. An NSF (insufficient fund) check fee in the amount of \$30.00 will be added to the account.

Minimum Order Charges

Orders with a net value of less than \$50.00 will be invoiced at \$50.00.

Minimum Annual Purchase Requirement

A minimum annual amount of \$15,000.00 is required to maintain open account status with Hager Companies.

Packaging

- A charge of \$100.00 net will be made when requested to itemize and special package in accordance with such schedules.
- A charge of \$50.00 net will be made when requested to make changes on itemized jobs after the orders have been processed.
- A charge of \$15.60 net for crating certain products will be added to invoices at time of shipment.

Quick Ship

The items throughout this price book that have prices in **bold and red** are items included in the Hager Quick Ship Program and typically ship within 24 hours. When ordering these products, please visit www.hagerco.com and click on 'Quick Ship' in the footer. You will be prompted to log in with your My Hager account name and password and then you may begin ordering.

Shipments and Freight Charges

All shipments are F.O.B. Point of Origin. Freight prepaid on shipments having a value of \$2,000.00 net or more, route of our selection. Less than \$2,000.00 net shipped prepay and add. Shipments by Express, Air Freight, or United Parcel Service are F.O.B. Point of Origin, without any freight allowance. Any request for shipments not falling under these guidelines may be subject to a handling charge. Hager will not provide consignee or third party freight billing.

There will be a \$25.00 net charge for furnishing proof of delivery receipt. This charge will be canceled if delivery was not made. Proof of delivery may be obtained by visiting www.hagerco.com and establishing an account with "My Hager." Due to size limitations by certain carriers, some orders may require LTL shipment.

Please note that for next day air shipments, written consent with an authorized signature must be sent via fax or e-mail to Hager Companies before an order will be released for overnight delivery. Next day air requests must be received prior to 1:00 p.m. CDT.



Cancellations and Make-to-Order Items

Orders for non-stock goods, accepted by Hager, are non-cancelable except with prior written consent, and then subject to a service charge based on the manufacturing expenses incurred. Under no circumstances will non-stock, make-to-order or discontinued product be accepted for return unless it is due to a Hager error.

Return Goods Policy

No credit will be issued for returned goods unless such return is authorized by our St. Louis office. There will be a minimum 35% handling and restocking charge invoked in connection with the return. Freight terms will be specified on return goods authorization forms. Return goods must be in saleable condition or no credit will be issued and goods will be destroyed. No goods will be accepted for return after 6 months. No return goods authorization will be issued for less than \$25.00.

Warranty Returns

A credit in the amount of the original purchase order will be issued after the returned product is inspected and the defect is found to be valid.

Inspection and Delivery

Customer will inspect all product deliveries immediately upon receipt. Hager will assume acceptance of delivered product if not notified within 5 days of receipt of product. If damage is visible upon receipt, note that on the Bill of Lading and notify Hager immediately.

Claims

All claims should be submitted to Hager as follows:

- All claims for pricing adjustments must be submitted within 30 days of invoice date
- All claims for order quantity discrepancies must be submitted within 5 days
- All claims for damaged material prior to acceptance by customer must be submitted within 5 days

Limited Warranty

Subject to the limitations of liability set forth below, Hager Companies (the "Company") warrants to purchasers that the products which the Company sells under the "Hager" trademark or trade name are free from defects in workmanship and materials under normal use and regular service and maintenance from date of delivery.

This is the sole and exclusive warranty given by the company with respect to the products and is in lieu of any and all other warranties, express or implied, arising by operation of law or otherwise. All implied warranties, including but not limited to the warranties of merchantability, non-infringement and fitness for a particular purpose, are hereby excluded.

This warranty does not cover defects or damage arising from improper installation, incorrect application, lack of or improper maintenance, improper storage, shipping and handling, excessive wear and tear, misuse, abuse, accident, unauthorized service, or use with unauthorized products or parts.

The sole and exclusive liability of the Company under this warranty or otherwise, shall be limited to the repair or replacement of any product or component part which shall prove defective to the original purchaser from the Company. The Company will not pay for the costs or repair performed other than in accordance with this warranty. The company shall not be liable for damages caused by delay in performance and in no event, regardless of the form of the claim or cause of action (whether based on contract, infringement, negligence, strict liability, other tort or otherwise), shall the company's liability to purchaser and/or its customers exceed the price paid by purchaser for the specific products giving rise to the claim or cause of action. Purchaser agrees that in no event shall the company's liability to purchaser and/or its customers extend to include incidental, consequential or punitive damages resulting from use of these products, or arising out of any breach of this warranty. The term "consequential damages" shall include, but not limited to, loss of anticipated profits, business interruption, loss of use or revenue, cost of capital or loss or damage to property or equipment. The foregoing limitations and exclusions are intended to be effective



General Information

to the maximum extent permitted by law. This warranty is governed by the law of the State of Missouri without regard to its conflicts of law principles. The company and purchaser agree that the United Nations Convention on Contracts for the International Sale of Goods and the United Nations Convention on the Limitation Period in the International Sale of Goods shall not apply to sales of the products covered by this warranty.

Written notice of a product believed to be defective as covered by this warranty should be sent to Hager Companies, 139 Victor Street, St. Louis, Missouri 63104 within 30 days from the discovery of the alleged defects, and should include the purchaser's name and address, identification of the product, and brief description of the defect. Upon receipt of such notice, the Company will inform the purchaser where to ship such product, shipping charges prepaid, for examination. In the event such examination reveals a defect covered by this warranty, the Company will, at its own option, repair or replace the product, and return it or the replacement to the purchaser, with charge only for transportation.

Hager Advantage Program

Please note that the terms of your Hager Advantage Program override any terms found in this price book. If you are not active in our Hager Advantage Program and would like to take advantage of the many benefits, please contact your Hager Sales Representative today.

CODES AND ILLUSTRATIONS

Units of Measure

EACH	Item in a box either with or without screws.
PACK	Items poly bagged (1 or more) per bag.
PAIR	Items (1 or more) pair per box.
SET	Items (1 or more) sets per box.

Illustrations

Pictures shown in this Price Book are for general product information only and are not meant to be used as templates. Contact Hager Companies Sales and Service for final product identification for installation, or go to www.hagerco.com to download templates or installation instructions.

Packaging

The following codes have been established to provide clarification of packaging methods. The basic code letter(s) are shown in parenthesis in the unit column of each page. The letter designation refers to the standard Hager Pack.

Hager Companies reserves the right to change the packaging methods when deemed necessary and to increase or decrease quantities to make full case quantities on a specific item.

B = Boxed
PB = Poly Bag
BLK = Bulk Pack
SET = Set



DISCOUNTS

Customer Number

Architectural Hinges

Residential Hinges

Roton Continuous Geared Hinges

Stainless Steel Continuous Hinges

Trim & Auxiliary

Thresholds & Weatherstripping

Sliding Door Hardware

Locks

Door Closers

Exit Devices

Electrified Products

Notes





One Family. One Brand. One Vision.™

www.hagerco.com

TABLE OF CONTENTS

A		E	
Armor Fronts (Mortise)	52-53	Electric Options	
		Cylindrical Locks	24
		Mortise Locks	47
B		Electric Standalone Locks	
Backset Extension Links		34K1	28-29
2500.....	8	34K2.....	28-29
3400.....	24		
3500.....	30	F	
Blocking Rings.....	65	Faceplate Adapter	6
C		I	
Cams (Fixed Cylinder).....	59-60	Interchangeable Cores (Small Format)	60
Cams (LFIC)	65	Interchangeable Cores (Large Format).....	63
Cams (SFIC).....	62-63	Interconnected Locks	
Cash Box Nut.....	66	3700, Grade 2	39-41
Cores		K	
Small Format Interchangeable.....	60	Key Blanks (Fixed Cylinder).....	56-57
Large Format Interchangeable	63	Key Blanks (SFIC).....	61
Cylinders		Key Blanks (LFIC).....	63
Key-In-Lever	57	Keying Charges (Fixed Cylinder)	56
Mortise (Fixed Cylinder)	59	Keying Charges (SFIC).....	61
Mortise (SFIC).....	62	Keying Charges (LFIC).....	63
Mortise Dummy.....	59	Keying, Tools and Accessories.....	67-68
Mortise ADA Turn Knob.....	59	Keys, Cut (Fixed Cylinder)	56-57
Rim (Fixed Cylinder)	58	Keys, Cut (SFIC).....	61
Rim (SFIC).....	62	Keys, Cut (LFIC).....	63-64
Rim Dummy.....	58	L	
Cylinder Aligning Sleeves.....	10, 26, 29, 35, 38	Latchbolts	
Cylinder Collars.....	51, 66-67	2300, Tubular	6
Cylindrical Locks		2500, Grade 2 Cylindrical.....	8-11
2500, Grade 2.....	8-11	3400, Grade 1 Cylindrical.....	22-27
3400, Grade 1.....	22-27	34K1/K2, Grade 1 Standalone.....	28
3500, Grade 2.....	30-35	3500, Grade 2 Cylindrical.....	30-31
		3600, Grade 2 Tubular	36
D		3700, Grade 2 Interconnected.....	39
Deadbolts		Lead Lining	8, 22, 30, 43, 45, 48
3100, Grade 1.....	12	Lead Times	3
3200, Grade 2.....	16		
3700, Interconnected.....	39		
Deadlocks			
3100, Grade 1.....	12-15		
3200, Grade 2.....	16-20		
Dustbox (Mortise).....	52		
Dustbox (Deadbolt)	13,17		
Decorative Locks			
2300.....	5-7		



Locks

M

Mortise Cam Screws	65-66
Mortise Cylinder	59, 62, 64

Mortise Locks

Mortise Locks (Deadlocks).....	48
Mortise Locks (Small Case Deadlocks)	49
Mortise Locks (Sectional).....	43-44
Mortise Locks (Escutcheon).....	45-46
Mortise Locks (Sliding Door).....	50
Mortise Lock Accessories.....	51-55

P

Power Supplies

Cylindrical Lock.....	24
Mortise Lock.....	47

R

Rim Cylinder.....	58 62, 64
-------------------	-----------

S

Software

34K1.....	28
34K2.....	28

Screw Packs

2300, Tubular	7
2500, Grade 1 Deadlock.....	10
3100, Grade 2 Cylindrical.....	14
3200, Grade 2 Deadlock	18
3400, Grade 1 Cylindrical.....	27
34K1/K2, Grade 1 Standalone.....	29
3500, Grade 2 Cylindrical.....	35
3600, Grade 2 Tubular	38
3700, Grade 2 Interconnected.....	41
3800, Grade 1 Mortise.....	53
Stock Numbers	72-86

Strikes

2300, Tubular	6
2500, Grade 1 Deadlock.....	10
3100, Grade 1 Deadlock.....	13
3200, Grade 2 Deadlock.....	17
3300, Grade 3 Tubular.....	21
3400, Grade 1 Cylindrical.....	26
34K1/K2, Grade 1 Standalone	29
3500, Grade 2 Cylindrical.....	34
3600, Grade 2 Tubular	38
3700, Grade 2 Interconnected.....	41
3800, Grade 1 Mortise.....	50-52

T

Tactile Warning	8, 22, 28, 30, 43, 45
Tailpieces (Fixed Cylinder)	57-58
Tailpieces (SFIC).....	61-62
Tailpieces (Rim Cylinder).....	59, 64
Thumbturns (Mortise Lock).....	53
Thru-bolt Jigs.....	11, 29, 35

Tubular Locks

2300	5-7
3300, Grade 3.....	21
3600, Grade 2.....	36-38

INTRODUCTION

Hager Companies offers a variety of locks to meet a wide range of applications and solutions. Heavy Duty Grade 1 deadlocks, cylindrical locks, and mortise locks are ideal for schools, hospitals, and other high-use environments. Grade 2 deadlocks and cylindrical locks are ideal for less abusive environments, while Grade 2 tubular locks are suitable for heavy duty residential or medium duty commercial environments.

All Hager locks have been rigorously tested and certified to the highest standards. Most lock series are BHMA certified per the ANSI A156.2 standards. They are also UL/cUL Listed for all functions up to and including 3 hours for “A” labeled doors. In addition to the certifications, all Hager leversets are ADA compliant and most come with a lifetime warranty.

Most Hager locksets are either non-handed or field reversible in the case of the 3800 Series mortise lock. Conventional cylinder and small format interchangeable core are available on keyed functions. Most lock series offer three lever style options along with one knob style. Please check appropriate section for series specific options.

QUICK SHIP

Products denoted with **red and bold** in the stock number listing in the back of the pricing section are available to order through the QuickShip program and ship within 24 hours. When ordering these products please visit www.hagerco.com and log in to MyHager to access the ‘Quick Ship’ portal. Due to the promptness of the fulfillment process, Quick Ship orders are non-cancellable.

LEAD TIMES

Stock items will typically ship in five working days or less from the order entry date. Made-to-order items will typically ship in 15 working days depending on seasonal volume and order complexity. Special orders including industrials, special machining, and large quantities may need to be scheduled. The anticipated ship date will be included with each order acknowledgement. Please contact Customer Service if product availability is in question.

Keyed lock orders will typically ship in 10-15 working days from the order entry date. All appropriate information and paperwork must be supplied for Hager to schedule and acknowledge master keyed lead times.

CANCELLATION NOTIFICATION

Cancellation for made-to-order items must be communicated within 48 hours of order placement.



3453 2³/₄" US26D US26 WTN SCC KD ASA TW

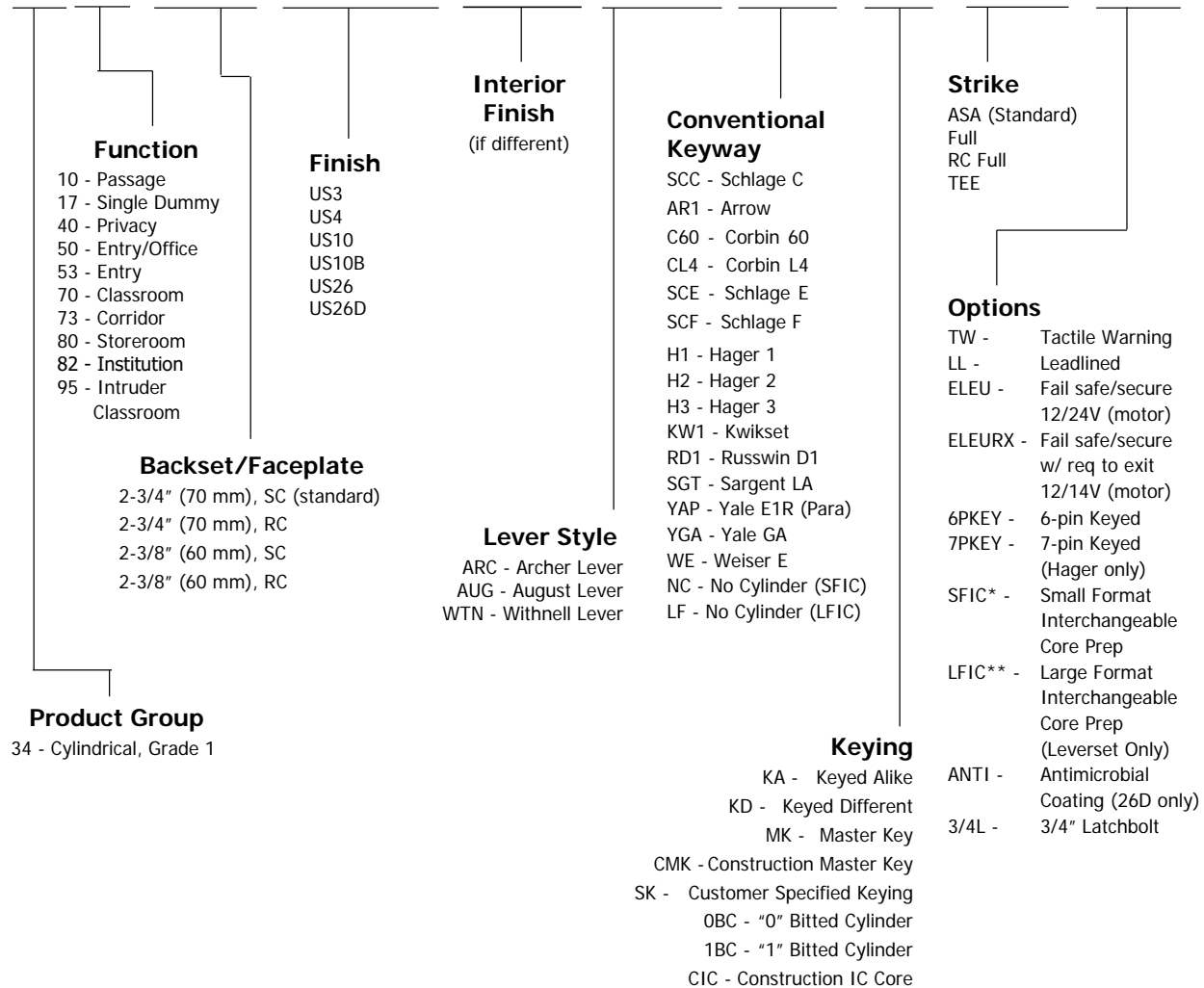

Notes:

- If master-keyed, include master key instruction sheet with order (available online).
- For additional keying information, please refer to cylinder, core, and keying section of catalog.
- Quick Connect option available on 3400 series electrified models (EL, EU, RX). **Ordering example: 3480 2-3/4" US26D WTN SCC KD ASA ELEUQC.**
- Interchangeable construction core will be included with the lockset if "CIC" is specified in keying section. Customer must specify BLUE or RED color for SFIC.

* Small format interchangeable core sold separately. Available in Best Keyways or Hager Keyways, A Standard. **Ordering example: 3453 2-3/4" US26D WTN NC ASA SFIC.**

Please refer to our Catalog or website (www.hagerco.com) for more detailed and series specific ordering information along with additional information including functions available, additional options, and keying information. Ordering forms such as Master Keying Instruction Sheet and Cylinder Instructions and Ordering Guide are also available on our website (www.hagerco.com).

Description

2300 Series

Decorative Tubular Locks
 2-3/8" (60 mm) backset (optional)
 2-3/4" (70 mm) backset (standard)
 2-1/4" x 1" (57 mm x 25 mm) SC and RC Faceplate (standard)

Round and square corner full lip strikes (standard)

Optional strikes available. For ASA strike, add \$7.00 adder to list price of the lock.

Refer to catalog or website for more detailed information on functions.

Finishes other than US10B, US15, and US26D, are subject to extended lead-times. Consult customer service for availability.

When ordering handed lever designs, LH=LHR and RH=RHR

Split finish available at extended lead time. Handing information required when ordering split finish.



Charles 



Johnston 



Joshua 



Louis 



Warren 

Function	Finish	2018 List	Case Qty.
2310 Passage	US3	105.70	24
	US10B	105.70	
	US15	101.60	
	US26	105.70	
	US26D	101.60	
2317 Single Dummy (Specify handing on Johnston and Warren Levers)	US3	47.50	24
	US10B	47.50	
	US15	45.70	
	US26	47.50	
	US26D	45.70	

Function	Finish	2018 List	Case Qty.
2327 Double Dummy	US3	95.00	24
	US10B	95.00	
	US15	91.35	
	US26	95.00	
	US26D	91.35	
2340 Privacy	US3	112.50	24
	US10B	112.50	
	US15	108.15	
	US26	112.50	
	US26D	108.15	



Locks - 2300 Series



Latchbolts		Finish	2018 List	Box Qty.
Description				
2-639-7607 Passage Spring Latch - (2300) 2-3/4" (70 mm) backset		n/a	17.45	10
2-639-7609 Passage Spring Latch - (2300) 2-3/8" (60 mm) backset		n/a	17.45	10
2-639-7608 Privacy Latch - (2300) 2-3/4" (70 mm) backset		n/a	17.45	10
2-639-7610 Privacy Latch - (2300) 2-3/8" (60 mm) backset		n/a	17.45	10
Strikes		Finish	2018 List	Box Qty.
Description				
3933 T-Strike with Plastic Dust Box 1-1/8" x 2-3/4" (29 mm x 70 mm), square corner		US3	8.10	10
		US10B	8.10	
		US15	8.10	
		US26	8.10	
		US26D	8.10	
2-639-7617 Full lip replacement strikes (2300) (Includes square and round corner)		US3	12.10	10
2-639-7619 Full lip replacement strikes (2300) (Includes square and round corner)		US10B	12.10	10
2-639-7620 Full lip replacement strikes (2300) (Includes square and round corner)		US15	12.10	10
2-639-7621 Full lip replacement strikes (2300) (Includes square and round corner)		US26	12.10	10
2-639-7622 Full lip replacement strikes (2300) (Includes square and round corner)		US26D	12.10	10
3935 ASA Strike 1-1/4" x 4-7/8" (32 mm x 124 mm), square corner		US3	12.25	10
		US10B	12.25	
		US15	12.25	
		US26	12.25	
		US26D	12.25	
3959 Faceplate Adapter Converts 1" (25 mm) to 1/8" (29 mm) width		NF	2.65	10





Components and Screwpacks		Finish	2018 List	Box Qty.
Description				
2-639-7601	Privacy Accessory Kit	US3	8.50	10
2-639-7603	Privacy Accessory Kit	US10B	8.50	10
2-639-7604	Privacy Accessory Kit	US15	8.50	10
2-639-7605	Privacy Accessory Kit	US26	8.50	10
2-639-7606	Privacy Accessory Kit	US26D	8.50	10
2-300-0091	Replacement Screw Packs	US3	10.50	10
2-300-0092	Replacement Screw Packs	US10B	10.50	10
2-300-0093	Replacement Screw Packs	US15/26/26D	10.50	10



Locks - 2500 Series



Archer  



Withnell  

Description

2500 Series

Grade 2 Cylindrical - Economy
 Fixed Cylinder, Standard
 6 Pin Cylinders, 5-pin Keyed
 Schlage C Keyway - KD Standard
 2-3/4" (70 mm) Backset
 2-1/4" x 1-1/8" (57 mm x 29 mm) SC Faceplate
 ASA Strike

Small Format Interchangeable Core option Available (cores sold separately - refer to Keying/Core section).

If construction SFIC core is included with the lockset, \$51.20 will be added to the list price of the lock. Refer to keying/cores section for construction core options.

Lead Lined available. Add \$137.00 to the list price of the lock.

Tactile Warning available (levers only). Add \$42 to the list price of the lock.

Optional backsets, faceplates and strikes available.

Optional keying/keyways available.

Refer to catalog or website for more detailed information on functions.

Function	Finish	2018 List	Case Qty.
2510 (F75) Passage	US3	97.10	6
	US10B	97.10	
	US26D	97.10	
2517 Single Dummy	US3	58.30	12
	US10B	58.30	
	US26D	58.30	
2525 (F111) Exit	US3	87.45	6
	US10B	87.45	
	US26D	87.45	
2527 BTB Dummy	US3	114.35	6
	US10B	114.35	
	US26D	114.35	

Function	Finish	2018 List	Case Qty.
2540 (F76A) Privacy	US3	99.20	6
	US10B	99.20	
	US26D	99.20	
2550 (F82A) Office	US3	110.65	6
	US10B	110.65	
2553 (F109) Entry	US26D	110.65	
2570 (F84) Classroom	US3	110.65	
	US10B	110.65	
2580 (F86) Storeroom	US26D	110.65	





Latchbolts	Finish	2018 List	Box Qty.
Description			
3947 Spring Latch - Passage Only (2510) 2-3/4" (70 mm) Backset 2-1/4" x 1-1/8" (57 mm x 29 mm) Faceplate Must specify square or round corner.	US3 US10B US26D	28.00 28.00 28.00	10
3949 Spring Latch - Passage Only (2510) 2-3/8" (60 mm) Backset 2-1/4" x 1" (57 mm x 25 mm) Faceplate Must specify square or round corner.	US3 US10B US26D	28.00 28.00 28.00	10
3965 Spring Latch - Privacy Only (2540) 2-3/4" (70 mm) Backset 2-1/4" x 1-1/8" (57 mm x 29 mm) Faceplate Must specify square or round corner.	US3 US10B US26D	28.00 28.00 28.00	10
3967 Spring Latch - Privacy Only (2540) 2-3/8" (60 mm) Backset 2-1/4" x 1" (57 mm x 25 mm) Faceplate Must specify square or round corner.	US3 US10B US26D	28.00 28.00 28.00	10
3948 Dead Latch - 2525 and all keyed functions (2500 Series) 2-3/4" (70 mm) Backset 2-1/4" x 1-1/8" (57 mm x 29 mm) Faceplate Must specify square or round corner.	US3 US10B US26D	28.00 28.00 28.00	10
3950 Dead Latch - 2525 and all keyed functions (2500 Series) 2-3/8" (60 mm) Backset 2-1/4" x 1" (57 mm x 25 mm) Faceplate Must specify square or round corner.	US3 US10B US26D	28.00 28.00 28.00	10
3959 Faceplate Adapter Can be used with 2500 2-3/8" (60 mm) backset latchbolt. Converts 1" (25 mm) to 1-1/8" (29 mm) width.	NF	2.65	10
3917 3-3/4" (95 mm) Backset Extension Link Must be used with 2-3/8" (60 mm) backset latchbolt to achieve 3-3/4" total backset.	NF	18.50	
3937 5" (127) Backset Extension Link Must be used with 2-3/4" (70 mm) backset latchbolt to achieve 5" total backset.	NF	20.00	
Drive-In Latchbolts	Finish	2018 List	Box Qty.
Description			
3922 2-3/4" (70 mm) Drive-In Spring Latch - Passage only (2510)	NF	28.00	20
3923 2-3/4" (70 mm) Drive-In Spring Latch - Privacy only (2540)	NF	28.00	20
3925 2-3/8" (60 mm) Drive-In Spring Latch - Passage only (2510)	NF	28.00	20



Locks - 2500 Series

Drive-In Latchbolts			
Description	Finish	2018 List	Box Qty.
3926 2-3/8" (60 mm) Drive-In Spring Latch - Privacy only (2540)	NF	28.00	20
3924 2-3/4" (70 mm) Drive-In Dead Latch - All keyed functions (2500 Series)	NF	28.00	20
3927 2-3/8" (60 mm) Drive-In Dead Latch - All keyed functions (2500 Series)	NF	28.00	20
Strikes			
Description	Finish	2018 List	Box Qty.
3933 T-Strike with Plastic Dust Box 1-1/8" x 2-3/4" (29 mm x 70 mm), square corner	US3 US10B US26D	8.10 8.10 8.10	10
3934 Full Lip Strike 1-5/8" x 2-1/4" (41 mm x 57 mm), square corner	US3 US10B US26D	8.10 8.10 8.10	10
3935 ASA Strike Plate Shipped standard with 2500 Series 1-1/4" x 4-7/8" (32 mm x 124 mm), square corner 1-5/16" lip Order dust box separately	US3 US10B US26D	12.25 12.25 12.25	10
3958 Round Corner Full Lip Strike 1-5/8" x 2-1/4" (41 mm x 57 mm), round corner (1/4" radius)	US3 US10B US26D	8.10 8.10 8.10	10
Components and Screwpacks			
Description	Finish	2018 List	
2-639-3577 Cylinder Aligning Sleeve (10 pack)	NF	3.05	
2-300-0048 Screwpack - 2500 Series Lever Locksets	US3	12.15	
2-300-0050 Screwpack - 2500 Series Lever Locksets	US10B	12.15	
2-300-0052 Screwpack - 2500 Series Lever Locksets	US26D	12.15	
2-300-0058 Screwpack - 2517/2527 Lever Locksets only	NF	12.15	
2-639-3523 2500 Series Thru Bolt Posts	NF	4.00	

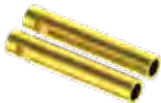



Components and Screwpacks			
Description	Finish	2018 List	
2-669-0389 ASA Metal Dust Box	NF	5.70	
3911 2500 Series Leverset Thru-Post Drill Jig	NF	18.75	ea



Locks - 3100 Series



Description

3100 Series

Grade 1
 Fixed Cylinder Standard
 6 Pin Cylinders, 5-pin Keyed
 Schlage C Keyway - KD Standard
 2-3/4" (70 mm) Backset
 2-1/4" x 1-1/8" (57 mm x 29 mm) Square Corner Faceplate
 Square Corner Strike

If construction SFIC core is included with the lockset, \$51.20 will be added to list price of the lock. Refer to keying/cores section for construction core options.

Small Format Interchangeable Core option available (cores sold separately - refer to Keying/Core section).

Optional backsets, faceplates, and strikes available (see below).

ASA Strike Available. Add \$7.00 to list price of deadlock.

Optional keying/keyways available.

Refer to catalog or website for more detailed information on functions.

Function	Finish	2018 List	Case Qty.
3114 (E2141) Double Cylinder	US3	186.10	12
	US4	186.10	
	US10	186.10	
	US10B	186.10	
	US26	186.10	
	US26D	178.95	
3115 (E2151) Cylinder x Thumbturn	US3	164.10	12
	US4	164.10	
	US10	164.10	
	US10B	164.10	
	US26	164.10	
	US26D	157.80	

Function	Finish	2018 List	Case Qty.
3118 (E2171) Classroom	US3	169.80	12
	US4	169.80	
	US10	169.80	
	US10B	169.80	
	US26	169.80	
	US26D	163.25	



Deadbolts		Finish	2018 List	Box Qty.
Description				
3940	2-3/4" (70 mm) Backset - Standard	US3	28.00	10
	2-1/4" x 1-1/8" (57 mm x 29 mm) Faceplate	US4	29.80	
	Must Specify Square or Round Corner	US10	29.80	
		US10B	28.00	
		US26D	28.00	
3941	2-3/8" (60 mm) Backset	US3	28.00	10
	2-1/4" x 1" (57 mm x 25 mm) Faceplate	US4	29.80	
	Must specify square or round corner	US10	29.80	
		US10B	28.00	
		US26D	28.00	
Strikes		Finish	2018 List	Box Qty.
Description				
3929	ASA Deadlock Strike	US3	19.70	10
	1-1/4" x 4-7/8" (32 mm x 124 mm), Square Corner	US4	20.95	
	1 5/16" lip	US10	20.95	
	Order dust box separately.	US10B	19.70	
		US26	19.70	
		US26D	19.70	
3930	Strike with plastic dust box	US3	8.00	10
	1-1/8" x 2-3/4" (29 mm x 70 mm), Square corner	US4	8.45	
		US10	8.45	
		US10B	8.00	
		US26D	8.00	
2-639-3109	Deadlock Dust Box	NF	3.85	10
Components and Screwpacks		Finish	2018 List	
Description				
2-639-3151	Collar Handing Keys - 3118 - (RH and LH w/ set screw)	NF	6.40	
2-639-7146	Thumbturn Repair Kit - 3100 Series	US3	11.60	
2-639-7147	Thumbturn Repair Kit - 3100 Series	US4	11.60	
2-639-7148	Thumbturn Repair Kit - 3100 Series	US10	11.60	
2-639-7149	Thumbturn Repair Kit - 3100 Series	US10B	11.60	
2-639-7150	Thumbturn Repair Kit - 3100 Series	US26	11.60	
2-639-3168	Thumbturn Repair Kit - 3100 Series	US26D	11.60	



Locks - 3100 Series

Components and Screwpacks		Finish	2018 List
	2-639-3152 Thumbturn Rose - 3100 Series	US3	9.30
	2-639-3153 Thumbturn Rose - 3100 Series	US4	9.30
	2-639-3154 Thumbturn Rose - 3100 Series	US10	9.30
	2-639-3155 Thumbturn Rose - 3100 Series	US10B	9.30
	2-639-3156 Thumbturn Rose - 3100 Series	US26	9.30
	2-639-3157 Thumbturn Rose - 3100 Series	US26D	9.30
	2-300-0000 Screwpack 3115/3118	US3/US10	11.15
2-300-0001 Screwpack 3115/3118	US4	11.15	
2-300-0003 Screwpack 3115/3118	US10B	11.15	
2-300-0004 Screwpack 3115/3118	US26	11.15	
2-300-0005 Screwpack 3115/3118	US26D	11.15	
2-300-0006 Screwpack 3114	US3/US10	11.15	
2-300-0007 Screwpack 3114	US4	11.15	
2-300-0009 Screwpack 3114	US10B	11.15	
2-300-0010 Screwpack 3114	US26	11.15	
2-300-0011 Screwpack 3114	US26D	11.15	
2-639-3167 Tailpiece Kit for 2" - 2-1/4" Thick Door (3114/3118 Fixed Cylinder Only)		8.60	
2-639-3236 Tailpiece Kit for 2" - 2-1/4" Thick Door (3114 Fixed Cylinder Only)	US3/US4/ US10	8.60	
2-639-3238 Tailpiece Kit for 2" - 2-1/4" Thick Door (3114 Fixed Cylinder Only)	US10B	8.60	
2-639-3239 Tailpiece Kit for 2" - 2-1/4" Thick Door (3114 Fixed Cylinder Only)	US26/US26D	8.60	





Components and Screwpacks		
Description	Finish	2018 List
2-639-7164 SFIC Deadlock Cylinder Assembly - 3115/3118	US3	20.00
2-639-7167 SFIC Deadlock Cylinder Assembly - 3115/3118	US4	20.00
2-639-7160 SFIC Deadlock Cylinder Assembly - 3115/3118	US10	20.00
2-639-7161 SFIC Deadlock Cylinder Assembly - 3115/3118	US10B	20.00
2-639-7163 SFIC Deadlock Cylinder Assembly - 3115/3118	US26D	20.00



Locks - 3200 Series



Description

3200 Series

Grade 2
 Fixed Cylinder, Standard
 6 Pin Cylinders, 5-pin Keyed
 Schlage C Keyway - KD Standard
 2-3/4" (70 mm) Backset
 2-1/4" x 1-1/8" SC Faceplate
 (57 mm x 29 mm)
 Square Corner Strike

Small Format Interchangeable Core option available (cores sold separately - refer to Keying/Core section).

If construction SFIC core is included with the lockset, \$51.20 will be added to list price of the lock. Refer to keying/cores section for construction core options.

Refer to Catalog or website for more detailed information on functions.

Optional backsets, faceplates, and strikes available (see next page).

ASA Strike Available. Add \$7.00 to list price of deadlock.

Optional keying/keyways available.

Function	Finish	2018 List	Case Qty.
3214 (E2142) Double Cylinder	US3	108.60	12
	US4	108.60	
	US10	108.60	
	US10B	108.60	
	US26D	103.45	
	US32D	94.90	
3215 (E2152) Cylinder x Thumbturn	US3	88.45	12
	US4	88.45	
	US10	88.45	
	US10B	88.45	
	US26D	84.25	
3216 Thumbturn x Occupancy Indicator	US3	70.35	20
	US4	70.35	
	US10	70.35	
	US10B	70.35	
	US26D	67.00	
	US32D	61.45	

Function	Finish	2018 List	Case Qty.
3220 (E21112) Thumbturn only w/ Blank Plate	US3	65.75	20
	US4	65.75	
	US10	65.75	
	US10B	65.75	
	US26D	62.60	
	US32D	57.45	
3221 (E2192) Thumbturn only (Replaced 3219)	US3	54.05	20
	US4	54.05	
	US10	54.05	
	US10B	54.05	
	US26D	51.50	
	US32D	47.25	
3222 Retrofit Kit for use w/ 3220 or 3221	US3	35.15	20
	US4	35.15	
	US10	35.15	
	US10B	35.15	
	US26D	33.50	
	US32D	30.75	





Deadbolts Description	Finish	2018 List	Box Qty.
3940	US3	28.00	10
2-3/4" (70 mm) Backset - Standard	US4	29.80	
2-1/4" x 1-1/8" (57 mm x 29 mm) Faceplate	US10	29.80	
Must Specify Square or Round Corner	US10B	28.00	
US32D available in square corner only	US26D	28.00	
	US32D	28.00	



3941	US3	28.00	10
2-3/8" (60 mm) Backset	US4	29.80	
2-1/4"x 1" (57 mm x 25 mm) Faceplate	US10	29.80	
Must specify square or round corner	US10B	28.00	
US32D available in square corner only	US26D	28.00	
	US32D	28.00	



3942	US3	28.00	10
2-3/8" - 2-3/4" (60 mm - 70 mm) Adjustable	US4	29.80	
2-1/4" x 1-1/8" (57 mm x 29 mm) Square Corner Faceplate	US10	29.80	
For use with 3220, 3221 deadlocks only	US10B	28.00	
Round corner optional	US26D	28.00	
1" Wide faceplate available in square corner or round corner	US32D	28.00	
US32D available in square corner only			



3959	NF	2.65	10
Faceplate Adapter			
Can be used with 3220 and 3221 deadlock			
Converts 1" (25 mm) to 1-1/8" (29 mm) width			



Strikes Description	Finish	2018 List	Box Qty.
3929	US3	19.70	10
ASA Deadlock Strike	US4	20.95	
1-1/4" x 4-7/8" (32 mm x 124 mm), Square Corner	US10	20.95	
1-5/16" lip	US10B	19.70	
Optional Strike can be used with 3100/3200 Series.	US26	19.70	
Order dust box separately.	US26D/US32D	19.70	
For use with 3200 Series US32D, order US26/US26D.			



3930	US3	8.00	10
Strike with plastic dust box	US4	8.45	
1-1/8" x 2-3/4" (29 mm x 70 mm), Square corner	US10	8.45	
	US10B	8.00	
	US26D	8.00	
	US32D	8.00	

2-639-3109	NF	3.85	10
Deadlock Dust Box			
For use with standard strike, 3930.			







Locks - 3200 Series



Components and Screwpacks		Finish	2018 List
Description			
2-300-0018 Screwpack for 3214		US3/US10	11.15
2-300-0019 Screwpack for 3214		US4	11.15
2-300-0021 Screwpack for 3214		US10B	11.15
2-300-0023 Screwpack for 3214		US26D/US32D	11.15
2-300-0024 Screwpack for 3215		US3/US10	11.15
2-300-0025 Screwpack for 3215		US4	11.15
2-300-0027 Screwpack for 3215		US10B	11.15
2-300-0029 Screwpack for 3215		US26D/US32D	11.15
2-300-0105 Screwpack 3216/3220/3222		US3/US10	11.15
2-300-0106 Screwpack 3216/3220/3222		US4	11.15
2-300-0108 Screwpack 3216/3220/3222		US10B	11.15
2-300-0110 Screwpack 3216/3220/3222		US26D/US32D	11.15
2-300-0111 Screwpack 3221		US3/US10	11.15
2-300-0112 Screwpack 3221		US4	11.15
2-300-0114 Screwpack 3221		US10B	11.15
2-300-0116 Screwpack 3221		US26D/US32D	11.15
2-639-3218 Thumbturn Assembly - 3215		US3/US10	11.40
2-639-3219 Thumbturn Assembly - 3215		US4	11.40
2-639-3221 Thumbturn Assembly - 3215		US10B	11.40
2-639-7153 Thumbturn Assembly - 3215		US26D	11.40
2-639-3223 Thumbturn Assembly - 3215		US32D	11.40



Components and Screwpacks		Finish	2018 List
Description			
	2-639-3230 Tailpiece Kit for 2" - 2-1/4" Door (3215 Fixed Cylinder Only)	US3/US10	8.60
	2-639-3231 Tailpiece Kit for 2" - 2-1/4" Door (3215 Fixed Cylinder Only)	US4	8.60
	2-639-3233 Tailpiece Kit for 2" - 2-1/4" Door (3215 Fixed Cylinder Only)	US10B	8.60
	2-639-3235 Tailpiece Kit for 2" - 2-1/4" Door (3215 Fixed Cylinder Only)	US26D	8.60
	2-639-7151 Tailpiece Kit for 2" - 2-1/4" Door (3215 Fixed Cylinder Only)	US32D	8.60
	2-639-3236 Tailpiece Kit for 2" - 2-1/4" Door (3214 Fixed Cylinder Only)	US3/US4/ US10	8.60
	2-639-3238 Tailpiece Kit for 2" - 2-1/4" Door (3214 Fixed Cylinder Only)	US10B	8.60
	2-639-3239 Tailpiece Kit for 2" - 2-1/4" Door (3214 Fixed Cylinder Only)	US26D	8.60
	2-639-3703 Exterior Deadlock Scalp - 3200 Series	US3	8.50
	2-639-3704 Exterior Deadlock Scalp - 3200 Series	US4	8.50
	2-639-3705 Exterior Deadlock Scalp - 3200 Series	US10	8.50
	2-639-3706 Exterior Deadlock Scalp - 3200 Series	US10B	8.50
	2-639-7152 Exterior Deadlock Scalp - 3200 Series	US26D	8.50
	2-639-3708 Exterior Deadlock Scalp - 3200 Series	US32D	8.50
	2-639-7157 3215 SFIC Deadlock Spacer	US3	6.85
	2-639-7158 3215 SFIC Deadlock Spacer	US4	6.85
	2-639-7154 3215 SFIC Deadlock Spacer	US10	6.85
	2-639-7155 3215 SFIC Deadlock Spacer	US10B	6.85
	2-639-7156 3215 SFIC Deadlock Spacer	US26D	6.85
	2-639-7144 3215 SFIC Deadlock Spacer	US32D	6.85



Locks - 3200 Series



Components and Screwpacks

Description	Finish	2018 List
2-639-7164 SFIC Deadlock Cylinder Assembly - 3215	US3	20.00
2-639-7167 SFIC Deadlock Cylinder Assembly - 3215	US4	20.00
2-639-7160 SFIC Deadlock Cylinder Assembly - 3215	US10	20.00
2-639-7161 SFIC Deadlock Cylinder Assembly - 3215	US10B	20.00
2-639-7163 SFIC Deadlock Cylinder Assembly - 3215	US26D	20.00
2-639-7166 SFIC Deadlock Cylinder Assembly - 3215	US32D	20.00
2-639-7641 3216 Emergency Key (10Pk)	NF	8.70





Archer



August



Johnston



Withnell

Description

3300 Series

Grade 3 Tubular - Residential
 Fixed Cylinder, Standard
 5 Pin Keyed Different Cylinder only - no keying services available
 Schlage C Keyway only
 2-3/8" - 2-3/4" (60mm - 70mm) adjustable backset
 2-1/4" - 1" (57mm x 25mm) RC Faceplate (Square corner faceplate loose in the box)

1-3/4" x 2-1/4" Full lip round corner strike, no box (standard)

Optional strikes must be purchased separately.

Refer to catalog or website for more detailed information on functions.

Finishes other than US10B, US15 and US26D will be subject to extended lead times. Consult customer service for availability.

When ordering handed lever designs, LH=LHR and RH=RHR.

Function	Finish	2018 List	Case Qty.
3310	US3	\$46.50	18
Passage	US10B	\$54.00	18
	US15	\$46.50	18
	US26	\$49.00	18
	US26D	\$49.00	18
3317	US3	\$22.25	27
Single Dummy (Specify Handing for Johnston lever)	US10B	\$26.00	27
	US15	\$22.25	27
	US26	\$24.00	27
	US26D	\$24.00	27

Function	Finish	2018 List	Case Qty.
3340	US3	\$49.00	18
Privacy	US10B	\$56.50	18
	US15	\$49.00	18
	US26	\$51.50	18
	US26D	\$51.50	18
3353	US3	\$57.50	18
Entry	US10B	\$65.00	18
	US15	\$57.50	18
	US26	\$60.00	18
	US26D	\$60.00	18

Strikes

Description	Finish	2018 List
2-639-7790 Full Lip Strike 1-3/4" x 2-1/4" (45mm x 57mm), square corner	US3	\$2.10
2-639-7792 Full Lip Strike	US10B	\$2.10
2-639-7793 Full Lip Strike	US15/US26/US26D	\$2.10
2-639-7795 T-Strike 1-1/8" x 2-3/4" (29mm x 70mm), square corner	US3	\$2.10
2-639-7797 T-Strike	US10B	\$2.10
2-639-7798 T-Strike	US15/US26/US26D	\$2.10



Locks - 3400 Series

Description

3400 Series

Grade 1 Cylindrical
 Fixed Cylinder, Standard
 6 Pin Cylinders, 5-pin Keyed
 Schlage C Keyway - KD Standard
 2-3/4" (70 mm) Backset
 2-1/4" x 1-1/8" SC Faceplate (57 mm x 29 mm)
 ASA Strike

Small and Large Format Interchangeable Core option available (cores sold separately - refer to Keying/Core section).

If construction core is included with the lockset, \$51.20 (SFIC) or \$64.75 (LFIC) will be added to the list price of the lock. Refer to keying/cores section for construction core options.

Extended Lip ASA strike available. Add \$12.00 to list price of the lock.

Lead Lined available. Add \$137.00 to the list price of the lock.

Tactile Warning available on levers only. Add \$42.00 to the list price of lock.

Anti-microbial available on 26D finish only. Add \$40.00 to the list price of the lock.

3/4" latchbolt available. Add \$103.00 to the list price of lock.

Split finish available. Priced at higher finish.

Optional backsets, faceplates, and strikes available (see next page).

Security Torx screws available. Add \$14.00 to list price of the lock.

Optional keying/keyways available.

3495 Intruder Classroom includes locking indicator rose.

Refer to catalog or website for more detailed information on functions.



Archer



August



Withnell



Function	Finish	Lever 2018 List	Case Qty.
3410 (F75) Passage	US3	283.30	6
	US4	283.30	
	US10	283.30	
	US10B	283.30	
	US26	283.30	
	US26D	272.40	
3417 Single Dummy	US3	133.25	12
	US4	133.25	
	US10	133.25	
	US10B	133.25	
	US26	133.25	
	US26D	128.10	
3440 (F76A) Privacy	US3	326.25	6
	US4	326.25	
	US10	326.25	
	US10B	326.25	
	US26	326.25	
	US26D	313.70	



Description

3400 Series (Continued)
Continued

	Function	Finish	Lever 2018 List	Case Qty.
3450 (F82A) Office		US3	379.95	6
		US4	379.95	
3453 (F109) Entry		US10	379.95	
		US10B	379.95	
3470 (F84) Classroom		US26	379.95	
		US26D	365.35	
3473 (F90) Corridor*/Dormitory				
3480 (F86) Storeroom				
3482 (F87) Institution		US3	493.75	6
		US4	493.75	
		US10	493.75	
		US10B	493.75	
		US26	493.75	
		US26D	419.95	
3495 (F110) Intruder Classroom*		US3	463.00	6
		US4	463.00	
		US10	463.00	
		US10B	463.00	
		US26	463.00	
		US26D	445.20	



Locks - 3400 Series



3400 Series Electrified Cylindrical Lockset Description	Add electrified charges to the list price of the lock Function	2018 List
Outside lever continuously locked (EL) or unlocked (EU) by 12 or 24V. Latchbolt retracted by key outside or lever inside. Auxiliary latch deadlocks latchbolt when door is closed. Inside always free for immediate egress.	3480 ELEU 12V/24V Storeroom - Fail Safe/Fail Secure	210.00
Monitors inside lever rotation. Incorporates into fire alarm systems or in conjunction with an electromagnet.	RX Request to Exit	179.00

QUICK CONNECT OPTION: Locks will come with molex connector attached. Quick connect option allows rapid installation of locks when used with the Hager Quick Connect harness cable. See Commercial Hinges section (page 7) for available harness sizes.

QUICK CONNECT ORDERING EXAMPLE: 3480 US26D WTN ELEUQC

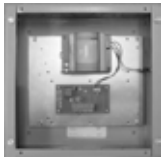

Power Supplies Description	Add electrified charges to the list price of the lock Function	2018 List
Provides power for Fail Safe or Fail Secure locking devices and interface with building alarm controls, card readers, keypads, and other door controls.	2903 24 Volt Power Supply	Reference Electrified products section
Provides power and control for openings with an electrified locking device and automatic door operator.	2904 24 Volt Power Supply	Reference Electrified products section
Provides up to 1 amp of 12 or 24 Volt DC Power for all Hager Electrified Products.	2908 24 Volt Power Supply	Reference Electrified products section
Provides up to 2 amps of 12 or 24 Volt DC Power for all Hager Electrified Products.	2909 24 Volt Power Supply	Reference Electrified products section



Latchbolts Description	Finish	2018 List	Box Qty.
3943 Spring Latch - Passage Only (3410) - Standard 2-3/4" (70 mm) Backset 2-1/4" x 1-1/8" (57 mm x 29 mm) Faceplate *Must specify square or round corner.	US3	29.40	10
	US4	31.30	
	US10	31.30	
	US10B	29.40	
	US26	29.40	
	US26D	29.40	
3945 Spring Latch - Passage Only (3410) 2-3/8" (60 mm) Backset 2-1/4" x 1-1/8" (57 mm x 29 mm) Faceplate *Must specify square or round corner.	US3	29.40	10
	US4	31.30	
	US10	31.30	
	US10B	29.40	
	US26	29.40	
	US26D	29.40	
3964 Spring Latch - Privacy Only (3440) 2-3/4" (70 mm) Backset 2-1/4" x 1-1/8" (57 mm x 29 mm) Faceplate *Must specify square or round corner.	US3	29.40	10
	US4	31.30	
	US10	31.30	
	US10B	29.40	
	US26	29.40	
	US26D	29.40	





Latchbolts Description	Finish	2018 List	Box Qty.
3966 Spring Latch - Privacy Only (3440) 2-3/8" (60 mm) Backset 2-1/4" x 1-1/8" (57 mm x 29 mm) Faceplate *Must specify square or round corner.	US3	29.40	10
	US4	31.30	
	US10	31.30	
	US10B	29.40	
	US26	29.40	
	US26D	29.40	
3944 Dead Latch - All keyed functions except Corridor 2-3/4" (70 mm) Backset 2-1/4" x 1-1/8" (57 mm x 29 mm) Faceplate *Must specify square or round corner.	US3	29.40	10
	US4	31.30	
	US10	31.30	
	US10B	29.40	
	US26	29.40	
	US26D	29.40	
3946 Dead Latch - All keyed functions except Corridor 2-3/8" (60 mm) Backset 2-1/4" x 1-1/8" (57 mm x 29 mm) Faceplate *Must specify square or round corner.	US3	29.40	10
	US4	31.30	
	US10	31.30	
	US10B	29.40	
	US26	29.40	
	US26D	29.40	
3992 Dead Latch - Corridor (3473) 2-3/8" (60 mm) Backset 2-1/4" x 1-1/8" (57 mm x 29 mm) Faceplate *Must specify square or round corner.	US3	29.40	10
	US4	31.30	
	US10	31.30	
	US10B	29.40	
	US26	29.40	
	US26D	29.40	
3993 Dead Latch - Corridor (3473) 2-3/4" (70 mm) Backset 2-1/4" x 1-1/8" (57 mm x 29 mm) Faceplate *Must specify square or round corner.	US3	29.40	10
	US4	31.30	
	US10	31.30	
	US10B	29.40	
	US26	29.40	
	US26D	29.40	
3932 3/4" Dead Latch (3450, 3453, 3470, 3480, 3495) 2-3/4" (70 mm) Backset 2-1/4" x 1-1/8" (57 mm x 29 mm) square corner faceplate	US3	102.90	10
	US4	102.90	
	US10	102.90	
	US10B	102.90	
	US26	102.90	
	US26D	102.90	
3916 3-3/4" (95 mm) Backset Extension Link Must be used with 2-3/8" backset latchbolt to achieve 3-3/4" total backset.	NF	18.50	10
3936 5" (127 mm) Backset Extension Link Must be used with 2-3/4" backset latchbolt to achieve 5" total backset.	NF	20.00	10



Locks - 3400 Series



Strikes		Finish	2018 List	Box Qty.
Description				
3933 T-Strike with Plastic Dust Box 1-1/8" x 2-3/4" (29 x 70 mm), square corner		US3	8.10	10
		US4	8.50	
		US10	8.50	
		US10B	8.10	
		US26	8.10	
		US26D	8.10	
3934 Full Lip Strike 1-5/8" x 2-1/4" (41 mm x 57 mm), square corner		US3	8.10	10
		US4	8.50	
		US10	8.50	
		US10B	8.10	
		US26	8.10	
		US26D	8.10	
3935 ASA Strike Shipped standard with 3400 Series 1-1/4" x 4-7/8" (32 mm x 124 mm), square corner 1-5/16" lip Order dust box separately		US3	12.25	10
		US4	13.00	
		US5	12.25	
		US10	12.25	
		US15	12.25	
		US10B	12.25	
		US26	12.25	
		US26D	12.25	
		US32D	12.25	
3958 Round Corner Full Lip Strike 1-5/8" x 2-1/4" (41 mm x 57 mm), round corner (1/4" radius)		US3	8.10	10
		US4	8.50	
		US10	8.50	
		US10B	8.10	
		US26	8.10	
		US26D	8.10	
2-669-0389 ASA Metal Dust Box		NF	5.70	10
Components and Screwpacks		Finish	2018 List	
Description				
2-639-3490 Cylinder Aligning Sleeve (10 pack)		NF	2.80	





Components and Screwpacks		Finish	2018 List
Description			
2-300-0036 Screwpack - 3400 Series Lever Lockset		US3/US4/ US10	12.15
2-300-0039 Screwpack - 3400 Series Lever Lockset		US10B	12.15
2-300-0041 Screwpack - 3400 Series Lever Lockset		US26/US26D	12.15
2-300-0043 Screwpack - 3400 Series Lever Lockset		US3	12.15
2-300-0042 Screwpack - 3417 Dummy Lever Only		NF	5.15
2-300-0045 Screwpack - 3417 Dummy Knob Only		NF	5.15
3911 3400 Series Leverset Thru-Post Drill Jig		NF	18.75 ea



Locks - 34K Series

Description

34K Series

Grade 1 Cylindrical Standalone
 Fixed Cylinder, Standard
 6 Pin Cylinders, 5-pin keyed Standard
 Schlage C Keyway – KD Standard
 2-3/4" (70mm) Backset
 2-1/4" x 1-1/8" SC Faceplate (57mm x 29mm)
 ASA Strike Standard

Small Format Interchangeable Core option available (Core sold separately – refer to Keying/Core section).

If construction SFIC core is included with the lockset, \$51.20 will

be added to list price of the lock. Refer to keying/cores section for construction core options.

Extended Lip ASA strike available. Add \$12.00 to list price of the lock.

Tactile Warning available. Add \$42.00 to the list price of lock.

3/4" latchbolt available. Add \$103.00 to the list price of lock.

Optional faceplates and strikes available

Optional keying/keyways available.



Function	Finish	2018 List	Case Qty.
34K1	US10B	1082.00	2
Keypad - Entry/ Storeroom	US26D	1043.00	

Function	Finish	2018 List	Case Qty.
34K2	US10B	1550.00	2
Keypad + Prox - Entry/ Storeroom	US26D	1494.00	

34K SERIES LOCKS HOW TO ORDER

34K1 2-3/4" US26D WTN SCC KD ASA 6P KEY

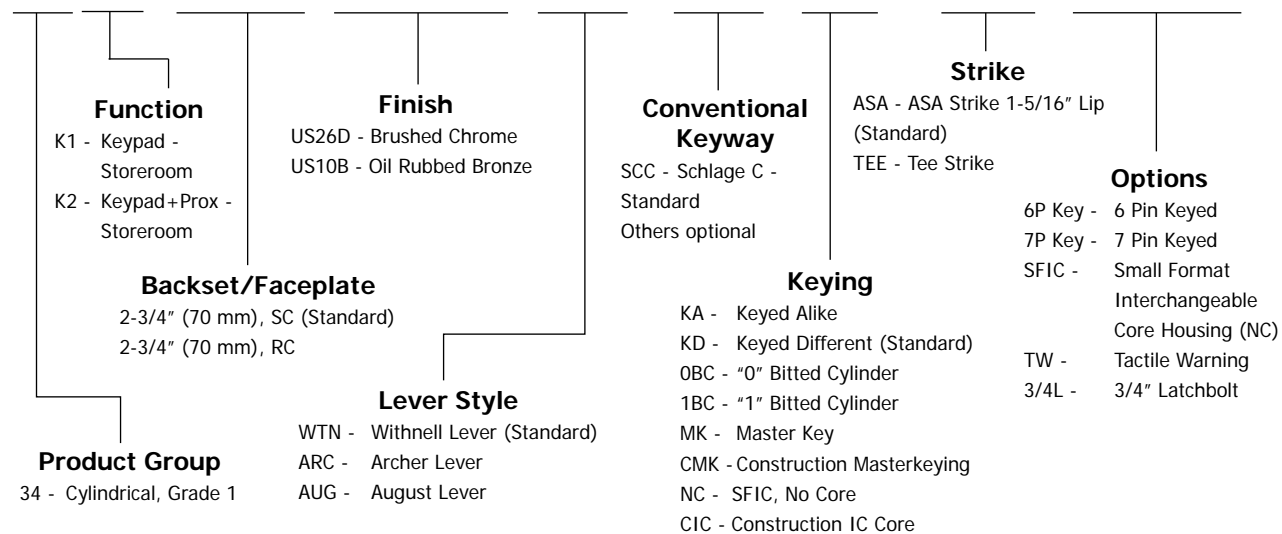

Audit Trail Accessories			
Description	Finish	2018 List	
2-639-6000 34K1 Software Kit – Includes Disc, USB Cable and Programming manual	n/a	130.00	
2-639-6001 34K2 Software Kit – Includes Disc, Prox card reader/enroller, USB Cable and Programming manual	n/a	460.00	
Latchbolts			
Description	Finish	2018 List	Box Qty.
3944 Dead Latch 2-3/4" (70 mm) Backset 2-1/4" x 1-1/8" (57 mm x 29 mm) Faceplate *Must specify square or round corner.	US10B US26D	29.40 29.40	10
3932 3/4" Dead Latch 2-3/4" (70 mm) Backset 2-1/4" x 1-1/8" (57 mm x 29 mm) square corner faceplate	US10B US26D	102.90 102.90	10
Strikes			
Description	Finish	2018 List	Box Qty.
3933 T-Strike with Plastic Dust Box 1-1/8" x 2-3/4" (29 mm x 70 mm), square corner	US10B US26D	8.10 8.10	10
3935 ASA Strike Plate Shipped standard 1-1/4" x 4-7/8" (32 mm x 124 mm), square corner 1-5/16" lip Order dust box separately:	US10B US26D	12.25 12.25	10
2-669-0389 ASA Metal Dust Box	NF	5.70	10
Components and Screwpacks			
Description	Finish	2018 List	
2-300-0300 Screwpack - 34K Series Lockset	US10B	13.25	
2-300-0301 Screwpack - 34K Series Lockset	US26D	13.25	
2-300-0302 Screwpack - 34K Battery Cover (10 pack)	NF	10.50	
2-639-3490 Cylinder Aligning Sleeve (10 pack)	NF	2.80	
2-639-7714 Thru-bolt Posts (2 pack)	NF	4.00	



Locks - 3500 Series

Description

3500 Series

Grade 2 Cylindrical
 Fixed Cylinder, Standard
 6 Pin Cylinders, 5-pin Keyed
 Schlage C Keyway - KD Standard
 2-3/4" (70 mm) Backset
 2-1/4" x 1-1/8" (57 mm x 29 mm) SC Faceplate
 ASA Strike

Small Format Interchangeable Core option available (cores sold separately - refer to Keying/Core section).

If construction SFIC core is included with the lockset, \$51.20 will be added to list price of the lock. Refer to keying/cores section for construction core options.

Extended Lip ASA strike available. Add \$10.00 to list price of the lock.

Lead Lined available. Add \$137.00 to the list price of the lock.

Tactile Warning available (Levers only). Add \$42.00 to the list price of the lock.

Anti-microbial available on 26D finish only. Add \$40.00 to list price of lock.

3/4" latchbolt available. Add \$103.00 to the list price of the lock.

Split finish available. Priced at higher finish.

Optional backsets, faceplates and strikes available (see next page).

Security Torx screws available. Add \$12.00 to list price of the lock.

Optional keying/keyways available.

Apollo knob with SFIC will be subject to extended lead times, consult factory for availability.

*3525 Exit, 3527 BTB Dummy, and 3573 Corridor functions are not available on Apollo knob.

Refer to catalog or website for more detailed information on functions.



Apollo



Archer



August



Withnell



Function	Finish	Lever 2018 List	Case Qty.	Knob 2018 List	Case Qty.
3510 (F75) Passage	US3	171.15	6	57.65	20
	US4	171.15			
	US10	171.15			
	US10B	171.15			
	US26	171.15			
	US26D	159.25			
	US32D			57.65	20
3517 Single Dummy	US3	67.75	12	33.00	60
	US4	67.75			
	US10	67.75			
	US10B	67.75			
	US26	67.75			
	US26D	63.00			
	US32D			33.00	60
3525 (F111) Exit*	US3	171.15	6		
	US4	171.15			
	US10	171.15			
	US10B	171.15			
	US26	171.15			
	US26D	159.25			
3527 BTB Dummy*	US3	135.45	6		
	US4	135.45			
	US10	135.45			
	US10B	135.45			
	US26	135.45			
	US26D	126.00			

Description

3500 Series (Continued)

Continued

	Function	Finish	Lever 2018 List	Case Qty.	Knob 2018 List	Case Qty.
3540 (F76A) Privacy		US3	194.40	6	60.80	20
		US4	194.40			
		US10	194.40			
		US10B	194.40			
		US26	194.40			
		US26D	180.85			
		US32D			60.80	20
3550 (F82A) Office		US3	215.70	6	87.85	20
		US4	215.70			
3553 (F109) Entry		US10	215.70			
		US10B	215.70			
3570 (F84) Classroom		US26	215.70			
		US26D	200.65			
3573 (F90) Corridor*/Dormitory		US32D			87.85	20
3579 (F113) Keyed Communicating						
3580 (F86) Storeroom						



Locks - 3500 Series



Latchbolts	Finish	2018 List	Box Qty.
Description			
3947	US3	28.00	10
Spring Latch - Passage only (3510) - Standard	US4	29.80	
2-3/4" (70 mm) Backset	US10	29.80	
2-1/4" x 1-1/8" (57 mm x 29 mm) Faceplate	US10B	28.00	
Must specify square or round corner.	US26	28.00	
	US26D	28.00	
	US32D	28.00	
3949	US3	28.00	10
Spring Latch - Passage only (3510)	US4	29.80	
2-3/8" (60 mm) Backset	US10	29.80	
2-1/4" x 1" (57 mm x 25 mm) Faceplate	US10B	28.00	
Must specify square or round corner.	US26	28.00	
	US26D	28.00	
	US32D	28.00	
3965	US3	28.00	10
Spring Latch - Privacy only (3540) - Standard	US4	29.80	
2-3/4" (70 mm) Backset	US10	29.80	
2-1/4" x 1-1/8" (57 mm x 29 mm) Faceplate	US10B	28.00	
Must specify square or round corner.	US26	28.00	
	US26D	28.00	
	US32D	28.00	
3967	US3	28.00	10
Spring Latch - Privacy only (3540)	US4	29.80	
2-3/8" (60 mm) Backset	US10	29.80	
2-1/4" x 1" (57 mm x 25 mm) Faceplate	US10B	28.00	
Must specify square or round corner.	US26	28.00	
	US26D	28.00	
	US32D	28.00	
3948	US3	28.00	10
Dead Latch - 3525 and all keyed functions except Corridor	US4	29.80	
2-3/4" (70 mm) Backset	US10	29.80	
2-1/4" x 1-1/8" (57 mm x 29 mm) Faceplate	US10B	28.00	
Must specify square or round corner.	US26	28.00	
	US26D	28.00	
	US32D	28.00	
3950	US3	28.00	10
Dead Latch - 3525 and all keyed functions except Corridor	US4	29.80	
2-3/8" (60 mm) Backset	US10	29.80	
2-1/4" x 1" (57 mm x 25 mm) Faceplate	US10B	28.00	
Must specify square or round corner.	US26	28.00	
	US26D	28.00	
	US32D	28.00	
3994	US3	28.00	10
Dead Latch - Corridor (3573)	US4	29.80	
2-3/8" (60 mm) Backset	US10	29.80	
2-1/4" x 1" (57 mm x 25 mm) Faceplate	US10B	28.00	
Must specify square or round corner.	US26	28.00	
	US26D	28.00	
	US32D	28.00	



Latchbolts Description	Finish	2018 List	Box Qty.
3995 Dead Latch - Corridor (3573) 2-3/4" (70 mm) Backset 2-1/4" x 1-1/8" (57 mm x 29 mm) Faceplate Must specify square or round corner.	US3 US4 US10 US10B US26 US26D US32D	28.00 29.80 29.80 28.00 28.00 28.00 28.00	10
3959 Faceplate Adapter Can be used with 3500 2-3/8" backset latchbolt. Converts to 1" (25 mm) to 1-1/8" (29 mm) width.	NF	2.65	10
3932 3/4" Dead Latch (3550, 3553, 3570, 3580) 2-3/4" (70 mm) Backset 2-1/4" x 1-1/8" (57 mm x 29 mm) square corner faceplate	US3 US4 US10 US10B US26 US26D	102.90 102.90 102.90 102.90 102.90 102.90	10
3917 3-3/4" (95 mm) Backset extension link Must be used with 2-3/8" backset latchbolt to achieve 3-3/4" total backset.	NF	18.50	10
3937 5" (127 mm) Backset extension link Must be used with 2-3/4" backset latchbolt to achieve 5" total backset.	NF	20.00	10



Locks - 3500 Series



Drive-in Latchbolts Description	Finish	2018 List	Box Qty.
------------------------------------	--------	-----------	----------

3922 2-3/4" (70 mm) Drive-In Spring Latch - Passage only (3510)	NF	28.00	20
---	----	-------	----

3923 2-3/4" (70 mm) Drive-In Spring Latch - Privacy only (3540)	NF	28.00	20
---	----	-------	----

3925 2-3/8" (60 mm) Drive-In Spring Latch - Passage only (3510)	NF	28.00	20
---	----	-------	----

3926 2-3/8" (60 mm) Drive-In Spring Latch - Privacy only (3540)	NF	28.00	20
---	----	-------	----



3924 2-3/4" (70 mm) Drive-In Dead Latch - All keyed functions except corridor	NF	28.00	20
---	----	-------	----

3927 2-3/8" (60 mm) Drive-In Dead Latch - All keyed functions except corridor	NF	28.00	20
---	----	-------	----

3996 2-3/8" (60 mm) Drive-In Dead Latch - Corridor (3573)	NF	28.00	20
---	----	-------	----

3997 2-3/4" (70 mm) Drive-In Dead Latch - Corridor (3573)	NF	28.00	20
---	----	-------	----

Strikes Description	Finish	2018 List	Box Qty.
------------------------	--------	-----------	----------

3933 T-Strike with Plastic Dust Box 1-1/8" x 2-3/4" (29 mm x 70 mm), square corner For use with US32D knobs, order US26D.	US3	8.10	10
	US4	8.50	
	US10	8.50	
	US10B	8.10	
	US26	8.10	
	US26D	8.10	
	US32D	8.10	

3934 Full Lip Strike 1-5/8" x 2-1/4" (41 mm x 57 mm), square corner For use with US32D knobs, order US26D.	US3	8.10	10
	US4	8.50	
	US10	8.50	
	US10B	8.10	
	US26	8.10	
	US26D	8.10	
	US32D	8.10	

3935 ASA Strike Shipped Standard with 3500 Series 1-1/4" x 4-7/8" (32 mm x 124 mm), square corner 1-5/16" lip Order dust box separately.	US3	12.25	10
	US4	13.00	
	US5	12.25	
	US10	12.25	
	US15	12.25	
	US10B	12.25	
	US26	12.25	
	US32D	12.25	

3958 Round Corner Full Lip Strike 1-5/8" x 2-1/4" (41 mm x 57 mm), round corner (1/4" radius) For use with US32D knobs, order US26D.	US3	8.10	10
	US4	8.50	
	US10	8.50	
	US10B	8.10	
	US26	8.10	
	US32D	8.10	



Strikes		Finish	2018 List	Box Qty.
2-669-0389	ASA Metal Dust Box	NF	5.70	10

Components and Screwpacks		Finish	2018 List	
2-300-0048	Screwpack - 3500 Series Lever Locksets	US3/US4/ US10	12.15	
2-300-0050	Screwpack - 3500 Series Lever Locksets	US10B	12.15	
2-300-0052	Screwpack - 3500 Series Lever Locksets	US26/US26D	12.15	
2-300-0059	Screwpack - 3500 Series Knob Locksets	US3	12.15	
2-300-0060	Screwpack - 3500 Series Knob Locksets	US32D	12.15	
2-300-0058	Screwpack - 3517/3527 Lever Locksets only	NF	12.15	
2-300-0045	Screwpack - 3517 Knob Lockset only	NF	5.15	
2-639-3523	3500 Series thru bolt posts	NF	4.20	
2-639-3577	Cylinder Aligning Sleeve (10 pack)	NF	3.05	
3912	3500 Series Leverset Thru-Post Drill Jig	NF	18.75	ea

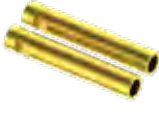

Locks - 3600 Series



Archer  



August  



Withnell  

Description

3600 Series

Grade 2 Tubular Locks
 Fixed Cylinder, Standard
 6 Pin Cylinders, 5-Pin Keyed
 Schlage C Keyway - KD Standard
 2-3/8" - 2-3/4" (60 mm - 70 mm) adjustable backset
 2-1/4" x 1" (57 mm x 25 mm) SC Faceplate
 ASA Strike
 Levers only

Small Format Interchangeable Core option available (cores sold separately - refer to Keying/Core section).

If construction SFIC core is included with the lockset, \$51.20 will be added to the list price of the lock. Refer to keying/cores section for construction core options.

Extended Lip ASA strike available. Add \$10.00 to list price of the lock.

Split finish available, priced at higher finish.

Optional backsets, faceplates and strikes available (see next page).

Optional keying/keyways available.

Refer to catalog or website for more detailed information on functions.

Function	Finish	2018 List	Case Qty.
3610 (F75) Passage	US3	117.60	12
	US4	117.60	
	US10	117.60	
	US10B	117.60	
	US26	117.60	
	US26D	109.40	
3617 Single Dummy	US3	58.40	20
	US4	58.40	
	US10	58.40	
	US10B	58.40	
	US26	58.40	
	US26D	54.30	

Function	Finish	2018 List	Case Qty.
3640 (F76B) Privacy	US3	125.80	12
	US4	125.80	
	US10	125.80	
	US10B	125.80	
	US26	125.80	
	US26D	117.00	
3653 (F82A) Entry/Office	US3	159.80	12
	US4	159.80	
3670 (F84) Classroom	US10	159.80	
	US10B	159.80	
3680 (F86) Storeroom	US26	159.80	
	US26D	148.70	



Latchbolts Description	Finish	2018 List	Box Qty.
3951 Spring Latch - Non-keyed Functions (3600) - Standard 2-3/8" - 2-3/4" (60 mm - 70 mm) adjustable backset 2-1/4" x 1" (57 mm x 25 mm) square corner faceplate	US3	23.50	10
	US4	25.00	
	US10	25.00	
	US10B	23.50	
	US26	23.50	
	US26D	23.50	



3952 Dead Latch - All keyed functions (3600) - Standard 2-3/8" - 2-3/4" (60 mm - 70 mm) adjustable backset 2-1/4" x 1" (57 mm x 25 mm) square corner faceplate	US3	23.50	10
	US4	25.00	
	US10	25.00	
	US10B	23.50	
	US26	23.50	
	US26D	23.50	



3953 Spring Latch - Non-keyed Functions (3600) 2-3/8" - 2-3/4" (60 mm - 70 mm) adjustable backset 2-1/4" x 1" (57 mm x 25 mm) round corner faceplate	US3	23.50	10
	US4	25.00	
	US10	25.00	
	US10B	23.50	
	US26	23.50	
	US26D	23.50	



3954 Dead Latch - All keyed functions (3600) 2-3/8" - 2-3/4" (60 mm - 70 mm) adjustable backset 2-1/4" x 1" (57 mm x 25 mm) round corner faceplate	US3	23.50	10
	US4	25.00	
	US10	25.00	
	US10B	23.50	
	US26	23.50	
	US26D	23.50	



3938 Dead Latch - All keyed functions (3600) 5" (127 mm) Backset 2-1/4" x 1" (57 mm x 25 mm) Faceplate Must specify square or round corner.	US3	25.00	10
	US4	26.30	
	US10	26.30	
	US10B	25.00	
	US26	25.00	
	US26D	25.00	



3939 Spring Latch - Non-keyed functions (3600) 5" (127 mm) Backset 2-1/4" x 1" (57 mm x 25 mm) Faceplate Must specify square or round corner.	US3	25.00	10
	US4	26.30	
	US10	26.30	
	US10B	25.00	
	US26	25.00	
	US26D	25.00	



Drive-in Latchbolts Description	Finish	2018 List	Box Qty.
3914 2-3/8" - 2-3/4" (60 mm - 70 mm) Adjustable Drive-In Spring Latch - All non-keyed functions	NF	23.50	20



3915 2-3/8" - 2-3/4" (60 mm - 70 mm) Adjustable Drive-In Dead Latch - All keyed functions	NF	23.50	20
---	----	-------	----



Locks - 3600 Series

Strikes Description	Finish	2018 List	Box Qty.
3933 T-Strike with Plastic Dust Box 1-1/8" x 2-3/4" (29 mm x 70 mm), square corner	US3	8.10	10
	US4	8.50	
	US10	8.50	
	US10B	8.10	
	US26	8.10	
	US26D	8.10	
3934 Full Lip Strike 1-5/8" x 2-1/4" (41 mm x 57 mm), square corner	US3	8.10	10
	US4	8.50	
	US10	8.50	
	US10B	8.10	
	US26	8.10	
	US26D	8.10	
3935 ASA Strike Shipped standard w/ 3600 Series 1-1/4" x 4-7/8" (32 mm x 124 mm), square corner 1-5/16" lip Order dust box separately	US3	12.25	10
	US4	13.00	
	US5	12.25	
	US10	12.25	
	US15	12.25	
	US10B	12.25	
	US26	12.25	
	US26D	12.25	
3958 Round Corner Full Lip Strike 1-5/8" x 2-1/4" (41 mm x 57 mm) round corner (1/4" radius)	US3	8.10	10
	US4	8.50	
	US10	8.50	
	US10B	8.10	
	US26	8.10	
	US26D	8.10	
2-669-0389 ASA Metal Dust Box	NF	5.70	10
3959 Faceplate Adapter 3600 Series Standard Converts 1" (25 mm) to 1-1/8" (29 mm) width	NF	2.65	10
Components and Screwpacks			
Description	Finish	2018 List	
2-300-0064 Screwpack - 3600 Series Lever Locksets	US3/US4	11.05	
2-300-0066 Screwpack - 3600 Series Lever Locksets	US10B	11.05	
2-300-0068 Screwpack - 3600 Series Lever Locksets	US26/US26D	11.05	
2-300-0074 Screwpack - 3617 Lever Locksets only	NF	11.05	
2-639-7159 Cylinder Aligning Sleeve (10 pack)	NF	2.80	



Description

3700 Series
 Grade 2 Interconnected
 Fixed Cylinder, Standard
 6 Pin Cylinders, 5-Pin Keyed
 Schlage C Keyway - KD Standard
 2-3/4" (70 mm) Backset
 2-1/4" x 1-1/8" (57 mm x 29 mm) SC Faceplate
 T-Strike
 Levers only
 Small Format Interchangeable Core option available (cores sold separately - refer to Keying/Core section).

If construction SFIC core is included with the lockset, \$51.20 will be added to list price of the lock. Refer to keying/cores section for construction core options.



Split finish available, priced at higher finish.

Optional backsets, faceplates and strikes available (see next page).

Optional keying / keyways available.

Refer to catalog or website for more detailed information on functions.



Archer  



August  



Withnell  

Function	Finish	2018 List	Case Qty.
3710 (F95) Entry Single Locking	US3	318.40	6
	US4	318.40	
	US10	318.40	
	US10B	318.40	
	US26	318.40	
	US26D	309.10	

3753 (F97) Entry Double Locking	US3	350.45	6
	US4	350.45	
	US10	350.45	
	US10B	350.45	
	US26	350.45	
	US26D	340.25	

Function	Finish	2018 List	Case Qty.
3796 Privacy Single Locking w/ Indicator	US3	354.85	6
	US4	354.85	
	US10	354.85	
	US10B	354.85	
	US26	354.85	
	US26D	344.50	



Locks - 3700 Series



Latchbolts Description	Finish	2018 List	Box Qty.
3920	US3	28.00	10
2-3/4" (70 mm) Backset - Standard	US4	29.80	
2-1/4" x 1-1/8" (57 mm x 29 mm) Faceplate	US10	29.80	
Must specify square or round corner.	US10B	28.00	
	US26	28.00	
	US26D	28.00	

3921	US3	28.00	10
2-3/8" (60 mm) Backset	US4	29.80	
2-1/4" x 1" (57 mm x 25 mm) Faceplate	US10	29.80	
Must specify square or round corner.	US10B	28.00	
	US26	28.00	
	US26D	28.00	



3947	US3	28.00	10
Spring Latch - Entry Single Locking (3710) - Standard	US4	29.80	
2-3/4" (70 mm) Backset	US10	29.80	
2-1/4" x 1-1/8" (57 mm x 29 mm) Faceplate	US10B	28.00	
Must specify square or round corner.	US26	28.00	
	US26D	28.00	

3949	US3	28.00	10
Spring Latch - Entry Single Locking (3710)	US4	29.80	
2-3/8" (60 mm) Backset	US10	29.80	
2-1/4" x 1" (57 mm x 25 mm) Faceplate	US10B	28.00	
Must specify square or round corner.	US26	28.00	
	US26D	28.00	



3948	US3	28.00	10
Dead Latch - Entry Double Locking (3753) - Standard	US4	29.80	
2-3/4" (70 mm) Backset	US10	29.80	
2-1/4" x 1-1/8" (57 mm x 29 mm) Faceplate	US10B	28.00	
Must specify square or round corner.	US26	28.00	
	US26D	28.00	









3950	US3	28.00	10
Dead Latch - Entry Double Locking (3753)	US4	29.80	
2-3/8" (60 mm) Backset	US10	29.80	
2-1/4" x 1" (57 mm x 25 mm) Faceplate	US10B	28.00	
Must specify square or round corner.	US26	28.00	
	US26D	28.00	



3959	NF	2.65	10
Faceplate Adapter			
Can be used with 3700 2-3/8" backset latchbolt.			
Converts 1" (25 mm) to 1-1/8" (29 mm) width.			

Strikes Description	Finish	2018 List	Box Qty.
3930	US3	8.00	10
3700 Series Deadlock, Standard	US4	8.45	
Strike with Plastic Dust Box	US10	8.45	
1-1/8" x 2-3/4" (29 mm x 70 mm), square corner	US10B	8.00	
	US26	8.00	
	US26D	8.00	



Strikes		Finish	2018 List	Box Qty.
Description				
 3933 T-Strike with Plastic Dust Box 3700 Series Latchbolt, Standard 1-1/8" x 2-3/4" (29 mm x 70 mm), square corner		US3	8.10	10
		US4	8.50	
		US10	8.50	
		US10B	8.10	
		US26	8.10	
		US26D	8.10	
 3934 Full Lip Strike 1-5/8" x 2-1/4" (41 mm x 57 mm), square corner		US3	8.10	10
		US4	8.50	
		US10	8.50	
		US10B	8.10	
		US26	8.10	
		US26D	8.10	
 3958 Round Corner Full Lip Strike 1-5/8" x 2-1/4" (41 mm x 57 mm), round corner (1/4" radius)		US3	8.10	10
		US4	8.50	
		US10	8.50	
		US10B	8.10	
		US26	8.10	
		US26D	8.10	
 2-639-3109 Deadlock Dust Box, Plastic		NF	3.85	10
Components and Screwpacks		Finish	2018 List	
Description				
 2-300-0138 Screwpack - 3700 Series Lever Lockset		US3/US4/ US10	11.60	
		US10B	11.60	
2-300-0140 Screwpack - 3700 Series Lever Lockset		US10B	11.60	
		US26/US26D	11.60	
2-300-0141 Screwpack - 3700 Series Lever Lockset		US26/US26D	11.60	
 2-639-7641 3976 Emergency Key (10Pk)		NF	8.70	



HOW TO ORDER EXAMPLE

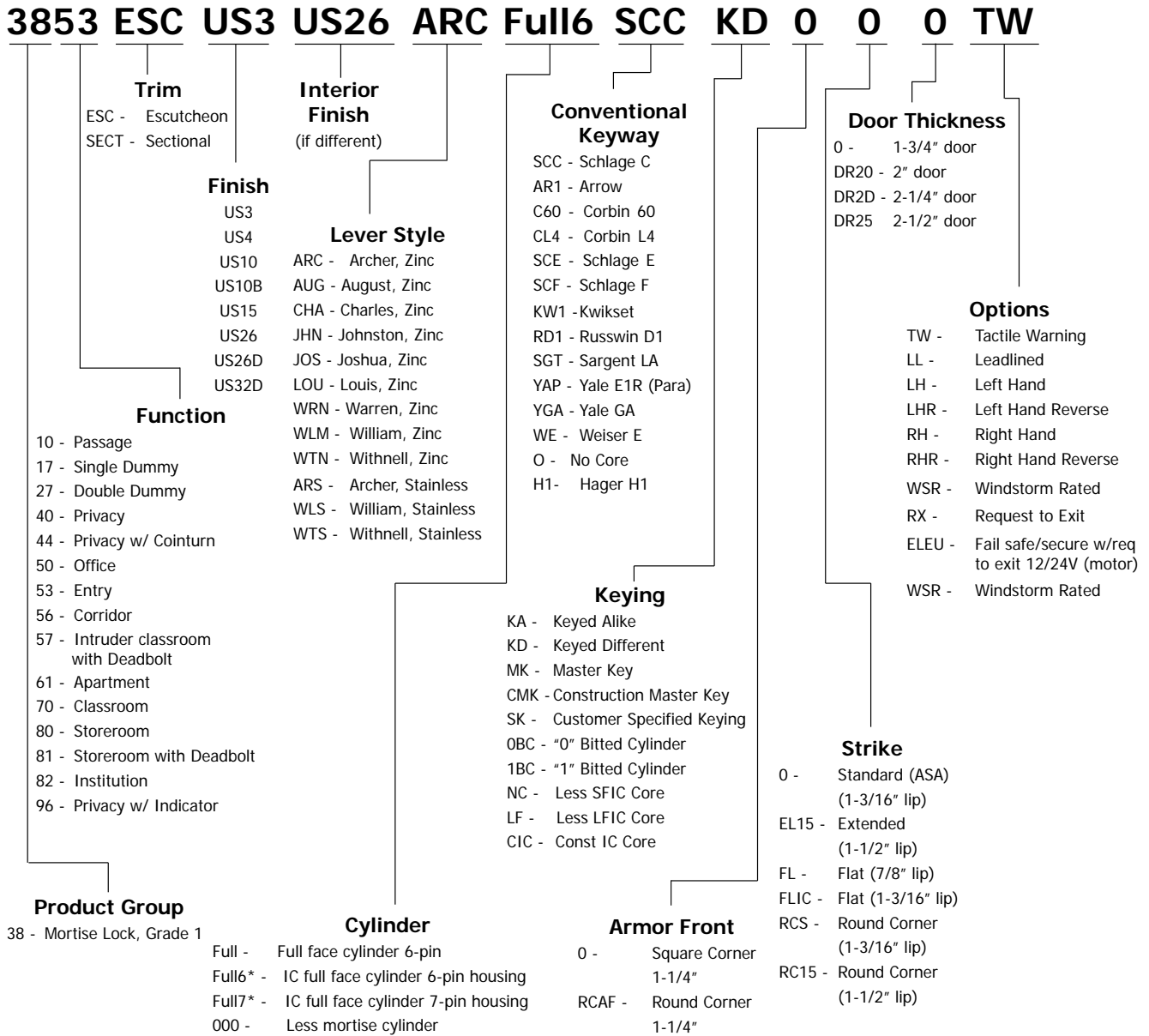

Notes:

- Finishes other than US10B, US15, US26D and US32D are subject to 90 day extended lead time.
- If master-keyed, include master key instruction sheet with order (available online).
- For additional keying information, refer to cylinder, core, and keying section of catalog.
- Quick Connect option available on 3800Series Electrified Sectional and Escutcheon models (EL, EU, RX, DPM, and LM).

Ordering example: 3880 SECT US26D WTN ELEUQC

- Door width greater than 2-1/2", or doors with offset prep are POA with 90 day extended lead time.

Please refer to our Catalog or website (www.hagerco.com) for more detailed and series specific ordering information along with additional information including functions available, additional options, and keying information.

Description

3800 Series Sectional

Grade 1 Mortise
 Fixed Cylinder, Supplied Standard
 1-1/8" Mortise Cylinder w/ Schlage L Cam - Standard
 6 Pin Cylinders, 5-pin Keyed
 Schlage C Keyway - KD Standard
 2-3/4" (70 mm) Backset
 ASA Strike, 3985

Price includes mortise cylinder(s) where applicable and standard cylinder will be shipped with lock unless specified.

If keyed functions ordered less cylinder, subtract \$48.00 for each cylinder from list price.

Small and Large Format Interchangeable Core option available (cores sold separately - refer to Keying/Core section).

If construction core is included with the lockset, \$51.20 (SFIC) or \$64.75 (LFIC) will be added to list price of the lock. Refer to keying/cores section for construction core options.

*3857, 3861, and 3882 require two cylinders.

Must specify "Full" for fixed cylinder, "ICFULL6" for SFIC 6-Pin / LFIC 6-Pin, and "ICFull7" for SFIC 7-Pin.

Options

- Lead Lined available. Add \$175.00 to the list price of lock.
- Tactile Warning available. Add \$42.00 to the list price of lock.
- For Severe Windstorm Rating, add \$40.00 to the list price of lock (3853 and 3881 only).
- Optional strikes and armor fronts available.
- Optional keying/keyways available.
- Extended Lip ASA strike available, add \$15.00 to list price of the lock.
- Lock Hanging available, add \$12.00 to list price of the lock.
- ADA thumbturn available, add \$16 to list price of the lock.
- Security Torx screws available, add \$18 to the list price of the lock.

Finishes

Finishes other than 10B, 15, 26D and 32D will be subject to an extended lead time. Consult factory for availability.

**32D look on cast zinc lever; for a true 32D, specify stainless steel levers (Archer = ARS, William = WLS, Withnell = WTS).

Special door thicknesses are POA and will be subject to long lead time.

Handing required when ordering Johnston and Warren lever design.



Archer 



August 



William 



Withnell 



Joshua 



Charles 



Louis 



Johnston 



Warren 

Function	Finish	Zinc 2018 List	Case Qty.	S.S. 2018 List	Case Qty.
3810S (F01) Passage	US3	384.45	6		6
	US4	384.45			
	US10	384.45			
	US10B	384.45			
	US15	384.45			
	US26	384.45			
	US26D	369.65			
	US32D**	369.65		480.50	
3817S Single Dummy	US3	130.75	6		6
	US4	130.75			
	US10	130.75			
	US10B	130.75			
	US15	130.75			
	US26	130.75			
	US26D	125.70			
	US32D**	125.70		163.40	
3827S Double Dummy	US3	260.60	6		6
	US4	260.60			
	US10	260.60			
	US10B	260.60			
	US15	260.60			
	US26	260.60			
	US26D	250.55			
	US32D**	250.55		325.75	



Locks - 3800 Series



Description

3800 Series Sectional (Continued)

Continued

Function	Finish	Zinc 2018 List	Case Qty.	S.S. 2018 List	Case Qty.
3840S (F02) Privacy	US3	441.60	6		6
	US4	441.60			
	US10	441.60			
	US10B	441.60			
	US15	441.60			
	US26	441.60			
	US26D	424.65			
	US32D**	424.65		552.05	
3844S (F22) Privacy w/ Cointurn	US3	480.90	6		6
	US4	480.90			
	US10	480.90			
	US10B	480.90			
	US15	480.90			
	US26	480.90			
	US26D	462.45			
	US32D**	462.45		601.20	
3850S (F04) Office	US3	493.05	6		6
	US4	493.05			
3870S (F05) Classroom	US10	493.05			
	US10B	493.05			
3880S (F07) Storeroom	US15	493.05			
	US26	493.05			
	US26D	474.10			
	US32D**	474.10		616.35	
3853S (F20) Entry	US3	510.85	6		6
	US4	510.85			
3856S (F13) Corridor	US10	510.85			
	US10B	510.85			
	US15	510.85			
	US26	510.85			
	US26D	491.20			
	US32D**	491.20		638.55	

Function	Finish	Zinc 2018 List	Case Qty.	S.S. 2018 List	Case Qty.
3857S* (F33) Intruder Classroom w/ Deadbolt	US3	548.70	6		6
	US4	548.70			
3861S* (F09) Apartment Entrance	US10	548.70			
	US10B	548.70			
3882S* (F30) Institution	US15	548.70			
	US26	548.70			
	US26D	527.60			
	US32D**	527.60		685.85	
3881S Storeroom w/ Deadbolt	US3	536.50	6		6
	US4	536.50			
	US10	536.50			
	US10B	536.50			
	US15	536.50			
	US26	536.50			
	US26D	515.85			
	US32D**	515.85		670.65	
3896S Privacy w/ Indicator	US3	501.45	6		6
	US4	501.45			
	US10	501.45			
	US10B	501.45			
	US15	501.45			
	US26	501.45			
	US26D	482.15			
	US32D**	482.15		626.85	

Description

3800 Series Escutcheon

Grade 1 Mortise
 Fixed Cylinder, Supplied Standard
 1-1/8" Mortise Cylinder w/ Schlage L Cam - Standard
 6 Pin Cylinders, 5-pin Keyed
 Schlage C Keyway - KD Standard
 2-3/4" (70 mm) Backset
 ASA Strike, 3985

Price includes mortise cylinder(s) where applicable and standard cylinder will be shipped with lock unless specified.

If keyed functions ordered less cylinder, subtract \$48.00 for each cylinder from list price.

Small and Large Format Interchangeable Core option available (cores sold separately - refer to Keying/Core section).

If included with the lockset, \$51.20 will be added to list price of the lock. Refer to keying/cores section for construction core options.

*3857, 3861, and 3882 require two cylinders.

Must specify "Full" for fixed cylinder, "ICFULL6" for SFIC 6-Pin / LFIC 6-Pin, and "ICFull7" for SFIC 7-Pin.

Options

- Lead Lined available. Add \$175.00 to the list price of lock.
- Tactile Warning available. Add \$42.00 to the list price of lock.
- For Severe Windstorm Rating, add \$40.00 to the list price of lock (3853 and 3881 only).
- Optional strikes and armor fronts available.
- Optional keying/keyways available
- Extended Lip ASA strike available. Add \$15.00 to list price of the lock.
- Lock Handing Available. Add \$12.00 to list price of the lock.
- Security Torx screws available, add \$18.00 to the list price of the lock.

Finishes

Finishes other than 10B, 15, 26D and 32D will be subject to an extended lead time. Consult factory for availability.

**32D look on cast zinc lever; for a true 32D, specify stainless steel levers (Archer = ARS, William = WLS, Withnell = WTS).

Special door thicknesses are POA and will be subject to long lead time.

Handing required when ordering Johnston and Warren lever design.



Archer



August



William



Withnell



Joshua



Charles



Louis



Johnston



Warren

Function	Finish	Zinc 2018 List	Case Qty.	S.S. 2018 List	Case Qty.
3810E (F10) Passage	US3	417.10	6		6
	US4	417.10			
	US10	417.10			
	US10B	417.10			
	US15	417.10			
	US26	417.10			
	US26D	401.05			
	US32D**	401.05		521.35	
3817E Single Dummy	US3	141.85	6		6
	US4	141.85			
	US10	141.85			
	US10B	141.85			
	US15	141.85			
	US26	141.85			
	US26D	136.40			
	US32D**	136.40		177.35	
3827E Double Dummy	US3	282.70	6		6
	US4	282.70			
	US10	282.70			
	US10B	282.70			
	US15	282.70			
	US26	282.70			
	US26D	271.85			
	US32D**	271.85		353.40	



Locks - 3800 Series



Description

3800 Series Escutcheon (Continued)

Continued

Function	Finish	Zinc 2018 List	Case Qty.	S.S. 2018 List	Case Qty.
3840E (F02) Privacy	US3	479.15	6		6
	US4	479.15			
	US10	479.15			
	US10B	479.15			
	US15	479.15			
	US26	479.15			
	US26D	460.75			
	US32D**	460.75		598.95	
3844E (F22) Privacy w/ Cointurn	US3	521.85	6		6
	US4	521.85			
	US10	521.85			
	US10B	521.85			
	US15	521.85			
	US26	521.85			
	US26D	501.75			
	US32D**	501.75		652.30	
3850E (F04) Office	US3	535.00	6		6
	US4	535.00			
3870E (F05) Classroom	US10	535.00			
	US10B	535.00			
3880E (F07) Storeroom	US15	535.00			
	US26	535.00			
	US26D	514.40			
	US32D**	514.40		668.75	
3853E (F20) Entry	US3	554.25	6		6
	US4	554.25			
3856E (F13) Corridor	US10	554.25			
	US10B	554.25			
	US15	554.25			
	US26	554.25			
	US26D	532.95			
	US32D**	532.95		692.80	

Function	Finish	Zinc 2018 List	Case Qty.	S.S. 2018 List	Case Qty.
3857E* (F33) Intruder Classroom w/ Deadbolt	US3	595.30	6		6
	US4	595.30			
3861E* (F09) Apartment Entrance	US10	595.30			
	US10B	595.30			
3882E* (F30) Institution	US15	595.30			
	US26	595.30			
	US26D	572.40			
	US32D**	572.40		744.10	
3881E Storeroom w/ Deadbolt	US3	582.10	6		6
	US4	582.10			
	US10	582.10			
	US10B	582.10			
	US15	582.10			
	US26	582.10			
	US26D	559.70			
	US32D**	559.70		727.60	
3896E Privacy w/ Indicator	US3	544.10	6		6
	US4	544.10			
	US10	544.10			
	US10B	544.10			
	US15	544.10			
	US26	544.10			
	US26D	523.15			
	US32D**	523.15		680.10	





3800 Series Electrified Options - Sectional or Escutcheon Models	Add electrified charges to the list price of the lock	
Description	Function	2018 List
Outside lever continuously locked (EL) or unlocked (EU) by 12 or 24V. Latchbolt retracted by key outside or lever inside. Auxiliary latch deadlocks latchbolt when door is closed. Inside always free for immediate egress.	3880ELEU 12V/24V Storeroom - Fail Safe/Fail Secure	370.00
Both levers continuously locked (EL) or unlocked (EU) by 12 or 24V. Latchbolt retracted by key inside or outside. Auxiliary latch deadlocks latchbolt when door is closed.	3882ELEU 12V/24V Institution - Fail Safe/Fail Secure	370.00
Monitors inside lever rotation. Incorporates into fire alarm systems or in conjunction with an electromagnet. Available on 3880 or in conjunction with 3880ELEU.	RX Request to Exit	198.00
Single switch (SPDT) mounted inside lockset monitors the full extension of the latchbolt. Available on 3880, 3882, or in conjunction with 3880ELEU or 3882ELEU.	LM Latchbolt Monitoring	198.00
Single switch (SPDT Reed Magnetic Switch) mounted inside the lock monitors whether the door is fully closed. Available on 3880, 3882, or in conjunction with 3880ELEU or 3882ELEU.	DPM Door Position Monitoring	218.00

Quick Connect Option: Locks will come with molex connector attached. Quick connect option allows rapid installation of locks when used with the Hager Quick Connect harness cable. See Commercial Hinge section (page 7) for available harness sizes.

Quick Connect Ordering Example: 3880 SECT US26D WTN ELEUQC



Power Supplies	Add electrified charges to the list price of the lock	
Description	Function	2018 List
Provides power for locking devices and interfaces with building alarm controls, card readers, keypads, and other door controls.	2903 24 Volt Power Supply	Reference Electrified products section
Provides power and control for openings with an electrified locking device and automatic door operator.	2904 24 Volt Power Supply	Reference Electrified products section
Provides up to 1 amp of 12 or 24 Volt DC Power for all Hager Electrified Products	2908 24 Volt Power Supply	Reference Electrified products section
Provides up to 2 amp of 12 or 24 Volt DC Power for all Hager Electrified Products	2909 24 Volt Power Supply	Reference Electrified products section



Locks - 3800 Series



Description

3800 Series Deadlock

Grade 1 Mortise - Deadlock
 Fixed Cylinder, Standard
 1-1/8" Mortise Cylinder w/ Schlage `L' Cam Standard
 6 Pin Cylinders, 5-pin Keyed
 Schlage C Keyway - KD Standard
 2-3/4" (70 mm) Backset
 No Lip Strike, 3991

Price includes mortise cylinder(s) where applicable and standard cylinder will be shipped with deadlock unless specified.

If keyed deadlocks ordered less cylinder, subtract \$48.00 for each cylinder from list price.

Small and Large Format Interchangeable Core option available (cores sold separately - refer to Keying/Core section).

*3862 requires two cylinders

Must specify "Full" for fixed cylinder, "ICFULL6" for SFIC 6-Pin / LFIC 6-Pin, and "ICFull7" for SFIC 7-Pin.

Options

- Lead Lined available. Add \$175.00 to the list price of lock.
- Optional keying/keyways available.

**Hager Keyway is 7-Pin Only

Finishes other than 26D will be subject to an extended lead time. Consult factory for availability.

Refer to catalog or website for more detailed information on functions.

Function	Finish	2018 List	Case Qty.
3860S (F17) Cylinder x Thumbturn	US3	268.25	6
	US4	268.25	
	US10	268.25	
	US10B	268.25	
	US26	268.25	
	US26D	255.45	
3862S* (F16) Double Cylinder	US3	325.75	6
	US4	325.75	
	US10	325.75	
	US10B	325.75	
	US26	325.75	
	US26D	310.20	

Function	Finish	2018 List	Case Qty.
3863S (F29) Classroom (Specify Handing)	US3	325.75	6
	US4	325.75	
	US10	325.75	
	US10B	325.75	
	US26	325.75	
	US26D	310.20	
3864S (F18) Cylinder	US3	224.40	6
	US4	224.40	
	US10	224.40	
	US10B	224.40	
	US26	224.40	
	US26D	213.75	



Description

3800 Series Small Case Deadlock

Grade 1 Mortise - Deadlock
 Fixed Cylinder, Standard
 1-1/8" Mortise Cylinder w/ Schlage `L' Cam Standard
 6 Pin Cylinders, 5-pin Keyed
 Schlage C Keyway - KD Standard
 2-3/4" (70 mm) Backset
 No Lip Strike, 3999

Price includes mortise cylinder(s) where applicable and standard cylinder will be shipped with deadlock unless specified.

If keyed deadlocks ordered less cylinder, subtract \$48.00 for each cylinder from list price.

Small and Large Format Interchangeable Core option available (cores sold separately - refer to Keying/Core section).

*3832 requires two cylinders
 Must specify "Full" for fixed cylinder, "ICFULL6" for SFIC 6-Pin / LFIC 6-Pin, and "ICFull7" for SFIC 7-Pin.

Options
 - Optional keying/keyways available.
 **Hager Keyway is 7-Pin Only

Finishes other than 26D will be subject to an extended lead time. Consult factory for availability.

Refer to catalog or website for more detailed information on functions.

Function	Finish	2018 List	Case Qty.
3830S (E06071) Cylinder x Thumbturn	US3	234.35	6
	US4	234.35	
	US10	234.35	
	US10B	234.35	
	US26	234.35	
	US26D	223.20	
3831S (E06181) Door Bolt Thumbturn only	US3	200.35	6
	US4	200.35	
	US10	200.35	
	US10B	200.35	
	US26	200.35	
	US26D	190.80	
3832S* (E06061) Double Cylinder	US3	284.45	6
	US4	284.45	
	US10	284.45	
	US10B	284.45	
	US26	284.45	
	US26D	270.90	

Function	Finish	2018 List	Case Qty.
3833S (E06091) Classroom (Specify Handing)	US3	284.45	6
	US4	284.45	
	US10	284.45	
	US10B	284.45	
	US26	284.45	
	US26D	270.90	
3834S (E06081) Cylinder	US3	196.00	6
	US4	196.00	
	US10	196.00	
	US10B	196.00	
	US26	196.00	
	US26D	186.70	



Locks - 3800 Series



Description

3800 Series Sliding Door Mortise Lock

Sliding Door Mortise Lock
 Fixed Cylinder, Standard
 1-1/8" Mortise Cylinder w/ Schlage `L` Cam Standard
 6 Pin Cylinders, 5-pin Keyed
 Schlage C Keyway - KD Standard
 2-3/4" (70 mm) Backset
 No Lip Strike

Price includes mortise cylinder(s) where applicable and standard cylinder will be shipped with deadlock unless specified.

If keyed deadlocks ordered less cylinder, subtract \$48.00 for each cylinder from list price.

Small and Large Format Interchangeable Core option available (cores sold separately - refer to Keying/Core section).

*3837 requires two cylinders

Must specify "Full" for fixed cylinder, "ICFULL6" for SFIC 6-Pin / LFIC 6-Pin, and "ICFull7" for SFIC 7-Pin.

Options

- Optional keying/keyways available.

**Hager Keyway is 7-Pin Only

Refer to catalog or website for more detailed information on functions.

Function	Finish	2018 List	Case Qty.
3835S Cylinder x Thumbturn	US26D	177.35	6
3836S Single Cylinder	US26D	177.35	6
3837S Double Cylinder	US26D	208.85	6

Function	Finish	2018 List	Case Qty.
3838S Thumbturn Only	US26D	157.50	6
3839S Thumbturn w/ Emergency Key (Privacy)	US26D	170.10	6

Components, Strikes, and Screwpacks		
Description	Finish	2018 List
Zinc Mortise Lock Levers (each) Consult factory for part numbers and other finishes. (May be subject to extended lead times)	US26D/US32D	56.45
Stainless Mortise Lock Levers (each) Consult factory for part numbers and other finishes. (May be subject to extended lead times)	US32D	85.35
3918 Tapered Cylinder Collar For use with sectional mortise lock, standard with 1-1/8" cylinder, 1-3/4" door. Includes wave washer and shim.	US26D US10B US15 / US32D	11.65 13.65 11.65
3928 Flat Cylinder Collar 1-3/8" diameter, 11/32" thick For use with double cylinder sectional mortise locks and other special cylinders and door thicknesses. Consult factory. Includes wave washer and shim.	US26D US10B US15 / US32D	11.65 13.65 11.65
3985 Standard Lip Strike Square corner 1-1/4" x 4-7/8" x 1-3/16" (32 mm x 124 mm x 30 mm)	US10B US32D*	18.25 17.05
3986 Extended Lip Strike Square corner 1-1/4" x 4-7/8" x 1-1/2" (32 mm x 124 mm x 38 mm)	US10B US32D*	18.25 17.05
3987 Standard Lip Strike Round corner 1-1/4" x 4-7/8" x 1-3/16" (32 mm x 124 mm x 30 mm)	US10B US32D*	18.25 17.05
3988 Extended Lip Strike Round corner 1-1/4" x 4-7/8" x 1-1/2" (32 mm x 124 mm x 38 mm)	US10B US32D*	18.25 17.05
3989 Flat Lip Strike Square corner 1-1/4" x 4-7/8" x 7/8" (32 mm x 124 mm x 22 mm)	US10B US32D*	18.25 17.05
3990 Extended Flat Lip Strike Square corner 1-1/4" x 4-7/8" x 1-3/16" (32 mm x 124 mm x 30 mm)	US10B US26D	18.25 17.05
3991 Square corner Full Case Deadlock Strike (3860, 3862, 3863, 3864) 1-1/4" x 4-7/8" (32 mm x 124 mm)	US10B US26D	18.25 17.05



Locks - 3800 Series



Components, Strikes, and Screwpacks Description	Finish	2018 List
3999	US10B	18.25
For Small Case	US32D*	17.05
No Lip Strike		
Square corner		
1-1/8" x 3- 1/2" (29 mm x 89 mm)		
2-669-0389	NF	5.70
ASA Metal Dust Box		
2-669-0224	US10B	12.50
Armor Front 1-1/4" Square corner (Latch x Aux Latch x Deadbolt) - 3853, 3881		
2-669-0226	US32D*	12.00
Armor Front 1-1/4" Square corner (Latch x Aux Latch x Deadbolt) - 3853, 3881		
2-669-0230	US10B	12.50
Armor Front 1-1/4" Square corner (Latch x Aux Latch) - 3850, 3861, 3870, 3880, 3882		
2-669-0232	US32D*	12.00
Armor Front 1-1/4" Square corner (Latch x Aux Latch) - 3850, 3861, 3870, 3880, 3882		
2-669-0236	US10B	12.50
Armor Front 1-1/4" Square corner (Latch x Deadbolt) - 3856, 3857		
2-669-0238	US32D*	12.00
Armor Front 1-1/4" Square corner (Latch x Deadbolt) - 3856, 3857		
2-669-0242	US10B	12.50
Armor Front 1-1/4" Square corner (Latch) - 3810, 3840, 3844, 3896		
2-669-0244	US32D*	12.00
Armor Front 1-1/4" Square corner (Latch) - 3810, 3840, 3844, 3896		
2-669-0248	US10B	12.50
Armor Front 1-1/4" Square corner (Blank)		
2-669-0250	US32D*	12.00
Armor Front 1-1/4" Square corner (Blank)		
2-669-0254	US10B	12.50
Armor Front 1-1/4" Square corner (Deadbolt) - 3860, 3862, 3863, 3864		
2-669-0256	US32D*	12.00
Armor Front 1-1/4" Square corner (Deadbolt) - 3860, 3862, 3863, 3864		
2-669-0296	US10B	12.50
Armor Front 1-1/4" Round corner (Latch x Aux Latch x Deadbolt) - 3853, 3881		
2-669-0298	US32D*	12.00
Armor Front 1-1/4" Round corner (Latch x Aux Latch x Deadbolt) - 3853, 3881		
2-669-0302	US10B	12.50
Armor Front 1-1/4" Round corner (Latch x Aux Latch) - 3850, 3861, 3870, 3880, 3882		
2-669-0304	US32D*	12.00
Armor Front 1-1/4" Round corner (Latch x Aux Latch) - 3850, 3861, 3870, 3880, 3882		



Components, Strikes, and Screwpacks Description	Finish	2018 List
2-669-0308 Armor Front 1-1/4" Round corner (Latch x Deadbolt) - 3856, 3857	US10B	12.50
2-669-0310 Armor Front 1-1/4" Round corner (Latch x Deadbolt) - 3856, 3857	US32D*	12.00
2-669-0314 Armor Front 1-1/4" Round corner (Latch) - 3810, 3840, 3844, 3896	US10B	12.50
2-669-0316 Armor Front 1-1/4" Round corner (Latch) - 3810, 3840, 3844, 3896	US32D*	12.00
2-669-0320 Armor Front 1-1/4" Round corner (Blank)	US10B	12.50
2-669-0322 Armor Front 1-1/4" Round corner (Blank)	US32D*	12.00
2-669-0326 Armor Front 1-1/4" Round corner (Deadbolt) - 3860, 3862, 3863, 3864	US10B	12.50
2-669-0328 Armor Front 1-1/4" Round corner (Deadbolt) - 3860, 3862, 3863, 3864	US32D*	12.00
2-669-0408 Thumbturn (3850, 3853, 3856, 3860, 3881)	US10B	34.15
2-669-0410 Thumbturn (3850, 3853, 3856, 3860, 3881)	US26D	31.90
2-669-0411 Thumbturn (3850, 3853, 3856, 3860, 3881)	US15/US32D	31.90
*For use with US15 and US26D mortise locks, order US32D finish.		
2-669-0415 Thumbturn (3840, 3844, 3896)	US10B	34.15
2-669-0417 Thumbturn (3840, 3844, 3896)	US26D	31.90
2-669-0418 Thumbturn (3840, 3844, 3896)	US15/US32D	31.90
2-669-0422 Emergency Release (3840, 3896)	US10B	7.45
2-669-0424 Emergency Release (3840, 3896)	US26D	6.95
2-669-0425 Emergency Release (3840, 3896)	US32D	6.95
2-669-0111 Screwpack (3850S, 3853S, 3856S, 3840S, 3844S, 3896S)	US10B	27.20
2-669-0112 Screwpack (3850S, 3853S, 3856S, 3840S, 3844S, 3896S)	US32D	25.40
2-669-0115 Screwpack (3870S, 3861S, 3857S, 3865S, 3810S)	US10B	27.20



Locks - 3800 Series

Components, Strikes, and Screwpacks Description	Finish	2018 List
2-669-0116 Screwpack (3870S, 3861S, 3857S, 3865S, 3810S)	US32D	25.40
2-669-0119 Screwpack (3850E, 3853E, 3870E, 3861E, 3857E, 3856E, 3840E, 3844E, 3810E, 3896E)	US10B	27.20
2-669-0120 Screwpack (3850E, 3853E, 3870E, 3861E, 3857E, 3856E, 3840E, 3844E, 3810E, 3896E)	US32D	25.40
2-669-0123 Screwpack (3881S)	US10B	27.20
2-669-0124 Screwpack (3881S)	US32D	25.40
2-669-0127 Screwpack (3880S)	US10B	27.20
2-669-0128 Screwpack (3880S)	US32D	25.40
2-669-0131 Screwpack (3880E, 3881E)	US10B	27.20
2-669-0132 Screwpack (3880E, 3881E)	US32D	25.40
2-669-0135 Screwpack (3862S, 3863S, 3864S)	US10B	13.60
2-669-0136 Screwpack (3862S, 3863S, 3864S)	US32D	12.70
2-669-0147 Screwpack (3860S)	US10B	13.60
2-669-0148 Screwpack (3860S)	US32D	12.70
2-669-0139 Screwpack (3882S)	US10B	17.70
2-669-0140 Screwpack (3882S)	US32D	16.55
2-669-0143 Screwpack (3882E)	US10B	17.70
2-669-0144 Screwpack (3882E)	US32D	16.55
2-669-0157 Screwpack (3827S)	NF	10.20
2-669-0158 Screwpack (3827E)	NF	10.20
2-669-0167 Screwpack (3817S)	NF	7.10
2-669-0168 Screwpack (3817E)	NF	7.10
2-669-0365 Thru-Bolt Bag (2 each) 1-3/8" to 2" door	NF	8.70
2-669-0366 Thru-Bolt Bag (2 each) Over 2" to 2-1/2" door	NF	9.65





Components, Strikes, and Screwpacks		
Description	Finish	2018 List
2-669-0613 Square Spindles - 5-pk	NF	26.50
2-669-0597 Armor Front Screws - 10-pk	26D	11.10
2-669-0615 Lock Case (3853)	NF	182.00
2-669-0616 Lock Case (3881)	NF	182.00
2-669-0600 Lock Case (3856, 3857)	NF	216.00
2-669-0603 Lock Case (3850, 3870, 3861, 3876)	NF	178.75
2-669-0604 Lock Case (3880)	NF	178.75
2-669-0605 Lock Case (3810)	NF	127.85
2-669-0641 Lock Case (3840, 3844, 3896)	NF	178.75
2-669-0635 Lock Case (3853 Windstorm Rated)	NF	216.00
2-669-0636 Lock Case (3881 Windstorm Rated)	NF	216.00
2-669-0643 Lever Adapters (Keepers) for Stainless Levers	NF	6.40



Locks - Cylinders/Keying



Fixed Cylinders/Key-in-Lever - Keying Charges		
Description	Finish	2018 List
Keyed Different (KD) 5-pin (Standard), 6-pin, 7-pin (Hager Keyway only) available		N/C
Keyed Alike (KA) 5-pin (Standard), 6-pin, 7-pin (Hager Keyway Only). 0-Bitted and 1-Bitted available*		N/C
Master Keyed (MK) - Add to list price of lock**		21.10
Construction Master Keyed (CMK) - Add to the standard master key charge and the list price of lock (Schlage C / Hager H1 only)**		14.15
Keyed to specific or existing number - Add to list price of lock		7.50
Extra Cut Keys - specify change key, MK, GMK or CMK (3961 - 5-pin, 3962 - 6-pin, 3908 - 7-pin Hager only)		6.35
Key Markings - Standard key symbols (AA1) - Visual Key Control (VKC)		No Charge
Key Markings - Non-standard code - Visual Key Control (VKC)		6.05
Custom Cylinder Markings/Concealed Key Control (CKC) - limited to 6 characters		6.05
3998 - Bitting List (No charge if ordered with master keying) - Factory Keyed		175.00
Bitting List - Hager designed system - Keyed by others		175.00
Other keyways available (refer to Catalog or website) - Add to list price of lock		15.65

*Allow 7 working days for 0-bitted, 1-bitted, and KA orders

** Allow 20 working days for factory master key orders.

Notes:

1. Lock prices do not include keying charges.
2. Locks furnished with 6-pin cylinder, 5-pin keyed, Schlage C keyway keyed different unless otherwise specified.
3. Please include Master Key Instruction Sheet with order, available online or in catalog. Failure to provide will delay order.

Fixed Cylinder Key Description	Finish	2018 List	Box Qty.
3955 Key Blank 5-Pin C Keyway Other keyways available*	NF	1.60	50
3956 Key Blank 6-Pin C Keyway Other keyways available*	NF	2.20	50
3961 Cut 5-Pin Key 5-Pin C Keyway Other keyways available*	NF	6.35	50





Fixed Cylinder Key		Finish	2018 List	Box Qty.
Description				
3962	Cut 6-Pin Key 6-Pin C Keyway Other keyways available*	NF	6.35	50
3907	Key Blank 7-Pin H Keyways	NF	2.20	50
3908	Cut 7-Pin Key 7-Pin H Keyways	NF	6.35	50











*Refer to catalog or website for more information on available keyways.



Fixed Cylinder/Tailpieces		Finish	2018 List
Description			
3960 or 3906 (Hager Keyway Only)	Fixed Cylinder Kit - Includes two keys 3960 - C Keyway; 6-pin cylinder, 5-pin keyed - Standard 3906 - H Keyways, 7-pin cylinder - Standard Additional options and keyways available at additional cost (refer to catalog or website). Tailpiece optional when ordering (No Charge) Please include cylinder instructions and ordering guide sheet with order (available online).	US4 US26D	51.30 51.30
2-639-7000	Tailpiece 1 Pack of 10 tailpieces for use with 3453L, 3450L, 3480L, 3482L, 2580L	NF	11.75
2-639-7001	Tailpiece 2 Pack of 10 tailpieces for use with 3470L.	NF	11.75
2-639-7002	Tailpiece 3 Pack of 10 tailpieces for use with 3453K, 3480K, 3550L, 3553L, 3553K, 3579L, 3580L, 3580K, 3753L, 2550L, 2553L	NF	11.75
2-639-7003	Tailpiece 4 Pack of 10 tailpieces for use with 3470K, 3570K	NF	11.75
2-639-7005	Tailpiece 6 Pack of 10 tailpieces for use with 3114 (Exterior Cyl.), 3214 (Exterior	NF	11.75



Locks - Cylinders/Keying

Fixed Cylinder/Tailpieces			
Description	Finish	2018 List	
 2-639-7006 Tailpiece 7 Pack of 10 tailpieces for use with 3114 (Interior Cyl.), 3214 (Interior)	NF	11.75	
 2-639-7007 Tailpiece 8 Pack of 10 tailpieces for use with 3115, 3118, 3215, 3710L, 3753L	NF	11.75	
 2-639-7008 Tailpiece 9 Pack of 10 tailpieces for use with 3653L, 3670L, 3680L	NF	11.75	
 2-639-7018 Tailpiece W Pack of 10 tailpieces for use with 3473L	NF	11.75	
 2-639-7192 Tailpiece K Pack of 10 tailpieces for use with 47KE, 47KN	NF	11.75	
 2-639-7087 Tailpiece Z Pack of 10 tailpieces for use with 3570L and 3573L	NF	11.75	
 2-639-7094 Tailpiece X Pack of 10 tailpieces for use with 3495L	NF	11.75	
 2-639-7322 Tailpiece V Pack of 10 tailpieces for use with 3473L	NF	11.75	
Fixed Cylinder - Rim Cylinder			
Description	Finish	2018 List	Box Qty.
 3901 Fixed Rim Cylinder 6-Pin Cylinder, 5-Pin Keyed; 7-Pin Cylinder (Hager Keyway Only) Schlage C Keyway or Hager Keyway - Keyed Different Standard Shipped with breakoff tailpiece attached. Shipped with collar, mounting plate, and breakoff screws.	US3	48.50	1
	US4	51.55	
	US10	51.55	
	US10B	48.50	
	US26	48.50	
	US26D	48.50	
 3903 Rim Dummy Cylinder Shipped with mounting plate, and breakoff screws.	US3	32.40	1
	US4	32.40	
	US10	32.40	
	US10B	32.40	
	US26	32.40	
	US26D	32.40	





Fixed Cylinder - Rim Cylinder Accessories	Finish	2018 List	Box Qty.
---	--------	-----------	----------

2-639-7058 Long breakoff tailpiece - 2-3/8" (60 mm)	NF	2.45	1
---	----	------	---

2-300-0118 Extra long breakoff screws - 2-3/8" (60 mm) (2 each)	NF	1.70	2
---	----	------	---

2-649-0137 Retaining cup Can be used with 45PN, 47PN, and 47RN	NF	8.95	1
---	----	------	---

Fixed Cylinder - Mortise Cylinder	Finish	2018 List	Box Qty.
-----------------------------------	--------	-----------	----------

3902 Fixed Cylinder Mortise Cylinder 6-Pin Cylinder, 5-Pin Keyed, 7-Pin Cylinder (Hager Keyway Only) Schlage C Keyway or Hager Keyways - Keyed Different Standard Specify 1-1/8" (29 mm), 1-1/4" (32 mm) or 1-5/8" (41 mm) Shipped with standard cam attached and Adams Rite cam loose in box; specify if different. Specify Schlage L cam when ordering cylinders for use in Hager mortise locks.	US3 US4 US10 US10B US26 US26D	48.50 51.55 51.55 48.50 48.50 48.50	1
---	--	--	---

3904 Mortise Dummy Specify 1-1/8" (29 mm) or 1-1/4" (32 mm)	US3 US4 US10 US10B US26 US26D	40.00 42.50 42.50 40.00 40.00 40.00	1
--	--	--	---

3905 Mortise ADA Turn Knob Specify 1-1/8" (29 mm) or 1-1/4" (32 mm) Shipped with Schlage L cam attached, specify if different.	US3 US10B US26D	69.95 69.95 69.95	1
--	-----------------------	-------------------------	---

Fixed Cylinder - Mortise Cylinder Cams	Finish	2018 List	Box Qty.
--	--------	-----------	----------

3971 Yale Cam .722" (18 mm)	US2C	3.70 ea.	10
--	------	----------	----

3972 Adams Rite Cam .560" (14 mm) Shipped Loose in box w/ standard 3902	US2C	3.70 ea.	10
---	------	----------	----

3973 Standard Cloverleaf .741" (19 mm)	US2C	3.70 ea.	10
---	------	----------	----

3974 Marks Cam R.755" (19 mm)	US2C	3.70 ea.	10
--	------	----------	----



Locks - Cylinders/Keying



Fixed Cylinder - Mortise Cylinder Cams			
Description	Finish	2018 List	Box Qty.
3975 Standard Cam R.723" (18 mm) Shipped standard w/ 3902	US2C	3.70 ea.	10
3976 Schlage L Cam .637" (16 mm) For use w/ all keyed function 3800 Series Mortise Locks.	US2C	3.70 ea.	10
3977 Sargent/Yale Cam .733" (18.6 mm)	US2C	3.70 ea.	10
3978 Corbin Russwin/Best Cloverleaf Cam .725" (18.5 mm)	US2C	3.70 ea.	10
Small Format Interchangeable Core - Keying Charges/Cores			
Description	Finish	2018 List	
3981-U Uncombined Core 6-Pin (includes two key blanks), specify US4 or US26D		41.90	
3982-U or 3909 (Hager SFIC Only) Uncombined Core 7-Pin (includes two key blanks), specify US4 or US26D		41.90	
3981-C Combined Core 6-Pin (includes two operating keys), specify US4, US26D. Specify KA*, KD*, MK**. Specify number of control keys needed.		51.20	
3982-C or 3969 (Hager SFIC Only) Combined Core 7-Pin (includes two operating keys), specify US4, US26D. Specify KA*, KD*, MK**. Specify number of control keys needed.		51.20	
3981-BLU or RED (Best A) Construction Core 6-Pin (includes two operating keys). Specify number of control keys. Two control keys provided as a default.		51.20	
3982-BLU or RED (Best A) Construction Core 7-Pin (includes two operating keys). Specify number of control keys. Two control keys provided as a default.		51.20	
Key Markings: Standard key symbols (AA1) - Visual Key Control (VKC)		N/C	
Key Markings: Non-standard code - Visual Key Control (VKC)		6.05	
Custom Cylinder Markings/Concealed Key Control (CKC) - limited to 6 characters		6.05	
3984 Cut Keys - Control Keys, Extra change keys, or Master Keys		6.35	
3908 Cut Keys (Hager Keyway Only) - Control Keys, Extra change keys, or Master Keys		6.35	
3998 Bitting list (no charge if ordered with master key) - Factory keyed		175.00	
Bitting list - Hager designed system - Keyed by others		175.00	



Small Format Interchangeable Core - Keying Charges/Cores	Finish	2018 List
--	--------	-----------

Description

*Allow 7 working days for KD and KA orders
 ** Allow 20 working days for factory master key orders.

Notes:

1. Lock price includes keying charges.
2. Cores are supplied Best A keyed different unless otherwise specified.
3. Please include Master Key Instruction Sheet with order, available online or in catalog. Failure to provide will delay order.
4. Construction Cores - Receive full credit, less shipping, of original cost upon return of cores and keys.



Small Format Interchangeable Core - Keys	Finish	2018 List	Box Qty.
--	--------	-----------	----------

3983 Small Format Interchangeable Core Key Blanks Best Keyways Used with 6-pin and 7-pin cores	NF	2.20	50
--	----	------	----

3984 Small Format Interchangeable Core Cut Key Best Keyways Used with 6-pin and 7-pin cores	NF	6.35	50
---	----	------	----

2-639-7168 SFIC 6-pin "BLUE" Construction Control Key Best A Keyway	NF	6.35	1
--	----	------	---

2-639-7169 SFIC 7-pin "BLUE" Construction Control Key Best A Keyway	NF	6.35	1
--	----	------	---

2-639-7113 SFIC 6-pin "RED" Construction Control Key Best A Keyway	NF	6.35	1
---	----	------	---

2-639-7170 SFIC 7-pin "RED" Construction Control Key Best A Keyway	NF	6.35	1
---	----	------	---



3907 Small Format Interchangeable Core Key Blanks Hager Keyways (7-pin cores only)	NF	2.20	50
---	----	------	----



3908 Small Format Interchangeable Core Cut Key Hager Keyways (7-pin cores only)	NF	6.35	50
--	----	------	----

Small Format Interchangeable Core - Tailpieces	Finish	2018 List	Box Qty.
--	--------	-----------	----------

2-639-7060 Pack of 10 tailpieces and compression springs for use with 2500/3500 Series SFIC lever locksets. 6-pin/7-pin cores	NF	13.55	10
--	----	-------	----



Locks - Cylinders/Keying



Small Format Interchangeable Core - Tailpieces

Description	Finish	2018 List	Box Qty.
2-639-7061 Pack of 10 tailpieces and compression springs for use with 3400/3500 Series SFIC knob locksets. 6-pin/7-pin cores	NF	13.55	10
2-639-7090 Pack of 10 tailpieces and compression springs for use with 3753 interconnected lock SFIC lever locksets. 6-pin/7-pin cores	NF	13.55	10
2-639-7091 Pack of 10 tailpieces for use with 3114/3214 SFIC housing deadlock. 6-pin/7-pin cores	NF	13.55	10
2-639-7095 Pack of 10 tailpieces for use with 3115/3118/3215/3710DL/3753DL SFIC housing deadlock. 6-pin/7-pin cores	NF	13.55	10

Small Format Interchangeable Core - Rim Cylinder Housing

Description	Finish	2018 List	Box Qty.
3901 Rim Cylinder - Small Format Interchangeable Core Housing Specify 6-pin or 7-pin Supplied with long tailpiece standard, collar, mounting plate, and breakoff screws. Cores sold separately.	US3 US4 US10 US10B US26 US26D	48.50 51.55 51.55 48.50 48.50 48.50	1

Small Format Interchangeable Core - Mortise Cylinder Housing

Description	Finish	2018 List	Box Qty.
3902 Mortise Cylinder - Small Format Interchangeable Core Housing Specify length 1-1/4" (6-pin) or 1-3/8" (7-pin) or 1-5/8" for mortise exit devices. Shipped with standard cam attached and Adams Rite cam loose in box (specify if different). Cores sold separately. 1/4" blocking ring included. Specify Schlage L cam when ordering new cylinders for use in Hager mortise lock.	US3 US4 US10 US10B US26 US26D	48.50 51.55 51.55 48.50 48.50 48.50	1

Small Format Interchangeable Core - Mortise Cylinder Cams

Description	Finish	2018 List	Box Qty.
2-639-7082 Yale Standard Cam Shipped standard w/ 3902 Small Format Interchangeable Core (SFIC) Housing.	US2C	3.70 ea	10
2-639-7083 Adams Rite Cam Shipped loose in box w/ standard 3902 Small Format Interchangeable Core (SFIC) Housing.	US2C	3.70 ea	10
2-639-7084 Corbin/Best Cloverleaf Cam	US2C	3.70 ea	10





Small Format Interchangeable Core - Mortise Cylinder Cams			
Description	Finish	2018 List	Box Qty.

2-639-7085 Schlage 'L' Cam For use w/ all keyed functions on 3800 Series Mortise Locks and 46CE.	US2C	3.70 ea	10
---	------	---------	----

2-639-7086 Sargent Yale Cam	US2C	3.70 ea	10
---------------------------------------	------	---------	----

Large Format Interchangeable Core - Keying Charges/Cores		
Description	Finish	2018 List

3919-Z Zero Bitted Core 6-Pin (includes two key blanks), specify US4 or US26D		53.00
---	--	-------

3919-C Combinated Core 6-Pin (includes two change keys), specify US4 or US26D. Specify KA*, KD*, MK**. Specify number of control keys needed.		64.75
--	--	-------

3919-BLA (Schlage C) Construction Core 6-Pin (includes two operating keys). Specify number of control keys. Two control keys provided as a default.		64.75
---	--	-------

Key Markings: Standard key symbols (AA1) - Visual Key Control (VKC)		N/C
---	--	-----

Key Markings: Non-standard code - Visual Key Control (VKC)		6.05
--	--	------

Custom Cylinder Markings/Concealed Key Control (CKC) - limited to 6 characters		6.05
--	--	------

3998 Bitting list (no charge if ordered with master key) - Factory keyed		175.00
--	--	--------

Bitting list - Hager designed system - Keyed by others		175.00
--	--	--------

*Allow 7 working days for KD and KA orders

** Allow 20 working days for factory master key orders.

Notes:

1. Lock prices do not include keying charges.
2. Cores are available in Schlage C keyway only.
3. Please include Master Key Instruction Sheet with order, available online or in catalog. Failure to provide will delay order.
4. Construction Cores - Receive full credit, less shipping, of original cost upon return of cores and keys.

Large Format Interchangeable Core - Keys		
Description	Finish	2018 List

3956 LFIC Key Blanks Schlage C Keyway		2.20
--	--	------

3962 LFIC Cut Keys Schlage C Keyway		6.35
--	--	------

2-639-7649 LFIC Control Key Blanks Schlage C Keyway		2.20
--	--	------



Locks - Cylinders/Keying

Large Format Interchangeable Core - Keys

Description	Finish	2018 List
3963 LFIC Control Cut Keys Schlage C Keyway		6.35
2-639-7132 LFIC 6-Pin "Black" Construction Control Key Schlage C Keyway		6.35



Large Format Interchangeable Core - Tailpieces

Description	Finish	2018 List	Box Qty.
2-639-7645 For use with 3450, 3480, and 3482 LFIC lever locksets		2.45	1
2-639-7646 For use with 3470 LFIC lever locksets		2.45	1
2-639-7647 For use with 3473 and 3495 LFIC lever locksets		2.45	1



Large Format Interchangeable Core - Rim Cylinder Housing

Description	Finish	2018 List	Box Qty.
3901 Rim Cylinder - Large Format Interchangeable Core Housing Supplied with tailpiece, collar, mounting plate, and breakoff screws. 6-Pin Only Cores sold separately.	US3	48.50	1
	US4	51.55	
	US10	51.55	
	US10B	48.50	
	US26	48.50	
	US26D	48.50	



LFIC - Rim Cylinder Accessories

Description	Finish	2018 List	Box Qty.
2-639-7578 Breakoff Tailpiece Assembly	NF	3.00	1
2-300-0175 Breakoff Screws - 2-1/8" (54mm) (2each)	NF	1.70	2



Large Format Interchangeable Core - Mortise Cylinder Housing

Description	Finish	2018 List	Box Qty.
3902 Mortise Cylinder - Large Format Interchangeable Core Housing 1-1/2" Length Shipped with standard cam attached and Adams Rite cam loose in box (specify if different). Cores sold separately. Specify Schlage L cam when ordering cylinders for use in Hager mortise locks.	US3	48.50	1
	US4	51.55	
	US10	51.55	
	US10B	48.50	
	US26	48.50	
	US26D	48.50	



Large Format Interchangeable Core - Mortise Cylinder Cams			
Description	Finish	2018 List	Box Qty.
2-639-7570 Yale Standard Cam Shipped standard w/ 3902 Large Format Interchangeable Core (LFIC) Housing.	US2C	3.90 ea	1
2-639-7571 Adams Rite Cam Shipped loose in box w/ standard 3902 Large Format Interchangeable Core (LFIC) Housing.	US2C	3.90 ea	1
2-639-7572 Schlage `L' Cam For use w/ all keyed functions on 3800 Series Mortise Locks and 46CE.	US2C	3.90 ea	1
2-639-7573 Corbin/Best Cloverleaf Cam	US2C	3.90 ea	1
2-639-7574 Sargent/Yale Cam	US2C	3.90 ea	1
Miscellaneous			
Description	Finish	2018 List	Box Qty.
3911 2500/3400 Series Lever Thru-Bolt Jig - Steel	NF	18.75	ea
3912 3500 Series Lever Thru-Bolt Jig - Steel	NF	18.75	ea
3959 Faceplate Adaptor Can be used with a 2-3/8" backset on the 2500, 3500, 3600, and 3700 Series lockset and 3200 Series deadlocks. Converts 1" (25 mm) to 1-1/8" (29 mm) width.	NF	2.65	ea
3968 Aluminum Blocking Rings Sizes available 1/8" (3.2 mm), 3/16" (4.8 mm), 1/4" (6.4 mm), 5/16" (7.9 mm), 3/8" (9.5 mm), 1/2" (12.5 mm)	BGA CLR DBA US10	5.85 5.85 5.85 5.85	ea
3968 Aluminum Blocking Rings Sizes available 1/8" (3.2 mm), 1/4" (6.4 mm),	US3 US4 US10B US26 US26D	5.85 5.85 5.85 5.85 5.85	
3979 Mortise Cam Screws - Fixed Cylinder Mortise Cylinder Only	NF	0.35	each



Locks - Cylinders/Keying



Miscellaneous Description	Finish	2018 List	Box Qty.
3980 Cash Box Nut	NF	8.40	each

2-639-7680 Mortise Cam Screws - SFIC Mortise Cylinder Only	NF	0.35	each
--	----	------	------

Cylinder Collars Description	Finish	2018 List	Box Qty.
2-647-0012 Cylinder Collar - 7/8" projection	US3	19.10	each
2-647-0013 Cylinder Collar - 7/8" projection	ALM	19.10	each
2-647-0014 Cylinder Collar - 7/8" projection	DBZ	19.10	each
2-647-0015 Cylinder Collar - 7/8" projection	US15 / US32D	19.10	each
2-647-0016 Cylinder Collar - 7/8" projection	US4	19.10	each
2-647-0017 Cylinder Collar - 7/8" projection	US10	19.10	each
2-647-0018 Cylinder Collar - 7/8" projection	US10B	19.10	each
2-647-0019 Cylinder Collar - 7/8" projection	US26	19.10	each
2-647-0020 Cylinder Collar - 7/8" projection	US26D	19.10	each

Above cylinder collars can be used with 4700 Series exit device trim and 1-1/8" - 1-3/8" long mortise cylinders.

2-649-0045 Cylinder Collar - 7/16" projection	US3	19.10	each
2-649-0046 Cylinder Collar - 7/16" projection	US4	19.10	each
2-649-0047 Cylinder Collar - 7/16" projection	US10	19.10	each
2-649-0048 Cylinder Collar - 7/16" projection	US10B	19.10	each
2-649-0050 Cylinder Collar - 7/16" projection	US26	19.10	each
2-649-0051 Cylinder Collar - 7/16" projection	US26D	19.10	each
2-649-0052 Cylinder Collar - 7/16" projection	US15 / US32D	19.10	each

Above cylinder collars can be used with 4500 Series exit device trim and 1-1/8" long mortise cylinders.





Cylinder Collars	Finish	2018 List	Box Qty.
2-649-0053 Cylinder Collar - 11/16" projection	US3	19.10	each
2-649-0054 Cylinder Collar - 11/16" projection	US4	19.10	each
2-649-0055 Cylinder Collar - 11/16" projection	US10	19.10	each
2-649-0056 Cylinder Collar - 11/16" projection	US10B	19.10	each
2-649-0057 Cylinder Collar - 11/16" projection	US26	19.10	each
2-649-0058 Cylinder Collar - 11/16" projection	US26D	19.10	each
2-649-0059 Cylinder Collar - 11/16" projection	US15 / US32D	19.10	each

Above cylinder collars can be used with 4500 Series exit device trim and 1-1/4" or 1-3/8" long mortise cylinders.

Cylinder Parts	Finish	2018 List
2-650-3998 SFIC Capping Strip		59.00/ per 50
2-639-7511 Pin Kit 100 each of all pins and springs, additional top pins. Please note that pin kit does NOT include SFIC caps.		345.00
2-639-7512 Cylinder Lubricant		50.00
2-639-7513 Shims Opens a locked conventional cylinder (at the workbench).		49.50/ per 100
2-639-7517 Construction Ball Used for lost ball construction keying. (#6 increment)		55.00/ per 1,000
2-639-7518 Cylinder Spring Pin tumbler spring for use in all cylinders.		6.60/ per 100
2-639-7519 Cap Pin Spring Key-in-Knob/Lever cylinders including Retrofit, and Full Size (Schlage Retrofit) Interchangeable Core.		15.00/ per 100
2-639-7520 Individual SFIC Cap For use with the individual capping block tool #6.		9.00/ per 100
2-639-7522 Profile Cylinder Set Screws Caps the profile cylinder chambers		7.00/ per 10
2-639-7523 Hager Screw Cap - (.280") height		15.00/ per 10



Locks - Cylinders/Keying

Cylinder Parts Description	Finish	2018 List
2-639-7524 Retrofit Screw Cap - (.230") height For use in competitor cylinders with thinner tailpiece driver		15.00/ per 10
2-639-7526 Screw Cap Pin (KIK / LFIC)		15.00/ per 100
2-639-7527 Follower (KIK) Holds top pins in place during assembly or disassembly		19.00
2-639-7528 Tweezers		38.00
2-639-7530 Capping Punch		57.00
2-639-7531 Decombinating Block (punch included)		175.00
2-639-7532 Manual Capping Block (punch included) (140 Spacing)		218.90
2-639-7535 Key Punch (140 Spacing)		3,540.00
2-639-7536 HPC 1200 Series Code Card (140 Spacing)		38.50
2-639-7537 Block and Punch Set (140 Spacing) Toolset must be purchased in order to cap Hager H1, H2, or H3 Keyway SFIC cores with Hager capping press (2-639-7534)		274.00



Top Pins (sold in multiples of 100)	2018 List
Description	
2-639-8188 #2 (0.025")	6.65/ per 100
2-639-8189 #3 (0.037")	6.65/ per 100
2-639-8190 #4 (0.050")	6.65/ per 100
2-639-8191 #5 (0.062")	6.65/ per 100
2-639-8192 #6 (0.075")	6.65/ per 100
2-639-8193 #7 (0.087")	6.65/ per 100
2-639-8194 #8 (0.100")	6.65/ per 100
2-639-8195 #9 (0.112")	6.65/ per 100
2-639-8196 #10 (0.125")	6.65/ per 100
2-639-8197 #11 (0.137")	6.65/ per 100
2-639-8198 #12 (0.150")	6.65/ per 100
2-639-8199 #13 (0.162")	6.65/ per 100
2-639-8200 #14 (0.175")	6.65/ per 100
2-639-8201 #15 (0.187")	6.65/ per 100
2-639-8202 #16 (0.200")	6.65/ per 100
2-639-8203 #17 (0.212")	6.65/ per 100
2-639-8204 #18 (0.225")	6.65/ per 100
2-639-8205 #19 (0.237")	6.65/ per 100



Locks - Full Bottom Pins

Full Bottom Pins (sold in multiples of 100) Description	2018 List
2-639-8210 #0 (0.185")	6.65/ per 100
2-639-8211 #1 (0.1975")	6.65/ per 100
2-639-8212 #2 (0.210")	6.65/ per 100
2-639-8213 #3 (0.2225")	6.65/ per 100
2-639-8214 #4 (0.2350")	6.65/ per 100
2-639-8215 #5 (0.2475")	6.65/ per 100
2-639-8216 #6 (0.2600")	6.65/ per 100
2-639-8217 #7 (0.2725")	6.65/ per 100
2-639-8218 #8 (0.2850")	6.65/ per 100
2-639-8219 #9 (0.2975")	6.65/ per 100



SFIC Bottom Pins (sold in multiples of 100) Description	2018 List
2-639-8220 #0 (0.110")	6.65/ per 100
2-639-8221 #1 (0.122")	6.65/ per 100
2-639-8222 #2 (0.135")	6.65/ per 100
2-639-8223 #3 (0.147")	6.65/ per 100
2-639-8224 #4 (0.160")	6.65/ per 100
2-639-8225 #5 (0.172")	6.65/ per 100
2-639-8226 #6 (0.185")	6.65/ per 100
2-639-8227 #7 (0.197")	6.65/ per 100
2-639-8228 #8 (0.210")	6.65/ per 100
2-639-8229 #9 (0.222")	6.65/ per 100



2310

2310 2-3/8" US15 JOS	174156
2310 2-3/8" 26D CHA	173293
2310 2 3/4" US10B JOS	169469
2310 2 3/4" US10B JHN	169738
2310 2 3/4" US10B WRN	169741
2310 2 3/4" US10B LOU	169744
2310 2 3/4" US10B CHA	169747
2310 2 3/4" US15 JOS	169686
2310 2 3/4" US15 JHN	169701
2310 2 3/4" US15 WRN	169709
2310 2 3/4" US15 LOU	169716
2310 2 3/4" US15 CHA	169722
2310 2 3/4" US26 JOS	169698
2310 2 3/4" US26 JHN	169737
2310 2 3/4" US26 WRN	169740
2310 2 3/4" US26 LOU	169743
2310 2 3/4" US26 CHA	169746
2310 2 3/4" US26D JOS	169453
2310 2 3/4" US26D JHN	169453
2310 2 3/4" US26D JOS	169453
2310 2 3/4" US26D JHN	169617
2310 2 3/4" US26D WRN	169622
2310 2 3/4" US26D LOU	169628
2310 2 3/4" US26D CHA	169631
2310 2 3/4" US3 JOS	169689
2310 2 3/4" US3 JHN	169704
2310 2 3/4" US3 WRN	169712
2310 2 3/4" US3 LOU	169718
2310 2 3/4" US3 CHA	169724
2310 2 3/4" US4 JOS	169695
2310 2 3/4" US4 JHN	169735
2310 2 3/4" US4 WRN	169739
2310 2 3/4" US4 LOU	169742
2310 2 3/4" US4 CHA	169745

2317

2317 US10B JOS	169754
2317 US10B JHN HL	171905
2317 US10B JHN RH	171906
2317 US10B WRN LH	171917
2317 US10B WRN RH	171918
2317 US10B LOU	169772
2317 US10B CHA	169778
2317 US15 JOS	169748
2317 US15 JHN LH	171895
2317 US15 JHN RH	171896
2317 US15 WRN LH	171909
2317 US15 WRN RH	171910
2317 US15 LOU	169768
2317 US15 CHA	169774
2317 US10B JOS	169753
2317 US26 JHN LH	171902
2317 US26 JHN RH	171903
2317 US26 WRN LH	171915
2317 US26 WRN RH	171916
2317 US26 LOU	169771

2317

2317 US26 CHA	169777
2317 US26D JOS	167921
2317 US26D JHN LH	171893
2317 US26D JHN RH	171894
2317 US26D WRN LH	171907
2317 US26D WRN RH	171908
2317 US26D LOU	169767
2317 US26D CHA	169773
2317 US3 JOS	169751
2317 US3 JHN LH	171897
2317 US3 JHN RH	171898
2317 US3 WRN LH	171911
2317 US3 WRN RH	171912
2317 US3 LOU	169769
2317 US3 CHA	169775
2317 US4 LOU	169770
2317 US4 CHA	169776
2317 US4 JOS	169752
2317 US4 JHN LH	171900
2317 US4 JHN RH	171901
2317 US4 WRN LH	171913
2317 US4 WRN RH	171914

2340

2340 2-3/8" US15 JOS	174157
2340 2-3/8" 26D JOS	175754
2340 2-3/8" 26D CHA	173294
2340 2 3/4" US10B JOS	169471
2340 2 3/4" US10B JHN	169819
2340 2 3/4" US10B WRN	169822
2340 2 3/4" US10B LOU	169825
2340 2 3/4" US10B CHA	169828
2340 2 3/4" US15 JOS	169688
2340 2 3/4" US15 JHN	169703
2340 2 3/4" US15 WRN	169711
2340 2 3/4" US15 LOU	169730
2340 2 3/4" US15 CHA	169732
2340 2 3/4" US26 JOS	169700
2340 2 3/4" US26 JHN	169818
2340 2 3/4" US26 WRN	169821
2340 2 3/4" US26 LOU	169824
2340 2 3/4" US26 CHA	169827
2340 2 3/4" US26D JOS	169455
2340 2 3/4" US26D JHN	169455
2340 2 3/4" US26D JHN	169619
2340 2 3/4" US26D WRN	169682
2340 2 3/4" US26D LOU	169729
2340 2 3/4" US26D CHA	169733
2340 2 3/4" US3 JOS	169694
2340 2 3/4" US3 JHN	169706
2340 2 3/4" US3 WRN	169728
2340 2 3/4" US3 LOU	169731
2340 2 3/4" US3 CHA	169734
2340 2 3/4" US4 JOS	169697
2340 2 3/4" US4 JHN	169817
2340 2 3/4" US4 WRN	169820

Items with the price in **bold and red** are Quick Ship Items and ship in 24 hours.

2340

2340 2 3/4" US4 LOU	169823
2340 2 3/4" US4 CHA	169826

2510

2510 2-3/8" US10B ARC ASA	143873
2510 2-3/8" US10B WTN ASA	147186
2510 2-3/8" US26D ARC ASA	134474
2510 2-3/8" US26D WTN ASA	136277
2510 2-3/8" US3 WTN ASA	137318
2510 2-3/4" US10B ARC ASA	128993
2510 2-3/4" US10B WTN ASA	129000
2510 2-3/4" US26D ARC ASA	129001
2510 2-3/4" US26D WTN ASA	129002
2510 2-3/4" US3 ARC ASA	129003
2510 2-3/4" US3 WTN ASA	129004

2517

2517 US10B ARC	130785
2517 US10B WTN	130786
2517 US10B WTN	130786
2517 US10B WTN	130786
2517 US26D ARC	130787
2517 US26D WTN	130788
2517 US26D WTN	130788
2517 US3 ARC	130789
2517 US3 WTN	130790

2525

2525 2-3/8" US10B ARC ASA	176278
2525 2-3/8" US26D ARC ASA	156965
2525 2-3/8" US26D WTN ASA	147316
2525 2-3/8" US3 WTN ASA	167674
2525 2-3/4" US10B ARC ASA	129012
2525 2-3/4" US10B WTN ASA	129013
2525 2-3/4" US26D ARC ASA	129016
2525 2-3/4" US26D WTN ASA	129017
2525 2-3/4" US3 ARC ASA	129018
2525 2-3/4" US3 WTN ASA	129020

2540

2540 2-3/8" US10B ARC ASA	135767
2540 2-3/8" US10B WTN ASA	147189
2540 2-3/8" US26D ARC ASA	134473
2540 2-3/8" US26D WTN ASA	144640
2540 2-3/8" US3 WTN ASA	137317
2540 2-3/4" US10B ARC ASA	129021
2540 2-3/4" US10B WTN ASA	129022
2540 2-3/4" US26D ARC ASA	129023
2540 2-3/4" US26D WTN ASA	129024
2540 2-3/4" US3 ARC ASA	129025
2540 2-3/4" US3 WTN ASA	129026

2550

2550 2-3/8" US26D ARC SCC KD ASA	150263
2550 2-3/8" US26D WTN SCC KD ASA	148604
2550 2-3/4" US10B ARC SCC KD ASA	129637
2550 2-3/4" US10B WTN SCC KD ASA	129638
2550 2-3/4" US26D ARC SCC KD ASA	129639

2550

2550 2-3/4" US26D WTN SCC KD ASA	129642
2550 2-3/4" US26D WTN SCC KD ASA	129642
2550 2-3/4" US3 ARC SCC KD ASA	129643
2550 2-3/4" US3 WTN SCC KA ASA	134149
2550 2-3/4" US3 WTN SCC KD ASA	129644

2553

2553 2-3/8" US10B ARC SCC KA ASA	135787
2553 2-3/8" US10B ARC SCC KD ASA	140478
2553 2-3/8" US10B WTN SCC KD ASA	160465
2553 2-3/8" US26D ARC SCC KD ASA	134768
2553 2-3/8" US26D WTN SCC KD ASA	136279
2553 2-3/8" US3 ARC SCC KD ASA	163970
2553 2-3/8" US3 WTN SCC KD ASA	150220
2553 2-3/4" US10B ARC SCC KD ASA	129645
2553 2-3/4" US10B WTN SCC KD ASA	129646
2553 2-3/4" US26D ARC SCC KD ASA	129647
2553 2-3/4" US26D WTN SCC KD ASA	129648
2553 2-3/4" US3 ARC SCC KD ASA	129649
2553 2-3/4" US3 WTN SCC KD ASA	129650
2553 2-3/4" US3/US26D WTN SCC KD ASA	152111

2570

2570 2-3/8" US10B WTN SCC KD ASA	164364
2570 2-3/8" US26D WTN SCC KD ASA	143635
2570 2-3/8" US3 WTN SCC KD ASA	170761
2570 2-3/4" US10B ARC SCC KD ASA	129651
2570 2-3/4" US10B WTN SCC KD ASA	129652
2570 2-3/4" US26D ARC SCC KD ASA	129653
2570 2-3/4" US26D WTN SCC KD ASA	129654
2570 2-3/4" US3 ARC SCC KD ASA	129655
2570 2-3/4" US3 WTN SCC KD ASA	129656

2580

2580 2-3/8" US10B WTN SCC KD ASA	151209
2580 2-3/8" US26D WTN SCC KD ASA	132617
2580 2-3/4" US10B ARC SCC KD ASA	129657
2580 2-3/4" US10B WTN SCC KD ASA	129658
2580 2-3/4" US26D ARC SCC KD ASA	129659
2580 2-3/4" US26D WTN SCC KD ASA	129660
2580 2-3/4" US3 ARC SCC KD ASA	129661
2580 2-3/4" US3 WTN SCC KD ASA	129662

3114

3114 2-3/4" US10 NC IC034812
3114 2-3/4" US10 SCC KD012596
3114 2-3/4" US10B NC IC034811
3114 2-3/4" US10B SCC KD012597
3114 2-3/4" US26 NC IC034810
3114 2-3/4" US26 SCC KD028119
3114 2-3/4" US26D NC IC	034807
3114 2-3/4" US26D SCC KD	028118
3114 2-3/4" US3 NC IC034815
3114 2-3/4" US3 SCC KD012594
3114 2-3/4" US4 NC IC034814
3114 2-3/4" US4 SCC KD012595

Items with the price in **bold and red** are Quick Ship Items and ship in 24 hours.



3115		3215	
3115 2-3/4" US10 NC IC	.040420	3215 2-3/4" US10B SCC KD	012652
3115 2-3/4" US10 SCC KD	.012588	3215 2-3/8" US26D NC IC	.046832
3115 2-3/4" US10B NC IC	.040418	3215 2-3/8" US26D SCC KD	.065836
3115 2-3/4" US10B SCC KD	.012592	3215 2-3/4" US26D NC IC	098280
3115 2-3/4" US26 NC IC	.040449	3215 2-3/4" US26D SCC KD	098341
3115 2-3/4" US26 SCC KD	.028121	3215 2-3/8" US3 NC IC	.005743
3115 2-3/4" US26D NC IC	098283	3215 2-3/8" US3 SCC KD	.096177
3115 2-3/4" US26D SCC KD	028120	3215 2-3/4" US3 NC IC	.084949
3115 2-3/4" US3 NC IC	.040425	3215 2-3/4" US3 SCC KD	.012655
3115 2-3/4" US3 SCC KD	.012590	3215 2-3/8" US32 SCC KD	.140554
3115 2-3/4" US4 NC IC	.050868	3215 2-3/4" US32 NC IC	.038839
3115 2-3/4" US4 SCC KD	.012589	3215 2-3/4" US32 SCC KD	.012656
3118		3215 2-3/8" US32D NC IC	.031595
3118 2-3/4" US10 NC IC	.038894	3215 2-3/8" US32D SCC KD	.097015
3118 2-3/4" US10 SCC KD	.028133	3215 2-3/4" US32D NC IC	.098220
3118 2-3/4" US10B NC IC	.038887	3215 2-3/4" US32D SCC KD	012657
3118 2-3/4" US10B SCC KD	.050113	3215 2-3/8" US4 NC IC	.108489
3118 2-3/4" US26 NC IC	.039335	3215 2-3/8" US4 SCC KD	.067222
3118 2-3/4" US26 SCC KD	.028126	3215 2-3/4" US4 NC IC	.038847
3118 2-3/4" US26D NC IC	098282	3215 2-3/4" US4 SCC KD	.012654
3118 2-3/4" US26D SCC KD	028123	3216	
3118 2-3/4" US3 NC IC	.038920	3216 ADJ US10	.143039
3118 2-3/4" US3 SCC KD	.028129	3216 ADJ US10B	.143040
3118 2-3/4" US4 NC IC	.038899	3216 ADJ US26D	143041
3118 2-3/4" US4 SCC KD	.028131	3216 ADJ US3	.143037
3214		3216 ADJ US32	.143042
3214 2-3/8" US10 SCC KD	.099243	3216 ADJ US32D	.143043
3214 2-3/4" US10 NC IC	.034800	3216 ADJ US4	.143038
3214 2-3/4" US10 SCC KD	.012650	3220	
3214 2-3/8" US10B SCC KD	.058093	3220 ADJ US10	.111391
3214 2-3/4" US10B NC IC	.034769	3220 ADJ US10B	.111392
3214 2-3/4" US10B SCC KD	.012651	3220 ADJ US26D	118136
3214 2-3/8" US26D SCC KD	.113487	3220 ADJ US3	.111393
3214 2-3/4" US26D NC IC	.034759	3220 ADJ US32	.111394
3214 2-3/4" US26D SCC KD	098342	3220 ADJ US32D	.111395
3214 2-3/8" US3 SCC KD	.044086	3220 ADJ US4	.111396
3214 2-3/4" US3 NC IC	.034803	3221	
3214 2-3/4" US3 SCC KD	.012647	3221 ADJ US10	.111825
3214 2-3/4" US32 NC IC	.034758	3221 ADJ US10B	.111832
3214 2-3/4" US32 SCC KD	.012646	3221 ADJ US26D	.118140
3214 2-3/8" US32D SCC KD	.096051	3221 ADJ US3	.111833
3214 2-3/4" US32D NC IC	.034749	3221 ADJ US32	.111834
3214 2-3/4" US32D SCC KD	012645	3221 ADJ US32D	.111835
3214 2-3/8" US4 SCC KD	.130567	3221 ADJ US4	.111837
3214 2-3/4" US4 NC IC	.034801	3222	
3214 2-3/4" US4 SCC KD	.012649	3222 ADJ US10	.111415
3215		3222 ADJ US10B	.111416
3215 2-3/8" US10 NC IC	.136009	3222 ADJ US26D	.118139
3215 2-3/8" US10 SCC KD	.054763	3222 ADJ US3	.111417
3215 2-3/4" US10 NC IC	.048992	3222 ADJ US32	.111418
3215 2-3/4" US10 SCC KD	.012653	3222 ADJ US32D	.111419
3215 2-3/8" US10B NC IC	.007223	3222 ADJ US4	.111421
3215 2-3/8" US10B SCC KD	.097759		
3215 2-3/4" US10B NC IC	.038848		

Items with the price in **bold and red** are Quick Ship Items and ship in 24 hours.

3410

3410 2-3/4" US10 ARC ASA012557
3410 2-3/4" US10 AUG ASA041178
3410 2-3/4" US10 WTN ASA012548
3410 2-3/4" US10B ARC ASA012560
3410 2-3/4" US10B AUG ASA041148
3410 2-3/4" US10B WTN ASA012549
3410 2-3/4" US26 ARC ASA012553
3410 2-3/4" US26 AUG ASA041141
3410 2-3/4" US26 WTN ASA012526
3410 2-3/4" US26D ARC ASA012550
3410 2-3/4" US26D AUG ASA041139
3410 2-3/4" US26D WTN ASA012525
3410 2-3/4" US3 ARC ASA012554
3410 2-3/4" US3 APL ASA012520
3410 2-3/4" US3 AUG ASA041082
3410 2-3/4" US3 WTN ASA012528
3410 2-3/4" US32D APL ASA012524
3410 2-3/4" US4 ARC ASA012555
3410 2-3/4" US4 AUG ASA040960
3410 2-3/4" US4 WTN ASA012530

3417

3417 US10 ARC012576
3417 US10 AUG028522
3417 US10 WTN012569
3417 US10B ARC012577
3417 US10B AUG028542
3417 US10B WTN012570
3417 US26 ARC012572
3417 US26 AUG028516
3417 US26 WTN012566
3417 US26D ARC012571
3417 US26D AUG028530
3417 US26D WTN012563
3417 US3 ARC012573
3417 US3 APL012561
3417 US3 AUG028515
3417 US3 WTN012567
3417 US32D APL012562
3417 US4 ARC012575
3417 US4 AUG028529
3417 US4 WTN012568

3440

3440 2-3/4" US10 ARC ASA012518
3440 2-3/4" US10 AUG ASA040751
3440 2-3/4" US10 WTN ASA012509
3440 2-3/4" US10B ARC ASA012519
3440 2-3/4" US10B AUG ASA040748
3440 2-3/4" US10B WTN ASA012510
3440 2-3/4" US26 ARC ASA012515
3440 2-3/4" US26 AUG ASA040718
3440 2-3/4" US26 WTN ASA012504
3440 2-3/4" US26D ARC ASA012514
3440 2-3/4" US26D AUG ASA040658
3440 2-3/4" US26D WTN ASA012499
3440 2-3/4" US3 ARC ASA012516

3440

3440 2-3/4" US3 APL ASA012502
3440 2-3/4" US3 AUG ASA040639
3440 2-3/4" US3 WTN ASA012505
3440 2-3/4" US32D APL ASA012503
3440 2-3/4" US4 ARC ASA012517
3440 2-3/4" US4 AUG ASA040618
3440 2-3/4" US4 WTN ASA012508

3450

3450 2-3/4" US10 ARC NC ASA IC038099
3450 2-3/4" US10 ARC SCC KD ASA038133
3450 2-3/4" US10 AUG NC ASA IC024940
3450 2-3/4" US10 AUG SCC KD ASA028445
3450 2-3/4" US10 WTN NC ASA IC038088
3450 2-3/4" US10 WTN SCC KD ASA038127
3450 2-3/4" US10B ARC NC ASA IC038087
3450 2-3/4" US10B ARC SCC KD ASA038116
3450 2-3/4" US10B AUG NC ASA IC024141
3450 2-3/4" US10B AUG SCC KD ASA028440
3450 2-3/4" US10B WTN NC ASA IC038048
3450 2-3/4" US10B WTN SCC KD ASA038113
3450 2-3/4" US26 ARC NC ASA IC038824
3450 2-3/4" US26 ARC SCC KD ASA038170
3450 2-3/4" US26 AUG NC ASA IC024933
3450 2-3/4" US26 AUG SCC KD ASA028439
3450 2-3/4" US26 WTN NC ASA IC038823
3450 2-3/4" US26 WTN SCC KD ASA038169
3450 2-3/4" US26D ARC NC ASA IC098296
3450 2-3/4" US26D ARC SCC KD ASA098330
3450 2-3/4" US26D AUG NC ASA IC024987
3450 2-3/4" US26D AUG SCC KD ASA028481
3450 2-3/4" US26D WTN NC ASA IC098323
3450 2-3/4" US26D WTN SCC KD ASA098333
3450 2-3/4" US3 ARC NC ASA IC038539
3450 2-3/4" US3 ARC SCC KD ASA038167
3450 2-3/4" US3 AUG NC ASA IC024928
3450 2-3/4" US3 AUG SCC KD ASA028431
3450 2-3/4" US3 WTN NC ASA IC038293
3450 2-3/4" US3 WTN SCC KD ASA038140
3450 2-3/4" US4 ARC NC ASA IC038135
3450 2-3/4" US4 ARC SCC KD ASA038139
3450 2-3/4" US4 AUG NC ASA IC024949
3450 2-3/4" US4 AUG SCC KD ASA028446
3450 2-3/4" US4 WTN NC ASA IC038112
3450 2-3/4" US4 WTN SCC KD ASA038134

3453

3453 2-3/4" US10 ARC NC ASA IC037850
3453 2-3/4" US10 ARC SCC KD ASA012442
3453 2-3/4" US10 AUG NC ASA IC024866
3453 2-3/4" US10 AUG SCC KD ASA028404
3453 2-3/4" US10 WTN NC ASA IC037795
3453 2-3/4" US10 WTN SCC KD ASA012435
3453 2-3/4" US10B ARC NC ASA IC088953
3453 2-3/4" US10B ARC SCC KD ASA012443
3453 2-3/4" US10B AUG NC ASA IC024855
3453 2-3/4" US10B AUG SCC KD ASA028393

Items with the price in **bold and red** are Quick Ship Items and ship in 24 hours.



3453		3470	
3453 2-3/4" US10B WTN NC ASA IC037776	3470 2-3/4" US3 ARC SCC KD ASA012468
3453 2-3/4" US10B WTN SCC KD ASA	012437	3470 2-3/4" US3 AUG NC ASA IC024543
3453 2-3/4" US26 ARC NC ASA IC038229	3470 2-3/4" US3 AUG SCC KD ASA028324
3453 2-3/4" US26 ARC SCC KD ASA012439	3470 2-3/4" US3 WTN NC ASA IC037724
3453 2-3/4" US26 AUG NC ASA IC024761	3470 2-3/4" US3 WTN SCC KD ASA012454
3453 2-3/4" US26 AUG SCC KD ASA028391	3470 2-3/4" US4 ARC NC ASA IC037686
3453 2-3/4" US26 WTN NC ASA IC038044	3470 2-3/4" US4 ARC SCC KD ASA012470
3453 2-3/4" US26 WTN SCC KD ASA012429	3470 2-3/4" US4 AUG NC ASA IC024405
3453 2-3/4" US26D ARC NC ASA IC	098295	3470 2-3/4" US4 AUG SCC KD ASA028330
3453 2-3/4" US26D ARC SCC KD ASA	012438	3470 2-3/4" US4 WTN NC ASA IC037657
3453 2-3/4" US26D AUG NC ASA IC024713	3470 2-3/4" US4 WTN SCC KD ASA012455
3453 2-3/4" US26D AUG SCC KD ASA	028390	3470 2-3/4" US3 APL SCC KD ASA012445
3453 2-3/4" US26D WTN NC ASA IC	098322	3470 2-3/4" US32D APL NC ASA IC143141
3453 2-3/4" US26D WTN SCC KD ASA	012427	3470 2-3/4" US32D APL SCC KD ASA012447
3453 2-3/4" US3 ARC NC ASA IC038042	3473	
3453 2-3/4" US3 ARC SCC KD ASA012440	3473 2-3/4" US10 ARC NC ASA IC (REV1)138464
3453 2-3/4" US3 AUG NC ASA IC024712	3473 2-3/4" US10 ARC SCC KD ASA (REV1)138465
3453 2-3/4" US3 AUG SCC KD ASA028389	3473 2-3/4" US10 AUG NC ASA IC (REV1)138466
3453 2-3/4" US3 WTN NC ASA IC038040	3473 2-3/4" US10 AUG SCC KD ASA (REV1)138467
3453 2-3/4" US3 WTN SCC KD ASA012433	3473 2-3/4" US10 WTN NC ASA IC (REV1)138468
3453 2-3/4" US4 ARC NC ASA IC038018	3473 2-3/4" US10 WTN SCC KD ASA (REV1)138469
3453 2-3/4" US4 ARC SCC KD ASA012441	3473 2-3/4" US10B ARC NC ASA IC (REV1)138470
3453 2-3/4" US4 AUG NC ASA IC024616	3473 2-3/4" US10B ARC SCC KD ASA (REV1)138471
3453 2-3/4" US4 AUG SCC KD ASA028381	3473 2-3/4" US10B AUG NC ASA IC (REV1)138472
3453 2-3/4" US4 WTN NC ASA IC037886	3473 2-3/4" US10B AUG SCC KD ASA (REV1)138473
3453 2-3/4" US4 WTN SCC KD ASA012434	3473 2-3/4" US10B WTN NC ASA IC (REV1)138474
3453 2-3/4" US3 APL SCC KD ASA012423	3473 2-3/4" US10B WTN SCC KD ASA (REV1)138475
3453 2-3/4" US32D APL NC ASA IC060301	3473 2-3/4" US26 ARC NC ASA IC (REV1)138476
3453 2-3/4" US32D APL SCC KD ASA012425	3473 2-3/4" US26 ARC SCC KD ASA (REV1)138477
3470		3473 2-3/4" US26 AUG NC ASA IC (REV1)138478
3470 2-3/4" US10 ARC NC ASA IC037656	3473 2-3/4" US26 AUG SCC KD ASA (REV1)138479
3470 2-3/4" US10 ARC SCC KD ASA012473	3473 2-3/4" US26 WTN NC ASA IC (REV1)138480
3470 2-3/4" US10 AUG NC ASA IC024615	3473 2-3/4" US26 WTN SCC KD ASA (REV1)138481
3470 2-3/4" US10 AUG SCC KD ASA028346	3473 2-3/4" US26D ARC NC ASA IC (REV1)138482
3470 2-3/4" US10 WTN NC ASA IC037616	3473 2-3/4" US26D ARC SCC KD ASA (REV1)138485
3470 2-3/4" US10 WTN SCC KD ASA012458	3473 2-3/4" US26D AUG NC ASA IC (REV1)138487
3470 2-3/4" US10B ARC NC ASA IC037613	3473 2-3/4" US26D AUG SCC KD ASA (REV1)138488
3470 2-3/4" US10B ARC SCC KD ASA012474	3473 2-3/4" US26D WTN NC ASA IC (REV1)138489
3470 2-3/4" US10B AUG NC ASA IC024467	3473 2-3/4" US26D WTN SCC KD ASA (REV1)138490
3470 2-3/4" US10B AUG SCC KD ASA028344	3473 2-3/4" US3 ARC NC ASA IC (REV1)138491
3470 2-3/4" US10B WTN NC ASA IC037532	3473 2-3/4" US3 ARC SCC KD ASA (REV1)138492
3470 2-3/4" US10B WTN SCC KD ASA012462	3473 2-3/4" US3 AUG NC ASA IC (REV1)138493
3470 2-3/4" US26 ARC NC ASA IC038100	3473 2-3/4" US3 AUG SCC KD ASA (REV1)138494
3470 2-3/4" US26 ARC SCC KD ASA012467	3473 2-3/4" US3 WTN NC ASA IC (REV1)138495
3470 2-3/4" US26 AUG NC ASA IC024613	3473 2-3/4" US3 WTN SCC KD ASA (REV1)138496
3470 2-3/4" US26 AUG SCC KD ASA028343	3473 2-3/4" US4 ARC NC ASA IC (REV1)138497
3470 2-3/4" US26 WTN NC ASA IC037742	3473 2-3/4" US4 ARC SCC KD ASA (REV1)138498
3470 2-3/4" US26 WTN SCC KD ASA012453	3473 2-3/4" US4 AUG NC ASA IC (REV1)138499
3470 2-3/4" US26D ARC NC ASA IC098293	3473 2-3/4" US4 AUG SCC KD ASA (REV1)138500
3470 2-3/4" US26D ARC SCC KD ASA	012463	3473 2-3/4" US4 WTN NC ASA IC (REV1)138501
3470 2-3/4" US26D AUG NC ASA IC024554	3473 2-3/4" US4 WTN SCC KD ASA (REV1)138502
3470 2-3/4" US26D AUG SCC KD ASA	028339	3480	
3470 2-3/4" US26D WTN NC ASA IC	098321	3480 2-3/4" US10 ARC NC ASA IC037343
3470 2-3/4" US26D WTN SCC KD ASA	012451	3480 2-3/4" US10 ARC SCC KD ASA012495
3470 2-3/4" US3 ARC NC ASA IC037741	3480 2-3/4" US10 AUG NC ASA IC024368

Items with the price in **bold and red** are Quick Ship Items and ship in 24 hours.

3480

3480 2-3/4" US10 AUG SCC KD ASA028031
3480 2-3/4" US10 WTN NC ASA IC037330
3480 2-3/4" US10 WTN SCC KD ASA012483
3480 2-3/4" US10B ARC NC ASA IC037326
3480 2-3/4" US10B ARC SCC KD ASA012496
3480 2-3/4" US10B AUG NC ASA IC024348
3480 2-3/4" US10B AUG SCC KD ASA028017
3480 2-3/4" US10B WTN NC ASA IC037325
3480 2-3/4" US10B WTN SCC KD ASA012490
3480 2-3/4" US26 ARC NC ASA IC038085
3480 2-3/4" US26 ARC SCC KD ASA012492
3480 2-3/4" US26 AUG NC ASA IC024328
3480 2-3/4" US26 AUG SCC KD ASA027994
3480 2-3/4" US26 WTN NC ASA IC037531
3480 2-3/4" US26 WTN SCC KD ASA012479
3480 2-3/4" US26D ARC NC ASA IC	098292
3480 2 3/4 26D ARC SCC KD ASA	012491
3480 2-3/4" US26D AUG NC ASA IC024264
3480 2-3/4" US26D AUG SCC KD ASA	027993
3480 2-3/4" US26D WTN NC ASA IC	098651
3480 2-3/4" US26D WTN SCC KD ASA	012478
3480 2-3/4" US3 ARC NC ASA IC037516
3480 2-3/4" US3 ARC SCC KD ASA012493
3480 2-3/4" US3 AUG NC ASA IC024233
3480 2-3/4" US3 AUG SCC KD ASA027990
3480 2-3/4" US3 WTN NC ASA IC037444
3480 2-3/4" US3 WTN SCC KD ASA012481
3480 2-3/4" US4 ARC NC ASA IC037408
3480 2-3/4" US4 ARC SCC KD ASA012494
3480 2-3/4" US4 AUG NC ASA IC024187
3480 2-3/4" US4 AUG SCC KD ASA027988
3480 2-3/4" US4 WTN NC ASA IC037388
3480 2-3/4" US4 WTN SCC KD ASA012482
3480 2-3/4" US3 APL SCC KD ASA012475
3480 2-3/4" US32D APL NC ASA IC143142
3480 2-3/4" US32D APL SCC KD ASA012477

3495

3495 2-3/4" US10 ARC NC ASA IC006810
3495 2-3/4" US10 ARC SCC KD ASA007195
3495 2-3/4" US10 AUG NC ASA IC006739
3495 2-3/4" US10 AUG SCC KD ASA006847
3495 2-3/4" US10 WTN NC ASA IC006765
3495 2-3/4" US10 WTN SCC KD ASA007081
3495 2-3/4" US10B ARC NC ASA IC006803
3495 2-3/4" US10B ARC SCC KD ASA007192
3495 2-3/4" US10B AUG NC ASA IC006738
3495 2-3/4" US10B AUG SCC KD ASA006846
3495 2-3/4" US10B WTN NC ASA IC006758
3495 2-3/4" US10B WTN SCC KD ASA007074
3495 2-3/4" US26 ARC NC ASA IC006798
3495 2-3/4" US26 ARC SCC KD ASA007182
3495 2-3/4" US26 AUG NC ASA IC006735
3495 2-3/4" US26 AUG SCC KD ASA006841
3495 2-3/4" US26 WTN NC ASA IC006754
3495 2-3/4" US26 WTN SCC KD ASA007071

3495

3495 2-3/4" US26D ARC NC ASA IC006797
3495 2-3/4" US26D ARC SCC KD ASA007180
3495 2-3/4" US26D AUG NC ASA IC006705
3495 2-3/4" US26D AUG SCC KD ASA006840
3495 2-3/4" US26D WTN NC ASA IC006753
3495 2-3/4" US26D WTN SCC KD ASA	007070
3495 2-3/4" US3 ARC NC ASA IC007292
3495 2-3/4" US3 ARC SCC KD ASA007295
3495 2-3/4" US3 AUG NC ASA IC006745
3495 2-3/4" US3 AUG SCC KD ASA007063
3495 2-3/4" US3 WTN NC ASA IC006795
3495 2-3/4" US3 WTN SCC KD ASA007176
3495 2-3/4" US4 ARC NC ASA IC006819
3495 2-3/4" US4 ARC SCC KD ASA007199
3495 2-3/4" US4 AUG NC ASA IC006743
3495 2-3/4" US4 AUG SCC KD ASA006848
3495 2-3/4" US4 WTN NC ASA IC006792
3495 2-3/4" US4 WTN SCC KD ASA007170

3510

3510 2-3/4" US10 ARC ASA000319
3510 2-3/4" US10 AUG ASA038966
3510 2-3/4" US10 WTN ASA000261
3510 2-3/4" US10B ARC ASA	000320
3510 2-3/4" US10B AUG ASA	037082
3510 2-3/4" US10B WTN ASA	000262
3510 2-3/4" US26 ARC ASA000316
3510 2-3/4" US26 AUG ASA036933
3510 2-3/4" US26 WTN ASA000258
3510 2-3/4" US26D ARC ASA	000313
3510 2-3/4" US26D AUG ASA	036892
3510 2-3/4" US26D WTN ASA	000256
3510 2-3/4" US3 ARC ASA000317
3510 2-3/4" US3 AUG ASA036825
3510 2-3/4" US3 WTN ASA000259
3510 2-3/4" US4 ARC ASA000318
3510 2-3/4" US4 AUG ASA036813
3510 2-3/4" US4 WTN ASA000260
3510 2-3/4" US3 APL ASA091147
3510 2-3/4" US32D APL ASA	091148

3517

3517 US10 ARC000329
3517 US10 AUG027799
3517 US10 WTN000277
3517 US10B ARC111284
3517 US10B AUG111285
3517 US10B WTN111286
3517 US26 ARC000322
3517 US26 AUG027791
3517 US26 WTN111288
3517 US26D ARC	111289
3517 US26D AUG	111290
3517 US26D WTN	111291
3517 US3 ARC000323
3517 US3 AUG027775
3517 US3 WTN111294

Items with the price in **bold and red** are Quick Ship Items and ship in 24 hours.



3517

3517 US4 ARC	.000325
3517 US4 AUG	.027768
3517 US4 WTN	.000276
3517 US3 APL	.000102
3517 US32D APL	.000105

3525

3525 2-3/4" US10 ARC ASA	.095545
3525 2-3/4" US10 AUG ASA	.038501
3525 2-3/4" US10 WTN ASA	.095536
3525 2-3/4" US10B ARC ASA	.095546
3525 2-3/4" US10B AUG ASA	.038434
3525 2-3/4" US10B WTN ASA	.095537
3525 2-3/4" US26 ARC ASA	.095547
3525 2-3/4" US26 AUG ASA	.038492
3525 2-3/4" US26 WTN ASA	.095543
3525 2-3/4" US26D ARC ASA	.095550
3525 2-3/4" US26D AUG ASA	.038430
3525 2-3/4" US26D WTN ASA	.095544
3525 2-3/4" US3 ARC ASA	.095533
3525 2-3/4" US3 AUG ASA	.038519
3525 2-3/4" US3 WTN ASA	.095532
3525 2-3/4" US4 ARC ASA	.095534
3525 2-3/4" US4 AUG ASA	.038390
3525 2-3/4" US4 WTN ASA	.095535

3527

3527 US10 ARC	.111169
3527 US10 AUG	.111189
3527 US10 WTN	.111191
3527 US10B ARC	.111192
3527 US10B AUG	.111193
3527 US10B WTN	.111194
3527 US26 ARC	.111195
3527 US26 AUG	.111196
3527 US26 WTN	.111197
3527 US26D ARC	.111198
3527 US26D AUG	.111199
3527 US26D WTN	.111200
3527 US3 ARC	.111201
3527 US3 AUG	.111202
3527 US3 WTN	.111203
3527 US4 ARC	.111205
3527 US4 AUG	.111206
3527 US4 WTN	.111204

3540

3540 2-3/4" US10 ARC ASA	.000311
3540 2-3/4" US10 AUG ASA	.038384
3540 2-3/4" US10 WTN ASA	.000252
3540 2-3/4" US10B ARC ASA	.000312
3540 2-3/4" US10B AUG ASA	.038280
3540 2-3/4" US10B WTN ASA	.000254
3540 2-3/4" US26 ARC ASA	.000308
3540 2-3/4" US26 AUG ASA	.038266
3540 2-3/4" US26 WTN ASA	.000248
3540 2-3/4" US26D ARC ASA	.000307

Items with the price in **bold and red** are Quick Ship Items and ship in 24 hours.

3540

3540 2-3/4" US26D AUG ASA	.038034
3540 2-3/4" US26D WTN ASA	.000247
3540 2-3/4" US3 ARC ASA	.000309
3540 2-3/4" US3 AUG ASA	.037999
3540 2-3/4" US3 WTN ASA	.000249
3540 2-3/4" US4 ARC ASA	.000310
3540 2-3/4" US4 AUG ASA	.037979
3540 2-3/4" US4 WTN ASA	.000250
3540 2-3/4" US3 APL ASA	.091121
3540 2-3/4" US32D APL ASA	.091146

3550

3550 2-3/4" US10 ARC NC ASA IC	.037229
3550 2-3/4" US10 ARC SCC KD ASA	.037173
3550 2-3/4" US10 AUG NC ASA IC	.023439
3550 2-3/4" US10 AUG SCC KD ASA	.027728
3550 2-3/4" US10 WTN NC ASA IC	.037227
3550 2-3/4" US10 WTN SCC KD ASA	.037170
3550 2-3/4" US10B ARC NC ASA IC	.037208
3550 2-3/4" US10B ARC SCC KD ASA	.037169
3550 2-3/4" US10B AUG NC ASA IC	.023588
3550 2-3/4" US10B AUG SCC KD ASA	.027729
3550 2-3/4" US10B WTN NC ASA IC	.037206
3550 2-3/4" US10B WTN SCC KD ASA	.037162
3550 2-3/4" US26 ARC NC ASA IC	.038039
3550 2-3/4" US26 ARC SCC KD ASA	.037205
3550 2-3/4" US26 AUG NC ASA IC	.023554
3550 2-3/4" US26 AUG SCC KD ASA	.027726
3550 2-3/4" US26 WTN NC ASA IC	.037256
3550 2-3/4" US26 WTN SCC KD ASA	.037203
3550 2-3/4" US26D ARC NC ASA IC	.098290
3550 2-3/4" US26D ARC SCC KD ASA	.098325
3550 2-3/4" US26D AUG NC ASA IC	.023493
3550 2-3/4" US26D AUG SCC KD ASA	.027719
3550 2-3/4" US26D WTN NC ASA IC	.098291
3550 2-3/4" US26D WTN SCC KD ASA	.098329
3550 2-3/4" US3 ARC NC ASA IC	.037245
3550 2-3/4" US3 ARC SCC KD ASA	.050365
3550 2-3/4" US3 AUG NC ASA IC	.023438
3550 2-3/4" US3 AUG SCC KD ASA	.027713
3550 2-3/4" US3 WTN NC ASA IC	.037234
3550 2-3/4" US3 WTN SCC KD ASA	.037202
3550 2-3/4" US4 ARC NC ASA IC	.037232
3550 2-3/4" US4 ARC SCC KD ASA	.037200
3550 2-3/4" US4 AUG NC ASA IC	.023453
3550 2-3/4" US4 AUG SCC KD ASA	.027704
3550 2-3/4" US4 WTN NC ASA IC	.037230
3550 2-3/4" US4 WTN SCC KD ASA	.037191

3553

3553 2-3/4" US10 ARC NC ASA IC	.048993
3553 2-3/4" US10 ARC SCC KD ASA	.000290
3553 2-3/4" US10 AUG NC ASA IC	.023437
3553 2-3/4" US10 AUG SCC KD ASA	.027702
3553 2-3/4" US10 WTN NC ASA IC	.037888
3553 2-3/4" US10 WTN SCC KD ASA	.000095
3553 2-3/4" US10B ARC NC ASA IC	.037159

3553

3553 2-3/4" US10B ARC SCC KD ASA000291
3553 2-3/4" US10B AUG NC ASA IC023436
3553 2-3/4" US10B AUG SCC KD ASA027701
3553 2-3/4" US10B WTN NC ASA IC045784
3553 2-3/4" US10B WTN SCC KD ASA	000096
3553 2-3/4" US26 ARC SCC KD ASA000286
3553 2-3/4" US26 AUG NC ASA IC023435
3553 2-3/4" US26 AUG SCC KD ASA027684
3553 2-3/4" US26 WTN NC ASA IC014395
3553 2-3/4" US26 WTN SCC KD ASA000092
3553 2-3/4" US26D ARC NC ASA IC098289
3553 2-3/4" US26D ARC SCC KD ASA	000284
3553 2-3/4" US26D AUG NC ASA IC023393
3553 2-3/4" US26D AUG SCC KD ASA	027683
3553 2-3/4" US26D WTN NC ASA IC	098655
3553 2-3/4" US26D WTN SCC KD ASA	000091
3553 2-3/4" US3 ARC NC ASA IC053986
3553 2-3/4" US3 ARC SCC KD ASA000288
3553 2-3/4" US3 AUG NC ASA IC023377
3553 2-3/4" US3 AUG SCC KD ASA027682
3553 2-3/4" US3 WTN NC ASA IC084942
3553 2-3/4" US3 WTN SCC KD ASA000093
3553 2-3/4" US4 ARC NC ASA IC086632
3553 2-3/4" US4 ARC SCC KD ASA000289
3553 2-3/4" US4 AUG NC ASA IC023296
3553 2-3/4" US4 AUG SCC KD ASA027677
3553 2-3/4" US4 WTN NC ASA IC037153
3553 2-3/4" US4 WTN SCC KD ASA000094
3553 2-3/4" US3 APL SCC KD ASA090526
3553 2-3/4" US32D APL NC ASA IC117596
3553 2-3/4" US32D APL SCC KD ASA	091096

3570

3570 2-3/4" US10 ARC NC ASA IC037112
3570 2-3/4" US10 ARC SCC KD ASA000297
3570 2-3/4" US10 AUG NC ASA IC023292
3570 2-3/4" US10 AUG SCC KD ASA027675
3570 2-3/4" US10 WTN NC ASA IC037111
3570 2-3/4" US10 WTN SCC KD ASA000130
3570 2-3/4" US10B ARC NC ASA IC037110
3570 2-3/4" US10B ARC SCC KD ASA000299
3570 2-3/4" US10B AUG NC ASA IC023281
3570 2-3/4" US10B AUG SCC KD ASA027667
3570 2-3/4" US10B WTN NC ASA IC037109
3570 2-3/4" US10B WTN SCC KD ASA	000129
3570 2-3/4" US26 ARC NC ASA IC037760
3570 2-3/4" US26 ARC SCC KD ASA000294
3570 2-3/4" US26 AUG NC ASA IC023249
3570 2-3/4" US26 AUG SCC KD ASA027652
3570 2-3/4" US26 WTN NC ASA IC037152
3570 2-3/4" US26 WTN SCC KD ASA000098
3570 2-3/4" US26D ARC NC ASA IC098287
3570 2-3/4" US26D ARC SCC KD ASA	000293
3570 2-3/4" US26D AUG NC ASA IC023248
3570 2-3/4" US26D AUG SCC KD ASA	027649
3570 2-3/4" US26D WTN NC ASA IC098288

3570

3570 2-3/4" US26D WTN SCC KD ASA	000097
3570 2-3/4" US3 ARC NC ASA IC037145
3570 2-3/4" US3 ARC SCC KD ASA000295
3570 2-3/4" US3 AUG NC ASA IC023247
3570 2-3/4" US3 AUG SCC KD ASA027645
3570 2-3/4" US3 WTN NC ASA IC084961
3570 2-3/4" US3 WTN SCC KD ASA000099
3570 2-3/4" US4 ARC NC ASA IC037129
3570 2-3/4" US4 ARC SCC KD ASA000296
3570 2-3/4" US4 AUG NC ASA IC023246
3570 2-3/4" US4 AUG SCC KD ASA027647
3570 2-3/4" US4 WTN NC ASA IC037113
3570 2-3/4" US4 WTN SCC KD ASA000101
3570 2-3/4" US3 APL SCC KD ASA090544
3570 2-3/4" US32D APL SCC KD ASA	091099

3573

3573 2-3/4" US10 ARC NC ASA IC (REV1)138416
3573 2-3/4" US10 ARC SCC KD ASA (REV1)138417
3573 2-3/4" US10 AUG NC ASA IC (REV1)138418
3573 2-3/4" US10 AUG SCC KD ASA (REV1)138419
3573 2-3/4" US10 WTN NC ASA IC (REV1)138420
3573 2-3/4" US10 WTN SCC KD ASA (REV1)138421
3573 2-3/4" US10B ARC NC ASA IC (REV1)138422
3573 2-3/4" US10B ARC SCC KD ASA (REV1)138423
3573 2-3/4" US10B AUG NC ASA IC (REV1)138424
3573 2-3/4" US10B AUG SCC KD ASA (REV1)138426
3573 2-3/4" US10B WTN NC ASA IC (REV1)138427
3573 2-3/4" US10B WTN SCC KD ASA (REV1)138428
3573 2-3/4" US26 ARC NC ASA IC (REV1)138429
3573 2-3/4" US26 ARC SCC KD ASA (REV1)138430
3573 2-3/4" US26 AUG NC ASA IC (REV1)138431
3573 2-3/4" US26 AUG SCC KD ASA (REV1)138432
3573 2-3/4" US26 WTN NC ASA IC (REV1)138433
3573 2-3/4" US26 WTN SCC KD ASA (REV1)138434
3573 2-3/4" US26D ARC NC ASA IC (REV1)138405
3573 2-3/4" US26D ARC SCC KD ASA (REV1)138435
3573 2-3/4" US26D AUG NC ASA IC (REV1)138407
3573 2-3/4" US26D AUG SCC KD ASA (REV1)138409
3573 2-3/4" US26D WTN NC ASA IC (REV1)138441
3573 2-3/4" US26D WTN SCC KD ASA (REV1)138412
3573 2-3/4" US3 ARC NC ASA IC (REV1)138448
3573 2-3/4" US3 ARC SCC KD ASA (REV1)138449
3573 2-3/4" US3 AUG NC ASA IC (REV1)138450
3573 2-3/4" US3 AUG SCC KD ASA (REV1)138452
3573 2-3/4" US3 WTN NC ASA IC (REV1)138453
3573 2-3/4" US3 WTN SCC KD ASA (REV1)138454
3573 2-3/4" US4 ARC NC ASA IC (REV1)138455
3573 2-3/4" US4 ARC SCC KD ASA (REV1)138456
3573 2-3/4" US4 AUG NC ASA IC (REV1)138457
3573 2-3/4" US4 AUG SCC KD ASA (REV1)138458
3573 2-3/4" US4 WTN NC ASA IC (REV1)138459
3573 2-3/4" US4 WTN SCC KD ASA (REV1)138460

3579

3579 2-3/4" US10 ARC SCC KD ASA095564
3579 2-3/4" US10 AUG NC ASA IC023240

Items with the price in **bold and red** are Quick Ship Items and ship in 24 hours.



3579

3579 2-3/4" US10 AUG SCC KD ASA027417
3579 2-3/4" US10 WTN SCC KD ASA095555
3579 2-3/4" US10B ARC SCC KD ASA095563
3579 2-3/4" US10B AUG NC ASA IC023129
3579 2-3/4" US10B AUG SCC KD ASA027411
3579 2-3/4" US10B WTN NC ASA IC100241
3579 2-3/4" US10B WTN SCC KD ASA095556
3579 2-3/4" US26 ARC SCC KD ASA095560
3579 2-3/4" US26 AUG NC ASA IC023053
3579 2-3/4" US26 AUG SCC KD ASA027410
3579 2-3/4" US26 WTN SCC KD ASA095557
3579 2-3/4" US26D ARC NC ASA IC098284
3579 2-3/4" US26D ARC SCC KD ASA095559
3579 2-3/4" US26D AUG NC ASA IC023041
3579 2-3/4" US26D AUG SCC KD ASA027408
3579 2-3/4" US26D WTN NC ASA IC098285
3579 2-3/4" US26D WTN SCC KD ASA095558
3579 2-3/4" US3 ARC SCC KD ASA095566
3579 2-3/4" US3 AUG NC ASA IC022986
3579 2-3/4" US3 AUG SCC KD ASA027420
3579 2-3/4" US3 WTN SCC KD ASA095552
3579 2-3/4" US4 ARC SCC KD ASA095565
3579 2-3/4" US4 AUG NC ASA IC023241
3579 2-3/4" US4 AUG SCC KD ASA027421
3579 2-3/4" US4 WTN SCC KD ASA095553

3580

3580 2-3/4" US10 ARC NC ASA IC037088
3580 2-3/4" US10 ARC SCC KD ASA000305
3580 2-3/4" US10 AUG NC ASA IC022937
3580 2-3/4" US10 AUG SCC KD ASA027351
3580 2-3/4" US10 WTN NC ASA IC037034
3580 2-3/4" US10 WTN SCC KD ASA000156
3580 2-3/4" US10B ARC NC ASA IC037031
3580 2-3/4" US10B ARC SCC KD ASA000306
3580 2-3/4" US10B AUG NC ASA IC022831
3580 2-3/4" US10B AUG SCC KD ASA027349
3580 2-3/4" US10B WTN NC ASA IC037018
3580 2-3/4" US10B WTN SCC KD ASA000160
3580 2-3/4" US26 ARC NC ASA IC037752
3580 2-3/4" US26 ARC SCC KD ASA000301
3580 2-3/4" US26 AUG NC ASA IC022737
3580 2-3/4" US26 AUG SCC KD ASA027347
3580 2-3/4" US26 WTN NC ASA IC037103
3580 2-3/4" US26 WTN SCC KD ASA000144
3580 2-3/4" US26D ARC NC ASA IC098286
3580 2-3/4" US26D ARC SCC KD ASA000300
3580 2-3/4" US26D AUG NC ASA IC022700
3580 2-3/4" US26D AUG SCC KD ASA027338
3580 2-3/4" US26D WTN NC ASA IC098652
3580 2-3/4" US26D WTN SCC KD ASA000143
3580 2-3/4" US3 ARC NC ASA IC037098
3580 2-3/4" US3 ARC SCC KD ASA000302
3580 2-3/4" US3 AUG NC ASA IC022615
3580 2-3/4" US3 AUG SCC KD ASA027337
3580 2-3/4" US3 WTN NC ASA IC084892

3580

3580 2-3/4" US3 WTN SCC KD ASA000154
3580 2-3/4" US4 ARC NC ASA IC086636
3580 2-3/4" US4 ARC SCC KD ASA000303
3580 2-3/4" US4 AUG NC ASA IC022602
3580 2-3/4" US4 AUG SCC KD ASA027328
3580 2-3/4" US4 WTN NC ASA IC037089
3580 2-3/4" US4 WTN SCC KD ASA000155
3580 2-3/4" US3 APL SCC KD ASA090565
3580 2-3/4" US32D APL SCC KD ASA091101

3610

3610 ADJ 2-3/8 TO 2-3/4 US10 ARC ASA092398
3610 ADJ 2-3/8 TO 2-3/4 US10 AUG ASA027301
3610 ADJ 2-3/8 TO 2-3/4 US10 WTN ASA092402
3610 ADJ 2-3/8 TO 2-3/4 US10B ARC ASA092404
3610 ADJ 2-3/8 TO 2-3/4 US10B AUG ASA027299
3610 ADJ 2-3/8 TO 2-3/4 US10B WTN ASA092403
3610 ADJ 2-3/8 TO 2-3/4 US26 ARC ASA092406
3610 ADJ 2-3/8 TO 2-3/4 US26 AUG ASA027295
3610 ADJ 2-3/8 TO 2-3/4 US26 WTN ASA092405
3610 ADJ 2-3/8 TO 2-3/4 US26D ARC ASA092408
3610 ADJ 2-3/8 TO 2-3/4 US26D AUG ASA027294
3610 ADJ 2-3/8 TO 2-3/4 US26D WTN ASA092410
3610 ADJ 2-3/8 TO 2-3/4 US3 ARC ASA092416
3610 ADJ 2-3/8 TO 2-3/4 US3 AUG ASA027292
3610 ADJ 2-3/8 TO 2-3/4 US3 WTN ASA092411
3610 ADJ 2-3/8 TO 2-3/4 US4 ARC ASA092418
3610 ADJ 2-3/8 TO 2-3/4 US4 AUG ASA027291
3610 ADJ 2-3/8 TO 2-3/4 US4 WTN ASA092419

3617

3617 US10 ARC013176
3617 US10 AUG027277
3617 US10 WTN013170
3617 US10B ARC013175
3617 US10B AUG027275
3617 US10B WTN013169
3617 US26 ARC013172
3617 US26 AUG027276
3617 US26 WTN013166
3617 US26D ARC013171
3617 US26D AUG027272
3617 US26D WTN013165
3617 US3 ARC013173
3617 US3 AUG027262
3617 US3 WTN013167
3617 US4 ARC013174
3617 US4 AUG027278
3617 US4 WTN013168

3640

3640 ADJ 2-3/8 TO 2-3/4 US10 ARC ASA092422
3640 ADJ 2-3/8 TO 2-3/4 US10 AUG ASA027238
3640 ADJ 2-3/8 TO 2-3/4 US10 WTN ASA092421
3640 ADJ 2-3/8 TO 2-3/4 US10B ARC ASA092423
3640 ADJ 2-3/8 TO 2-3/4 US10B AUG ASA027232
3640 ADJ 2-3/8 TO 2-3/4 US10B WTN ASA092424

Items with the price in **bold and red** are Quick Ship Items and ship in 24 hours.

3640

3640 ADJ 2-3/8 TO 2-3/4 US26 ARC ASA092428
 3640 ADJ 2-3/8" TO 2-3/4" US26 AUG ASA027230
 3640 ADJ 2-3/8 TO 2-3/4 US26 WTN ASA092427
3640 ADJ 2-3/8 TO 2-3/4 US26D ARC ASA 092429
3640 ADJ 2-3/8" TO 2-3/4" US26D AUG ASA 027229
3640 ADJ 2-3/8 TO 2-3/4 US26D WTN ASA 092430
 3640 ADJ 2-3/8 TO 2-3/4 US3 ARC ASA092431
 3640 ADJ 2-3/8" TO 2-3/4" US3 AUG ASA027227
 3640 ADJ 2-3/8 TO 2-3/4 US3 WTN ASA092433
 3640 ADJ 2-3/8 TO 2-3/4 US4 ARC ASA092435
 3640 ADJ 2-3/8" TO 2-3/4" US4 AUG ASA027225
 3640 ADJ 2-3/8 TO 2-3/4 US4 WTN ASA092434

3653

3653 ADJ 2-3/8" TO 2-3/4" US10 ARC NC ASA IC007193
 3653 ADJ 2-3/8 TO 2-3/4 US10 ARC SCC KD ASA092436
 3653 ADJ 2-3/8" TO 2-3/4" US10 AUG NC ASA IC020652
 3653 ADJ 2-3/8" TO 2-3/4" US10 AUG SCC KD ASA026938
 3653 ADJ 2-3/8" TO 2-3/4" US10 WTN NC ASA IC007154
 3653 ADJ 2-3/8 TO 2-3/4 US10 WTN SCC KD ASA092439
 3653 ADJ 2-3/8" TO 2-3/4" US10B ARC NC ASA IC006959
 3653 ADJ 2-3/8 TO 2-3/4 US10B ARC SCC KD ASA092440
 3653 ADJ 2-3/8" TO 2-3/4" US10B AUG NC ASA IC020622
 3653 ADJ 2-3/8" TO 2-3/4" US10B AUG SCC KD ASA026695
 3653 ADJ 2-3/8" TO 2-3/4" US10B WTN NC ASA IC007153
 3653 ADJ 2-3/8 TO 2-3/4 US10B WTN SCC KD ASA092452
 3653 ADJ 2-3/8" TO 2-3/4" US26 ARC NC ASA IC007181
 3653 ADJ 2-3/8 TO 2-3/4 US26 ARC SCC KD ASA092442
 3653 ADJ 2-3/8" TO 2-3/4" US26 AUG NC ASA IC020621
 3653 ADJ 2-3/8" TO 2-3/4" US26 AUG SCC KD ASA026868
 3653 ADJ 2-3/8" TO 2-3/4" US26 WTN NC ASA IC007148
 3653 ADJ 2-3/8 TO 2-3/4 US26 WTN SCC KD ASA092450
 3653 ADJ 2-3/8" TO 2-3/4" US26D ARC NC ASA IC007177
3653 ADJ 2-3/8 TO 2-3/4 US26D ARC SCC KD ASA . . 092443
 3653 ADJ 2-3/8" TO 2-3/4" US26D AUG NC ASA IC020617
3653 ADJ 2-3/8" TO 2-3/4" US26D AUG SCC KD ASA 026836
 3653 ADJ 2-3/8" TO 2-3/4" US26D WTN NC ASA IC007138
3653 ADJ 2-3/8 TO 2-3/4 US26D WTN SCC KD ASA . . 092449
 3653 ADJ 2-3/8" TO 2-3/4" US3 ARC NC ASA IC007198
 3653 ADJ 2-3/8 TO 2-3/4 US3 ARC SCC KD ASA092444
 3653 ADJ 2-3/8" TO 2-3/4" US3 AUG NC ASA IC020559
 3653 ADJ 2-3/8" TO 2-3/4" US3 AUG SCC KD ASA026788
 3653 ADJ 2-3/8" TO 2-3/4" US3 WTN NC ASA IC007173
 3653 ADJ 2-3/8 TO 2-3/4 US3 WTN SCC KD ASA092447
 3653 ADJ 2-3/8" TO 2-3/4" US4 ARC NC ASA IC007197
 3653 ADJ 2-3/8 TO 2-3/4 US4 ARC SCC KD ASA092445
 3653 ADJ 2-3/8" TO 2-3/4" US4 AUG NC ASA IC020489
 3653 ADJ 2-3/8" TO 2-3/4" US4 AUG SCC KD ASA026834
 3653 ADJ 2-3/8" TO 2-3/4" US4 WTN NC ASA IC007162
 3653 ADJ 2-3/8 TO 2-3/4 US4 WTN SCC KD ASA092446

3670

3670 REV 1 ADJ 2-3/8" - 2-3/4" US10 ARC NC ASA IC127307
 3670 REV 1 ADJ 2-3/8" - 2-3/4" US10 ARC SCC KD ASA127308
 3670 REV 1 ADJ 2-3/8" - 2-3/4" US10 AUG NC ASA IC127309
 3670 REV 1 ADJ 2-3/8" - 2-3/4" US10 AUG SCC KD ASA127310
 3670 REV 1 ADJ 2-3/8" - 2-3/4" US10 WTN NC ASA IC127311

3670

3670 REV 1 ADJ 2-3/8 - 2-3/4 US10 WTN SCC KD ASA127312
 3670 REV 1 ADJ 2-3/8" - 2-3/4" US10B ARC NC ASA IC127291
 3670 REV 1 ADJ 2-3/8 - 2-3/4 US10B ARC SCC KD ASA127292
 3670 REV 1 ADJ 2-3/8" - 2-3/4" US10B AUG NC ASA IC127293
 3670 REV1 ADJ 2-3/8" - 2-3/4" US10B AUG SCC KD ASA127294
 3670 REV 1 ADJ 2-3/8" - 2-3/4" US10B WTN NC ASA IC127295
 3670 REV 1 ADJ 2-3/8 - 2-3/4 US10B WTN SCC KD ASA127296
 3670 REV 1 ADJ 2-3/8" - 2-3/4" US26 ARC NC ASA IC127313
 3670 REV 1 ADJ 2-3/8" - 2-3/4" US26 ARC SCC KD ASA127314
 3670 REV 1 ADJ 2-3/8" - 2-3/4" US26 AUG NC ASA IC127315
 3670 REV 1 ADJ 2-3/8" - 2-3/4" US26 AUG SCC KD ASA127316
 3670 REV 1 ADJ 2-3/8" - 2-3/4" US26 WTN NC ASA IC127317
 3670 REV 1 ADJ 2-3/8" - 2-3/4" US26 WTN SCC KD ASA127318
 3670 REV 1 ADJ 2-3/8" - 2-3/4" US26D ARC NC ASA IC127279
 3670 REV 1 ADJ 2-3/8 TO 2-3/4 US26D ARC SCC KD ASA127280
 3670 REV 1 ADJ 2-3/8" - 2-3/4" US26D AUG NC ASA IC127281
 3670 REV1 ADJ 2-3/8" - 2-3/4" US26D AUG SCC KD ASA127282
 3670 REV 1 ADJ 2-3/8" - 2-3/4" US26D WTN NC ASA IC127283
 3670 REV 1 ADJ 2-3/8 - 2-3/4 US26D WTN SCC KD ASA127284
 3670 REV 1 ADJ 2-3/8" - 2-3/4" US3 ARC NC ASA IC127319
 3670 REV 1 ADJ 2-3/8" - 2-3/4" US3 ARC SCC KD ASA127320
 3670 REV 1 ADJ 2-3/8" - 2-3/4" US3 AUG NC ASA IC127321
 3670 REV 1 ADJ 2-3/8" - 2-3/4" US3 AUG SCC KD ASA127322
 3670 REV 1 ADJ 2-3/8" - 2-3/4" US3 WTN NC ASA IC127323
 3670 REV 1 ADJ 2-3/8" - 2-3/4" US3 WTN SCC KD ASA127324
 3670 REV 1 ADJ 2-3/8" - 2-3/4" US4 ARC NC ASA IC127325
 3670 REV 1 ADJ 2-3/8" - 2-3/4" US4 ARC SCC KD ASA127326
 3670 REV 1 ADJ 2-3/8" - 2-3/4" US4 AUG NC ASA IC127327
 3670 REV 1 ADJ 2-3/8" - 2-3/4" US4 AUG SCC KD ASA127328
 3670 REV 1 ADJ 2-3/8" - 2-3/4" US4 WTN NC ASA IC127329
 3670 REV 1 ADJ 2-3/8" - 2-3/4" US4 WTN SCC KD ASA127330

3680

3680 REV 1 ADJ 2-3/8" - 2-3/4" US10 ARC NC ASA IC127331
 3680 REV 1 ADJ 2-3/8" - 2-3/4" US10 ARC SCC KD ASA127332
 3680 REV 1 ADJ 2-3/8" - 2-3/4" US10 AUG NC ASA IC127333
 3680 REV 1 ADJ 2-3/8" - 2-3/4" US10 AUG SCC KD ASA127334
 3680 REV 1 ADJ 2-3/8" - 2-3/4" US10 WTN NC ASA IC127335
 3680 REV 1 ADJ 2-3/8" - 2-3/4" US10 WTN SCC KD ASA127336
 3680 REV 1 ADJ 2-3/8" - 2-3/4" US10B ARC NC ASA IC127297
 3680 REV1 ADJ 2-3/8" - 2-3/4" US10B ARC SCC KD ASA127298
 3680 REV 1 ADJ 2-3/8" - 2-3/4" US10B AUG NC ASA IC127299
 3680 REV1 ADJ 2-3/8" - 2-3/4" US10B AUG SCC KD ASA127300
 3680 REV 1 ADJ 2-3/8" - 2-3/4" US10B WTN NC ASA IC127301
 3680 REV1 ADJ 2-3/8" - 2/3/4" US10B WTN SCC KD ASA127302
 3680 REV 1 ADJ 2-3/8" - 2-3/4" US26 ARC NC ASA IC127337
 3680 REV 1 ADJ 2-3/8" - 2-3/4" US26 ARC SCC KD ASA127338
 3680 REV 1 ADJ 2-3/8" - 2-3/4" US26 AUG NC ASA IC127339
 3680 REV 1 ADJ 2-3/8" - 2-3/4" US26 AUG SCC KD ASA127340
 3680 REV 1 ADJ 2-3/8" - 2-3/4" US26 WTN NC ASA IC127341
 3680 REV 1 ADJ 2-3/8" - 2-3/4" US26 WTN SCC KD ASA127342
 3680 REV 1 ADJ 2-3/8" - 2-3/4" US26D ARC NC ASA IC127285
 3680 REV 1 ADJ 2-3/8 - 2-3/4 US26D ARC SCC KD ASA127286
 3680 REV 1 ADJ 2-3/8" - 2-3/4" US26D AUG NC ASA IC127287
 3680 REV1 ADJ 2-3/8" - 2-3/4" US26D AUG SCC KD ASA127288
 3680 REV 1 ADJ 2-3/8" - 2-3/4" US26D WTN NC ASA IC127289

Items with the price in bold and red are Quick Ship Items and ship in 24 hours.



3680

3680 REV 1 ADJ 2-3/8 - 2-3/4 US26D WTN SCC KD ASA . . 127290

3680 REV 1 ADJ 2-3/8" - 2-3/4" US3 ARC NC ASA IC	127343
3680 REV 1 ADJ 2-3/8" - 2-3/4" US3 ARC SCC KD ASA	127344
3680 REV 1 ADJ 2-3/8" TO 2-3/4" US3 AUG NC ASA IC	127345
3680 REV 1 ADJ 2-3/8" - 2-3/4" US3 AUG SCC KD ASA	127346
3680 REV 1 ADJ 2-3/8" - 2-3/4" US3 WTN NC ASA IC	127347
3680 REV 1 ADJ 2-3/8" - 2-3/4" US3 WTN SCC KD ASA	127348
3680 REV 1 ADJ 2-3/8" - 2-3/4" US4 ARC NC ASA IC	127349
3680 REV 1 ADJ 2-3/8" - 2-3/4" US4 ARC SCC KD ASA	127350
3680 REV 1 ADJ 2-3/8" - 2-3/4" US4 AUG NC ASA IC	127351
3680 REV 1 ADJ 2-3/8" - 2-3/4" US4 AUG SCC KD ASA	127352
3680 REV 1 ADJ 2-3/8" - 2-3/4" US4 WTN NC ASA IC	127353
3680 REV 1 ADJ 2-3/8" 1 2-3/4" US4 WTN SCC KD ASA	127354

3710

3710 2-3/4" US10 ARC NC TEE IC005277
3710 2-3/4" US10 ARC SCC KD TEE005365
3710 2-3/4" US10 AUG NC TEE IC005268
3710 2-3/4" US10 AUG SCC KD TEE005328
3710 2-3/4" US10 WTN NC TEE IC005287
3710 2-3/4" US10 WTN SCC KD TEE005663
3710 2-3/4" US10B ARC NC TEE IC005275
3710 2-3/4" US10B ARC SCC KD TEE005363
3710 2-3/4" US10B AUG NC TEE IC005267
3710 2-3/4" US10B AUG SCC KD TEE005316
3710 2-3/4" US10B WTN NC TEE IC005242
3710 2-3/4" US10B WTN SCC KD TEE005656
3710 2-3/4" US26 ARC NC TEE IC005274
3710 2-3/4" US26 ARC SCC KD TEE005355
3710 2-3/4" US26 AUG NC TEE IC005263
3710 2-3/4" US26 AUG SCC KD TEE005303
3710 2-3/4" US26 WTN NC TEE IC005284
3710 2-3/4" US26 WTN SCC KD TEE005651
3710 2-3/4" US26D ARC NC TEE IC005273
3710 2-3/4" US26D ARC SCC KD TEE005339
3710 2-3/4" US26D AUG NC TEE IC005262
3710 2-3/4" US26D AUG SCC KD TEE005302
3710 2-3/4" US26D WTN NC TEE IC005283
3710 2-3/4" US26D WTN SCC KD TEE005623
3710 2-3/4" US3 ARC NC TEE IC005282
3710 2-3/4" US3 ARC SCC KD TEE005369
3710 2-3/4" US3 AUG NC TEE IC005272
3710 2-3/4" US3 AUG SCC KD TEE005336
3710 2-3/4" US3 WTN NC TEE IC005290
3710 2-3/4" US3 WTN SCC KD TEE005684
3710 2-3/4" US4 ARC NC TEE IC005281
3710 2-3/4" US4 ARC SCC KD TEE005368
3710 2-3/4" US4 AUG NC TEE IC005271
3710 2-3/4" US4 AUG SCC KD TEE005335
3710 2-3/4" US4 WTN NC TEE IC005289
3710 2-3/4" US4 WTN SCC KD TEE005680

3753

3753 2-3/4" US10 ARC NC TEE IC005444
3753 2-3/4" US10 ARC SCC KD TEE005594
3753 2-3/4" US10 AUG NC TEE IC005424

Items with the price in **bold and red** are Quick Ship Items and ship in 24 hours.



3753

3753 2-3/4" US10 AUG SCC KD TEE005542
3753 2-3/4" US10 WTN NC TEE IC005474
3753 2-3/4" US10 WTN SCC KD TEE005708
3753 2-3/4" US10B ARC NC TEE IC005442
3753 2-3/4" US10B ARC SCC KD TEE005580
3753 2-3/4" US10B AUG NC TEE IC005423
3753 2-3/4" US10B AUG SCC KD TEE005541
3753 2-3/4" US10B WTN NC TEE IC005468
3753 2-3/4" US10B WTN SCC KD TEE005702
3753 2-3/4" US26 ARC NC TEE IC005441
3753 2-3/4" US26 ARC SCC KD TEE005578
3753 2-3/4" US26 AUG NC TEE IC005399
3753 2-3/4" US26 AUG SCC KD TEE005540
3753 2-3/4" US26 WTN NC TEE IC005458
3753 2-3/4" US26 WTN SCC KD TEE005701
3753 2-3/4" US26D ARC NC TEE IC005440
3753 2-3/4" US26D ARC SCC KD TEE005567
3753 2-3/4" US26D AUG NC TEE IC005390
3753 2-3/4" US26D AUG SCC KD TEE005525
3753 2-3/4" US26D WTN NC TEE IC005454
3753 2-3/4" US26D WTN SCC KD TEE	115187
3753 2-3/4" US3 ARC NC TEE IC005453
3753 2-3/4" US3 ARC SCC KD TEE005610
3753 2-3/4" US3 AUG NC TEE IC005431
3753 2-3/4" US3 AUG SCC KD TEE005547
3753 2-3/4" US3 WTN NC TEE IC005500
3753 2-3/4" US3 WTN SCC KD TEE005715
3753 2-3/4" US4 ARC NC TEE IC005446
3753 2-3/4" US4 ARC SCC KD TEE005598
3753 2-3/4" US4 AUG NC TEE IC005427
3753 2-3/4" US4 AUG SCC KD TEE005544
3753 2-3/4" US4 WTN NC TEE IC005499
3753 2-3/4" US4 WTN SCC KD TEE005712

3810

3810 ESC US26D ARC001029
3810 ESC US26D ARB001134
3810 ESC US26D WLM001118
3810 ESC US26D WLB001110
3810 ESC US26D AUG141107
3810 ESC US26D WTN001070
3810 ESC US26D WTB001039
3810 ESC US32D ARC101244
3810 ESC US32D ARS104200
3810 ESC US32D WLM101245
3810 ESC US32D WLS104202
3810 ESC US32D WTN101242
3810 ESC US32D WTS104198
3810 SECT US26D ARC001035
3810 SECT US26D ARB001094
3810 SECT US26D WLM001132
3810 SECT US26D WLB001113
3810 SECT US26D AUG121368
3810 SECT US26D AUB131854
3810 SECT US26D WTN001078
3810 SECT US26D WTB001050

3810

3810 SECT US32D ARC.....	101243
3810 SECT US32D ARS.....	104199
3810 SECT US32D WLM.....	100652
3810 SECT US32D WLS.....	104201
3810 SECT US32D AUG.....	142537
3810 SECT US32D WTN.....	101241
3810 SECT US32D WTS.....	104197

3817

3817 ESC 26D ARC.....	101383
3817 ESC 26D WLM.....	101384
3817 ESC 26D WTN.....	101380
3817 ESC 32D ARC.....	101392
3817 ESC US32D ARS.....	143086
3817 ESC 32D WLM.....	101394
3817 ESC 32D WTN.....	101387
3817 SECT US26 AUG.....	123073
3817 SECT 26D ARC.....	101382
3817 SECT 26D WLM.....	101385
3817 SECT US26D AUG.....	122764
3817 SECT 26D WTN.....	101379
3817 SECT 32D ARC.....	101388
3817 SECT 32D ARS.....	118466
3817 SECT 32D WLM.....	101393
3817 SECT 32D WTN.....	101386

3827

3827 ESC 26D ARC.....	101398
3827 ESC 26D WLM.....	101399
3827 ESC 26D AUG.....	124256
3827 ESC 26D WTN.....	101396
3827 ESC 32D ARC.....	101404
3827 ESC 32D WLM.....	101412
3827 ESC 32D WTN.....	101402
3827 SECT 26D ARC.....	101397
3827 SECT 26D WLM.....	101400
3827 SECT US26D AUG.....	122765
3827 SECT 26D WTN.....	101395
3827 SECT 32D ARC.....	101403
3827 SECT 32D ARS.....	118447
3827 SECT 32D WLM.....	101411
3827 SECT US32D WLS.....	110988
3827 SECT 32D WTN.....	101401
3827 SECT US32D WTS.....	141202

3840

3840 ESC US26D ARC.....	.000999
3840 ESC US26D ARB.....	.000997
3840 ESC US26D WLM.....	.000992
3840 ESC US26D WLB.....	.000987
3840 ESC US26D AUG.....	118525
3840 ESC US26D WTN.....	.001023
3840 ESC US26D WTB.....	.001022
3840 ESC US32D ARC.....	101339
3840 ESC US32D ARS.....	104206
3840 ESC US32D WLM.....	101340
3840 ESC US32D WLS.....	104208

3840

3840 ESC US32D WTN.....	101337
3840 ESC US32D WTS.....	104204
3840 SECT US26D ARC.....	.001000
3840 SECT US26D ARB.....	.000998
3840 SECT US26D WLM.....	.000994
3840 SECT US26D WLB.....	.000988
3840 SECT US26D AUG.....	122766
3840 SECT US26D WTN.....	001098
3840 SECT US26D WTB.....	.001011
3840 SECT US32D ARC.....	101338
3840 SECT US32D ARS.....	104205
3840 SECT US32D WLM.....	100653
3840 SECT US32D WLB.....	104116
3840 SECT US32D WLS.....	104207
3840 SECT US32D AUS.....	140374
3840 SECT US32D AUG.....	131036
3840 SECT US32D WTN.....	101336
3840 SECT US32D WTS.....	104203

3844

3844 ESC US26D WTN.....	135035
3844 ESC US32D WTN.....	135357
3844 SECT US26D ARC.....	142322
3844 SECT US26D WTN.....	134987
3844 SECT US26D WTS.....	142453
3844 SECT US32D WTN.....	135355

3850

3850 ESC US26D ARC.....	100433
3850 ESC US26D ARC FULL6 SCC KD.....	102922
3850 ESC US26D ARB.....	103654
3850 ESC US26D ARB FULL6 SCC KD.....	103631
3850 ESC US26D WLM.....	100434
3850 ESC US26D WLM FULL6 SCC KD.....	102924
3850 ESC US26D WLB.....	103655
3850 ESC US26D WLB FULL6 SCC KD.....	103632
3850 ESC US26D WTN.....	100432
3850 ESC US26D WTN FULL6 SCC KD.....	102920
3850 ESC US26D WTB.....	103656
3850 ESC US26D WTB FULL6 SCC KD.....	103633
3850 ESC US32D ARC.....	101236
3850 ESC US32D ARC FULL6 SCC KD.....	102969
3850 ESC US32D ARS.....	103657
3850 ESC US32D ARS FULL6 SCC KD.....	103658
3850 ESC US32D WLM.....	101239
3850 ESC US32D WLM FULL6 SCC KD.....	102971
3850 ESC US32D WLS.....	103659
3850 ESC US32D WLS FULL6 SCC KD.....	103660
3850 ESC US32D WTN.....	101232
3850 ESC US32D WTN FULL6 SCC KD.....	102967
3850 ESC US32D WTS.....	103746
3850 ESC US32D WTS FULL6 SCC KD.....	103661
3850 SECT US26D ARC.....	.000965
3850 SECT US26D ARC FULL6 SCC KD.....	102921
3850 SECT US26D ARB.....	103340
3850 SECT US26D ARB FULL6 SCC KD.....	103341
3850 SECT US26D WLM.....	.000959

Items with the price in **bold and red** are Quick Ship Items and ship in 24 hours.



3850

3850 SECT US26D WLM FULL6 SCC KD	102923
3850 SECT US26D WLB	103634
3850 SECT US26D WLB FULL6 SCC KD	103635
3850 SECT US26D AUG	136008
3850 SECT US26D AUG FULL6 SCC KD	122972
3850 SECT US26D WTN	000972
3850 SECT US26D WTN FULL6 SCC KD	102925
3850 SECT US26D WTB	103338
3850 SECT US26D WTB FULL6 SCC KD	103339
3850 SECT US32D ARC	101234
3850 SECT US32D ARC FULL6 SCC KD	102968
3850 SECT US32D ARS	103360
3850 SECT US32D ARS FULL6 SCC KD	103361
3850 SECT US32D WLM	101238
3850 SECT US32D WLM FULL6 SCC KD	102970
3850 SECT US32D WLS	103662
3850 SECT US32D WLS FULL6 SCC KD	103663
3850 SECT US32D AUG FULL6 SCC KD	121583
3850 SECT US32D WTN	101230
3850 SECT US32D WTN FULL6 SCC KD	102966
3850 SECT US32D WTS	103358
3850 SECT US32D WTS FULL6 SCC KD	103359

3853

3853 ESC US26D ARC REV 1	115862
3853 ESC US26D ARC FULL6 SCC KD REV 1	115630
3853 ESC US26D ARB REV 1	115866
3853 ESC US26D ARB FULL6 SCC KD REV 1	115867
3853 ESC US26D WLM REV 1	115868
3853 ESC US26D WLM FULL6 SCC KD REV 1	115631
3853 ESC US26D WLB REV 1	115871
3853 ESC US26D WLB FULL6 SCC KD REV 1	115872
3853 ESC US26D AUG FULL6 SCC KD REV 1	125154
3853 ESC US26D WTN REV 1	115873
3853 ESC US26D WTN FULL6 SCC KD	115632
3853 ESC US26D WTB REV 1	115875
3853 ESC US26D WTB FULL6 SCC KD REV 1	115876
3853 ESC US32D ARC REV 1	115878
3853 ESC US32D ARC FULL6 SCC KD REV 1	115880
3853 ESC US32D ARS REV 1	115881
3853 ESC US32D ARS FULL6 SCC KD REV 1	115882
3853 ESC US32D WLM REV 1	115883
3853 ESC US32D WLM FULL6 SCC KD REV 1	115885
3853 ESC US32D WLS REV 1	115890
3853 ESC US32D WLS FULL6 SCC KD REV 1	115891
3853 ESC US32D WTN REV 1	115892
3853 ESC US32D WTN FULL6 SCC KD REV 1	115894
3853 ESC US32D WTS REV 1	115895
3853 ESC US32D WTS FULL6 SCC KD REV 1	115896
3853 SECT US26D ARC REV 1	115900
3853 SECT US26D ARC FULL6 SCC KD	115902
3853 SECT US26D ARB REV 1	115903
3853 SECT US26D ARB FULL6 SCC KD REV 1	115904
3853 SECT US26D ARS FULL6 SCC KD (REV.1)	139693
3853 SECT US26D WLM REV 1	115905
3853 SECT US26D WLM FULL6 SCC KD REV 1	115633

Items with the price in **bold and red** are Quick Ship Items and ship in 24 hours.

3853

3853 SECT US26D WLB REV 1	115907
3853 SECT US26D WLB FULL6 SCC KD REV 1	115908
3853 SECT US26D AUG REV 1	131092
3853 SECT US26D AUG FULL6 SCC KD REV.1	120892
3853 SECT US26D WTN REV 1	115909
3853 SECT US26D WTN FULL6 SCC KD	115634
3853 SECT US26D WTB REV 1	115911
3853 SECT US26D WTB FULL6 SCC KD REV 1	115912
3853 SECT US32D ARC REV 1	115914
3853 SECT US32D ARC FULL6 SCC KD REV 1	115916
3853 SECT US32D ARS REV 1	115917
3853 SECT US32D ARS FULL6 SCC KD (REV.1)	115918
3853 SECT US32D WLM REV 1	115919
3853 SECT US32D WLM FULL6 SCC KD REV 1	115921
3853 SECT US32D WLS REV 1	115922
3853 SECT US32D WLS FULL6 SCC KD REV 1	115923
3853 SECT US32D AUG FULL6 SCC KD REV.1	121377
3853 SECT US32D AUS REV 1	144317
3853 SECT US32D AUS FULL6 SCC KD REV 1	144318
3853 SECT US32D WTN REV 1	115924
3853 SECT US32D WTN FULL6 SCC KD REV 1	115926
3853 SECT US32D WTS REV 1	115927
3853 SECT US32D WTS FULL6 SCC KD REV 1	115928

3857

3857 ESC US26D ARC REV 1	123411
3857 ESC US26D ARC FULL6 SCC KD REV 1	123830
3857 ESC US26D ARB REV 1	123832
3857 ESC US26D ARB FULL6 SCC KD REV 1	123833
3857 ESC US26D WLM REV 1	123840
3857 ESC US26D WLM FULL6 SCC KD REV 1	123868
3857 ESC US26D WLB REV 1	123869
3857 ESC US26D WLB FULL6 SCC KD REV 1	123870
3857 ESC US26D AUG	118526
3857 ESC US26D WTN REV 1	123871
3857 ESC US26D WTN FULL6 SCC KD REV 1	123872
3857 ESC US26D WTB REV 1	123873
3857 ESC US26D WTB FULL6 SCC KD REV 1	123874
3857 ESC US32D ARC REV 1	123875
3857 ESC US32D ARC FULL6 SCC KD REV 1	123876
3857 ESC US32D ARS REV 1	123879
3857 ESC US32D ARS FULL6 SCC KD REV 1	123880
3857 ESC US32D WLM REV 1	123881
3857 ESC US32D WLM FULL6 SCC KD REV 1	123882
3857 ESC US32D WLS REV 1	123932
3857 ESC US32D WLS FULL6 SCC KD REV 1	123933
3857 ESC US32D WTN REV 1	123935
3857 ESC US32D WTN FULL6 SCC KD REV 1	123936
3857 ESC US32D WTS REV 1	123937
3857 ESC US32D WTS FULL6 SCC KD REV 1	123938
3857 SECT US26D ARC REV 1	123939
3857 SECT US26D ARC FULL6 SCC KD REV 1	123940
3857 SECT US26D ARB REV 1	123941
3857 SECT US26D ARB FULL6 SCC KD REV 1	123942
3857 SECT US26D WLM REV 1	123980
3857 SECT US26D WLM FULL6 SCC KD REV 1	123981

3857

3857 SECT US26D WLB REV 1	123982
3857 SECT US26D WLB FULL6 SCC KD REV 1	123983
3857 SECT US26D AUG FULL6 SCC KD REV 1	139898
3857 SECT US26D WTN REV 1	123984
3857 SECT US26D WTN FULL6 SCC KD REV 1	123985
3857 SECT US26D WTB REV 1	123986
3857 SECT US26D WTB FULL6 SCC KD REV 1	123987
3857 SECT US32D ARC REV 1	123989
3857 SECT US32D ARC FULL6 SCC KD REV 1	123991
3857 SECT US32D ARS REV 1	123992
3857 SECT US32D ARS FULL6 SCC KD REV 1	123993
3857 SECT US32D ARS ICFULL7 NC REV1	145327
3857 SECT US32D WLM REV 1	123994
3857 SECT US32D WLM FULL6 SCC KD REV 1	123995
3857 SECT US32D WLS REV 1	124068
3857 SECT US32D WLS FULL6 SCC KD REV 1	124069
3857 SECT US32D AUG FULL6 SCC KD REV 1	131477
3857 SECT US32D WTN REV 1	124070
3857 SECT US32D WTN FULL6 SCC KD REV 1	124071
3857 SECT US32D WTS REV 1	124072
3857 SECT US32D WTS FULL6 SCC KD REV 1	124073

3870

3870 ESC US26D ARC	100370
3870 ESC US26D ARC FULL6 SCC KD	102930
3870 ESC US26D ARB	103700
3870 ESC US26D ARB FULL6 SCC KD	103642
3870 ESC US26D WLM	100374
3870 ESC US26D WLM FULL6 SCC KD	102932
3870 ESC US26D WLB	103701
3870 ESC US26D WLB FULL6 SCC KD	103644
3870 ESC US26D AUB	124409
3870 ESC US26D WTN	100365
3870 ESC US26D WTN FULL6 SCC KD	102928
3870 ESC US26D WTB	103702
3870 ESC US26D WTB FULL6 SCC KD	103645
3870 ESC US32D ARC	101187
3870 ESC US32D ARC FULL6 SCC KD	102937
3870 ESC US32D ARS	103703
3870 ESC US32D ARS FULL6 SCC KD	103704
3870 ESC US32D WLM	101191
3870 ESC US32D WLM FULL6 SCC KD	102939
3870 ESC US32D WLS	103705
3870 ESC US32D WLS FULL6 SCC KD	103706
3870 ESC US32D WTN	101182
3870 ESC US32D WTN FULL6 SCC KD	102934
3870 ESC US32D WTS	103707
3870 ESC US32D WTS FULL6 SCC KD	103708
3870 SECT US26D ARC	100368
3870 SECT US26D ARC FULL6 SCC KD	102929
3870 SECT US26D ARB	103332
3870 SECT US26D ARB FULL6 SCC KD	103333
3870 SECT US26D WLM	100372
3870 SECT US26D WLM FULL6 SCC KD	102931
3870 SECT US26D WLB	103646
3870 SECT US26D WLB FULL6 SCC KD	103647

3870

3870 SECT US26D AUG	143782
3870 SECT US26D AUG FULL6 SCC KD	121680
3870 SECT US26D WTN	100362
3870 SECT US26D WTN FULL6 SCC KD	102927
3870 SECT US26D WTB	103330
3870 SECT US26D WTB FULL6 SCC KD	103331
3870 SECT US32D ARC	101185
3870 SECT US32D ARC FULL6 SCC KD	102936
3870 SECT US32D ARS	103348
3870 SECT US32D ARS FULL6 SCC KD	103357
3870 SECT US32D WLM	101189
3870 SECT US32D WLM FULL6 SCC KD	102938
3870 SECT US32D WLS	103709
3870 SECT US32D WLS FULL6 SCC KD	103710
3870 SECT US32D WTN	101181
3870 SECT US32D WTN FULL6 SCC KD	102933
3870 SECT US32D WTS	103346
3870 SECT US32D WTS FULL6 SCC KD	103347

3880

3880 ESC US26D ARC	100447
3880 ESC US26D ARC FULL6 SCC KD	102981
3880 ESC US26D ARB	103711
3880 ESC US26D ARB FULL6 SCC KD	103648
3880 ESC US26D WLM	100444
3880 ESC US26D WLM FULL6 SCC KD	102983
3880 ESC US26D WLB	103712
3880 ESC US26D WLB FULL6 SCC KD	103649
3880 ESC US26D AUG	118527
3880 ESC US26D AUG FULL6 SCC KD	136173
3880 ESC US26D WTN	100446
3880 ESC US26D WTN FULL6 SCC KD	102979
3880 ESC US26D WTB	103713
3880 ESC US26D WTB FULL6 SCC KD	103650
3880 ESC US32D ARC	101347
3880 ESC US32D ARC FULL6 SCC KD	102987
3880 ESC US32D ARS	103714
3880 ESC US32D ARS FULL6 SCC KD	103715
3880 ESC US32D WLM	101350
3880 ESC US32D WLM FULL6 SCC KD	102989
3880 ESC US32D WLS	103716
3880 ESC US32D WLS FULL6 SCC KD	103717
3880 ESC US32D WTN	101343
3880 ESC US32D WTN FULL6 SCC KD	102985
3880 ESC US32D WTS	103718
3880 ESC US32D WTS FULL6 SCC KD	103719
3880 SECT US26D ARC	100438
3880 SECT US26D ARC FULL6 SCC KD	102980
3880 SECT US26D ARB	103344
3880 SECT US26D ARB FULL6 SCC KD	103345
3880 SECT US26D WLM	100441
3880 SECT US26D WLM FULL6 SCC KD	102982
3880 SECT US26D WLB	103651
3880 SECT US26D WLB FULL6 SCC KD	103652
3880 SECT US26D AUG	122767
3880 SECT US26D AUG FULL6 SCC KD	121692

Items with the price in **bold and red** are Quick Ship Items and ship in 24 hours.



3880

3880 SECT US26D WTN	100435
3880 SECT US26D WTN FULL6 AR1 KD	109917
3880 SECT US26D WTB	103342
3880 SECT US26D WTB FULL6 SCC KD	103343
3880 SECT US32D ARC	101345
3880 SECT US32D ARC FULL6 SCC KD	102986
3880 SECT US32D ARS	103355
3880 SECT US32D ARS FULL6 SCC KD	103356
3880 SECT US32D WLM	101349
3880 SECT US32D WLM FULL6 SCC KD	102988
3880 SECT US32D WLS	103720
3880 SECT US32D WLS FULL6 SCC KD	103721
3880 SECT US32D AUG FULL6 SCC KD	124258
3880 SECT US32D WTN	101341
3880 SECT US32D WTN FULL6 SCC KD	102984
3880 SECT US32D WTS	103353
3880 SECT US32D WTS FULL6 SCC KD	103354

3881

3881 ESC US26D ARC REV 1	115636
3881 ESC US26D ARC FULL6 SCC KD REV 1	115637
3881 ESC US26D ARB REV 1	115638
3881 ESC US26D ARB FULL6 SCC KD REV 1	115640
3881 ESC US26D WLM REV 1	115641
3881 ESC US26D WLM FULL6 SCC KD REV 1	115642
3881 ESC US26D WLB REV 1	115643
3881 ESC US26D WLB FULL6 SCC KD REV 1	115645
3881 ESC US26D AUB REV 1	146081
3881 ESC US26D WTN REV 1	115646
3881 ESC US26D WTN FULL6 SCC KD REV 1	115647
3881 ESC US26D WTB REV 1	115648
3881 ESC US26D WTB FULL6 SCC KD REV 1	115649
3881 ESC US32D ARC REV 1	115650
3881 ESC US32D ARC FULL6 SCC KD REV 1	115651
3881 ESC US32D ARS REV 1	115652
3881 ESC US32D ARS FULL6 SCC KD REV 1	115653
3881 ESC US32D WLM REV 1	115654
3881 ESC US32D WLM FULL6 SCC KD REV 1	115655
3881 ESC US32D WLS REV 1	115681
3881 ESC US32D WLS FULL6 SCC KD REV 1	115682
3881 ESC US32D WTN REV 1	115683
3881 ESC US32D WTN FULL6 SCC KD REV 1	115684
3881 ESC US32D WTS REV 1	115685
3881 ESC US32D WTS FULL6 SCC KD REV 1	115686
3881 SECT US26D ARC REV 1	115687
3881 SECT US26D ARC FULL6 SCC KD REV 1	115689
3881 SECT US26D ARB REV 1	115690
3881 SECT US26D ARB FULL6 SCC KD REV 1	115691
3881 SECT US26D WLM REV 1	115692
3881 SECT US26D WLM FULL6 SCC KD REV 1	115693
3881 SECT US26D WLB REV 1	115694
3881 SECT US26D WLB FULL6 SCC KD REV 1	115695
3881 SECT US26D AUG REV.1	123601
3881 SECT US26D AUG FULL6 SCC KD REV 1	130006
3881 SECT US26D WTN REV 1	115696
3881 SECT US26D WTN FULL6 SCC KD REV 1	115697

3881

3881 SECT US26D WTB REV 1	115763
3881 SECT US26D WTB FULL6 SCC KD REV 1	115764
3881 SECT US3 WTN REV. 1	128042
3881 SECT US3 WTN FULL6 SCC KD REV 1	136709
3881 SECT US32D ARC REV 1	115765
3881 SECT US32D ARC FULL6 SCC KD REV 1	115766
3881 SECT US32D ARS REV 1	115767
3881 SECT US32D ARS FULL6 SCC KD REV 1	115768
3881 SECT US32D WLM REV 1	115769
3881 SECT US32D WLM FULL6 SCC KD REV 1	115770
3881 SECT US32D WLS REV 1	115771
3881 SECT US32D WLS FULL6 SCC KD REV 1	115772
3881 SECT US32D AUG FULL6 SCC KD REV1	146044
3881 SECT US32D WTN REV 1	115773
3881 SECT US32D WTN FULL6 SCC KD REV 1	115774
3881 SECT US32D WTS REV 1	115775
3881 SECT US32D WTS FULL6 SCC KD REV 1	115776

Items with the price in **bold and red** are Quick Ship Items and ship in 24 hours.



One Family. One Brand. One Vision.™

www.hagerco.com

TABLE OF CONTENTS

A		
Arms, 5100 Series		
Main Arm Assembly.....	6	
Extra Heavy Duty Parallel.....	6	
Extra Heavy Duty Hold Open	7	
Extra Heavy Duty Stop	7	
Extra Heavy Duty Hold Open Stop	8	
Extra Heavy Duty Hold Open Cushion Stop	8	
Extra Heavy Duty Cushion Stop	8	
Standard Hold Open	6	
Arms, 5200 Series		
Main Arm Assembly.....	11	
Extra Heavy Duty Hold Open Cushion Stop	13	
Extra Heavy Duty Cushion Stop	13	
Extra Heavy Duty.....	12	
Extra Heavy Duty Hold Open	12	
Extra Heavy Duty Hold Open Stop	12	
Extra Heavy Duty Stop	12	
Standard Hold Open	11	
Arms, 5300 Series		
Main Arm Assembly.....	16	
Extra Heavy Duty.....	17	
Extra Heavy Duty Hold Open	17	
Extra Heavy Duty Hold Open Stop	17	
Extra Heavy Duty Stop	17	
Extra Heavy Duty Hold Open Cushion Stop	18	
Extra Heavy Duty Cushion Stop	18	
Standard Hold Open	16	
Arms, 5400 Series		
Main Arm Assembly.....	20	
B		
Blade Stop Spacer		
5100 Series	7	
5200 Series	12	
5300 Series	17	
5400 Series	20	
Body Only		
5100 Series, Cast Iron.....	6	
5200 Series, Aluminum.....	11	
5300 Series, Aluminum.....	16	
5400 Series, Aluminum.....	19	
Brackets		
Extra Clearance, 5100 Series	7	
Extra Clearance, 5200 Series	13	
Extra Clearance, 5300 Series	18	
Extra Clearance, 5400 Series.....	20	
C		
Closers		
5100 Series, Grade 1	5	
5200 Series, Grade 1	10	
5300 Series, Grade 1	15	
5400 Series, Grade 2	19	
Covers		
5100 Series, Full Plastic.....	6	
5100 Series, Metal	8	
5200 Series, Full Plastic.....	11	
5200 Series, Slim Line Plastic	13	
5200 Series, Metal	13	
5300 Series, Full Plastic.....	16	
D		
Drop Plates		
5100 Series, Regular Arm	7	
5100 Series, Low Clearance	7	
5100 Series, Parallel Arm.....	7	
5100 Series, Top Jamb.....	7	
5200 Series, Top Jamb, Narrow Top Rail.....	12	
5200 Series, Narrow Top Rail	13	
5200 Series, Top Jamb, Parallel Arm	13	
5200 Series, Parallel Arm.....	13	
5300 Series, Narrow Rail, Parallel Arm.....	17	
5300 Series, Low Clearance	17	
5300 Series, OH Holder, Narrow.....	17	
E		
Electromagnetic Door Holders & Accessories		
Accessories	22-23	
Floor Mount (Double Door)	21	
Floor Mount (Single Door)	21	
Flush Mount	21	
Recessed Mount.....	21	
Surface Mount.....	21	
H		
High Security Package, 5100 Series.....	6	
How To Order	3-4	



Door Controls

L		S	
Lead Times	2	Screw Packs	
Long Rod and Shoe, 5100 Series.....	7	5100 Series	6-8
Long Rod and Shoe, 5200 Series.....	12	5200 Series	11-12
Long Rod and Shoe, 5300 Series.....	17	5300 Series	16-17
		5400 Series	20
O		Spring Cushion Kit	8, 13, 18
Overhead Door Holders and Stops	24-28	T	
P		Track Arms	
Pinion Cap		5100 Series	6, 8-9
5200 Series	12	5200 Series	11, 13-14
5300 Series	16	5300 Series	16, 18
5400 Series	20		
Q			
Quick Ship.....	2		

INTRODUCTION

Hager door controls offer architects, contractors, and building owners a superior product with proven reliability. In fact, our 5100, 5200, and 5300 Series Grade 1 models are the only closers in the industry that are both BHMA certified and backed by a lifetime warranty. That makes them a no-risk choice for virtually any building type.

With Hager, you get door controls that are packaged with everything needed for quick installation, regardless of the application. Hager door closers are tri-packed for mounting three ways: parallel arm, regular arm, and top jamb. They are non-handed, packaged with a parallel arm bracket and thru-bolts at no extra charge, and adjustable for various door sizes.

Quick Ship

Products denoted with **red and bold** pricing are available to order through the Quick Ship program and ship within 24 hours. When ordering these products please visit www.hagerco.com and log in to MyHager to access the 'Quick Ship' portal. Due to the promptness of the fulfillment process, Quick Ship orders are non-cancellable.

Lead Times

Stock items will typically ship in five working days or less from the order entry date. Made-to-order items will typically ship in 15 working days depending on seasonal volume and order complexity. Special orders including industrials, special machining, and large quantities may need to be scheduled. The anticipated ship date will be included with each order acknowledgement. Please contact Customer Service if product availability is in question.

New Finish

Painted flat black finish (BHMA 693) is now available. Use BLK to designate finish. Extended lead time and MOQ may apply.

Cancellation Notification

Cancellation for made-to-order items must be communicated within 48 hours of order placement.

HOW TO ORDER

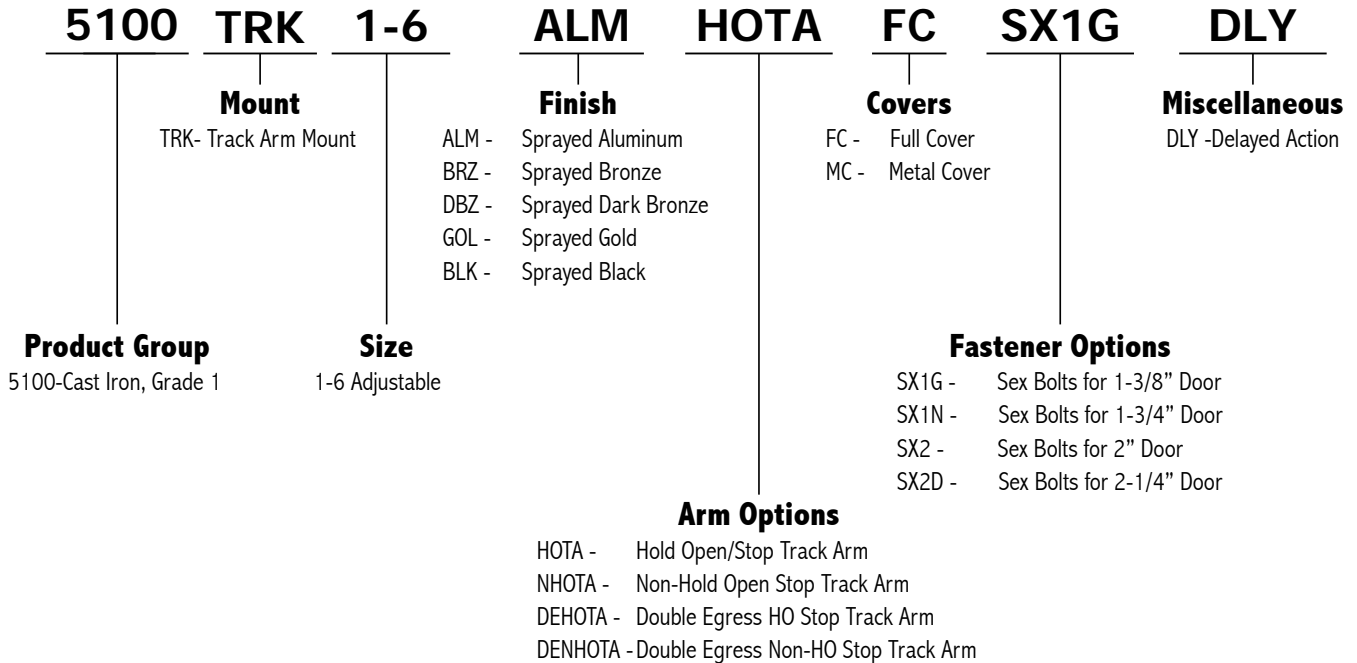

HOW TO ORDER

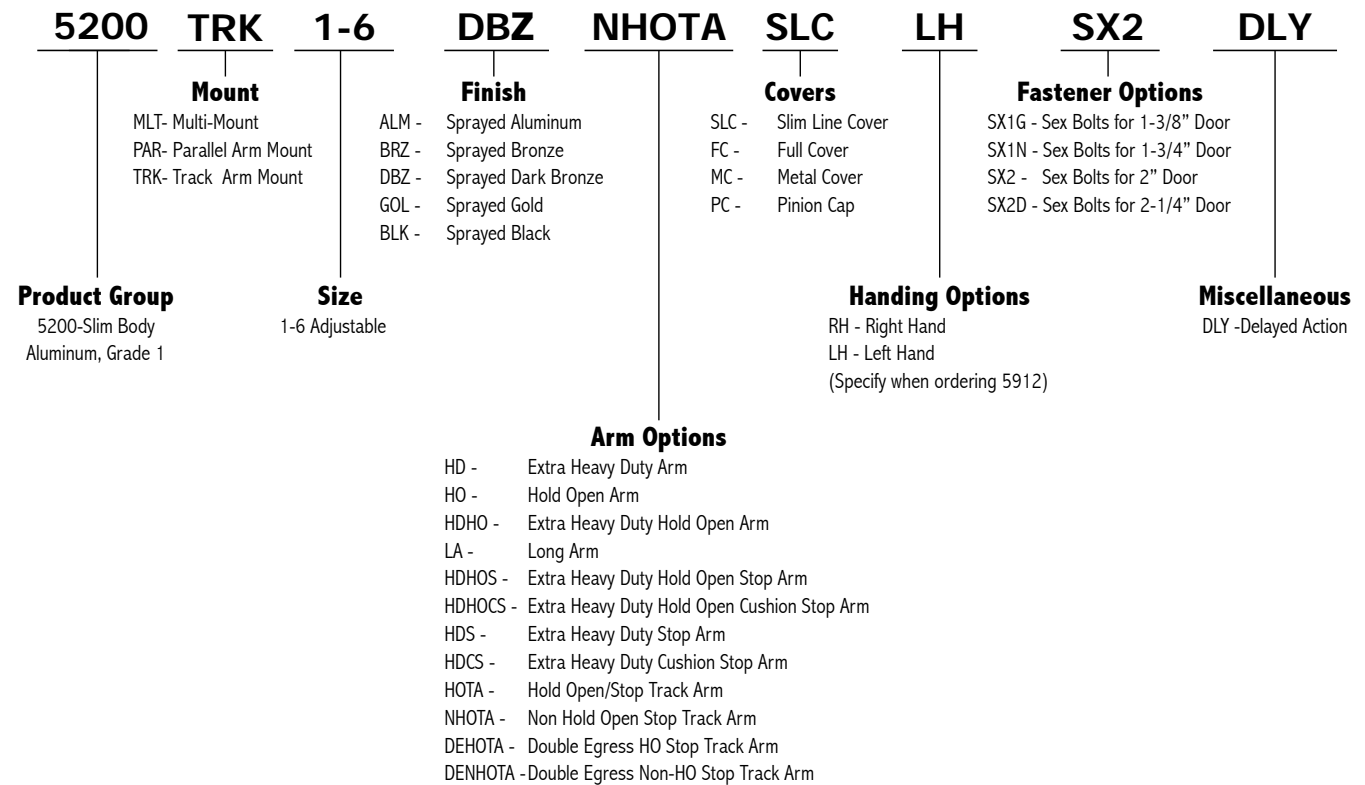

Door Controls

HOW TO ORDER

5300	TRK	1-6	DBZ	HOTA	FC	RH	SX1G	DLY
	Mount MLT- Multi-Mount PAR- Parallel Arm Mount TRK- Track Arm Mount		Finish ALM - Sprayed Aluminum BRZ - Sprayed Bronze DBZ - Sprayed Dark Bronze GOL - Sprayed Gold BLK - Sprayed Black		Covers FC - Full Cover PC - Pinion Cap		Fastener Options SX1G - Sex Bolts for 1-3/8" Door SX1N - Sex Bolts for 1-3/4" Door SX2 - Sex Bolts for 2" Door SX2D - Sex Bolts for 2-1/4" Door	
Product Group 5300 - Aluminum, Grade 1		Size 1-6 Adjustable				Handing Options RH - Right Hand LH - Left Hand (Specify when ordering 5912)		Miscellaneous DLY -Delayed Action
			Arm Options HD - Extra Heavy Duty Arm HO - Hold Open Arm HDHO - Extra Heavy Duty Hold Open Arm LA - Long Arm HDHOS - Extra Heavy Duty Hold Open Stop Arm HDHOCS - Extra Heavy Duty Hold Open Cushion Stop Arm HDS - Extra Heavy Duty Stop Arm HDCS - Extra Heavy Duty Cushion Stop Arm HOTA - Hold Open/Stop Track Arm NHOTA - Non Hold Open Stop Track Arm					





Description	Finish	2018 List	Stock No.	Case Qty.	Box Qty.
5100 Series	ALM	315.65	126470	4	1
Grade 1	BRZ	315.65	126473		
Adjustable sizes 1-6	DBZ	315.65	126472		
	GOL	315.65	126474		
	BLK	315.65	199292		
	US32D	517.30	62640	4	1

ADA (Barrier Free) Door Closers:

Any certified BHMA/ANSI A156.4 door closer, regardless of manufacturer, that is installed and adjusted based on ADA or other reduced opening force requirements may not provide sufficient power to reliably close and latch a door.

If arms are ordered separately, there will be a significant difference in price than if purchased with a closer as a complete assembly. Adders are listed below. Add the list price of the option to the list price of the closer and take standard discounts.

Delayed Action Valve	17.20
Lead Lined Cover	108.15
Check with factory for pricing and availability of plated products other than US32D.	POA





Closers with non-standard arms

5100 Series 1-6 Closer, 5106 extra heavy duty arm, plastic cover	ALM	362.50	130952
	BRZ	362.50	130970
	DBZ	362.50	130973
	GOL	362.50	130976
5100 Series 1-6 Closer, 5107 standard hold open arm, plastic cover	ALM	353.65	126475
	BRZ	353.65	130899
	DBZ	353.65	130947
	GOL	353.65	130951
5100 Series 1-6 Closer, 5108 extra heavy duty hold open arm, plastic cover (left hand)	ALM	362.50	130956
	BRZ	362.50	149871
	DBZ	362.50	151034
	GOL	362.50	156482
5100 Series 1-6 Closer, 5108 extra heavy duty hold open arm , plastic cover (right hand)	ALM	362.50	130957
	BRZ	362.50	149872
	DBZ	362.50	151033
	GOL	362.50	156483
5100 Series 1-6 Closer, 5125 extra heavy duty stop arm, plastic cover	ALM	362.50	130961
	BRZ	362.50	130972
	DBZ	362.50	130975
	GOL	362.50	130978
5100 Series 1-6 Closer, 5954 extra heavy duty hold open cushion stop arm, plastic cover	ALM	498.75	130959
	BRZ	498.75	149499
	DBZ	498.75	148985
	GOL	498.75	154060
5100 Series 1-6 Closer, 5955 extra heavy cushion stop arm, plastic cover	ALM	453.20	130962
	BRZ	453.20	151220
	DBZ	453.20	150847
	GOL	453.20	155760
5100 Series 1-6 Closer, 5961 extra heavy hold open stop arm, plastic cover	ALM	409.15	130958
	BRZ	409.15	130971
	DBZ	409.15	130974
	GOL	409.15	130977

1. Items with the price in **bold and red** are Quick Ship items and ship in 24 hours.
Please use stock number when ordering. 2. U/M is each unless otherwise noted.



Door Controls - 5100 Series

Description	Finish	2018 List	Stock No.	Case Qty.	Box Qty.
5100M16ALMOMOX 5100 Series High Security Package Package Contains: Closer, main arm assembly, parallel arm bracket, standard screw pack, SNB screw pack, torx screw pack and painted metal cover.	ALM	367.10	1521143	4	1
 5100 Closer w/ Non Hold Open Stop Track Arm	ALM	359.35	166331	10	1
	BRZ	359.35	166352		
	DBZ	359.35	166332		
	GOL	359.35	166353		
 5100 Closer w/ Hold Open Stop Track Arm	ALM	372.60	166337	10	1
	BRZ	372.60	166219		
	DBZ	372.60	166338		
	GOL	372.60	167220		
 5100 Closer w/ Double Egress Non Hold Open Stop Track Arm	ALM	388.05	166344	10	1
	BRZ	388.05	167235		
	DBZ	388.05	166345		
	GOL	388.05	167236		
 5100 Closer w/ Double Egress Hold Open Stop Track Arm	ALM	401.30	166348	10	1
	BRZ	401.30	167239		
	DBZ	401.30	166349		
	GOL	401.30	167240		
5101 5100 Series Closer Body Only Adjustable sizes 1-6	ALM	238.55	148803	4	1
	BRZ	238.55	148805		
	DBZ	238.55	148804		
	GOL	238.55	148806		
5102 Full Plastic Cover 5100 Series	ALM	16.65	89003	25	1
	BRZ	16.65	88988		
	DBZ	16.65	88928		
	GOL	16.65	88730		
5103 Main Arm Assembly 5100 Series	ALM	33.00	72038	8	1
	BRZ	33.00	71384		
	DBZ	33.00	71378		
	GOL	33.00	71297		
5104 Standard Screw Pack 5100 Series	ALM	9.30	87683	80	1
	BRZ	9.30	87619		
	DBZ	9.30	87607		
	GOL	9.30	87089		
5106 Extra Heavy Duty Parallel Arm 5100 Series	ALM	90.50	71612	10	1
	BRZ	90.50	71144		
	DBZ	90.50	71129		
	GOL	90.50	71121		
5107 Standard Hold Open Arm 5100 Series	ALM	70.40	65492	10	1
	BRZ	70.40	65430		
	DBZ	70.40	65429		
	GOL	70.40	65422		



Door Controls - 5100 Series



Description	Finish	2018 List	Stock No.	Case Qty.	Box Qty.
5108 Extra Heavy Duty Hold Open Arm 5100 Series Specify handing when ordering.	ALM	90.50	72742	10	1
	BRZ	90.50	71054		
	DBZ	90.50	71053		
	GOL	90.50	70883		
5109 Drop Plate - Regular Arm Mount w/ Screws 5100 Series	ALM	40.00	62245	10	1
	BRZ	40.00	62028		
	DBZ	40.00	61745		
5110 Drop Plate - Parallel Arm Mount w/ Screws 5100 Series	ALM	40.00	61739	10	1
	BRZ	40.00	61735		
	DBZ	40.00	61726		
5111 Extra Heavy Duty Parallel Arm Bracket 5100 Series	ALM	16.65	61676	10	1
	BRZ	16.65	61506		
	DBZ	16.65	61432		
5112 Long Rod and Shoe 5100 Series For door reveals between 3" - 5".	ALM	16.65	98370	10	1
	BRZ	16.65	97617		
	DBZ	16.65	95821		
5113 Blade Stop Spacer	ALM	24.80	95278	15	1
	BRZ	24.80	95276		
	DBZ	24.80	94728		
5114 Drop Plate Low Clearance Top Jamb Mount w/ Screws 5100 Series	ALM	40.00	36332	10	1
	BRZ	40.00	36326		
	DBZ	40.00	36325		
5115 Drop Plate Top Jamb Mount w/ Screws 5100 Series	ALM	40.00	23471	10	1
	BRZ	40.00	36431		
	DBZ	40.00	36430		
5125 Extra Heavy Duty Stop Arm 5100 Series Can be combined with 5950, spring cushion kit.	ALM	90.50	120769	10	1
	BRZ	90.50	120770		
	DBZ	90.50	120771		
5909 Parallel Arm Bracket 5100 Series	ALM	8.40	63220	20	1
	BRZ	8.40	63101		
	DBZ	8.40	63100		
5935 2" Extra Clearance Bracket 5100 Series	ALM	21.85	129572	36	6
	BRZ	21.85	129574		
	DBZ	21.85	129575		
5940 SNB Screw Pack, 1-3/4" Door 5100 Series	ALM	9.30	104380	200	1
	BRZ	9.30	104381		
	DBZ	9.30	104382		
	GOL	9.30	104383		

1. Items with the price in **bold and red** are Quick Ship items and ship in 24 hours.
Please use stock number when ordering. 2. U/M is each unless otherwise noted.



Door Controls - 5100 Series



Description	Finish	2018 List	Stock No.	Case Qty.	Box Qty.
5941 SNB Screw Pack, 1-3/8" Door 5100 Series	ALM	9.30	104384	200	1
	BRZ	9.30	104385		
	DBZ	9.30	104386		
	GOL	9.30	104387		
5942 SNB Screw Pack, 2" Door 5100 Series	ALM	9.30	104388	200	1
	BRZ	9.30	104389		
	DBZ	9.30	104390		
	GOL	9.30	104391		
5943 SNB Screw Pack, 2-1/4" Door 5100 Series	ALM	9.30	104392	200	1
	BRZ	9.30	104393		
	DBZ	9.30	104394		
	GOL	9.30	104395		
5946 Tamper Resistant Torx Screwpack Sex Nuts and Bolts for 1-3/4" (44mm) doors 5100 Series Only	ALM	28.65	148410	1000	1
5950 Spring Cushion Kit 5100/5200/5300 Series	ALM	121.45	118353	10	1
	BRZ	121.45	120777		
	DBZ	121.45	120779		
	GOL	121.45	120780		
5954 Extra Heavy Duty Hold Open Cushion Stop Arm 5100 Series Includes 5961 and 5950.	ALM	253.85	118337	10	1
	BRZ	253.85	118338		
	DBZ	253.85	118339		
	GOL	253.85	118340		
5955 Extra Heavy Duty Cushion Stop Arm 5100 Series Includes 5125 and 5950.	ALM	218.45	118341	10	1
	BRZ	218.45	118342		
	DBZ	218.45	118343		
	GOL	218.45	118344		
5961 Extra Heavy Duty Hold Open Stop Arm Can be combined with 5950, spring cushion kit.	ALM	180.70	192281	10	1
	BRZ	180.70	192282		
	DBZ	180.70	192283		
	GOL	180.70	192284		
5962 5100 Series Plated Metal Cover (Check with factory for availability)	US32D	201.65	198227	25	1
	ALM / Painted	141.15	144034		
	DBZ / Painted	141.15	144035		
2-659-0145 Non Hold Open Stop Track Arm 5100 Series	ALM	87.55	167833	10	1
2-659-0144 Non Hold Open Stop Track Arm 5100 Series	BRZ	87.55	162731		
2-659-0143 Non Hold Open Stop Track Arm 5100 Series	DBZ	87.55	162718		
2-659-0142 Non Hold Open Stop Track Arm 5100 Series	GOL	87.55	162719		



Door Controls - 5100 Series



Description	Finish	2018 List	Stock No.	Case Qty.	Box Qty.
2-659-0137 Hold Open Stop Track Arm 5100 Series	ALM	100.95	167857	10	1
2-659-0136 Hold Open Stop Track Arm 5100 Series	BRZ	100.95	167858		
2-659-0135 Hold Open Stop Track Arm 5100 Series	DBZ	100.95	167859		
2-659-0134 Hold Open Stop Track Arm 5100 Series	GOL	100.95	167860		
2-659-0203 Double Egress Non Hold Open Stop Track Arm 5100 Series	ALM	125.65	167865	10	1
2-659-0204 Double Egress Non Hold Open Stop Track Arm 5100 Series	BRZ	125.65	167866		
2-659-0205 Double Egress Non Hold Open Stop Track Arm 5100 Series	DBZ	125.65	167867		
2-659-0206 Double Egress Non Hold Open Stop Track Arm 5100 Series	GOL	125.65	167868		
2-659-0207 Double Egress Hold Open Stop Track Arm 5100 Series	ALM	144.20	167869	10	1
2-659-0208 Double Egress Hold Open Stop Track Arm 5100 Series	BRZ	144.20	167870		
2-659-0209 Double Egress Hold Open Stop Track Arm 5100 Series	DBZ	144.20	167871		
2-659-0210 Double Egress Hold Open Stop Track Arm 5100 Series	GOL	144.20	167873		

Track arms only available in painted finishes shown

1. Items with the price in **bold and red** are Quick Ship items and ship in 24 hours.
Please use stock number when ordering. 2. U/M is each unless otherwise noted.



Door Controls - 5200 Series



Description	Finish	2018 List	Stock No.	Case Qty.	Box Qty.
5200 Series	ALM	236.80	126476	6	1
Grade 1	BRZ	236.80	126478		
Adjustable sizes 1-6	DBZ	236.80	126477		
	GOL	236.80	126479		
	BLK	236.80	199553		
	US32D	401.06	62634	6	1

ADA (Barrier Free) Door Closers:

Any certified BHMA/ANSI A156.4 door closer, regardless of manufacturer, that is installed and adjusted based on ADA or other reduced opening force requirements may not provide sufficient power to reliably close and latch a door.

If arms are ordered separately, there will be a significant difference in price than if purchased with a closer as a complete assembly.

Adders are listed below. Add the list price of the option to the list price of the closer and take standard discounts.

Delayed Action Valve	17.20
Lead Lined Cover	108.15
Check with factory for pricing and availability of plated products other than US32D.	POA

Closers with non-standard arms

5200 Series 1-6 Closer, 5203 tri-pack arm, slim line plastic cover	ALM	236.80	145551
	BRZ	236.80	166442
	DBZ	236.80	149176
	GOL	236.80	151746
5200 Series 1-6 Closer, 5910 hold open arm, plastic cover	ALM	275.40	145539
	BRZ	275.40	145540
	DBZ	275.40	145541
	GOL	275.40	145542
5200 Series 1-6 Closer, 5906 extra heavy duty hold open stop arm, plastic cover	ALM	331.75	145552
	BRZ	331.75	145556
	DBZ	331.75	145557
	GOL	331.75	145558
5200 Series 1-6 Closer, 5907 extra heavy duty stop arm, plastic cover	ALM	284.40	145560
	BRZ	284.40	145561
	DBZ	284.40	145562
	GOL	284.40	145563
5200 Series 1-6 Closer, 5911 extra heavy duty arm, plastic cover	ALM	300.05	149447
	BRZ	300.05	154453
	DBZ	300.05	148832
	GOL	300.05	155891
5200 Series 1-6 Closer, 5912 extra heavy duty hold open arm, plastic cover (left hand)	ALM	271.90	148835
	BRZ	271.90	163413
	DBZ	271.90	153689
	GOL	271.90	156741
5200 Series 1-6 Closer, 5912 extra heavy duty hold open arm, plastic cover (right hand)	ALM	271.90	148839
	BRZ	271.90	163414
	DBZ	271.90	153858
	GOL	271.90	156742
5200 Series 1-6 Closer, 5956 extra heavy duty hold open cushion stop arm, plastic cover	ALM	422.30	149802
	BRZ	422.30	151691
	DBZ	422.30	149732
	GOL	422.30	162296



Door Controls - 5200 Series

Description	Finish	2018 List	Stock No.	Case Qty.	Box Qty.
5200 Series 1-6 Closer, 5957 extra heavy duty cushion stop arm, plastic cover	ALM	383.15	149011		
	BRZ	383.15	162252		
	DBZ	383.15	148977		
	GOL	383.15	162991		
5200 Closer w/ Non Hold Open Stop Track Arm	ALM	282.10	166333	10	1
	BRZ	282.10	166354		
	DBZ	282.10	166334		
	GOL	282.10	167045		
5200 Closer w/ Hold Open Stop Track Arm	ALM	295.55	166339	10	1
	BRZ	295.55	167223		
	DBZ	295.55	166341		
	GOL	295.55	137224		
5200 Closer w/ Double Egress Non Hold Open Stop Track Arm	ALM	324.60	166350	10	1
	BRZ	324.60	167241		
	DBZ	324.60	166351		
	GOL	324.60	167242		
5200 Closer w/ Double Egress Hold Open Stop Track Arm	ALM	311.15	166346	10	1
	BRZ	311.15	167237		
	DBZ	311.15	166347		

Description	Finish	2018 List	Stock No.	Case Qty.	Box Qty.
5201 5200 Series Closer Body Only Adjustable sizes 1-6	ALM	167.10	148807	6	1
	BRZ	167.10	148809		
	DBZ	167.10	148808		
	GOL	167.10	148810		
5202 Full Plastic Cover 5200 Series	ALM	16.65	88651	25	1
	BRZ	16.65	88532		
	DBZ	16.65	88355		
	GOL	16.65	88343		
5203 Main Arm Assembly 5200 Series	ALM	33.00	71694	8	1
	BRZ	33.00	71296		
	DBZ	33.00	70681		
	GOL	33.00	71271		
5204 Standard Screw Pack 5200 Series	ALM	9.60	72358	80	1
	BRZ	9.60	72236		
	DBZ	9.60	72228		
	GOL	9.60	70684		
5910 Standard Hold Open Arm 5200 Series If ordered separately, 5914, Rev 1 needed for parallel mount.	ALM	72.45	191400	10	1
	BRZ	72.45	191402		
	DBZ	72.45	191401		
	GOL	72.45	191403		
5900 Parallel Arm Bracket 5200/5300/5400 Series	ALM	8.40	99140	120	1
	BRZ	8.40	99138		
	DBZ	8.40	99135		
	GOL	8.40	99134		
5902 SNB Screw Pack, 1-3/4" Door 5200/5300/5400 Series	ALM	9.60	99129	200	1
	BRZ	9.60	99128		
	DBZ	9.60	99127		
	GOL	9.60	99126		



1. Items with the price in **bold and red** are Quick Ship items and ship in 24 hours.
Please use stock number when ordering. 2. U/M is each unless otherwise noted.



Door Controls - 5200 Series



Description	Finish	2018 List	Stock No.	Case Qty.	Box Qty.
5903 SNB Screw Pack, 1-3/8" Door 5200/5300/5400 Series	ALM	9.60	99125	200	1
	BRZ	9.60	99124		
	DBZ	9.60	99123		
	GOL	9.60	99122		
5904 SNB Screw Pack, 2" Door 5200/5300/5400 Series	ALM	9.60	9921	200	1
	BRZ	9.60	99118		
	DBZ	9.60	99117		
	GOL	9.60	99116		
5905 SNB Screw Pack, 2-1/4" Door 5200/5300/5400 Series	ALM	9.60	99115	200	1
	BRZ	9.60	99114		
	DBZ	9.60	99113		
	GOL	9.60	99112		
5906 Extra Heavy Duty Hold Open Stop Arm 5200/5300 Series Can be combined with 5950, spring cushion kit.	ALM	180.70	14583	10	1
	BRZ	180.70	14582		
	DBZ	180.70	14578		
	GOL	180.70	14570		
5907 Extra Heavy Duty Stop Arm 5200/5300 Series Can be combined with 5950, spring cushion kit.	ALM	90.50	14595	10	1
	BRZ	90.50	14591		
	DBZ	90.50	14587		
	GOL	90.50	14586		
5908 Long Rod and Shoe 5200/5300 Series	ALM	16.65	35989	25	1
	BRZ	16.65	35988		
	DBZ	16.65	35941		
	GOL	16.65	35929		
5911 Extra Heavy Duty Arm 5200/5300 Series	ALM	90.50	73657	10	1
	BRZ	90.50	73656		
	DBZ	90.50	73607		
	GOL	90.50	73487		
5912 Extra Heavy Duty Hold Open Arm 5200/5300 Series Specify handing when ordering.	ALM	90.50	73446	10	1
	BRZ	90.50	73317		
	DBZ	90.50	73347		
	GOL	90.50	73283		
5913 Blade Stop Spacer 5200/5300/5400 Series	ALM	25.55	73268	15	1
	BRZ	25.55	73244		
	DBZ	25.55	73076		
	GOL	25.55	73074		
5914 Hold Open Parallel Arm Bracket 5200/5300 Series For standard hold-open arm.	ALM	16.65	72936	60	1
	BRZ	16.65	72905		
	DBZ	16.65	72907		
	GOL	16.65	72814		
5918 Drop Plate - Top Jamb Narrow Top Rail w/ Mounting Screws 5200 Series For use with slim line or no cover.	ALM	41.20	72262	10	1
	BRZ	41.20	72242		
	DBZ	41.20	72248		
	GOL	41.20	72241		
5919 Pinion Cap 5200 Series	ALM	1.85	72138	20	1
	BRZ	1.85	70989		
	DBZ	1.85	70779		
	GOL	1.85	70765		





Description	Finish	2018 List	Stock No.	Case Qty.	Box Qty.
5920 Slim Line Plastic Cover 5200 Series	ALM	16.65	70962	18	1
	BRZ	16.65	70859		
	DBZ	16.65	70987		
	GOL	16.65	70984		
5921 Drop Plate Narrow Top Rail w/ Mounting Screws 5200 Series For use with full cover.	ALM	40.00	33996	10	1
	BRZ	40.00	33994		
	DBZ	40.00	33980		
	GOL	40.00	33979		
5922 Drop Plate - Top Jamb Parallel Arm with Mounting Screws 5200 Series For use with slim line or no cover.	ALM	40.00	33957	10	1
	BRZ	40.00	33943		
	DBZ	40.00	33941		
	GOL	40.00	33940		
5923 Drop Plate Parallel Arm with Mounting Screws 5200 Series For use with full cover.	ALM	40.00	33947	10	1
	BRZ	40.00	33936		
	DBZ	40.00	33934		
	GOL	40.00	33929		
5932 Plated Metal Cover (Check with factory for availability) 5200 Series	US32D	164.25	198229	25	1
	ALM (painted)	164.25	191374		
5936 Extra Clearance Bracket 5200/5300 Series	ALM	21.85	129577	48	8
	BRZ	21.85	129578		
	DBZ	21.85	129579		
	GOL	21.85	129580		
5950 Spring Cushion Kit 5100/5200/5300 Series	ALM	121.45	118353	10	1
	BRZ	121.45	120777		
	DBZ	121.45	120779		
	GOL	121.45	120780		
5956 Extra Heavy Duty Hold Open Cushion Stop Arm 5200/5300 Series Includes 5906 and 5950.	ALM	253.85	118345	10	1
	BRZ	253.85	118346		
	DBZ	253.85	118347		
	GOL	253.85	118348		
5957 Extra Heavy Duty Cushion Stop Arm 5200/5300 Series Includes 5907 and 5950.	ALM	218.45	118349	10	1
	BRZ	218.45	118350		
	DBZ	218.45	118351		
	GOL	218.45	118352		
2-659-0141 Non Hold Open Stop Track Arm 5200 Series	ALM	87.55	167837	10	1
	BRZ	87.55	167854		
	DBZ	87.55	167855		
	GOL	87.55	167856		

1. Items with the price in **bold and red** are Quick Ship items and ship in 24 hours.
Please use stock number when ordering. 2. U/M is each unless otherwise noted.



Door Controls - 5200 Series



Description	Finish	2018 List	Stock No.	Case Qty.	Box Qty.
2-659-0350 Hold Open Stop Track Arm 5200 Series	ALM	100.95	167861	10	1
2-659-0351 Hold Open Stop Track Arm 5200 Series	BRZ	100.95	167862		
2-659-0352 Hold Open Stop Track Arm 5200 Series	DBZ	100.95	167863		
2-659-0353 Hold Open Stop Track Arm 5200 Series	GOL	100.95	167864		
2-659-0211 Double Egress Non Hold Open Stop Track Arm 5200 Series	ALM	125.65	167874	10	1
2-659-0212 Double Egress Non Hold Open Stop Track Arm 5200 Series	BRZ	125.65	167875		
2-659-0213 Double Egress Non Hold Open Stop Track Arm 5200 Series	DBZ	125.65	167876		
2-659-0214 Double Egress Non Hold Open Stop Track Arm 5200 Series	GOL	125.65	167877		
2-659-0215 Double Egress Hold Open Stop Track Arm 5200 Series	ALM	144.20	167878	10	1
2-659-0216 Double Egress Hold Open Stop Track Arm 5200 Series	BRZ	144.20	167879		
2-659-0217 Double Egress Hold Open Stop Track Arm 5200 Series	DBZ	144.20	167880		
2-659-0218 Double Egress Hold Open Stop Track Arm 5200 Series	GOL	144.20	167881		

Track arms only available in painted finishes shown





Description	Finish	2018 List	Stock No.	Case Qty.	Box Qty.
5300 Series	ALM	189.20	145672	6	1
Grade 1	BRZ	189.20	145673		
Adjustable sizes 1-6	DBZ	189.20	145674		
	GOL	189.20	145675		
	BLK	189.20	199793		

ADA (Barrier Free) Door Closers:

Any certified BHMA/ANSI A156.4 door closer, regardless of manufacturer, that is installed and adjusted based on ADA or other reduced opening force requirements may not provide sufficient power to reliably close and latch a door.

If arms are ordered separately, there will be a significant difference in price than if purchased with a closer as a complete assembly. Adders are listed below. Add the list price of the option to the list price of the closer and take standard discounts.

Delayed Action Valve	17.20
Lead Lined Cover	108.15
Check with factory for pricing and availability of plated products.	POA

Closers with non-standard arms

5300 Series 1-6 Closer, 5910 hold open arm, plastic cover	ALM	226.70	145676
	BRZ	226.70	145677
	DBZ	226.70	145678
	GOL	226.70	145679
5300 Series 1-6 Closer, 5906 extra heavy duty hold open stop arm, plastic cover	ALM	281.40	145681
	BRZ	281.40	145682
	DBZ	281.40	145683
	GOL	281.40	145684
5300 Series 1-6 Closer, 5907 extra heavy duty stop arm, plastic cover	ALM	235.40	145686
	BRZ	235.40	174460
	DBZ	235.40	145687
	GOL	235.40	164629
5300 Series 1-6 Closer, 5911 extra heavy duty arm, plastic cover	ALM	235.40	150366
	BRZ	235.40	173792
	DBZ	235.40	152815
	GOL	235.40	
5300 Series 1-6 Closer, 5912 extra heavy duty hold open arm, plastic cover (left hand)	ALM	222.50	152972
	BRZ	222.50	
	DBZ	222.50	154681
	GOL	222.50	
5300 Series 1-6 Closer, 5912 extra heavy duty hold open arm, plastic cover (right hand)	ALM	222.50	152973
	BRZ	222.50	
	DBZ	222.50	154682
	GOL	222.50	
5300 Series 1-6 Closer, 5956 extra heavy duty hold open cushion stop arm, plastic cover	ALM	369.65	150916
	BRZ	369.65	171199
	DBZ	369.65	160007
	GOL	369.65	
5300 Series 1-6 Closer, 5957 extra heavy duty cushion stop arm, plastic cover	ALM	329.60	149230
	BRZ	329.60	149807
	DBZ	329.60	149013
	GOL	329.60	173080

1. Items with the price in **bold and red** are Quick Ship items and ship in 24 hours.
Please use stock number when ordering. 2. U/M is each unless otherwise noted.



Door Controls - 5300 Series















5300 Closer w/ Non Hold Open Stop Track Arm	ALM	233.60	166335	10	1
	BRZ	233.60	167062		
	DBZ	233.60	166336		
	GOL	233.60	167217		
5300 Closer w/ Hold Open Stop Track Arm	ALM	245.55	166342	10	1
	BRZ	245.55	167225		
	DBZ	245.55	166343		
	GOL	245.55	167234		

Description	Finish	2018 List	Stock No.	Case Qty.	Box Qty.
5301 Closer Body Only Adjustable sizes 1-6	ALM	121.75	148811	6	1
	BRZ	121.75	148813		
	DBZ	121.75	148812		
	GOL	121.75	148814		
5302 Full Plastic Cover 5300 Series	ALM	16.65	88207	25	1
	BRZ	16.65	87873		
	DBZ	16.65	87843		
	GOL	16.65	87785		
5303 Main Arm Assembly 5300 Series	ALM	33.00	71270	8	1
	BRZ	33.00	71255		
	DBZ	33.00	71254		
	GOL	33.00	71234		
5304 Standard Screw Pack 5300 Series	ALM	9.60	72356	80	1
	BRZ	9.60	72210		
	DBZ	9.60	72180		
	GOL	9.60	72174		
5910 Standard Hold Open Arm 5300 Series If ordered separately, 5914, Rev 1 needed for parallel mount.	ALM	72.45	191400	10	1
	BRZ	72.45	191402		
	DBZ	72.45	191401		
	GOL	72.45	191403		
5900 Parallel Arm Bracket 5200/5300/5400 Series	ALM	8.40	99140	120	1
	BRZ	8.40	99138		
	DBZ	8.40	99135		
	GOL	8.40	99134		
5901 Pinion Cap 5300/5400 Series	ALM	1.90	99133	200	1
	BRZ	1.90	99132		
	DBZ	1.90	99131		
	GOL	1.90	99130		1
5902 SNB Screw Pack, 1-3/4" Door 5200/5300/5400 Series	ALM	9.60	99129	200	1
	BRZ	9.60	99128		
	DBZ	9.60	99127		
	GOL	9.60	99126		
5903 SNB Screw Pack, 1-3/8" Door 5200/5300/5400 Series	ALM	9.60	99125	200	1
	BRZ	9.60	99124		
	DBZ	9.60	99123		
	GOL	9.60	99122		



Door Controls - 5300 Series

Description	Finish	2018 List	Stock No.	Case Qty.	Box Qty.
 5904 SNB Screw Pack, 2" Door 5200/5300/5400 Series	ALM	9.60	99121	200	1
	BRZ	9.60	99118		
	DBZ	9.60	99117		
	GOL	9.60	99116		
 5905 SNB Screw Pack, 2-1/4" Door 5200/5300/5400 Series	ALM	9.60	99115	200	1
	BRZ	9.60	99114		
	DBZ	9.60	99113		
	GOL	9.60	99112		
 5906 Extra Heavy Duty Hold Open Stop Arm 5200/5300 Series Can be combined with 5950, spring cushion kit.	ALM	180.70	14583	10	1
	BRZ	180.70	14582		
	DBZ	180.70	14578		
	GOL	180.70	14570		
 5907 Extra Heavy Duty Stop Arm 5200/5300 Series Can be combined with 5950, spring cushion kit.	ALM	90.50	14595	10	1
	BRZ	90.50	14591		
	DBZ	90.50	14587		
	GOL	90.50	14586		
 5908 Long Rod and Shoe 5200/5300 Series	ALM	16.65	35989	25	1
	BRZ	16.65	35988		
	DBZ	16.65	35941		
	GOL	16.65	35929		
 5911 Extra Heavy Duty Arm 5200/5300 Series	ALM	90.50	73657	10	1
	BRZ	90.50	73656		
	DBZ	90.50	73607		
	GOL	90.50	73487		
 5912 Extra Heavy Duty Hold Open Arm 5200/5300 Series Specify handing when ordering.	ALM	90.50	73446	10	1
	BRZ	90.50	73317		
	DBZ	90.50	73347		
	GOL	90.50	73283		
 5913 Blade Stop Spacer 5200/5300/5400 Series	ALM	25.55	73268	15	1
	BRZ	25.55	73244		
	DBZ	25.55	73076		
	GOL	25.55	73074		
 5914 Hold Open Parallel Arm Bracket 5200/5300 Series For standard hold-open arm.	ALM	16.65	72936	60	1
	BRZ	16.65	72905		
	DBZ	16.65	72907		
	GOL	16.65	72814		
 5915 Drop Plate - OH Holder Narrow Rail w/ Mounting Screws 5300 Series For use with full cover.	ALM	40.00	72754	10	1
	BRZ	40.00	72741		
	DBZ	40.00	72750		
	GOL	40.00	72673		
 5916 Drop Plate - Narrow Rail Parallel Arm Cover w/ Mounting Screws 5300 Series For use with full cover.	ALM	40.00	72669	10	1
	BRZ	40.00	72500		
	DBZ	40.00	72509		
	GOL	40.00	72468		
 5917 Drop Plate - Low Clearance Overhead Holder w/ Mounting Screws 5300 Series For use with no cover.	ALM	40.00	72410	10	1
	BRZ	40.00	72281		
	DBZ	40.00	72372		
	GOL	40.00	72264		

1. Items with the price in **bold and red** are Quick Ship items and ship in 24 hours.
 Please use stock number when ordering. 2. U/M is each unless otherwise noted.



Door Controls - 5300 Series

	Description	Finish	2018 List	Stock No.	Case Qty.	Box Qty.
	5936	ALM	21.85	129577	48	1
	Extra Clearance Bracket	BRZ	21.85	129578		
	5200/5300 Series	DBZ	21.85	129579		
		GOL	21.85	129580		
	5950	ALM	121.45	118353	10	1
	Spring Cushion Kit (sold separately)	BRZ	121.45	120777		
	5100/5200/5300 Series	DBZ	121.45	120779		
		GOL	121.45	120780		
	5956	ALM	253.85	118345	10	1
	Extra Heavy Duty	BRZ	253.85	118346		
	Hold Open Cushion Stop Arm	DBZ	253.85	118347		
	5200/5300 Series	GOL	253.85	118348		
	Includes 5906 and 5950.					
	5957	ALM	218.45	118349	10	1
	Extra Heavy Duty Cushion Stop Arm	BRZ	218.45	118350		
	5200/5300 Series	DBZ	218.45	118351		
		GOL	218.45	118352		
	Includes 5907 and 5950.					
	2-659-0141	ALM	87.55	167837	10	1
	Non Hold Open Stop Track Arm					
	5300 Series					
	2-659-0140	BRZ	87.55	167854		
	Non Hold Open Stop Track Arm					
	5300 Series					
	2-659-0139	DBZ	87.55	167855		
	Non Hold Open Stop Track Arm					
	5300 Series					
2-659-0138	GOL	87.55	167856			
Non Hold Open Stop Track Arm						
5300 Series						
	2-659-0350	ALM	100.95	167861	10	1
	Hold Open Stop Track Arm					
	5300 Series					
	2-659-0351	BRZ	100.95	167862		
	Hold Open Stop Track Arm					
	5300 Series					
	2-659-0352	DBZ	100.95	167863		
	Hold Open Stop Track Arm					
	5300 Series					
2-659-0353	GOL	100.95	167864			
Hold Open Stop Track Arm						
5300 Series						

Track arms only available in painted finishes shown

Door Controls - 5400 Series



Description	Finish	2018 List	Stock No.	Case Qty.	Box Qty.
5400 Series	ALM	116.80	85450	6	1
Grade 2	DBZ	116.80	85449		
Size 2 - 5					
5400 Series Adders:		16.00			
Optional backcheck available (add to list price)					
5401	ALM	89.85	67779	6	1
5400 Series Closer Body	DBZ	89.85	76407		
Only Size 2 - 5					



1. Items with the price in **bold and red** are Quick Ship items and ship in 24 hours.
Please use stock number when ordering. 2. U/M is each unless otherwise noted.



Door Controls - 5400 Series



Description	Finish	2018 List	Stock No.	Case Qty.	Box Qty.
5403 Main Arm Assembly 5400 Series	ALM	29.45	71659	8	1
	BRZ	29.45	71227		
	DBZ	29.45	71218		
	GOL	29.45	71216		
5404 Standard Screw Pack 5400 Series	ALM	9.15	72336	80	1
	BRZ	9.15	72173		
	DBZ	9.15	72171		
	GOL	9.15	72166		
5900 Parallel Arm Bracket 5200/5300/5400 Series	ALM	8.65	99140	120	1
	BRZ	8.65	99138		
	DBZ	8.65	99135		
	GOL	8.65	99134		
5901 Pinion Cap 5300/5400 Series	ALM	1.90	99133	200	1
	BRZ	1.90	99132		
	DBZ	1.90	99131		
	GOL	1.90	99130		
5902 SNB Screw Pack, 1-3/4" Door 5200/5300/5400 Series	ALM	9.60	9129	200	1
	BRZ	9.60	9128		
	DBZ	9.60	9127		
	GOL	9.60	9126		
5903 SNB Screw Pack, 1-3/8" Door 5200/5300/5400 Series	ALM	9.60	99125	200	1
	BRZ	9.60	99124		
	DBZ	9.60	99123		
	GOL	9.60	99122		
5904 SNB Screw Pack, 2" Door 5200/5300/5400 Series	ALM	9.60	9921	200	1
	BRZ	9.60	99118		
	DBZ	9.60	99117		
	GOL	9.60	99116		
5905 SNB Screw Pack, 2-1/4" Door 5200/5300/5400 Series	ALM	9.60	99115	200	1
	BRZ	9.60	99114		
	DBZ	9.60	99113		
	GOL	9.60	99112		
5913 Blade Stop Spacer 5200/5300/5400 Series	ALM	25.55	73268	15	1
	BRZ	25.55	73244		
	DBZ	25.55	73076		
	GOL	25.55	73074		
5402 Full Plastic Cover 5400 Series	ALM	16.65	77881	25	1
	DBZ	16.65	77879		



Door Controls - Electromagnetic Holders

	Description	Voltage	Finish	2018 List	Stock No.	Case Qty.	Box Qty.	
	380F Electromagnetic Door Holder Flush Mount	12 & 24	US3	252.75	122598	25	1	
			L2	252.75	113307			
			LS	252.75	107216			
			24 & 120	US3	252.75	-		
				L2	252.75	143678		
				LS	252.75	107443		
			24 & 220	US3	252.75	142090		
				L2	252.75	-		
				LS	252.75	124474		
	380G Electromagnetic Door Holder Floor Mount (Single Door)	12 & 24	US3	382.35	133360	18	1	
			L2	382.35	-			
			LS	382.35	133362			
			24 & 120	US3	382.35	-		
				L2	382.35	-		
				LS	382.35	111432		
			24 & 220	US3	382.35	-		
				L2	382.35	122342		
				LS	382.35	139500		
	380H Electromagnetic Door Holder Floor Mount (Double Door)	12 & 24	US3	447.15	-	6	1	
			L2	447.15	-			
			LS	447.15	-			
			24 & 120	US3	447.15	-		
				L2	447.15	-		
				LS	447.15	114881		
			24 & 220	US3	447.15	-		
				L2	447.15	-		
				LS	447.15	-		
	380R Electromagnetic Door Holder Recessed Mount	12 & 24	US3	252.75	129952	25	1	
			L2	252.75	130390			
			LS	252.75	107442			
			24 & 120	US3	252.75	-		
				L2	252.75	-		
				LS	252.75	107446		
			24 & 220	US3	252.75	-		
				L2	252.75	-		
				LS	252.75	141037		
	380S Electromagnetic Door Holder Surface Mount	12 & 24	US3	278.65	114503	25	1	
			L2	278.65	113961			
			LS	278.65	107441			
			24 & 120	US3	278.65	120377		
				L2	278.65	116868		
				LS	278.65	107444		
			24 & 220	US3	278.65	-		
				L2	278.65	139499		
				LS	278.65	-		

1. Items with the price in **bold and red** are Quick Ship items and ship in 24 hours.
Please use stock number when ordering. 2. U/M is each unless otherwise noted.



Door Controls - Electromagnetic Holders



Description	Size	Finish	2018 List	Stock No.	Case Qty.	Box Qty.
381A Adjustable Extension Rods	1-1/2"	US3	20.85	107528	25	1
		L2	20.85	107529		
		LS	20.85	107527		
	2"	US3	22.10	107532		
		L2	22.10	107533		
		LS	22.10	107530		
	4"	US3	24.60	107535		
		L2	24.60	107536		
		LS	24.60	107534		
381B Surface Back Box	4"	US3	38.90	107547	50	1
		L2	38.90	107548		
		LS	38.90	107545		
381C Catch Disc	2"	US3	26.00	107550	25	1
		L2	26.00	107551		
		LS	26.00	107549		
381D Drilling Fixture	4"	-	50.00	16654	1	1
381E Extension Rods	1/2"	US3	16.95	107450	25	1
		L2	16.95	107451		
		LS	16.95	107449		
	1"	US3	18.25	107453		
		L2	18.25	107452		
		LS	18.25	107455		
	1-1/2"	US3	19.50	107458		
		L2	19.50	107460		
		LS	19.50	107457		
	2"	US3	20.85	107467		
		L2	20.85	107468		
		LS	20.85	107462		
	3"	US3	22.10	107489		
		L2	22.10	107490		
		LS	22.10	107488		
4"	US3	23.35	107492			
	L2	23.35	107493			
	LS	23.35	107491			



Door Controls - Electromagnetic Holders



Description	Size	Finish	2018 List	Stock No.	Case Qty.	Box Qty.
381H Hardware Package	4"	-	22.10	-	25	1
381S Catch Plate Assembly	4"	US3	64.80	107543	50	1
		L2	64.80	107544		
		LS	64.80	107542		
381W Extension Wrenches (2 pcs.)	4"	-	5.20	107552	25	1

1. Items with the price in **bold and red** are Quick Ship items and ship in 24 hours.
Please use stock number when ordering. 2. U/M is each unless otherwise noted.



Door Controls - Overhead Door Holders and Stops



Description	Material	Finish	2018 List	Stock No.	Case Qty.	Box Qty.
6015 Series						
Medium Duty Surface Mount						
Friction	Stainless steel	US32D/630	165.20	140725	6	1
Size 1	Steel	US10B/640	165.20	140826		
18" - 33" Frame Opening		US3/632	165.20	147008		
		ALM/powder coated	121.20	140886		
Friction	Stainless steel	US32D/630	165.20	140726	6	1
Size 2	Steel	US10B/640	165.20	140827		
33" - 51" Frame Opening		US3/632	165.20	147010		
		ALM/powder coated	121.20	140887		
6015 Series						
Medium Duty Concealed Mount						
Friction	Stainless steel	US32D/630	165.20	140731	6	1
Size 1	Steel	US10B/640	165.20	140832		
18" - 33" Frame Opening		US3/632	165.20	147009		
		ALM/powder coated	121.20	140892		
Friction	Stainless steel	US32D/630	165.20	140732	6	1
Size 2	Steel	US10B/640	165.20	140833		
33" - 51" Frame Opening		US3/632	165.20	147011		
		ALM/powder coated	121.20	140893		
6016 Series						
Medium Duty Surface Mount						
Stop ONLY	Stainless steel	US32D/630	165.20	140720	6	1
Size 1	Steel	US10B/640	165.20	140822		
18" - 33" Frame Opening		US3/632	165.20	147000		
		ALM/powder coated	121.20	140882		
Stop ONLY	Stainless steel	US32D/630	165.20	140721	6	1
Size 2	Steel	US10B/640	165.20	140823		
33" - 51" Frame Opening		US3/632	165.20	147002		
		ALM/powder coated	121.20	140883		
6016 Series						
Medium Duty Concealed Mount						
Stop ONLY	Stainless steel	US32D/630	165.20	140727	6	1
Size 1	Steel	US10B/640	165.20	140828		
18" - 33" Frame Opening		US3/632	165.20	147001		
		ALM/powder coated	121.20	140888		
Stop ONLY	Stainless steel	US32D/630	165.20	140728	6	1
Size 2	Steel	US10B/640	165.20	140829		
33" - 51" Frame Opening		US3/632	165.20	147003		
		ALM/powder coated	121.20	140889		



Door Controls - Overhead Door Holders and Stops



Description	Material	Finish	2018 List	Stock No.	Case Qty.	Box Qty.
6017 Series						
Medium Duty Surface Mount						
Hold Open	Stainless steel	US32D/630	165.20	140722	6	1
Size 1	Steel	US10B/640	165.20	140824		
18" - 33" Frame Opening		US3/632	165.20	147004		
		ALM/powder coated	121.20	140884		
Hold Open	Stainless steel	US32D/630	165.20	140723	6	1
Size 2	Steel	US10B/640	165.20	140825		
33" - 51" Frame Opening		US3/632	165.20	147006		
		ALM/powder coated	121.20	140885		
6017 Series						
Medium Duty Concealed Mount						
Hold Open	Stainless steel	US32D/630	165.20	140729	6	1
Size 1	Steel	US10B/640	165.20	140830		
18" - 33" Frame Opening		US3/632	165.20	147005		
		ALM/powder coated	121.20	140890		
Hold Open	Stainless steel	US32D/630	165.20	140730	6	1
Size 2	Steel	US10B/640	165.20	140831		
33" - 51" Frame Opening		US3/632	165.20	147007		
		ALM/powder coated	121.20	140891		
6000 Series Accessories						
Surface Mounted End Cap and Spring Replacement Kit	2-659-0101	US26D	13.30	141691		
	2-659-0102	US10B	13.30	141692		
	2-659-0103	US3	13.30	141697		
6000 Series Accessories						
Concealed Mounted End Cap and Spring Replacement Kit	2-659-0104	-	13.30	141695		
6000 Series Accessories						
Hold Open Replacement Kit	2-659-0105	-	19.90	141696		
6000 Series Accessories						
Friction Replacement Kit	2-659-0106	-	19.90	141697		
6000 Series Screwpacks						
Standard screwpack includes machine screws, wood screws, sex nuts & bolts for 1-3/4" doors, arm set screws, Allen wrench, for both concealed and surface mounted	2-659-0098	US26D	10.00	141688		
	2-659-0099	US10B	10.00	141689		
	2-659-0100	US3	10.00	141690		
6000 Series Screwpacks						
SNB screwpack includes sex nuts and bolts for 1-3/8" doors	2-659-0107	US26D	7.80	141698		
	2-659-0108	US10B	7.80	141699		
	2-659-0109	US3	7.80	141700		
6000 Series Screwpacks						
SNB screwpack includes sex nuts and bolts for 2" doors	2-659-0110	US26D	7.80	141701		
	2-659-0111	US10B	7.80	141702		
	2-659-0112	US3	7.80	141703		



1. Items with the price in **bold and red** are Quick Ship items and ship in 24 hours.
Please use stock number when ordering. 2. U/M is each unless otherwise noted.

04/24/2020
www.hagerco.com



Door Controls - Overhead Door Holders and Stops



Description	Material	Finish	2018 List	Stock No.	Case Qty.	Box Qty.
6000 Series Screwpacks	2-659-0113	US26D	7.80	141704		
SNB screwpack includes sex nuts and bolts for 2-1/4" doors	2-659-0114	US10B	7.80	141705		
	2-659-0115	US3	7.80	141706		



Description	Material	Finish	2018 List	Stock No.	Case Qty.	Box Qty.
7015 Series Heavy Duty Surface Mount						
Friction	Stainless steel	US32D/630	313.90	140712	6	1
Size 1	Steel	US10B/640	313.90	140814		
23" - 39" Frame Opening		US3/632	313.90	147263		
		ALM/powder coated	253.35	140874		
Friction	Stainless steel	US32D/630	313.90	140713	6	1
Size 2	Steel	US10B/640	313.90	140815		
39" - 54" Frame Opening		US3/632	313.90	147265		
		ALM/powder coated	253.35	140875		

7015 Series Heavy Duty Concealed Mount

Friction	Stainless steel	US32D/630	313.90	140718	6	1
Size 1	Steel	US10B/640	313.90	140820		
23" - 39" Frame Opening		US3/632	313.90	147264		
		ALM/powder coated	253.35	140880		
Friction	Stainless steel	US32D/630	313.90	140719	6	1
Size 2	Steel	US10B/640	313.90	140821		
39" - 54" Frame Opening		US3/632	313.90	147266		
		ALM/powder coated	253.35	140881		



7016 Series Heavy Duty Surface Mount

Stop ONLY	Stainless steel	US32D/630	313.90	140680	6	1
Size 1	Steel	US10B/640	313.90	140805		
23" - 39" Frame Opening		US3/632	313.90	147252		
		ALM/powder coated	253.35	140870		
Stop ONLY	Stainless steel	US32D/630	313.90	140701	6	1
Size 2	Steel	US10B/640	313.90	140807		
39" - 54" Frame Opening		US3/632	313.90	147255		
		ALM/powder coated	253.35	140871		



7016 Series Heavy Duty Concealed Mount

Stop ONLY	Stainless steel	US32D/630	313.90	140714	6	1
Size 1	Steel	US10B/640	313.90	140816		
23" - 39" Frame Opening		US3/632	313.90	147254		
		ALM/powder coated	253.35	140876		
Stop ONLY	Stainless steel	US32D/630	313.90	140715	6	1
Size 2	Steel	US10B/640	313.90	140817		
39" - 54" Frame Opening		US3/632	313.90	147256		
		ALM/powder coated	253.35	140877		



Door Controls - Overhead Door Holders and Stops



Description	Material	Finish	2018 List	Stock No.	Case Qty.	Box Qty.
7017 Series Heavy Duty Surface Mount						
Hold Open	Stainless steel	US32D/630	313.90	140710	6	1
Size 1	Steel	US10B/640	313.90	140810		
23" - 39" Frame Opening		US3/632	313.90	147257		
		ALM/powder coated	253.35	140872		
Hold Open	Stainless steel	US32D/630	313.90	140711	6	1
Size 2	Steel	US10B/640	313.90	140813		
39" - 54" Frame Opening		US3/632	313.90	147261		
		ALM/powder coated	253.35	140873		
7017 Series Heavy Duty Concealed Mount						
Hold Open	Stainless steel	US32D/630	313.90	140716	6	1
Size 1	Steel	US10B/640	313.90	140818		
23" - 39" Frame Opening		US3/632	313.90	147258		
Hold Open	Stainless steel	US32D/630	313.90	140717	6	1
Size 2	Steel	US10B/640	313.90	140819		
39" - 54" Frame Opening		US3/632	313.90	147264		
7000 Series Accessories						
	2-659-0119	US26D	18.20	141711		
Surface Mounted End Cap and	2-659-0120	US10B	18.20	141712		
Spring Replacement Kit	2-659-0121	US3	18.20	141713		
7000 Series Accessories						
	2-659-0122	-	18.20	141714		
Concealed Mounted End Cap and						
Spring Replacement Kit						
7000 Series Accessories						
	2-659-0123	-	22.05	141715		
Hold Open Replacement Kit						
7000 Series Accessories						
	2-659-0124	-	22.05	141716		
Friction Replacement Kit						
7000 Series Screwpacks						
	2-659-0116	US26D	15.20	141707		
Standard screwpack includes	2-659-0117	US10B	15.20	141708		
machine screws, wood screws, sex	2-659-0118	US3	15.20	141709		
nuts & bolts for 1-3/4" doors, arm						
set screws, Allen wrench, for both						
concealed and surface mounted						
7000 Series Screwpacks						
	2-659-0125	US26D	11.00	141717		
SNB screwpack includes sex nuts	2-659-0126	US10B	11.00	141718		
and bolts for 1-3/8" doors	2-659-0127	US3	11.00	141719		
7000 Series Screwpacks						
	2-659-0128	US26D	11.00	141720		
SNB screwpack includes sex nuts	2-659-0129	US10B	11.00	141721		
and bolts for 2" doors	2-659-0130	US3	11.00	141722		



1. Items with the price in **bold and red** are Quick Ship items and ship in 24 hours.
Please use stock number when ordering. 2. U/M is each unless otherwise noted.



Door Controls - Overhead Door Holders and Stops



Description	Material	Finish	2018 List	Stock No.	Case Qty.	Box Qty.
7000 Series Screwpacks	2-659-0131	US26D	11.00	141723		
SNB screwpack includes sex nuts	2-659-0132	US10B	11.00	141724		
and bolts for 2-1/4" doors	2-659-0133	US3	11.00	141725		





One Family. One Brand. One Vision.™

www.hagerco.com

TABLE OF CONTENTS

	Top or Bottom Rod Replacement Kit.....	44
	Trim Handing Pin.....	45
A		
Accessories, 4500 Series Grade 1		
Alarm Kit.....		25
Alarm Kit Latchbolt Monitor Switch.....		28
Alarm Kit Tamper Switch.....		29
Concealed Vertical Rod Bottom Latch Assembly.....		29
Concealed Vertical Rod Top Latch Assembly.....		29
Cylinder Cup Spacer 45PN/47PN	29, 44	
Cylinder Dogging Conversion Kit.....		23
End Cap Replacement Packs (standard and flush).....	26-27	
Extension Rod Kit - 24".....		25
Extension Rod Kit - 36".....		25
Hex Key for Dogging.....		29
Less Bottom Rod Fire Bolt Kit.....		28
Less Bottom Rod Replacement Head Cover Plug.....		28
Photoluminescent Push Bar		29
Replacement Head Covers.....	24-25	
Rod to Rod Connector		28
Rod Guide Replacement Pack.....		26
Spring Cage/Hanging Pin Replacement Pack.....		27
Surface Vertical Rod Top Latch Assembly.....		24
Surface Vertical Rod Bottom Latch Assembly		23
Screwpacks	27-28	
Top or Bottom Latch Cover Replacement Pack.....		27
Top or Bottom Rod Replacement Kits.....		24
Accessories, 4600 Series Grade 1 Narrow Stile		
Alarm Kit.....		35
Alarm Kit Latchbolt Monitor Switch.....		36
Alarm Kit Tamper Switch.....		36
Cylinder Dogging Conversion Kit.....		34
End Cap Replacement Packs (standard and flush).....		36
Hex Key for Dogging.....		36
Rim Replacement Head Cover		36
Concealed Vertical Rod accessories.....		36-37
Accessories, 4700 Series Standard Duty		
Bottom Latch Assembly.....		43
Bottom Latch Cover		45
Cylinder Cup Spacer 45PN/47PN	29, 46	
End Cap Replacement Pack.....		46
Extension Rod Kit - 24".....		44
Extension Rod Kit - 36".....		44
Hex Key for Dogging.....		46
Replacement Dogging Plates.....		44
Replacement Head Covers.....		44
Rod to Rod Connector		46
Rod Guide Replacement.....	44-45	
Screwpacks	45-46	
Top Latch Assembly.....		43
Top Latch Cover.....		45
	Top or Bottom Rod Replacement Kit.....	44
	Trim Handing Pin.....	45
C		
Cylinders		
Cylinder Collar, 4500 Trim.....		49-50
Cylinder Collar, 4700 Trim.....		50
Mortise.....		49
Retaining Cup.....		49
Rim.....		48
E		
Exit Devices, Grade 1		
How to Order		6
4500 Rim Device.....		9
4500 Mortise Lock Exit Device.....		12-13
4500 Concealed Vertical Rod Device		11
4500 Concealed Vertical Rod Device Less Bottom Rod		12
4500 Dummy Push Pad Device.....		13
4500 Surface Vertical Rod Device.....		10
4500 Surface Vertical Rod Device Less Bottom Rod.....		9
4500 Electric Modifications, Power Supplies, and Alarmed Devices		4-5
Exit Devices, Grade 1 Narrow Stile		
How to Order		7
4600 Narrow Stile Rim Device.....		30
4600 Concealed Vertical Rod Device.....		30
4600 Concealed Vertical Rod Device CLB.....		31
4600 Electric Modifications, Power Supplies, and Alarmed Devices		4-5
4500 Dummy Push Pad Device.....		13
Exit Devices, Standard Duty		
How to Order		8
4700 Rim Device.....		38
4700 Surface Vertical Rod Device.....		38
M		
Mullions		
Mullion Set - Keyed Removable.....		47
Mullion Set - Non-Keyed Removable		47
Mullion Tube - Keyed Removable		48
Mullion Tube - Non-Keyed Removable		47
Stabilizer - Keyed Removable		48
Stabilizer - Non-Keyed Removable		47
Top/Bottom Bracket Set - Keyed Removable.....		48
Top/Bottom Bracket Set - Non-Keyed Removable		47



Exit Devices

S

Shim Kit, 4500 Series Grade 1

Shim Kit, Rim Device.....	24
Shim Kit, Surface Vertical Rod.....	24

Shim Kit, 4600 Series Grade 1 Narrow Stile

Shim Kit, Narrow Stile Rim Device.....	35
--	----

Shim Kit, 4700 Series Standard Duty

Shim Kit, Rim Device.....	44
Shim Kit, Surface Vertical Rod.....	44

Strikes, 4500 Series Grade 1

Concealed Vertical Rod, Top Strike, Fire Rated.....	26
Concealed Vertical Rod, Top Strike, Standard.....	26
Double Door Strike, Standard.....	22
Mortise Device, Fire Rated.....	29
Mortise Device, Standard.....	29
Mullion, Strikes.....	47, 48
Rim Device, Fire Rated.....	22
Rim Device, Standard.....	22
Surface Vertical Rod, Bottom Strike, Fire Rated.....	23
Surface Vertical Rod, Bottom Strike, Standard.....	23
Surface Vertical Rod, Top Strike, Fire Rated.....	23
Surface Vertical Rod, Top Strike, Standard.....	23
Threshold Strike, Standard.....	22

Strikes, 4600 Series Grade 1 Narrow Stile

Blade Stop.....	35
Rim, Fire Rated.....	34
Rim, Standard.....	34
Semi-Flush Mount.....	35
Single Rabbit.....	35

Strikes, 4700 Series Standard Duty

Double Door Strike, Standard.....	43
Mullion, Strikes.....	47, 48
Rim Device, Standard.....	43
Surface Vertical Rod, Bottom Strike, Standard.....	43
Surface Vertical Rod, Top Strike, Standard.....	43
Threshold Strike, Standard.....	43

T

Trim, 4500 Series Grade 1

Anti-Vandal Pull.....	22
Blank Escutcheon.....	13-14
Blank Escutcheon, Mortise.....	14-15
Cylinder Escutcheon.....	15-16
Cylinder Escutcheon, Mortise.....	16-17
Dummy Trim.....	17-18
Dummy Trim, Mortise.....	18-19
Night Latch.....	19-20
Night Latch, Mortise.....	20-21
Pull Plate Trim.....	21

Trim, 4600 Series Grade 1 Narrow Stile

Blank Escutcheon.....	32
Cylinder Escutcheon.....	32-33
Dummy Trim.....	34
Night Latch.....	33-34

Trim, 4700 Series Standard Duty

Blank Escutcheon.....	38
Cylinder Escutcheon.....	39
Dummy Trim.....	39
Key-In-Lever Trim.....	40-42
Night Latch.....	40
Pull Plate Trim.....	42
Raised Lip - Dummy.....	43
Raised Lip - Night Latch.....	43

INTRODUCTION

Every model in Hager's line of exit devices is designed and engineered to assure you and your customers years of superior performance. Hager exit devices use fewer moving parts and are constructed with high-quality features--like die cast caps on our lifetime warranty Grade 1 devices, and die cast head covers on all our models. All Hager exit devices meet UL specifications for panic devices and are fire rated for up to three hours.

Hager exit devices were designed with ease of installation in mind. We package our exit devices for convenience and versatility, with thru-bolts included for every model, slotted strikes, and non-handed designs. Hager offers escutcheon trim available in four functions, along with many other trim options.

Quick Ship

Products denoted with **red and bold** pricing are available to order through the Quick Ship program and ship within 24 hours. When ordering these products please visit www.hagerco.com and log in to MyHager to access the 'Quick Ship' portal. Due to the promptness of the fulfillment process, Quick Ship orders are non-cancellable.

Lead Times

Stock items will typically ship in five working days or less from the order entry date. Made-to-order items will typically ship in 15 working days depending on seasonal volume and order complexity. Special orders including industrials, special machining, and large quantities may need to be scheduled. The anticipated ship date will be included with each order acknowledgement. Please contact Customer Service if product availability is in question.

Cancellation Notification

Cancellation for made-to-order items must be communicated within 48 hours of order placement.

New Finish

Painted flat black finish (BHMA 693) is now available. Use BLK to designate finish. Extended lead time and MOQ may apply.

APPLICATIONS

Single Door with Rim Exit Device

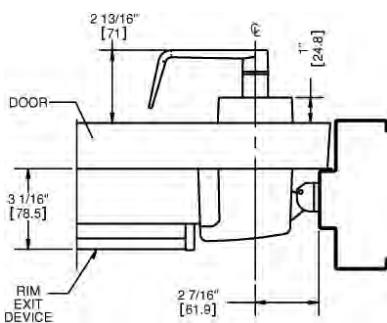

Double Door with Two Surface Vertical Rod Exit Devices

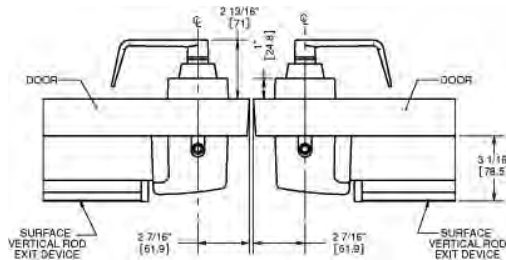

Double Door with Rim Exit Device and Surface Vertical Rod Exit Device

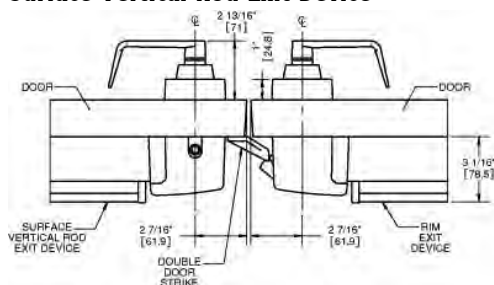

Double Door with Mullion

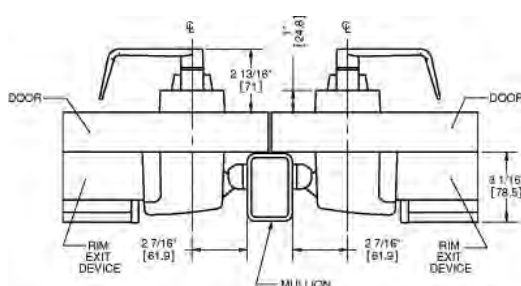

Exit Devices

ELECTRIC MODIFICATIONS - For use with 4500 Series and 4600 Series exit devices

FUNCTION	FUNCTION #	DESCRIPTION	ADD TO LIST PRICE
Electric Dogging	ED	Provides continuous latch retraction and dogging simultaneously.	\$721.90
Request to Exit	RX	Used to shunt an alarm, activate an alarm, provide release of magnetic locks, or signal a console.	\$290.45
Electric Dogging with Request to Exit	EDRX	Provides continuous latch retraction and dogging simultaneously along with an SPDT switch.	\$873.45
Dual Request to Exit	RX2	Features two SPDT switches	\$348.75
Latchbolt Monitoring	LM	An internal SPDT switch that monitors the latchbolt to signal both egress and access of an opening	\$290.45
Latchbolt Monitoring/ Request to Exit	RXLM	Two internal SPDT switches that monitor the latchbolt and the pushbar simultaneously	\$360.40
Electric Trim*	ET*	Provides the means of locking or unlocking outside lever trim controls remotely. Specify Fail Safe (EL) or Fail Secure (EU) and voltage (12V or 24V).	\$535.30
Authorized Ingress/Key Monitoring*	AI*	An internal SPDT switch that monitors the operation of the outside trim, available for use with either the 45BE, 45CE or 45NL trim or nightlatch by optional pull. Must be ordered with the device.	\$302.10
Request to Exit/Authorized Ingress*	RXAI*	Two internal SPDT switches that monitor the pushbar and the outside trim simultaneously, available for use with either the 45CE or 45NL trim. Must be ordered with the device.	\$360.40
Delayed Egress	DE	Delays egress for 15 or 30 seconds when unauthorized egress is initiated. Wall mount controller (2-679-0630) provides digital countdown display with verbal instructions or alarm tone only and must be ordered separately, list price \$1,404.50. Requires 3902 Power Supply.	\$1,272.00
Onboard Delayed Egress	OBDE*	Delays egress for 15 seconds (30 seconds optional) when unauthorized egress is initiated. Modification can be made to 4501 exit devices. Requires Mortise Cylinder, sold separately. Requires 3902 Power Supply. 1-1/8" - 1 3/8" length, 3978 Cloverleaf or equivalent tailpiece required.	\$2,856.70

*Available on 4500 Series only.

ELECTRIC MODIFICATIONS (CONTINUED)

FUNCTION	FUNCTION #	DESCRIPTION	ADD TO LIST PRICE
Motor Driven Electric Latch Retraction	MLR	Provides the means of locking or unlocking exit devices remotely using an electric motor. Recommend Hager 2903 or 2904 Power Supply.	\$1,090.25
Motor Driven Electric Latch Retraction with Request to Exit	MLRX	Provides the means of locking or unlocking exit devices remotely using an electric motor, along with an SPDT switch. Recommend Hager 2903 or 2904 Power Supply.	\$1,234.40
Electrified Mortise Exit Device	EU/EL	Provides the means of locking or unlocking outside lever trim controls remotely. Specify Fail Safe (EL) or Fail Secure (EU) and voltage (12V or 24V).	\$535.30

POWER SUPPLIES

PRODUCT #	DESCRIPTION	LIST PRICE
2903	Provides 24 Volt DC power for Fail Safe or Fail Secure locking devices and interface with building alarm controls, card readers, keypads, and other door controls	Reference Electrified Products for Pricing
2904	Provides 24 Volt DC power and control for openings with an electrified locking device and automatic door operator	Reference Electrified Products for Pricing
2908	Provides up to 1 amp of 12 or 24 Volt DC power.	Reference Electrified Products for Pricing
2909	Provides up to 2 amps of 12 or 24 Volt DC power.	Reference Electrified Products for Pricing

QUICK CONNECT

Available for use with 4500 and 4600 Series AI (4500 only), ED, LM, MLR, and RX. Compatible with Hager Quick Connect Harness Cables which can plug into Hager hinges with quick connect for quick and accurate wiring of the door. No additional charge.

ALARMED DEVICES**4501/4601 ALK - Alarm Kit**

Add \$337.10 to the list price of the device

4501/4601 ALM - ALK with Latch Monitor Switch (recommended for use with SVR devices)

Add \$452.65 to the list price of the device

4501/4601 ALT - ALK with Tamper Switch

Add \$454.65 to the list price of the device

4501/4601 ALL - ALK with Latch Monitor and Tamper Switch

Add \$568.20 to the list price of the device

Note: Alarm kit components may be purchased separately. Alarmed devices are not available on 4600 Series concealed vertical rod devices.



Exit Devices

4500 SERIES HOW TO ORDER

4501	RIM	F	36"	US3	1-3/4"	ALK
Product Group	Type	Rating	Door Size**	Finish	Door Thickness	Electric Modifications
4500 Series, Grade 1	RIM - Rim Device SVR - Surface Vertical Rod LBR - Surface Vertical Rod Less Bottom Rod * CVR - Concealed Vertical Rod CLB - Concealed Vertical Rod Less Bottom Rod * DMY - Dummy Push Pad MRT - Mortise Device (MC, MB, MD) MRTN - Mortise Night Latch Device (MN)	FR - Fire-Rated 0 - Non-Fire Rated CD - Cylinder Dogging L - Less Dogging WR - Windstorm Rated W - Windstorm and Fire-Rated	36" 48" 36" x 84" 36" x 96" 48" x 84" 48" x 96"	US3 US4 US10 US10B US26 US26D US32D BLK (New)	1-5/8" 1-3/4" 2" 2-1/2" 3"	AI - Authorized Ingress *** ALK - Alarm Kit ALL - Alarm Kit w/ Tamper Switch and Latch Monitor ALM - Alarm Kit w/ Latch Monitor ALT - Alarm Kit w/ Tamper Switch ED - Electric Dogging EDRX - Electric Dogging w/ Request to Exit LM - Latchbolt Monitor *** RX - Request to Exit RX2 - Dual Request to Exit RXAI - Request to Exit w/ Authorized Ingress *** RXLM - Request to Exit w/ Latchbolt Monitor *** MLR - Motor Driven Electric Latch Retraction MLRX - Motor Driven Electric Latch Retraction w/ Request to Exit

*Fire rated LBR and CLB devices must be ordered in pairs for the vertical rod devices or can be used in conjunction with an approved automatic or constant latching flush bolt. When ordering pairs, specify one device LBR and second device LBR with fire bolt, for example: 4501 LBR Fire 36" x 84" plus 4501 LBR Fire 36" x 84" EO with bolt -OR- 4501 LBR Fire 36" x 84" plus an approved automatic or constant latching flush bolt. Add \$50.35 to list price for firebolt kit.

** Exits for 24" doors available. For more details, please call Hager Customer Service. Add \$383.75 to 36" list price. (Requires extended lead-time).

*** Not available on Mortise devices

4500 SERIES TRIM HOW TO ORDER

45	CE	ARC	US3	1-3/4"	EL24
Product Group	Trim/Function	Lever Style	Finish	Door Thickness	Options
BE - Blank Escutcheon Function 14, always operable	CE - Cylinder Escutcheon Function 08, key locks/unlocks	ARC - Archer AUG - August WLM - William WTN - Withnell CHA - Charles JHN - Johnston** JOS - Joshua LOU - Louis WRN - Warren**	US3 US4 US10 US10B US26 US26D US32D (pull plate trim only) BLK (New)	1-5/8" 1-3/4" 2" 2-1/2" 3"	EL12 - Fail Safe, 12 Volt *** EL24 - Fail Safe, 24 Volt *** EU12 - Fail Secure, 12 Volt *** EU24 - Fail Secure, 24 Volt *** TW - Tactile Warning A - Antimicrobial Coating US26D & US32D only
DT - Dummy Trim Function 02, pull when dogged down	ET - Electric Escutcheon Trim				
NL - Night Latch (1-3/4" to 2-1/2" doors) Function 03, key retracts latchbolt	PD - Pull Plate Dummy Trim (Not available for CVR device) Function 02, pull when dogged down				
PN - Pull Plate Night Latch (Not available for CVR device) Function 03, key retracts latchbolt	PT - Thumbpiece Entrance (Not available for CVR device) Function 05, key locks or unlocks thumbpiece				
VR - Vandal Resistant	MB - Mortise Blank Escutcheon (14) *				
MC - Mortise Cylinder Escutcheon (08) *	MD - Mortise Dummy Trim (02) *				
MN - Mortise Night Latch (03) *					

* Mortise trim does not match centerline of other 4500 series trim. Cannot be used with 4500 Series Rim or Vertical Rod devices.

** Johnston and Warren lever designs are handed - specify LHR/RH or RHR/LH when ordering.

*** Not available on Mortise Exit trim

Notes:

- Mortise cylinder 3902 is required for use with cylinder escutcheon trim and pull plate with thumb piece trim and is sold separately.
- Rim cylinder with long tailpiece 3901 is required for use with night latch trim and is sold separately.
- For more cylinder information, please refer to general information in the Locks section of the catalog.
- If using shim kit, specify total door thickness including shims.
- For ET trim, must specify Fail Safe (EL) or Fail Secure (EU) and 12 or 24 volt.
- NEW - Flat Black Finish (BHMA 693). Priced same as US10B. Extended lead times may apply.**



4600 SERIES HOW TO ORDER

4601

Product Group

4600 Series, Grade 1

RIM

Type

RIM - Rim Device
 CVR- Concealed Vertical Rod Device
 CLB- Concealed Vertical Rod - Less Bottom Rod

FR

Rating

FR- Fire Rated
 0 - Non-Fire Rated
 CD - Cylinder Dogging
 LD - Less Dogging

36"

Size

36"
 48"

US3

Finish

US3
 US4
 US10
 US10B
 US26
 US26D
 US32D

BLK (New)

1-3/4"

Door Thickness

1-5/8"⁶
 1-3/4"
 2"⁶

ALK

Electric Modifications

ALK - Alarm Kit ⁶
 ALL - Alarm Kit w/ Tamper Switch and Latch Monitor⁶
 ALM - Alarm Kit w/ Latch Monitor⁶
 ALT - Alarm Kit w/ Tamper Switch⁶
 ED - Electric Dogging
 EDRX - Electric Dogging w/ Request to Exit
 LM - Latchbolt Monitor
 RX - Request to Exit
 RX2 - Dual Request to Exit
 RXLM - Request to Exit w/ Latchbolt Monitor
 MLR - Motor Driven Electric Latch Retraction
 MLRX - Motor Driven Electric Latch Retraction with Request to Exit
 MLRLM - Motor Driven Electric Latch Retraction with Latchbolt Monitoring
 MLRXL - Motor Driven Electric Latch Retraction with Request to Exit and Latchbolt Monitoring

4600 SERIES TRIM HOW TO ORDER

4600 SERIES TRIM

46

Product Group

46 - 4600 Series, Grade 1

CE

Trim/Function

BE - Blank Escutcheon
 Function 14, always operable
 CE - Cylinder Escutcheon
 Function 08, key locks/unlocks lever
 DT - Dummy Trim
 Function 02, pull when dogged down
 NL - Night Latch (Not available for 3" door)
 Function 03, key retracts latchbolt

ARC

Lever Style

ARC - Archer
 AUG - August
 WLM - William
 WTN - Withnell

US3

Finish

US3
 US4
 US10
 US10B
 US26
 US26D

BLK (New)

1-3/4"

Door Thickness

1-5/8"⁶
 1-3/4"
 2"⁶
 2-1/2"⁶
 3"⁶

TW

Options

TW - Tactile Warning
 A - Antimicrobial Coating - US26D & US32D only

Notes:

1. Mortise cylinder 3902 with 3976 L cam is required for use with cylinder escutcheon trim and is sold separately.
2. Rim cylinder 3901 with long tailpiece is required for use with night latch trim and is sold separately.
3. For more cylinder information, please refer to general information in the Locks section of the catalog.
4. If using shim kit, specify total door thickness including shims.
5. **NEW - Flat Black Finish (BHMA 693). Priced same as US10B. Extended lead times may apply.**
6. Not available on concealed vertical rod devices.



Exit Devices

4700 SERIES HOW TO ORDER

4701	RIM	F	36"	US3	2"
Product Group	Type	Rating	Size	Finish	Door Thickness
4700 Series, Standard Duty	RIM - Rim Device SVR - Surface Vertical Rod	F - Fire Rated 0 - Non-Fire Rated	36" 48" 36" x 84" 36" x 96" 48" x 84" 48" x 96"	US3 US32D ALM DBZ	1-5/8" 1-3/4" 2" 2-1/4"

4700 SERIES TRIM HOW TO ORDER

47	CE	RH	ARC	US3	2"	TW
Product Group	Trim/Function	Handing	Lever Style	Finish	Door Thickness	Options
47 - 4700 Series, Standard Duty	CE - Cylinder Escutcheon BE - Blank Escutcheon NL - Night Latch DT - Dummy Trim KD - Key in Lever - Dummy Trim KE - Key in Lever - Entrance KN - Key in Lever - Night Latch KP - Key in Lever - Passage PD - Pull Plate Dummy Trim PN - Pull Plate Night Latch RD - Raised Lip Pull - Dummy Trim RN - Raised Lip Pull - Night Latch BT - Thumbpiece Pull Plate, Passage PT - Thumbpiece Pull Plate, Entrance	RH - Right Handed / LHR LH - Left Handed / RHR	ARC - Archer AUG - August WTN - Withnell APL - Apollo knob	US3 US32D ALM DBZ	1-5/8" 1-3/4" 2" 2-1/4"	TW - Tactile Warning

Notes:

1. Handing is required for the 4700 Series trim.
2. Mortise cylinder, 3902, is sold separately.
3. For more cylinder information, please refer to General Information in the lock section of the catalog.
4. Maximum door thickness compatibility for key-in-lever (Entrance, Night Latch, and Passage) trim is 1-3/4" (44 mm)





Description	Length	Finish	2018 List	Stock No.	List Fire Rated	Stock No.	Case Qty.
4501 RIM	36"	US3	996.40	158092	1,137.95	158111	3
4501 RIM	Exit Only	US4	996.40	158094	1,137.95	158107	
Grade 1		US10	996.40	158087	1,137.95	115725	
Non-Handed		US10B	996.40	158088	1,137.95	158103	
		US26	996.40	158089	1,137.95	158109	
Cylinder Dogging (specify CD), add \$43.10 to list price. 3902 mortise cylinder with standard cam must be ordered separately.		US26D	961.95	158090	1,101.90	158104	
		US32D	996.40	158093	1,137.95	158105	
	48"	US3	1,031.95	156140	1,181.90	156145	3
Exit Only		US4	1,031.95	156141	1,181.90	156146	
		US10	1,031.95	156138	1,181.90	156142	
Severe Windstorm Rated device, add \$53.90 to list price and specify WR.		US10B	1,031.95	156139	1,181.90	156143	
		US26	1,031.95	158180	1,181.90	156144	
Refer to page 4 for electric modification pricing.		US26D	1,007.00	156135	1,144.80	154983	
		US32D	1,031.95	156136	1,181.90	156137	
Anti-microbial coating - add \$46.65 to list price.							



4501 SVR LBR	36" x 84"	US3	1,468.10	129450	1,591.10	126690	3
Grade 1	Exit Only	US4	1,468.10	131538	1,591.10	135130	
Non-Handed		US10	1,468.10	130713	1,591.10	144325	
		US10B	1,468.10	127645	1,591.10	126438	
Cylinder Dogging (specify CD), add \$43.10 to list price. 3902 mortise cylinder with standard cam must be ordered separately.		US26	1,468.10	-	1,591.10	146277	
		US26D	1,355.75	124387	1,487.75	124389	
		US32D	1,468.10	124388	1,591.10	170442	
	36" x 96"	US3	1,522.70	-	1,662.65	-	3
Exit Only		US4	1,522.70	152521	1,662.65	173396	
Fire rated LBR devices must be ordered in pairs of less bottom rod vertical rod devices and with a spring loaded fire latch (Part # 2-649-0166 - add \$50.35 to list price) to ensure the device's fire rating.		US10	1,522.70	-	1,662.65	153887	
		US10B	1,522.70	143515	1,662.65	126441	
		US26	1,522.70	-	1,662.65	155427	
		US26D	1,443.20	127422	1,573.60	133810	
		US32D	1,522.70	133952	1,662.65	124391	
	48" x 84"	US3	1,573.60	-	1,707.15	146813	3
Exit Only		US4	1,573.60	131540	1,707.15	147614	
Refer to page 4 for electric modification.		US10	1,573.60	148071	1,707.15	-	
Refer to page 25 for extension rod kits for doors over 8 feet in height. Note that these are not fire rated for the LBR.		US10B	1,573.60	161824	1,707.15	127646	
		US26	1,573.60	-	1,707.15	-	
		US26D	1,487.75	129506	1,608.55	127252	
		US32D	1,573.60	138585	1,707.15	156237	
Anti-microbial coating - add \$46.65 to list price.	48" x 96"	US3	1,601.70	-	1,733.10	-	3
Exit Only		US4	1,601.70	-	1,733.10	141078	
		US10	1,601.70	-	1,733.10	-	
		US10B	1,601.70	173468	1,733.10	137024	
		US26	1,601.70	-	1,733.10	-	
		US26D	1,573.60	147312	1,662.65	129948	
		US32D	1,601.70	149138	1,733.10	138708	

1. Items with the price in **bold and red** are Quick Ship items and ship in 24 hours. Please use stock number when ordering. 2. U/M is each unless otherwise noted.



Exit Devices - 4500



Description	Length	Finish	2018 List	Stock No.	List Fire Rated	Stock No.	Case Qty.
4501 SVR Grade 1 Non-Handed Cylinder Dogging (specify CD), add \$43.10 to list price. 3902 mortise cylinder with standard cam must be ordered separately.	36" x 84"	US3	1,468.10	157344	1,591.10	157393	3
	Exit Only	US4	1,468.10	157346	1,591.10	157395	
		US10	1,468.10	157398	1,591.10	169257	
	US10B	1,468.10	157341	1,591.10	157422		
		US26	1,468.10	157342	1,591.10	158058	
		US26D	1,355.75	157343	1,487.75	157392	
		US32D	1,468.10	157345	1,591.10	157394	
	36" x 96" Exit Only Severe Windstorm Rated device, add \$53.90 to list price and specify WR. Refer to page 4 for electric modification. Refer to page 25 for extension rod kits for doors over 8 feet in height.	US3	1,522.70	157400	1,662.65	157426	3
		US4	1,522.70	157401	1,662.65	158068	
			1,522.70	157548	1,662.65	158064	
US10B		1,522.70	157399	1,662.65	157424		
		US26	1,522.70	157568	1,662.65	157425	
US26D		1,443.20	157390	1,573.60	157396		
US32D		1,522.70	157391	1,662.65	157397		
36" x 120" Exit Only Anti-microbial coating - add \$46.65 to list price.	US3			1,744.80	157419	3	
	US4			1,744.80	157421		
				1,744.80	157402		
	US10B			1,744.80	157887		
		US26			1,744.80	157417	
	US26D			1,625.00	157418		
	US32D			1,744.80	157420		
48" x 84" Exit Only	US3	1,573.60	157895	1,707.15	156229	3	
	US4	1,573.60	156152	1,707.15	158070		
		1,573.60	157734	1,707.15	158070		
	US10B	1,573.60	156149	1,707.15	154982		
		US26	1,573.60	156150	1,707.15	156227	
	US26D	1,487.75	156147	1,608.55	156148		
	US32D	1,573.60	156151	1,707.15	156230		
48" x 96" Exit Only	US3	1,601.70	157901	1,733.10	158076	3	
	US4	1,601.70	157906	1,733.10	156235		
		1,601.70	157899	1,733.10	158075		
	US10B	1,601.70	157900	1,733.10	156231		
		US26	1,601.70	156153	1,733.10	156232	
	US26D	1,573.60	156154	1,662.65	156233		
	US32D	1,601.70	157905	1,733.10	156234		
48" x 120" Exit Only	US3			1,818.45	156224	3	
	US4			1,818.45	156226		
				1,818.45	156155		
	US10B			1,818.45	156156		
		US26			1,818.45	156157	
	US26D			1,692.85	158069		
US32D			1,818.45	156225			

1. Items with the price in **bold and red** are Quick Ship items and ship in 24 hours. Please use stock number when ordering.
2. U/M is each unless otherwise noted.
3. Available at extended lead times.

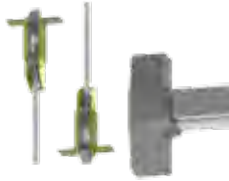

Description	Length	Finish	2018 List	Stock No.	List Fire Rated	Stock No.	Case Qty.
4501 CVR	36" x 84"	US3	1,845.50	149481	2,068.10	149489	3
Grade 1 - for wood or metal doors	Exit Only	US4	1,845.50	149482	2,068.10	149512	
Non-Handed		US10	1,845.50	149484	2,068.10	150548	
		US10B	1,845.50	149310	2,068.10	150549	
Cylinder Dogging (specify CD), add \$43.10 to list price. 3902 mortise cylinder with standard cam must be ordered separately.		US26	1,845.50	149485	2,068.10	150550	
		US26D	1,845.50	149305	2,068.10	173051	
		US32D	1,845.50	149312	2,068.10	149313	
	36" x 96"	US3	1,884.70	150573	2,107.30	150763	3
Refer to page 4 for electric modification pricing.	Exit Only	US4	1,884.70	150574	2,107.30	149314	
		US10	1,884.70	150758	2,107.30	150764	
		US10B	1,884.70	151032	2,107.30	149315	
Refer to page 25 for extension rod kits for doors over 8 feet in height.		US26	1,884.70	150760	2,107.30	150765	
		US26D	1,884.70	150761	2,107.30	149316	
		US32D	1,884.70	150762	2,107.30	149317	
Anti-microbial coating - add \$46.65 to list price.	48" x 84"	US3	1,920.75	168177	2,143.35	150783	3
	Exit Only	US4	1,920.75	168179	2,143.35	150784	
		US10	1,920.75	168173	2,143.35	150785	
		US10B	1,920.75	168174	2,143.35	150786	
		US26	1,920.75	168175	2,143.35	150787	
		US26D	1,920.75	168176	2,143.35	150788	
		US32D	1,920.75	168178	2,143.35	156236	
	48" x 96"	US3	1,959.95	168182	2,182.55	150796	3
	Exit Only	US4	1,959.95	168184	2,182.55	150797	
		US10	1,959.95	168180	2,182.55	150798	
		US10B	1,959.95	168172	2,182.55	150799	
		US26	1,959.95	168181	2,182.55	150800	
		US26D	1,959.95	168167	2,182.55	150801	
		US32D	1,959.95	168183	2,182.55	150802	

1. Items with the price in **bold and red** are Quick Ship items and ship in 24 hours. Please use stock number when ordering. 2. U/M is each unless otherwise noted.



Exit Devices - 4500



Description	Length	Finish	2018 List	Stock No.	List Fire Rated	Stock No.	Case Qty.	
4501 CLB Grade 1 - for wood or metal doors Non-Handed Cylinder Dogging (specify CD), add \$43.10 to list price. 3902 mortise cylinder with standard cam must be ordered separately.	36" x 84"	US3	1,845.80	-	2,068.10	-	3	
	Exit Only	US4	1,845.80	-	2,068.10	-		
		US10	1,845.80	-	2,068.10	-		
	Fire rated LBR devices must be ordered in pairs of less bottom rod vertical rod devices and with a spring loaded fire bolt (Part # 2-649-0166, add \$50.35 to list price) to ensure the device's fire rating.	Exit Only	US10B	1,845.80	161859	2,068.10	-	
			US26	1,845.80	-	2,068.10	-	
			US26D	1,845.80	161858	2,068.10	161863	
			US32D	1,845.80	161854	2,068.10	161871	
	Refer to page 4 for electric modification pricing.	Exit Only	US3	1,884.70	-	2,107.30	-	3
			US4	1,884.70	-	2,107.30	-	
			US10	1,884.70	-	2,107.30	-	
US10B			1,884.70	-	2,107.30	161874		
US26			1,884.70	-	2,107.30	-		
US26D			1,884.70	161872	2,107.30	161875		
Refer to page 25 for extension rod kits for doors over 8 feet in height	Exit Only	US32D	1,884.70	161873	2,107.30	161876		
		US3	1,920.75	-	2,143.35	-	3	
		US4	1,920.75	-	2,143.35	-		
		US10	1,920.75	-	2,143.35	-		
Anti-microbial coating - add \$46.65 to list price.	Exit Only	US10B	1,920.75	169856	2,143.35	-		
		US26	1,920.75	-	2,143.35	-		
		US26D	1,920.75	161877	2,143.35	173691		
Anti-microbial coating - add \$46.65 to list price.	Exit Only	US32D	1,920.75	-	2,143.35	161879		
		US3	1,959.95	-	2,182.55	-	3	
		US4	1,959.95	-	2,182.55	-		
		US10	1,959.95	-	2,182.55	-		
		US10B	1,959.95	-	2,182.55	-		
		US26	1,959.95	-	2,182.55	-		
		US26D	1,959.95	-	2,182.55	-		
		US32D	1,959.95	161881	2,182.55	-		

Mortise Lock Exit Devices

Grade 1
Non-Handed

Cylinder Dogging (specify CD), add \$43.10 to list price. 3902 mortise cylinder with standard cam must be ordered separately.

Refer to page 4 for electric modification pricing.
Anti-microbial coating - add \$46.65 to list price.

4501 M (Pair with MB, MC, MD trim)	36"	US3	1,851.85	162895	2,035.75	162900	3	
		Exit Only	US4	1,851.85	162897	2,035.75	162901	
			US10	1,851.85	162898	2,035.75	162947	
		Exit Only	US10B	1,851.85	162807	2,035.75	162829	
			US26	1,851.85	162899	2,035.75	162948	
			US26D	1,787.70	162827	1,966.85	162830	
			US32D	1,851.85	162828	2,035.75	162831	
48"	Exit Only	US3	1,876.20	162949	2,060.15	162953	3	
		US4	1,876.20	162950	2,060.15	162954		
		US10	1,876.20	162951	2,060.15	163724		
		US10B	1,876.20	162832	2,060.15	162836		
		US26	1,876.20	162952	2,060.15	162956		
		US26D	1,812.10	162833	1,989.10	162835		
		US32D	1,876.20	162834	2,060.15	162837		



07/22/2020

www.hagerco.com

1. Items with the price in **bold and red** are Quick Ship items and ship in 24 hours.
Please use stock number when ordering.
2. U/M is each unless otherwise noted.
3. Available at extended lead times.

Description	Length	Finish	2018 List	Stock No.	List Fire Rated	Stock No.	Case Qty.
4501 N (Pair with MN trim)	36"	US3	1,851.85	-	2,035.75	-	3
		Exit Only	US4	1,851.85	-	2,035.75	-
		US10	1,851.85	-	2,035.75	-	
		US10B	1,851.85	163023	2,035.75	163735	
		US26	1,851.85	-	2,035.75	-	
		US26D	1,787.70	163737	1,966.85	163544	
		US32D	1,851.85	163736	2,035.75	163524	
48"	Exit Only	US3	1,876.20	-	2,060.15	-	3
		US4	1,876.20	-	2,060.15	-	
		US10	1,876.20	-	2,060.15	-	
		US10B	1,876.20	163734	2,060.15	163731	
		US26	1,876.20	-	2,060.15	-	
		US26D	1,812.10	163733	1,989.10	163730	
		US32D	1,876.20	163732	2,060.15	163729	
4501 D Dummy Push Pad Non-handed For use with 4500 and 4600 Series Exit Devices	36"	US3	628.05	149393			3
		US10B	628.05	149392			
		US26D	551.20	149391			
		US32D	628.05	149390			
		48"	US3	652.45	149397		
Anti-microbial coating - add \$46.65 to list price.	48"	US10B	652.45	149396			
		US26D	575.60	149395			
		US32D	652.45	149394			
45BE Blank Escutcheon Tactile Warning - add \$42.40 to list price. Anti-microbial coating - add \$46.65 to list price.							
Archer Lever	14" Always Operable	US3	508.80	122812			6
		US4	508.80	122814			
		US10	508.80	122804			
		US10B	508.80	122806			
		US26	508.80	122808			
		US26D	489.75	122810			
August Lever		US3	508.80	122796			6
		US4	508.80	122797			
		US10	508.80	122792			
		US10B	508.80	122793			
		US26	508.80	122794			
		US26D	489.75	122795			
Charles Lever		US3	508.80	-			6
		US4	508.80	-			
		US10	508.80	-			
		US10B	508.80	178079			
		US26	508.80	-			
		US26D	489.75	176196			
Johnston Lever (must specify handling)		US3	508.80	-	508.80	-	6
		US4	508.80	178146	508.80	-	
		US10	508.80	178136	508.80	178142	
		US10B	508.80	177946	508.80	177951	
		US26	508.80	178130	508.80	178133	
		US26D	489.75	177384	489.75	177387	



1. Items with the price in **bold and red** are Quick Ship items and ship in 24 hours.
Please use stock number when ordering. 2. U/M is each unless otherwise noted.



Exit Devices - 4500

Description	Function	Finish	2018 List	Stock No. LHR	Stock No. RHR	Case Qty.	
Joshua Lever		US3	508.80	-		6	
		US4	508.80	-			
		US10	508.80	-			
		US10B	508.80	178087			
		US26	508.80	-			
		US26D	489.75	178084			
Louis Lever	14 Always Operable	US3	508.80	177349		6	
		US4	508.80	177356			
		US10	508.80	177291			
		US10B	508.80	177296			
		US26	508.80	177301			
		US26D	489.75	177305			
Warren Lever		US3	508.80	-	508.80	-	6
		US4	508.80	-	508.80	-	
		US10	508.80	-	508.80	-	
		US10B	508.80	178053	508.80	178057	
		US26	508.80	-	508.80	-	
		US26D	489.75	178031	489.75	178048	
William Lever		US3	508.80	165845		6	
		US4	508.80	165846			
		US10	508.80	165841			
		US10B	508.80	165842			
		US26	508.80	165843			
		US26D	489.75	165844			
Withnell Lever		US3	508.80	122813		6	
		US4	508.80	122815			
		US10	508.80	122805			
		US10B	508.80	122807			
		US26	508.80	122809			
		US26D	489.75	122811			

Description	Function	Finish	2018 List	Stock No.	Case Qty.
45MB					
Blank Escutcheon for use with 4501M Mortise Lock Exit Device Mortise trim does not match centerline of other 4500 Series trim Tactile Warning - add \$42.40 to list price. Anti-microbial coating - add \$46.65 to list price.					
Archer Lever	14 Always Operable	US3	508.80	163557	6
		US4	508.80	163596	
		US10	508.80	163600	
		US10B	508.80	163696	
		US26	508.80	163699	
		US26D	489.75	163559	
August Lever		US3	508.80	163593	6
		US4	508.80	163597	
		US10	508.80	163601	
		US10B	508.80	163697	
		US26	508.80	163700	
		US26D	489.75	163560	



1. Items with the price in **bold and red** are Quick Ship items and ship in 24 hours.
Please use stock number when ordering.
2. U/M is each unless otherwise noted.
3. Available at extended lead times.



Description	Function	Finish	2018 List	Stock No.	Case Qty.
William Lever		US3	508.80	163594	6
		US4	508.80	163598	
		US10	508.80	163602	
		US10B	508.80	163698	
		US26	508.80	163701	
		US26D	489.75	163624	
Withnell Lever		US3	508.80	163595	6
		US4	508.80	163599	
		US10	508.80	163695	
		US10B	508.80	163558	
		US26	508.80	163702	
		US26D	489.75	163561	



Description	Function	Finish	2018 List	Stock No. LHR	Stock No. RHR	Case Qty.	
45CE							
Cylinder Escutcheon							
Requires a 3902 mortise cylinder (with standard cam) sold separately							
Tactile Warning - add \$42.40 to list price.							
Anti-microbial coating - add \$46.65 to list price.							
Refer to page 4 for electric modification pricing.							
Archer Lever	08 Key locks or unlocks lever	US3	508.80	122824		6	
		US4	508.80	122826			
		US10	508.80	122816			
		US10B	508.80	122818			
		US26	508.80	122820			
		US26D	489.75	122822			
August Lever		US3	508.80	122802		6	
		US4	508.80	122803			
		US10	508.80	122798			
		US10B	508.80	122799			
		US26	508.80	122800			
		US26D	489.75	122801			
Charles Lever		US3	508.80	-		6	
		US4	508.80	-			
		US10	508.80	-			
		US10B	508.80	178080			
		US26	508.80	-			
		US26D	489.75	176193			
Johnston Lever (must specify handling)		US3	508.80	-	508.80	-	6
		US4	508.80	178147	508.80	-	
		US10	508.80	178137	508.80	178143	
		US10B	508.80	177948	508.80	177952	
		US26	508.80	178131	508.80	178134	
		US26D	489.75	177385	489.75	177386	

1. Items with the price in **bold and red** are Quick Ship items and ship in 24 hours.
Please use stock number when ordering. 2. U/M is each unless otherwise noted.



Exit Devices - 4500

Description	Function	Finish	2018 List	Stock No. LHR	Stock No. RHR	Case Qty.	
Joshua Lever		US3	508.80	-		6	
		US4	508.80	-			
		US10	508.80	-			
		US10B	508.80	178088			
		US26	508.80	-			
		US26D	489.75	178085			
Louis Lever	08 Key locks or unlocks lever	US3	508.80	177350		6	
		US4	508.80	177357			
		US10	508.80	177292			
		US10B	508.80	177298			
		US26	508.80	177302			
		US26D	489.75	177306			
Warren Lever		US3	508.80	-	508.80	-	6
		US4	508.80	-	508.80	-	
		US10	508.80	-	508.80	-	
		US10B	508.80	178054	508.80	178058	
		US26	508.80	-	508.80	-	
		US26D	489.75	178032	489.75	178049	
William Lever		US3	508.80	159126		6	
		US4	508.80	159127			
		US10	508.80	159128			
		US10B	508.80	159121			
		US26	508.80	159129			
		US26D	489.75	159109			
Withnell Lever		US3	508.80	122825		6	
		US4	508.80	122827			
		US10	508.80	122817			
		US10B	508.80	122819			
		US26	508.80	122821			
		US26D	489.75	122823			

Description	Function	Finish	2018 List	Stock No.	Case Qty.
45MC					
Cylinder Escutcheon for use with 4501M Mortise Lock Exit Device					
Mortise trim does not match centerline of other 4500 Series trim					
Requires a 3902 mortise cylinder (1-5/8" with standard cam) sold separately.					
Tactile Warning - add \$42.40 to list price.					
Anti-microbial coating - add \$46.65 to list price.					
Archer Lever	08 Key locks or unlocks lever	US3	508.80	163703	6
		US4	508.80	163708	
		US10	508.80	163711	
		US10B	508.80	163562	
		US26	508.80	163717	
		US26D	489.75	163523	
August Lever		US3	508.80	163704	6
		US4	508.80	163709	
		US10	508.80	163712	
		US10B	508.80	163715	
		US26	508.80	163718	
		US26D	489.75	163564	



1. Items with the price in **bold and red** are Quick Ship items and ship in 24 hours.
Please use stock number when ordering.
2. U/M is each unless otherwise noted.
3. Available at extended lead times.



Description	Function	Finish	2018 List	Stock No.	Case Qty.
William Lever		US3	508.80	163705	6
		US4	508.80	163625	
		US10	508.80	163713	
		US10B	508.80	163716	
		US26	508.80	163719	
		US26D	489.75	163626	
Withnell Lever		US3	508.80	163707	6
		US4	508.80	163710	
		US10	508.80	163714	
		US10B	508.80	163563	
		US26	508.80	163720	
		US26D	489.75	163565	



Description	Function	Finish	2018 List	Stock No. LHR	Stock No. RHR	Case Qty.	
45DT							
Dummy Trim							
Tactile Warning - add \$42.40 to list price.							
Anti-microbial coating - add \$46.65 to list price.							
Archer Lever	02 Pull when device is dogged down	US3	508.80	14036		6	
		US4	508.80	14023			
		US10	508.80	14049			
		US10B	508.80	14038			
		US26	508.80	60033			
		US26D	489.75	60018			
August Lever		US3	508.80	107837		6	
		US4	508.80	107838			
		US10	508.80	107833			
		US10B	508.80	107834			
		US26	508.80	107835			
		US26D	489.75	107836			
Charles Lever		US3	508.80	-		6	
		US4	508.80	-			
		US10	508.80	-			
		US10B	508.80	178082			
		US26	508.80	-			
		US26D	489.75	178078			
Johnston Lever		US3	508.80	-	508.80	-	6
		US4	508.80	178148	508.80	-	
		US10	508.80	178138	508.80	178144	
		US10B	508.80	177949	508.80	177953	
		US26	508.80	178132	508.80	178135	
		US26D	489.75	177937	489.75	177940	
Joshua Lever		US3	508.80	-		6	
		US4	508.80	-			
		US10	508.80	-			
		US10B	508.80	178089			
		US26	508.80	-			
		US26D	489.75	178086			

1. Items with the price in **bold and red** are Quick Ship items and ship in 24 hours.
Please use stock number when ordering. 2. U/M is each unless otherwise noted.



Exit Devices - 4500

Description	Function	Finish	2018 List	Stock No. LHR	Stock No. RHR	Case Qty.
Louis Lever	02	US3	508.80	177354		6
	Pull when device is dogged down	US4	508.80	177358		
		US10	508.80	177295		
		US10B	508.80	177299		
		US26	508.80	177303		
		US26D	489.75	177307		
Warren Lever	US3	508.80	-	508.80	-	6
	US4	508.80	-	508.80	-	
	US10	508.80	-	508.80	-	
	US10B	508.80	178055	508.80	178059	
	US26	508.80	-	508.80	-	
	US26D	489.75	178046	489.75	178050	
William Lever	US3	508.80	159142			6
	US4	508.80	165851			
	US10	508.80	165847			
	US10B	508.80	165848			
	US26	508.80	165849			
	US26D	489.75	165850			
Withnell Lever	US3	508.80	14035			6
	US4	508.80	14020			
	US10	508.80	14045			
	US10B	508.80	14037			
	US26	508.80	60027			
	US26D	489.75	60017			

Description	Function	Finish	2018 List	Stock No.	Case Qty.
45MD					
Dummy Trim for use with 4501M Mortise Lock Exit Device					
Mortise trim does not match centerline of other 4500 Series trim					
Tactile Warning - add \$42.40 to list price.					
Anti-microbial coating - add \$46.65 to list price.					
Archer Lever	02	US3	508.80	-	6
	Pull when device is dogged down	US4	508.80	-	
		US10	508.80	-	
		US10B	508.80	-	
		US26	508.80	-	
		US26D	489.75	-	
August Lever	US3	508.80	-		6
	US4	508.80	-		
	US10	508.80	-		
	US10B	508.80	-		
	US26	508.80	-		
	US26D	489.75	-		



1. Items with the price in **bold and red** are Quick Ship items and ship in 24 hours.
Please use stock number when ordering.
2. U/M is each unless otherwise noted.
3. Available at extended lead times.



Description	Function	Finish	2018 List	Stock No.	Case Qty.
William Lever		US3	508.80	-	6
		US4	508.80	-	
		US10	508.80	-	
		US10B	508.80	-	
		US26	508.80	-	
		US26D	489.75	-	
Withnell Lever		US3	508.80	-	6
		US4	508.80	-	
		US10	508.80	-	
		US10B	508.80	163728	
		US26	508.80	-	
		US26D	489.75	163727	



Description	Function	Finish	2018 List	Stock No. LHR	Stock No. RHR	Case Qty.	
45NL							
Night Latch							
Requires a 3901 rim cylinder (with long tailpiece) sold separately.							
Tactile Warning - add \$42.40 to list price.							
Anti-microbial coating - add \$46.65 to list price.							
Maximum door thickness compatibility is 2-1/2" (38 mm)							
Archer Lever	03 Key retracts latchbolt	US3	508.80	14003		6	
		US4	508.80	13984			
		US10	508.80	14015			
		US10B	508.80	14011			
		US26	508.80	60009			
		US26D	489.75	60000			
August Lever		US3	508.80	107844		6	
		US4	508.80	107845			
		US10	508.80	107840			
		US10B	508.80	107841			
		US26	508.80	107842			
		US26D	489.75	107843			
Charles Lever		US3	508.80	-		6	
		US4	508.80	-			
		US10	508.80	-			
		US10B	508.80	178083			
		US26	508.80	-			
		US26D	489.75	178429			
Johnston Lever		US3	508.80	-	508.80	-	6
		US4	508.80	178149	508.80	-	
		US10	508.80	178139	508.80	178145	
		US10B	508.80	177950	508.80	177954	
		US26	508.80	177955	508.80	177956	
		US26D	489.75	177938	489.75	177941	

1. Items with the price in **bold and red** are Quick Ship items and ship in 24 hours.
 Please use stock number when ordering. 2. U/M is each unless otherwise noted.



Exit Devices - 4500

Description	Function	Finish	2018 List	Stock No. LHR	Stock No. RHR	Case Qty.	
Joshua Lever		US3	508.80	-		6	
		US4	508.80	-			
		US10	508.80	-			
		US10B	508.80	178092			
		US26	508.80	-			
		US26D	489.75	178091			
Louis Lever	03 Key retracts latchbolt	US3	508.80	177355		6	
		US4	508.80	177359			
		US10	508.80	177294			
		US10B	508.80	177300			
		US26	508.80	177304			
		US26D	489.75	177308			
Warren Lever		US3	508.80	-	508.80	6	
		US4	508.80	-	508.80		
		US10	508.80	-	508.80		
		US10B	508.80	178056	508.80		178060
		US26	508.80	-	508.80		-
		US26D	489.75	178047	489.75		175051
William Lever		US3	508.80	159148		6	
		US4	508.80	159149			
		US10	508.80	159131			
		US10B	508.80	159132			
		US26	508.80	159133			
		US26D	489.75	159112			
Withnell Lever		US3	508.80	13999		6	
		US4	508.80	13980			
		US10	508.80	14012			
		US10B	508.80	14007			
		US26	508.80	60008			
		US26D	489.75	60001			

Description	Function	Finish	2018 List	Stock No.	Case Qty.	
45MN						
Night Latch for use with 4501N Mortise Lock Exit Device						
Mortise trim does not match centerline of other 4500 Series trim						
Requires a 3902 mortise cylinder (1-5/8" with standard cam) sold separately.						
Tactile Warning - add \$42.40 to list price.						
Anti-microbial coating - add \$46.65 to list price.						
Maximum door thickness compatibility is 2-1/2" (38 mm)						
Archer Lever	03 Key retracts latchbolt	US3	508.80	-		6
		US4	508.80	-		
		US10	508.80	-		
		US10B	508.80	-		
		US26	508.80	-		
		US26D	489.75	163538		



1. Items with the price in **bold and red** are Quick Ship items and ship in 24 hours.
Please use stock number when ordering.
2. U/M is each unless otherwise noted.
3. Available at extended lead times.



Description	Function	Finish	2018 List	Stock No.	Case Qty.
August Lever		US3	508.80	-	6
		US4	508.80	-	
		US10	508.80	-	
		US10B	508.80	-	
		US26	508.80	-	
		US26D	489.75	163725	
William Lever		US3	508.80	-	6
		US4	508.80	-	
		US10	508.80	-	
		US10B	508.80	-	
		US26	508.80	-	
		US26D	489.75	169861	
Withnell Lever		US3	508.80	-	6
		US4	508.80	-	
		US10	508.80	-	
		US10B	508.80	-	
		US26	508.80	-	
		US26D	489.75	163726	
45PD Pull Plate - Dummy Trim For use with 4500 RIM, SVR, LBR, ad CLB devices. Not for CVR. Tactile Warning - add \$42.40 to list price. Anti-microbial coating - add \$46.65 to list price.	02	US3	138.35	109038	12
	Pull when device is dogged down	US4	138.35	109039	
		US10	138.35	109040	
		US10B	138.35	109041	
		US26	138.35	109042	
		US26D	138.35	109043	
	US32D	138.35	109044		
45PN Pull Plate - Night Latch For use with 4500 RIM, SVR, LBR, ad CLB devices. Not for CVR. Requires a 3901 rim cylinder (sold separately) Includes retaining cup for 161 door prep. Tactile Warning - add \$42.40 to list price. Anti-microbial coating - add \$46.65 to list price.	03	US3	154.80	109048	12
	Key retracts latchbolt	US4	154.80	109049	
		US10	154.80	109050	
		US10B	154.80	109051	
		US26	154.80	109052	
		US26D	154.80	109053	
	US32D	154.80	109054		
45PT Pull Plate - Thumbpiece For use with 4501 Rim device Requires a 3902 mortise cylinder (sold separately) Tactile Warning - add \$42.40 to list price. Anti-microbial coating - add \$46.65 to list price.	05	US32D	336.05	146142	6



1. Items with the price in **bold and red** are Quick Ship items and ship in 24 hours. Please use stock number when ordering. 2. U/M is each unless otherwise noted.



Exit Devices - 4500



Description	Finish	2018 List	Stock No.	Case Qty.
313SE Anti-Vandal Pull for 4500 Rim device Material: 11 GA stainless steel Max Projection: 1-7/8" Size: 6-11/32 x 11" Door Thickness: 1-3/4" - 2" Fasteners: 1/4" FPHMS with finish washers Rim cylinder 3901 sold separately Retaining cup 2-649-0137 for 161 prep sold separately	Dummy	US32D	307.35	185346
	NL cyl. cutout LHR	US32D	307.35	185350
	NL cyl. cutout RHR	US32D	307.35	185352



313LE Anti-Vandal Pull w/Latchguard for 4500 Rim Device Material: 11 GA stainless steel Max Projection: 1-7/8" Size: 6-11/32 x 11" Door Thickness: 1-3/4" - 2" Fasteners: 1/4" FPHMS with finish washers Rim cylinder 3901 sold separately Retaining cup 2-649-0137 for 161 prep sold separately	Dummy	US32D	307.35	185355
	NL cyl. cutout LHR	US32D	307.35	185354
	NL cyl. cutout RHR	US32D	307.35	185353



4915 Threshold strike for use with 4500 or 4700 Series. Optional - order separately. Not for fire-rated doors.	US32D	24.95	67426	48
--	-------	-------	-------	----



4920 Strike for use with 4500 Series or 4600 Series Rim exit device. Included with device. Not for fire-rated doors.	US32D	70.00	16208	24
---	-------	-------	-------	----



4920F Fire rated strike for use with 4500 Series or 4600 Series fire rated Rim exit device. Included with fire rated device.	US32D	97.00	16207	24
---	-------	-------	-------	----



4921 Double door strike for 4500 Surface Vertical Rod and Rim exit device. Optional - order separately. Not for fire-rated doors.	US3	70.00	102255	24
	US4	70.00	102256	
	US10	70.00	102257	
	US10B	70.00	102258	
	US26	70.00	102259	
	US32D	70.00	102271	



4923 Top strike for use with 4500 Series Surface Vertical Rod device. Included with device.	US32D	44.55	16206	24
---	-------	-------	-------	----

1. Items with the price in **bold and red** are Quick Ship items and ship in 24 hours.
Please use stock number when ordering.
2. U/M is each unless otherwise noted.
3. Available at extended lead times.





Description	Finish	2018 List	Stock No.	Case Qty.		
4923F Fire rated top strike for use with 4500 Series Surface Vertical Rod device. Included with fire rated device.	US32D	54.60	16205	24		
4924 Bottom strike for use with 4500 Series Vertical Rod devices. Included with panic rated device.	US32D	54.60	16203	12		
4924F Fire rated bottom strike for use with 4500 Series Vertical Rod device. Included with fire rated device.	US32D	58.30	16201	12		
4926 Cylinder Dogging Conversion Kit for panic rated 4500 device Requires a 3902 mortise cylinder (with standard cam) sold separately.	36"	US3	45.60	157135	48	
		US4	45.60	157137		
		US10	45.60	157138		
		US10B	45.60	157139		
		US26	45.60	157140		
		US26D	45.60	157141		
		US32D	45.60	157142		
		48"	US3	48.80	157143	36
		US4	48.80	157144		
		US10	48.80	157145		
	US10B	48.80	157146			
	US26	48.80	157147			
	US26D	48.80	157148			
	US32D	48.80	157149			
4927 Bottom Latch Assembly for use with 4500 Series SVR Devices Includes latch, cover and screws. Included with device.		US3	97.00	2526	24	
		US4	97.00	2525		
		US10	97.00	2524		
		US10B	97.00	2522		
		US26	97.00	2520		
		US26D	97.00	2518		
	US32D	97.00	2511			

1. Items with the price in **bold and red** are Quick Ship items and ship in 24 hours. Please use stock number when ordering. 2. U/M is each unless otherwise noted.



Exit Devices - 4500



Description	Function	Finish	2018 List	Stock No.	Case Qty.
4928 Top Latch Assembly for use with 4500 Series SVR and LBR Devices Includes latch, cover and screws. Included with device.		US3	97.00	112972	24
		US4	97.00	112974	
		US10	97.00	112968	
		US10B	97.00	112969	
		US26	97.00	112970	
		US26D	97.00	112971	
		US32D	97.00	112973	
4929 SVR/LBR Rod Replacement Kit (top or bottom) Includes: One (1) each 45-1/4" (1149 mm) rod, rod connector, and appropriate fasteners.		US3	45.60	2634	24
		US4	45.60	2633	
		US10	45.60	2587	
		US10B	45.60	2582	
		US26	45.60	2573	
		US26D	45.60	2571	
4929C CVR/CLB Rod Replacement Kit (top or bottom) Includes: One (1) each 46-5/8" (1184 mm) rod, rod connector, and appropriate fasteners.		US26D	45.60	165570	24
4930R Shim Kit for 4500 Rim Device Packaged 2 ea. 1/8" shims		US3	82.70	1440	24
		US4	82.70	1438	
		US10	82.70	1429	
		US10B	82.70	1428	
		US26	82.70	1426	
		US26D	82.70	1423	
		US32D	97.00	1421	
4930S Shim Kit for 4500 Surface Vertical Rod Device Packaged 2 ea. 1/8" shims		US3	82.70	1412	24
		US4	82.70	1411	
		US10	82.70	1406	
		US10B	82.70	1404	
		US26	82.70	1400	
		US26D	82.70	1391	
		US32D	97.00	1388	
4932C Replacement Head Cover for 4500 CVR or Mortise Device		US3	82.70	166447	20
		US4	82.70	166449	
		US10	82.70	166443	
		US10B	82.70	166444	
		US26	82.70	166445	
		US26D	82.70	166446	
		US32D	97.00	166448	





Description	Function	Finish	2018 List	Stock No.	Case Qty.
4932R Replacement Head Cover for 4500 Rim Device		US3	82.70	105036	20
		US4	82.70	105037	
		US10	82.70	105038	
		US10B	82.70	105039	
		US26	82.70	105040	
		US26D	82.70	105041	
		US32D	97.00	105042	
4932S Replacement Head Cover for 4500 SVR Device		US3	82.70	105043	20
		US4	82.70	105044	
		US10	82.70	105045	
		US10B	82.70	105046	
		US26	82.70	105047	
		US26D	82.70	105048	
		US32D	97.00	105049	
4936 24" Extension Rod Kit Includes 24" extension rod, rod connector, rod guide, and wood and machine screws.		US3	29.15	129372	24
		US4	29.15	129373	
		US10	29.15	129374	
		US10B	29.15	129375	
		US26	29.15	129376	
		US26D	29.15	129377	
		US32D	29.15	129378	
4937 36" Extension Rod Kit Includes 36" extension rod, rod connector, rod guide, and wood and machine screws.		US3	32.90	129381	24
		US4	32.90	129382	
		US10	32.90	129383	
		US10B	32.90	129384	
		US26	32.90	129385	
		US26D	32.90	129386	
		US32D	32.90	129387	
4940 Alarm Kit for 4500 Series Latchbolt monitor switch and tamper switch available. See page 29.	36"	US3	389.55	137621	24
		US4	389.55	137622	
		US10	389.55	137623	
		US10B	389.55	137595	
		US26	389.55	137624	
		US26D	389.55	137596	
		US32D	389.55	137597	
	48"	US3	389.55	164020	24
		US4	389.55	164029	
		US10	389.55	164004	
		US10B	389.55	164008	
		US26	389.55	164012	
		US26D	389.55	164016	
		US32D	389.55	164025	

1. Items with the price in **bold and red** are Quick Ship items and ship in 24 hours.
Please use stock number when ordering. 2. U/M is each unless otherwise noted.



Exit Devices - 4500



Description	Function	Finish	2018 List	Stock No.	Case Qty.
4945 Top Strike Standard for 4501 CVR		US32D	45.05	150417	
4945F Fire Rated Top Strike for 4501 CVR		US32D	55.65	150418	
2-649-0031 Rod Guide Replacement Pack		US3	9.05	3478	
2-649-0032 Rod Guide Replacement Pack		US4	9.05	3477	
2-649-0033 Rod Guide Replacement Pack		US10	9.05	3476	
2-649-0034 Rod Guide Replacement Pack		US10B	9.05	3473	
2-649-0035 Rod Guide Replacement Pack		US26	9.05	3467	
2-649-0036 Rod Guide Replacement Pack		US26D	9.05	3466	
2-649-0037 Rod Guide Replacement Pack		US32D	9.05	3464	
2-649-0038 End Cap Replacement		US3	29.15	3462	
2-649-0039 End Cap Replacement		US4	29.15	3454	
2-649-0040 End Cap Replacement		US10	29.15	3452	
2-649-0041 End Cap Replacement		US10B	29.15	3435	
2-649-0042 End Cap Replacement		US26	29.15	3433	
2-649-0043 End Cap Replacement		US26D	29.15	3424	
2-649-0044 End Cap Replacement		US32D	29.15	3414	
2-649-0218 Flush End Cap		US3	33.95	182923	
2-649-0220 Flush End Cap		US4	33.95	182925	
2-649-0214 Flush End Cap		US10	33.95	182919	
2-649-0215 Flush End Cap		US10B	33.95	182920	
2-649-0216 Flush End Cap		US26	33.95	182921	
2-649-0217 Flush End Cap		US26D	33.95	182922	

1. Items with the price in **bold and red** are Quick Ship items and ship in 24 hours.
Please use stock number when ordering.
2. U/M is each unless otherwise noted.
3. Available at extended lead times.

Description	Function	Finish	2018 List	Stock No.	Case Qty.
2-649-0219 Flush End Cap		US32D	33.95	182924	
Note: All end caps come with bracket and fasteners					
2-649-0049 Spring Cage and Hanging Pin for 4500 Series Escutcheon Trim		-	13.80	3405	
2-649-0060 Top or Bottom Latch Cover Replacement Pack		US3	51.95	3333	
2-649-0061 Top or Bottom Latch Cover Replacement Pack		US4	51.95	3306	
2-649-0062 Top or Bottom Latch Cover Replacement Pack		US10	51.95	3304	
2-649-0063 Top or Bottom Latch Cover Replacement Pack		US10B	51.95	3299	
2-649-0064 Top or Bottom Latch Cover Replacement Pack		US26	51.95	3297	
2-649-0065 Top or Bottom Latch Cover Replacement Pack		US26D	51.95	3296	
2-649-0066 Top or Bottom Latch Cover Replacement Pack		US32D	51.95	3295	
2-649-0074 SVR Screwpack - Latch, rod, rod connector, rod guide		US3	7.95	103548	
2-649-0075 SVR Screwpack - Latch, rod, rod connector, rod guide		US4	7.95	103550	
2-649-0076 SVR Screwpack - Latch, rod, rod connector, rod guide		US10	7.95	103551	
2-649-0077 SVR Screwpack - Latch, rod, rod connector, rod guide		US10B	7.95	103552	
2-649-0078 SVR Screwpack - Latch, rod, rod connector, rod guide		US26	7.95	103553	
2-649-0079 SVR Screwpack - Latch, rod, rod connector, rod guide		US26D	7.95	103554	
2-649-0080 SVR Screwpack - Latch, rod, rod connector, rod guide		US32D	7.95	103555	
2-649-0081 SVR Screwpack - Top and bottom strike		-	4.80	103556	



1. Items with the price in **bold and red** are Quick Ship items and ship in 24 hours.
Please use stock number when ordering. 2. U/M is each unless otherwise noted.



Exit Devices - 4500



Description	Length	Finish	2018 List	Stock No.	Case Qty.
2-649-0082 Screwpack - Chassis, end cap, head cover, rim strike (4500 & 4600 Series)		US3	14.35	103558	
2-649-0083 Screwpack - Chassis, end cap, head cover, rim strike (4500 & 4600 Series)		US4	14.35	103559	
2-649-0084 Screwpack - Chassis, end cap, head cover, rim strike (4500 & 4600 Series)		US10	14.35	103560	
2-649-0085 Screwpack - Chassis, end cap, head cover, rim strike (4500 & 4600 Series)		US10B	14.35	103561	
2-649-0086 Screwpack - Chassis, end cap, head cover, rim strike (4500 & 4600 Series)		US26	14.35	103562	
2-649-0087 Screwpack - Chassis, end cap, head cover, rim strike (4500 & 4600 Series)		US26D	14.35	103563	
2-649-0088 Screwpack - Chassis, end cap, head cover, rim strike (4500 & 4600 Series)		US32D	14.35	103582	
2-649-0166 Firebolt Kit for Fire Rated 4500 Series LBR and CLB devices. Includes fire bolt, plastic plug, head cover plug, screws, and instructions. Must use firebolt with fire rated pairs of less bottom rod vertical rod devices to ensure the device's fire rating.		-	53.55	124539	
2-649-0167 LBR Replacement Head Cover Plug Shipped standard if device ordered as LBR		-	7.95	124540	
2-649-0168 Latchbolt Monitor Switch for 4940 and 4941 Alarm Kits		-	133.60	124228	
2-649-0177 Rod to Rod Connector		US3	7.95	129398	
2-649-0178 Rod to Rod Connector		US4	7.95	129399	
2-649-0179 Rod to Rod Connector		US10	7.95	129400	
2-649-0180 Rod to Rod Connector		US10B	7.95	129401	
2-649-0181 Rod to Rod Connector		US26	7.95	129402	
2-649-0182 Rod to Rod Connector		US26D	7.95	129403	
2-649-0183 Rod to Rod Connector		US32D	7.95	129404	



1. Items with the price in **bold and red** are Quick Ship items and ship in 24 hours.
Please use stock number when ordering.
2. U/M is each unless otherwise noted.
3. Available at extended lead times.





Description	Finish	2018 List	Stock No.	Case Qty.
2-649-0406 45PN/47PN Cylinder Cup Spacer	-	8.50	182414	
2-649-1074 Hex Key for Dogging 5/32" 10 pack	-	5.85	122690	
2-649-1090 Tamper Switch for 4940 and 4941 alarm kits	-	133.60	137590	
2-649-1108 4501 CVR Top Latch Assembly Replacement Kit	-	80.60	150415	
2-649-1109 4501 CVR Bottom Latch Assembly Replacement Kit	-	80.60	150416	
2-649-0440 4500 Series Mortise Exit Strike (2-hole)	US10B	24.40	070809	
2-649-0441 4500 Series Mortise Exit Strike (2-hole)	US26D	24.40	070801	
2-649-0442 4500 Series Mortise Exit Strike (2-hole)	US32D	24.40	070791	
2-649-0443 4500 Series Fire Rated Mortise Exit Strike (2-hole)	US10B	24.40	070792	
2-649-0444 4500 Series Fire Rated Mortise Exit Strike (2-hole)	US26D	24.40	070793	
2-649-0445 4500 Series Fire Rated Mortise Exit Strike (2-hole)	US32D	24.40	070788	
2-649-0250 4500/4600 Series 36" Photoluminescent Push Bar		250.00	185696	
2-649-0257 4500/4600 Series 48" Photoluminescent Push Bar		300.00	185792	

1. Items with the price in **bold and red** are Quick Ship items and ship in 24 hours.
Please use stock number when ordering. 2. U/M is each unless otherwise noted.



Exit Devices - 4600



Description		Finish	2018 List	Stock No.	List Fire Rated	Stock No.	Case Qty.
4601 RIM	36"	US3	1,386.50	158394	1,550.25	139568	3
Narrow Stile Rim	Exit Only	US4	1,386.50	158396	1,550.25	139569	
Grade 1		US10	1,386.50	158388	1,550.25	139570	
Non-Handed		US10B	1,386.50	158343	1,550.25	139571	
		US26	1,386.50	158390	1,550.25	139572	
For cylinder dogging (specify CD), add \$43.10 to the list price. 3902 mortise cylinder with standard cam must be ordered separately.		US26D	1,269.90	158324	1,422.00	139573	
		US32D	1,386.50	158344	1,550.25	139574	
	48"	US3	1,427.85	158401	1,594.80	139592	3
	Exit Only	US4	1,427.85	158402	1,594.80	139593	
		US10	1,427.85	158397	1,594.80	139594	
Refer to page 4 for electric modification pricing.		US10B	1,427.85	158398	1,594.80	139595	
		US26	1,427.85	158399	1,594.80	139596	
Anti-microbial coating - add \$46.65 to list price.		US26D	1,307.00	156239	1,466.00	139597	
		US32D	1,427.85	156240	1,594.80	139599	



Description		Finish	2020 List	Stock No.	List Fire Rated	Stock No.	Case Qty.
4601 CVR (Non-Fire Rated)	36" x 84"	US3 ³	1,220.00	-	-	-	3
Grade 1 -	Exit Only	US4 ³	1,190.00	-	-	-	
Non-Handed		US10 ³	1,200.00	-	-	-	
		US10B ³	1,190.00	-	-	-	
Cylinder Dogging (specify CD), add \$43.10 to list price. 3902 mortise cylinder with standard cam must be ordered separately.		US26 ³	1,220.00	-	-	-	
		US26D	1,170.00	040789	-	-	
		US32D	1,190.00	040784	-	-	
		BLK ³	1,190.00	-	-	-	
Refer to page 4 for electric modification pricing.	36" x 96"	US3 ³	1,260.00	-	-	-	3
	Exit Only	US4 ³	1,230.00	-	-	-	
		US10 ³	1,260.00	-	-	-	
Refer to page 25 for extension rod kits for doors over 8 feet in height.		US10B ³	1,230.00	-	-	-	
		US26 ³	1,260.00	-	-	-	
		US26D ³	1,210.00	-	-	-	
Anti-microbial coating - add \$46.65 to list price.		US32D ³	1,230.00	-	-	-	
		BLK ³	1,230.00	-	-	-	
	48" x 84"	US3 ³	1,280.00	-	-	-	3
	Exit Only	US4 ³	1,260.00	-	-	-	
		US10 ³	1,280.00	-	-	-	
		US10B ³	1,280.00	-	-	-	
		US26 ³	1,280.00	-	-	-	
		US26D	1,230.00	040783	-	-	
		US32D	1,260.00	040785	-	-	
		BLK ³	1,260.00	-	-	-	
	48" x 96"	US3 ³	1,320.00	-	-	-	3
	Exit Only	US4 ³	1,300.00	-	-	-	
		US10 ³	1,320.00	-	-	-	
		US10B ³	1,320.00	-	-	-	
		US26 ³	1,320.00	-	-	-	
		US26D ³	1,270.00	-	-	-	
		US32D ³	1,300.00	-	-	-	
		BLK ³	1,300.00	-	-	-	



Exit Devices - 4600



Description	Finish	2020 List	Stock No.	List Fire Rated	Stock No.	Case Qty.
4601 CLB (Non-Fire Rated)	36" x 84"	US3 ³	1,220.00	-	-	3
Grade 1 -	Exit Only	US4 ³	1,190.00	-	-	-
Non-Handed		US10 ³	1,200.00	-	-	-
		US10B ³	1,190.00	-	-	-
Cylinder Dogging (specify CD), add \$43.10 to list price. 3902 mortise cylinder with standard cam must be ordered separately.		US26 ³	1,220.00	-	-	-
		US26D	1,170.00	035049	-	-
		US32D	1,190.00	035050	-	-
		BLK ³	1,190.00	-	-	-
Refer to page 4 for electric modification pricing.	36" x 96"	US3 ³	1,260.00	-	-	3
	Exit Only	US4 ³	1,230.00	-	-	-
		US10 ³	1,260.00	-	-	-
Refer to page 25 for extension rod kits for doors over 8 feet in height.		US10B ³	1,230.00	-	-	-
		US26 ³	1,220.00	-	-	-
		US26D ³	1,210.00	-	-	-
Anti-microbial coating - add \$46.65 to list price.		US32D ³	1,230.00	-	-	-
		BLK ³	1,230.00	-	-	-
	48" x 84"	US3 ³	1,280.00	-	-	3
	Exit Only	US4 ³	1,260.00	-	-	-
		US10 ³	1,280.00	-	-	-
		US10B ³	1,280.00	-	-	-
		US26 ³	1,280.00	-	-	-
		US26D	1,230.00	035051	-	-
		US32D	1,260.00	035052	-	-
		BLK ³	1,260.00	-	-	-
	48" x 96"	US3 ³	1,320.00	-	-	3
	Exit Only	US4 ³	1,300.00	-	-	-
		US10 ³	1,320.00	-	-	-
		US10B ³	1,320.00	-	-	-
		US26 ³	1,320.00	-	-	-
		US26D ³	1,270.00	-	-	-
		US32D ³	1,300.00	-	-	-
		BLK ³	1,300.00	-	-	-



1. Items with the price in **bold and red** are Quick Ship items and ship in 24 hours. Please use stock number when ordering.
2. U/M is each unless otherwise noted.
3. Available at extended lead times.



Description		Finish	2018 List	Stock No.	Case Qty.
46BE					
Blank Escutcheon					
Tactile Warning - add \$42.40 to list price.					
Anti-microbial coating - add \$46.65 to list price.					
Archer Lever	14 Always Operable	US3	508.80	171112	6
		US4	508.80	171116	
		US10	508.80	170816	
		US10B	508.80	171033	
		US26	508.80	171089	
		US26D	489.75	171090	
August Lever		US3	508.80	171114	6
		US4	508.80	171118	
		US10	508.80	170825	
		US10B	508.80	171084	
		US26	508.80	171088	
		US26D	489.75	171096	
William Lever		US3	508.80	171113	6
		US4	508.80	171117	
		US10	508.80	170819	
		US10B	508.80	171083	
		US26	508.80	171087	
		US26D	489.75	171071	
Withnell Lever		US3	508.80	171115	6
		US4	508.80	171119	
		US10	508.80	171032	
		US10B	508.80	171085	
		US26	508.80	171089	
		US26D	489.75	171097	



46CE					
Cylinder Escutcheon					
Requires a 3902 mortise cylinder (with 3976 L cam) sold separately.					
Tactile Warning - add \$42.40 to list price.					
Anti-microbial coating - add \$46.65 to list price.					
Archer Lever	08 Key locks or unlocks lever	US3	508.80	171510	6
		US4	508.80	171514	
		US10	508.80	171479	
		US10B	508.80	171483	
		US26	508.80	171504	
		US26D	489.75	171508	
August Lever		US3	508.80	171512	6
		US4	508.80	171516	
		US10	508.80	171481	
		US10B	508.80	171503	
		US26	508.80	171506	
		US26D	489.75	171212	
William Lever		US3	508.80	171511	6
		US4	508.80	171515	
		US10	508.80	171480	
		US10B	508.80	171484	
		US26	508.80	171506	
		US26D	489.75	171211	

1. Items with the price in **bold and red** are Quick Ship items and ship in 24 hours.
Please use stock number when ordering. 2. U/M is each unless otherwise noted.



Exit Devices - 4600

Description	Finish	2018 List	Stock No.	Case Qty.
Withnell Lever	US3	508.80	171513	6
	US4	508.80	171518	
	US10	508.80	171482	
	US10B	508.80	171129	
	US26	508.80	171507	
	US26D	489.75	171509	



46DT

Dummy Trim

Tactile Warning - add \$42.40 to list price.

Anti-microbial coating - add \$46.65 to list price.

Archer Lever	02	US3	508.80	171292	6
	Pull when device is dogged down	US4	508.80	171296	
		US10	508.80	171223	
		US10B	508.80	171228	
		US26	508.80	171234	
		US26D	489.75	171283	

August Lever	US3	508.80	171294	6
	US4	508.80	171298	
	US10	508.80	171226	
	US10B	508.80	171232	
	US26	508.80	171281	
	US26D	489.75	171285	

William Lever	US3	508.80	171293	6
	US4	508.80	171297	
	US10	508.80	171224	
	US10B	508.80	171375	
	US26	508.80	171280	
	US26D	489.75	171376	

Withnell Lever	US3	508.80	171295	6
	US4	508.80	171412	
	US10	508.80	171227	
	US10B	508.80	171233	
	US26	508.80	171282	
	US26D	489.75	171287	



46NL

Night Latch

Requires a 3901 rim cylinder (with long tailpiece) sold separately.

Maximum door thickness compatibility is 2-1/2" (38mm).

Tactile Warning - add \$42.40 to list price.

Anti-microbial coating - add \$46.65 to list price.

Archer Lever	03	US3	508.80	171538	6
	Key retracts latchbolt	US4	508.80	171542	
		US10	508.80	171523	
		US10B	508.80	171527	
		US26	508.80	171531	
		US26D	489.75	171534	



Description	Finish	2018 List	Stock No.	Case Qty.	
August Lever	US3	508.80	171540	6	
	US4	508.80	171544		
	US10	508.80	171525		
	US10B	508.80	171529		
	US26	508.80	171533		
	US26D	489.75	171536		
William Lever	US3	508.80	171539	6	
	US4	508.80	171543		
	US10	508.80	171524		
	US10B	508.80	171528		
	US26	508.80	171532		
	US26D	489.75	171535		
Withnell Lever	US3	508.80	171541	6	
	US4	508.80	171545		
	US10	508.80	171526		
	US10B	508.80	171530		
	US26	508.80	171424		
	US26D	489.75	171537		
4920 Strike for use with 4500 or 4600 Series Rim Exit Device. Optional - order separately	US32D	70.00	16208	24	
4920F Fire rated strike for use with 4500 or 4600 Series Fire Rated Rim Exit Device. Included standard with fire rated device.	US32D	97.00	16207	24	
4925C Cylinder Dogging Conversion Kit for Panic Rated 4600 Series CVR and CLB Device.	36"	US10B	42.40	157216	48
		US26D	42.40	157218	
		US32D	42.40	157219	
Requires a 3902 mortise cylinder (with standard cam) sold separately.	48"	US10B	44.55	157274	36
		US26D	44.55	157276	
		US32D	44.55	157277	



1. Items with the price in **bold and red** are Quick Ship items and ship in 24 hours.
Please use stock number when ordering. 2. U/M is each unless otherwise noted.



Exit Devices - 4600



Description	Finish	2018 List	Stock No.	Case Qty.	
4925R Cylinder Dogging Conversion Kit for Panic Rated 4600 Series Rim Device. Requires a 3902 mortise cylinder (with standard cam) sold separately.	36"	US3	42.40	157187	48
		US4	42.40	157191	
		US10	42.40	157192	
		US10B	42.40	157193	
		US26	42.40	157194	
		US26D	42.40	157195	
		US32D	42.40	157196	
	48"	US3	44.55	157197	
		US4	44.55	157198	
		US10	44.55	157199	
	US10B	44.55	157200		
	US26	44.55	157201		
	US26D	44.55	157202		
	US32D	44.55	157203		
4941R Alarm Kit for 4600 Series Rim Device Latchbolt monitor switch and tamper switch available.	36"	US3	354.05	147106	36
		US4	354.05	147107	
		US10	354.05	147108	
		US10B	354.05	167348	
		US26	354.05	147110	
		US26D	354.05	167349	
		US32D	354.05	167464	
	48"	US3	354.05	147140	
		US4	354.05	147146	
		US10	354.05	147147	
	US10B	354.05	167468		
	US26	354.05	147149		
	US26D	354.05	147150		
	US32D	354.05	167467		
4950 Blade stop strike for use with 4600 Series Rim Exit Device. Included standard with panic rated device.		US32D	70.00	139746	24
4951 Single rabbet strike for use with 4600 Series Rim Exit Device Optional - order separately		US32D	70.00	139748	24





Description	Length	Finish	2018 List	Stock No.	Case Qty.
4952 Semi-flush mount strike for use with 4600 Series Rim Exit Device Optional - order separately		US32D	70.00	139747	24
4960R Shim Kit for 4600 Series Rim Exit Device Packaged 2 each 1/8" shims		US3 US4 US10 US10B US26 US26D US32D	75.30 75.30 75.30 75.30 75.30 75.30 88.55	139716 139717 139718 139719 139720 139721 139722	24
4965R Replacement Head Cover for 4600 Rim Device		US3 US4 US10 US10B US26 US26D US32D	75.30 75.30 75.30 75.30 75.30 75.30 88.55	139700 139707 139708 139709 139710 139711 139712	20
4965C Replacement Head Cover for 4600 CVR/CLB Device		US10B US26D US32D	75.30 75.30 88.55	166451 166453 166455	20
2-649-0218 Flush End Cap		US3	33.95	182923	
2-649-0220 Flush End Cap		US4	33.95	182925	
2-649-0214 Flush End Cap		US10	33.95	182919	
2-649-0215 Flush End Cap		US10B	33.95	182920	
2-649-0216 Flush End Cap		US26	33.95	182921	
2-649-0217 Flush End Cap		US26D	33.95	182922	
2-649-0219 Flush End Cap		US32D	33.95	182924	
Note: All end caps come with bracket and fasteners					
2-649-0168 Latchbolt Monitor Switch for 4940 and 4941 Alarm Kits		-	133.60	124228	
2-649-1074 Hex Key for Dogging 5/32" 10 pack		-	5.30	122690	

1. Items with the price in **bold and red** are Quick Ship items and ship in 24 hours. Please use stock number when ordering. 2. U/M is each unless otherwise noted.





Description	Length	Finish	2018 List	Stock No.	Case Qty.
2-649-1090 Tamper Switch for 4940 and 4941 Alarm Kits		-	133.60	137590	
4929C 4929 CVR/CLB Rod Replacement PK 46-5/8" US26D (4500/4600)		-	55.00	165570	
2-649-0596 4600 CVR Bottom Strike Packaged Assembly		-	27.00	39704	
2-649-0598 4600 CVR Top Strike Packaged Assembly		-	27.00	39700	
2-649-0581 4600 CVR Top Latch Assembly (no screws)		-	93.00	39696	
2-649-0582 4600 CVR Bottom Latch Assembly (no screws)		-	93.00	39697	
2-649-0580 4600 CVR Rod Connector Pack		-	15.00	39698	
2-649-0597 4600 Exit Device Chassis Screw Pack		-	6.00	039685	
2-649-0598 4600 CVR Latch Screw Pack, 26D		-	5.00	39682	
2-649-0589 4600 CVR Latch Screw Pack, 32D		-	5.00	39675	
2-649-0583 4600 CVR Latch Screw Pack, US3		-	5.00	39671	
2-649-0584 4600 CVR Latch Screw Pack, US4		-	5.00	39664	
2-649-0585 4600 CVR Latch Screw Pack, US10		-	5.00	39661	
2-649-0586 4600 CVR Latch Screw Pack, US10B		-	5.00	39658	
2-649-0587 4600 CVR Latch Screw Pack, US26		-	5.00	39655	
2-649-0590 4600 CVR Latch Screw Pack, BLK		-	5.00	39652	

1. Items with the price in **bold and red** are Quick Ship items and ship in 24 hours.
Please use stock number when ordering. 2. U/M is each unless otherwise noted.



Exit Devices - 4700



Description	Function	Finish	2018 List	Stock No.	List Fire Rated	Stock No.	Case Qty.	
4701 RIM Standard Duty Non-Handed	36" Exit Only	ALM	303.20	118164	416.60	115718	3	
		DBZ	303.20	118165	416.60	115738		
		US3	510.95	118162	627.55	115737		
		US32D	510.95	118163	627.55	115717		
	48" Exit Only	ALM	341.35	118168	456.35	115720	3	
		DBZ	341.35	118169	456.35	115740		
		US3	549.10	118166	664.10	115739		
		US32D	549.10	118167	664.10	115719		
	4701 SVR Standard Duty Non-Handed SVR panic devices available on 10' openings. Order extension rod kits separately.	36" x 84" Exit Only	ALM	492.90	118204	681.05	118190	3
			DBZ	492.90	118205	681.05	118191	
US3			701.75	118170	890.40	118188		
US32D			701.75	118171	890.40	118189		
36" x 96" Exit Only		ALM	532.15	118176	720.30	118194	3	
		DBZ	532.15	118177	720.30	118195		
		US3	738.30	118174	928.60	118192		
		US32D	738.30	118175	928.60	118193		
48" x 84" Exit Only		ALM	549.10	118181	738.30	118198	3	
		DBZ	549.10	118182	738.30	118199		
		US3	743.10	118178	946.05	118196		
		US32D	743.10	118180	946.05	118197		
48" x 96" Exit Only		ALM	568.20	118185	757.90	118202	3	
		DBZ	568.20	118186	757.90	118203		
		US3	777.55	118183	967.25	118200		
		US32D	777.55	118184	967.25	118201		



Description	Function	Finish	2018 List	Stock No. LHR	Stock No. RHR	Case Qty.	
47BE Blank Escutcheon Must specify handing Steel body, zinc lever (US32D has stainless steel cover). For doors thicker than 1-3/4" or when used with a shim kit, specify total door thickness. Tactile Warning - add \$42.40 to list price of item.							
Archer Lever	14	ALM	241.15	92763	241.15	6	
	Always	DBZ	241.15	92760	241.15		
	Operable	US3	263.45	92764	263.45		92846
		US32D	263.45	92772	263.45		92889
August Lever		ALM	241.15	107647	241.15	6	
		DBZ	241.15	107650	241.15		
		US3	263.45	107640	263.45		107643
		US32D	263.45	107645	263.45		107646
Withnell Lever		ALM	241.15	92917	241.15	6	
		DBZ	241.15	92906	241.15		
		US3	263.45	92918	263.45		93173
		US32D	263.45	92919	263.45		93199





Description	Function	Finish	2018 List	Stock No. LHR	Stock No. RHR	Case Qty.	
47CE							
Cylinder Escutcheon							
Must specify handing							
Requires a 3902 mortise cylinder (with standard cam) sold separately.							
Steel body, zinc lever (US32D has stainless steel cover).							
For doors thicker than 1-3/4" or when used with a shim kit, specify total door thickness.							
Tactile Warning - add \$42.40 to list price of item.							
Archer Lever	08	ALM	241.15	93208	241.15	93829	6
	Key locks or unlocks lever	DBZ	241.15	93206	241.15	93819	
		US3	263.45	93219	263.45	93903	
		US32D	263.45	93220	263.45	93913	
August Lever	ALM	241.15	107658	241.15	107659	6	
	DBZ	241.15	107660	241.15	107661		
	US3	263.45	107652	263.45	107654		
	US32D	263.45	107655	263.45	107657		
Withnell Lever	ALM	241.15	93778	241.15	95104	6	
	DBZ	241.15	93765	241.15	95004		
	US3	263.45	93786	263.45	95118		
	US32D	263.45	93801	263.45	95143		



47DT							
Dummy Trim							
Must specify handing							
Steel body, zinc lever (US32D has stainless steel cover).							
For doors thicker than 1-3/4" or when used with a shim kit, specify total door thickness.							
Tactile Warning - add \$42.40 to list price of item.							
Archer Lever	02	ALM	241.15	92290	241.15	92306	6
	Pull when device is dogged down	DBZ	241.15	92257	241.15	92304	
		US3	263.45	92291	263.45	92320	
		US32D	263.45	92293	263.45	92322	
August Lever	ALM	241.15	107675	241.15	107674	6	
	DBZ	241.15	107676	241.15	107677		
	US3	263.45	107669	263.45	107670		
	US32D	263.45	107671	263.45	107673		
Withnell Lever	ALM	241.15	92325	241.15	92391	6	
	DBZ	241.15	92324	241.15	92386		
	US3	263.45	92367	263.45	92392		
	US32D	263.45	92189	263.45	92396		

1. Items with the price in **bold and red** are Quick Ship items and ship in 24 hours. Please use stock number when ordering. 2. U/M is each unless otherwise noted.



Exit Devices - 4700



Description	Function	Finish	2018 List	Stock No. LHR	Stock No. RHR	Case Qty.
47NL						
Night Latch						
Must specify handing						
Requires a 3902 mortise cylinder (sold separately) with standard cam.						
Steel body, zinc lever (US32D has stainless steel cover).						
For doors thicker than 1-3/4" or when used with a shim kit, specify total door thickness.						
Tactile Warning - add \$42.40 to list price of item.						
Archer Lever	03	ALM	241.15	92451	241.15	6
	Key retracts latchbolt	DBZ	241.15	92397	241.15	
		US3	263.45	92485	263.45	
		US32D	263.45	92492	263.45	
August Lever		ALM	241.15	107803	241.15	6
		DBZ	241.15	107805	241.15	
		US3	263.45	107799	263.45	
		US32D	263.45	107801	263.45	
Withnell Lever		ALM	241.15	92575	241.15	6
		DBZ	241.15	92566	241.15	
		US3	263.45	92576	263.45	
		US32D	263.45	92593	263.45	



Description	Function	Finish	2018 List	Stock No. Fixed Cyl	Stock No. SFIC Hous	Case Qty.
47KD						
Dummy Trim						
Steel body and zinc lever (US32D stainless steel rose).						
Tactile Warning - add \$42.40 to list price of item.						
Archer Lever	02	ALM	218.40	109800	-	12
	Entrance by trim when device is dogged down	DBZ	218.40	109801	-	
		US3	241.15	109802	-	
		US32D	241.15	109803	-	
August Lever		ALM	218.40	109804	-	12
		DBZ	218.40	109805	-	
		US3	241.15	109806	-	
		US32D	241.15	109807	-	
Withnell Lever		ALM	218.40	109808	-	12
		DBZ	218.40	109809	-	
		US3	241.15	109810	-	
		US32D	241.15	109811	-	





Description	Function	Finish	2018 List	Stock No. Fixed Cyl	2018 List	Stock No. SFIC Hous	Case Qty.
47KE							
Entrance							
Fixed cylinder standard or SFIC housing option for levers (SFIC cores sold separately, refer to locks section).							
Steel body and zinc lever or knob (US32D stainless steel rose).							
Tactile Warning - add \$42.40 to list price of item.							
Archer Lever	08	ALM	241.15	169423	241.15	169422	12
	Entrance by trim	DBZ	241.15	169430	241.15	169429	
	key locks or unlocks trim	US3	263.45	169436	263.45	169435	
		US32D	263.45	169442	263.45	169441	
August Lever		ALM	241.15	169426	241.15	169424	12
		DBZ	241.15	169432	241.15	169431	
		US3	263.45	169438	263.45	169437	
		US32D	263.45	169444	263.45	169443	
Withnell Lever		ALM	241.15	169428	241.15	169427	12
		DBZ	241.15	169434	241.15	169433	
		US3	263.45	169440	263.45	169439	
		US32D	263.45	169446	263.45	169445	
Apollo Knob (not ADA compliant)							
		US32D	263.45	169447	-	-	12



47KN							
Night Latch							
Fixed cylinder standard or SFIC housing option for levers (SFIC cores sold separately, refer to locks section).							
Steel body, zinc lever or knob (US32D stainless steel rose).							
Tactile Warning - add \$42.40 to list price of item.							
Archer Lever	03	ALM	241.15	127486	241.15	109767	12
	Key retracts latchbolt	DBZ	241.15	127489	241.15	109768	
		US3	263.45	127480	263.45	109769	
		US32D	263.45	127483	263.45	109770	
August Lever		ALM	241.15	127487	241.15	109775	12
		DBZ	241.15	127490	241.15	109776	
		US3	263.45	127481	263.45	109777	
		US32D	263.45	127484	263.45	109778	
Withnell Lever		ALM	241.15	127488	241.15	109783	12
		DBZ	241.15	127491	241.15	109784	
		US3	263.45	127482	263.45	109785	
		US32D	263.45	127485	263.45	109786	
Apollo Knob (not ADA compliant)							
		US32D	263.45	149373	-	-	12

1. Items with the price in **bold and red** are Quick Ship items and ship in 24 hours. Please use stock number when ordering. 2. U/M is each unless otherwise noted.



Exit Devices - 4700



Description	Function	Finish	2018 List	Stock No. Fixed Cyl	Stock No. SFIC Hous	Case Qty.
47KP						
Passage						
Steel body, zinc lever (US32D stainless steel rose).						
Tactile Warning - add \$42.40 to list price of item.						
Archer Lever	14	ALM	218.40	109788	-	12
	Always operable	DBZ	218.40	109789	-	-
		US3	241.15	109790	-	-
		US32D	241.15	109791	-	-
August Lever	ALM	218.40	109792	-	-	12
	DBZ	218.40	109793	-	-	-
	US3	241.15	109794	-	-	-
	US32D	241.15	109795	-	-	-
Withnell Lever	ALM	218.40	109796	-	-	12
	DBZ	218.40	109797	-	-	-
	US3	241.15	109798	-	-	-
	US32D	241.15	109799	-	-	-



Description	Function	Finish	2018 List	Stock No.	Stock No.	Case Qty.
47BT						
Pull Plate						
Thumb Piece Passage						
Must specify handing						
Tactile Warning - add \$42.40 to list price of item.						
	14	US32D	266.10	168977	168976	6
47PT						
Pull Plate						
Thumb Piece Entrance						
Must specify handing						
Tactile Warning - add \$42.40 to list price of item.						
	05	US32D	266.10	159296	159297	6
47PD						
Pull Plate - Dummy Trim						
Plated steel for ALM, DBZ, and US3.						
Stainless steel for US32D.						
Tactile Warning - add \$42.40 to list price of item.						
	02	ALM	108.65	109019		12
	Pull when device is dogged down	DBZ	108.65	109020		
		US3	108.65	109021		
		US32D	108.65	109022		
47PN						
Pull Plate - Night Latch						
Requires a 3901 rim cylinder (sold separately).						
Includes retaining cup for 161 door prep.						
Plated steel for ALM, DBZ, and US3.						
Stainless steel for US32D.						
Tactile Warning - add \$42.40 to list price of item.						
	03	ALM	125.10	109023		12
	Key retracts latchbolt	DBZ	125.10	109026		
		US3	125.10	109027		
		US32D	125.10	109028		













Description		Finish	2018 List	Stock No.	Case Qty.
47RD Raised Lip Pull - Dummy Trim Plated steel for ALM, DBZ, and US3. Stainless steel for US32D. Tactile Warning - add \$42.40 to list price of item.	02	ALM	60.45	18956	12
	Pull when	DBZ	60.45	18949	
	device is	US3	60.45	18934	
	dogged down	US32D	60.45	18933	
47RN Raised Lip Pull - Night Latch Requires a 3901 rim cylinder (sold separately). Tactile Warning - add \$42.40 to list price of item.	03	ALM	67.35	18914	12
	Key	DBZ	67.35	18902	
	retracts	US3	67.35	18885	
	latchbolt	US32D	67.35	18884	
4910 Strike for use with 4700 Series Panic-Rated RIM Exit Device.		US32D	67.35	20040	24
4910F Strike for use with 4700 Series Fire-Rated RIM Exit Device. Included standard with device.		US32D	67.35	096788	24
4911 Double door strike for 4700 Surface Vertical Rod and Rim Exit Device. Not for fire-rated door. Optional - order separately.		DBZ	60.45	19301	24
		US3	60.45	19323	
		US32D	60.45	19322	
4913 Top strike for 4700 Surface Vertical Rod Exit Device Included standard with device.		US32D	42.95	16231	24
4914 Bottom strike for 4700 Surface Vertical Rod Exit Device Included standard with device.		US32D	42.95	16213	24
4915 Threshold strike for use with 4500 Series or 4700 Series. Not for fire-rated doors. Optional order separately.		US32D	24.95	67426	48
4917 Bottom Latch Assembly Includes latch, cover and screws. Included standard with device.		ALM	63.10	56412	50
		DBZ	63.10	56401	
		US3	63.10	56400	
		US32D	63.10	56398	
4918 Top Latch Assembly Includes latch, cover and screws. Included standard with device.		ALM	63.10	56418	50
		DBZ	63.10	56410	
		US3	63.10	56409	
		US32D	63.10	56407	
4919 Rod Replacement Kit (top or bottom) Includes rod (47-1/4"), rod guide, rod connector assembly and all appropriate screws.		ALM	31.80	73587	24
		DBZ	31.80	73574	
		US3	31.80	73568	
		US32D	31.80	73530	

1. Items with the price in **bold and red** are Quick Ship items and ship in 24 hours.
Please use stock number when ordering. 2. U/M is each unless otherwise noted.



Exit Devices - 4700

	Description	Length	Finish	2018 List	Stock No.	Case Qty.
	4931R		ALM	55.15	101773	24
	Shim Kit for 4700 Series Rim Device		DBZ	55.15	101774	
	Packaged 2 ea. 1/8" shims.		US3	63.10	101775	
	If using with 47BE, 47CE, 47NL trim, please specify thickness (door plus shim).		US32D	63.10	101776	
	4931S		ALM	55.15	101783	24
	Shim Kit for 4700 Series Surface Vertical Rod Device		DBZ	55.15	101784	
	Packaged 2 ea. 1/8" shims.		US3	63.10	101786	
	If using with 47BE, 47CE, 47NL trim, please specify thickness (door plus shim).		US32D	63.10	101787	
	4933R		ALM	39.75	105050	20
	Replacement Head Cover for 4700 Series Rim Device		DBZ	39.75	105051	
			US3	46.15	105052	
			US32D	46.15	105053	
	4933S		ALM	39.75	105054	20
	Replacement Head Cover for 4700 Series SVR Device		DBZ	39.75	105055	
			US3	46.15	105056	
			US32D	46.15	105057	
	4934	36"	ALM	31.80	105058	20
	Replacement Dogging Plate for 4700 Series Panic Rated Device		DBZ	31.80	105059	
			US3	31.80	105060	
			US32D	31.80	105061	
		48"	ALM	36.05	105062	20
			DBZ	36.05	105063	
			US3	36.05	105064	
			US32D	36.05	105065	
	4934F	36"	ALM	31.80	105066	20
	Replacement Dogging Plate for 4700 Series Fire Rated Device		DBZ	31.80	105076	
			US3	31.80	105068	
			US32D	31.80	105069	
		48"	ALM	36.05	105070	20
			DBZ	36.05	105071	
			US3	36.05	105072	
			US32D	36.05	105073	
	4936		ALM	28.10	129379	24
	24" Extension Rod Kit		DBZ	28.10	129380	
	Includes 24" extension rod, rod connector, rod guide, and wood and machine screws.		US3	29.15	129372	
	Fire rated up to 8' on Surface Vertical Rod device.		US32D	29.15	129378	
	4937		ALM	31.80	129388	24
	36" Extension Rod Kit		DBZ	31.80	129389	
	Includes 36" extension rod, rod connector, rod guide, and wood and machine screws.		US3	32.90	129381	
	Fire rated up to 8' on Surface Vertical Rod device.		US32D	32.90	129387	
	2-649-0010		US3	7.95	56131	
	Rod Guide Replacement					



Description	Function	Finish	2018 List	Stock No.	Case Qty.
2-649-0011 Rod Guide Replacement		US32D	7.95	56026	
2-649-0012 Rod Guide Replacement		DBZ	7.95	56025	
2-649-0013 Rod Guide Replacement		ALM	7.95	56027	
2-649-0014 Trim Handing Pin - 5 pack		-	7.95	52275	
2-649-0021 Top Latch Cover		ALM	34.45	56389	
2-649-0022 Top Latch Cover		DBZ	34.45	56388	
2-649-0023 Top Latch Cover		US3	34.45	56376	
2-649-0024 Top Latch Cover		US32D	34.45	56375	
2-649-0025 Bottom Latch Cover		ALM	34.45	56331	
2-649-0026 Bottom Latch Cover		DBZ	34.45	56328	
2-649-0027 Bottom Latch Cover		US3	34.45	56319	
2-649-0028 Bottom Latch Cover		US32D	34.45	56296	
2-649-0095 SVR Screwpack - Latch, rod, rod connector, rod guide		ALM	7.95	103572	
2-649-0096 SVR Screwpack - Latch, rod, rod connector, rod guide		DBZ	7.95	103573	
2-649-0097 SVR Screwpack - Latch, rod, rod connector, rod guide		US3	7.95	103574	
2-649-0098 SVR Screwpack - Latch, rod, rod connector, rod guide		US32D	7.95	103575	
2-649-0099 SVR Screwpack - Top and bottom strike		-	4.80	103576	
2-649-0100 Screwpack - Chassis, end cap, head cover, rim strike		ALM	13.80	103577	
2-649-0101 Screwpack - Chassis, end cap, head cover, rim strike		DBZ	13.80	103578	
2-649-0102 Screwpack - Chassis, end cap, head cover, rim strike		US3	13.80	103579	



1. Items with the price in **bold and red** are Quick Ship items and ship in 24 hours.
Please use stock number when ordering. 2. U/M is each unless otherwise noted.



Exit Devices - 4700

Description	Function	Finish	2018 List	Stock No.	Case Qty.
2-649-0103 Screwpack - Chassis, end cap, head cover, rim strike		US32D	13.80	103580	
2-649-0141 Screwpack - 2" thick door, trim		-	2.65	103606	
2-649-0142 Screwpack - 2-1/4" thick door, trim		-	2.65	103607	
2-649-0144 End Cap Replacement Pack		ALM	17.00	104043	
2-649-0145 End Cap Replacement Pack		DBZ	17.00	104044	
2-649-0146 End Cap Replacement Pack		US3	17.00	104045	
2-649-0147 End Cap Replacement Pack		US32D	17.00	104046	
Note: All end caps come with bracket and fasteners					
2-649-0164 Pack of 8 Screws, trim (4700), 1/4 - 20 x 3/4" PHMS		-	7.95	112534	
2-649-0177 Rod to Rod Connector		US3	7.95	129398	
2-649-0183 Rod to Rod Connector		US32D	7.95	129404	
2-649-0184 Rod to Rod Connector		ALM	7.95	129405	
2-649-0185 Rod to Rod Connector		DBZ	7.95	129406	
2-649-0406 45PN/47PN Cylinder Cup Spacer		-	8.50	182414	
2-649-4703 Hex Key for Dogging 3/16" 10 pack		-	5.85	315	





Description	Function	Finish	2018 List	Stock No.	List Fire Rated	Stock No.	Case Qty.
4900U Non-Keyed Removable Mullion Set 11 Gauge Steel Tube, top bracket/ bottom bracket set Fire rated mullion requires a fire rated strike (sold separately).	7'	USP	501.40	133007	749.95	133010	1
	8'	USP	501.40	133008	749.95	133011	1
	10'	USP	625.40	133009		-	1
<hr/>							
4904 Top/Bottom Bracket Set Removable (Non-Keyed)		-	219.95	133029	270.30	133031	5
<hr/>							
4905 Mullion Tube (Non-Keyed) 11 Gauge Steel	7'	USP	321.75	133032		-	1
	8'	USP	321.75	133033		-	1
	10'	USP	398.60	133034		-	1
<hr/>							
4912 Fire rated strike for use with 4500 Series and 4600 Series Fire Rated Exit Device and Mullion		US32D		-	137.80	16232	24
<hr/>							
4916 Fire rated strike for use with 4700 Series Fire Rated Exit Device and Mullion		US32D		-	137.80	115780	24
<hr/>							
4953 Mullion Stabilizer for use with 4900 Series Non-Keyed and Keyed Removable Mullion		US32D		-	54.10	139749	12
<hr/>							
4900T Keyed Removable Mullion Set 11 gauge steel tube, top bracket/ bottom bracket set. Requires a 3901 rim cylinder (sold separately). Fire rated mullion requires a fire rated strike (sold separately).	7'	USP	1,034.05	132391	1,223.80	132393	1
	8'	USP	1,034.05	132392	1,223.80	132394	1
	10'	USP	1,192.00	132390		-	1

1. Items with the price in **bold and red** are Quick Ship items and ship in 24 hours.
Please use stock number when ordering. 2. U/M is each unless otherwise noted.



Exit Devices - 4700



Description	Function	Finish	2018 List	Stock No.	List Fire Rated	Stock No.	Case Qty.
4902 Top/Bottom Bracket Set Key Removable		-	635.50	45351	787.05	31750	5
Requires a 3901 rim cylinder (sold separately).							
4907 Mullion Tube (Key Removable) 11 Gauge Steel	7'	USP	428.80	45349		-	1
	8'	USP	428.80	45334		-	1
	10'	USP	557.60	45323		-	1
4912 Fire rated strike for use with 4500 Series and 4600 Series Fire Rated Device and Mullion		US32D		-	137.80	16232	24
4916 Fire rated strike for use with 4700 Series Fire Rated Exit Device and Mullion		US32D		-	137.80	115780	24
4953 Mullion Stabilizer for use with 4900 Series Non-Keyed and Keyed Removable Mullion		US32D		-	54.10	139749	12
3901 Rim Cylinder Fixed cylinder and Small Format Interchangeable Core housing available (SFIC cores sold separately). Dummy rim cylinders also available.		US3	48.50				1
		US4	51.55				
		US10	51.55				
		US10B	48.50				
		US26	48.50				
		US26D	48.50				
Shipped standard with long break-off tailpiece.							
Specify 6-pin or 7-pin for SFIC housing.							
For additional cylinder information, please refer to the Locks section.							





Description	Function	Finish	2018 List	Stock No.	Case Qty.
3902 Mortise Cylinder Fixed cylinder and Small Format Interchangeable Core housing available (SFIC cores sold separately). Dummy mortise cylinders also available.		US3	48.50		1
		US4	51.55		
		US10	51.55		
		US10B	48.50		
		US26	48.50		
		US26D	48.50		
Shipped with Schlage C keyway, standard cam attached, and Adams Rite cam loose in box.					
Specify length 1-1/8" or 1-1/4" for fixed cylinder or 1-1/4" (6-pin) or 1-3/8" (7-pin) for SFIC housing and cam required.					
For mortise exit device trim specify 1-5/8" with standard cam for fixed cylinder (Schlage C Keyway) or SFIC housing.					
For mortise exit device x cylinder/optional pull, use 1-3/8" cylinder with 11/16" cylindrical collar.					
For additional cylinder information, please refer to the Locks section.					
2-649-0137 Retaining Cup For use with Rim cylinder and 161 prep		NF	9.55	103365	
2-649-0045 7/16" Cylinder Collar (4500 Pull Plate Trim)		US3	19.10	3404	
2-649-0046 7/16" Cylinder Collar (4500 Pull Plate Trim)		US4	19.10	3395	
2-649-0047 7/16" Cylinder Collar (4500 Pull Plate Trim)		US10	19.10	3394	
2-649-0048 7/16" Cylinder Collar (4500 Pull Plate Trim)		US10B	19.10	3393	
2-649-0050 7/16" Cylinder Collar (4500 Pull Plate Trim)		US26	19.10	3386	
2-649-0051 7/16" Cylinder Collar (4500 Pull Plate Trim)		US26D	19.10	3384	
2-649-0052 7/16" Cylinder Collar (4500 Pull Plate Trim)		US32D	19.10	3381	
Note: For use with 1-1/8" mortise cylinders Note: All cylinder collars come with wave washer and spacer					
2-649-0053 11/16" Cylinder Collar (4500 Escutcheon Trim)		US3	19.10	3380	
2-649-0054 11/16" Cylinder Collar (4500 Escutcheon Trim)		US4	19.10	3357	
2-649-0055 11/16" Cylinder Collar (4500 Escutcheon Trim)		US10	19.10	3346	
2-649-0056 11/16" Cylinder Collar (4500 Escutcheon Trim)		US10B	19.10	3340	
2-649-0057 11/16" Cylinder Collar (4500 Escutcheon Trim)		US26	19.10	3339	



1. Items with the price in **bold and red** are Quick Ship items and ship in 24 hours.
Please use stock number when ordering. 2. U/M is each unless otherwise noted.



Exit Devices - 4700



Description	Finish	2018 List	Stock No.	Case Qty.
2-649-0058 1 1/16" Cylinder Collar (4500 Escutcheon Trim)	US26D	19.10	3335	
2-649-0059 1 1/16" Cylinder Collar (4500 Escutcheon Trim)	US32D	19.10	3334	
Note: For use with 1-1/4" or 1-3/8" mortise cylinders Note: All cylinder collars come with wave washer and spacer				
2-647-0012 7/8" Cylinder Collar - 5, 6, 7 pin (4700 Escutcheon Trim)	US3	19.10	31809	
2-647-0013 7/8" Cylinder Collar - 5, 6, 7 pin (4700 Escutcheon Trim)	ALM	19.10	31804	
2-647-0014 7/8" Cylinder Collar - 5, 6, 7 pin (4700 Escutcheon Trim)	DBZ	19.10	31793	
2-647-0015 7/8" Cylinder Collar - 5, 6, 7 pin (4700 Escutcheon Trim)	US32D	19.10	31789	
Note: For use with 1-1/8" mortise cylinders Note: All cylinder collars come with wave washer and spacer				





One Family. One Brand. One Vision.™

www.hagerco.com

TABLE OF CONTENTS

A		P	
Adjustable Angle Bracket (2941/2942)	6	Pedestrian Presence Sensors	21
Angle Brackets (2950 Series)	9	Power Supply.....	3-4
Armature Mounting Plates (2950 Series).....	7-8	Power Transfers	11
C		Pressure Sense Bars.....	10
Coordinator Mounting Bracket (2950 Series)	8	Proximity Cards & Keys... ..	4
Concealed Magnetic Contact	11	S	
D		Spacer Brackets (2950 Series).....	7
Delayed Egress Magnetic Lock.....	9-10	T	
Door Prop Alarms.....	3	Top Jamb Kits (2941/2942)	6
E		Top Jamb Kits (2950 Series)	7
Egress Sensors.....	11	U	
Electric Strikes	5-6	Universal Brackets (2950 Series)	7
Exit Switches	10	Underdesk Switch.....	11
Emergency Door Release.....	11		
F			
Filler Bars (2941/2942 Series)	6		
Filler Bars (2950 Series)	8		
G			
Gang Boxes	11		
Glass Door Kits (2941/2942)	6		
Glass Door Kits (2950 Series)	7		
K			
Key Switch.....	3		
Keypads	4		
L			
Low Energy Power Operator	12-20		
M			
Magnetic Locks (2941/2942 Series).....	6		
Magnetic Locks (2950 Series).....	6-7		
Magnetic Shear Locks (2961/2965)	9		
Magnetic Switches	11		
O			
Outdoor Shrouds	4,11		



Electrified Products

Low Energy Power Operators

8300 Series Low Energy Power Operators 15-16

8400 Series Low Energy Power Operators 12-14

A

Actuators	17-19
Arm Assemblies (8300 Series)	16
Arm Assemblies (8400 Series)	13

B

Battery Backup (8300 Series)	15
Bollard Posts	19

C

Covers (8400 Series)	13-14
----------------------------	-------

D

Drop Plates (8400 Series)	13
---------------------------------	----

H

Handheld Programmer (8300 Series)	16
---	----

O

On-Board Power Supply (8400 Series)	14
---	----

S

Spindles (8400 Series)	13
------------------------------	----

R

Relay & Door Sequencer	20
Relay Board (8400 Series)	14

W

Wireless Receiver	19
Wireless Transmitters	20

LEAD TIMES

Stock items will typically ship in five working days or less from the order entry date. Made-to-order items will typically ship in 15 working days depending on seasonal volume and order complexity. Special orders including industrials, special machining, and large quantities may need to be scheduled. The anticipated ship date will be included with each order acknowledgment. Please contact Customer Service if product availability is in question.

QUICK SHIP

Products denoted with **red and bold** pricing are available to order through the Quick Ship program and ship within 24 hours. When ordering these products please visit www.hagerco.com and log in to MyHager to access the 'Quick Ship' portal. Due to the promptness of the fulfillment process, Quick Ship orders are non-cancellable.

CANCELLATION NOTIFICATION

Cancellation for made-to-order items must be communicated within 48 hours of order placement.



Description	Finish	2018 List	Stock No.	Case Qty.
29KS ASD Key switch - Alternate, SPDT	US32D	102.75	156361	12
29KS MSD Key switch - Momentary, SPDT	US32D	102.75	156367	12
29KS ADD Key switch - Alternate, DPDT	US32D	119.00	156366	12
29KS MDD Key switch - Momentary, DPDT	US32D	113.60	156367	12
Options: Red LED \$21.65 list price adder Green LED \$21.65 list price adder 2 LED's \$27.05 list price adder				
29EA NS Door Prop Alarm, Single Gang Mount, No Key Switch		294.65	199478	
29EA KS Door Prop Alarm, Double Gang Mount, Key Switch		415.20	199474	
29EA MKNC Door Prop Alarm, Double Gang Mount, Mortise Cylinder Switch		375.00	199473	
2901 For use with 4500 Series electric latch retraction battery back up option available		596.40	114909	
2902 For use with 4500 Series electric latch retraction in a day/night mode of operation, battery backup option available		658.20	114990	
2903 Provides 24 volt DC power for Fail Safe or Fail Secure locking devices and interface with building alarm controls, card readers, keypads, and other door controls.		514.00	114455	
2904 Provides 24 volt DC power and control for opening with an electrified locking device and automatic door operator		544.90	136899	
2908 Provides up to 1 amp of 12 or 24 volt DC power for all Hager Electrified Products except (ELR)		355.35	149931	1
2909 Provides up to 2 amps of 12 or 24 volt DC power for all Hager Electrified Products		541.80	177262	



Electrified Products



Description	Finish	2018 List	Stock No.	Case Qty.
2910 Provides up to 4 amps of 12 or 24 volt DC power for all Hager Electrified Products		831.70	198523	
2911 Provides up to 6 amps of 12 or 24 volt DC power for all Hager Electrified Products		971.00	198524	
2-679-0661 5 Amp hour battery backup for use with 2908 & 2909		47.60	153208	
2-679-0662 12 VDC output regulator module for use with 2908 & 2909		61.05	159033	
2-679-0664 Universal Relay Module for use with 2908 & 2909		117.25	156812	
2-679-0703 Electric Retraction Sequencer for use with 2908 & 2909		177.20	177267	
2-679-0704 Access Control Module for use with 2908 & 2909		193.65	177263	
2-679-0705 16 AMP Power Booster for use with 2909 only		177.25	177264	
2-679-0706 Power Supply Remote Monitoring Module for use with 2908 & 2909		257.50	177266	
2-679-0708 Underdesk Push Switch		111.65	176289	
2915 Heavy Duty Keypad - Indoor 500 users, 4-6 digit PIN codes 12/24V AC/DC	US3	232.55	150749	12
	US4	232.55	150750	
	US10B	232.55	150751	
	US26	232.55	150752	
	US32D	189.30	149619	
2916 Heavy Duty Keypad - Outdoor 500 users, 4-6 digit PIN Codes 12/24V AC/DC	32D	247.20	173204	8
2916P Heavy Duty Keypad / Prox-Outdoor 500 users, 4-6 digit PIN codes 12/24V AC/DC	32D	679.75	189700	8
2-679-0669 Shroud Cover	-	158.95	176541	
2-679-0700 Surface Mount Box	-	31.95	172698	
2-679-0021 HID ProxCard II, 25 Cards	-	189.30	149627	
2-679-0022 HID ProxCard II, 100 Cards	-	757.05	153893	





Description	Finish	2018 List	Stock No.	Case Qty.
2-679-0023 HID ProxKey, 10 Key fobs	-	151.45	150753	
2-679-0024 HID ProxKey, 100 Key fobs	-	1,514.10	153894	
2925 Electric Strike - 5/8" Latch Field Reversible Failsafe/Failsecure 12/24VDC 4-7/8" Sq Corner Stainless Steel Faceplate	US32D	129.80	149637	8
2928 SC Electric Strike - 1/2" to 3/4" latch Failsafe/Failsecure 12/24V AC/DC 4-7/8" Sq Corner Stainless Steel Faceplate	US32D	210.90	149638	8
2928 RC Electric Strike - 1/2" to 3/4" latch Failsafe/Failsecure 12/24V AC/DC 4-7/8" Radius Corner Faceplate	ALM	183.90	150333	8
2928 6R Electric Strike - 1/2" to 3/4" latch Failsafe/Failsecure 12/24V AC/DC 6-7/8" Radius Corner Faceplate	ALM	189.30	154920	8
2928 7R Electric Strike - 1/2" to 3/4" latch Failsafe/Failsecure 12/24V AC/DC 7-15/16" Radius Corner Faceplate	ALM	194.70	173212	8
Options: Keeper open/closed status \$48.70 list price adder Note: Additional finishes available for 2928. Inquire with Hager Customer Service for pricing.				
2930 CYL Electric Strike - Cylindrical lock Dual Voltage 12/24VDC ANSI/BHMA A156.31 Grade 1 UL Listed 3-hour fire rated Non-handed	US4 US10 US10B US26 US26D US32D	546.20 546.20 546.20 546.20 546.20 497.50	175715 156216 160255 175075 149642 149641	12
2930 MOR Electric Strike - Mortise lock Dual Voltage 12/24VDC ANSI/BHMA A156.31 Grade 1 UL Listed 3-hour fire rated Non-handed	US4 US10 US10B US26 US26D US32D	567.80 567.80 567.80 567.80 567.80 524.55	167282 160328 163253 149646 149645	12



Electrified Products

Description	Finish	2018 List	Stock No.	Case Qty.
2930 MDB	US4	594.85		12
Electric Strike - Mortise lock w/ Deadbolt	US10	594.85	175970	
Dual Voltage 12/24VDC	US10B	594.85	176007	
ANSI/BHMA A156.31 Grade 1	US26	594.85		
UL Listed 3-hour fire rated	US26D	594.85	149649	
Non-handed	US32D	540.75	149648	
Options:				
Latchbolt Monitor (LBM)		\$70.85 list price adder		
Door secure monitor (DSM)		\$146.05 list price adder		
Deadbolt monitor - (DBM) LH		\$75.75 list price adder		
Deadbolt monitor - (DBM) RH		\$75.75 list price adder		
2-679-0028	-	42.85	153474	12
Buzzer 12/24V AC/DC operation for 2925/2928/2930				
2-679-0029	-	23.80	155676	12
Rectifier for AC operation for 2925/2928/2930				
2941 Magnetic Lock	ALM	243.35	149650	4
600 lb. holding force 12/24VDC, field selectable				
2942 Magnetic Lock	ALM	292.05	149652	4
1200 lb. holding force 12/24VDC, field selectable				
2-679-0100	ALM	95.20	149653	8
Top Jamb Kit for 2942				
2-679-0101	ALM	95.20	149654	8
Top Jamb Kit for 2941				
2-679-0102	ALM	47.60	149655	8
Glass Door Kit for 2942				
2-679-0103	ALM	47.60	149656	8
Glass Door Kit for 2941				
2-679-0104	ALM	35.70	149657	8
Adjustable Angle Bracket for 2942 10-1/2" x 1-3/4" x 3-1/8"				
2-679-0106	ALM	23.80	149659	8
Angle bracket for 2942 (Cut for use with 2941) 10-1/2" x 1-1/2" x 3/4"				
2-679-0107	ALM	17.90	149660	6
Filler bar for 2942 (Cut for use with 2941) 5/8" x 3/4" x 10-1/2"				



Description	Finish	2018 List	Stock No.	Case Qty.	
2-679-0108 Filler bar for 2942 (Cut for use with 2941) 3/4" x 3/4" x 10-1/2"	ALM	17.90	149661	6	
2951 Magnetic Lock 1,650 lb. holding force Surface mount - single 12/24VDC	ALM	497.50	149701	2	
	DBZ	567.80	153513	2	
2952 Magnetic Lock 1,650 lb. holding force Surface mount - double 12/24VDC	ALM	1,011.25	152042	2	
	DBZ	1,146.40	153528	2	
2953 Magnetic Lock 1,200 lb. holding force Surface mount - single 12/24VDC	ALM	470.50	149707	2	
	DBZ	535.35	153533	2	
2954 Magnetic Lock 1,200 lb. holding force Surface mount - double 12/24VDC	ALM	951.75	152043	2	
	DBZ	1,092.35	153538	2	
Options: Adjustable timer input (TIME) \$75.75 (2-679-0109) Door Position Sensor (DPS) \$47.60 (2-679-0110)* Magnetic Bond Sensor (MBS) \$71.40 (2-679-0111)* Anti Tamper Switch (ATS) \$58.05 (2-679-0112)					
Note: Additional finishes available for 2951, 2952, 2953, 2954. Inquire with Hager Customer Service for pricing. * Must order two for use with the 2952 or 2954					
	2-679-0120 Top jamb kit 2951/2953	ALM	115.75	149709	4
	2-679-0130 Top jamb kit 2952/2954	ALM	232.55	153861	4
	2-679-0160 Glass door kit 2951/2953 * Order 2 ea. for double door	ALM	214.15	168468	8
	2-679-0180 Universal Bracket for 2951/2953	ALM	75.75	149710	12
	2-679-0181 Universal Bracket for 2951/2953	ALM	75.75	45390	10
2-679-0190 Universal Bracket for 2952/2954	ALM	151.45	161684	9	



Electrified Products



Description	Finish	2018 List	Stock No.	Case Qty.
2-679-0191 Universal Bracket for 2952/2954	DBZ	222.80	167699	9
2-679-0200 Spacer Bracket for 2951/2953	ALM	107.10	153684	12
2-679-0201 Spacer Bracket for 2952/2954	ALM	133.05	161686	9
2-679-0204 Armature mounting plate	-	71.40	167666	3
Note: Additional finishes available on many of the 2950 magnetic lock series accessories. Inquire with Hager Customer Service for pricing.				
2-679-0210 Coordinator mounting bracket for 2951/2953	ALM	142.80	160581	12
2-679-0220 Coordinator mounting bracket for 2952/2954	ALM	261.75	166426	6
2-679-0281 Filler bar - 1/8" x 1/-1/4" for 2951/2953	ALM	38.95	149711	12
2-679-0283 Filler bar - 1/8" x 1/-1/4" for 2951/2953	DBZ	74.65	149712	12
2-679-0291 Filler bar - 1/4" x 1/-1/4" for 2951/2953	ALM	40.05	149713	12
2-679-0293 Filler bar - 1/4" x 1/-1/4" for 2951/2953	DBZ	75.75	149715	12
2-679-0311 Filler bar - 1/2" x 1/-1/4" for 2951/2953	ALM	44.35	149716	12
2-679-0313 Filler bar - 1/2" x 1/-1/4" for 2951/2953	DBZ	80.05	149738	12
2-679-0321 Filler bar - 5/8" x 1/-1/4" for 2951/2953	ALM	47.60	149717	12
2-679-0323 Filler bar - 5/8" x 1/-1/4" for 2951/2953	DBZ	83.30	149739	12
2-679-0381 Filler bar - 1/8" x 1/-1/4" for 2952/2954	ALM	44.35	149718	12
2-679-0383 Filler bar - 1/8" x 1/-1/4" for 2952/2954	DBZ	80.05	149740	12
2-679-0391 Filler bar - 1/4" x 1/-1/4" for 2952/2954	ALM	47.60	149719	12
2-679-0393 Filler bar - 1/4" x 1/-1/4" for 2952/2954	DBZ	83.30	149741	12
2-679-0411 Filler bar - 1/2" x 1/-1/4" for 2952/2954	ALM	51.95	149720	12
2-679-0413 Filler bar - 1/2" x 1/-1/4" for 2952/2954	DBZ	87.65	149742	12



Description	Finish	2018 List	Stock No.	Case Qty.
2-679-0421 Filler bar - 5/8" x 1-1/4" for 2952/2954	ALM	54.10	149721	12
2-679-0423 Filler bar - 5/8" x 1-1/4" for 2952/2954	DBZ	89.80	149743	12
2-679-0491 Angle Bracket - 1-1/2" x 1-1/2" for 2951/2953	ALM	51.95	149734	12
2-679-0493 Angle Bracket - 1-1/2" x 1-1/2" for 2951/2953	DBZ	87.65	149744	12
2-679-0501 Angle Bracket - 2" x 1-1/2" for 2951/2953	ALM	54.10	149735	12
2-679-0503 Angle Bracket - 2" x 1-1/2" for 2951/2953	DBZ	89.80	149745	12
2-679-0571 Angle Bracket - 1-1/2" x 1-1/2" for 2952/2954	ALM	69.25	149736	12
2-679-0573 Angle Bracket - 1-1/2" x 1-1/2" for 2952/2954	DBZ	104.95	149746	12
2-679-0581 Angle Bracket - 2" x 1-1/2" for 2952/2954	ALM	73.55	149737	12
2-679-0583 Angle Bracket - 2" x 1-1/2" for 2952/2954	DBZ	109.25	149747	12
Note: Additional finishes available on many of the 2950 magnetic lock series accessories. Inquire with Hager Customer Service for pricing				
2961 Magnetic Shear Lock 2,000 lb. holding force 1-5/8" depth, integrated electronics	US32D	854.40	151837	6
2965 Magnetic Shear Lock 2,700 lb. holding force 1-5/8" depth, integrated electronics ITC, FTC, HTC Same Price	US32D	924.70	151838	6
Options: ITC for standard mounting armature kit for aluminum and hollow metal doors with 7/8" to 1-1/8" deep top channels, wood doors, and factory prepared hollow metal flush edge doors. FTC for mounting for field prepared horizontal mounting in hollow metal doors with flush edge. HTC for mounting 1-15/16" deep Herculite channels. Herculite top rail armature adjustment bracket for leading edge adjustments (HTR) \$393.75 list price adder Magnetic bond sensor (MBS) \$127.05 list price adder Door Position sensor (DPS) \$57.75 list price adder				
2-679-0600 Wood Door reinforcement box for 2961	-	47.60	158750	6
2958 Delayed Egress Magnetic Lock 1,650 lb. holding force Surface mount - single 12/24 VDC	ALM DBZ	1,308.65 1,378.65	149748 176098	6
2958 T Tandem Delayed Egress Magnetic Lock 1,650 lb. holding force Surface mount - double 12/24 VDC	ALM DBZ	2,200.90 2,276.60		6



Electrified Products

Description	Finish	2018 List	Stock No.	Case Qty.
<p>Operation (Must Specify): NA - IBC, IFC, NFPA101, NFPA1-UFC, UBC, SBC Compliant ND - IBC, IFC, California Building Code OSHPD, NFPA 101, NFPA1-UFC, UBC, SBC Compliant BD - BOCA National Building Code CH - City of Chicago Building Code</p> <p>Reset Control: Built in key switch - 1-30 second timed bypass, sustained bypass and alarm reset (std) (Not available with BOCA and Chicago operation) Built in reset push switch. Available with NFPA (NA) only Less key or push switch (No price reduction)</p> <p>Options: Door Position Status (DPS) \$43.30 list price adder Magnetic Bond Sensor (MBS) \$70.85 list price adder Anti-Tamper Switch (ATS) \$59.50 list price adder</p>				
<p>2972 Exit Switch MSD 2" Square button Momentary, SPDT 10 AMP contact</p>	US32D	75.75	149630	12
<p>2972T Exit Switch with Integrated Adjustable Timer 2" Square Button Adjustable 1-60 second timer Note: Not Code Compliant</p>	US32D	146.05	151710	6
<p>Options: Red LED \$21.65 list price adder Green LED \$21.65 list price adder 2 LED's \$27.05 list price adder</p>				
<p>2973 Code Compliant Exit Switch 2" Square Button Integrated fixed 30- second timer CSFM Listed, NFPA, IBC, IFC code compliance for Access Controlled Egress Doors LED illumination</p>	US32D	151.45	149631	6
<p>Options: Red LED \$21.65 list price adder Green LED \$21.65 list price adder 2 LED's \$27.05 list price adder</p>				
<p>2977 Exit Switch Piezoelectric Button Green & Red Illumination Adj. 1-35 sec. 12/24VDC Timer</p>	US32D	151.45	149634	12
<p>2978 Touchless Exit Switch Infrared sensor Illuminated status indication</p>	US32D	89.25	149636	12
<p>4801 Pressure Sense Bar Pressure sense technology; Tri-failsafe 12/24 VDC voltage sense input includes 10 ft. cable and connector; armored power transfer loop 36" Standard, Optional 42" & 48" available</p>	ALM BLK	392.60 392.60	156360 167722	6





Description	Finish	2018 List	Stock No.	Case Qty.
2-679-0611 PIR Egress Sensor	White	259.60	149632	12
2-679-0612 PIR Egress Sensor	Black	259.60	149633	12
2-679-0708 Under Desk Push Switch	White	111.65	176289	1
2-679-0620 Concealed Mortise Power Transfer Loop	-	71.40	149750	12
2-679-0621 Heavy Duty Power Transfer 2-Wire	ALM	427.20	152079	6
2-679-0622 Heavy Duty Power Transfer 2-Wire	DBZ	427.20	160604	6
2-679-0623 Heavy Duty Power Transfer 10-Wire	ALM	427.20	149751	6
2-679-0624 Heavy Duty Power Transfer 10-Wire	DBZ	427.20	154018	6
2-679-0625 Concealed Magnetic Contact	ALM	118.15	152890	12
2-679-0626 Concealed Door Status Sensor	-	37.90	182672	1
2-679-0640 Single gang back box	-	14.35	149752	1
2-679-0641 3-gang interior mount box	-	107.10	166911	1
2-679-0642 Shroud for surface mount box outdoor use	-	68.00	166912	1
2-659-0368 Restroom Kit	US32D	300.00	34125	1
2-659-0372 Emergency Kit	US32D	555.00	34130	1
2-679-0650 Emergency Door Release Blue break glass station	-	218.50	149754	6



8400 Series - Low Energy Power Operator



Description	Mount	Finish	2018 List	Stock No.	Box Qty.
8418 Single Operator	Push	ALM	4,507.65	162136	1
1 unit, 1 controller, single cover, handed		DBZ	4,507.65	162141	
Standard Sizes - 36"	Pull	ALM	4,538.10	162138	
42", 44" and 48" - add \$263.00 to list price		DBZ	4,538.10	162143	
Specify Push or Pull side of door					
8419 Simultaneous Pair	Push	ALM	8,090.25	162145	1
2 units, 1 controller, double cover, non-handed		DBZ	8,090.25	162147	
Standard Sizes - 60" and 72"	Pull	ALM	8,190.00	162146	
84", 88", 92" and 96" - add \$263.00 to list price		DBZ	8,190.00	162148	
Specify Push or Pull side of door					
8420 Independent Pair	Push	ALM	8,842.05	162149	1
2 units, 2 controllers, double cover, non-handed		DBZ	8,842.05	162151	
Standard Sizes - 60" and 72"	Pull	ALM	8,944.95	162150	
84", 88", 92" and 96" - add \$263.00 to list price		DBZ	8,944.95	162152	
Specify Push or Pull side of door					
8421 Double Egress Simultaneous Pair	Push/Pull	ALM	8,594.00	162153	1
2 units, 1 controller, double cover, non-handed		DBZ	8,594.00	162154	
Standard Sizes - 60" and 72"					
84", 88", 92" and 96" - add \$263.00 to list price					
8422 Double Egress Independent Pair	Push/Pull	ALM	9,392.20	162155	1
2 units, 2 controllers, double cover, non-handed		DBZ	9,392.20	162156	
Standard Sizes - 60" and 72"					
84", 88", 92" and 96" - add \$263.00 to list price					
8423 Single Operator with Mechanical Closer	Push	ALM	6,090.00		1
1 unit, 1 controller, 1-5100 Series Door Closer,		DBZ	6,090.00		
double cover, handed	Pull	ALM	6,090.00		
Standard Sizes - 60" and 72"		DBZ	6,090.00		
84", 88", 92" and 96" - add \$263.00 to list price					
Specify Push or Pull side of door					
*Note: Non-standard door widths in quantities under 50 units: please contact Technical Support for list adder.					
*Note: Curtain wall operators are available. Please contact Technical Support					



8400 Series - Low Energy Power Operator



Description	Finish	Year List	Stock No.	Case Qty.	Box Qty.
2-659-0151 Pull Side Track Arm with 20mm Spindle	ALM	435.75	162512	-	1
2-659-0152 Pull Side Track Arm with 20mm Spindle	DBZ	530.25	162513	-	
2-659-0153 Push Side Standard Arm with 35mm Spindle	ALM	435.75	162515	-	1
2-659-0154 Push Side Standard Arm with 35mm Spindle	DBZ	530.25	162516	-	
2-659-0220 Push Side Standard Arm with 50mm Spindle For use with double egress assemblies	ALM	435.75	162561	-	1
2-659-0221 Push Side Standard Arm with 50mm Spindle For use with double egress assemblies	DBZ	530.25	162562	-	
2-659-0222 Double Egress Arm Assembly Track arm with 20mm Spindle	ALM	787.50	162563	-	1
2-659-0223 Double Egress Arm Assembly Track arm with 20mm Spindle	DBZ	892.50	162564	-	
2-659-0224 20mm Replacement Spindle For use with double egress and track arm assembly	ALM	150.70	162565	-	1
2-659-0225 20mm Replacement Spindle For use with double egress and track arm assembly	DBZ	183.75	162566	-	
2-659-0226 35mm Replacement Spindle For use with standard single and standard pair applications	ALM	150.70	162567	-	1
2-659-0227 35mm Replacement Spindle For use with standard single and standard pair applications	DBZ	183.75	162568	-	
2-659-0228 50mm Replacement Spindle	ALM	150.70	162570	-	1
2-659-0229 50mm Replacement Spindle For use with push side standard arm - double egress only	DBZ	183.75	162573	-	
2-659-0230 Narrow Top Rail Drop Plate	ALM	133.35	162693	-	1
2-659-0231 Narrow Top Rail Drop Plate	DBZ	133.35	162694	-	
2-659-0232 Cover for Single Operator - 36"	ALM	252.00	162574	-	1
2-659-0233 Cover for Single Operator - 36"	DBZ	252.00	162661	-	



8400 Series - Low Energy Power Operator



Description	Finish	2018 List	Stock No.	Case Qty.	Box Qty.
2-659-0234 Cover for Dual Operators - 72"	ALM	441.00	162663	-	1
2-659-0235 Cover for Dual Operators - 72"	DBZ	441.00	162692	-	-
Note: Additional sizes available. Inquire with Hager customer service for pricing.					
2-659-0236 Power Supply On-Board 115 VAC 60Hz 24 VDC 500mA		824.25	162696	-	1
2-659-0237 Relay Board 24VDC 40mA 5 amp/ 220 VAC or 28VDC DPDT contacts		32.05	162697	-	1



8300 Series - Low Energy Power Operator



Description	Mount	Finish	2018 List	Stock No.	Box Qty.
8318 Single Operator	Push	ALM	3,250.00	75963	1
1 unit, single cover, non-handed		DBZ	3,625.00	75960	1
Standard Sizes - 36"	Pull	ALM	3,250.00	75956	1
42", 44" and 48"		DBZ	3,625.00	75937	1
Specify Push or Pull side of door					
8319 Simultaneous Pair	Push	ALM	6,500.00	75652	1
2 units, double cover, non-handed		DBZ	7,670.00	75653	1
Standard Sizes - 72"	Pull	ALM	6,500.00	75650	1
84", 88", and 96"		DBZ	7,670.00	75644	1
Specify Push or Pull side of door					
8321 Double Egress Simultaneous Pair	Push/Pull	ALM	7,205.00	-	1
2 units, double cover, non-handed					
Standard Sizes - 72"					
84", 88", 96"					

For non-standard sizes, add \$246.90 to single operator list price. For doubles, add \$370.40 to the list price.



8300 Series - Low Energy Power Operator

Description	Finish	2018 List	Stock No.	Case Qty.	Box Qty.
2-679-0901 8300 - 20mm Replacement Spindle		113.65	75504	-	1
2-679-0902 8300 - 35mm Replacement Spindle		113.65	75500	-	1
2-679-0903 8300 - 50mm Replacement Spindle		113.65	75501	-	1
2-679-0904 8300 - 80mm Replacement Spindle		136.40	75502	-	1
2-679-0896 8300 - Standard Arm w/ 35mm Spindle (Push)	ALM	340.90	75498	-	1
2-679-0897 8300 - Standard Arm w/ 35mm Spindle (Push)	BLK	340.90	75494	-	1
2-679-0898 8300 - Track Arm w/ 20mm Spindle (Pull)	ALM	431.90	75495	-	1
2-679-0899 8300 - Track Arm w/ 20mm Spindle (Pull)	BLK	431.90	75485	-	1
2-679-0900 8300 - Dbl Egress Arm w/ 20mm Spindle (Pull)	ALM	136.40	75482	-	1
2-679-0905 8300 - Standard Arm Extension	ALM	227.25	75478	-	1
2-679-0906 8300 - Standard Arm Extension	BLK	909.15	75472	-	1
2-679-0907 8300 - KP EVO Programming Device		1,181.90	75470	-	1



Electrified Products - Low Energy Power Operator Controls



Description	Finish	2018 List	Stock No.	Case Qty.	Box Qty.
2-659-0303 6" Round with Text & Logo	US32D/Blue	206.00	185055	12	1
2-659-0304 6" Round with Logo Only	US32D/Blue	206.00	185058	12	1
2-659-0305 4-3/4" Square with Text & Logo	US32D/Blue	206.00	185056	12	1
2-659-0306 4-3/4" Square with Logo Only	US32D/Blue	206.00	185059	12	1
2-659-0307 4-3/4" Square with Logo Only	US32D/Blue	206.00	186793	12	1
2-659-0308 4-3/4" Square with Text Only	US32D/Blue	206.00	186794	12	1
2-659-0161 6" Round Actuator Push To Open and Handicap Symbol	US32D/Blue	123.60	162698	20	1
2-659-0162 6" Round Actuator Handicap Symbol	US32D/Blue	123.60	162699	20	1
2-659-0357 4.5" Square Actuator Push to Open text and Accessibility Logo	US32D/Blue	97.55	068110	20	1
2-659-0358 6" Round Actuator Push to Open text and Accessibility Logo	US32D/Blue	97.55	068104	20	1
2-659-0163 Surface Mount Box For 6" Round Actuator	Black	41.20		20	1



Electrified Products - Low Energy Power Operator Controls



Description	Finish	2018 List	Stock No.	Case Qty.	Box Qty.
2-659-0164 Weather Ring For 6" Round Actuator	Black	8.25	162701	10	1
2-659-0165 4.5" Round Actuator Push To Open and Handicap Symbol	US32D/Blue	107.15	162703	20	1
2-659-0166 4.5" Round Actuator Handicap Symbol	US32D/Blue	107.15	162704	20	1
2-659-0167 Surface Mount Box For 4.5" Round Actuator	Black	33.00	162705	20	1
2-659-0168 Weather Ring For 4.5" Round Actuator	Black	8.25	162706	10	1
2-659-0241 Universal Back Plate For use when mounting 4.5" round or 4.5" square actuator to bollard post	US32D	26.80	162743	10	1
2-659-0169 6" Square Actuator Push To Open and Handicap Symbol	US32D/Blue	123.60	162707	20	1
2-659-0170 6" Square Actuator Handicap Symbol	US32D/Blue	123.60	162708	20	1
2-659-0171 Surface Mount Box For 6" Square Actuator	Black	33.00	162709	20	1
2-659-0172 4.5" Square Actuator Push To Open and Handicap Symbol	US32D/Blue	100.95	162710	20	1
2-659-0173 4.5" Square Actuator Handicap Symbol	US32D/Blue	100.95	162711	20	1



Electrified Products - Low Energy Power Operator Controls



Description	Finish	2018 List	Stock No.	Case Qty.	Box Qty.
2-659-0174 Surface Mount Box For 4.5" Square Actuator	Black	33.00	162712	45	1
2-659-0175 1.5" x 4.75" Jamb Actuator Push To Open and Handicap Symbol	US32D/Blue	97.85	162713	20	1
2-659-0176 1.5" x 4.75" Jamb Actuator Handicap Symbol	US32D/Blue	97.85	162714	20	1
2-659-0177 Surface Mount Box For 1.5" x 4.75" Jamb Actuator	Black	20.60	162715	20	1
2-659-0178 36" Low Profile Actuator Push To Open and Handicap Symbol Wireless Includes 433 MHz wireless transmitter Exceeds California Building Code, Section 1117B.6	US32D/Blue	721.00	162716	2	1
2-659-0179 36" Low Profile Actuator Push To Open and Handicap Symbol Hard Wired Exceeds California Building Code, Section 1117B.6	US32D/Blue	664.35	162717	2	1
2-659-0242 4.75" Vestibule Actuator Push To Open and Handicap Symbol	US32D/Blue	247.20	162741	20	1
2-659-0243 Surface Mount Box For 4.75" Vestibule Actuator	Black	77.25	162742	42	1
2-659-0180 Bollard Post For use with 4.5" round and 4.5" square push plates	Black	515.00	162720	1	1
2-659-0181 Bollard Post For use with 4.5" round and 4.5" square push plates	Bronze	515.00	162724	1	1



Electrified Products - Low Energy Power Operator Controls



Description	Finish	2018 List	Stock No.	Case Qty.	Box Qty.
2-659-0182 Bollard Post For use with 4.5" round and 4.5" square push plates	Silver	515.00	162725	1	1
2-659-0183 433 MHz Receiver Digital, Radio Controlled	-	118.45	162726	20	1
2-659-0184 3-Volt Transmitter Wireless Hardwired to actuator	Black	113.30	162727	20	1
2-659-0185 9-Volt Transmitter Wireless	Black	113.30	162728	20	1
2-659-0186 Wireless Transmitter One Button	Black	113.30	162729	20	1
2-659-0240 Programmable Relay and Door Sequencer For door timing and advanced relay sequencing	-	179.45	082867	20	1

*Note: Actuators come standard hard-wired. Must order receiver and transmitter separately for wireless applications.



Electrified Products - Pedestrian Presence Sensors



Description	Finish	2018 List	Stock No.	Case Qty.	Box Qty.
2-659-0332 Bodyguard Sensor Overhead Presence Sensor	Black	\$541.05		24	1
2-659-0333 Bodyguard Programming Remote		\$61.15		1	1
2-659-0334 Bodyguard Mounting Kit	Black	\$56.00		20	1
2-659-0335 Superscan I Safety Sensor Single Mount Unit	Black	\$391.80		6	1
2-659-0336 Superscan II Safety Sensor Single Mount Unit with Master and Slave Modules	Black	\$671.65		6	1





One Family. One Brand. One Vision.™

www.hagerco.com

TABLE OF CONTENTS

A
 Architectural Finish Symbols..... 3-4

B
 Back Plate 12

E
 ECCO 72-74
 Emergency Stop Release..... 14

F
 Fasteners.....9-10

D
 Detention Food Pass Through Hinge..... 31
 Detention Hinge (IHT) 22, 28, 31
 Detention Utility Hinge..... 31

H
 Hinge Additions/Modifications5-11
 Hinges - Electric5-7
 Hinge Pins 8
 Hinge Tips..... 11

Hinges – Brass or Stainless Steel
 BALL BEARING FIVE KNUCKLE
 Anchor 33-34, 46
 Full Mortise..... 39-51, 68
 Half Mortise 32,
 Swing Clear 67
 Wide Throw 45-47, 50-51
 CONCEALED BEARING THREE KNUCKLE
 Anchor 74-75
 Full Mortise..... 24-28
 Full Surface.....26, 29
 Half Mortise26, 28
 Half Surface26, 29
 Wide Throw 25-28
 PLAIN BEARING FIVE KNUCKLE
 Full Mortise..... 39-40, 67
 PLAIN BEARING THREE KNUCKLE
 Full Mortise.....23, 29
 CONCEALED BEARING FIVE KNUCKLE
 Full Mortise..... 5
 CONCEALED BEARING TWO KNUCKLE
 Full Mortise..... 30

Hinges – Steel

BALL BEARING FIVE KNUCKLE
 Anchor 33-34
 Full Mortise..... 35-38, 56-57, 60-62, 65-66
 Full Surface..... 70-71
 Half Mortise 32
 Half Surface 33
 Swing Clear 55-56
 Wide Throw 37-38, 63-66
 CONCEALED BEARING THREE KNUCKLE
 Anchor 72-73
 Full Mortise..... 17-23
 Full Surface.....20, 22
 Half Mortise20, 22
 Half Surface20, 23
 Swing Clear 71-74
 Wide Throw 19-22
 PLAIN BEARING FIVE KNUCKLE
 Full Mortise..... 56-59
 Half Mortise 32
 Half Surface 37
 Swing Clear 54-56
 Welding 69
 PLAIN BEARING THREE KNUCKLE
 Full Mortise..... 15-16
 CONCEALED BEARING TWO KNUCKLE
 Full Mortise..... 30
 PLAIN BEARING TWO KNUCKLE
 Full Mortise.....29, 31

Hinges – Spring
 Double Acting 67
 Full Mortise..... 51-54
 Full Mortise - Stainless Steel..... 32
 Half Surface 52
 Reverse Action..... 53-54
 Spring Hinge Sets..... 53

L
 Lead Times 2

M
 Molly Jack Nut..... 12
 Mortar Box..... 12



Commerical Hinges

P

Pivots.....	13-15
Pivots Rack & Pinion	14
Pivot Reinforcing	12

R

Reinforcement Plate	12
---------------------------	----

S

Set Screws (Set).....	12
Sleeve Bolt.....	13
Strike - Combination Rescue	13
Strike - Double Lip.....	12-13

T

Tip Kits.....	65-66
---------------	-------

LEAD TIMES

Stock items will typically ship in five working days or less from the order entry date. Made-to-order items will typically ship in 15 working days depending on seasonal volume and order complexity. Special orders including industrials, special machining, and large quantities may need to be scheduled. The anticipated ship date will be included with each order acknowledgement. Please contact Customer Service if product availability is in question.

QUICK SHIP

Products denoted with **red and bold** pricing are available to order through the Quick Ship program and ship within 24 hours. When ordering these products please visit www.hagerco.com and log in to MyHager to access the 'Quick Ship' portal. Due to the promptness of the fulfillment process, Quick Ship orders are non-cancellable.

CANCELLATION NOTIFICATION

Cancellation for made-to-order items must be communicated within 48 hours of order placement.

ARCHITECTURAL FINISH SYMBOLS

These additions apply to the BASE HINGE LIST PRICE as listed in the book. Not all products are available in all finishes. Contact Hager Companies Sales and Service (1-800-325-9995) for more specific information.

BHMA Symbol Base Material

*if not listed in pricing sections

US & HAGER	DESCRIPTION	PRICING INSTRUCTIONS	STEEL	BRASS & BRONZE	STAINLESS STEEL
2C	Plain Zinc Plate	20% above US10A or US10B price	603	N/A	N/A
H2H x BP	Mechanical Galvanized; Steel Only	25% above US10A price	N/A	N/A	N/A
3	Bright Brass	Use price of US10B	632	605	N/A
3A	Bright Brass - Unlacquered	Use price of US3	N/A	N/A	N/A
4	Satin Brass	Use price of US10	633	606	N/A
5	Satin Brass, Oxidized	Use price of 10A/10B	638	609	N/A
9	Bright Bronze	20% above US10A or US10B price	637	611	N/A
10	Satin Bronze	As listed	639	612	N/A
10A (US11)	Antique Bronze, Lacquered	As listed (steel only)	641/643	N/A	N/A
10B	Antique Bronze, Oiled	Use price of US10A	640	613	N/A
10Z	Antiqued Bronze-SPL	Use price of US10A/US10B	N/A	N/A	N/A
10D	Black Nickel, Oiled	Use price of US10B	640	613	N/A
SS/10Z	Antique Bronze, Stainless Steel	30% above 32D	N/A	N/A	N/A
13P	White	20% above US10			
14	Bright Nickel	20% above US10A or US10B	645	618	N/A
15	Satin Nickel	Use price of US10A or US10B	646	619	N/A
15A	Satin Nickel, Nickel Oxidized & Highlighted	20% above US10A or US10B	647	620	N/A
17A	Black Nickel, Dull	20% above US10A or US10B	648	621	N/A
26	Bright Chromium Plated	Use price of US10A or US10B	651	625	N/A
26D	Satin Chromium Plated	As listed	652	626	N/A
32	Stainless Steel Metal, Bright	Use price of US32D	N/A	N/A	629
32D	Stainless Steel Metal, Satin (304)	As listed	N/A	N/A	630
32D (316)	Stainless Steel Metal, Satin (316)	POA	N/A	N/A	630
32D (CLR)	Stainless Steel Metal, Satin (Clear Coat)	30% above US32D	N/A	N/A	630
83P	Semi Bright Black	20% above US10			
P	Prime Coat	Use price of US10	600	600	N/A
PS	Plain Steel	Use price of US4 or USP	N/A	N/A	N/A
L1	Flat Black	Use price of US10	693	693	N/A
L2 (90P)	Dark Bronze	Use price of US10	695	695	N/A
L3	Medium Bronze	Use price of US10	694	694	N/A
LS	Luma Sheen®	Use price of US10	689	689	N/A



Commercial Hinges

Whenever possible, Hager Companies employs the latest technologies in metal finishing to provide the best long-term performance for our customers. Some finishes may not comply completely with BHMA (Builders Hardware Manufacturing Association) Standard A156.18 specifications with regard to plating process. However, they match BHMA color standards and exceed all BHMA performance criteria with regard to such tests as salt spray corrosion resistance, ultraviolet light deterioration resistance, solvent resistance, perspiration resistance, and finish hardness. For the convenience of our customers, we refer to the most appropriate finish symbols to indicate similarity of appearance using BHMA standard nomenclature including the "US" and numerical designation. Dissimilar metals are plated to match or be compatible to the finishes indicated. Finish numbers indicated on each product are the most equivalent to the old "US" symbol numbers and carry the BHMA finish symbol in parenthesis adjacent to the finish: Example — US3 (605) - Bright Brass or US26D (626) - Satin Chrome.

Hager's finishes are durable, high quality finishes obtained by careful processing of steel, brass, and stainless steel materials. It is important to consider usage and climatic conditions when selecting finishes. This is especially true in areas subjected to strong corrosive chemical conditions, humid climate or salt air which may have a damaging effect on metal finishes in a very short period of time. The longevity and preservation of the finish appearance are determined by base metal and finish process.

Care and maintenance of clear protective coatings or other organic finishing applications may require different methods of cleaning and care. As an example, all hardware finishes should not be cleaned with solvents or abrasives; surfaces should periodically be cleaned with a mild, non-abrasive soap and dried lightly with a soft, clean cloth. The type of base material and finishing techniques must be considered when applying any cleaning or preservative method. Contact Hager's Sales and Service Department for further information on the care of hardware finishes.

Note: Hager only warrants US10B finish over brass or bronze base material. If steel base material is necessary, Hager recommends US10A lacquer finish.



HINGE ADDITIONS/MODIFICATIONS

These additions apply to the BASE HINGE LIST PRICE as listed in the book. They do not apply to the price of any hinges listed with additions in this book. If the hinge to be priced has additions, START WITH THE PRICE OF THE BASE HINGE, THEN ADD "FOR ADDITIONS WHERE NOT LISTED."

Antimicrobial powder coat protection - Symbol is 'MV5' (use as suffix). List price is \$22.70.

Bearings

Ball bearings (symbol 'BB') and anti-friction bearings (symbol 'AB') regularly furnished. Oilite bearings (symbol 'OB') and CB (concealed bearing) available on select hinges at same price as ball bearings.

*To maximize hinge life and assist in achieving ADA compliance, Hager recommends the use of anti-friction or ball bearing hinges with door closer products.



Commercial Hinges

Concealed Electric Hinge Modification

Swing clear, wide throw, raised barrel – add \$160. Available on Heavy weight only.

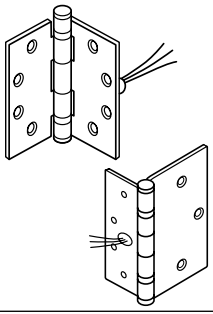
	CONCEALED ELECTRIC MONITOR		
	Description	Steel/Brass List	Stainless Steel List
	Miniature snap action switch is incorporated into the frame leaf. Available in 4" through 8". Full mortise ball bearing hinges. Concealed electric monitor, per hinge.	\$352.35	\$460.15
NRP not necessary as hinges are cross pinned and are not field removable. To order, use symbol 'EMN' as suffix.			

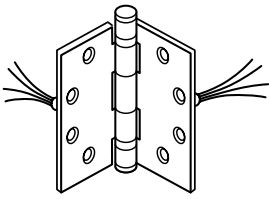
	CONCEALED ELECTRIC THROUGH-WIRE		
	Description	Steel/Brass List	Stainless Steel List
	Four continuous electric conductors (28 gauge wire). Available in 4" through 8". Full mortise ball bearing, standard weight and heavy weight in steel and brass material. NRP not necessary as hinges are cross pinned and are not field removable. To order, use symbol 'ETW' as suffix.		
	<u>Extra charges (each)</u>		
	ETW-4 (4 wire)	\$314.05	\$392.55
	ETW-8 (8 wire)	\$348.25	\$435.30
	ETW-12 (12 wire)	\$487.45	\$609.35
	ETW-2 (18 GA)**	\$414.55	\$517.00
	ETW-6-1828 (2-18 GA, 4-28 GA)*/**	\$459.65	\$574.60
	ETW-8-1828(2-18 GA, 6-28 GA)*/**	\$508.40	\$634.45

* Not available on three knuckle hinges. ** Not available on swing clear.

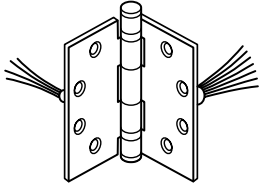

CONCEALED ELECTRIC THROUGH-WIRE & MONITOR			
Description		Steel/Brass List	Stainless Steel List
	This combines the 4, 8, or 10 continuous electrical conductors and the miniature snap action switch to provide continuous circuit and monitor capabilities. Available in 4" through 8". Full mortise ball bearing or anti-friction bearing, standard weight and heavy weight in steel and brass material. NRP not necessary as hinges are cross pinned and are not field removable. To order, use symbol 'ETM' as suffix.		
	<u>Extra charges (each)</u>		
	ETM-4 (4 wire)	\$666.40	\$833.00
	ETM-8 (8 wire)	\$697.75	\$872.20
	ETM-10 (10 wire)	\$764.66	\$955.76

The hospital tip feature is available on concealed electric hinges.

STANDARD WIRE LEAD - 8" per side: 18 or 28 gauge wire
 Additional wire leads - must be bought in 4, 8, and 12 feet lengths. Price includes both sides.

Description	List
4-wire hinge; per foot	\$7.45
6-wire hinge; per foot	\$7.45
8-, 12-wire hinge; per foot	\$7.45

Quick Connect

Extra charge \$43.40 per hinge (available on ETW 4, 8, and 12 wire. Not available with 18g wire.).

QUICK CONNECT HARNESS CABLES - connectors installed on one end, pigtails on the other for easy install in the field

Part Number	Description	List Price
1-479-0007	3" Wire Harness Assembly	\$55.90
1-479-0008	6" Wire Harness Assembly	\$58.30
1-479-0012	12" Wire Harness Assembly	\$72.00
1-479-0026	26" Wire Harness Assembly	\$85.70
1-479-0032	32" Wire Harness Assembly	\$86.75
1-479-0038	38" Wire Harness Assembly	\$89.25
1-479-0044	44" Wire Harness Assembly	\$92.60
1-479-0400	50" Wire Harness Assembly	\$94.30
1-479-1500	15'2 Wire Harness Assembly	\$168.00

Five Knuckle Concealed Bearing Hinges (CB)

Available on standard weight, heavy weight full mortise 3-1/2", 4", 4-1/2", and 5". Price same as Ball Bearing (BB).



Commerical Hinges

Prices and Part Numbers for Hinge Pins (Boxes of 10 Each)

Contract Grade Pins Size 4-1/2"

STANDARD WEIGHT		
STEEL - FINISH	PART NUMBER	LIST (10/BOX)
US3	1-890-7550	\$63.45 per box
US4	1-890-7619	\$63.45 per box
US10	1-890-7695	\$63.45 per box
US10A/US10B	1-890-7733	\$63.45 per box
US26	1-890-7625	\$63.45 per box
US26D	1-890-7657	\$63.45 per box
USP	1-890-7771	\$63.45 per box
L1	1-890-7772	\$63.45 per box

HEAVY WEIGHT		
STEEL - FINISH	PART NUMBER	LIST (10/BOX)
US3	1-890-8269	\$77.60 per box
US10	1-890-8270	\$77.60 per box
US10A/US10B	1-890-8267	\$77.60 per box
US26D	1-890-8305	\$77.60 per box
USP	1-890-8268	\$77.60 per box

Non-Removable Pins (Medium Security)

<u>Symbol</u>	<u>Description</u>	<u>List</u>
NRP*	Set screw in barrel	\$5.00 ea.

*This modification is intended as a deterrent only. It is not to be considered suitable for high-security applications or abusive environments.

Raised Barrel Hinges

- Specify handing and door thickness.
- Not available on 8" x 6" or 8" x 8" hinges.
- Prices apply to both standard and heavyweight hinges.
- **Prices listed for 1-3/8" and 1-3/4" doors only.**
- **For 2" or greater doors add 30%**
- **Available on select hinge models**

<u>Symbol</u>	<u>Description</u>	<u>List</u>
RBB	Raised Barrel for Mortised Jamb Leaf, Beveled Edge Door Leaves Equal	\$44.75 ea.
RBS	Raised Barrel for Mortised Jamb Leaf, Square Edge Door Leaves Equal	\$44.75 ea.
ISM	Raised Barrel for Jamb Surface Mount, Leaves Equal	\$44.75 ea.



Clear Coat

Not available on all finishes.

<u>Symbol</u>	<u>List</u>
CLR	Add 30% to list price of hinge

Round Corners

Round corners (1/4" and 5/8" radius). Specify radius desired; standard radius 1/4".

<u>Symbol</u>	<u>List</u>
RC	\$8.00 ea.

***Available on select hinge models**

Safety Stud

Security offered to prevent slipping leaves past one another when hinge is closed. Stud attached to one leaf projects into hole in matching leaf.

<u>Symbol</u>	<u>List</u>
SH*	\$19.05 ea.

This feature not necessary on anchor hinges

* This modification is intended as a deterrent only. It is not to be considered suitable for high-security applications or abusive environments.

Reverse Safety Stud - Heavy Weight Only

Reverse safety studs extend into reinforcing plate of door & frame to help prevent screw shearing.

<u>Symbol</u>	<u>List</u>
RSS	\$29.40 ea.

Note: Available on steel, stainless steel detention or institutional tip hinges only. Not available on solid brass hinges.

Special Applications

In the event you do not find the particular hinge which will meet your requirements, we recommend that you contact Hager Companies Sales and Service and provide us with your specification.

Special Screws

All butt hinges are regularly packed with flat Phillips head wood or machine screws or bolts. All other types are special.

Extra for tamper proof torx screws

<u>Description</u>	<u>List</u>
Steel	\$1.50 per screw 12.00 hinge
Stainless steel	\$1.95 per screw 15.60 hinge

Boxed Screws

Machine Torx (12-24 x1/2 - for 4", 4.5", 5" hinges)

<u>Description</u>	<u>List</u>
1-804-3212 (26D)	\$150.00 per box-torx (100/box)
1-803-3205 (32D)	\$175.00 per box-torx (100/box)

Wood Torx (1-1/4x12 - for 4", 4.5", 5" hinges)

<u>Description</u>	<u>List</u>
1-810-9920 (26D)	\$150.00 per box-torx (100/box)
1-813-9910 (32D)	\$175.00 per box-torx (100/box)



Commerical Hinges

Standard Screw Packs for Full Mortise Architectural Hinges

PART NUMBER	SIZE	FINISH	SCREWS
700, AB700, 1279, BB1279, EC1100, EC1105, 1250 (with or without NRP), ECBB1100	4-1/2" x 4-1/2" 4-1/2" x 4	US3, US4, US5, US10, US10A (US11), US10B, US15, US15A, US26, US26D, USP	AMS & AWS
Other than listed above	4-1/2"	Other than listed above	AMS & 1/2 WS
All	3-1/2"	All	AWS & 1/2 MS
All	4"	All	AWS & 1/2 MS
All	5"	All	AMS & 1/2 WS
All hinges with decorative tips	All	All	AWS
Note: Hinge additions listed on pages 5-9 will affect standard screw packaging.			

Prices and Part Numbers for Bulk Packed Screws Contract grade hinges size 4", 4-1/2", and 5"

WOOD SCREWS 1-1/4" x 12 FPHW - STEEL			MACHINE SCREWS 12-24 x 1/2" FPHM - STEEL		
PART NUMBER	FINISH	LIST (100/BOX)	PART NUMBER	FINISH	LIST (100/BOX)
1-810-5824	US3	\$108.80 per box	1-800-7225	US3	\$54.20 per box
1-810-5952	US4	\$108.80 per box	1-800-7275	US4	\$54.20 per box
1-810-6208	US10	\$108.80 per box	1-800-7375	US10	\$54.20 per box
1-810-6336	US10A/US10B	\$108.80 per box	1-800-7425	US10A (US11)/US10B	\$54.20 per box
1-810-6848	US26	\$108.80 per box	1-800-7575	US26	\$54.20 per box
1-810-5696	US26D	\$108.80 per box	1-800-7175	US26D	\$54.20 per box
1-810-6976	USP	\$108.80 per box	1-800-7625	USP	\$54.20 per box
1-810-7232	L1	\$108.80 per box	1-800-7725	L1	\$54.20 per box

WOOD SCREWS 1-1/4" x 12 FPHW - BRASS			MACHINE SCREWS 12-24 x 1/2" FPHM - BRASS		
PART NUMBER	FINISH	LIST (100/BOX)	PART NUMBER	FINISH	LIST (100/BOX)
1-811-5824	US3	\$215.80 per box	1-801-7225	US3	\$108.05 per box
1-811-5952	US4	\$215.80 per box	1-801-7275	US4	\$108.05 per box
1-811-6208	US10	\$215.80 per box	1-801-7375	US10	\$108.05 per box
1-811-6336	US10A/US10B	\$215.80 per box	1-801-7425	US10A (US11)/US10B	\$108.05 per box
1-811-6848	US26	\$215.80 per box	1-801-7575	US26	\$108.05 per box
1-811-5696	US26D	\$215.80 per box	1-801-7175	US26D	\$108.05 per box
1-811-6976	USP	\$215.80 per box	1-801-7625	USP	\$108.05 per box
1-811-7232	L1	\$215.80 per box	1-801-7725	L1	\$108.05 per box

WOOD SCREWS 1-1/4" x 12 FPHW - STAINLESS STEEL			MACHINE SCREWS 12-24 x 1/2" FPHM - STAINLESS STEEL		
PART NUMBER	FINISH	LIST (100/BOX)	PART NUMBER	FINISH	LIST (100/BOX)
1-813-2500	US32	\$215.80 per box	1-803-2500	US32	\$108.05 per box
1-813-2499	US32D	\$215.80 per box	1-803-2499	US32D	\$108.05 per box

Stainless Steel Balls and Raceways

Furnished if desired on steel or brass ball bearing hinges.

<u>Description</u>	<u>List</u>
Standard weight two ball bearing hinge.....	\$23.35 ea.
Heavy weight four ball bearing hinge.....	\$28.25 ea.

Swaging

Swaging, no holes or flat surface, add 30% to list price of hinge.

Tips - Exposed

<u>Symbol</u>	<u>Description</u>	<u>List</u>
ET*	Button tip for three knuckle hinges only.....	N/C
*Exposed Tip	(ET standard on 5 knuckle)	





Tips - Hospital

<u>Symbol</u>	<u>Description</u>	<u>List</u>
HT*	Standard Weight and Heavy Weight Hinges	\$30.10
*Hospital Tip		

Tips - Decorator

Regular decorator tips are available on brass or steel hinges, three and five knuckle, for the type and size shown below. To order hinges with regular decorator tips, give the catalog number of the hinge, the size, the finish and the tip style.

Regular Decorator Tips:
 For example: BB1199 – 5" x 5" US3 Ball Tip
 BB1279 – 4-1/2" x 4-1/2" US10A Steeple Tip
 AB700 – 4-1/2" x 4-1/2" US3 Ball Tip

REGULAR DECORATOR TIPS (Supplied with all wood screws unless otherwise specified)			LIST
Acorn Tip		Standard Weight - 3-1/2", 4", 4-1/2", 5", and 6" Heavy Weight - 4-1/2", 5", 6", and 8"	\$46.95 \$46.95
Ball Tip		Standard Weight - 3", 3-1/2", 4", 4-1/2", 5", and 6" Heavy Weight - 4-1/2", 5", 6", and 8"	\$29.40 \$29.40
Steeple Tip		Standard Weight - 3", 3-1/2", 4", 4-1/2", 5", and 6" Heavy Weight - 4-1/2", 5", 6", and 8"	\$29.40 \$29.40
Urn Tip		Standard Weight - 3-1/2", 4", 4-1/2", 5", and 6" Heavy Weight - 4-1/2", 5", 6", and 8"	\$46.95 \$46.95









Note: Certain hinge additions/modifications may not be applicable. Please contact Hager Companies Customer Service before ordering.

Commercial Hinges



Description	Finish	2018 List	Stock No.	Box Qty.	Case Qty.	
100 Set Screw Set	PS	360.05	001076		10	
252 Full Surface Reinforcing Pivot for 4" (102 mm) wide hinges, non-handed.	LH US2C	188.30	001121		10	
	RH US2C	188.30	001122			
253 Full Surface Reinforcing Pivot for 4-1/2" (114 mm) wide hinges, non-handed.	US2C	188.30	121571	1		
263 Thru Bolts for reinforcing 1-3/4" (45 mm) doors. Pack of 100	US2C	257.05	001141	1 pack		
265 Molly Jack Nuts (8S JN) for Reinforcing Pivot Pack of 100	US2C	137.00	001143	1 pack of 100		
305 Hinge Reinforcement Plate	PS	8.55	001153		50	
417 Back Plate for Wood Doors Half Surface Hinges or Full Surface Hinges	4-5/8" (117 mm)	USP	30.95	001195	10	100
		US10	30.95	001187		
		US26D	30.95	001190		
	5" (127 mm)	USP	32.85	001203	10	100
	US10	32.85	078619			
	US26D	32.85	001199			
430 Mortar Box	H2H	62.65	001206	1		
451 Double Lipped Strike Center Hung <i>*Other sizes available</i>	US26D	198.10	001208	1		
452 Double Lipped Strike Center Hung <i>*Other sizes available</i>	US26D	198.10	001209	1		
453 Double Lipped Strike 1/8" Inset <i>*Other sizes available</i>	US26D	198.10	001210	1		

1. Items with the price in **bold and red** are Quick Ship items and ship in 24 hours. Please use stock number when ordering. 2. U/M is each unless otherwise noted.

	Description	Finish	2018 List	Stock No.	Box Qty.	Case Qty.
	454 Double Lipped Strike 1/8" Inset <i>*Other sizes available</i>	US26D	198.10	001211	1	
	455 Center Hung Combination Rescue Door Stop and Two Way Strike Plates Specify Handing <i>*Other sizes available</i>	LH US26D RH US26D	566.15 566.15	001218 001219	1	
	456 Center Hung Combination Rescue Door Stop and Two Way Strike Plates Specify Handing <i>*Other sizes available</i>	LH US26D RH US26D	570.85 570.85	001222 001223	1	
	457 1/8" Inset Combination Rescue Door Stop and Two Way Strike Plates Specify Handing <i>*Other sizes available</i>	LH US26D RH US26D	566.15 566.15	001224 001225	1	
	458 1/8" Inset Combination Rescue Door Stop and Two Way Strike Plates Specify Handing <i>*Other sizes available</i>	LH US26D RH US26D	594.40 594.40	001226 001227	1	
	<i>*Other sizes available</i>		4-3/4" thru 8-3/4" greater than 8-3/4"	add \$80 to list of 6 3/4" size add \$125 to list of 6 3/4" size		
	495 Forged Bronze - Full Mortise Ball Bearing Adjustable Top Pivot Hinge	US26D	246.65	001236	1	
	496 Forged Bronze - Full Mortise Ball Bearing Adjustable Intermediate Pivot Hinge Specify Handing	LH US26D RH US26D	332.30 332.30	001250 001251	1	
	497 Forged Bronze - Full Mortise Ball Bearing Adjustable Bottom Pivot Hinge Specify Handing	LH US26D RH US26D	559.35 559.35	001265 001266	1	

1. Items with the price in **bold and red** are Quick Ship items and ship in 24 hours.
Please use stock number when ordering. 2. U/M is each unless otherwise noted.



Commercial Hinges



Description	Finish	2018 List	Stock No.	Box Qty.	Case Qty.
500 Brass - Full Mortise Standard Weight Rack and Pinion Pivot	US26D	519.00	001274		
510 Mortise Application - Hospital Set Wood Floor - Less Release	US26D	350.05	001278	1	10
511 Mortise Application - Hospital Set Masonry Floor - Less Release	US26D	417.45	001281	1	10
512 Surface Application - Hospital Set Masonry Floor - Less Release	US26D	417.45	001283	1	10
550 Brass - Full Mortise Heavy Weight Rack and Pinion Pivot	US26D	622.75	001288		
551 Brass - Full Mortise Extra Heavy Weight Rack and Pinion Pivot	US26D	683.75	113311		
610 Emergency Stop Release	US26D	268.90	001296	1	10



Description	Finish	2018 List	Stock No.	Box Qty.	Case Qty.
611 Mortise Application - Hospital Set Masonry Floor	US26D	691.95	001298	1	10
612 Surface Application - Hospital Set Masonry Floor	US26D	691.95	001301	1	10
615 Steel - Heavy Weight Pivot Set for Frameless Opening	US26D	148.15	042688	1	10
700 Steel - Full Mortise Standard Weight Plain Bearing Three Knuckle	3-1/2" x 3-1/2" (89 mm x 89 mm)	LS 11.90 USP 8.85 US3 17.75 US4 11.90 US10 11.90 US10A (US11) 17.75 US10B 17.75 US26 17.75 US26D 14.85	- 000926 001311 001312 001303 001304 069448 001308 001309	2	100
	4" x 4" (102 mm x 102 mm)	LS 14.05 USP 10.90 US3 20.10 US4 14.05 US10 14.05 US10A (US11) 20.10 US10B 20.10 US26 20.10 US26D 18.15	14.05 10.90 20.10 14.05 14.05 20.10 20.10 20.10 18.15	3	48
	4-1/2" x 4" (114 mm x 102 mm)	LS 13.40 USP 11.50 US3 23.00 US4 13.40 US10 13.40 US10A (US11) 23.00 US10B 23.00 US26 23.00 US26D 14.60	085393 001350 001343 001344 001328 001329 001332 001336 001340	3	48

1. Items with the price in **bold and red** are Quick Ship items and ship in 24 hours.
Please use stock number when ordering. 2. U/M is each unless otherwise noted.



Commercial Hinges



Description	Finish	2018 List	Stock No.	Box Qty.	Case Qty.	
700 - Cont. Continued	4-1/2" x 4-1/2" (114 mm x 114 mm)	LS	13.40	-	3	48
		USP	11.50	001390		
		US3	23.00	001372		
		US4	13.40	001376		
		US10	13.40	001352		
		US10A (US11)	23.00	001355		
		US10B	23.00	001360		
		US26	23.00	001364		
		US26D	14.60	001367		
	5" x 4" (127 mm x 102 mm)	LS	46.25	-	3	24
USP		38.05	001399			
US3		62.50	-			
US4		46.25	-			
US10		46.25	-			
US10A (US11)		62.50	-			
US10B		62.50	109332			
US26		62.50	-			
US26D		42.85	104223			
5" x 4-1/2" (127 mm x 114 mm)	LS	46.25	-	3	24	
	USP	38.05	067157			
	US3	62.50	-			
	US4	46.25	123152			
	US10	46.25	038706			
	US10A (US11)	62.50	-			
	US10B	62.50	-			
	US26	62.50	065399			
	US26D	42.85	001403			
5" x 5" (127 mm x 127 mm)	LS	46.25	-	3	24	
	USP	38.05	042507			
	US3	62.50	-			
	US4	46.25	-			
	US10	46.25	041251			
	US10A (US11)	62.50	115621			
	US10B	62.50	038084			
	US26	62.50	-			
	US26D	42.85	068632			





Description	Finish	2018 List	Stock No.	Box Qty.	Case Qty.	
AB700 Steel - Full Mortise Standard Weight Concealed Anti-Friction Bearing Three Knuckle	3-1/2" x 3-1/2" (89 mm x 89 mm)	LS	35.55	124088	2	100
		USP	31.10	045449		
		US3	43.00	044765		
		US4	31.10	016859		
		US10	35.55	029909		
		US10A (US11)	43.00	012038		
		US10B	43.00	033999		
		US26	43.00	053130		
		US26D	36.90	091472		
	<hr/>					
	4" x 4" (102 mm x 102 mm)	LS	35.55	-	3	48
		USP	31.10	001501		
		US3	43.00	001497		
US4		31.10	001499			
US10		35.55	098013			
US10A (US11)		43.00	068298			
US10B		43.00	034156			
US26		43.00	022969			
US26D		36.90	001495			
<hr/>						
4-1/2" x 4" (114 mm x 102 mm)	LS	29.65	085392	3	48	
	USP	20.90	001559			
	US3	35.80	001543			
	US4	29.65	095580			
	US10	29.65	001502			
	US10A (US11)	35.80	001507			
	US10B	35.80	001515			
	US26	35.80	001526			
	US26D	20.10	001533			
<hr/>						
4-1/2" x 4-1/2" (114 mm x 114 mm)	LS	29.65	122473	3	48	
	USP	20.90	001682			
	US3	35.80	001645			
	US4	29.65	001654			
	US10	29.65	001574			
	US10A (US11)	35.80	001585			
	US10B	35.80	001597			
	US26	35.80	001607			
	US26D	20.10	001620			
<hr/>						
5" x 4" (127 mm x 102 mm)	LS	57.90	-	3	24	
	USP	57.90	069644			
	US3	73.30	046335			
	US4	57.90	017201			
	US10	57.90	047777			
	US10A (US11)	73.30	033653			
	US10B	73.30	047266			
	US26	73.30	001706			
	US26D	56.65	001709			

1. Items with the price in **bold and red** are Quick Ship items and ship in 24 hours.
Please use stock number when ordering. 2. U/M is each unless otherwise noted.



Commercial Hinges



Description	Finish	2018 List	Stock No.	Box Qty.	Case Qty.		
AB700 - Cont. Continued	5" x 4-1/2" (127 mm x 114 mm)	LS	57.90	-	3	24	
		USP	57.90	001748			
		US3	73.30	001738			
		US4	57.90	091318			
		US10	57.90	098518			
		US10A (US11)	73.30	097200			
		US10B	73.30	028451			
		US26	73.30	019133			
		US26D	56.65	001727			
		5" x 5" (127 mm x 127 mm)	LS	57.90	-	3	24
		USP	57.90	001773			
		US3	73.30	020279			
		US4	57.90	017173			
		US10	57.90	001758			
	US10A (US11)	73.30	008276				
	US10B	73.30	048588				
	US26	73.30	016080				
	US26D	56.65	025276				
WTAB700 Wide Throw Hinge Steel - Full Mortise Standard Weight Concealed Anti-Friction Bearing Three Knuckle	4-1/2" x 5" (114 mm x 127 mm)	LS	111.60	-	3	24	
		USP	109.15	065577			
		US3	125.00	069940			
		US10	111.60	043251			
		US10A (US11)	125.00	030958			
		US10B	125.00	007941			
		US26	125.00	069304			
		US26D	116.95	001446			
		4-1/2" x 6" (114 mm x 152 mm)	LS	111.60	-	3	24
		USP	109.15	023667			
		US3	125.00	026730			
		US10	111.60	065978			
		US10A (US11)	125.00	065835			
		US10B	125.00	075797			
	US26	125.00	062172				
	US26D	116.95	001458				
	4-1/2" x 7" (114 mm x 178 mm)	LS	120.35	-	3	24	
	USP	120.35	032001				
	US3	137.25	011172				
	US10	122.65	091490				
	US10A (US11)	137.25	047357				
	US10B	137.25	104122				
	US26	137.25	001467				
	US26D	128.55	039039				
	4-1/2" x 8" (114 mm x 203 mm)	LS	120.35	-	3	24	
	USP	120.35	046359				
	US3	137.25	011806				
	US10	122.65	-				
	US10A (US11)	137.25	063050				
	US10B	137.25	104121				
	US26	137.25	081758				
	US26D	128.55	001469				





Description	Finish	2018 List	Stock No.	Box Qty.	Case Qty.
WTAB700					
Wide Throw Hinge	LS	159.90	-	3	24
Steel - Full Mortise	USP	152.20	110219		
Standard Weight	US3	190.25	054746		
Concealed Anti-Friction Bearing	US10	159.90	077240		
Three Knuckle	US10A (US11)	190.25	-		
	US10B	190.25	030049		
	US26	190.25	-		
	US26D	175.05	047936		
<hr/>					
5" x 6"	LS	159.90	-	3	24
(127 mm x 152 mm)	USP	152.20	134948		
	US3	190.25	-		
	US10	159.90	-		
	US10A (US11)	190.25	044063		
	US10B	190.25	045970		
	US26	190.25	-		
	US26D	175.05	088534		
<hr/>					
5" x 7"	LS	159.90	-	3	24
(127 mm x 178 mm)	USP	152.20	134948		
	US3	190.25	-		
	US10	159.90	-		
	US10A (US11)	190.25	044063		
	US10B	190.25	045970		
	US26	190.25	-		
	US26D	175.05	088534		
<hr/>					
5" x 8"	LS	159.90	-	3	24
(127 mm x 203 mm)	USP	152.20	-		
	US3	190.25	-		
	US10	159.90	-		
	US10A (US11)	190.25	085769		
	US10B	190.25	104124		
	US26	190.25	-		
	US26D	175.05	040817		

1. Items with the price in **bold and red** are Quick Ship items and ship in 24 hours.
Please use stock number when ordering. 2. U/M is each unless otherwise noted.



Commercial Hinges



Description	Finish	2018 List	Stock No.	Box Qty.	Case Qty.	
AB750 Steel - Full Mortise Heavy Weight Concealed Anti-Friction Bearing Three Knuckle	4-1/2" x 4" (114 mm x 102 mm)	LS	64.95	-	3	24
		USP	64.95	096935		
		US3	77.05	073827		
		US4	64.95	071658		
		US10	64.95	001909		
		US10A (US11)	77.05	001911		
		US10B	77.05	065832		
		US26	77.05	001914		
		US26D	55.55	092641		
	4-1/2" x 4-1/2" (114 mm x 114 mm)	LS	64.95	114475	3	24
USP		64.95	002006			
US3		77.05	001982			
US4		64.95	001987			
US10		64.95	001936			
US10A (US11)		77.05	001944			
US10B		77.05	001956			
US26		77.05	001965			
US26D		55.55	001970			
5" x 4-1/2" (127 mm x 114 mm)		LS	83.50	-	3	24
	USP	83.50	002093			
	US3	86.95	002078			
	US4	83.50	002081			
	US10	83.50	092589			
	US10A (US11)	86.95	002044			
	US10B	86.95	002055			
	US26	86.95	016351			
	US26D	71.60	002064			
	5" x 5" (127 mm x 127 mm)	LS	83.50	-	3	24
USP		83.50	023577			
US3		86.95	030368			
US4		83.50	002131			
US10		83.50	002109			
US10A (US11)		86.95	002113			
US10B		86.95	017886			
US26		86.95	006052			
US26D		71.60	002125			





Description	Finish	2018 List	Stock No.	Box Qty.	Case Qty.
WTAB750	LS	161.30	-	3	24
Wide Throw	USP	174.90	115754		
Steel - Full Mortise	US3	196.60	-		
Heavy Weight	US10	161.30	065696		
Concealed Anti-Friction Bearing	US10A (US11)	196.60	093406		
Three Knuckle	US10B	196.60	076857		
	US26	196.60	092976		
	US26D	162.30	022959		
<hr/>					
4-1/2" x 5"	LS	162.05	-	3	24
(114 x 127 mm)	USP	175.65	063855		
	US3	197.60	043920		
	US10	162.05	045850		
	US10A (US11)	197.60	090251		
	US10B	197.60	086471		
	US26	197.60	089046		
	US26D	169.60	097881		

1. Items with the price in **bold and red** are Quick Ship items and ship in 24 hours.
Please use stock number when ordering. 2. U/M is each unless otherwise noted.



Commercial Hinges



Description		Finish	2018 List	Stock No.	Box Qty.	Case Qty.
IHTAB750	4-1/2" x 4-1/2"	LS	115.25	082386	3	24
MADE IN USA	(114 mm x 114 mm)	USP	136.10	081222		
Steel - Full Mortise		US26D	120.70	081223		
Concealed Anti-Friction Bearing	5" x 4-1/2"	LS	126.10	-	3	24
Heavy Weight	(127 x 114 mm)	USP	144.65	005416		
Institutional or Prison; Welded Hospital Tip Three Knuckle		US26D	132.30	089127		
TORX Screws - add \$12 to list						





Description	Finish	2018 List	Stock No.	Box Qty.	Case Qty.	
300 Brass or Stainless Full Mortise Standard Weight Plain Bearing Three Knuckle	3-1/2" x 3-1/2" (89 mm x 89 mm)	US3	86.50	002239	2	100
		US10	67.75	125628		
		US10B	86.50	002236		
		US26	86.50	018814		
		US26D	77.45	017876		
	US32D	81.70	002240			
4" x 4" (102 mm x 102 mm)		US3	83.55	002247	3	48
		US10	64.75	131214		
		US10B	83.35	013109		
		US26	83.35	032743		
		US26D	76.85	002246		
	US32D	88.60	002249			
4-1/2" x 4" (114 mm x 102 mm)		US3	74.80	024497	3	48
		US10	63.85	-		
		US10B	74.80	023835		
		US26	74.80	-		
		US26D	67.55	032689		
	US32D	76.45	071727			
4-1/2" x 4-1/2" (114 mm x 114 mm)		US3	74.80	002279	3	48
		US10	63.85	005530		
		US10B	74.80	002268		
		US26	74.80	002271		
		US26D	67.55	002274		
	US32D	76.45	002284			
5" x 4" (127 mm x 102 mm)		US3	118.05	-	3	24
		US10	94.25	-		
		US10B	118.05	061899		
		US26	118.05	-		
		US26D	104.90	092717		
	US32D	119.45	097552			
5" x 4-1/2" (127 x 114 mm)		US3	118.05	019910	3	24
		US10	94.25	-		
		US10B	118.05	067358		
		US26	118.05	-		
		US26D	104.90	107933		
	US32D	119.45	006935			
5" x 5" (127 mm x 127 mm)		US3	118.05	016629	3	24
		US10	94.25	-		
		US10B	118.05	126436		
		US26	118.05	103826		
		US26D	104.90	085018		
	US32D	119.45	019417			

1. Items with the price in **bold and red** are Quick Ship items and ship in 24 hours.
Please use stock number when ordering. 2. U/M is each unless otherwise noted.



Commercial Hinges



Description	Finish	2018 List	Stock No.	Box Qty.	Case Qty.	
AB800 Brass or stainless Full Mortise Standard Weight Concealed Anti-Friction Bearing Three Knuckle	4-1/2" x 4" (114 mm x 102 mm)	US3	85.70	002371	3	48
		US10	71.25	002353		
		US10B	85.70	002354		
		US26	85.70	031110		
		US26D	72.80	002366		
		US32D	73.90	002379		
4-1/2" x 4-1/2" (114 mm x 114 mm)	US3	85.70	002430	3	48	
	US10	71.25	002390			
	US10B	85.70	002397			
	US26	85.70	095263			
	US26D	72.80	002416			
	US32D	73.90	002441			
5" x 4" (127 mm x 102 mm)	US3	141.05	138239	3	24	
	US10	109.85	014350			
	US10B	141.05	053030			
	US26	141.05	-			
	US26D	112.40	041703			
	US32D	115.60	002477			
5" x 4-1/2" (127 mm x 114 mm)	US3	141.05	-	3	24	
	US10	109.85	129221			
	US10B	141.05	037911			
	US26	141.05	-			
	US26D	112.40	096274			
	US32D	115.60	002500			
5" x 5" (127 mm x 127 mm)	US3	141.05	032238	3	24	
	US10	109.85	129222			
	US10B	141.05	021424			
	US26	141.05	065762			
	US26D	112.40	009938			
	US32D	115.60	095163			





Description	Finish	2018 List	Stock No.	Box Qty.	Case Qty.
WTAB800					
4-1/2" x 5"	LS	163.55	-	3	24
Wide Throw (114 mm x 127 mm)	US3	228.60	051926		
Brass or Stainless	US10	163.55	074633		
Full Mortise	US10B	216.00	002306		
Standard Weight	US26	216.00	-		
Concealed Anti-Friction Bearing	US26D	185.50	081811		
Three Knuckle	US32	228.60	-		
	US32D	228.60	022382		
<hr/>					
4-1/2" x 6"	LS	179.20	-	3	24
(114 mm x 152 mm)	US3	233.40	016264		
	US10	179.20	144616		
	US10B	233.40	047131		
	US26	233.40	114753		
	US26D	185.05	015281		
	US32	245.70	065657		
	US32D	245.70	078170		
<hr/>					
4-1/2" x 7"	LS	188.25	-	3	24
(114 mm x 178 mm)	US3	245.20	121348		
	US10	188.25	-		
	US10B	245.20	021385		
	US26	245.20	-		
	US26D	222.05	121347		
	US32	258.05	-		
	US32D	258.05	017222		
<hr/>					
4-1/2" x 8"	LS	190.55	-	3	24
(114 mm x 203 mm)	US3	245.45	117869		
	US10	190.55	-		
	US10B	245.45	115804		
	US26	245.45	143234		
	US26D	214.20	037781		
	US32	257.80	143233		
	US32D	257.80	113887		
<hr/>					
5" x 6"	LS	347.55	-	3	24
(127 mm x 152 mm)	US3	455.15	-		
	US10	347.55	-		
	US10B	455.15	043722		
	US26	455.15	-		
	US26D	402.20	122338		
	US32	483.10	-		
	US32D	483.10	045622		
<hr/>					
5" x 7"	LS	364.90	-	3	24
(127 mm x 178 mm)	US3	478.05	-		
	US10	364.90	140083		
	US10B	478.05	-		
	US26	478.05	-		
	US26D	414.55	-		
	US32	506.55	140555		
	US32D	506.55	140540		

1. Items with the price in **bold and red** are Quick Ship items and ship in 24 hours.
Please use stock number when ordering. 2. U/M is each unless otherwise noted.



Commercial Hinges



Description	Finish	2018 List	Stock No.	Box Qty.	Case Qty.
WTAB800 - Cont. Continued	5" x 8" (127 mm x 203 mm)	LS	402.95	-	3 24
		US3	497.55	-	
		US10	402.95	-	
		US10B	497.55	-	
		US26	497.55	-	
		US26D	434.70	-	
		US32	519.40	-	
	US32D	519.40	088291		
AB850 Brass or Stainless Full Mortise Heavy Weight Concealed Anti-Friction Bearing Three Knuckle	4-1/2" x 4" (114 mm x 102 mm)	US3	132.30	046338	3 24
		US10	122.05	045488	
		US10B	132.30	001714	
		US26	132.30	-	
		US26D	104.80	002599	
		US32D	106.90	093039	
	4-1/2" x 4-1/2" (114 mm x 114 mm)	US3	132.30	098711	3 24
		US10	122.05	002615	
		US10B	132.30	094812	
		US26	132.30	002631	
		US26D	104.80	002638	
		US32D	106.90	002654	
	5" x 4" (127 mm x 102 mm)	US3	168.85	-	3 24
		US10	142.15	014351	
		US10B	168.85	100720	
US26		168.85	081818		
US26D		142.20	057422		
	US32D	144.75	002683		
5" x 4-1/2" (127 mm x 114 mm)	US3	168.85	091548	3 24	
	US10	142.15	008334		
	US10B	168.85	002691		
	US26	168.85	002700		
	US26D	142.20	002704		
	US32D	144.75	002721		
5" x 5" (127 mm x 127 mm)	US3	168.85	032239	3 24	
	US10	142.15	033916		
	US10B	168.85	095231		
	US26	168.85	112488		
	US26D	142.20	002743		
	US32D	144.75	024905		
6" x 4-1/2" (152 mm x 114 mm)	US3	393.00	124252	3 24	
	US10	255.30	025004		
	US10B	393.00	043245		
	US26	393.00	-		
	US26D	277.10	074191		
	US32D	374.85	002758		





Description	Finish	2018 List	Stock No.	Box Qty.	Case Qty.
AB850 - Cont. Continued	6" x 5" (152 mm x 127 mm)	US3 393.00	-	3	24
		US10 255.30	-		
		US10B 393.00	034166		
		US26 393.00	-		
		US26D 277.10	022892		
		US32D 374.85	001925		
	6" x 6" (152 mm x 152 mm)	US26D 277.10	026100	3	24
		US32D 374.85	002771		
WTAB850 Wide Throw Brass or Stainless Full Mortise Heavy Weight Concealed Anti-Friction Bearing Three Knuckle	4-1/2" x 5" (114 mm x 127 mm)	LS 244.95	-	3	24
		US3 310.35	119032		
		US10 244.95	089830		
		US10B 310.35	041693		
		US26 310.35	-		
		US26D 269.10	014202		
		US32 332.85	-		
		US32D 332.85	073360		
	4-1/2" x 6" (114 mm x 152 mm)	LS 253.40	-	3	24
		US3 319.45	119033		
US10 253.40		-			
US10B 319.45		030057			
US26 319.45		-			
US26D 287.15		004168			
US32 341.80		-			
	US32D 341.80	024258			
4-1/2" x 7" (114 mm x 178 mm)	LS 280.70	-	3	24	
	US3 337.35	146198			
	US10 280.70	-			
	US10B 337.35	062830			
	US26 337.35	-			
	US26D 323.90	147246			
	US32 364.35	-			
	US32D 364.35	017221			



1. Items with the price in **bold and red** are Quick Ship items and ship in 24 hours.
Please use stock number when ordering. 2. U/M is each unless otherwise noted.



Commercial Hinges



Description	Finish	2018 List	Stock No.	Box Qty.	Case Qty.
WTAB850 - Cont. Continued	4-1/2" x 8" (114 mm x 203 mm)	LS	310.40	-	3 24
		US3	364.35	-	
		US10	310.40	126847	
		US10B	364.35	113225	
		US26	364.35	-	
		US26D	337.35	025417	
		US32	394.05	-	
		US32D	394.05	035073	
5" x 6" (127 mm x 152 mm)	LS	323.90	-	3 24	
	US3	377.85	095930		
	US10	323.90	-		
	US10B	377.85	011469		
	US26	377.85	-		
	US26D	348.20	-		
	US32	421.05	099689		
	US32D	421.05	045352		
5" x 7" (127 mm x 178 mm)	LS	323.90	-	3 24	
	US3	391.40	-		
	US10	323.90	-		
	US10B	391.40	104539		
	US26	391.40	-		
	US26D	350.80	-		
	US32	426.45	-		
	US32D	426.45	081554		
5" x 8" (127 mm x 203 mm)	LS	348.20	-	3 24	
	US3	407.55	106302		
	US10	348.20	-		
	US10B	407.55	019906		
	US26	407.55	-		
	US26D	364.35	-		
	US32	445.30	-		
	US32D	445.30	015599		
IHTAB850 MADE IN USA Stainless - Full Mortise Heavy Weight Concealed Anti-Friction Bearing Institutional or Prison Welded Hospital Tip Three Knuckle TORX Screws - add \$16.50 to list	4-1/2" x 4-1/2" (114 x 114 mm)	US32D	194.20	079272	3 24
	5" x 4-1/2" (127 mm x 114 mm)	US32D	245.25	095240	3 24





Description	Finish	2018 List	Stock No.	Box Qty.	Case Qty.		
920 Steel Full Mortise Standard Weight Plain Bearing Two Knuckle Specify Handing	4-1/2" x 4" (114 mm x 102 mm)	LH USP	11.75	002850	3	48	
		RH USP	11.75	002851			
		LH US10	16.25	002828			
		RH US10	16.25	002830			
		LH US10A (US11)	31.50	074625			
		RH US10A (US11)	31.50	002833			
		LH US10B	31.50	073260			
		RH US10B	31.50	073258			
		LH US26D	22.55	002836			
		RH US26D	22.55	002837			
		4-1/2" x 4-1/2" (114 mm x 114 mm)	LH USP	13.00	002888	3	48
			RH USP	13.00	002889		
			LH US10	16.25	002852		
			RH US10	16.25	002853		
		LH US10A (US11)	31.50	002854			
		RH US10A (US11)	31.50	002856			
		LHUS10B	31.50	002858			
		RH US10B	31.50	002859			
		LH US26D	23.00	002867			
		RH US26D	23.00	002869			
AB920 Steel Full Mortise Standard Weight Concealed Anti-Friction Bearing Two Knuckle Specify Handing	4-1/2" x 4" (114 mm x 102 mm)	LH USP	32.45	002914	3	48	
		RH USP	32.45	002915			
		LH US10	28.20	002890			
		RH US10	28.20	002892			
		LH US10A (US11)	44.10	002894			
		RH US10A (US11)	44.10	002895			
		LHUS10B	44.10	017887			
		RH US10B	44.10	017888			
		LH US26D	36.85	002900			
		RH US26D	36.85	002901			
	Available with ETW	4-1/2" x 4-1/2" (114 mm x 114 mm)	LH USP	32.45	002958	3	48
			RH USP	32.45	002963		
			LH US10	28.20	002918		
			RH US10	28.20	002919		
		LH US10A (US11)	44.10	002921			
		RH US10A (US11)	44.10	002924			
		LHUS10B	44.10	002926			
		RH US10B	44.10	002927			
		LH US26D	36.85	002936			
		RH US26D	36.85	002937			



1. Items with the price in **bold and red** are Quick Ship items and ship in 24 hours.
Please use stock number when ordering. 2. U/M is each unless otherwise noted.



Commercial Hinges



Description		Finish	2018 List	Stock No.	Box Qty.	Case Qty.
AB923	4-1/2" x 4"	LH US3	92.15	037373	3	48
Brass or Stainless	(114 mm x 102 mm)	RH US3	92.15	037374		
Full Mortise		LH US4	72.20	017474		
Standard Weight		RH US4	72.20	-		
Concealed Anti-Friction Bearing		LH US10	72.20	053643		
Two Knuckle		RH US10	72.20	053640		
Specify Handing		LH US10B	92.15	064730		
		RH US10B	92.15	064731		
		LH US26	92.15	048404		
Available with ETW		RH US26	92.15	048405		
		LH US26D	81.90	057100		
		RH US26D	81.90	057102		
		LH US32	107.35	039538		
		RH US32	107.35	085667		
		LH US32D	107.35	040225		
		RH US32D	107.35	031930		
	4-1/2" x 4-1/2"	LH US3	92.15	048410	3	48
	(114 mm x 114 mm)	RH US3	92.15	048411		
		LH US4	72.20	063272		
		RH US4	72.20	050767		
		LH US10	72.20	041925		
		RH US10	72.20	041924		
		LH US10B	92.15	027478		
		RH US10B	92.15	027479		
		LH US26	92.15	020180		
		RH US26	92.15	035847		
		LH US26D	81.90	039586		
		RH US26D	81.90	027480		
		LH US32	107.35	030201		
		RH US32	107.35	030202		
		LH US32D	107.35	021425		
		RH US32D	107.35	021427		





Description	Finish	2018 List	Stock No.	Box Qty.	Case Qty.	
IHTHB953 Stainless Steel Full Mortise Heavy Weight Concealed Bearing Institutional or Prison Welded Hospital Tip Standard with RSS and Torx Screws	US32D	128.45	051344	3	24	
990 Steel Detention Utility Hinge Full Surface Welded Tip	USP	171.45	079393	2	10	
992 Steel Detention Food Pass Through Hinge Full Surface With Stop Welded Tip Set of 2 hinges with 2 stops	USP	367.00	079398	1	12	
BB1109 Brass or Stainless Half Mortise Standard Weight Ball Bearing	4-1/2" (114 mm)	US10	145.85	004145	3	48
		US10B	179.65	085217		
		US26D	156.20	004149		
		US32D	207.90	004154		
	5" (127 mm)	US10	187.80	045318	3	24
	US10B	210.95	-			
	US26D	183.45	004165			
	US32D	248.85	004170			
1129 Steel Half Mortise Standard Weight Plain Bearing	4-1/2" (114 mm)	USP	27.20	004186	3	48
		US10B	46.65	065372		
		US26D	35.60	004180		

1. Items with the price in **bold and red** are Quick Ship items and ship in 24 hours.
Please use stock number when ordering. 2. U/M is each unless otherwise noted.



Commercial Hinges



Description		Finish	2018 List	Stock No.	Box Qty.	Case Qty.
BB1129	4-1/2" (114 mm)	USP	70.25	004209	3	48
Steel		US10	74.75	004188		
Half Mortise		US10A (US11)	104.65	004190		
Standard Weight		US10B	104.65	004193		
Plain Bearing		US26D	82.65	004197		
	5" (127 mm)	USP	94.70	004223	3	24
		US10	110.00	004215		
		US10A (US11)	135.95	113352		
		US10B	135.95	015737		
		US26D	118.45	004218		



1150	4-1/2" x 4"	US32	150.05	047217	3	48
Stainless Steel	(114 mm x 102 mm)	US32D	129.00	023378		
Full Mortise		US10Z	169.05	177119	3	48
Standard Weight	4-1/2" x 4-1/2"	US32	150.05	028073	3	48
Spring Hinge	(114 mm x 114 mm)	US32D	129.00	023379		
		US10Z	169.05	177118	3	48

Note: Hager does not recommend using spring hinges on doors over 7'0"



Description	Finish	2018 List	Stock No.	Box Qty.	Case Qty.
-------------	--------	-----------	-----------	----------	-----------

PAGE DELIBERATELY LEFT BLANK



Commercial Hinges



Description	Finish	2018 List	Stock No.	Box Qty.	Case Qty.	
BB1168 Steel Full Mortise Heavy Weight Ball Bearing	4-1/2" x 4" (114 mm x 102 mm)	LS	56.45	-	3	24
		USP	56.45	004540		
		US3	67.00	004529		
		US10	56.45	004501		
		US10A (US11)	67.00	004505		
		US10B	67.00	004510		
		US15	67.00	084310		
		US26	67.00	004512		
		US26D	48.30	004517		
	4-1/2" x 4-1/2" (114 mm x 114 mm)	LS	56.45	004735	3	24
USP		56.45	004744			
US3		67.00	004671			
US10		56.45	004547			
US10A (US11)		67.00	004564			
US10B		67.00	004585			
US15		67.00	004592			
US26		67.00	004601			
US26D		48.30	004616			
5" x 4" (127 mm x 102 mm)		LS	72.60	-	3	24
	USP	71.55	004794			
	US3	75.60	010504			
	US10	72.60	071777			
	US10A (US11)	75.60	004779			
	US10B	75.60	059153			
	US15	75.60	035760			
	US26	75.60	047535			
	US26D	62.25	004785			
	5" x 4-1/2" (127 mm x 114 mm)	LS	72.60	128700	3	24
USP		71.55	004922			
US3		75.60	004881			
US10		72.60	004802			
US10A (US11)		75.60	004813			
US10B		75.60	004826			
US15		75.60	004830			
US26		75.60	004836			
US26D		62.25	004850			





Description	Finish	2018 List	Stock No.	Box Qty.	Case Qty.	
BB1168 - Cont. Continued	5" x 5" (127 mm x 127 mm)	LS	72.60	-	3	24
		USP	71.55	005029		
		US3	75.60	004998		
		US10	72.60	004947		
		US10A (US11)	75.60	004956		
		US10B	75.60	004974		
		US15	75.60	022614		
		US26	75.60	004975		
		US26D	62.25	004981		
6" x 4-1/2" (152 mm x 114 mm)	LS	201.00	-	3	12	
	USP	194.50	005069			
	US3	247.85	005064			
	US10	201.00	035454			
	US10A (US11)	247.85	057799			
	US10B	247.95	068270			
	US15	247.85	033562			
	US26	247.95	005054			
	US26D	186.95	005057			
6" x 5" (152 mm x 127 mm)	USP	194.50	005102	3	12	
	US10	201.00	007229			
	US10A (US11)	247.85	020131			
	US10B	247.95	078457			
	US15	247.85	030967			
	US26D	186.95	005086			
6" x 6" (152 mm x 152 mm)	USP	194.50	005128	3	12	
	US10	201.00	030639			
	US10A (US11)	247.85	011627			
	US10B	247.95	065303			
	US15	247.85	016874			
	US26D	186.95	005113			
8" x 6" (203 mm x 152 mm)	USP	449.15	005145	3	12	
	US10	464.25	026481			
	US10A (US11)	572.45	047621			
	US10B	572.45	039286			
	US15	572.45	-			
	US26D	486.35	064840			
8" x 8" (203 mm x 203 mm)	USP	449.15	005158	3	12	
	US10	464.25	079431			
	US10A (US11)	572.45	005148			
	US10B	572.45	017141			
	US15	572.45	-			
	US26D	486.35	005151			

1. Items with the price in **bold and red** are Quick Ship items and ship in 24 hours.
Please use stock number when ordering. 2. U/M is each unless otherwise noted.



Commercial Hinges



Description	Finish	2018 List	Stock No.	Box Qty.	Case Qty.
WTBB1168					
Wide Throw	LS	131.50	-	3	24
Steel	USP	142.55	097956		
Full Mortise	US3	160.35	004408		
Heavy Weight	US10	131.50	012221		
Ball Bearing	US10A (US11)	160.35	004403		
	US10B	160.35	007916		
	US26	160.35	015160		
	US26D	135.65	092594		
<hr/>					
4-1/2" x 5"	LS	132.10	-	3	24
(114 mm x 127 mm)	USP	143.30	004427		
	US3	161.20	004422		
	US10	132.10	099482		
	US10A (US11)	161.20	098167		
	US10B	161.20	004417		
	US26	161.20	004419		
	US26D	138.30	004420		
<hr/>					
4-1/2" x 7"	LS	174.45	-	3	24
(114 mm x 178 mm)	USP	189.25	040653		
	US3	212.80	015930		
	US10	174.45	003123		
	US10A (US11)	212.80	010920		
	US10B	212.80	058190		
	US26	212.80	050632		
	US26D	182.65	004435		
<hr/>					
4-1/2" x 8"	LS	182.05	-	3	24
(114 mm x 203 mm)	USP	197.45	004450		
	US3	222.10	078934		
	US10	182.05	045774		
	US10A (US11)	222.10	019132		
	US10B	222.10	062081		
	US26	222.10	066672		
	US26D	190.60	004446		
<hr/>					
5" x 6"	LS	177.70	-	3	24
(127 mm x 152 mm)	USP	192.50	008259		
	US3	215.55	004463		
	US10	177.70	020214		
	US10A (US11)	215.55	031197		
	US10B	215.55	019659		
	US26	215.55	004459		
	US26D	184.20	004461		





Description	Finish	2018 List	Stock No.	Box Qty.	Case Qty.	
WTBB1168 - Cont. Continued	5" x 7" (127 mm x 203 mm)	LS	180.30	-	3 24	
		USP	195.40	066742		
		US3	218.55	067657		
		US10	180.30	023928		
		US10A (US11)	218.55	020805		
		US10B	218.55	073756		
		US26	218.55	143181		
		US26D	186.90	004475		
		5" x 8" (127 mm x 203 mm)	LS	188.05	-	3 24
		USP	203.80	004495		
	US3	228.15	008357			
	US10	188.05	034739			
	US10A (US11)	228.15	015855			
	US10B	228.15	026651			
	US26	228.15	057245			
	US26D	194.90	098271			
1173 Steel Half Surface Standard Weight Plain Bearing	3-1/2" (89 mm)	USP	38.90	005304	3 48	
		US10	43.35	005292		
		US10A (US11)	51.70	005293		
		US10B	51.70	024439		
		US26D	45.50	005295		
	4" (102 mm)	USP	59.55	005319	3 48	
		US10	62.65	005306		
		US10A (US11)	73.90	046712		
		US10B	73.90	044390		
		US26D	64.45	005309		
4-1/2" (114 mm)	USP	40.05	005337	3 48		
	US10	42.90	005321			
	US10A (US11)	58.90	005323			
	US10B	58.90	001848			
	US26D	45.25	005326			
	BB1173 Steel Half Surface Standard Weight Ball Bearing	4" (102 mm)	USP	75.95	005356	3 48
		US10	91.10	005349		
		US10A (US11)	114.35	001845		
		US10B	114.35	091863		
		US26D	99.85	005351		
4-1/2" (114 mm)		USP	61.20	005389	3 48	
	US10	68.40	005358			
	US10A (US11)	95.35	005360			
	US10B	95.35	005364			
	US26D	71.70	005367			
5" (127 mm)	USP	86.50	005410	3 36		
	US10	105.75	005395			
	US10A (US11)	130.65	005397			
	US10B	130.65	015735			
	US26D	97.35	005401			



1. Items with the price in **bold and red** are Quick Ship items and ship in 24 hours.
Please use stock number when ordering. 2. U/M is each unless otherwise noted.



Commercial Hinges



Description	Finish	2018 List	Stock No.	Box Qty.	Case Qty.	
1191 Brass or Stainless Full Mortise Standard Weight Plain Bearing Specify if all wood screws are required.	3" x 3" (76 mm x 76 mm)	US3	174.65	005484	2	100
		US4	137.00	005496		
		US10	137.00	065549		
		US10B	174.65	005475		
		US15	174.65	005478		
		US26	174.65	005479		
		US26D	154.75	005481		
		US32	194.25	005490		
		US32D	192.05	005491		
	3-1/2" x 3-1/2" (89 mm x 89 mm)	US3	72.10	006934		
US4		56.45	006952			
US10		56.45	006911			
US10B		72.10	006913			
US15		72.10	006920			
US26		72.10	006923			
US26D		64.55	006929			
US32		72.25	006943			
US32D		68.10	006945			
4" x 3-1/2" (102 mm x 89 mm)	US3	90.15	097274	3	48	
	US4	68.85	005502			
	US10	68.85	121560			
	US10B	90.15	069063			
	US15	90.15	035011			
	US26	90.15	011778			
	US26D	78.60	029852			
	US32	88.75	132157			
4" x 4" (102 mm x 102 mm)	US3	69.40	005535	3	48	
	US4	53.95	005562			
	US10	53.95	005503			
	US10B	69.40	005508			
	US15	69.40	052318			
	US26	69.40	005522			
	US26D	64.05	005528			
	US32	73.80	005549			
US32D	41.35	005552				





Description	Finish	2018 List	Stock No.	Box Qty.	Case Qty.
1191 - Cont. Continued	4-1/2" x 4" (114 mm x 102 mm)	US3	70.50	005597	3 48
		US4	55.50	005620	
		US10	55.50	052272	
		US10B	70.50	005582	
		US15	70.50	005586	
		US26	70.50	005590	
		US26D	58.90	005592	
		US32	71.00	005611	
		US32D	66.00	005614	
4-1/2" x 4-1/2" (114 mm x 114 mm)	US3	70.50	005690	3 48	
	US4	55.50	005724		
	US10	55.50	005629		
	US10B	70.50	005640		
	US15	70.50	005652		
	US26	70.50	005664		
	US26D	58.90	005673		
	US32	71.00	005709		
	US32D	66.00	005713		
5" x 4" (127 mm x 102 mm)	US3	98.40	005752	3 24	
	US4	78.55	110512		
	US10	78.55	-		
	US10B	98.40	012964		
	US15	98.40	047207		
	US26	98.40	043361		
	US26D	87.40	033877		
	US32	109.45	046989		
	US32D	99.60	005755		
5" x 4-1/2" (127 mm x 114 mm)	US3	98.40	005771	3 24	
	US4	78.55	005783		
	US10	78.55	105329		
	US10B	98.40	005763		
	US15	98.40	032825		
	US26	98.40	128711		
	US26D	87.40	005768		
	US32	109.45	125488		
	US32D	99.60	005779		
5" x 5" (127 mm x 127 mm)	US3	98.40	005803	3 24	
	US4	78.55	027281		
	US10	78.55	128170		
	US10B	98.40	005791		
	US15	98.40	030280		
	US26	98.40	005799		
	US26D	87.40	005800		
	US32	109.45	009578		
	US32D	99.60	005815		

1. Items with the price in **bold and red** are Quick Ship items and ship in 24 hours.
Please use stock number when ordering. 2. U/M is each unless otherwise noted.



Commercial Hinges



Description	Finish	2018 List	Stock No.	Box Qty.	Case Qty.	
BB1191 Brass or Stainless Full Mortise Standard Weight Ball Bearing Specify if all wood screws are required.	3-1/2" x 3-1/2" (89 mm x 89 mm)	US3	85.55	007012	2	100
		US4	79.70	007026		
		US10	79.70	006997		
		US10B	85.55	007000		
		US15	85.55	039663		
		US26	85.55	007006		
		US26D	83.75	007008		
		US32	118.35	007020		
		US32D	104.60	007021		
	4" x 3-1/2" (102 mm x 89 mm)	US3	129.55	080659	3	48
		US4	99.35	-		
		US10	99.35	-		
		US10B	129.55	091160		
	US15	129.55	095215			
	US26	129.55	-			
	US26D	124.95	072201			
	US32	156.65	085839			
	US32D	130.00	006219			
4" x 4" (102 mm x 102 mm)	US3	98.80	006246	3	48	
	US4	86.70	006269			
	US10	86.70	006221			
	US10B	98.80	006225			
	US15	98.80	006232			
	US26	98.80	006235			
	US26D	92.75	006240			
	US32	116.95	006261			
	US32D	112.90	006263			
4-1/2" x 4" (114 mm x 102 mm)	US3	84.20	006321	3	48	
	US4	64.80	006343			
	US10	64.80	006286			
	US10B	84.20	006289			
	US15	84.20	006302			
	US26	84.20	006306			
	US26D	65.65	006311			
	US32	78.65	006332			
	US32D	66.65	006335			





Description	Finish	2018 List	Stock No.	Box Qty.	Case Qty.	
BB1191 - Cont. Continued	4-1/2" x 4-1/2" (114 mm x 114 mm)	US3	84.20	006489	3	48
		US4	64.80	006562		
		US10	64.80	006373		
		US10B	84.20	006393		
		US15	84.20	006426		
		US26	84.20	006446		
		US26D	65.65	006462		
		US32	78.65	006528		
		US32D	66.65	006537		
	5" x 4" (127 mm x 102 mm)	US3	115.15	006630		
US4		89.70	069057			
US10		89.70	020761			
US10B		115.15	006621			
US15		115.15	043259			
US26		115.15	006623			
US26D		93.70	006627			
US32		112.90	047877			
5" x 4-1/2" (127 mm x 114 mm)	US3	115.15	006681	3	24	
	US4	89.70	006707			
	US10	89.70	006644			
	US10B	115.15	006655			
	US15	115.15	006665			
	US26	115.15	065277			
	US26D	93.70	006672			
	US32	112.90	006693			
5" x 5" (127 mm x 127 mm)	US3	115.15	006761	3	24	
	US4	89.70	006791			
	US10	89.70	006727			
	US10B	115.15	006733			
	US15	115.15	068939			
	US26	115.15	006746			
	US26D	93.70	006752			
	US32	112.90	006779			
	US32D	95.80	006784			

1. Items with the price in **bold and red** are Quick Ship items and ship in 24 hours.
Please use stock number when ordering. 2. U/M is each unless otherwise noted.



Commercial Hinges



Description		Finish	2018 List	Stock No.	Box Qty.	Case Qty.
BB1191 - Cont. 2	6" x 4-1/2"	US3	360.45	006813	3	24
Continued	(152 mm x 114 mm)	US4	283.25	030956		
		US10	283.25	010566		
		US10B	360.45	007519		
		US15	360.45	-		
		US26	360.45	099318		
		US26D	324.15	006811		
		US32	394.00	084160		
		US32D	394.00	006817		
	6" x 5"	US3	360.45	006830	3	24
	(152 mm x 127 mm)	US4	283.25	081058		
		US10	283.25	031360		
		US10B	360.45	069067		
		US15	360.45	117950		
		US26	360.45	-		
		US26D	324.15	019124		
		US32	394.00	-		
		US32D	394.00	006832		
	6" x 6"	US3	360.45	006843	3	24
	(152 mm x 152 mm)	US4	283.25	046772		
		US10	283.25	012558		
		US10B	360.45	006838		
		US15	360.45	070946		
		US26	360.45	147729		
		US26D	324.15	006842		
		US32	394.00	106911		
		US32D	394.00	006850		





Description	Finish	2018 List	Stock No.	Box Qty.	Case Qty.	
WTBB1191 Wide Throw Brass or Stainless Full Mortise Standard Weight Ball Bearing	3-1/2" x 5" (89 mm x 127 mm)	US3	154.10	067005	3	24
		US4	119.80	026605		
		US10	119.80	121849		
		US10B	154.10	075305		
		US26	154.10	129251		
		US26D	135.20	118052		
		US32	185.20	000080		
		US32D	185.20	032663		
	3-1/2" x 6" (89 mm x 152 mm)	US3	154.75	040163	3	24
		US4	124.10	-		
US10		124.10	-			
US10B		154.75	113815			
US26		154.75	-			
US26D		139.45	130243			
US32		192.20	138152			
4" x 5" (102 mm x 127 mm)	US3	193.45	010124	3	24	
	US4	152.30	037602			
	US10	152.30	086104			
	US10B	193.45	070966			
	US26	193.45	041818			
	US26D	170.20	038964			
	US32	207.85	-			
	US32D	207.85	075139			
4" x 6" (102 mm x 152 mm)	US3	201.10	006119	3	24	
	US4	159.00	012392			
	US10	159.00	146501			
	US10B	201.10	006117			
	US26	201.10	096937			
	US26D	176.60	009831			
	US32	215.20	114550			
	US32D	215.20	006121			

1. Items with the price in **bold and red** are Quick Ship items and ship in 24 hours.
Please use stock number when ordering. 2. U/M is each unless otherwise noted.



Commercial Hinges



Description	Finish	2018 List	Stock No.	Box Qty.	Case Qty.	
WTBB1191 - Cont. Continued	4" x 7"	US3	209.90	092349	3	24
	(102 mm x 178 mm)	US4	167.30	089839		
		US10	167.30	-		
		US10B	209.90	039719		
		US26	209.90	069207		
		US26D	183.90	088865		
		US32	224.10	099920		
		US32D	224.10	048155		
4-1/2" x 5"	(114 mm x 127 mm)	US3	172.80	094007	3	24
		US4	130.80	101381		
		US10	130.80	046401		
		US10B	172.80	025650		
		US26	172.80	001393		
		US26D	148.35	092728		
		US32	182.70	121467		
		US32D	182.70	006144		
4-1/2" x 6"	(114 mm x 152 mm)	US3	190.35	095253	3	24
		US4	146.15	036949		
		US10	146.15	024066		
		US10B	190.35	006152		
		US26	190.35	020291		
		US26D	172.55	065373		
		US32	200.35	052335		
		US32D	200.35	092901		
4-1/2" x 7"	(114 mm x 178 mm)	US3	185.20	080909	3	24
		US4	149.85	041505		
		US10	149.85	-		
		US10B	185.20	024545		
		US26	185.20	049886		
		US26D	173.60	069011		
		US32	205.90	076444		
		US32D	205.90	099811		
4-1/2" x 8"	(114 mm x 203 mm)	US3	200.30	072567	3	24
		US4	155.30	116184		
		US10	155.30	137974		
		US10B	200.30	034770		
		US26	200.30	060370		
		US26D	174.75	008143		
		US32	210.40	-		
		US32D	210.40	098630		
5" x 6"	(127 mm x 152 mm)	US3	371.15	006199	3	24
		US4	283.50	067616		
		US10	283.50	028304		
		US10B	371.15	046882		
		US26	371.15	-		
		US26D	328.25	033730		
		US32	394.20	046097		
		US32D	394.20	040909		





Description	Finish	2018 List	Stock No.	Box Qty.	Case Qty.	
WTBB1191 - Cont. 2 Continued	5" x 7" (127 mm x 178 mm)	US3	390.05	067159	3 24	
		US4	297.80	140565		
		US10	297.80	-		
		US10B	390.05	035145		
		US26	390.05	-		
		US26D	338.25	065278		
		US32	413.30	-		
		US32D	413.30	036859		
	5" x 8" (127 mm x 203 mm)	US3	406.15	074194	3 24	
		US4	328.80	-		
US10		328.80	038873			
US10B		406.15	020027			
US26		406.15	-			
US26D		354.70	025454			
US32		423.70	-			
US32D		423.70	072530			
BB1195 Brass or Stainless Full Mortise Heavy Weight Ball Bearing Anchor Hinge Specify Handing		5" x 4-1/2" (127 mm x 114 mm)	LH US10	369.30	037675	1 10
			RH US10	369.30	037676	
		LH US10B	441.50	079470		
		RH US10B	441.50	079471		
		LH US26D	414.65	065411		
		RH US26D	414.65	065412		
		LH US32D	476.35	062056		
		RH US32D	476.35	062057		
BB1196 Brass or Stainless Full Mortise Heavy Weight Ball Bearing Anchor Hinge for Beveled Edge Doors Specify Handing	5" x 4-1/2" (127 mm x 114 mm)	LH US10	369.30	085583	1 10	
		RH US10	369.30	085582		
		LH US10B	441.50	065640		
		RH US10B	441.50	065641		
		LH US26D	414.65	073416		
		RH US26D	414.65	073415		
		LH US32D	476.35	063230		
		RH US32D	476.35	063231		
BB1197 Brass or Stainless Full Mortise Heavy Weight Ball Bearing Anchor Hinge Beveled Edge Doors Specify Handing	5" x 4-1/2" (127 mm x 114 mm)	LH US10	369.30	003650	1 10	
		RH US10	369.30	088543		
		LH US10B	441.50	067686		
		RH US10B	441.50	067687		
		LH US26D	414.65	074907		
		RH US26D	414.65	074908		
		LH US32D	476.35	079648		
		RH US32D	476.35	079649		



1. Items with the price in **bold and red** are Quick Ship items and ship in 24 hours.
Please use stock number when ordering. 2. U/M is each unless otherwise noted.



Commercial Hinges



Description	Finish	2018 List	Stock No.	Box Qty.	Case Qty.	
BB1199 Brass or Stainless Full Mortise Heavy Weight Ball Bearing	4-1/2" x 4" (114 mm x 102 mm)	US3	126.00	007369	3	24
		US4	116.25	007381		
		US10	116.25	019651		
		US10B	126.00	007354		
		US15	126.00	035768		
		US26	126.00	007362		
		US26D	99.80	007364		
		US32	101.85	007376		
		US32D	101.00	007378		
	4-1/2" x 4-1/2" (114 mm x 114 mm)	US3	126.00	007469	3	24
US4		116.25	007520			
US10		116.25	007390			
US10B		126.00	007406			
US15		126.00	007424			
US26		126.00	007437			
US26D		99.00	007445			
US32		101.85	007496			
5" x 4" (127 mm x 102 mm)	US3	160.85	007564	3	24	
	US4	135.35	069122			
	US10	135.35	064950			
	US10B	160.85	007557			
	US15	160.85	087838			
	US26	160.85	091928			
	US26D	135.45	007561			
	US32	137.85	138846			
5" x 4-1/2" (127 mm x 114 mm)	US3	160.85	007619	3	24	
	US4	135.35	007651			
	US10	135.35	007576			
	US10B	160.85	007585			
	US15	160.85	065583			
	US26	160.85	007601			
	US26D	135.45	007607			
	US32	137.85	007634			
5" x 5" (127 mm x 127 mm)	US3	160.85	007717	3	24	
	US4	135.35	007752			
	US10	135.35	007678			
	US10B	160.85	007689			
	US15	160.85	040362			
	US26	160.85	007703			
	US26D	135.45	007707			
	US32	137.85	007738			
	US32D	137.85	007742			





Description	Finish	2018 List	Stock No.	Box Qty.	Case Qty.	
BB1199 - Cont. Continued	6" x 4-1/2" (152 mm x 114 mm)	US3	374.30	011566	3	12
		US4	243.15	018196		
		US10	243.15	099882		
		US10B	374.30	094854		
		US15	374.30	031525		
		US26	374.30	-		
		US26D	263.90	007775		
		US32	357.00	058406		
		US32D	357.00	007783		
	6" x 5" (152 mm x 127 mm)	US3	374.30	007803	3	12
US4		243.15	013028			
US10		243.15	019745			
US10B		374.30	007792			
US15		374.30	055244			
US26		374.30	-			
US26D		263.90	007800			
US32		357.00	048380			
6" x 6" (152 mm x 152 mm)	US3	374.30	007827	3	12	
	US4	243.15	007838			
	US10	243.15	007816			
	US10B	374.30	007820			
	US15	374.30	040565			
	US26	374.30	116381			
	US26D	263.90	007825			
	US32	357.00	073209			
8" x 6" (203 mm x 152 mm)	USP	598.40	054124	3	12	
	US3	849.25	017553			
	US10	628.20	071278			
	US10B	849.25	072364			
	US15	849.25	095022			
	US26D	738.60	003819			
	US32D	984.60	007853			
	8" x 8" (203 mm x 203 mm)	USP	598.40	046441	3	12
US3		849.25	073590			
US10		628.20	025171			
US10B		849.25	007857			
US15		849.25	124169			
US26D		738.60	032486			
US32D		984.60	007863			

1. Items with the price in **bold and red** are Quick Ship items and ship in 24 hours.
Please use stock number when ordering. 2. U/M is each unless otherwise noted.



Commercial Hinges



Description	Finish	2018 List	Stock No.	Box Qty.	Case Qty.		
WTBB1199 Wide Throw Brass or Stainless Full Mortise Heavy Weight Ball Bearing	4-1/2" x 5" (114 mm x 127 mm)	US3	295.55	007267	3	24	
		US4	233.35	065299			
		US10	233.35	031727			
		US10B	295.55	021314			
		US26	295.55	017632			
		US26D	256.30	007274			
		US32	317.05	089866			
		US32D	317.05	098011			
		4-1/2" x 6" (114 mm x 152 mm)	US3	304.25	023840	3	24
		US4	241.35	068984			
	US10	241.35	048525				
	US10B	304.25	055190				
	US26	304.25	033508				
	US26D	273.55	076837				
	US32	325.50	015353				
	US32D	325.50	007302				
	4-1/2" x 7" (114 mm x 178 mm)	US3	321.30	103595	3	24	
	US4	267.35	051679				
	US10	267.35	013416				
	US10B	321.30	007306				
	US26	321.30	-				
	US26D	308.45	018563				
	US32	347.05	-				
	US32D	347.05	099677				
	4-1/2" x 8" (114 mm x 203 mm)	US3	347.05	028182	3	24	
	US4	295.60	091502				
	US10	295.60	087891				
	US10B	347.05	039213				
	US26	347.05	069204				
	US26D	321.30	105127				
	US32	375.30	051771				
	US32D	375.30	020980				
	5" x 6" (127 mm x 152 mm)	US3	359.90	048922	3	24	
	US4	308.45	021718				
	US10	308.45	125775				
	US10B	359.90	032471				
	US26	359.90	-				
	US26D	331.60	030677				
	US32	401.00	095695				
	US32D	401.00	007332				
	5" x 7" (127 mm x 178 mm)	US3	372.75	046417	3	24	
	US4	308.45	109376				
	US10	308.45	102105				
	US10B	372.75	065989				
	US26	372.75	-				
	US26D	334.20	048069				
	US32	406.15	145249				
	US32D	406.15	030561				



Description	Finish	2018 List	Stock No.	Box Qty.	Case Qty.	
WTBB1199 - Cont. Continued	5" x 8" (127 mm x 203 mm)	US3	388.15	084305	3	24
		US4	331.60	142606		
		US10	331.60	146648		
		US10B	388.15	005340		
		US26	388.15	-		
		US26D	347.05	034917		
		US32	424.15	-		
	US32D	424.15	019520			
1250 Steel Full Mortise Standard Weight Spring Hinge Available with Raised Barrel Available with hospital tip (voids UL)	3-1/2" x 3-1/2" (89 mm x 89 mm)	USP	30.25	007989	2	80
		US3	40.05	007984		
		US4	30.25	007986		
		US10	30.25	007974		
		US10A (US11)	40.05	007975		
		US10B	40.05	007977		
		US26D	40.90	007981		
	4" x 4" (102 mm x 102 mm)	USP	38.55	008006	3	48
		US3	53.65	008001		
		US4	38.55	008003		
		US10	38.55	007991		
		US10A (US11)	53.65	007992		
		US10B	53.65	007994		
	US26D	47.40	007999			
4-1/2" x 4" (114 mm x 102 mm)	USP	68.90	008020	3	48	
	US3	65.35	008014			
	US4	68.90	008015			
	US10	68.90	008008			
	US10A (US11)	65.35	008009			
	US10B	65.35	008010			
	US26D	62.25	008013			
4-1/2" x 4-1/2" (114 mm x 114 mm)	USP	68.90	008050	3	48	
	US3	65.35	008039			
	US4	68.90	008041			
	US10	68.90	008021			
	US10A (US11)	65.35	008023			
	US10B	65.35	008025			
	US26	65.35	008034			
	US26D	62.25	008037			
1251 Steel 1/4" Round Corner Radius, Full Mortise Standard Weight Spring Hinge	4" x 4" (102 mm x 102 mm)	USP	38.55	008079	3	48
		US3	53.65	008073		
		US4	38.55	008074		
		US10	38.55	008067		
		US10A (US11)	53.65	008069		
		US10B	53.65	067122		
		US26D	47.40	008072		

1. Items with the price in **bold and red** are Quick Ship items and ship in 24 hours.
Please use stock number when ordering. 2. U/M is each unless otherwise noted.



Commercial Hinges

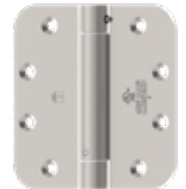

Description		Finish	2018 List	Stock No.	Box Qty.	Case Qty.
1251 - Cont. Continued	4-1/2" x 4"	USP	67.00	008086	3	48
	(114 mm x 102 mm)	US3	92.90	003696		
		US4	82.60	008084		
		US10	82.60	012636		
		US10A (US11)	92.90	072921		
		US10B	92.90	038047		
		US26D	89.55	008082		
1252 Steel 5/8" Round Corner Radius Full Mortise Standard Weight Spring Hinge	4" x 4"	USP	38.55	008111	3	48
	(102 mm x 102 mm)	US3	53.65	008106		
		US4	38.55	008107		
		US10	38.55	008102		
		US10A (US11)	53.65	008103		
		US10B	53.65	079680		
		US26D	47.40	008105		
Note: Hager does not recommend using spring hinges on doors over 7'0"	4-1/2" x 4"	USP	67.00	094477	3	48
	(114 mm x 102 mm)	US3	92.90	131917		
		US4	82.60	128797		
		US10	82.60	-		
		US10A (US11)	92.90	-		
		US10B	92.90	066475		
		US26D	89.55	008112		
1253 Steel Half Surface Standard Weight Spring Hinge	4-1/2" (114 mm)	USP	102.20	008126	3	48
		US3	141.45	008122		
		US4	122.95	008123		
		US10	122.95	068449		
		US10A (US11)	141.45	040132		
		US10B	141.45	029321		
	US26D	145.20	008121			





Description	Finish	2018 List	Stock No.	Box Qty.	Case Qty.
1255 Steel, Full Mortise Standard Weight Spring Hinge Set 2 ea. 1250 and 1 ea. AB700	4-1/2" x 4-1/2" (114 mm x 114 mm)	USP	174.50	059982	1 16
		US3	183.10	069391	
		US4	184.20	072216	
		US10B	183.10	015725	
		US26D	160.30	050862	
Note: Hager does not recommend using spring hinges on doors over 7'0"					
1256 Steel Full Mortise Standard Weight Spring Hinge Set 2 ea. 1250 and 1 ea. BB1279	4-1/2" x 4-1/2" (114 mm x 114 mm)	USP	170.75	066379	1 16
		US3	176.55	066381	
		US4	178.75	066382	
		US10B	176.55	078188	
		US26D	156.60	066380	
Note: Hager does not recommend using spring hinges on doors over 7'0"					
1257 Steel Reverse Action (opens door) Spring Hinge Full Mortise Standard Weight	4-1/2" x 4-1/2" (114 mm x 114 mm)	US26D	105.55	023280	3 48
Note: Hager does not recommend using spring hinges on doors over 7'0"					
1260 Steel Full Mortise Standard Weight Swing Clear	3-1/2" (89 mm)	USP	71.80	008132	3 48
		US3	107.45	008130	
		US4	78.35	008131	
		US10	88.95	008127	
		US10A (US11)	107.45	057903	
		US10B	107.45	019620	
		US26	107.45	008128	
		US26D	85.15	008129	
	4" (102 mm)	USP	85.15	008134	3 36
		US3	109.85	051811	
		US4	81.00	051756	
		US10	91.90	052043	
		US10A (US11)	109.85	097783	
	US10B	109.85	018275		
	US26	109.85	008133		
	US26D	87.60	053701		

1. Items with the price in **bold and red** are Quick Ship items and ship in 24 hours.
Please use stock number when ordering. 2. U/M is each unless otherwise noted.



Commercial Hinges

Description	Finish	2018 List	Stock No.	Box Qty.	Case Qty.
-------------	--------	-----------	-----------	----------	-----------

PAGE DELIBERATELY LEFT BLANK



Description		Finish	2018 List	Stock No.	Box Qty.	Case Qty.
BB1260	4-1/2" (114 mm)	USP	152.05	008150	3	36
Steel		US10	158.30	008137		
Full Mortise		US10A (US11)	186.95	008140		
Standard Weight		US10B	186.95	062238		
Ball Bearing		US26D	162.10	008142		
Swing Clear	5" (127 mm)	USP	152.05	008157	3	36
RH Standard (Reversible to LH)		US10	158.30	016025		
		US10A (US11)	186.95	008154		
		US10B	186.95	061702		
		US26D	162.10	008156		



BB1261	4-1/2" (114 mm)	USP	152.05	008174	3	36
Steel		US10	158.30	008161		
Full Mortise		US10A (US11)	186.95	008163		
Standard Weight		US10B	186.95	098270		
Ball Bearing		US26D	162.10	008166		
Swing Clear	5" (127 mm)	USP	152.05	032933	3	36
Beveled Edge Doors		US10	158.30	083843		
RH Standard (Reversible to LH)		US10A (US11)	186.95	008175		
		US10B	186.95	073019		
		US26D	162.10	008177		



BB1262	4-1/2" (114 mm)	USP	188.10	008193	3	24
Steel		US10	190.80	008181		
Full Mortise		US10A (US11)	229.15	008182		
Heavy Weight		US10B	229.15	080232		
Ball Bearing		US26D	177.45	008186		
Swing Clear	5" (127 mm)	USP	188.10	008205	3	24
RH Standard (Reversible to LH)		US10	190.80	008195		
		US10A (US11)	229.15	007128		
		US10B	229.15	022873		
		US26D	177.45	008199		



BB1263	4-1/2" (114 mm)	USP	188.10	008223	3	24
Steel		US10	190.80	008212		
Full Mortise		US10A (US11)	229.15	008214		
Heavy Weight		US10B	229.15	008216		
Ball Bearing		US26D	177.45	008218		
Swing Clear	5" (127 mm)	USP	188.10	008236	3	24
Beveled Edge Doors		US10	190.80	008225		
RH Standard (Reversible to LH)		US10A (US11)	229.15	008227		
		US10B	229.15	018189		
		US26D	177.45	008229		

1. Items with the price in **bold and red** are Quick Ship items and ship in 24 hours.
Please use stock number when ordering. 2. U/M is each unless otherwise noted.



Commercial Hinges



Description	Finish	2018 List	Stock No.	Box Qty.	Case Qty.
BB1266					
5" (127 mm)	USP	368.35	008266	3	12
Steel	US10	386.60	071003		
Full Surface	US10A (US11)	580.70	026077		
Heavy Weight	US10B	580.70	060302		
Ball Bearing	US26D	460.30	008261		
Swing Clear					



1267					
4-1/2" (114 mm)	USP	190.00	135773	3	36
Steel	US3	221.30	121383		
Full Mortise	US10	199.90	-		
Swing Clear Spring Hinge	US10A (US11)	221.30	-		
Square Edge Doors	US10B	221.30	-		
Use with BB1260/AB7001	US26	221.30	-		
	US26D	210.20	113387		

Note: Hager does not recommend using spring hinges on doors over 7'0"



BB1277					
Made to Order		106.20*	-	3	48
Steel		*Add to price of BB1279			
Full Mortise					
Standard Weight					
Ball Bearing					
Both Leaves Tapped					



BB1278					
		106.20*	-	3	48
Steel		*Add to price of BB1279			
Full Mortise					
Standard Weight					
Ball Bearing					
One Leaf Tapped					
Specify Handing					



1279					
3" x 3"	LS	26.95	008460	2	100
(76 mm x 76 mm)	H2H	54.55	008448		
Steel	USP	23.00	008461		
Full Mortise	US3	50.35	008449		
Standard Weight	US4	26.95	008454		
Plain Bearing	US10	26.95	008427		
	US10A (US11)	50.35	008429		
	US10B	50.35	064052		
	US15	50.35	008435		
	US26	50.35	008439		
	US26D	41.85	008442		





Description	Finish	2018 List	Stock No.	Box Qty.	Case Qty.	
1279 - Cont. Continued	3-1/2" x 3-1/2" (89 mm x 89 mm)	LS	9.40	010919	2	100
		H2H	19.05	010881		
		USP	7.35	010923		
		US3	14.80	010886		
		US4	9.40	010897		
		US10	9.40	010819		
		US10A (US11)	14.80	010829		
		US10B	14.80	010839		
		US15	14.80	010850		
		US26	14.80	010859		
		US26D	12.35	010870		
	4" x 3-1/2" (102 x 89 mm)	LS	17.35	-	3	48
		H2H	28.20	-		
USP		13.35	000695			
US3		24.50	008469			
US4		15.70	096337			
US10		15.70	015158			
US10A (US11)		24.50	063165			
US10B		24.50	025812			
US15		24.50	041310			
US26		24.50	056835			
US26D		21.30	088103			
4" x 4" (102 mm x 102 mm)		LS	11.60	008583	3	48
		H2H	20.80	008532		
	USP	9.10	008585			
	US3	16.65	008540			
	US4	11.60	008555			
	US10	11.60	008470			
	US10A (US11)	16.65	008477			
	US10B	16.65	008488			
	US15	16.65	008496			
	US26	16.65	008507			
	US26D	15.15	008517			
	4-1/2" x 4" (114 mm x 102 mm)	LS	11.15	008648	3	48
		H2H	23.95	067471		
USP		9.60	008650			
US3		19.20	008629			
US4		11.15	008637			
US10		11.15	008599			
US10A (US11)		19.20	008602			
US10B		19.20	008608			
US15		19.20	008612			
US26		19.20	008617			
US26D		12.00	008622			

1. Items with the price in **bold and red** are Quick Ship items and ship in 24 hours.
Please use stock number when ordering. 2. U/M is each unless otherwise noted.



Commercial Hinges



Description	Finish	2018 List	Stock No.	Box Qty.	Case Qty.	
1279 - Cont. 2 Continued	4-1/2" x 4-1/2" (114 mm x 114 mm)	LS	11.15	008826	3	48
		H2H	23.95	008748		
		USP	9.60	008833		
		US3	19.20	008762		
		US4	11.15	008785		
		US10	11.15	008657		
		US10A (US11)	19.20	008671		
		US10B	19.20	008687		
		US15	19.20	008698		
		US26	19.20	008709		
		US26D	12.00	008720		
5" x 4" (127 mm x 102 mm)	LS	38.55	-	3	24	
	H2H	65.15	038234			
	USP	31.70	008871			
	US3	52.15	008863			
	US4	38.55	008865			
	US10	38.55	088473			
	US10A (US11)	52.15	009784			
	US10B	52.15	008536			
	US15	52.15	068578			
	US26	52.15	064843			
	US26D	35.70	008862			
5" x 4-1/2" (127 mm x 114 mm)	LS	38.55	-	3	24	
	H2H	65.15	031063			
	USP	31.70	008911			
	US3	52.15	008895			
	US4	38.55	008900			
	US10	38.55	008875			
	US10A (US11)	52.15	008879			
	US10B	52.15	008882			
	US15	52.15	083724			
	US26	52.15	008884			
	US26D	35.70	008887			
5" x 5" (127 mm x 127 mm)	LS	38.55	081132	3	24	
	H2H	65.15	019652			
	USP	31.70	008963			
	US3	52.15	008944			
	US4	38.55	008956			
	US10	38.55	008923			
	US10A (US11)	52.15	008925			
	US10B	52.15	008929			
	US15	52.15	067162			
	US26	52.15	008934			
	US26D	35.70	008938			



Description	Finish	2018 List	Stock No.	Box Qty.	Case Qty.	
BB1279 Steel Full Mortise Standard Weight Ball Bearing	3-1/2" x 3-1/2" (89 mm x 89 mm)	LS	35.55	019111	2	100
		H2H	57.60	-		
		USP	35.55	011038		
		US3	46.10	011013		
		US4	35.55	011021		
		US10	35.55	010983		
		US10A (US11)	46.10	010988		
		US10B	46.10	010995		
		US15	46.10	060839		
		US26	46.10	010998		
		US26D	35.90	011003		
	4" x 3-1/2" (102 mm x 89 mm)	LS	41.90	-	3	48
		H2H	62.35	-		
		USP	38.30	072989		
		US3	55.35	009726		
US4		38.30	028772			
US10		41.90	006898			
US10A (US11)		55.35	070929			
US10B		55.35	014742			
US15		55.35	029388			
US26		55.35	000728			
US26D		47.65	009725			
4" x 4" (102 mm x 102 mm)	LS	29.65	009805	3	48	
	H2H	44.80	020230			
	USP	25.95	009808			
	US3	35.85	009778			
	US4	25.95	009792			
	US10	29.65	009727			
	US10A (US11)	35.85	009731			
	US10B	35.85	009738			
	US15	35.85	009747			
	US26	35.85	009755			
	US26D	30.75	009763			
4-1/2" x 4" (114 mm x 102 mm)	LS	24.70	009933	3	48	
	H2H	37.30	045582			
	USP	17.40	009937			
	US3	29.85	009888			
	US4	24.70	009900			
	US10	24.70	009817			
	US10A (US11)	29.85	009825			
	US10B	29.85	009841			
	US15	29.85	009849			
	US26	29.85	009857			
	US26D	16.75	009868			

1. Items with the price in **bold and red** are Quick Ship items and ship in 24 hours.
Please use stock number when ordering. 2. U/M is each unless otherwise noted.



Commercial Hinges



Description	Finish	2018 List	Stock No.	Box Qty.	Case Qty.	
BB1279 - Cont. Continued	4-1/2" x 4-1/2" (114 mm x 114 mm)	LS	24.70	010310	3	48
		H2H	37.30	010172		
		USP	17.40	010322		
		US3	29.85	010189		
		US4	24.70	010230		
		US10	24.70	009957		
		US10A (US11)	29.85	009990		
		US10B	29.85	010029		
		US15	29.85	010048		
		US26	29.85	010073		
		US26D	16.75	010108		
	<hr/>					
	5" x 4" (127 mm x 102 mm)	LS	48.25	-	3	24
H2H		76.40	-			
USP		48.25	010411			
US3		61.10	010397			
US4		48.25	010403			
US10		48.25	010377			
US10A (US11)		61.10	010380			
US10B		61.10	071584			
US15		61.10	035721			
US26		61.10	010385			
US26D		47.25	010390			
<hr/>						
5" x 4-1/2" (127 mm x 114 mm)	LS	48.25	055246	3	24	
	H2H	76.40	-			
	USP	48.25	010515			
	US3	61.10	010479			
	US4	48.25	010493			
	US10	48.25	010416			
	US10A (US11)	61.10	010429			
	US10B	61.10	010438			
	US15	61.10	010444			
	US26	61.10	010447			
	US26D	47.25	010457			
<hr/>						
5" x 5" (127 mm x 127 mm)	LS	48.25	-	3	24	
	H2H	76.40	105812			
	USP	48.25	010620			
	US3	61.10	010586			
	US4	48.25	010602			
	US10	48.25	010537			
	US10A (US11)	61.10	010546			
	US10B	61.10	010556			
	US15	61.10	010559			
	US26	61.10	010564			
	US26D	47.25	010570			



Description	Finish	2018 List	Stock No.	Box Qty.	Case Qty.
BB1279 - Cont. 2	6" x 4-1/2"	LS	114.70	-	3 24
Continued	(152 mm x 114 mm)	H2H	174.80	-	
		USP	114.70	010651	
		US3	154.25	010644	
		US4	114.70	010649	
		US10	114.70	010632	
		US10A (US11)	154.25	009996	
		US10B	154.25	010638	
		US15	154.25	093744	
		US26	154.25	113396	
		US26D	132.45	010641	
	6" x 5"	LS	114.70	-	3 24
	(152 mm x 127 mm)	H2H	174.80	-	
		USP	114.70	065930	
		US3	154.25	017680	
		US4	114.70	014005	
		US10	114.70	010656	
		US10A (US11)	154.25	010658	
		US10B	154.25	020934	
		US15	154.25	108871	
		US26	154.25	-	
		US26D	132.45	010660	
	6" x 6"	LS	114.70	-	3 24
	(152 mm x 152 mm)	H2H	174.80	-	
		USP	114.70	010696	
		US3	154.25	010685	
		US4	114.70	010689	
		US10	114.70	010674	
		US10A (US11)	154.25	010677	
		US10B	154.25	068156	
		US15	154.25	043949	
		US26	154.25	010679	
		US26D	132.45	010681	

1. Items with the price in **bold and red** are Quick Ship items and ship in 24 hours.
 Please use stock number when ordering. 2. U/M is each unless otherwise noted.



Commercial Hinges



Description	Finish	2018 List	Stock No.	Box Qty.	Case Qty.		
WTBB1279 Wide Throw Steel Full Mortise Standard Weight Ball Bearing	3-1/2" x 5" (89 mm x 127 mm)	LS	68.15	-	3	24	
		USP	65.40	010918			
		US3	83.40	009518			
		US10	68.15	101108			
		US10A (US11)	83.40	009516			
		US10B	83.40	023424			
		US26	83.40	065499			
		US26D	74.25	011178			
		3-1/2" x 6" (89 mm x 152 mm)	LS	68.15	-	3	24
		USP	65.40	066581			
	US3	83.40	047525				
	US10	68.15	121608				
	US10A (US11)	83.40	132395				
	US10B	83.40	098415				
	US26	83.40	117331				
	US26D	74.25	009523				
	4" x 5" (102 mm x 127 mm)	LS	95.10	-	3	24	
	USP	91.85	009537				
	US3	110.85	009531				
	US10	95.10	011977				
	US10A (US11)	110.85	009527				
	US10B	110.85	031902				
	US26	110.85	009684				
	US26D	101.75	092731				
	4" x 6" (102 mm x 152 mm)	LS	95.10	-	3	24	
	USP	91.85	009547				
	US3	110.85	009545				
	US10	95.10	014811				
	US10A (US11)	110.85	009540				
	US10B	110.85	006722				
	US26	110.85	022988				
	US26D	101.75	009543				
	4" x 7" (102 mm x 178 mm)	LS	95.10	130408	3	24	
	USP	91.85	093245				
	US3	110.85	009552				
	US10	95.10	146515				
	US10A (US11)	110.85	049316				
	US10B	110.85	015456				
	US26	110.85	002586				
	US26D	101.75	009551				





Description	Finish	2018 List	Stock No.	Box Qty.	Case Qty.
WTBB1279 - Cont. Continued	4-1/2" x 5" (114 mm x 127 mm)	LS	91.05	-	3 24
		USP	89.10	009587	
		US3	101.90	009573	
		US10	91.05	009557	
		US10A (US11)	101.90	009559	
		US10B	101.90	009564	
		US26	101.90	009566	
		US26D	95.30	009567	
4-1/2" x 6" (114 mm x 152 mm)	LS	91.05	-	3	24
	USP	89.10	009629		
	US3	101.90	009613		
	US10	91.05	009591		
	US10A (US11)	101.90	009596		
	US10B	101.90	009600		
	US26	101.90	009601		
	US26D	95.30	009607		
4-1/2" x 7" (114 mm x 178 mm)	USP	95.90	009654	3	24
	US3	109.55	009644		
	US10	98.00	009636		
	US10A (US11)	109.55	097139		
	US10B	109.55	034974		
	US26D	102.60	009642		
4-1/2" x 8" (114 mm x 203 mm)	USP	95.90	009671	3	24
	US3	109.55	093992		
	US10	98.00	066950		
	US10A (US11)	109.55	028232		
	US10B	109.55	019076		
	US26D	102.60	009663		
5" x 6" (127 mm x 152 mm)	USP	121.75	049054	3	24
	US3	152.10	097745		
	US10	127.80	009676		
	US10A (US11)	152.10	019102		
	US10B	152.10	028233		
	US26D	140.00	009683		
5" x 7" (127 mm x 178 mm)	USP	121.75	033635	3	24
	US3	152.10	021386		
	US10	127.80	009694		
	US10A (US11)	152.10	050575		
	US10B	152.10	030684		
	US26D	140.00	036924		
5" x 8" (127 mm x 203 mm)	USP	121.75	027044	3	24
	US3	152.10	047665		
	US10	127.80	042602		
	US10A (US11)	152.10	034328		
	US10B	152.10	011281		
	US26D	140.00	094856		

1. Items with the price in **bold and red** are Quick Ship items and ship in 24 hours.
Please use stock number when ordering. 2. U/M is each unless otherwise noted.



Commercial Hinges



Description	Finish	2018 List	Stock No.	Box Qty.	Case Qty.	
1303 Double Acting Spring Hinge	3" (76 mm)	USP	43.95	126803	1	10
		US3	58.00	126804		
		US4	53.20	126805		
		US26D	71.80	126807		
	4" (102 mm)	USP	49.85	126808	1	10
		US3	65.55	126809		
		US4	64.55	126810		
		US26D	80.65	126811		
	5" (127 mm)	USP	71.35	126812	1	10
		US3	96.25	126813		
		US4	105.85	126814		
		US26D	117.95	126815		
6" (152 mm)	USP	71.35	126816	1	10	
	US3	96.25	126817			
	US4	105.85	126818			
	US26D	117.95	126819			
BB1360 Stainless Steel Full Mortise Standard Weight Ball Bearing Swing Clear RH Standard (reversible to LH)	4-1/2" (114 mm)	US32D	221.80	060909	3	36
	5" (127 mm)	US32D	221.80	097565	3	36
BB1361 Stainless Steel Full Mortise Standard Weight Ball Bearing Swing Clear Beveled Edge Doors RH Standard (reversible to LH)	4-1/2" (114 mm)	US32D	221.80	044728	3	36
	5" (127 mm)	US32D	221.80	094295	3	36
BB1362 Stainless Steel Full Mortise Heavy Weight Ball Bearing Swing Clear RH Standard (reversible to LH)	4-1/2" (114 mm)	US32D	248.60	045163	3	24
	5" (127 mm)	US32D	248.60	041420	3	24
BB1363 Stainless Steel Full Mortise Heavy Weight Ball Bearing Swing Clear Beveled Edge Doors RH Standard (reversible to LH)	4-1/2" (114 mm)	US32D	248.60	042414	3	24
	5" (127 mm)	US32D	248.60	042845	3	24
BB1577 Brass or stainless Full Mortise Standard Weight Ball Bearing Both Leaves Tapped			105.35*	-	3	48
			*Add to price of BB1191			





Description	Finish	2018 List	Stock No.	Box Qty.	Case Qty.
BB1578 Brass or stainless Full Mortise Standard Weight Ball Bearing One Leaf Tapped Specify Handing		105.35* *Add to price of BB1191	-	3	48
1712 Ball Tip Hinge Kit Standard Weight					
	3-1/2" (89 mm)	ALL	57.95	066653	10 100
	4" (102 mm)	ALL	57.95	066654	10 100
	4-1/2" (114 mm)	ALL	58.35	066655	10 100
	5" (127 mm)	ALL	58.35	066656	10 100
	6" (152 mm)	ALL	58.35	079328	10 100
1713 Ball Tip Hinge Kit Heavy Weight					
	4-1/2" (114 mm)	ALL	63.75	066657	10 100
	5" (127 mm)	ALL	63.75	066658	10 100
	6" (152 mm)	ALL	63.75	072882	10 100
1716 Acorn Tip Hinge Kit Standard Weight					
	3-1/2" (89 mm)	ALL	58.35	066638	10 100
	4" (102 mm)	ALL	58.35	066639	10 100
	4-1/2" (114 mm)	ALL	58.35	066640	10 100
	5" (127 mm)	ALL	58.35	066641	10 100
	6" (152 mm)	ALL	58.35	-	10 100
1717 Acorn Tip Hinge Kit Heavy Weight					
	4-1/2" (114 mm)	ALL	63.75	015890	10 100
	5" (127 mm)	ALL	63.75	066643	10 100
	6" (152 mm)	ALL	63.75	-	10 100
1722 Steeple Tip Hinge Kit Standard Weight					
	3-1/2" (89 mm)	ALL	58.35	066644	10 100
	4" (102 mm)	ALL	58.35	066645	10 100
	4-1/2" (114 mm)	ALL	58.35	066689	10 100
	5" (127 mm)	ALL	58.35	066690	10 100
	6" (152 mm)	ALL	58.35	-	10 100
1723 Steeple Tip Hinge Kit Heavy Weight					
	4-1/2" (114 mm)	ALL	63.75	066691	10 100
	5" (127 mm)	ALL	63.75	066646	10 100
	6" (152 mm)	ALL	63.75	-	10 100
1728 Urn Tip Hinge Kit Standard Weight					
	3-1/2" (89 mm)	ALL	58.35	066647	10 100
	4" (102 mm)	ALL	58.35	066648	10 100
	4-1/2" (114 mm)	ALL	58.35	066649	10 100
	5" (127 mm)	ALL	58.35	066650	10 100
	6" (152 mm)	ALL	58.35	-	10 100
1729 Urn Tip Hinge Kit Heavy Weight					
	4-1/2" (114 mm)	ALL	63.75	066651	10 100
	5" (127 mm)	ALL	63.75	022876	10 100
	6" (152 mm)	ALL	63.75	007875	10 100

1. Items with the price in **bold and red** are Quick Ship items and ship in 24 hours.
Please use stock number when ordering. 2. U/M is each unless otherwise noted.



Commercial Hinges



Description	Finish	2018 List	Stock No.	Box Qty.	Case Qty.
1850 Steel - Full Surface	PS	55.90	042562	10	40
Heavy Weight	PS	73.25	042564	10	40
Plain Bearing	PS	94.10	042596	1	10
No Holes	PS	140.50	042597	1	10
1850 LP Loose Oval Pin	PS	140.50	177161	1	10



BB2112 Brass or Stainless	US10	401.25	056746	3	48
Half Surface	US10B	505.25	028766		
Standard Weight	US26D	434.65	026917		
Ball Bearing	US32D	589.35	006867		
	US10	193.35	012824	3	48
	US10B	241.70	002499		
	US26D	208.10	012828		
	US32D	281.95	012833		
	US10	204.20	012838	3	36
	US10B	265.45	133233		
	US26D	230.90	012839		
	US32D	300.15	004041		



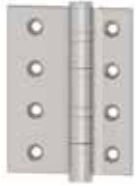

Description		Finish	2018 List	Stock No.	Box Qty.	Case Qty.
BB2168	4-1/2" (114 mm)	USP	305.20	012899	3	36
	Steel	US10	318.00	-		
	Full Surface	US10A (US11)	372.30	-		
	Heavy Weight	US10B	372.30	089570		
	Ball Bearing	US26D	333.65	012898		
5" (127 mm)	USP	368.45	012902	3	24	
	US10	386.90	141575			
	US10A (US11)	504.20	-			
	US10B	504.20	-			
	US26D	438.45	011313			



BB2169	4-1/2" (114 mm)	USP	213.45	012914	3	36
	Steel	US10	318.05	042983		
	Full Surface	US10A (US11)	372.30	061635		
	Heavy Weight	US10B	372.30	115013		
	Ball Bearing	US26D	333.65	012911		
5" (127 mm)	USP	329.00	012923	3	24	
	US10	345.40	129997			
	US10A (US11)	460.90	-			
	US10B	460.90	080993			
	US26D	400.75	012920			



BB2171	4-1/2" (114 mm)	USP	83.40	012946	3	48
	Steel	US10	98.50	012934		
	Full Surface	US10A (US11)	125.60	012936		
	Standard Weight	US10B	125.60	143435		
	Ball Bearing	US26D	110.50	012940		
5" (127 mm)	USP	99.95	012956	3	36	
	US10	131.50	026071			
	US10A (US11)	163.20	-			
	US10B	163.20	-			
	US26D	141.85	012952			

1. Items with the price in **bold and red** are Quick Ship items and ship in 24 hours.
Please use stock number when ordering. 2. U/M is each unless otherwise noted.



Commercial Hinges



Description	Finish	2018 List	Stock No.	Box Qty.	Case Qty.
AB7001					
4-1/2" (114 mm)	LS	186.40	-	3	36
Steel	USP	186.40	122842		
Full Mortise	US3	229.10	028735		
Standard Weight	US10	193.95	-		
Concealed Anti-Friction Bearing	US10A (US11)	229.10	077050		
Swing Clear	US10B	229.10	008284		
	US26	229.10	-		
	US26D	181.65	024377		
<hr/>					
5" (127 mm)	LS	186.40	-	3	36
	USP	186.40	-		
	US3	229.10	102769		
	US10	193.95	-		
	US10A (US11)	229.10	-		
	US10B	229.10	-		
	US26	229.10	079631		
	US26D	181.65	087869		



AB7002					
4-1/2" (114 mm)	LS	186.40	-	3	36
Steel	USP	186.40	065541		
Full Mortise	US3	229.10	024690		
Standard Weight	US10	193.95	-		
Concealed Anti-Friction Bearing	US10A (US11)	229.10	103793		
Swing Clear	US10B	229.10	008287		
Beveled Edge Doors	US26	229.10	068502		
	US26D	181.65	094245		
<hr/>					
5" (127 mm)	LS	186.40	-	3	36
	USP	186.40	-		
	US3	229.10	-		
	US10	193.95	-		
	US10A (US11)	229.10	-		
	US10B	229.10	-		
	US26	229.10	-		
	US26D	181.65	013655		







AB7501					
4-1/2" (114 mm)	USP	230.65	073850	3	24
Steel	US10	233.85	017299		
Full Mortise	US10A (US11)	280.75	019030		
Heavy Weight	US10B	280.75	122627		
Concealed Anti-Friction Bearing	US26D	212.85	013622		
Swing Clear	<hr/>				
5" (127 mm)	USP	230.65	-	3	24
	US10	233.85	027631		
	US10A (US11)	280.75	116946		
	US10B	280.75	-		
	US26D	212.85	013628		



AB7502					
4-1/2" (114 mm)	USP	230.65	041605	3	24
Steel	US10	233.85	025196		
Full Mortise	US10A (US11)	280.75	081770		
Heavy Weight	US10B	280.75	085448		
Concealed Anti-Friction Bearing	US26D	212.85	094244		
Swing Clear	<hr/>				
5" (127 mm)	USP	230.65	116906	3	24
	US10	233.85	025197		
	US10A (US11)	280.75	094319		
	US10B	280.75	109409		
	US26D	212.85	013645		









	Description	Finish	2018 List	Stock No.	Box Qty.	Case Qty.
	AB7505	5" x 4-1/2"	LH USP	328.10	013659	1 10
	Steel	(127 mm x 114 mm)	RH USP	328.10	092796	
	Full Mortise		LH US10	334.35	043893	
	Heavy Weight		RH US10	334.35	054740	
	Concealed Anti-Friction Bearing		LH US10A (US11)	404.75	013652	
	Anchor Hinge		RH US10A (US11)	404.75	-	
	Specify Handing		LH US10B	404.75	105739	
			RH US10B	404.75	105740	
			LH US26D	322.10	094710	
			RH US26D	322.10	094711	
	AB7506	5" x 4-1/2"	LH USP	328.10	013684	1 10
	Steel	(127 mm x 114 mm)	RH USP	328.10	013687	
	Full Mortise		LH US10	334.35	094813	
	Heavy Weight		RH US10	334.35	093244	
	Concealed Anti-Friction Bearing		LH US10A (US11)	404.75	013664	
	Anchor Hinge		RH US10A (US11)	404.75	112521	
	Specify Handing		LH US10B	404.75	124567	
			RH US10B	404.75	124568	
			LH US26D	322.10	013674	
			RH US26D	322.10	013676	
	AB7507	5" x 4-1/2"	LH USP	328.10	018824	1 10
	Steel	(127 mm x 114 mm)	RH USP	328.10	071660	
	Full Mortise		LH US10	334.35	076424	
	Heavy Weight		RH US10	334.35	-	
	Concealed Anti-Friction Bearing		LH US10A (US11)	404.75	-	
	Anchor Hinge		RH US10A (US11)	404.75	-	
	Specify Handing		LH US10B	404.75	100912	
			RH US10B	404.75	100911	
			LH US26D	322.10	013696	
			RH US26D	322.10	096847	
	AB7508	5" x 4-1/2"	LH USP	328.10	013735	1 10
	Steel	(127 mm x 114 mm)	RH USP	328.10	013736	
	Full Mortise		LH US10	334.35	016914	
	Heavy Weight		RH US10	334.35	016885	
	Concealed Anti-Friction Bearing		LH US10A (US11)	404.75	013713	
	Anchor Hinge		RH US10A (US11)	404.75	039369	
	Beveled Edge Doors		LH US10B	404.75	096476	
	Specify Handing		RH US10B	404.75	096475	
			LH US26D	322.10	013721	
			RH US26D	322.10	013722	
	AB7509	5" x 4-1/2"	LH USP	328.10	-	1 10
	Steel	(127 mm x 114 mm)	RH USP	328.10	-	
	Full Mortise		LH US10	334.35	036585	
	Heavy Weight		RH US10	334.35	036561	
	Concealed Anti-Friction Bearing		LH US10A (US11)	404.75	-	
	Anchor Hinge		RH US10A (US11)	404.75	-	
	Beveled Edge Doors		LH US10B	404.75	059951	
	Specify Handing		RH US10B	404.75	059965	
			LH US26D	322.10	013748	
			RH US26D	322.10	013749	

1. Items with the price in **bold and red** are Quick Ship items and ship in 24 hours.
Please use stock number when ordering. 2. U/M is each unless otherwise noted.



Commercial Hinges

	Description	Finish	2018 List	Stock No.	Box Qty.	Case Qty.	
	AB8505	5" x 4-1/2" (127 mm x 114 mm)	LH US10	343.00	120612	1	10
	Brass or Stainless		RH US10	343.00	120613		
	Full Mortise		LH US10B	410.70	005892		
	Heavy Weight		RH US10B	410.70	005891		
	Concealed Anti-Friction Bearing		LH US26D	325.55	088541		
	Anchor Hinge		RH US26D	325.55	088542		
	Specify Handing		LH US32D	536.20	013976		
			RH US32D	536.20	013977		
	AB8506	5" x 4-1/2" (127 mm x 114 mm)	LH US10	343.00	038811	1	10
	Brass or Stainless		RH US10	343.00	038812		
	Full Mortise		LH US10B	410.70	090057		
	Heavy Weight		RH US10B	410.70	090058		
	Concealed Anti-Friction Bearing		LH US26D	325.55	013988		
	Anchor Hinge		RH US26D	325.55	013990		
	Specify Handing		LH US32D	536.20	013996		
			RH US32D	536.20	013998		
	AB8507	5" x 4-1/2" (127 mm x 114 mm)	LH US10	343.00	-	1	10
	Brass or Stainless		RH US10	343.00	-		
	Full Mortise		LH US10B	410.70	046057		
	Heavy Weight		RH US10B	410.70	046058		
	Concealed Anti-Friction Bearing		LH US26D	325.55	092729		
	Anchor Hinge		RH US26D	325.55	092730		
	Beveled Edge Doors		LH US32D	536.20	093601		
Specify Handing`		RH US32D	536.20	094538			
	AB8508	5" x 4-1/2" (127 mm x 114 mm)	LH US10	343.00	057002	1	10
	Brass or Stainless		RH US10	343.00	057004		
	Full Mortise		LH US10B	410.70	097781		
	Heavy Weight		RH US10B	410.70	014016		
	Concealed Anti-Friction Bearing		LH US26D	325.55	014019		
	Anchor Hinge		RH US26D	325.55	014021		
	Beveled Edge Doors		LH US32D	536.20	014028		
Specify Handing		RH US32D	536.20	014030			
	AB8509	5" x 4-1/2" (127 mm x 114 mm)	LH US10	343.00	012173	1	10
	Brass or Stainless		RH US10	343.00	012174		
	Full Mortise		LH US10B	410.70	046059		
	Heavy Weight		RH US10B	410.70	046060		
	Concealed Anti-Friction Bearing		LH US26D	325.55	068077		
	Anchor Hinge		RH US26D	325.55	022626		
	Beveled Edge Doors		LH US32D	536.20	014048		
Specify Handing		RH US32D	536.20	094613			
	EC1100*	4-1/2" x 4" (114 mm x 102 mm)	US26D	11.10	121894	3	48
	Steel						
	Full Mortise	4-1/2" x 4-1/2"	USP	7.60	079434	3	48
	Standard Weight	(114 mm x 114 mm)	US3	13.90	079435		
	Plain Bearing		US4	10.10	079441		
			US10B	13.90	075953		
			US15	13.90	108111		
		US26	13.90	108113			
		US26D	11.10	075047			

1. Items with the price in **bold and red** are Quick Ship items and ship in 24 hours.
Please use stock number when ordering. 2. U/M is each unless otherwise noted.



Description	Finish	2018 List	Stock No.	Box Qty.	Case Qty.
EC1100 NRP* Steel Full Mortise Standard Weight Plain Bearing	4-1/2" x 4" (114 mm x 102 mm)	US26D	13.45	123072	3 48
	4-1/2" x 4-1/2" (114 mm x 114 mm)	USP	9.95	084179	3 48
		US10B	16.20	075986	
		US15	16.20	109256	
		US26	16.20	135223	
		US26D	13.45	082934	

* ECCO hinges are sold in box quantities only

* Some ECCO hinges available in 316 Stainless Steel. Contact Hager Companies Sales and Service for information.



ECBB1100* Steel Full Mortise Standard Weight Ball Bearing	4-1/2" x 4" (114 mm x 102 mm)	US26D	13.20	094657	3 48
	4-1/2" x 4-1/2" (114 mm x 114 mm)	USP	12.85	079444	3 48
		US3	24.40	079445	
		US4	17.75	079446	
		US10B	24.40	076317	
		US15	24.40	108114	
		US26	24.40	108117	
		US26D	13.20	075048	



ECBB1100 NRP* Steel Full Mortise Standard Weight Ball Bearing	4-1/2" x 4" (114 mm x 102 mm)	US26D	15.50	094659	3 48
	4-1/2" x 4-1/2" (114 mm x 114 mm)	USP	15.15	079448	3 48
		US3	26.75	082125	
		US4	20.10	082129	
		US10B	26.75	076316	
		US26	26.75	109257	
		US26D	15.50	075049	



ECRC1100* Round Corner Steel Full Mortise Standard Weight Plain Bearing	4" x 4" (102 mm x 102 mm)	US15	13.35	109258	3 48
		US26	13.35	-	
		US26D	9.30	075637	



ECRCBB1100* Round Corner Steel Full Mortise Standard Weight Ball Bearing	4" x 4" (102 mm x 102 mm)	US15	17.25	109259	3 48
		US26	17.25	-	
		US26D	12.60	073800	



EC1101* Brass or Stainless Steel Full Mortise Standard Weight Plain Bearing	4-1/2" x 4-1/2" (114 mm x 114 mm)	US15	48.00	128121	3 48
		US26	48.00	125210	
		US32D	46.15	079552	

1. Items with the price in **bold and red** are Quick Ship items and ship in 24 hours.
Please use stock number when ordering. 2. U/M is each unless otherwise noted.



Commercial Hinges



Description		Finish	2018 List	Stock No.	Box Qty.	Case Qty.
ECBB1101*	4-1/2" x 4-1/2"	US15	48.60	109275	3	48
Brass or Stainless Steel	(114 mm x 114 mm)	US32D	41.45	079555		
Full Mortise						
Standard Weight						
Ball Bearing						

* ECCO hinges are sold in box quantities only

* Other ECCO hinges available in 316 Stainless Steel. Contact Hager Companies Sales and Service for information.



ECBB1101 NRP*	4-1/2" x 4-1/2"	US15	50.85	109276	3	48
Brass or Stainless Steel	(114 mm x 114 mm)	US32D	43.80	079557		
Full Mortise		US32D/316SS	69.75	-		
Standard Weight						
Ball Bearing						



ECBB1102*	4-1/2" x 4-1/2"	USP	27.75	091900	3	24
Steel	(114 mm x 114 mm)	US15	57.75	109284		
Full Mortise		US26	57.75	119967		
Heavy Weight		US26D	34.40	091783		
Ball Bearing						
	5" x 4-1/2"	US15	59.90	130049	3	24
	(127 mm x 114 mm)	US26	59.90	140126		
		US26D	40.40	091638		



ECBB1102 NRP*	4-1/2" x 4-1/2"	USP	29.80	091866	3	24
Steel	(114 mm x 114 mm)	US15	60.15	109608		
Full Mortise		US26	60.15	127835		
Heavy Weight		US26D	36.75	091778		
Ball Bearing						
	5" x 4-1/2"	US15	62.20	132673	3	24
	(127 mm x 114 mm)	US26	62.20	125212		
		US26D	42.75	091618		



ECBB1103*	4-1/2" x 4-1/2"	US10B	107.70	091741	3	24
Brass or Stainless Steel	(114 mm x 114 mm)	US15	107.70	129146		
Full Mortise		US26	107.70	138809		
Heavy Weight		US32D	99.15	091731		
Ball Bearing						
	5" x 4-1/2"	US15	131.20	-	3	24
	(127 mm x 114 mm)	US26	131.20	-		
		US32D	126.95	091592		



ECBB1103 NRP*	4-1/2" x 4-1/2"	US10B	110.05	091732	3	24
Brass or Stainless Steel	(114 mm x 114 mm)	US26	110.05	-		
Full Mortise		US32D	101.50	091693		
Heavy Weight		US32D/316SS	145.50	169967		
Ball Bearing						
	5" x 4-1/2"	US15	133.50	-	3	24
	(127 mm x 114 mm)	US26	133.50	-		
		US32D	129.30	091593		





Description		Finish	2018 List	Stock No.	Box Qty.	Case Qty.
EC1105*	4-1/2" x 4-1/2"	USP	22.10	079571	3	48
Steel	(114 mm x 114 mm)	US3	45.00	079569		
Full Mortise		US4	39.25	079570		
Standard Weight		US10B	45.00	076318		
Spring Hinge		US15	45.00	109281		
		US26	45.00	109282		
		US26D	33.10	079567		

* ECCO hinges are sold in box quantities only

* Other ECCO hinges available in 316 Stainless Steel. Contact Hager Companies Sales and Service for information.



Commercial Hinges



Description	Finish	2018 List	Stock No.	Box Qty.	Case Qty.
BB1279 Drop Leaf Steel Full Mortise Standard Weight Ball Bearing NRP Standard Specify handling		4-1/2" x 4-1/2"	US26D	78.65	
BB1168 Drop Leaf Steel Full Mortise Heavy Weight Ball Bearing NRP Standard Specify handling		4-1/2" x 4-1/2"	US26D	126.05	
BB1191 Drop Leaf Stainless Steel Full Mortise Heavy Weight Ball Bearing NRP Standard Specify handling		4-1/2" x 4-1/2"	US32D	167.50	
BB1199 Drop Leaf Stainless Steel Full Mortise Heavy Weight Ball Bearing NRP Standard Specify handling		4-1/2" x 4-1/2"	US32D	250.55	
BB1279 Short Leaf Steel Full Mortise Standard Weight Ball Bearing Right Hand Standard Reversible to Left Hand		4-1/2" x 4-3/8"	US26D	78.65	
BB1168 Short Leaf Steel Full Mortise Heavy Weight Ball Bearing Right Hand Standard Reversible to Left Hand		4-1/2" x 4-3/8"	US26D	126.05	
BB1191 Short Leaf Stainless Steel Full Mortise Standard Weight Ball Bearing Right Hand Standard Reversible to Left Hand		4-1/2" x 4-3/8"	US32D	167.50	





Description	Finish	2018 List	Stock No.	Box Qty.	Case Qty.
BB1199 Short Leaf Stainless Steel Full Mortise Standard Weight Ball Bearing Right Hand Standard Reversible to Left Hand *NRP available upon request	4-1/2" x 4-3/8"	US32D		250.55	
BB1279 Unequal Leaf Centered Steel Full Mortise Standard Weight Ball Bearing NRP Standard Specify handing	5" x 4-1/2"	US26D		121.40	
BB1168 Unequal Leaf Centered Steel Full Mortise Heavy Weight Ball Bearing NRP Standard Specify handing	5" x 4-1/2"	US26D		171.90	
BB1191 Unequal Leaf Centered Stainless Steel Full Mortise Heavy Weight Ball Bearing NRP Standard Specify handing	5" x 4-1/2"	US32D		214.45	
BB1199 Unequal Leaf Centered Stainless Steel Full Mortise Heavy Weight Ball Bearing NRP Standard Specify handing	5" x 4-1/2"	US32D		313.80	

*Additional sizes, finishes, and hinges available. Contact Hager Customer Service for information.

1. Items with the price in **bold and red** are Quick Ship items and ship in 24 hours.
 Please use stock number when ordering. 2. U/M is each unless otherwise noted.





One Family. One Brand. One Vision.™

www.hagerco.com

TABLE OF CONTENTS

B	
Barn Door Hardware	
eConestoga Series Barn Door Hardware.....	20
Barn Door Privacy Lock.....	21
D	
Discount Groups	3
F	
Fast Riveted Pin.....	16
Finish	2
M	
Machine Screws	4
N	
Non-Removable Pin (Set Screw in Barrel).....	2
P	
Pins - Residential and Decorative Tips	19
R	
Residential Finish Symbols	2
S	
Safety Stud.....	13, 15, 19
Solid Brass or Stainless Steel.....	4-6, 11-12
Spring	6, 9-12
T	
Template Hinges.....	6, 9
W	
Wood Screws.....	17



Residential Hinges

RESIDENTIAL FINISH SYMBOLS

Not all products are available in all finishes. Contact Hager Sales and Service at 1-800-325-9995 for more specific information.

Non-Removable Pins (Medium Security)

Symbol	Description	List
NRP	Set screw in barrel	\$2.65 each

BHMA Symbol Base Material

US & HAGER	DESCRIPTION	STEEL	BRASS	STAINLESS STEEL
1D	Black	N/A	N/A	N/A
2D	Brass Tone Dichromate	N/A	N/A	N/A
3	Bright Brass	632	605	N/A
3LB	Light Brass	N/A	N/A	N/A
4	Satin Brass	633	606	N/A
10A	Antique Bronze - Lacquered	641	614	N/A
10R	Dark Bronze	N/A	N/A	N/A
15	Satin Nickel	646	619	N/A
26	Bright Chromium Plated	651	625	N/A
26D	Satin Chromium Plated	652	626	N/A
32	Stainless Steel Metal, Bright	N/A	N/A	629
32D	Stainless Steel Metal, Satin	N/A	N/A	630
P	Prime Coat - Beige	600	600	N/A
ABA/US5	Antique Brass	638	609	N/A
AN/15A	Antique Nickel	647	620	N/A

Note: For any finish not listed in this Price Book, price and availability on request.

LEAD TIMES

Items with prices in **bold** within this section are stock items and usually ship within 24 hours. Non-stock items will typically ship within 90 business days depending on seasonal volume and order complexity. The anticipated ship date will be included with each order acknowledgment.



RESIDENTIAL DISCOUNT GROUPS

GROUP	DESCRIPTION	DISC %
BB1541 - RCBB1541 - RCBB1542 (3.5)		
80M	3.5 - SS BB (32-32D)	_____
1741 - RC1741 - RC1842 (3.0, 3.5)		
81A	3.0, 3.5 - PB BOX (10A-ABA-AN-1D-26-26D-3)	_____
81C	3.0, 3.5 - PB BOX (10R-15)	_____
81G	3.0, 3.5 - PB BOX (2D-4-P-3LB)	_____
BB1741 - RCBB1741 - RCBB1842 (3.5)		
82A	3.5 - BB BOX (10A-ABA-AN-10R-1D-15-26-26D-3)	_____
82G	3.5 - BB BOX (2D-4-3LB)	_____
RC1641 - RC1841 - 7741 - 8741 (3.5)		
83A	3.5 - BULK (10A-ABA-AN-1D-26-26D-3)	_____
83C	3.5 - BULK (10R-15)	_____
83G	3.5 - BULK (2D-4-P-3LB)	_____
1541 - RC1541 - RC1542 (3.0, 3.5)		
86A	3.0, 3.5 - BRASS (10A-ABA-AN-10R-15-26-26D-3)	_____
86G	3.0, 3.5 - BRASS (4)	_____
86M	3.0, 3.5 - SS (32-32D)	_____
1750 - 1751 - 1752 (3.5)		
87A	3.5 - SPRING (10A-ABA-AN-1D-10R-15-26-26D-3)	_____
87G	3.5 - SPRING (2D-4-P-3LB)	_____
RC1748 (3.5)		
88A	3.5 - RC1748 (10A-ABA-AN-15-26-26D-3)	_____
88G	3.5 - RC1748 (2D-4-P-3LB)	_____
RCBB1841 (3.5)		
8CA	3.5 - BB BULK (AN-15-3-10R-26-26D-5)	_____
8CG	3.5 - BB BULK (2D-4)	_____
BB1543 (4.0)		
90A	4.0 - BRASS BB (10R-3-ABA-AN)	_____
90G	4.0 - BRASS BB (4)	_____
90M	4.0 - SS BB (32-32D)	_____





RCBB1841 (4.0)		
9CA	4.0 - BB BULK (10R-15)	_____

GROUP	DESCRIPTION	DISC %
1741 - RC1741 - 1842 (4.0)		
91A	4.0 - PB BOX (10A-ABA-AN-10R-1D-15-26-26D-H2H)	_____
91C	4.0 - PB BOX (10R-15)	_____
91G	4.0 - PB BOX (2D-4-P-3LB)	_____
RCBB1741 - RCBB1842 (4.0)		
92A	4.0 - BB BOX (10A-ABA-AN-10R-1D-26-26D-3)	_____
92G	4.0 - BB BOX (2D-4-P-3LB)	_____
RC1641 - RC1841 - RC8641 - RC8741 - RC8744 (4.0)		
93A	4.0 - BULK (10A-ABA-AN-1D-26-26D-3)	_____
93C	4.0 - BULK (10R - 15)	_____
93G	4.0 - BULK (2D-4-P-3LB)	_____
RC1542 - 1541 - RC1541 - RC1543 (4.0)		
96A	4.0 - BRASS (ABA-AN-10R-15-26-26D-3)	_____
96M	4.0 - SS (32-32D)	_____
1744 - 1750 - 1751 - 1752 - 1754 - 1760 - 1761 - 1762 - 1764 (4.0)		
97A	4.0 SPRING (10A-ABA-AN-10R-1D-15-26-26D-3)	_____
97G	4.0 SPRING (2D-4-P-3LB)	_____
97M	4.0 SPRING (32-32D)	_____
RC1749 (4.0)		
99A	4.0 - RC1749 (10A-ABA-15-26-26D-3-4-L2)	_____
99G	4.0 - RC1749 (2D-4-P-3LB)	_____
RC1846 - RC1847 (4.0)		
9AA	4.0 - FRP BOX (3)	_____
9AG	4.0 - FRP BOX (2D-P)	_____
RC1846 - RC1847 (4.0)		
9BA	4.0 - FRP BULK (10A-10R-ABA-AN-1D-3-15-26D)	_____
9BG	4.0 - FRP BULK (2D-P)	_____
RC1843 (4.0)		
9DA	4.0 - SECURITY BOX (10A-ABA-AN-15-26D-3-10R-26)	_____
9DG	4.0 - SECURITY BOX (2D-4)	_____
RC1843 (4.0)		
9EA	4.0 - SECURITY BULK (10R-15-26-26D-3-ABA-AN)	_____
9EG	4.0 - SECURITY BULK (2D-P-3LB)	_____
OTHER GROUP CODES		
701	RESIDENTIAL BULK SCREWS	_____
780	RESIDENTIAL AUXILIARY	_____



Residential Hinges



Description	Finish	2018 List	Stock No.	Box Qty.	Case Qty.	Disc. Code	
1340 Machine Screws UM - Pack of 400	10-24 x 1/2" FPHM with #9 Head	USP 33.63	095782	1 pack	10 packs	701	
		2D 33.63	095781				
		US3 33.63	095791				
		3LB 33.63	095792				
		US4 33.63	095795				
		ABA/US5 33.63	095796				
		US10A 33.63	095783				
		10R 33.63	095784				
		US15 33.63	095785				
		AN/US15A 33.63	095787				
	US26 33.63	095788					
	US26D 33.63	095789					
	1541 Solid Brass or Stainless Square Corner Full Mortise Residential Wt. Plain Bearing with Screws U/M - 1 each	3-1/2" x 3-1/2" (89 mm x 89 mm)	US3 15.24	030141	2 each	100 each	86A
			10R 15.24	032855			86A
		US15 15.24	031539			86A	
		US32 15.54	030144			86M	
		US32D 15.54	030146			86M	
	4" x 4" (102 mm x 102 mm)	US3 17.72	030149	2 each	50 each	96A	
		10R 17.72	033204			96A	
		US15 17.72	035737			96A	
		US32 18.02	030152			96M	
		US32D 18.02	030153			96M	
	BB1541 Stainless Square Corner Full Mortise Residential Wt. Ball Bearing with Screws U/M - 1 each	3-1/2" x 3-1/2" (89 mm x 89 mm)	US32D 20.26	034377	2 each	100 each	80M
		4" x 4" (102 mm x 102 mm)	US32D 22.38	034534	2 each	50 each	90M
	RC1541 Solid Brass or Stainless 1/4" Radius Round Corner Full Mortise Residential Weight Plain Bearing with Screws U/M - 1 each	3-1/2" x 3-1/2" (89 mm x 89 mm)	US3 15.24	030229	2 each	100 each	86A
			10R 15.24	034358			86A
			US15 15.24	033818			86A
			US26D 15.24	030227			86A
		US32D 15.54	030232			86M	
	4" x 4" (102 mm x 102 mm)	US3 17.72	033004	2 each	50 each	96A	
		10R 17.72	035343			96A	
		US15 17.72	034837			96A	
		US26D 17.72	033003			96A	
		US32D 18.02	033008			96M	
	RCBB1541 Stainless 1/4" Radius Full Mortise Residential Wt. Ball Bearing with Screws U/M - 1 each	3-1/2" x 3-1/2" (89 mm x 89 mm)	US32D 20.26	034378	2 each	100 each	80M
		4" x 4" (102 mm x 102 mm)	US32D 22.38	034587	2 each	50 each	90M





Description	Finish	2018 List	Stock No.	Box Qty.	Case Qty.	Disc. Code		
RC1542 Solid Brass or Stainless 5/8" Radius Round Corner Full Mortise Residential Wt. Plain Bearing with Screws U/M - 1 each	3-1/2" x 3-1/2" (89 mm x 89 mm)	US3	15.24	030276	2 each	100 each	86A	
		US4	15.24	030291			86G	
		10R	15.24	036081			86A	
		US15	15.24	035594			86A	
		US26D	15.24	030275			86A	
		US32	15.54	030288			86M	
		US32D	15.54	030289			86M	
		4" x 4" (102 mm x 102 mm)	US3	17.72	033051	2 each	50 each	96A
			10R	17.72	036761			96A
			US15	17.72	035743			96A
		US26D	17.72	033050			96A	
		US32	18.02	033053			96M	
		US32D	18.02	033056			96M	
RCBB1542 Stainless 5/8" Radius Round Corner Full Mortise Residential Wt. Ball Bearing with Screws U/M - 1 each	3-1/2" x 3-1/2" (89 mm x 89 mm)	US32D	20.26	034381	2 each	100 each	80M	
	4" x 4" (102 mm x 102 mm)	US32D	22.38	034589	2 each	50 each	90M	
1543 Solid Brass or Stainless Square by 5/8" Radius Full Mortise Residential Wt. Plain Bearing with Screws U/M - 1 each	4" x 4" (102 mm x 102 mm)	US3	17.72	071461	2 each	50 each	96A	
		10R	17.72	036911			96A	
		US15	17.72	071462			96A	
		US32D	18.02	071531			96M	
BB1543 Solid Brass or Stainless Square by 5/8" Radius Full Mortise Residential Wt. Ball Bearing with Screws U/M - 1 each	4" x 4" (102 mm x 102 mm)	US3	22.80	071637	2 each	50 each	90A	
		10R	22.80	036980			90A	
		US32D	22.38	071552			90M	
1734 Stainless Steel 1/4" Radius Round Corner Full Mortise Spring Hinge Template Timely Frame All MS 1/2 WS U/M -1 each	4" x 4" (102 mm x 102 mm)	US32D	45.24	169906	2 each	80 each	97M	



1. Items with prices in **bold** are stock items and usually ship within 24 hours. Please use stock number when ordering.
 2. Minimum order quantity is one box unless otherwise noted.



Residential Hinges



Description	Finish	2018 List	Stock No.	Box Qty.	Case Qty.	Disc. Code		
1741 Steel Square Corner Full Mortise Residential Wt. Plain Bearing - with Screws U/M - 1 each	3" x 3" (76 mm x 76 mm)	USP	2.18	029648	2 each	100 each	81G	
		2D	2.18	029641			81G	
		US3	6.23	033133			81A	
		US10A	6.23	033129			81A	
		US26	6.23	033131			81A	
		US26D	6.23	033132			81A	
		3-1/2" x 3-1/2" (89 mm x 89 mm)	USP	2.18			029661	81G
		1D	6.23	030556			81A	
		2D	1.94	029658			81G	
		US3	6.23	030533			81A	
		3LB	2.18	029660			81G	
		US4	2.18	029659			81G	
		ABA/US5	6.23	030552			81A	
	US10A	6.23	030548	81A				
	10R	6.23	037124	81C				
	US15	6.23	030555	81C				
	AN/US15A	6.23	030620	81A				
	US26	6.23	030547	81A				
	US26D	6.23	030551	81A				
4" x 4" (102 mm x 102 mm)	USP	3.21	029667	2 each	50 each	91G		
	1D	7.38	033144			91A		
	2D	3.21	029662			91G		
	US3	7.38	033148			91A		
	US4	3.21	029664			91G		
	ABA/US5	7.38	033197			91A		
	US10A	7.38	033141			91A		
	10R	7.38	038067			91C		
	US15	7.38	032829			91C		
	AN/US15A	7.38	033199			91A		
	US26	7.38	033145			91A		
	US26D	7.38	033146			91A		
	BB1741 Steel Square Corner Ball Bearing Hinges Full Mortise Residential Wt. with Screws U/M - 1 each	3-1/2" x 3-1/2" (89 mm x 89 mm)	US3			10.46	034274	2 each
		US4	6.41	034337	82G			
		ABA/US5	6.41	034332	82A			
		US10A	10.46	034330	82A			
		10R	10.46	040217	82A			
		US15	10.46	034333	82A			
		AN/US15A	10.46	034334	82A			
		US26	10.46	034275	82A			
		US26D	10.46	034329	82A			
		4" x 4" (102 mm x 102 mm)	2D	7.44	034500	92G		
		US3	11.55	034474	92A			
		US4	7.44	034502	92G			
		ABA/US5	11.55	034497	92A			
	US10A	11.55	034483	92A				
	10R	11.55	040724	92A				
	US15	11.55	034498	92A				
	AN/US15A	11.55	034499	92A				
	US26	11.55	034477	92A				
	US26D	11.55	034482	92A				





Description	Finish	2018 List	Stock No.	Box Qty.	Case Qty.	Disc. Code
RC1741						
3" x 3"	USP	2.18	029677	2 each	100 each	81G
Steel (76 mm x 76 mm)	2D	2.18	029673			81G
1/4" Radius	US3	6.23	033512			81A
Round Corner	US4	2.18	029675			81G
Full Mortise	ABA/US5	6.23	032869			81A
Residential Wt.	US26D	6.23	032859			81A
Plain Bearing with screws						
U/M - 1 each						
3-1/2" x 3-1/2"	USP	2.18	029683	2 each	100 each	81G
(89 mm x 89 mm)	1D	6.23	030680			81A
	2D	2.18	029678			81G
	US3	6.23	030644			81A
	3LB	2.18	029475			81G
	US4	2.18	029681			81G
	ABA/US5	6.23	030648			81A
	US10A	6.23	030645			81A
	10R	6.23	041116			81C
	US15	6.23	030652			81C
	AN/US15A	6.23	030689			81A
	US26	6.23	030646			81A
	US26D	6.23	030647			81A
4" x 4"	USP	3.21	029707	2 each	50 each	91G
(102 mm x 102 mm)	1D	7.38	032881			91A
	2D	3.21	029695			91G
	US3	7.38	033267			91A
	US4	3.21	029698			91G
	ABA/US5	7.38	033523			91A
	US10A	7.38	033514			91A
	10R	7.38	041269			91C
	US15	7.38	032876			91C
	AN/US15A	7.38	032882			91A
	US26	7.38	033262			91A
	US26D	7.38	033265			91A

1. Items with prices in **bold** are stock items and usually ship within 24 hours. Please use stock number when ordering.
 2. Minimum order quantity is one box unless otherwise noted.



Residential Hinges



Description	Finish	2018 List	Stock No.	Box Qty.	Case Qty.	Disc. Code	
RC1741	3-1/2" x 3-1/2"	USP	2.00	029477	-	100 each	83G
Steel	(89 mm x 89 mm)	1D	5.75	031633			83A
1/4" Radius		2D	2.00	029472			83G
Round Corner		US3	5.75	030706			83A
Full Mortise		3LB	2.00	029682			83G
Residential Wt.		US4	2.00	029474			83G
Plain Bearing		ABA/US5	5.75	030715			83A
Bulk Assembled		10R	5.75	041197			83C
See style #2617 & #2817 for screws		US15	5.75	030710			83C
U/M - Each - Bulk		AN/US15A	5.75	030716			83A
		US26	5.75	030714			83A
		US26D	5.75	030708			83A
<hr/>							
	4" x 4"	USP	2.90	029569	-	100 each	93G
	(102 mm x 102 mm)	1D	6.77	032697			93A
		2D	2.90	029565			93G
		US3	6.77	033519			93A
		3LB	2.90	029568			93G
		US4	2.90	029566			93G
		US10A	6.77	033600			93A
		10R	6.77	041270			93C
		US15	6.77	032877			93C
		AN/US15A	6.77	081352			93A
		US26	6.77	038957			93A
		US26D	6.77	033602			93A
<hr/>							
RCBB1741	3-1/2" x 3-1/2"	1D	10.46	079451	2 each	100 each	82A
Steel	(89 mm x 89 mm)	US3	10.46	034346			82A
1/4" Radius		US4	6.41	034361			82G
Round Corner		ABA/US5	10.46	034352			82A
Full Mortise		10R	10.46	038241			82A
Residential Wt.		US15	10.46	034353			82A
Ball Bearing with screws		AN/US15A	10.46	034355			82A
U/M - 1 each		US26	10.46	034348			82A
		US26D	10.46	034349			82A
<hr/>							
	4" x 4"	1D	11.55	079453	2 each	50 each	92G
	(102 mm x 102 mm)	2D	7.44	034512			92G
		US3	11.55	034504			92A
		US4	7.44	034514			92G
		ABA/US5	11.55	034509			92A
		US10A	11.55	034508			92A
		10R	11.55	040073			92A
		US15	11.55	034510			92A
		AN/US15A	11.55	034511			92A
		US26	11.55	034506			92A
		US26D	11.55	034507			92A





Description	Finish	2018 List	Stock No.	Box Qty.	Case Qty.	Disc. Code
1744						
Steel	USP	19.17	169928	2 each	80 each	97G
1/4" Radius	2D	19.17	169912			97G
Round Corner	US3	31.39	169913			97A
Full Mortise	US4	19.17	169915			97A
Residential Wt.	ABA/US5	31.39	169917			97A
Spring Hinge	US10A	31.39	169907			97A
Template	US26	31.39	169909			97A
All MS - 1/2 WS	US26D	31.39	169911			97A
U/M - 1 each						



RC1748						
Steel	2D	2.30	029724	2 each	100 each	88G
1/4" Radius	US3	6.23	030693			88A
Round Corner	3LB	2.30	029726			88G
Full Mortise	US4	2.30	029725			88G
Residential Wt.	US10A	6.23	030698			88A
Plain Bearing	10R	6.23	016929			88A
Template	US15	6.23	016936			88A
All MS - 1/2 WS	US26D	6.23	030695			88A
U/M - 1 each						

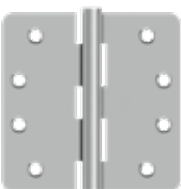

RC1749						
Steel	2D	4.72	029731	3 each	48 each	99G
1/4" Radius	US3	7.38	033529			99A
Round Corner	3LB	4.72	029734			99G
Full Mortise	US4	4.72	029732			99G
Residential Wt.	ABA/US5	7.38	032889			99A
Plain Bearing	US10A	7.38	032887			99A
Template	10R	7.38	016902			99A
AMS - 1/2 WS	US15	7.38	016897			99A
U/M - 1 each	US26	7.38	033524			99A
	US26D	7.38	033528			99A

1. Items with prices in **bold** are stock items and usually ship within 24 hours. Please use stock number when ordering.
 2. Minimum order quantity is one box unless otherwise noted.



Residential Hinges



Description	Finish	2018 List	Stock No.	Box Qty.	Case Qty.	Disc. Code	
1750	3-1/2" x 3-1/2"	USP	17.90	170018	2 each	80 each	87G
Steel	(89 mm x 89 mm)	1D	23.83	169977			87G
Square Corner		2D	17.90	169982			87G
Full Mortise		US3	23.83	169983			87A
Residential Wt.		3LB	17.90	169986			87G
Spring Hinge with Screws		US4	17.90	169985			87G
ALL WS		ABA/US5	23.83	169988			87A
U/M - 1 each		US10A	23.83	169971			87A
		10R	23.83	169973			87A
		US15	23.83	169974			87A
		AN/US15A	23.83	170017			87A
		US26	23.83	169979			87A
		US26D	23.83	169981			87A
	4" x 4"	USP	19.17	170046	2 each	80 each	97G
	(102 mm x 102 mm)	2D	19.17	170033			97G
		US3	31.39	170035			97A
		3LB	19.17	170037			97G
		US4	19.17	170040			97G
		ABA/US5	31.39	170043			97A
		US10A	31.39	170019			97A
		10R	31.39	170020			97A
		US15	31.39	170021			97A
		AN/US15A	31.39	170044			97A
		US26	31.39	170023			97A
		US26D	31.39	170031			97A



1751	3-1/2" x 3-1/2"	USP	17.90	170220	2 each	80 each	87G
Steel	(89 mm x 89 mm)	1D	23.83	170204			87A
1/4" Radius		2D	17.90	170206			87G
Round Corner		US3	23.83	170207			87A
Full Mortise		US4	17.90	170215			87G
Residential Wt.		ABA/US5	23.83	170217			87A
Spring Hinge with Screws		US10A	23.83	170200			87A
ALL WS		10R	23.83	170202			87A
U/M - 1 each		US15	23.83	170203			87A
		AN/US15A	23.83	170218			87A
		US26D	23.83	170205			87A
	4" x 4"	USP	19.17	170239	2 each	80 each	97G
	(102 mm x 102 mm)	1D	31.39	170226			97A
		2D	19.17	170230			97G
		US3	31.39	170233			97A
		3LB	19.17	170234			97G
		US4	19.17	170235			97G
		ABA/US5	31.39	170236			97A
		US10A	31.39	170223			97A
		10R	31.39	170224			97A
		US15	31.39	170225			97A
		AN/US15A	31.39	170237			97A
		US26	31.39	170228			97A
		US26D	31.39	170229			97A

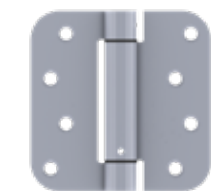

Description	Finish	2018 List	Stock No.	Box Qty.	Case Qty.	Disc. Code
1752						
3-1/2" x 3-1/2"	USP	17.90	170428	2 each	80 each	87G
Steel	1D	23.83	170245			87A
5/8" Radius	2D	17.90	170418			87G
Round Corner	US3	23.83	170419			87A
Full Mortise	3LB	17.90	170420			87G
Residential Wt.	US4	17.90	170421			87G
Spring Hinge with Screws	ABA/US5	23.83	170423			87A
ALL WS	US10A	23.83	170242			87A
U/M - 1 each	10R	23.83	170243			87A
	US15	23.83	170244			87A
	AN/US15A	23.83	170427			87A
	US26	23.83	170246			87A
	US26D	23.83	170417			87A
4" x 4"	USP	19.17	170480	2 each	80 each	97G
(102 mm x 102 mm)	1D	31.39	170453			97A
	2D	19.17	170457			97G
	US3	31.39	170458			97A
	3LB	19.17	170459			97G
	US4	19.17	170460			97G
	ABA/US5	31.39	170461			97A
	US10A	31.39	170430			97A
	10R	31.39	170451			97A
	US15	31.39	170452			97A
	AN/US15A	31.39	170479			97A
	US26	31.39	170454			97A
	US26D	31.39	170455			97A
1754						
4" x 4"	USP	19.17	170494	2 each	80 each	97G
(102 mm x 102 mm)	1D	31.39	170483			97G
Square by 5/8" Radius	2D	19.17	170486			97G
Full Mortise	US3	31.39	170487			97A
Residential Wt.	3LB	19.17	170488			97G
Spring Hinge with Screws	US4	19.17	170489			97A
ALL WS	ABA/US5	31.39	170490			97G
U/M - 1 each	10R	31.39	170481			97A
	US15	31.39	170482			97A
	AN/US15A	31.39	170491			97A
	US26	31.39	170484			97A
	US26D	31.39	170485			97A
1760						
4" x 4"	US32	45.24	170495	2 each	80 each	97M
(102 mm x 102 mm)	US32D	45.24	170497			
Stainless Steel						
Square Corner						
Full Mortise						
Residential Wt.						
Spring Hinge with Screws						
ALL WS						
U/M - 1 each						



1. Items with prices in **bold** are stock items and usually ship within 24 hours. Please use stock number when ordering.
 2. Minimum order quantity is one box unless otherwise noted.



Residential Hinges



Description	Finish	2018 List	Stock No.	Box Qty.	Case Qty.	Disc. Code
1761 Stainless Steel 4" x 4" (102 mm x 102 mm) 1/4" Radius Round Corner Full Mortise Residential Wt. Spring Hinge with Screws ALL WS U/M -1 each	US32 US32D	45.24 45.24	170513 170514	2 each	80 each	97M



1762 Stainless Steel 4" x 4" (102 mm x 102 mm) 5/8" Radius Round Corner Full Mortise Residential Wt. Spring Hinge with Screws ALL WS U/M - 1 each	US32 US32D	45.24 45.24	170515 170516	2 each	80 each	97M
--	---------------	----------------	------------------	--------	---------	-----



1764 Stainless Steel 4" x 4" (102 mm x 102 mm) Square by 5/8" Radius Full Mortise Residential Wt. Spring Hinge with Screws ALL WS U/M - 1 each	US32 US32D	45.24 45.24	170517 170519	2 each	80 each	97M
--	---------------	----------------	------------------	--------	---------	-----



1816 Steel 4" x 4" (102 mm x 102 mm) Square by 5/8" Radius Full Mortise Residential Wt. Plain Bearing Bulk Assembled Right Hand See style #2817 for Screws U/M - Each - Bulk	USP 1D 2D US3 3LB ABA/US5 10R US15 AN/US15A US26 US26D	2.90 6.77 6.77 6.77 2.90 6.77 6.77 6.77 6.77 6.77 6.77 6.77	069042 089461 069009 069142 069010 069097 041716 069140 069099 069127 069134	-	100 each	93G 93A 93G 93A 93G 93A 93C 93C 93A 93A 93A
---	--	--	--	---	----------	---



BB1816 Steel 4" x 4" (102 mm x 102 mm) Square by 5/8" Radius Full Mortise Residential Wt. Ball Bearing with screws Right Hand U/M - 1 each	2D US3 US4 ABA/US5 US10A 10R US15 AN/US15A US26D	7.44 11.55 7.44 11.55 11.55 11.55 11.55 11.55 11.55 11.55	069166 070306 070312 070258 070188 041717 070289 070273 070311	2 each	50 each	92G 92A 92G 92A 92A 92A 92A 92A 92A 92A
--	--	--	--	--------	---------	--



Description	Finish	2018 List	Stock No.	Box Qty.	Case Qty.	Disc. Code	
1817	4" x 4"	USP	2.90	070416	-	100 each	93G
Steel	(102 mm x 102 mm)	1D	6.77	089462			93A
Square by 5/8" Radius		2D	2.90	070403			93G
Full Mortise		US3	6.77	070496			93A
Residential Wt.		3LB	2.90	070417			93G
Plain Bearing		ABA/US5	6.77	070445			93A
Bulk Assembled Left Hand		10R	6.77	041719			93C
See style #2817 for Screws		US15	6.77	070459			93C
U/M - Each - Bulk		AN/US15A	6.77	070453			93A
		US26D	6.77	070476			93A

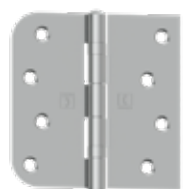

BB1817	4" x 4"	2D	7.44	070498	2 each	50 each	92G
Steel	(102 mm x 102 mm)	US3	11.55	070604			92A
Square by 5/8" Radius		US4	7.44	070612			92G
Full Mortise		ABA/US5	11.55	070534			92A
Residential Wt.		10R	11.55	041720			92A
Ball Bearing with screws		US15	11.55	070562			92A
Left Hand		AN/US15A	11.55	070556			92A
U/M - 1 each		US26D	11.55	070580			92A



1818	4" x 4"	USP	4.17	070634	-	100 each	9EG
Steel	(102 mm x 102 mm)	2D	4.17	070619			9EG
Square by 5/8" Radius		3LB	4.17	070665			9EG
Full Mortise		10R	9.19	095609			9EG
Residential Wt.		US15	9.19	070745			9EA
Plain Bearing		AN/US15A	9.19	070738			9EA
Bulk Assembled Right Hand		US26D	9.19	070767			9EA
Safety Stud							
See style #2817 for screws							
U/M - Each - Bulk							



1819	4" x 4"	USP	4.17	070900	-	100 each	9EG
Steel	(102 mm x 102 mm)	2D	4.17	070835			9EG
Square by 5/8" Radius		3LB	4.17	070922			9EG
Full Mortise		10R	9.19	095611			9EA
Residential Wt.		US15	9.19	070942			9EA
Plain Bearing		US26D	9.19	070971			9EA
Bulk Assembled Left Hand							
Safety Stud							
See style #2817 for screws							
U/M - Each - Bulk							

1. Items with prices in **bold** are stock items and usually ship within 24 hours. Please use stock number when ordering.
 2. Minimum order quantity is one box unless otherwise noted.



Residential Hinges



Description	Finish	2018 List	Stock No.	Box Qty.	Case Qty.	Disc. Code		
RC1841 Steel 5/8" Radius Round Corner Full Mortise Residential Wt. Plain Bearing Bulk Assembled with Screws See style #2617 & #2817 for screws U/M - Each - Bulk	3-1/2" x 3-1/2" (89 mm x 89 mm)	USP	2.00	027745	-	100 each	83G	
	1D	5.75	030728			83A		
	2D	2.00	027355			83G		
	US3	5.75	030718			83A		
	3LB	2.00	027360			83G		
	US4	2.00	027526			83G		
	ABA/US5	5.75	030724			83A		
	US10A	5.75	030721			83A		
	10R	5.75	042004			83C		
	US15	5.75	030727			83C		
	AN/US15A	5.75	030842			83A		
	US26	5.75	030719			83A		
	US26D	5.75	030720			83A		
	4" x 4" (102 mm x 102 mm)	USP	2.90	028287	-	100 each	93G	
		1D	6.77	033643			93A	
		2D	2.90	027771			93G	
		US3	6.77	033308			93A	
3LB		2.90	027995			93G		
US4		2.90	027996			93G		
ABA/US5		6.77	033537			93A		
US10A		6.77	033533			93A		
10R		6.77	042005			93C		
US15		6.77	032893			93C		
AN/US15A		6.77	033565			93A		
US26		6.77	033535			93A		
US26D		6.77	033307			93A		
RC1842 Steel 5/8" Radius Round Corner Full Mortise Residential Wt. Plain Bearing with screws U/M - 1 each		3-1/2" x 3-1/2" (89 mm x 89 mm)	USP	2.18	029759	2 each	100 each	81G
		1D	6.23	030857			81A	
		2D	2.18	029756			81G	
		US3	6.23	030851			81A	
	3LB	2.18	029847			81G		
	US4	1.94	029757			81G		
	ABA/US5	6.23	030853			81A		
	US10A	6.23	030843			81A		
	10R	6.23	042009			81C		
	US15	6.23	030856			81C		
	AN/US15A	6.23	030859			81A		
	US26	6.23	030845			81A		
	US26D	6.23	030846			81A		
	4" x 4" (102 mm x 102 mm)	USP	3.21	029774	2 each	50 each	91G	
		1D	7.38	032899			91A	
		2D	3.21	029769			91G	
		US3	7.38	033312			91A	
3LB		3.21	029771			91G		
US4		3.21	029770			91G		
ABA/US5		7.38	033313			91A		
US10A		7.38	033309			91A		
10R		7.38	042010			91C		
US15		7.38	032898			91C		
AN/US15A		7.38	033314			91A		
US26		7.38	033310			91A		
US26D		7.38	033311			91A		









Description	Finish	2018 List	Stock No.	Box Qty.	Case Qty.	Disc. Code		
RCBB1842 Steel 5/8" Radius Round Corner Full Mortise Residential Wt. Ball Bearing with screws U/M - 1 each	3-1/2" x 3-1/2" (89 mm x 89 mm)	1D	10.46	084215	2 each	100 each	82A	
		US3	10.46	034363			82A	
		3LB	6.41	034375			82G	
		US4	6.41	034374			82G	
		ABA/US5	10.46	034367			82A	
		US10A	10.46	034366			82A	
		10R	10.46	042006			82A	
		US15	10.46	034370			82A	
		AN/US15A	10.46	034371			82A	
		US26	10.46	034364			82A	
		US26D	10.46	034365			82A	
	4" x 4" (102 mm x 102 mm)	1D	11.55	084231	2 each	50 each	92A	
		2D	7.44	034526			92G	
		US3	11.55	034515			92A	
3LB		7.44	034528			92G		
US4		7.44	034527			92G		
ABA/US5		11.55	034520			92A		
US10A		11.55	034519			92A		
10R		11.55	042007			92A		
US15		11.55	034523			92A		
AN/US15A		11.55	034524			92A		
US26		11.55	034516			92A		
US26D		11.55	034518			92A		
RC1843 Steel 5/8" Radius Round Corner Full Mortise Residential Wt. Plain bearing with screws Safety Stud U/M - 1 each		4" x 4" (102 mm x 102 mm)	2D	4.11	033648	2 each	50 each	9DG
			US3	9.19	033649			9DA
		3LB	4.11	081897			9DG	
		US4	4.11	081896			9DG	
		ABA/US5	9.19	036149			9DA	
		US10A	9.19	081890			9DA	
		10R	9.19	042014			9DA	
		US15	9.19	081894			9DA	
		AN/US15A	9.19	081898			9DA	
		US26	9.19	081895			9DA	
		US26D	9.19	037158			9DA	
	RC1843 Steel 5/8" Radius Round Corner Full Mortise Residential Wt. Bulk Assembled with screws See style #2817 Safety Stud U/M - Each - Bulk	4" x 4" (102 mm x 102 mm)	USP	4.17	033589	-	100 each	9EG
			2D	4.17	033588			9EG
			US3	9.19	037028			9EA
		ABA/US5	9.19	126538			9EA	
		10R	9.19	129302			9EA	
		US15	9.19	126539			9EA	
		AN/US15A	9.19	126540			9EA	
		US26	9.19	126536			9EA	
		US26D	9.19	126537			9EA	
RC1846 Steel 5/8" Radius Round Corner Full Mortise Residential Wt. Plain Bearing with screws Riveted Pin U/M - 1 each		4" x 4" (102 mm x 102 mm)	2D	4.66	033651	2 each	50 each	9AG
		US3	12.04	033844			9AA	
		US26D	12.04	033843			9AA	

1. Items with prices in **bold** are stock items and usually ship within 24 hours. Please use stock number when ordering.
2. Minimum order quantity is one box unless otherwise noted.

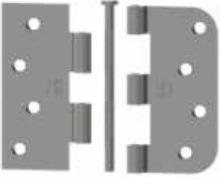

Residential Hinges

	Description	Finish	2018 List	Stock No.	Box Qty.	Case Qty.	Disc. Code	
	RC1846	4" x 4" (102 mm x 102 mm)	USP	4.66	029580	-	100 each	9BG
	Steel		2D	4.66	029576			9BG
	5/8" Radius		US3	8.59	037092			9BA
	Round Corner		3LB	4.66	029579			9BG
	Full Mortise		US4	4.66	029578			9BG
	Residential Wt.		10R	8.59	042015			9BA
	Plain Bearing		US15	8.59	081371			9BA
	Bulk assembled with screws		AN/US15A	8.59	081370			9BA
	See style #2817 for screws		US26	8.59	084250			9BA
	Riveted Pin		US26D	8.59	083473			9BA
	U/M - Each - Bulk		1D	8.59	082049			9BA
		RC1847	4" x 4" (102 mm x 102 mm)	USP	4.66	033658	2 each	50 each
Steel			2D	4.66	033654			9AG
Square by 5/8" Radius			US3	12.04	037777			9AA
Full Mortise								
Residential Wt.								
	RC1847	4" x 4" (102 mm x 102 mm)	USP	4.66	033590	-	100 each	9BG
	Steel		2D	4.66	033594			9BG
	Square by 5/8" Radius		US3	8.59	084253			9BA
	Full Mortise		ABA/US5	8.59	084254			9BA
	Residential Wt.		US10A	8.59	084255			9BA
	Bulk Assembled with screws		10R	8.59	042017			9BA
	See style #2817 for screws		US15	8.59	084258			9BA
	Riveted Pin		AN/US15A	8.59	084259			9BA
U/M - Each - Bulk		US26D	8.59	084261			9BA	
	1848	4" x 4" (102 mm x 102 mm)	US3	7.38	068746	2 each	50 each	91A
	Steel		ABA/US5	7.38	067438			91A
	Unassembled		US10A	7.38	068789			91A
	Square by 5/8" Radius		10R	7.38	042019			91C
	Full Mortise		US15	7.38	068735			91C
	Residential Wt.		AN/US15A	7.38	068713			91A
	Plain Bearing with screws		US26D	7.38	068734			91A
	U/M - 1 each							
	2617	#9 x 3/4" FPHS	USP	42.82	035459	1 pack	10 packs	701
	Screws for Residential Hinges		1D	35.40	034111			
	UM - Pack of 600		2D	35.40	034108			
			3LB	35.40	029794			
			US3	35.40	034109			
			US4	35.40	029793			
			ABA/US5	35.40	033323			
			US10A	35.40	033320			
			10R	35.40	042098			
			US15	35.40	033321			
			AN/US15A	35.40	033324			
			US26	35.40	033322			
		US26D	35.40	034110				



Description	Finish	2018 List	Stock No.	Box Qty.	Case Qty.	Disc. Code	
2817 Screws for Residential Hinges UM - Pack of 800	#9 x 3/4" FPHS	USP	47.20	033385	1 pack	10 packs	701
		1D	47.20	034124			
		2D	47.20	034129			
		3LB	47.20	039796			
		US3	47.20	033384			
		US4	47.20	029795			
		ABA/US5	47.20	034126			
		US10A	47.20	034303			
		10R	47.20	042099			
		US15	47.20	034302			
		AN/US15A	47.20	034123			
		US26	47.20	033327			
		US26D	47.20	033329			
	#9 X 1" FPHS	USP	51.05	033386	1 pack	10 packs	701
		1D	51.05	037331			
2D		51.05	035480				
3LB		51.05	029798				
US3		51.05	033387				
US4		51.05	029797				
ABA/US5		51.05	035550				
US10A		51.05	035461				
10R		51.05	042100				
US15		51.05	036448				
AN/US15A		51.05	035556				
US26		51.05	035582				
US26D		51.05	033388				
#9 x 2-1/2" FPHS		USP	67.45	048598	1 pack	-	701
#10 x 2-1/2" FPHS		2D	67.45	048601	1 pack	-	701
7741 Steel 1/4" Radius Round Corner Full Mortise Residential Wt. Plain Bearing See style #2617 & #2817 for screws Bulk Unassembled with pins U/M - Each - Bulk	3-1/2" x 3-1/2" (89 mm x 89 mm)	2D	2.00	029502	-	100 each	83G
		3LB	2.00	029508			83G
		US4	2.00	029504			83G
		10R	5.75	021624			83C
		US15	5.75	050813			83C
		AN/US15A	5.75	050817			83A
		US26	5.75	030864			83A
		US26D	5.75	030867			83A
	4" x 4" (102 x 102 mm)	2D	2.84	029585	-	100 each	93G
		US3	6.77	033751			93A
		3LB	2.84	029603			93G
		US4	2.84	029586			93G
		10R	6.77	015750			93C
		US15	6.77	050204			93C
		AN/US15A	6.77	051297			93A
	US26	6.77	033750			93A	
	US26D	6.77	075057			93A	



1. Items with prices in **bold** are stock items and usually ship within 24 hours. Please use stock number when ordering.
 2. Minimum order quantity is one box unless otherwise noted.



Residential Hinges

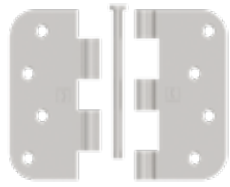

Description	Finish	2018 List	Stock No.	Box Qty.	Case Qty.	Disc. Code		
8741 Steel 5/8" Radius Round Corner Full Mortise Residential Wt. Plain Bearing Bulk Unassembled with pins See style #2617 & #2817 for screws U/M - Each - Bulk	3-1/2" x 3-1/2" (89 mm x 89 mm)	USP	2.00	029500	-	100 each	83G	
		2D	2.00	029486			83G	
		3LB	2.00	029497			83G	
		US4	5.75	029490			83G	
		ABA/US5	5.75	030964			83A	
		10R	5.75	175354			83A	
		US15	5.75	030953			83C	
		US26D	5.75	030962			83A	
		4" x 4" (102 mm x 102 mm)	2D	2.90	029621	-	100 each	93G
		US4	2.90	029622			93G	
		10R	6.77	066186			93C	
		US15	6.77	066183			93C	
		US26D	6.77	035794			93A	
8744 Steel Square by 5/8" Radius Full Mortise Residential Wt. Plain Bearing Bulk Unassembled with pins See style #2817 for screws U/M - Each - Bulk	4" x 4" (102 mm x 102 mm)	USP	2.90	029639	-	100 each	93G	
		2D	2.90	029630			93G	
		US3	6.77	036142			93A	
		3LB	2.90	039636			93G	
		US4	6.77	029631			93G	
		US10A	6.77	084235			93A	
		10R	6.77	042101			93C	
		US15	6.77	080130			93C	
		AN/US15A	6.77	084237			93A	
		US26D	6.77	036148			93A	
8746 Steel Square by 5/8" Radius Full Mortise Residential Wt. Plain Bearing Safety Stud Bulk Unassembled with pins See style #2817 for screws U/M - Each - Bulk	4" x 4" (102 mm x 102 mm)	USP	4.17	068828	-	100 each	9EG	
		2D	4.17	068819			9EG	
		US4	4.17	068989			9EG	
		ABA/US5	9.19	068910			9EA	
		US15	9.19	068929			9EA	
		US26D	9.19	038964			9EA	
		10R	9.19	195609			9EA	
		1D	9.19	195610			9EA	
1700 Pins for Residential Wt. Plain Bearing Hinges Sold full box qty U/M - 1 Each	3-1/2" (89 mm)	2D	0.79	038152	100 each	1000 each	900	
		US15	0.79	038173				
		US26D	0.79	038174				
	4" (102 mm)	2D	0.79	038153	100 each	1000 each	900	
		US15	0.79	038166				
		US26D	0.79	038175				





Description		Finish	2018 List	Stock No.	Box Qty.	Case Qty.	Disc. Code
1710	3-1/2" (89 mm)	US3	13.06	042118	10 packs	100 packs	780
Hinge Tip Kit		US4	13.06	058503			
2 Ball Tips in Solid Brass with 1		ABA/US5	13.06	058500			
Stainless Steel Pin for One		US10A	13.06	058506			
Residential Wgt.		10R	13.06	097381			
HingeU/M - Pack of 1 each		US15	13.06	037713			
		AN/US15A	13.06	037940			
		US26	13.06	058559			
		US26D	13.06	058502			
	4" (102 mm)	US3	13.06	042129	10 packs	100 packs	780
		US4	13.06	058965			
		ABA/US5	13.06	058957			
		US10A	13.06	058973			
		10R	13.06	097383			
		US15	13.06	037848			
		AN/US15A	13.06	037905			
		US26	13.06	058974			
		US26D	13.06	058960			
1720	3-1/2" (89 mm)	US3	13.06	042134	10 packs	100 packs	780
Hinge Tip Kit		US4	13.06	058577			
2 Steeple Tips in Solid Brass		ABA/US5	13.06	058579			
with 1 Stainless Steel Pin for		10R	13.06	097693			
One Residential Wgt. Hinge		US15	13.06	038014			
U/M - Pack of 1 each		US26	13.06	058575			
	4" (102 mm)	US3	13.06	042132	10 packs	100 packs	780
		US4	13.06	059010			
		10R	13.06	097385			
		US15	13.06	038419			
		AN/US15A	13.06	037996			
		US26	13.06	058989			



1. Items with prices in **bold** are stock items and usually ship within 24 hours. Please use stock number when ordering.
 2. Minimum order quantity is one box unless otherwise noted.



eConestoga Barn Door Hardware Series



Description	Finish	2018 List	Stock No.
9456-72 Flat Rail Steel Black Top Mount 72" Track Kit Includes Track	BLK	212.50	96467



9456-96 Flat Rail Steel Black Top Mount 96" Track Kit Includes Track	BLK	237.50	96466
---	-----	--------	-------



9457-72 Flat Rail Steel Black 3" Hook 72" Track Kit Includes Track	BLK	237.50	96427
---	-----	--------	-------



9457-96 Flat Rail Steel Black 3" Hook 96" Track Kit Includes Track	BLK	262.50	96388
---	-----	--------	-------



1-269-8649 Flat Rail Track Connector	BLK	12.50	96361
--	-----	-------	-------



1-269-8648 72" Rail Only	BLK	87.50	96355
------------------------------------	-----	-------	-------



1-269-8647 96" Rail Only	BLK	100.00	96353
------------------------------------	-----	--------	-------



1-269-8646 Flat Rail Soft Close Add On	BLK	62.50	96352
--	-----	-------	-------



How to Order

9458

Product Group

2D

Backset / Faceplate

2D (2-1/4")

35 (3-1/2")

BLK

Finish

BLK (Black)

US32D

US10B

For 1-3/8" (35mm) to 1-3/4"(40mm) thick doors standard.

- Non-handed.
- ADA Compliant thumb turn for commercial applications
- 2-1/4" or 3-1/2" backset options (see specifications for corresponding wall thickness).
- Drive in bolt casing diameter: 1" (25mm).
- Lock bolt: 1/2" (13mm) diameter, stainless Steel material.
- Lock bolt has 1" projection allowing up to 1/2" door to wall gap. Extra spacer ring accommodates up to 3/4" gap between barn door and wall.
- 1-1/4" diameter spring-loaded dust proof strike provides ample space to receive 1/2" bolt, allows easy locking from privacy side. Strike mounted in barn door for standard door.



Description	Finish	2018 List	Stock No.
94582D-32D Round ADA TT Stainless 2-1/4" Backset	32D	176.80	86683
94582D-10B Round ADA TT Oil Rubbed Bronze 2-1/4" Backset	10B	176.80	86672
94582D-BLK Round ADA TT Black 2-1/4" Backset	BLK	176.80	86664
945835-32D Round ADA TT Stainless Steel 3-1/2" Backset	32D	176.80	86663
945835-10B Round ADA TT Oil Rubbed Bronze 3-1/2" Backset	10B	176.80	86657
945835-BLK Round ADA TT Black 3-1/2" Backset	BLK	176.80	86653

1. Items with prices in **bold** are stock items and usually ship within 24 hours. Please use stock number when ordering.
 2. Minimum order quantity is one box unless otherwise noted.





One Family. One Brand. One Vision.™

www.hagerco.com

TABLE OF CONTENTS

	A			M
ANSI Standards.....		2	Mortar Box.....	11
	B			P
Bearing at Top.....		12	Painted Cover Channels.....	6
Bearing Replacement Kit.....		14	Polished Cover Channels.....	6
	C			Q
Cancellation Notification		2	Quick Connect.....	9
Center Punches		14	Quick Ship.....	2
Concealed Electric Hinges with Lead Wire.....		7-10		R
Concealed Electric Monitoring (EMN).....		7-10	Replacement Moldings	11
Concealed Electric Through-Wire (ETW).....		7-10		S
Concealed Electric Through-Wire - Removable (RETW)		7-10	Shim Stock.....	15
Concealed Electric Through-Wire and Monitoring (ETM)		7-10	Shipping Cartons	15
Custom Hole Pattern		12	Short Hinges.....	12
	D		Special Anodizing	6
Dutch Door Prep.....		14	Special Cover Channels.....	5
	E		Special Finished Hinges.....	6
Electric Power Transfer Preparation (EPT).....		9	Special Holes	6
Electrical Modifications		7-10	Special Lengths	3
Exposed Electric Contacts (E).....		7-10	Special Products.....	3
Exposed Electric Switches (EIS).....		7-10	Standard Finishes.....	3
Extra Long Hinges.....		12	Standard Lengths.....	3
Power Transfer Preparation		9		T
	F		Tamper Resistant Hinge.....	14
Fasteners.....		15	Template Hinges.....	3
Field Modifications.....		3	TIPIT®	14
Fire Ratings		4		
	H			
Hinges				
Concealed.....		16, 17, 19-23, 24, 26-27, 29		
Full Surface.....		16, 19, 23-25, 28		
Half Surface		16-19, 23, 25, 28		
Hospital Tip.....		12		
How To Order		2		
	L			
Lead Times		2		
Length Specifications.....		3		



Roton Continuous Hinges

HOW TO ORDER:

Example: 780-112HDFFUL 119" CLR 1 PK

Stock Number: 184038

Item Number: YS 1121190CLR000001 Rev. S



INTRODUCTION

Hager Roton hinges are unique, aluminum geared hinges developed to outperform most other entrance components because the weight of the door is distributed along the full length of the door frame.

Roton continuous hinges have been utilized in hospitals, schools, hotels, offices, airports, stadiums, storefronts, and commercial and industrial buildings in new construction and retrofit applications for over 30 years.

Hager Roton continuous geared hinges are designed for superior performance. Because of this, we offer our lifetime warranty with confidence.

ANSI Standards

- 780 Series Roton continuous geared hinges are approved per ANSI A156.26 Grade 1 for 150 lb. doors
- 780 Series Roton heavy duty hinges are approved per ANSI A156.26 Grade 1 for 300 lb. doors
- 780-111, 780-112, 780-124HD, 780-224, 780-226 standard duty and heavy duty Roton continuous geared hinges are Warnock-Hersey certified in accordance with ANSI A250.13 2003 Standard Severe Windstorm Resistant Components.



Lead Times

Stock items will typically ship in five working days or less from the order entry date. Made-to-order items will typically ship in 15 working days depending on seasonal volume and order complexity. Special orders including industrials, special machining, and large quantities may need to be scheduled. The anticipated ship date will be included with each order acknowledgement. Please contact Customer Service if product availability is in question.

Quick Ship

Products denoted with **red and bold** pricing are available to order through the Quick Ship program and ship within 24 hours. When ordering these products please visit www.hagerco.com and log in to MyHager to access the 'Quick Ship' portal. Due to the promptness of the fulfillment process, Quick Ship orders are non-cancellable.

Cancellation Notification

Cancellation for made to order items must be completed within 48 hours of order placement.



Standard Lengths

Roton hinges are listed and priced as actual lengths 79" (6'8" opening), 83" (7'0" opening), 85" (7'2" opening), 95" (8'0" opening), and 119" (10'0" opening) for convenience in application to nominal sized doors. Actual length provides for threshold clearance, head clearance and door height allowances for carpeting. Other lengths may be ordered as non-standard items.

Special Lengths

Should a non-standard length be required, please price as the next standard length. (For example, if 86" length is required, use 95" list price.)

Length Specifications

If special lengths to match the actual net door heights are required, please indicate this clearly on your order. A special length should be specified from the net door height, not the nominal height of the opening. To order specify: "Actual Length", or "Net Door Height". Use pricing for the next longer standard length from which the special length can be manufactured. For example, hinges 86-3/4" long will be invoiced at the 95" price.

Field Modifications

While Roton hinges can be cut in the field, any product modifications may void all warranties. Should in-the-field modifications be required, cut only from bottom of hinge. Do not cut through bearings or screw holes. When cutting electric hinges it is extremely important to clamp both hinge leaves securely to prevent hinge "chatter" which can damage the hinge's internal wiring. Consult the St. Louis sales office before proceeding.

Template Hinges

Hager has developed templated hole patterns for Roton hinge models in standard lengths. Drawings are available upon request by contacting Hager Customer Service or accessing the Hager website at www.hagerco.com.

Due to normal variances inherent in the manufacturing process, Roton custom length hinges are deemed by Hager to be non-templated.

Standard Finishes

Roton hinges are available in clear anodized satin aluminum (similar to US28), dark bronze and black exterior anodized coating.

Special Products

A special product is any product not listed in the price book in regard to length, finish, standard hole preparation or leaf combinations not illustrated. Orders for special products are encouraged, but any changes or cancellations on special orders may result in charges related to work performed and/or material loss. Under no circumstance will non-stock or make-to-order products be accepted for return unless due to Hager error.



Roton Continuous Hinges

FIRE RATINGS - UNDERWRITERS LABORATORY FIRE RATING FILE #A14627



780 Series Roton continuous geared hinges with stainless steel studs are approved for use on 4'x10' metal or wood swing type doors. 780 Series Roton continuous geared hinges without stainless steel studs are approved for use on 4'x8' single swing metal doors and 4'x10' single swing wood doors used without stainless steel studs limited to 20 minute fire rating without hose stream.

- Hollow metal, tin-clad, sheet-metal and steel covered composite type rated up to and including 3 hours
- Wood composite doors rated up to and including 1-1/2 hours
- Wood core doors rated up to 20 minutes without hose stream, non-studded
- 780 Series Roton Continuous Geared Hinges meet requirements for positive pressure UL10C, UL10B and UBC7-2 Part 1

UL10C Fire Rated Roton	Fully Concealed	Full Surface	Half Surface	NOTES: 1. All Roton hinges will be marked with UL stamp if they are fire-rated. 2. Several hinge models cannot be fire-rated. Check each profile. 3. Models that require studs have an extra charge. Four studs are required for UL stud hinges. Add to the hinge list price before applying buying group discount - add \$56.80 .
20 Minute Fire Rated Wood Core Door x Fire Rated Hollow Metal Frame	UL — FF STANDARD			
20 Minute Fire Rated Metal Door x Fire Rated Hollow Metal Frame	UL — FF STANDARD			
30 Minute Fire Rated Wood Composite Door x Fire Rated Hollow Metal Frame	UL — FF STANDARD			
30 Minute Fire Rated Metal Door x Fire Rated Hollow Metal Frame	UL — FF STANDARD			
45 Minute Fire Rated Wood Composite Door x Fire Rated Hollow Metal Frame	UL — FF STANDARD			
45 Minute Fire Rated Metal Door x Fire Rated Hollow Metal Frame	UL — FF STANDARD			
60 Minute Fire Rated Wood Door x Hollow Metal Frame	UL — FF STANDARD			
60 Minute Fire Rated Metal Door x Hollow Metal Frame	UL — FF STANDARD			
90 Minute Fire Rated Metal Door x Fire Rated Hollow Metal Frame	UL — FF STANDARD			
90 Minute Fire Rated Wood Composite Door x Fire Rated Hollow Metal Frame	UL — STUD REQUIRED * Must Specify			
3 Hour Fire Rated Metal Door x Fire Rated Hollow Metal Frame	UL — STUD REQUIRED * Must Specify			

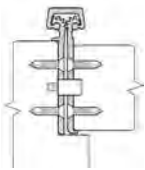

FULLY CONCEALED WITH STUD

Fully Concealed

These models are concealed between the frame and the hinge edge of the door. Models available include: 780-041HD, 780-041LL, 780-111, 780-111HD, 780-111LL, 780-112, 780-112HD, 780-112LL, 780--124HD, 780-124LL, 780-224, 780-224HD, 780-224LL, 780-226, 780-226HD, 780-226LL, and 780-235HD.

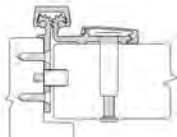

HALF SURFACE WITH STUD

Half Surface

These models have the frame leaf concealed between the frame and the edge of the door. The door leaf is mounted to the door with thru-bolts or screws. Models available include: 780-045HD, 780-046HD, 780-053, 780-053HD, 780-054HD, and 780-211HD.

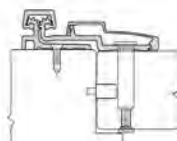

FULL SURFACE WITH STUD

Full Surface

These models have the frame leaf mounted to the face of the frame and the face of the door. The door leaf is mounted to the face of the door with thru-bolts. Models available include: 780-057HD, 780-157, 780-157HD, 780-210, 780-210HD, and 780-257HD.



MODIFICATIONS & ADDITIONS

Special Cover Channels

Rounded back cover channels may be ordered. Availability for hinges with electrical modifications vary.

Please consult the St. Louis sales office for confirmation. Add to the hinge list price before applying buying group discount:

Round Back Cover Channels

Clear Anodized

79", 83", 85" **\$25.40**

95" **\$31.50**

119" **\$40.55**

Bronze Anodized

79", 83", 85" **\$50.70**

95" **\$56.75**

119" **\$64.90**

Black Anodized

79", 83", 85" **\$58.31**

95" **\$65.27**

119" **\$74.64**



Note: Special cover channels available in clear, dark bronze and black finish.

Roton Cover Channel Compatibility		
Hinge Model	Flat FBCC	Round RBCC
750-134	•	•
750-138	•	•
780-041	•	•
780-045	•	•
780-046	•	•
780-053	•	•
780-054	•	•
780-057	•	•
780-110	•	•
780-111	•	•
780-112	•	•
780-113	•	•
780-124	•	•
780-155	•	•
780-157	•	
780-210	•	•
780-211	•	•
780-213	•	•
780-224	•	•
780-226	•	•
780-235	•	•
780-257	•	
780-300	•	

* Round back (RBCC) is not compatible with molded Hospital Tip option.



Roton Continuous Hinges

MODIFICATIONS & ADDITIONS

ADDITION TO LIST PRICE

Bone White Painted Cover Channels

For hinges 79", 83" and 85" in length

\$60.90

For hinges 95" in length

\$83.10

For hinges 119" in length

\$123.60

Roton cover channels are offered in bone white as a standard stock color option. This is only available on the standard Roton cover channel and should be ordered as bone white paint # UC43350.

Polished Cover Channels

CLEAR

GOLD

For hinges 79" in length

\$60.90

\$83.10

For hinges 83" in length

\$60.90

\$83.10

For hinges 85" in length

\$60.90

\$83.10

For hinges 95" in length

\$83.10

\$103.30

For hinges 119" in length

\$122.55

\$141.80

Any hinge may be ordered with a polished clear cover channel (similar to US26) to complement clear anodized hinge leaves or a polished gold cover channel (similar to US3) to complement satin gold hinge leaves.

Special Finished Hinges

Price on Application

Hager Companies can supply unfinished material to selected finishers for special projects that require unusual colors, but will require that final assembly be complete by Hager Companies. Because of special non-removable metal coatings applied to all hinges during assembly, users are cautioned against attempting to refinish any Roton product. Lead time of up to 10-12 weeks may be required.

Cannot paint 500 or 1200 series hinges.

Special Anodizing

Add 20% to the DBA hinges for gold

Roton hinges are available in various special colors including Black, Gold, and other special anodized finishes with fasteners to match. Example, specify "Black Anodized" or "Gold Anodized." All hinges ordered in special colors should be ordered at the same time to guarantee finish uniformity.

Other anodized colors by quotation only. Supply color chip for best match.

Special Holes

Price on Application

Any hinge may be ordered with special hole locations for unusual frame or door locations. Please provide specification for each leaf.



ROTON ELECTRICAL MODIFICATIONS

- A = Opening
- B = Door height
- C = Actual hinge length
- D = C.L. of EMN (electric monitor)
- E = C.L. of ETM (electric through-wires & monitor)
- F = C.L. of ETW (electric through-wires)
- G = C.L. of EPT (electric power transfer)
- H = C.L. of E1S (exposed switch)
- J = C.L. of E (exposed contact)
- K = C.L. of RETW (removable electric through-wires)

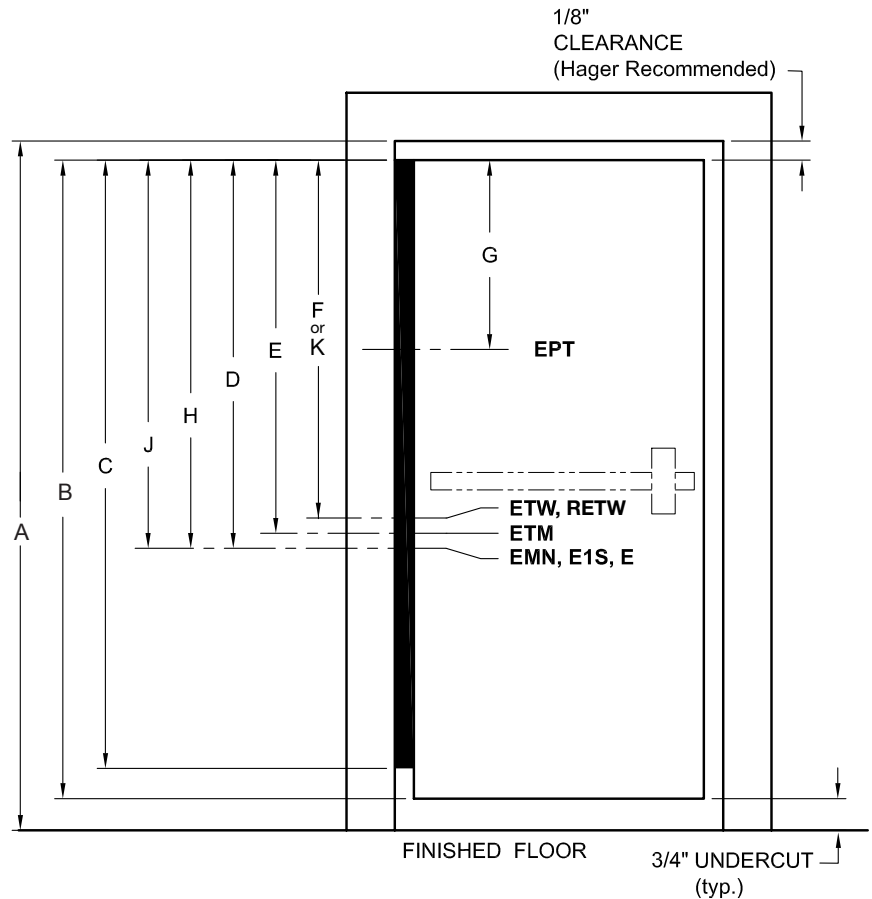

For ease of ordering, Hager Companies has established standard locations for power transfer cutouts. All standard location dimensions are referenced from the top edge of the door to the centerline of the power transfer cutout. Please specify handing.

NOTE: These locations are for concealed hinges only.

	Opening	Door Height	Actual Hinge Length	EMN	ETM	ETW	EPT	E1S	E	RETW
79 SD	80"	79-1/8"	79"	40-3/4"	42-3/4"	40-3/4"	34-3/8"	42-1/2"	42-1/2"	-
79 HD	80"	79-1/8"	79"	40-3/4"	43-3/8"	40-3/4"	34-3/8"	42-1/2"	42-1/2"	43-3/8"
83 SD	84"	83-1/8"	83"	45-5/16"	44-3/4"	45-5/16"	36-3/8"	46-1/2"	46-1/2"	-
83 HD	84"	83-1/8"	83"	45-5/16"	45-3/8"	45-5/16"	36-3/8"	46-1/2"	46-1/2"	45-3/8"
85 SD	86"	85-1/8"	N/A	N/A	N/A	N/A	N/A	N/A	N/A	N/A
85 HD	86"	85-1/8"	85"	46-5/16"	46-3/8"	46-5/16"	37-3/8"	48-1/2"	48-1/2"	46-3/8"
95 SD	96"	95-1/8"	95"	56-3/8"	55-13/16"	56-3/8"	47-1/2"	59-3/4"	59-3/4"	-
95 HD	96"	95-1/8"	95"	56-3/8"	56-1/2"	56-3/8"	47-1/2"	59-3/4"	59-3/4"	56-1/2"
119 SD	120"	119-1/8"	N/A	N/A	N/A	N/A	N/A	N/A	N/A	N/A
119 HD	120"	119-1/8"	119"	81-1/4"	81-5/16"	81-1/4"	72-5/16"	83-3/4"	83-3/4"	81-5/16"

SD = Standard Duty

HD = Heavy Duty



Roton Continuous Hinges

ROTON ELECTRICAL MODIFICATIONS (CONTINUED)

	Von Duprin EPT 2 or EPT 10 Power Transfer Preparation	Exposed Electric Contacts	Exposed Electric Switches	Concealed Electric Through-Wire	Concealed Electric Monitoring	Concealed Electric Through-Wire and Monitoring	Removable Electric Through-Wire
Part Number	EPT	E	E1S	ETW	EMN	ETM	RETW
780-045HD	•						
780-046HD	•						
780-053	•						
780-053HD	•						
780-054HD	•						
780-110HD			•				
780-057				•			•
780-111	•	•	•	•	•	•	
780-111HD	•	•	•	•	•	•	•
780-111LL	•	•	•	•	•	•	
780-112	•	•	•	•	•	•	
780-112HD	•	•	•	•	•	•	•
780-112LL	•	•	•	•	•	•	
780-124HD	•	•	•	•	•	•	•
780-124LL	•	•	•	•	•	•	
780-157				•			•
780-224	•	•	•	•	•	•	
780-224HD	•	•	•	•	•	•	•
780-224LL	•	•	•	•	•	•	
780-226HD	•	•	•	•	•	•	•
780-226LL	•	•	•	•	•	•	
1200-600	•			•			
1200-650	•			•			



MODIFICATIONS & ADDITIONS

ADDITION TO LIST PRICE

Quick Connect

\$45.60

Available for ETM, ETW, and RETW options. Top and bottom knockouts for standard conduit fittings.

Concealed Electric Monitoring (EMN)

\$268.40

- Miniature switch is incorporated into the frame leaf.
- Specify handing and the dimension from the top edge of the door to the centerline of the electric monitoring location.
- Special Electric Modifications and EPT locations may require additional charges if screw holes have to be moved.
- Templates regarding location of monitoring switch available upon request.

Concealed Electric Through-Wire and Monitoring (ETM)

- Electric Preparation

ETM-4	\$535.70
ETM-8	\$621.80
ETM-10	\$662.25

- All ETM have 28-Gauge continuous conductors.
- This combines the continuous electric conductors and the miniature switch to provide both power transfer and monitoring.
- Miniature switch is incorporated into the frame leaf.
- Specify handing and the dimension from the top edge of the door to the centerline of each electric modification location.
- Templates regarding location of monitoring switch available upon request.

Concealed Electric Through-Wire (ETW)

- Electric Preparation

ETW-4	\$268.40
ETW-8	\$349.40
ETW-10	\$398.00
ETW-12	\$445.40

- All ETW have 28-Gauge continuous conductors.
- 12" per side required as a suffix.
- Cut out for prep - 1/2" drilled hole.
- Transfers power discreetly from building to door hardware.
- Specify handing and the dimension from the top edge of the door to the centerline of the electric through-wire location.
- Special electric modifications and EPT locations may require additional charges if screw holes have to be moved.
Contact Hager Customer Service for charges.
- Templates regarding location of through-wires available upon request.

Available on the following Roton Concealed profiles:

- | | | | | |
|-------------|-------------|-------------|--------------|--------------|
| • 780-057HD | • 780-112HD | • 780-157HD | • 780-226HD | • 1200-650HD |
| • 780-111HD | • 780-124HD | • 780-224HD | • 1200-600HD | |

Power Transfer or Electric Power Transfer Preparation (EPT)

Concealed Leaf	\$104.40
Half Surface	\$62.90

- Hinge leaf cutout to accommodate power transfer device.
- Specify handing and the dimension from the top edge of the door to the **centerline** of the power transfer location.
- Special Electric Modifications and EPT locations may require additional charges if screw holes have to be moved.



Roton Continuous Hinges

MODIFICATIONS & ADDITIONS

ADDITION TO LIST PRICE

Lead Wire for Concealed Electric Hinges

Electric Preparation

4-wire hinge

8-wire hinge

10-wire hinge

- Standard wire leads are 12" per side
- Additional wire leads are available

Per Foot

\$9.25

\$16.80

\$19.05

Exposed Electric Switches (E1S)

\$93.80

- Miniature push button switch incorporated in hinge frame leaf to monitor position of the door.
- Three 12" wire leads.
- Each monitoring hinge only needs one E1S Switch.
- Specify handing and the dimension from the top edge of the door to the centerline of the electric switch location.
- Templates regarding location of contact switch available upon request.

Exposed Electric Contacts (E)

\$93.80

- Transfers power to door in closed position.
- Must have at least two (2) contacts to transfer power.
- Specify handing and the dimension from the top edge of the door to the centerline of the electric contact location.
- Templates regarding location of contacts available upon request.

Removable Electric Through-Wire (RETW) Twelve Wire

\$651.45

Removable 12 Wire Module Only

\$265.65

Component

Finish

7-102-1870

Clear

7-112-1872

Dark Bronze

7-112-1876

Gold

7-112-1881

Black

Removable Electric Through-Wire (RETW) Ten Wire

\$552.10

Removable 10 Wire Module Only

\$214.90

Component

Finish

7-102-1860

Clear

7-112-1870

Dark Bronze

7-112-1875

Gold

7-112-1880

Black

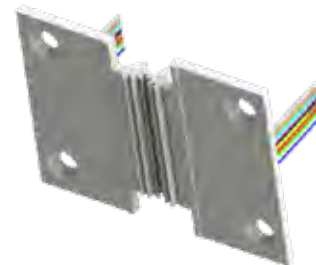

Available on heavy duty profiles:

- 780-057HD
- 780-112HD
- 780-157HD
- 780-226HD
- 780-111HD
- 780-124HD
- 780-224HD

- Transfers power discreetly from building to door hardware.
- Removable ETW module can be easily removed for adjustment for service.
- Templates regarding location of monitoring switch available upon request.
- Specify handing and the dimension from the top edge of the door to the centerline of the electric through-wire location.



MODIFICATIONS & ADDITIONS

Mortar Box - 430

\$45.55

- Serves as a mortar shield.
- Overall dimensions: 9" (229 mm) length with tabs, 7" (178 mm) inside, 1-3/4" x 1-3/4" (45 mm x 45 mm) inside dimension.
- Galvanized steel 0.040" (1 mm)

**Replacement Molding
780-052M**

Hinge Lengths

79", 83", 85"
95"
119"

Clear Anodized

\$38.60
\$44.60
\$53.25

Dark Bronze Anodized

\$44.60
\$53.25
\$61.80

Replacement door leaf molding for: 780-053, 780-053HD, 780-054HD, 780-155HD, 780-057HD, 780-157, 780-157HD, and 780-257HD.

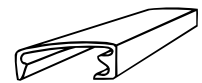
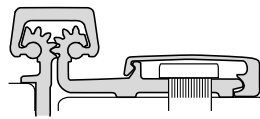

**Replacement Molding
780-210M**

Hinge Lengths

79", 83", 85"
95"
119"

Clear Anodized

\$40.60
\$50.20
\$58.80

Dark Bronze Anodized

\$50.20
\$58.80
\$66.45

Replacement door leaf molding for: 780-210, 780-210HD, 780-211, 780-211HD, 780-213HD, 780-045HD, and 780-046HD.

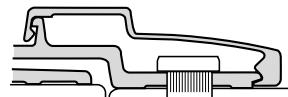

**Replacement Molding
780-247M**

Hinge Lengths

79", 83", 85"
95"
119"

Clear Anodized

\$34.50
\$40.60
\$50.20

Dark Bronze Anodized

\$40.60
\$50.20
\$58.80

Replacement frame leaf molding
780-157, 780-157HD, 780-257HD

Note: Replacement moldings for 780-052M and 780-210M are shipped in stock lengths for trimming in the field and furnished with Allen head set screw and wrench.

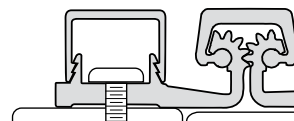

Roton Continuous Hinges

MODIFICATIONS & ADDITIONS

ADDITION TO LIST PRICE

Short Hinges

\$22.30

Hinges shorter than 79" will be invoiced at the 79" price. Where two or more short hinges can be obtained from a standard length, pricing is based on the number of standard lengths utilized plus an assembly charge for each hinge.

Extra Long Hinges

\$97.50

Hinges over 119" are manufactured as two separate lengths with a staggered joint for on-site connection. Hinge segments are taken from standard sizes for best economics in relation to the quantity required. Handing specifications are required to position the cuts inconspicuously and to finish symmetrical pairs in double door applications.

Custom Hole Pattern

Price on Application

Any hinge may be ordered with special hole locations for unusual frame or door conditions. Please provide specifications for each leaf.

Bearing At Top

\$41.50

This application allows for the bearing to be set at the very top of the cover channel. The cover channel is flush with the top of the geared hinge, preventing any obstructions or debris from being inserted in the top of the channel.

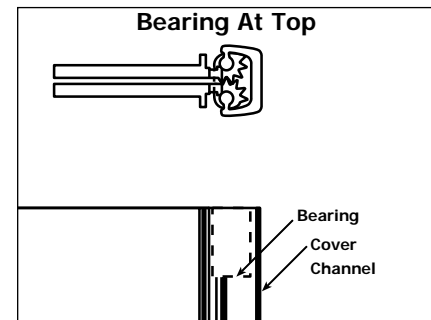

780 Series Concealed Molded Hospital Tip

\$122.50

780 Series Concealed and several Full Surface models can be prepared with a smooth tapered top bearing. This option is ideal for use in hospitals and correctional facilities to help provide a clean and safe environment. For Roton® Ligature-Resistant Opening Solutions see our TIPIT® section below. Not compatible with the round back cover channel option. For complete list of compatible models for this option, please reference chart on page 13.



Hospital Tip and TIPIT® Compatibility		
Part #	Molded Hospital Tip	TIPIT®
750-134		•
750-138		•
780-045		•
780-046		•
780-053		•
780-054		•
780-057	•	
780-110	•	•
780-111	•	•
780-112	•	•
780-113	•	•
780-124	•	•
780-155		•
780-157	•	•
780-210	•	•
780-211		•
780-224	•	•
780-226	•	•



Roton Continuous Hinges

MODIFICATIONS & ADDITIONS

TIPIT®

Designed to work with in new and retrofit applications, the TIPIT® was designed with safety in mind. When openings are fitted with the patented TIPIT® in conjunction with our Roton® Continuous Geared Hinge, this combination provides a safe environment while meeting institutional requirements for preventing objects from being hung from the top of the hinge.

Concealed

\$55.00



Full Surface (Gray or Black)

\$140.00



Tamper Resistant Hinge

\$143.80

This application is intended for use in hospital psychiatric areas and places of high security. The hinge is **prepared with a hospital tip** and every other bearing is supplied with a set screw to lock against the inside of the cover channel for additional security. 780 Series Concealed and Full Surface models (780-057, 780-157, and 780-210) are available in this configuration. Torx screws available at additional charge (see page 15).

Dutch Door Prep

\$85.15

Furnished as continuous frame leaf, whole door leaf is cut to fit dutch door specified length.

Bearing Replacement Kit

Standard Duty for 780 Series

Heavy Duty for 780 Series

Extra Heavy Duty for 1200 Series

Clear and Dark Bronze

\$43.65

\$83.10

\$165.15

Center Punches

Self-Centering center punches are available for #12 countersunk screws supplied. To make sure screw heads seat properly, accurate center punching is required.

\$9.25

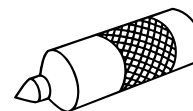

MODIFICATIONS & ADDITIONS

ADDITION TO LIST PRICE

Shim Stock

1/16" x 1-1/2" Wide x 7' Long
 1/8" x 1-1/2" Wide x 7' Long

\$32.00 each
\$44.60 each

Larger sizes available

Price on application

For clearance between the door and frame which may be excessive, a continuous shim is helpful (applied behind the frame leaf only). Anodized aluminum extrusions are supplied with no holes.

Shipping Carton

Extra shipping cartons are available for reshipping hinges in quantities of 2 or less.

\$22.30 each

Fasteners

All hinges are shipped with appropriate fasteners for metal doors and frames except where noted. **If wood screws are required, please specify on order, and wood screws will be substituted at no extra charge.** Bulk screws are packed separately.

Description	Part Numbers		
	Clear	Dark Bronze	
#12 x 1-1/2" Flat Head Wood Screw	7-080-0050	7-080-0051	\$247.30/box of 500
#12-24 x 11/16" Self-Drilling Flat Head Screw	7-080-0070	7-080-0072	\$221.10/box of 500
#12-24 x 1/2" Spanner Head Machine Screw			\$2.00 each
#12-24 x 11/16" Drill Quick Torx Screw			\$2.00 each
#12-24 x 13/32" Self-Threading Screw (Clear or Bronze)			\$0.80 each
#12-24 x 11/16" Self-Drilling Flat Head Screw (Clear or Bronze)			\$1.10 each
#12-24 x 11/16" Self-Drilling Pan Head Screw (Clear)			\$1.10 each
#12 x 1-1/2" Flat Head Wood Screw (Clear or Bronze)			\$1.10 each
#12 - 14 x 1-1/2" Wood Torx Screw			\$1.95 each
Sexbolts			\$2.95 each

Fastener Count: 83" - 38 holes, 95" - 40 holes, 119" - 48 holes.

Note: Additional fasteners may be ordered as follows (add to the hinge list price before applying buying group discount).



Roton Continuous Geared Hinges

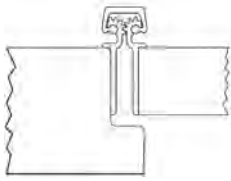

Description		Finish	2018 List	Stock No.	Case Qty.
500-048 Concealed Leaf With Sheet Metal Screws 1-1/6" Nominal Leaf Thickness	24" (610 mm)	Clear	71.70	068560	1
		Dark Bronze	95.50	068046	
	36" (914 mm)	Clear	81.20	068521	1
		Dark Bronze	107.50	067971	
	48" (1219 mm)	Clear	95.50	068520	1
		Dark Bronze	119.40	067970	

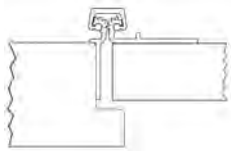

500-200 Half Surface With Sheet Metal Screws 1-1/6" Nominal Leaf Thickness	24" (610 mm)	Clear	71.70	067967	1
		Dark Bronze	95.50	067559	
	36" (914 mm)	Clear	83.60	067964	1
		Dark Bronze	107.50	067431	
	48" (1219 mm)	Clear	95.50	067961	1
		Dark Bronze	119.40	-	

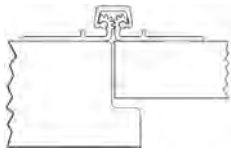

500-220 Full Surface With Sheet Metal Screws 1-1/6" Nominal Leaf Thickness	24" (610 mm)	Clear	71.70	067944	1
		Dark Bronze	95.50	-	
	36" (914 mm)	Clear	83.60	067940	1
		Dark Bronze	107.50	067009	
	48" (1219 mm)	Clear	95.50	067939	1
		Dark Bronze	119.40	067001	

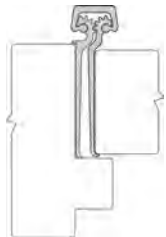

750-134 Concealed Leaf With Half Drill Quick and Half Wood Screws 1-3/4" Interior Wood Door	79" (2007 mm)	Clear	154.50	194853	8
	83" (2108 mm)	Clear	154.50	194855	8
	85" (2159 mm)	Clear	154.50	194859	8
	95" (2413 mm)	Clear	196.50	194861	8
	119" (3023 mm)	Clear	304.10	194863	6

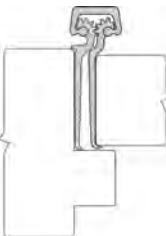

750-138 Concealed Leaf With Half Drill Quick and Half Wood Screws 1-3/8" Interior Wood Door	79" (2007 mm)	Clear	157.20	194890	8
	83" (2108 mm)	Clear	157.20	194897	8
	85" (2159 mm)	Clear	157.20	194909	8
	95" (2413 mm)	Clear	192.30	-	8
	119" (3023 mm)	Clear	296.60	-	8



Roton Continuous Geared Hinges

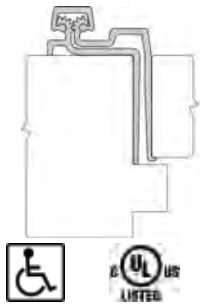

Description	Finish	2018 List	Stock No.	Case Qty.
780-041HD Concealed Leaf Heavy Duty 1-3/4" Door Swing Clear Action	79" (2007 mm) Clear	362.40	194918	6
	Dark Bronze	481.00	194919	
	Black	533.20	-	
	83" (2108 mm) Clear	362.40	194803	6
	Dark Bronze	481.00	194920	
	Black	553.20	-	
	85" (2159 mm) Clear	362.40	194921	6
	Dark Bronze	481.00	194923	
	Black	533.20	-	
	95" (2413 mm) Clear	449.20	194805	6
	Dark Bronze	591.70	194924	
	Black	680.40	-	
	119" (3023 mm) Clear	670.50	194925	2
	Dark Bronze	881.90	194926	
	Black	1,014.20	024432	

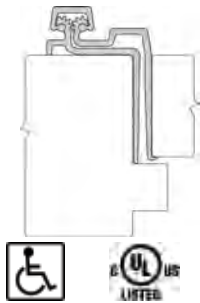

780-041LL Concealed Leaf With Half Drill Quick and Half Wood Screws 1-3/4" Door Lead Lined Heavy Duty Profile Only Swing Clear Action	79" (2007 mm) Clear	376.90	187432	6
	Dark Bronze	493.00	-	
	Black	567.00	-	
	83" (2108 mm) Clear	376.90	194928	6
	Dark Bronze	493.00	-	
	Black	567.00	-	
	85" (2159 mm) Clear	376.90	-	6
	Dark Bronze	493.00	-	
	Black	567.00	-	
	95" (2413 mm) Clear	461.30	194929	6
	Dark Bronze	603.70	-	
	Black	694.30	-	
	119" (3023 mm) Clear	681.50	-	2
	Dark Bronze	894.00	-	
	Black	1,028.10	-	



780-045HD Half Surface Heavy Duty	79" (2007 mm) Clear	429.70	004046	4
	Dark Bronze	574.40	-	
	Black	660.60	-	
	83" (2108 mm) Clear	429.70	065575	4
	Dark Bronze	574.40	152230	
	Black	660.60	-	
	85" (2159 mm) Clear	429.70	161260	4
	Dark Bronze	574.40	165869	
	Black	660.60	-	
	95" (2413 mm) Clear	528.20	104689	4
	Dark Bronze	706.50	168059	
	Black	812.40	-	
	119" (3023 mm) Clear	786.90	163204	2
	Dark Bronze	1,051.00	161207	
	Black	1,028.70	-	

1. Items with the price in **bold and red** are Quick Ship items and ship in 24 hours.
Please use stock number when ordering. 2. U/M is each unless otherwise noted.



Roton Continuous Geared Hinges



Description		Finish	2018 List	Stock No.	Case Qty.
780-046HD Half Surface Heavy Duty	79" (2007 mm)	Clear	462.50	163916	4
		Dark Bronze	606.70	-	
		Black	697.70	-	
	83" (2108 mm)	Clear	462.50	026032	4
		Dark Bronze	606.70	149561	
		Black	697.70	-	
	85" (2159 mm)	Clear	462.50	158054	4
		Dark Bronze	606.70	-	
		Black	697.70	-	
	95" (2413 mm)	Clear	567.10	025211	4
		Dark Bronze	754.10	162657	
		Black	867.20	-	
	119" (3023 mm)	Clear	847.20	-	2
		Dark Bronze	1,122.70	-	
		Black	1,291.10	-	
780-053 Half Surface	79" (2007 mm)	Clear	224.80	056995	5
		Dark Bronze	309.10	163993	
		Black	355.40	-	
	83" (2108 mm)	Clear	224.80	194991	5
		Dark Bronze	309.10	014876	
		Black	355.40	-	
	95" (2413 mm)	Clear	278.50	010247	5
		Dark Bronze	376.70	009044	
		Black	433.20	-	
780-053HD Half Surface Heavy Duty	79" (2007 mm)	Clear	282.00	013612	5
		Dark Bronze	353.70	082818	
		Black	406.80	-	
	83" (2108 mm)	Clear	282.00	194998	5
		Dark Bronze	353.70	194999	
		Black	406.80	-	
	85" (2159 mm)	Clear	282.00	050663	5
		Dark Bronze	353.70	132585	
		Black	406.80	-	
	95" (2413 mm)	Clear	349.90	195004	5
		Dark Bronze	423.90	018393	
		Black	487.50	-	
	119" (3023 mm)	Clear	535.60	052397	3
		Dark Bronze	715.00	093628	
		Black	822.30	-	

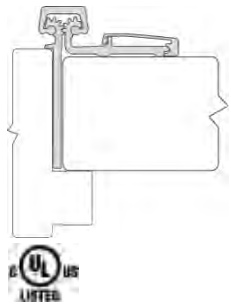
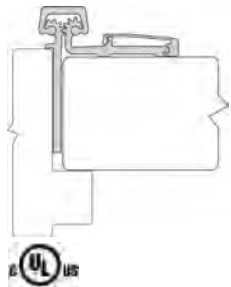

Roton Continuous Geared Hinges

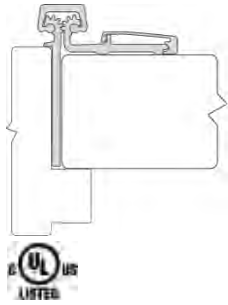

Description		Finish	2018 List	Stock No.	Case Qty.
780-054HD Half Surface Heavy Duty	79" (2007 mm)	Clear	308.00	021269	5
		Dark Bronze	378.80	131605	
		Black	435.60	-	
	83" (2108 mm)	Clear	308.00	195052	5
		Dark Bronze	378.80	027437	
		Black	435.60	-	
	85" (2159 mm)	Clear	308.00	078989	5
		Dark Bronze	378.80	071971	
		Black	435.60	-	
	95" (2413 mm)	Clear	380.80	078992	5
		Dark Bronze	450.50	071970	
		Black	518.00	-	
	119" (3023 mm)	Clear	585.80	026627	3
		Dark Bronze	756.10	159983	
		Black	869.50	-	
780-057HD Full Surface Heavy Duty Bi-Fold Applications	79" (2007 mm)	Clear	329.00	021238	5
		Dark Bronze	464.60	017850	
		Black	534.30	-	
	83" (2108 mm)	Clear	329.00	007856	5
		Dark Bronze	464.60	025973	
		Black	534.30	-	
	85" (2159 mm)	Clear	329.00	025846	5
		Dark Bronze	464.60	174835	
		Black	534.30	-	
	95" (2413 mm)	Clear	418.30	024478	5
		Dark Bronze	575.20	094331	
		Black	661.50	-	
	119" (3023 mm)	Clear	623.50	088469	4
		Dark Bronze	856.70	165568	
		Black	985.20	-	
780-110HD Concealed Leaf Heavy Duty For 1" to 1-3/8" door	79" (2007 mm)	Clear	209.20	009945	8
		Dark Bronze	270.30	127036	
		Black	310.80	-	
	83" (2108 mm)	Clear	209.20	009549	8
		Dark Bronze	270.30	006241	
		Black	310.80	-	
	85" (2159 mm)	Clear	209.20	044312	8
		Dark Bronze	270.30	173953	
		Black	310.80	-	
	95" (2413 mm)	Clear	251.40	100893	8
		Dark Bronze	325.80	161122	
		Black	374.70	-	
	119" (3023 mm)	Clear	398.20	158984	7
		Dark Bronze	522.90	169966	
		Black	601.40	-	

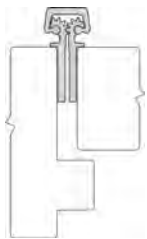

1. Items with the price in **bold and red** are Quick Ship items and ship in 24 hours.
Please use stock number when ordering. 2. U/M is each unless otherwise noted.

12/10/2019
www.hagerco.com



Roton Continuous Geared Hinges

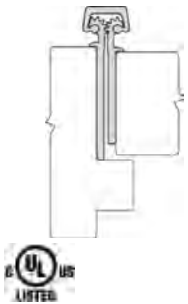
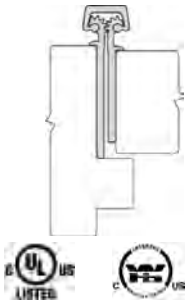
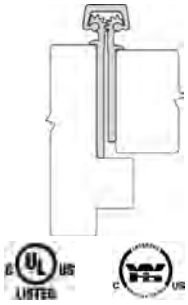

Description		Finish	2018 List	Stock No.	Case Qty.
780-111 Concealed Leaf	79" (2007 mm)	Clear	163.40	194809	8
		Dark Bronze	211.10	194810	
		Black	242.75	-	
	83" (2108 mm)	Clear	163.40	184007	8
		Dark Bronze	211.10	184008	
		Black	242.75	-	
	95" (2413 mm)	Clear	199.10	184031	8
		Dark Bronze	258.90	184048	
		Black	297.70	-	
780-111HD Concealed Leaf Heavy Duty	79" (2007 mm)	Clear	203.30	183917	8
		Dark Bronze	265.50	194812	
		Black	305.40	-	
	83" (2108 mm)	Clear	203.30	183924	8
		Dark Bronze	265.50	183988	
		Black	305.40	116592	
	85" (2159 mm)	Clear	203.30	194814	8
		Dark Bronze	265.50	194815	
		Black	305.40	-	
	95" (2413 mm)	Clear	246.80	184025	8
		Dark Bronze	319.20	194816	
		Black	367.10	109310	
	119" (3023 mm)	Clear	394.40	194817	7
		Dark Bronze	513.60	194819	
		Black	590.60	113845	
780-111LL Concealed Leaf With Half Drill Quick and Half Wood Screws Lead Lined Heavy Duty Profile Only	79" (2007 mm)	Clear	220.00	194848	8
		Dark Bronze	279.60	-	
		Black	321.60	-	
	83" (2108 mm)	Clear	220.00	195079	8
		Dark Bronze	279.60	195080	
		Black	321.60	-	
	85" (2159 mm)	Clear	220.00	-	8
		Dark Bronze	279.60	-	
		Black	321.60	-	
	95" (2413 mm)	Clear	261.50	195088	8
		Dark Bronze	333.20	195089	
		Black	383.20	-	
	119" (3023 mm)	Clear	405.00	-	7
		Dark Bronze	528.20	-	
		Black	607.50	-	

Roton Continuous Geared Hinges

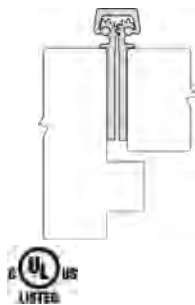

Description		Finish	2018 List	Stock No.	Case Qty.
780-112 Concealed Leaf Single Pack w/ Drill Quick Screws	79" (2007 mm)	Clear	137.60	183922	8
		Dark Bronze	177.70	194822	
		Black	204.40	-	
	83" (2108 mm)	Clear	137.60	184001	8
		Dark Bronze	177.70	184003	
		Black	204.40	-	
	95" (2413 mm)	Clear	168.50	184032	7
		Dark Bronze	221.90	184033	
		Black	255.20	-	
780-112 Concealed Leaf Case Pack w/ Drill Quick Screws Must Order Case Quantity	83" (2108 mm)	Clear	123.80	184009	8
		Dark Bronze	160.00	184010	
		Black	184.00	-	
780-112HD Concealed Leaf Single Pack w/ Drill Quick Screws	79" (2007 mm)	Clear	170.90	183881	8
		Dark Bronze	220.80	194826	
		Black	253.90	-	
	83" (2108 mm)	Clear	170.90	183926	8
		Dark Bronze	220.80	183932	
		Black	253.90	-	
	85" (2159 mm)	Clear	170.90	184011	8
		Dark Bronze	220.80	184013	
		Black	253.90	-	
	95" (2413 mm)	Clear	205.90	184020	7
		Dark Bronze	271.50	184021	
		Black	312.20	-	
	119" (3023 mm)	Clear	331.20	184038	7
		Dark Bronze	436.40	194827	
		Black	501.90	-	
780-112HD Concealed Leaf Case Pack w/ Drill Quick Screws Must Order Case Quantity	83" (2108 mm)	Clear	156.40	109235	8
		Dark Bronze	198.80	168587	
		Black	228.60	183989	
780-112LL Concealed Leaf With Half Drill Quick and Half Wood Screws Lead Lined Heavy Duty Profile Only	79" (2007 mm)	Clear	188.50	195090	8
		Dark Bronze	246.40	-	
		Black	283.40	-	
	83" (2108 mm)	Clear	188.50	195091	8
		Dark Bronze	246.40	195092	
		Black	283.40	-	
	85" (2159 mm)	Clear	188.50	195093	8
		Dark Bronze	246.40	-	
		Black	283.40	-	
	95" (2413 mm)	Clear	229.30	195094	8
		Dark Bronze	294.00	195095	
		Black	338.60	-	
	119" (3023 mm)	Clear	365.80	195096	7
		Dark Bronze	478.00	-	
		Black	549.70	-	

1. Items with the price in **bold and red** are Quick Ship items and ship in 24 hours.
Please use stock number when ordering. 2. U/M is each unless otherwise noted.



Roton Continuous Geared Hinges

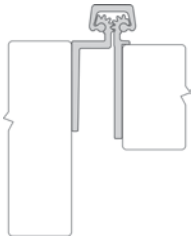

Description		Finish	2018 List	Stock No.	Case Qty.
780-113HD Concealed Leaf Heavy Duty "Safety Hinge" When Used Without Frame Stop	79" (2007 mm)	Clear	346.00	195097	6
		Dark Bronze	465.20	195098	
		Black	535.00	-	
	83" (2108 mm)	Clear	346.00	195099	6
		Dark Bronze	465.20	195100	
		Black	535.00	-	
	85" (2159 mm)	Clear	346.00	195101	6
		Dark Bronze	465.20	195102	
		Black	535.00	-	
	95" (2413 mm)	Clear	567.10	195103	6
		Dark Bronze	636.80	195104	
		Black	732.30	-	
	119" (3023 mm)	Clear	703.80	195105	4
		Dark Bronze	831.90	-	
		Black	956.70	-	

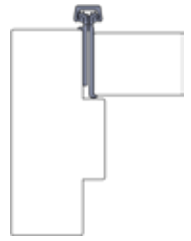

780-124HD Concealed Leaf Heavy Duty profile only Single Pack w/ Drill Quick Screws	79" (2007 mm)	Clear	173.70	194831	8
		Dark Bronze	226.20	194832	
		Black	260.20	-	
	83" (2108 mm)	Clear	173.70	183991	8
		Dark Bronze	226.20	194834	
		Black	260.20	140988	
	85" (2159 mm)	Clear	173.70	194835	8
		Dark Bronze	226.20	-	
		Black	260.20	-	
	95" (2413 mm)	Clear	210.10	194836	7
		Dark Bronze	252.50	194837	
		Black	290.40	-	
	119" (3023 mm)	Clear	341.40	194838	7
		Dark Bronze	447.40	-	
		Black	514.50	-	

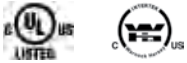

Roton Continuous Geared Hinges



Description		Finish	2018 List	Stock No.	Case Qty.
780-124LL Concealed Leaf Heavy Duty profile only With half drill quick and Half Wood Screws Lead Lined	79" (2007 mm)	Clear	195.90	-	8
		Dark Bronze	252.50	-	
		Black	290.40	-	
	83" (2108 mm)	Clear	195.90	195114	8
		Dark Bronze	252.50	-	
		Black	290.40	-	
	85" (2159 mm)	Clear	195.90	-	8
		Dark Bronze	252.50	-	
		Black	290.40	-	
	95" (2413 mm)	Clear	235.30	-	7
		Dark Bronze	296.90	-	
		Black	341.50	-	
	119" (3023 mm)	Clear	373.70	-	7
		Dark Bronze	484.80	-	
		Black	557.50	-	
780-155HD Half Surface Heavy Duty Center Hung and Egress Conversions	79" (2007 mm)	Clear	363.40	016603	5
		Dark Bronze	489.30	128736	
		Black	562.80	-	
	83" (2108 mm)	Clear	363.40	068088	5
		Dark Bronze	489.30	068371	
		Black	562.80	-	
	85" (2159 mm)	Clear	363.40	018276	5
		Dark Bronze	489.30	046665	
		Black	562.80	-	
	95" (2413 mm)	Clear	445.90	063096	5
		Dark Bronze	603.30	056566	
		Black	693.80	-	
	119" (3023 mm)	Clear	663.60	078745	2
		Dark Bronze	896.90	062632	
		Black	1,031.40	-	
780-157 Full Surface Frame Face Dimension Limitations	79" (2007 mm)	Clear	211.60	022092	5
		Dark Bronze	285.80	049196	
		Black	328.70	-	
	83" (2108 mm)	Clear	211.60	048049	5
		Dark Bronze	285.80	063070	
		Black	328.80	-	
	95" (2413 mm)	Clear	258.70	021262	5
		Dark Bronze	349.10	009045	
		Black	401.40	-	

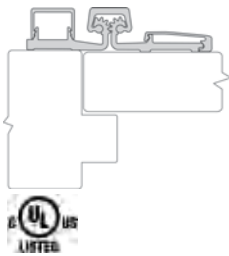
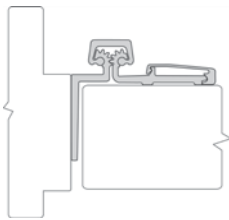

1. Items with the price in **bold and red** are Quick Ship items and ship in 24 hours.
Please use stock number when ordering. 2. U/M is each unless otherwise noted.



Roton Continuous Geared Hinges

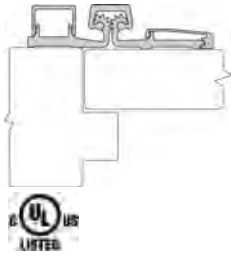

Description		Finish	2018 List	Stock No.	Case Qty.
780-157HD Full Surface Heavy Duty Frame Face Dimension Limitations	79" (2007 mm)	Clear	262.20	022028	5
		Dark Bronze	319.70	084386	
		Black	367.70	-	
	83" (2108 mm)	Clear	262.20	048059	5
		Dark Bronze	319.70	062422	
		Black	367.70	-	
	85" (2159 mm)	Clear	262.20	019546	5
		Dark Bronze	319.70	035156	
		Black	367.70	-	
	95" (2413 mm)	Clear	314.60	048060	5
		Dark Bronze	384.10	010547	
		Black	441.70	-	
	119" (3023 mm)	Clear	521.40	099644	2
		Dark Bronze	678.80	037141	
		Black	780.60	-	
780-210 Full Surface	79" (2007 mm)	Clear	211.60	010064	6
		Dark Bronze	285.80	073030	
		Black	328.70	-	
	83" (2108 mm)	Clear	211.60	048050	6
		Dark Bronze	285.80	048051	
		Black	328.70	-	
	95" (2413 mm)	Clear	253.20	063037	6
		Dark Bronze	344.90	020588	
		Black	396.60	-	

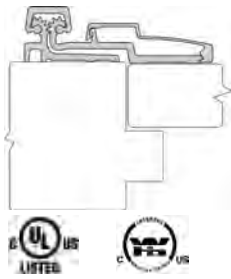

1. Items with the price in **bold and red** are Quick Ship items and ship in 24 hours. Please use stock number when ordering. 2. U/M is each unless otherwise noted.

Roton Continuous Geared Hinges

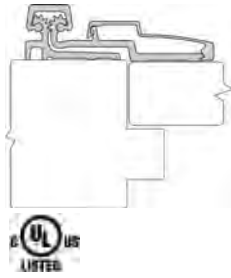

Description	Finish	2018 List	Stock No.	Case Qty.	
780-210HD Full Surface Heavy Duty	79" (2007 mm)	Clear	258.20	017046	6
		Dark Bronze	313.90	017037	
		Black	361.00	-	
	83" (2108 mm)	Clear	258.20	048061	6
		Dark Bronze	313.90	048062	
		Black	361.00	-	
	85" (2159 mm)	Clear	258.20	024124	6
		Dark Bronze	313.90	071974	
		Black	361.00	-	
95" (2413 mm)	Clear	304.80	048063	6	
	Dark Bronze	375.00	046722		
	Black	431.20	-		
119" (3023 mm)	Clear	509.80	025722	2	
	Dark Bronze	571.40	000304		
	Black	657.10	-		

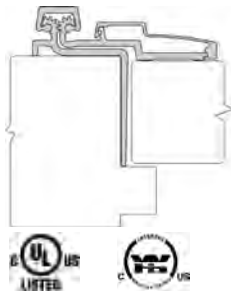

780-211HD Half Surface Heavy Duty Frame Leaf Wrap-Around Reinforcement for Damaged Frames	79" (2007 mm)	Clear	508.20	116360	4
		Dark Bronze	667.70	-	
		Black	767.90	-	
	83" (2108 mm)	Clear	508.20	010867	4
		Dark Bronze	667.70	120382	
		Black	767.90	-	
	85" (2159 mm)	Clear	508.20	162789	4
		Dark Bronze	667.70	160923	
		Black	767.90	-	
	95" (2413 mm)	Clear	625.40	115949	4
		Dark Bronze	821.80	-	
		Black	945.10	-	
	119" (3023 mm)	Clear	931.70	158595	2
		Dark Bronze	1,224.60	-	
		Black	1,408.30	-	

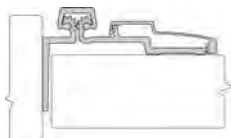

780-213HD Half Surface Heavy Duty Center Hung Doors	79" (2007 mm)	Clear	481.30	023958	4
		Dark Bronze	635.50	107818	
		Black	730.80	-	
	83" (2108 mm)	Clear	481.30	007660	4
		Dark Bronze	635.50	195212	
		Black	730.80	-	
	85" (2159 mm)	Clear	481.30	044343	4
		Dark Bronze	635.50	147623	
		Black	730.80	-	
	95" (2413 mm)	Clear	590.60	012731	4
		Dark Bronze	781.60	038555	
		Black	898.80	-	
	119" (3023 mm)	Clear	880.10	010262	2
		Dark Bronze	1,164.90	147624	
		Black	1,339.60	-	

1. Items with the price in **bold and red** are Quick Ship items and ship in 24 hours.
Please use stock number when ordering. 2. U/M is each unless otherwise noted.

12/10/2019
www.hagerco.com



Roton Continuous Geared Hinges

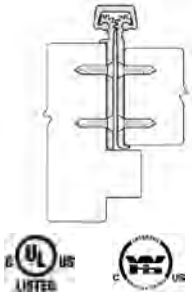

Description		Finish	2018 List	Stock No.	Case Qty.
780-224 Concealed Leaf 1-3/4" Doors Single Pack w/ Drill Quick Screws	79" (2007 mm)	Clear	139.30	183923	7
		Dark Bronze	181.70	194839	
		Black	209.00	-	
	83" (2108 mm)	Clear	139.30	184005	7
		Dark Bronze	181.70	184006	
		Black	209.00	-	
	95" (2413 mm)	Clear	176.60	184036	7
		Dark Bronze	228.30	194840	
		Black	262.50	-	

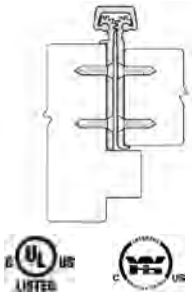

780-224HD Bulk Pack Concealed Leaf 1-3/4" Doors Case Pack w/ Drill Quick Screws Must Order Case Quantity	83" (2108 mm)	Clear	125.30	194841	7	
		Dark Bronze				
		Black				
	780-224HD Concealed Leaf 1-3/4" Doors Single Pack w/ Drill Quick Screws	79" (2007 mm)	Clear	173.80	183882	7
			Dark Bronze	226.00	183921	
			Black	259.90	-	
		83" (2108 mm)	Clear	173.80	184122	7
			Dark Bronze	226.00	183973	
			Black	259.90	183992	
85" (2159 mm)		Clear	173.80	184012	7	
		Dark Bronze	226.00	184014		
		Black	259.90	-		
95" (2413 mm)	Clear	210.50	184022	7		
	Dark Bronze	277.20	184023			
	Black	318.80	195809			
119" (3023 mm)	Clear	344.90	184039	5		
	Dark Bronze	449.00	194842			
	Black	516.40	195810			

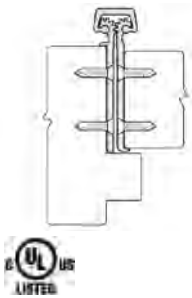

780-224HD Concealed Leaf 1-3/4" Doors Case Pack w/ Drill Quick Screws Must Order Case Quantity	83" (2108 mm)	Clear	156.40	194828	7
		Dark Bronze	203.50	194829	
		Black	234.00	-	
780-224LL Concealed Leaf 1-3/4" Doors Lead Lined With Half Drill Quick and Half Wood Screws Heavy Duty Profile Only	79" (2007 mm)	Clear	200.70	195181	7
		Dark Bronze	256.10	195221	
		Black	294.60	-	
	83" (2108 mm)	Clear	200.70	195184	7
		Dark Bronze	256.10	195222	
		Black	294.60	-	
	85" (2159 mm)	Clear	200.70	195223	7
		Dark Bronze	256.10	-	
		Black	294.60	-	
	95" (2413 mm)	Clear	242.70	195224	7
		Dark Bronze	298.80	195225	
		Black	343.60	-	
	119" (3023 mm)	Clear	381.70	195226	5
		Dark Bronze	492.00	-	
		Black	565.80	-	



Roton Continuous Geared Hinges

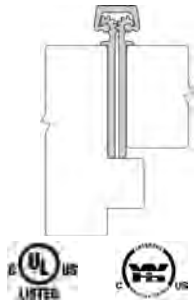

Description	Size	Finish	Year List	Stock No.	Case Qty.
780-226HD Concealed Leaf Heavy Duty For Doors 2" or Thicker Concealed Leaf Heavy Duty For Doors 2" or Thicker	79" (2007 mm)	Clear	207.90	194843	7
		Dark Bronze	274.20	194844	
		Black	315.40	-	
	83" (2108 mm)	Clear	207.90	183974	7
		Dark Bronze	274.20	194845	
		Black	315.40	195812	
	85" (2159 mm)	Clear	207.90	194846	7
		Dark Bronze	274.20	194849	
		Black	315.40	-	
95" (2413 mm)	Clear	253.00	184024	7	
	Dark Bronze	325.30	194850		
	Black	374.10	195813		
119" (3023 mm)	Clear	410.90	193587	5	
	Dark Bronze	533.70	194851		
	Black	613.70	195815		
780-226LL Concealed Leaf For Lead Lined Doors 2" or Thicker With Half Drill Quick and Half Wood Screws Heavy Duty Profile Only	79" (2007 mm)	Clear	225.30	195229	7
		Dark Bronze	287.00	-	
		Black	330.00	-	
	83" (2108 mm)	Clear	225.30	195235	7
		Dark Bronze	287.00	-	
		Black	330.00	-	
	85" (2159 mm)	Clear	225.30	-	7
		Dark Bronze	287.00	-	
		Black	330.00	-	
95" (2413 mm)	Clear	272.30	195236	7	
	Dark Bronze	327.20	195237		
	Black	376.30	-		
119" (3023 mm)	Clear	427.70	195238	5	
	Dark Bronze	551.00	195239		
	Black	633.70	-		
780-235HD Concealed Leaf Heavy Duty Wide Throw	83" (2108 mm)	Clear	483.40	195241	1
		Dark Bronze	632.80	195242	
		Black	727.70	-	
	95" (2413 mm)	Clear	596.60	195243	1
		Dark Bronze	760.10	195244	
		Black	874.10	-	

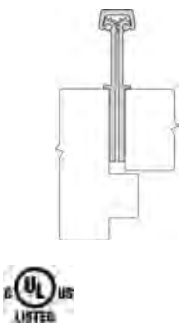
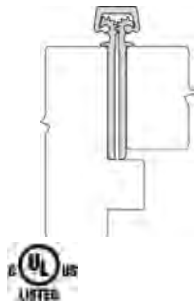

1. Items with the price in **bold and red** are Quick Ship items and ship in 24 hours.
Please use stock number when ordering. 2. U/M is each unless otherwise noted.



Roton Continuous Geared Hinges



Description	Size	Finish	Year List	Stock No.	Case Qty.
780-257HD Full Surface Heavy Duty Double hinge for hanging two doors from a fixed mullion.	79" (2007 mm)	Clear	505.50	-	2
		Dark Bronze	694.50	-	
		Black	798.60	-	
	83" (2108 mm)	Clear	505.50	081899	2
		Dark Bronze	694.50	159250	
		Black	798.60	-	
	85" (2159 mm)	Clear	505.50	112767	2
		Dark Bronze	694.50	158749	
		Black	798.60	-	
	95" (2413 mm)	Clear	622.10	028146	2
		Dark Bronze	854.00	161153	
		Black	982.10	-	
	119" (3023 mm)	Clear	927.60	162543	2
		Dark Bronze	1,272.90	-	
		Black	1,463.80	-	
780-300HD Half Surface Heavy Duty Center Hung Applications	79" (2007 mm)	Clear	360.80	010212	4
		Dark Bronze	490.10	019206	
		Black	563.10	-	
	83" (2108 mm)	Clear	360.80	047819	4
		Dark Bronze	490.10	057968	
		Black	563.10	-	
	85" (2159 mm)	Clear	360.80	061937	4
		Dark Bronze	490.10	038063	
		Black	563.10	-	
	95" (2413 mm)	Clear	443.80	047821	4
		Dark Bronze	602.10	047822	
		Black	692.40	-	
	119" (3023 mm)	Clear	661.00	015052	2
		Dark Bronze	898.20	011244	
		Black	1,033.00	-	

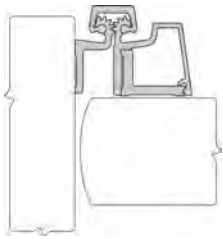

Roton Continuous Geared Hinges

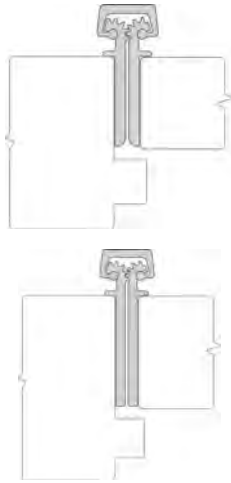

Description	Size	Finish	Year List	Stock No.	Case Qty.
1200-600XHD Concealed Leaf Extra Heavy Duty For doors from 1-3/4" to 2-3/8" thick.	83" (2108 mm)	Clear	1,016.40	000590	1
		Dark Bronze	1,422.50	028601	
	95" (2413 mm)	Clear	1,151.70	004040	1
		Dark Bronze	1,557.80	065709	
	119" (3023 mm)	Clear	1,287.20	090770	1
		Dark Bronze	1,693.20	107206	
1200-650XHD Concealed Leaf Extra Heavy Duty For doors 2-3/8" thick or thicker.	83" (2108 mm)	Clear	1,354.80	090353	1
		Dark Bronze	1,760.90	135473	
	95" (2413 mm)	Clear	1,490.20	090439	1
		Dark Bronze	1,896.20	108903	
	119" (3023 mm)	Clear	1,625.60	090440	1
		Dark Bronze	2,031.70	044852	

1. Items with the price in **bold and red** are Quick Ship items and ship in 24 hours.
Please use stock number when ordering. 2. U/M is each unless otherwise noted.

12/10/2019
www.hagerco.com





One Family. One Brand. One Vision.™

www.hagerco.com

TABLE OF CONTENTS

A		M	
ANSI Standards.....	2	Mortar Box.....	5
C		N	
Cancellation Notification	2	No Hole (Blank) Hinges	2
Concealed Electric Through-Wire.....	4-5	P	
Custom Hole Pattern	2	Powder Coat	3
Custom Length Hinges	2	Q	
D		Quick Connect.....	5
Dutch Door Hinges	3	Quick Ship.....	2
E		R	
Electrical Modifications Standard Locations.....	4	Raised Barrel.....	3
Electric Power Transfer Preparations (EPT)	5	Replacement Moldings	3
Exposed Electric Switches	5	S	
Extra Long Hinges.....	2	Security Fasteners.....	3
F		Security Studs.....	3
Fasteners.....	4	Sheared Leaf	3
Fire Rating	2	Standard Lengths.....	2
H		T	
Hinges		Tamper Resistant Hospital Tips.....	3
Concealed Leaf	6-7	W	
Full Surface	7	Wide Throw	3
Half Surface	6		
Half Mortise.....	6		
How To Order.....	1		
L			
Lead Times	2		
Lead Lined.....	2		

HOW TO ORDER:

Example: 790-900 83 1/8" US32D 1 PK

Stock Number: 023043

Item Number: PS90083B32D000001

790

STAINLESS
STEEL
CONTINUOUS
HINGE

900

ITEM#

83

LENGTH

1/8"

FRACTION

US32D

FINISH

1 PK

STANDARD
SINGLE
PACK



Stainless Steel Continuous Hinges

ANSI Standards

790 Series stainless steel continuous hinges are approved for ANSI A156.26 Grade 1 for 150-pound doors.

Fire Rating

Hager 790 Series hinges are approved by Underwriters Laboratories, Inc. Fire Rated label for up to 3 hours for metal doors and 90 minutes for wood composite doors.



Lead Times

Stock items will typically ship in five working days or less from the order entry date. Made-to-order items will typically ship in 15 working days depending on seasonal volume and order complexity. Special orders including industrials, special machining, and large quantities may need to be scheduled. The anticipated ship date will be included with each order acknowledgement. Please contact Customer Service if product availability is in question.

Quick Ship

Products denoted with **red and bold** pricing are available to order through the Quick Ship program and ship within 24 hours. When ordering these products please visit www.hagerco.com and log in to MyHager to access the 'Quick Ship' portal. Due to the promptness of the fulfillment process, Quick Ship orders are non-cancellable.

Cancellation Notification

Cancellation for made-to-order items must be communicated within 48 hours of order placement.

Standard Lengths

Stainless steel hinges are listed and priced as actual lengths 83-1/8" (7'0" opening), 85" (7'2" opening), 95" (8'0" opening), and 119" (10'0" opening) for convenience in application to nominal sized doors. Other lengths may be ordered as non-standard items.

Extra Long Hinges

Hinges over 119" are manufactured as two separate lengths with staggered joints for on-site connection.

MODIFICATIONS & ADDITIONS

ADDITION TO LIST PRICE

Custom Length Hinges

Actual door height may be specified at an additional charge outlined:

- For hinges 40" to 83" in length **\$68.15** to 7' list price.
- For hinges 83" to 95" in length **\$68.15** to 8' list price.
- For hinges 95" to 119" in length **\$68.15** to 10' list price.
- For hinges 119" to 192" in length **\$156.00** to the list price

Custom Hole Pattern

- Any hole pattern or shape other than Hager's standard hole pattern.

Price on Application

No Hole (Blank) Hinges

- Holes omitted for special applications (i.e. welded installation).

Price on Application

Lead Lined Hole Pattern

- Only available on Models 790-900, 790-911 and 790-915.

Price on Application



MODIFICATIONS & ADDITIONS

ADDITION TO LIST PRICE

Powder Coat

- Available in aluminum, dark bronze, satin bronze, satin brass, black, or white. Lead time of up to 8-10 weeks may be required.

Price on Application

Tamper Resistant Hospital Tips (HT)

- Custom lengths
- Available on concealed leaf models 790-900, 790-905, 790-907, 790-915, for standard lengths.

\$113.65

Price on Application

Dutch Door Prep (DUTCH)

- Furnished as a continuous frame leaf while door leaf is cut to fit dutch door specified height.

\$113.65

Wide Throw

- Specify distance from pin centerline to heel edge of hinge.

Price on Application

Raised Barrel (SWAGED)

- Available on concealed and half surface models.

Price on Application

Sheared Leaf

- Available on all models except 790-904 and 790-906.
- Specify distance from pin centerline to extreme edge of hinge when ordering.

Price on Application

Security Studs

- Stainless steel security studs mounted through frame leaf into door frame.
- Door and frame must be specifically prepped to accommodate security studs.
- Door leaf is drilled to accommodate studs.

\$80.00

Replacement Moldings (M)

Hinge lengths:

79", 83", 85"

95"

119"

\$168.10

\$181.70

\$198.95

- Shipped in stock lengths for trimming in the field.

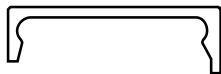

- Brush aluminum & furnished with 5 each molding clips, 5 each 1/4"-14 x 1" panhead 2C screws.
- Available on models 790-903, 790-904, 790-906 and 790-909.

Security Fasteners

- Torx and Spanner Head available in place of standard fasteners.

\$79.55



Stainless Steel Continuous Hinges

MODIFICATIONS & ADDITIONS

Additional Fasteners

#10-24 x 5/8" Torx Head Machine Screw	\$2.80 /ea
#10-16 x 1-1/4" Thread Forming Flat Head Screw	\$1.20 /ea
1/4"-14 x 1" Thread Forming Pan Head Screw	\$1.75 /ea
#10-24 x 5/8" Self-Drilling Flat Head Screw	\$1.75 /ea
1/4"-20 x 3/4" Self-Drilling Pan Head Screw	\$1.50 /ea
Adjustment Stud With Flat Head Screw	\$8.40 /ea
Sexbolt and Nut	\$5.20 /ea

STANDARD LOCATIONS FOR ELECTRICAL MODIFICATIONS

	79"	83"	85"	95"	119"
Opening	80"	84"	86"	96"	120"
Door Height	79-1/8"	83-1/8"	85-1/8"	95-1/8"	119-1/8"
Hinge Length	79-3/16"	83-1/8"	85-1/8"	95"	118-3/4"
ETW	41-1/2"	43-1/2"	45-1/2"	55-3/8"	79-1/8"
EPT	24-1/2"	28-7/16"	30-7/16"	40-1/2"	64-7/16"
E1S	41-1/2"	43-1/2"	45-1/2"	55-3/8"	79-1/8"

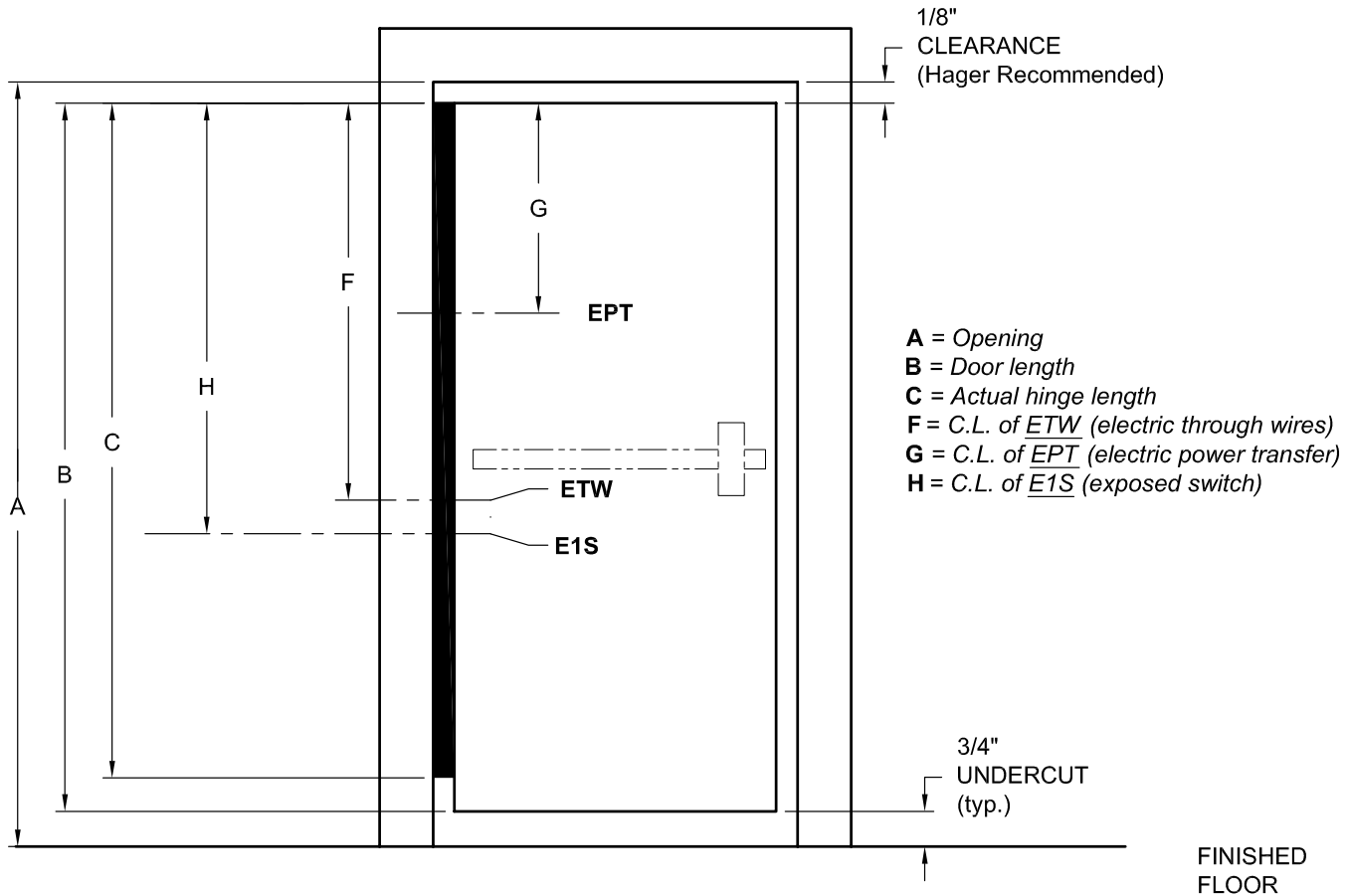

MODIFICATIONS & ADDITIONS

ADDITION TO LIST PRICE

Quick Connect

Available for ETW.

\$45.60

Electric Power Transfer Preparations (EPT)

\$130.25

- Hinge leaf cutout to accommodate power transfer device.
- Specify handing and dimension from top of hinge to centerline of power transfer cutout location. Please note the clearance from top of hinge to underside of header, typically 1/16" to 1/8" (1.6 mm to 3.2 mm).
- Available on models 790-900, 790-903, 790-904, and 790-915.

Exposed Electric Switches (E1S)

\$200.55

- Each monitoring hinge only needs one E1S switch.
- Specify handing and dimension from top of hinge to centerline of electric switch.
- Miniature push button switch is incorporated in the hinge frame leaf to monitor position of the door.

Concealed Electric Through-Wire (ETW)

Electric Through Wire	ETW - 4	\$579.55
Electric Through Wire	ETW - 8	\$866.95
Electric Through Wire	ETW - 10	\$1,169.05

- 24-gauge 12" wire leads available on 790-900 and 790-915.
- Transfers power discretely from building to door hardware.
- Specify handing and dimension from the top of hinge to the centerline of the electric through-wire location. ETW Centerline must be between two consecutive hinge knuckles. Please note, the clearance from top of hinge to underside of header is typically 1/16" to 1/8" (1.6 mm to 3.2 mm).

Mortar Box - 430

\$45.55

- Serves as mortar shield.
- Top and bottom knockouts for standard conduit fittings.
- Overall dimensions are 9" (229 mm) length with tabs 7" (178 mm). Inside is 1-3/4" x 1-3/4" (45 mm x 45 mm).
- Galvanized steel .040" (1 mm).



Stainless Steel Continuous Hinges

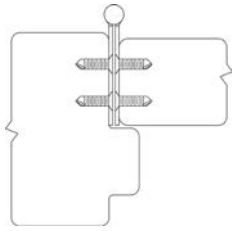

Description		Finish	2018 List	Stock No.	Case Qty.
790-900 Concealed Leaf, 1/8" Inset Door of Any Material	79" (2007 mm)	US32D	435.00	27336	1
	83" (2108 mm)	US32D	435.00	23243	1
	85" (2159 mm)	US32D	495.00	27921	1
	95" (2413 mm)	US32D	500.00	23250	1
	119" (3023 mm)	US32D	725.00	23251	1

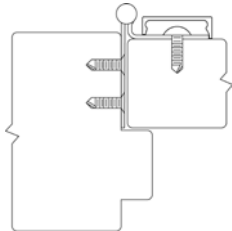

790-903 Half Surface, 1/8" Inset Door of Any Material Optional sex bolts available (specify when ordering).	79" (2007 mm)	US32D	500.00	42721	1
	83" (2108 mm)	US32D	500.00	23254	1
	85" (2159 mm)	US32D	580.00	53025	1
	95" (2413 mm)	US32D	580.00	23256	1
	119" (3023 mm)	US32D	740.00	23260	1

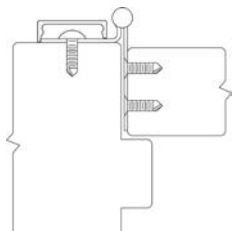

790-904 Half Mortise, 1/8" Inset Door of Any Material	79" (2007 mm)	US32D	505.00	71952	1
	83" (2108 mm)	US32D	505.00	52990	1
	85" (2159 mm)	US32D	605.00	92025	1
	95" (2413 mm)	US32D	605.00	52993	1
	119" (3023 mm)	US32D	785.00	52994	1

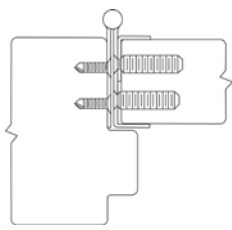

790-905 Concealed Leaf, 1/8" Inset Door of Any Material	79" (2007 mm)	US32D	560.00	65223	1
	83" (2108 mm)	US32D	560.00	23266	1
	85" (2159 mm)	US32D	640.00	36876	1
	95" (2413 mm)	US32D	640.00	23265	1
	119" (3023 mm)	US32D	955.00	23267	1

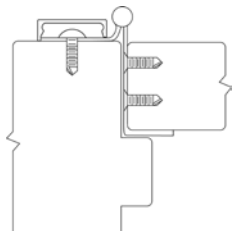

790-906 Half Mortise, Edge Guard Door of Any Material	79" (2007 mm)	US32D	505.00	92102	1
	83" (2108 mm)	US32D	505.00	92103	1
	85" (2159 mm)	US32D	605.00	92105	1
	95" (2413 mm)	US32D	605.00	92107	1
	119" (3023 mm)	US32D	785.00	92110	1



Stainless Steel Continuous Hinges

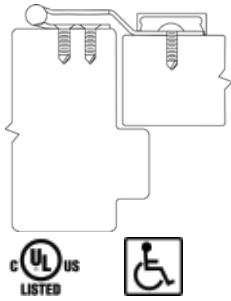

Description		Finish	2018 List	Stock No.	Case Qty.
790-909 Full Surface, 1/8" Inset Swing Clear Door of Any Material Optional sex bolts available (specify when ordering).	79" (2007 mm)	US32D	605.00	38978	1
	83" (2108 mm)	US32D	605.00	23270	1
	85" (2159 mm)	US32D	695.00	47643	1
	95" (2413 mm)	US32D	695.00	23271	1
	119" (3023 mm)	US32D	890.00	23279	1

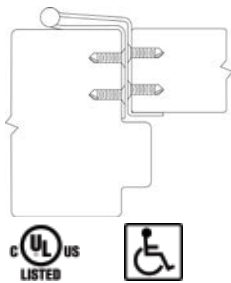

790-911 Concealed Leaf Swing Clear Door of Any Material	79" (2007 mm)	US32D	630.00	9412	1
	83" (2108 mm)	US32D	630.00	23284	1
	85" (2159 mm)	US32D	645.00	89831	1
	95" (2413 mm)	US32D	645.00	23285	1
	119" (3023 mm)	US32D	985.00	23286	1

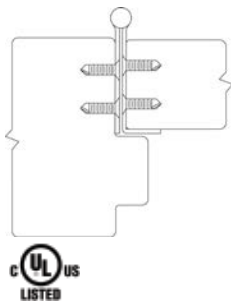

790-915 Concealed Leaf, 1/16" Inset Door of Any Material	79" (2007 mm)	US32D	525.00	33963	1
	83" (2108 mm)	US32D	525.00	23287	1
	85" (2159 mm)	US32D	595.00	40111	1
	95" (2413 mm)	US32D	595.00	23288	1
	119" (3023 mm)	US32D	885.00	23289	1

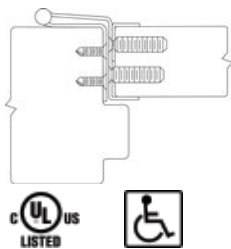

790-926 Concealed Leaf Swing Clear Door of Any Material	79" (2007 mm)	US32D	780.00	45597	1
	83" (2108 mm)	US32D	780.00	26760	1
	85" (2159 mm)	US32D	880.00	50336	1
	95" (2413 mm)	US32D	880.00	26761	1
	119" (3023 mm)	US32D	1,065.00	26762	1

1. Items with the price in **bold and red** are Quick Ship items and ship in 24 hours.
Please use stock number when ordering. 2. U/M is each unless otherwise noted.





One Family. One Brand. One Vision.™

www.hagerco.com

TABLE OF CONTENTS

	A		F	
Additions.....		4	Fasteners.....	4
Architectural Finish Symbols.....		3		
Armor Plates.....		6-8		
	C			
Chain Door Check		78		
Coat Hooks		92, 102-103, 125		
Corner Guard		65		
Custom Pulls			Filler Plates	
18 Degree Pull		116-117	Filler Plate, Door Face	83
90 Degree Pull		100	Filler Plate, Flush Bolt Strike	84
Acorn Tip Pull		104-105	Filler Plate, Door Edge	83-84
Colonial Pull		101	Filler Plate, Template Hinge Shim.....	84-85
C-Shaped Pulls.....		94-99	Filler Plate, Frame Strike	84
Curved Shape Pulls.....		99, 105, 113-115	Filler Plate, Latch Adapter	84
Offset Mount, Vertical Pull		92-93, 105, 108, 109	Filler Plate, Flush Bolt.....	84
Offset Pulls.....		101-102, 115-116	Filler Plate, Frame Hinge.....	84
Segment Shape Pulls.....		109-112		
Square Tip Pull		103-104	Flush Bolts	
S-Shaped Pulls.....		100	Automatic Flush Bolts.....	74-76
Steeple Tip Pull		104	Constant Latching Flush Bolt	75
Straight Mount, Vertical Pulls		93-94, 101, 103-110, 112	Dust Proof Strike	73
Crating		3	Automatic Flush Bolt with Fire Bolt	76
			Manual Flush Bolts	74
			Residential Flush Bolts	120-121
			Slide Flush Bolt.....	73
	D		H	
Door Coordinators			Hand Rail Bracket.....	78, 125
Carry Bar.....		76		
Coordinator with Filler Bar		77		
Filler Bars		77		
Gravity Coordinator		77		
Mounting Brackets.....		77		
Door Edgings				
Mortise Type		57-59		
Overlap Type.....		59-61		
Surface Type		62-64		
Door Guard.....		72, 120		
Door Knocker Viewer.....		80, 83		
Door Protection Plates		6-8, 119		
Door Latch (Privacy)		72-73, 120		
Door Silencers				
Metal Door		78		
Wood Door.....		79		
Door Viewers		122-123		
			K	
			Kick Plates	6-8, 119
			L	
			Latches	
			Hospital Latch, 2-3/4" Backset.....	79
			Hospital Latch, 5" Backset.....	79
			Hospital Latch, Lead Lined.....	79
			Latch Conversion Kit.....	79
			Pocket Door Latch.....	82
			Privacy Pocket Door Latch	82-83
			Latch Protectors	85



Trim & Auxiliary

M

Miscellaneous Hardware

- Closet Knobs 118
- Closet Rod, Sockets 123, 125
- Closet Pull Sockets 117-119
- Concealed Edge Pull 21
- Finger Pulls 117-119
- Magnetic Catch 122
- Pocket Door Edge Pulls 119
- Shelf Brackets 124
- Mounting Options 5

P

Pulls

- Anti Vandal Trim 79
- Back-to-Back Offset Pulls 20-22
- Back-to-Back Straight Pulls 16-17
- Cast Pulls 12-13, 19
- Flush Cup Pulls 18-19, 22-23
- Half Round 9
- Offset Pulls 15-16, 22
- Oval 13-14
- Rectangular 9-10
- Round 10-12, 14-16
- Straight Pulls 9-14
- Wire Drawer Pulls 78

Pull Plates

- Cylinder Pull 43
- Pull Plate w/ Lip 43
- Square Corner 26-34

Push Bars

- Back-to-Back 46
- Bent 44-46
- Flat 44
- Round 45-46

Push Plates

- Beveled - Square Corner 38-40
- Half Circle 43
- Plastic Laminate 38-39
- Radius Corner 35-36, 41
- Round Bevel Top and Bottom 42
- Rounded Corner 37-38
- Square Corner 24-25

Push/Pull Sets

- Flat Bar 56
- Round Bar 16-17, 19-21, 22, 46-56
- Security Push/Pull Plate 43

R

- Recommended Application 3
- Recommended Maintenance 3
- Residential Trim 78, 81, 117-121

Roller Latch/Catches

- Adjustable Ball Catch 80
- Drive-In Ball Catch 122
- Roller Latch 80
- Roller Latch with Stop 80
- Roller Latch w/ ASA Strike 117
- Roller Latch w/ Full Lip Strike 117
- Roller Latch w/ Tee Strike 80
- Three-Way Ball Catch 80

S

Signage

- ADA Tactile, Plastic 89-91
- International Symbols, Plastic 89
- Men/Women, Metal 88
- Men/Women, Plastic 86-87
- Numbers, Plastic 86
- Push/Pull, Metal 88
- Push/Pull, Plastic 86-87
- Restroom/Restrooms, Plastic 87-88

Stops and Holders

- Roller Bumper 71-72
- Door Holder, Kickdown 71, 119
- Floor Stops 66-72, 81-82, 119, 124
- Heavy Duty Floor Stop 71
- Stops With Holder 68-70, 81-82
- Wall Stops 65-66, 68-70, 81-82, 120, 124
- Hinge Pin Door Bumper 78, 120, 124
- Surface Bolts 72-73

CRATING CHARGES

When ordered separately, orders of less than 5 armor plates (plates over 22 inches high and wide) are subject to a \$15.60 net crating charge.

ARCHITECTURAL FINISH SYMBOLS

Unless specifically noted, finishes are priced as listed by each item on the following pages.

US & HAGER	DESCRIPTION	BASE MATERIAL	PRICING INSTRUCTIONS	BHMA SYMBOL
2C	Zinc Plated Steel	Steel	As Listed	603
3	Bright Brass	Brass	As Listed	605
4	Satin Brass	Brass	As Listed	606
5	Satin Brass, Oxidized	Brass Brass/Bronze	25% Above US10B	609
9	Bright Bronze	Brass Brass/Bronze	25% Above US10	611
10	Satin Bronze	Brass Brass/Bronze	As Listed	612
10B	Antique Bronze, Oiled	Brass Brass/Bronze	As Listed	613
10R	Matte Lacquer Antique Bronze	Brass Brass/Bronze	As Listed	-
15	Satin Nickel	Brass Brass/Bronze	Price Same as US26D	619
15A	Satin Nickel Oxidized	Brass Brass/Bronze	As Listed	620
19	Flat Black Coated	Any	As Listed ¹	693
26	Bright Chromium Plated	Brass Brass/Bronze	As Listed	625
26D	Satin Chromium Plated	Brass Brass/Bronze	As Listed	626
28	Satin Anodized Aluminum	Aluminum	As Listed	628
32	Stainless Steel Metal, Bright	300 Series	As Listed	629
32D	Stainless Steel Metal, Satin	300 Series	As Listed	630
DBZ	Dark Bronze Painted	Any	As Listed	695
PC	Clear Plastic	-	As Listed	-
PK	Plastic Laminate - Black	-	As Listed	-
CO	Plastic Laminate - Chocolate	-	As Listed	-
PG	Plastic Laminate - Grey	-	As Listed	-
S1	Sprayed Aluminum	Cast Iron	As Listed	-
S2	Sprayed Brass	Cast Iron	As Listed	-
S3	Sprayed Bronze	Cast Iron	As Listed	-

1. Same as DBZ unless otherwise listed.

NOTE: For any finish not listed in this Price Book, or explained above, price and availability on request.

RECOMMENDED SPECIAL INSTRUCTIONS:

Application: All accessory item installation should be made following the application of paint or other finishes. Under no circumstances should accessory items be installed prior to painting. Paint or other finish material must be dry before applying accessory items to door. Hager recommends that a 72 hour drying time be allowed prior to application of accessory items under normal atmospheric conditions.

Maintenance: For cleaning, use only a soft damp cloth. Do not use any chemicals, abrasive cleaners, waxes, or brass cleaners on items with a lacquer coating or on plastic plates.

Trim & Auxiliary

ADDITIONS WHERE NOT LISTED

Door Edgings

For quantities less than 20 of one type of door edging, add 30% to list price.

Pull, Push Plate, Pull Plate, or Kick Plate Options

Add to the list price of each unit:

Antimicrobial Powder Coat Protection (32D only)

To order use MV3 as suffix - \$14.50 list price each

Flush Back Mounting on Pull Plates

\$10.95 list each plate.

Cutouts - Standard Locations (Not available on Kick Plates)

Wrought (.050) thickness -

-Cut for 1-1/4" (CFC) Standard Cylinder, add \$14.95 each.

-Cut for 2-1/8" (CFC) Cylinder or Turn Piece, add \$14.95 each.

Other thickness plates -

-Cut for 1-1/4" (CFC) Standard Cylinder, add \$17.85 each.

-Cut for 2-1/8" (CFC) Cylinder or Turn Piece, add \$17.85 each.

Cutouts - Non-Standard Locations

Priced on application.

Engraving

For engraving standard "PUSH" or "PULL", "Men" or "Women" for stainless steel, add \$44.25 each, \$88.50 set.

For engraving standard "PUSH" or "PULL", "Men" or "Women" for all other materials, add \$30.05 each, \$60.15 set.

Tactile Warning

Available on limited items. Add \$41.05 to list.

Pull Plates - Non-Standard

To price pull plates not listed in price book, add list price of pull desired to the list price of the plate desired, plus \$4.80 list for assembly charge (and any other options required). Add \$5.00 list for punching two holes in push plates.

Accessibility Option

For Hager Special Accessibility Clearance - (2-1/2"), prefix "H". Add \$6.35 List for single pull and \$12.65 List for double pull.

FASTENERS

Illustrated below are various types of fasteners that can be furnished by Hager Companies. Please specify type of fastening desired. All types of fastening cannot be used with all items of hardware. If specified method is not possible, we reserve the right to furnish whatever type we feel is best suited for the installation. When used with tempered glass doors, specify thickness of glass and hole diameter.



Hex bolt and machine screws
(various sizes)



Lead anchor
(used with floor stops in masonry applications)



Plastic anchor and full threaded screw
(used in drywall or masonry applications)



Lag screw and shield

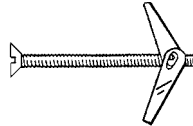

Toggle bolt
(ideal for drywall applications)

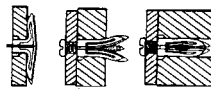

Plastic toggle anchor
(used with wall stops in drywall applications)



Thru-bolt and finish washer
(flat or oval head; size as required)



Spanner head machine screws
(various sizes furnished at extra charge)



Security torx head machine screws
(various sizes furnished at extra charge)

Note: Torx and Spanner screws are available for select items. Please call Customer Service for availability and price.

MOUNTINGS

Illustrated below are various types of mountings that can be furnished by Hager Companies. Please specify type of mounting desired. All types of mountings cannot be used with all items of hardware. If specified method is not possible, we reserve the right to furnish whatever type we feel is best suited for the installation. When used with tempered glass doors specify thickness of glass and hole diameter.

Mounting Accessory Charges:

For Concealed Cone mountings, add \$10.95 list for each required fitting (Type 3).
 For Concealed Cone mountings, add \$10.95 list for each required fitting (Type 5).
 For Spanner Collar mountings, add \$18.80 list for each required fitting (Type 7).
 For Concealed Cone and Lug mountings, add \$27.75 list for each required fitting. (.125" plate only)

Temper Glass Door Installation:

Spanner Cap Mountings (Type 8) for tempered glass doors, add \$18.80 list for each spanner cap.
 Note: Mounting back-to-back or spanner cap installation requires at least two fittings.
 Stile Plates, add \$15.70 list each.

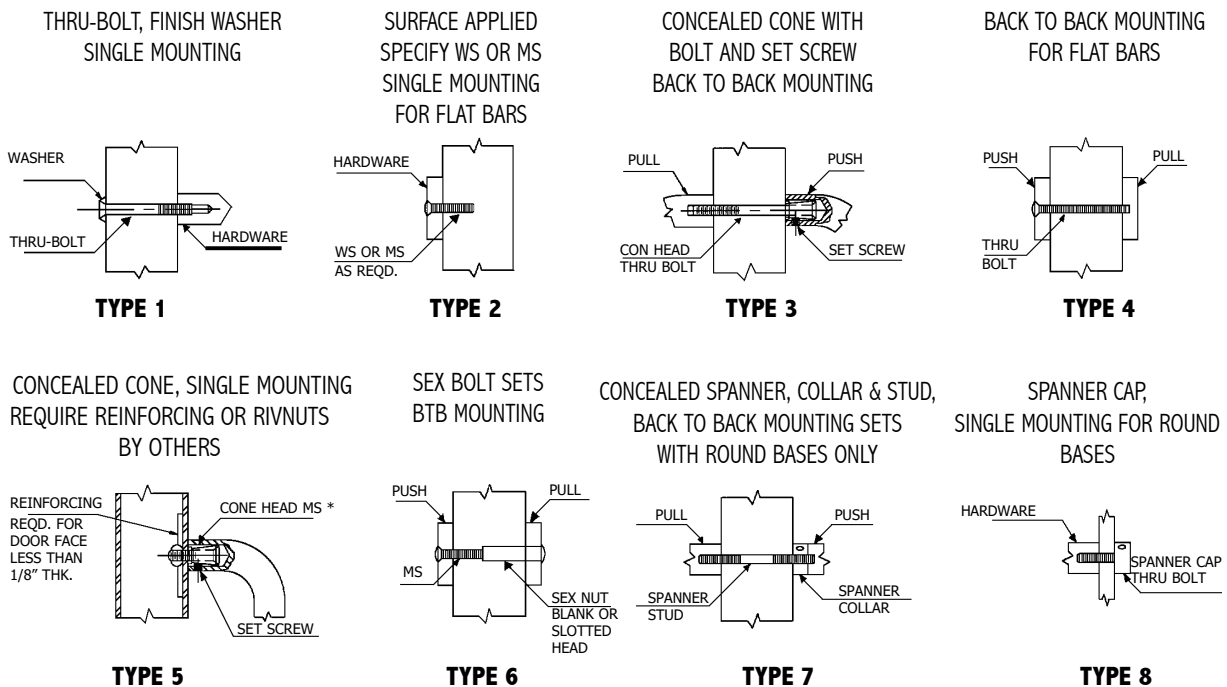

Lead Times

Stock items will typically ship in five working days or less from the order entry date. Made-to-order items will typically ship in 15 working days depending on seasonal volume and order complexity. Special orders including industrials, special machining, and large quantities may need to be scheduled. The anticipated ship date will be included with each order acknowledgement. Please contact Customer Service if product availability is in question.

Quick Ship

Products denoted with **red and bold** pricing are available to order through the Quick Ship program and ship within 24 hours. When ordering these products please visit www.hagerco.com and log in to MyHager to access the 'Quick Ship' portal. Due to the promptness of the fulfillment process, Quick Ship orders are non-cancellable.

Cancellation Notification

Cancellation for made-to-order items must be communicated within 48 hours of order placement.



Trim & Auxiliary

DOOR PLATE HUNDRED SQUARE INCH SIZE CHART													
H/W	24"	26"	28"	30"	32"	34"	36"	38"	40"	42"	44"	46"	48" MAX
4"	0.96	1.04	1.12	1.20	1.28	1.36	1.44	1.52	1.60	1.68	1.76	1.84	1.92
6"	1.44	1.56	1.68	1.80	1.92	2.04	2.16	2.28	2.40	2.52	2.64	2.76	2.88
8"	1.92	2.08	2.24	2.40	2.56	2.72	2.88	3.04	3.20	3.36	3.52	3.68	3.84
10"	2.40	2.60	2.80	3.00	3.20	3.40	3.60	3.80	4.00	4.20	4.40	4.60	4.80
12"	2.88	3.12	3.36	3.60	3.84	4.08	4.32	4.56	4.80	5.04	5.28	5.52	5.76
14"	3.36	3.64	3.92	4.20	4.48	4.76	5.04	5.32	5.60	5.88	6.16	6.44	6.72
16"	3.84	4.16	4.48	4.80	5.12	5.44	5.76	6.08	6.40	6.72	7.04	7.36	7.68
18"	4.32	4.68	5.04	5.40	5.76	6.12	6.48	6.84	7.20	7.56	7.92	8.28	8.64
20"	4.80	5.20	5.60	6.00	6.40	6.80	7.20	7.60	8.00	8.40	8.80	9.20	9.60
22"	5.28	5.72	6.16	6.60	7.04	7.48	7.92	8.36	8.80	9.24	9.68	10.12	10.56
24"	5.76	6.24	6.72	7.20	7.68	8.16	8.64	9.12	9.60	10.08	10.56	11.04	11.52
26"	6.24	6.76	7.28	7.80	8.32	8.84	9.36	9.88	10.40	10.92	11.44	11.96	12.48
28"	6.72	7.28	7.84	8.40	8.96	9.52	10.08	10.64	11.20	11.76	12.32	12.88	13.44
30"	7.20	7.80	8.40	9.00	9.60	10.20	10.80	11.40	12.00	12.60	13.20	13.80	14.40
32"	7.68	8.32	8.96	9.60	10.24	10.88	11.52	12.16	12.80	13.44	14.08	14.72	15.36
34"	8.16	8.84	9.52	10.20	10.88	11.56	12.24	12.92	13.60	14.28	14.96	15.64	16.32
36"	8.64	9.36	10.08	10.80	11.52	12.24	12.96	13.68	14.40	15.12	15.84	16.56	17.28
38"	9.12	9.88	10.64	11.40	12.16	12.92	13.68	14.44	15.20	15.96	16.72	17.48	18.24
40"	9.60	10.40	11.20	12.00	12.80	13.60	14.40	15.20	16.00	16.80	17.60	18.40	19.20
42"	10.08	10.92	11.76	12.60	13.44	14.28	15.12	15.96	16.80	17.64	18.48	19.32	20.16
44"	10.56	11.44	12.32	13.20	14.08	14.96	15.84	16.72	17.60	18.48	19.36	20.24	21.12
46"	11.04	11.96	12.88	13.80	14.72	15.64	16.56	17.48	18.40	19.32	20.24	21.16	22.08
48" MAX	11.52	12.48	13.44	14.40	15.36	16.32	17.28	18.24	19.20	20.16	21.12	22.08	23.04

To figure the list price of a door protection plate, find the hundred square inch size on the chart above. For odd or fractional sizes use the next higher price (i.e. 8" x 31-1/2" - price as 8" x 32" = 2.56 sq. inches). Multiply the square inch size by the list price (for example, 2.56 sq. inches x US\$31.10 = \$79.62 list).

- #6 x 5/8" Phillips Oval Head undercut, Stainless Steel Sheet Metal Screws for counter sunk plates and Truss Head Stainless Steel Screws for non-counter sunk plates, to match plated finish.
- When ordered separately, orders of less than 5 armor plates are subject to a \$15.60 net crating charge (plates over 22 inches high and wide).
- Four rounded corners are available for \$20.00 list.
- Kickplates specified with adhesive tape will be supplied without holes.
- Armor plates available with UL listing. See page 7.
- Cutouts for kick and armor plates priced on application.

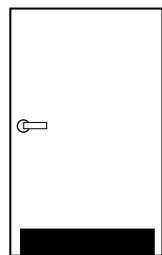

Mop Plate
Up to 8"h x 48"w

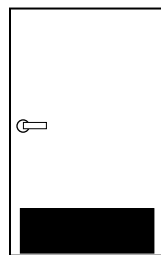

Kick Plate
6"-12"h x 48"w



Stretcher Plate
6"-12"h x 48"w

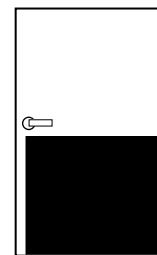

Armor Plate
Up to 48"h x 48"w

NFPA 80 STANDARD 6.4.5.3

- Factory installed protection plates shall be installed in accordance with the listing of the door.
- Field installed protection plate shall be labeled and installed in accordance with their listing.

Exception: Labeling is not required where the top of the protection plate is not more than 16" (406 mm) above the bottom of the door.



10/06/2020

www.hagerco.com



Description	Height	US3, US4,		DBZ		US32	US32D
		US28	US10	US19, US9	US10B		
190S	Under 8" high	11.25	31.80	37.10	46.40	22.15	9.95
Four beveled edges	8" to 24" high	9.50	31.10	36.45	45.55	21.55	8.90
.050 Gauge	Over 24" to 36" high	10.10	39.75	45.20	56.50	21.80	9.15
Metal Door Protection Plate	Over 36" to 48" high	10.10	47.95	54.80	68.55	21.80	9.15
Note: UL Listed for US32 and US32D only	8" x 34" (List Pricing)	-	-	-	-	-	24.21
	10" x 34" (List Pricing)	-	-	-	-	-	30.26



198S	Under 8" high	-	-	-	-	-	9.45
.038 Gauge	8" to 24" high	-	-	-	-	-	8.40
Metal Door Protection Plate	Over 24" to 36" high	-	-	-	-	-	8.65
	Over 36" to 48" high	-	-	-	-	-	8.65

Note: UL labeling not required when top of plate is less than 16" above the bottom of the door, per NFPA 80 - 2007.



Description	Height	BGA
199B	Under 8" high	11.05
Bright Gold Anodized	8" to 24" high	9.30
100 square inches	Over 24" to 36" high	9.35
.038 Gauge	Over 36" to 48" high	10.20
Metal Door Protection Plate		



Description	Height	Color				
		Plastic	Black	Brown	Grey	Grey
204S	Up to 48" high	9.10	-	-	-	-
Clear Plastic						
.125 Gauge						



214S	Up to 48" high	-	11.00	15.05	15.05	15.05
Plastic Laminate						
.125 Gauge						



Description	Height	US3, US4,		DBZ,		US32	US32D
		US28	US10	US19, US9	US10B		
220S	Under 8" high	14.00	32.75	44.85	56.05	-	22.85
Four beveled edges	8" to 24" high	14.00	32.75	44.85	56.05	-	22.85
.062 Gauge	Over 24" to 36" high	15.00	35.40	48.95	61.20	-	22.85
Metal Door Protection Plate	Over 36" to 48" high	16.40	38.10	51.60	64.55	-	22.85

Note: Diamond plate is available in US26. Use US3/US4/US10 pricing.



Trim & Auxiliary



Description	Height	Black (Calcutta)	Brown (Chocolate)	Tan (Beige)
225S	Under 8" high	12.50	12.50	12.50
.060 Gauge	8" to 24" high	10.65	10.65	10.65
Kydex Door Protection Plate	Over 24" to 36" high	11.30	11.30	11.30
	Over 36" to 48" high	11.30	11.30	11.30

Note: UL labeling not required when top of plate is less than 16" above the bottom of the door, per NFPA 80 - 2007.

Option	Description	Price
CSK	Countersunk Holes	0.50 per 100 square inch price
SA	Self Adhesive Tape	0.50 per 100 square inch price
	Spanner Head Screws	0.50 each
	Torx Head Screws	0.50 each
	.125 Material	Price on Application
	Wrap Around Side & Bottom Return	Price on Application
	UL Label Stamp (No tape -voids UL Listing)	12.80





Description	Finish	2018 List	Stock No.	Box Qty.	Case Qty.
1E	US3	49.65	052830	1	12
Pull- Half Round	US4	53.45	063599		
Material: Brass, bronze, aluminum, stainless steel	US10	53.45	052831		
Base: 1/2" x 1"	US10B	66.81	052832		
Projection: 2"	DBZ	53.45	-		
Clearance: 1-1/2"	US26	53.45	022786		
CTC: 6"	US26D	53.45	052834		
Door Thickness: 1-3/4" standard	US28	28.50	052835		
Fasteners: 1/4"-20 x 2-1/4" FPHMS with washers	US32	51.95	074723		
Not suitable for BTB Mounting.	US32D	50.55	052836		
1G	US3	58.95	081562	1	12
Pull- Half Round	US4	63.50	028588		
Material: Brass, bronze, aluminum, stainless steel	US10	63.50	060015		
Base: 1/2" x 1"	US10B	79.40	078323		
Projection: 2"	DBZ	63.50	-		
Clearance: 1-1/2"	US26	63.50	030588		
CTC: 8"	US26D	63.50	066243		
Door Thickness: 1-3/4" standard	US28	30.05	056587		
Fasteners: 1/4"-20 x 2-1/4" FPHS with washers	US32	63.50	032021		
Not suitable for BTB Mounting.	US32D	63.30	058307		
1J	US3	69.10	073346	1	12
Pull- Half Round	US4	75.25	026724		
Material: Brass, bronze, aluminum, stainless steel	US10	75.25	067206		
Base: 1/2" x 1"	US10B	94.05	062739		
Projection: 2"	DBZ	75.25	-		
Clearance: 1-1/2"	US26	75.25	013936		
CTC: 10"	US26D	75.25	062738		
Door Thickness: 1-3/4" standard	US28	33.90	010948		
Fasteners: 1/4"-20 x 2-1/4" FPHMS with washers	US32	73.20	092494		
Not suitable for BTB Mounting.	US32D	70.10	072255		
1L	US3	79.20	022469	1	12
Pull- Half Round	US4	87.20	059759		
Material: Brass, bronze, aluminum, stainless steel	US10	87.20	019781		
Base: 1/2" x 1"	US10B	109.00	048642		
Projection: 2"	DBZ	87.20	-		
Clearance: 1-1/2"	US26	87.20	-		
CTC: 12"	US26D	87.20	085377		
Door Thickness: 1-3/4" standard	US28	41.90	067536		
Fasteners: 1/4"-20 x 2-1/4" FPHMS with washers	US32	85.40	060054		
Not suitable for BTB Mounting.	US32D	81.15	060014		
2E	US3	45.85	052812	1	12
Pull - Rectangular	US4	47.35	002326		
Material: Brass, bronze, aluminum, stainless steel	US10	47.35	091536		
Base: 3/8" x 1-1/4"	US10B	59.20	015641		
Projection: 2"	DBZ	47.35	-		
Clearance: 1-5/8"	US26	47.35	052815		
CTC: 6"	US26D	47.35	052816		
Door Thickness: 1-3/4" standard	US28	24.15	052817		
Fasteners: 1/4"-20 x 2-1/4" FPHMS with washers	US32	51.70	-		
Not suitable for BTB Mounting.	US32D	46.40	052818		

1. Items with the price in **bold and red** are Quick Ship items and ship in 24 hours.
Please use stock number when ordering. 2. U/M is each unless otherwise noted.



Trim & Auxiliary

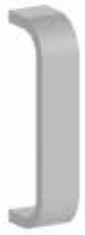

Description	Finish	2018 List	Stock No.	Box Qty.	Case Qty.
2G	US3	55.05	052819	1	12
Pull - Rectangular	US4	58.40	-		
Material: Brass, bronze, aluminum, stainless steel	US10	58.40	052820		
Base: 3/8" x 1-1/4"	US10B	73.00	052821		
Projection: 2"	DBZ	58.40	-		
Clearance: 1-5/8"	US26	58.40	120486		
CTC: 8"	US26D	58.40	008573		
Door Thickness: 1-3/4" standard	US28	25.95	052824		
Fasteners: 1/4"-20 x 2-1/4" FPHMS with washers	US32	60.00	-		
Not suitable for BTB Mounting.	US32D	56.65	052825		
2J	US3	65.05	099284	1	12
Pull - Rectangular	US4	70.55	111300		
Material: Brass, bronze, aluminum, stainless steel	US10	70.55	137339		
Base: 3/8" x 1-1/4"	US10B	90.05	083743		
Projection: 2"	DBZ	72.05	-		
Clearance: 1-5/8"	US26	72.05	-		
CTC: 10"	US26D	72.05	067318		
Door Thickness: 1-3/4" standard	US28	29.10	072355		
Fasteners: 1/4"-20 x 2-1/4" FPHMS with washers	US32	40.20	-		
Not suitable for BTB Mounting.	US32D	69.30	063689		
2L	US3	68.30	137565	1	12
Pull - Rectangular	US4	72.90	078244		
Material: Brass, bronze, aluminum, stainless steel	US10	76.00	036307		
Base: 3/8" x 1-1/4"	US10B	95.00	001482		
Projection: 2"	DBZ	76.00	-		
Clearance: 1-5/8"	US26	76.00	-		
CTC: 12"	US26D	76.00	101506		
Door Thickness: 1-3/4" standard	US28	37.80	016671		
Fasteners: 1/4"-20 x 2-1/4" FPHMS with washers	US32	76.85	036632		
Note suitable for BTB Mounting.	US32D	73.85	068545		
3E	US3	52.00	052507	1	12
Pull - Round	US4	52.00	082808		
Material: Brass, bronze, aluminum, stainless steel	US10	55.00	052508		
Base: 3/4" diameter	US10B	68.75	052510		
Projection: 2-1/4"	DBZ	55.00	-		
Clearance: 1-1/2"	US26	55.00	052826		
CTC: 6"	US26D	55.00	052705		
Door Thickness: 1-3/4" standard	US28	22.00	052511		
Fasteners: 1/4"-20 x 2-1/4" FPHMS with washers	US32	54.00	003987		
	US32D	28.25	052512		
3G	US3	53.40	052706	1	12
Pull - Round	US4	53.40	054828		
Material: Brass, bronze, aluminum, stainless steel	US10	56.50	052707		
Base: 3/4" diameter	US10B	70.65	052513		
Projection: 2-1/4"	DBZ	56.50	-		
Clearance: 1-1/2"	US26	56.50	052827		
CTC: 8"	US26D	56.50	052708		
Door Thickness: 1-3/4" standard	US28	28.50	052709		
Fasteners: 1/4"-20 x 2-1/4" FPHMS with washers	US32	54.00	003987		
	US32D	30.00	052514		





Description	Finish	2018 List	Stock No.	Box Qty.	Case Qty.
3J	US3	54.75	058846	1	12
Pull - Round	US4	54.75	017703		
Material: Brass, bronze, aluminum, stainless steel	US10	63.95	059315		
Base: 3/4" diameter	US10B	79.95	058929		
Projection: 2-1/4"	DBZ	63.95	-		
Clearance: 1-1/2"	US26	63.95	067231		
CTC: 10"	US26D	63.95	060904		
Door Thickness: 1-3/4" standard	US28	37.00	064414		
Fasteners: 1/4"-20 x 2-1/4" FPHMS with washers	US32	55.75	009135		
	US32D	34.40	053788		
3L	US3	65.95	062658	1	12
Pull - Round	US4	72.35	044307		
Material: Brass, bronze, aluminum, stainless steel	US10	77.85	084100		
Base: 3/4" diameter	US10B	97.30	067606		
Projection: 2-1/4"	DBZ	77.85	-		
Clearance: 1-1/2"	US26	77.85	088253		
CTC: 12"	US26D	77.85	070804		
Door Thickness: 1-3/4" standard	US28	40.10	068010		
Fasteners: 1/4"-20 x 2-1/4" FPHMS with washers	US32	83.25	071641		
	US32D	59.20	056122		
4E	US32D	59.00	127369	1	12
Security Pull - Round					
Material: Stainless steel					
Base: 1" diameter					
Projection: 2-1/4"					
Clearance: 1-1/4"					
CTC: 6"					
Fasteners: 1/4"-20 x 2-1/4" FPHMS with washers					
P4E	US32D	68.95	085014	1	12
Security Pull - Round					
Material: Stainless steel					
Base: 1" diameter					
Projection: 2-1/4"					
Clearance: 1-1/4"					
CTC: 6"					
Fasteners: 3/8" - 16 x 1-1/4"					
Nyloc hex head cap screws					
Concealed mounting in door, use on hollow metal doors only.					
T4E	US32D	72.00	085015	1	12
Security Pull - Round					
Material: Stainless steel					
Base: 1" diameter					
Projection: 2-1/4"					
Clearance: 1-1/4"					
CTC: 6"					
Door Thickness: 1-3/4" standard					
Fasteners: 1/4" - 20 x 2-1/4" FTXMS with washers					
Security Torx, Thru Bolt Mounting					
4G	US3	75.15	052710	1	12
Pull - Round	US4	81.15	071068		
Material: Brass, bronze, aluminum, stainless steel	US10	91.40	052711		
Base: 1" diameter	US10B	117.65	052712		
Projection: 2-3/4"	DBZ	94.10	052712		
Clearance: 1-3/4"	US26	83.70	052828		
CTC: 8"	US26D	83.70	052713		
Door Thickness: 1-3/4" standard	US28	37.75	051945		
Fasteners: 1/4"-20 x 2-1/4" FPHMS with washers	US32	72.50	056698		
	US32D	53.15	051946		

1. Items with the price in **bold and red** are Quick Ship items and ship in 24 hours.
Please use stock number when ordering. 2. U/M is each unless otherwise noted.



Trim & Auxiliary



Description	Finish	2018 List	Stock No.	Box Qty.	Case Qty.
4H	US3	74.20	116804	1	12
Pull - Round	US4	74.20	-		
Material: Brass, bronze, aluminum, stainless steel	US10	81.65	-		
Base: 1" diameter	US10B	102.50	068290		
Projection: 2-3/4"	DBZ	81.65	-		
Clearance: 1-3/4"	US26	81.65	139764		
CTC: 9"	US26D	81.65	016412		
Door Thickness: 1-3/4" standard	US28	42.85	099188		
Fasteners: 1/4"-20 x 2-1/4" FPHMS with washers	US32	93.80	075526		
	US32D	68.90	037214		
4J	US3	90.15	052714	1	12
Pull - Round	US4	90.15	054807		
Material: Brass, bronze, aluminum, stainless steel	US10	91.40	052715		
Base: 1" diameter	US10B	117.65	052716		
Projection: 2-3/4"	DBZ	94.10	-		
Clearance: 1-3/4"	US26	92.10	052829		
CTC: 10"	US26D	92.10	052515		
Door Thickness: 1-3/4" standard	US28	34.00	052717		
Fasteners: 1/4"-20 x 2-1/4" FPHMS with washers	US32	74.85	060648		
	US32D	59.10	052516		
4L	US3	84.40	056307	1	12
Pull - Round	US4	84.40	062858		
Material: Brass, bronze, aluminum, stainless steel	US10	99.40	068316		
Base: 1" diameter	US10B	124.25	062875		
Projection: 2-3/4"	DBZ	99.40	-		
Clearance: 1-3/4"	US26	99.40	054951		
CTC: 12"	US26D	99.40	072906		
Door Thickness: 1-3/4" standard	US28	50.25	059808		
Fasteners: 1/4"-20 x 2-1/4" FPHMS with washers	US32	109.45	069478		
	US32D	84.30	054672		
5D	US3	33.45	048492	1	12
Pull - Round	US4	33.45	048493		
Material: Brass, bronze, aluminum, stainless steel	US10	36.15	048489		
Base: 5/8" diameter	US10B	45.20	048495		
Projection: 2-1/8"	DBZ	36.15	-		
Clearance: 1-1/2"	US26	36.15	007765		
CTC: 5-1/2"	US26D	36.15	048496		
Door Thickness: 1-3/4" standard	US28	22.80	048491		
Fasteners: 1/4"-20 x 2-1/4" FPHMS with washers	US32	42.30	-		
Not suitable for BTB Mounting.	US32D	31.45	048497		
5N	US3	50.25	052289	1	12
Cast Pull	US4	54.00	052290		
Material: Brass, bronze, aluminum, stainless steel	US10	57.70	052291		
Base: 5/8" x 1-3/16"	US10B	72.15	052292		
Projection: 2"	DBZ	57.70	-		
Clearance: 1-1/2"	US26	57.70	052808		
Length: 6-1/8"	US26D	57.70	052701		
CTC: 5-1/2"	US28	35.30	138885		
Door Thickness: 1-3/4" standard	US32D	63.30	052294		
Fasteners: 1/4"-20 x 2-1/4" FPHMS with washers					
Not suitable for BTB Mounting.					





Description	Finish	2018 List	Stock No.	Box Qty.	Case Qty.
6N	US3	38.80	052295	1	12
Cast Pull	US4	43.40	052296		
Material: Brass, bronze, aluminum, stainless steel	US10	53.70	052297		
Base: 1" diameter	US10B	67.15	052298		
Projection: 1-7/8"	DBZ	53.70	-		
Clearance: 1-3/8"	US26	53.70	028570		
O/A Length: 6-1/2"	US26D	53.70	052811		
CTC: 5-1/2"	US28	28.00	052299		
Door Thickness: 1-3/4" standard	US32D	55.40	052300		
Fasteners: 1/4"-20 x 2-1/4" FPHMS with washers					
Not suitable for BTB Mounting.					
7N	US3	49.00	052301	1	12
Cast Pull	US4	49.00	053309		
Material: Brass, bronze, aluminum	US10	57.00	052302		
Base: 2" diameter	US10B	71.25	052806		
Projection: 1-7/8"	DBZ	57.00	-		
Clearance: 1-3/8"	US26	57.00	052807		
CTC: 5-1/2"	US26D	57.00	052304		
Door Thickness: 1-3/4" standard	US28	25.00	052303		
Fasteners: 1/4"-20 x 2-1/4" FPHMS with washers					
Not suitable for BTB Mounting.					
8N	US3	49.00	052305	1	12
Material: Brass, bronze, aluminum	US4	49.00	053310		
Base: 2" diameter	US10	52.00	052306		
Projection: 1-7/8"	US10B	73.75	052700		
CTC: 5-1/2"	DBZ	59.00	-		
Clearance: 1-3/8"	US26	52.00	052805		
Fasteners: #8 x 1 OPHWS	US26D	45.00	052308		
Not suitable for BTB Mounting.	US28	25.00	052307		
P8N	US4	68.95	081356	1	12
Cast Pull	US26D	68.95	084188		
Material: Brass					
Base: 1-1/2" x 1-5/8"					
Projection: 2-1/4"					
CTC: 7-3/4"					
Clearance: 1-9/16"					
O/A Length: 8-3/4"					
Fasteners: 3/8 - 16 x 3/4" FPHMS					
Not suitable for BTB Mounting.					
9E	US3	39.30	078724	1	12
Pull - Oval	US4	39.30	031734		
Material: Brass, bronze, stainless steel	US10	44.25	017647		
Base: 1/2" x 3/4"	US10B	55.30	083301		
Projection: 2"	DBZ	44.25	-		
Clearance: 1-1/2"	US26	44.25	083270		
CTC: 6"	US26D	44.25	082917		
Door Thickness: 1-3/4" standard	US32	45.85	109645		
Fasteners: 1/4"-20 x 2-1/4" FPHMS with washers	US32D	45.35	066230		
Not suitable for BTB Mounting.					

1. Items with the price in **bold and red** are Quick Ship items and ship in 24 hours.
Please use stock number when ordering. 2. U/M is each unless otherwise noted.



Trim & Auxiliary



Description	Finish	2018 List	Stock No.	Box Qty.	Case Qty.
9G	US3	44.00	073348	1	12
Pull - Oval	US4	44.00	129264		
Material: Brass, bronze, stainless steel	US10	48.80	071399		
Base: 1/2" x 3/4"	US10B	61.00	076145		
Projection: 2"	DBZ	48.80	-		
Clearance: 1-1/2"	US26	48.80	-		
CTC: 8"	US26D	48.80	073350		
Door Thickness: 1-3/4" standard	US32	32.85	089854		
Fasteners: 1/4"-20 x 2-1/4" FPHMS with washers	US32D	39.25	073862		
Not suitable for BTB Mounting.					
9J	US3	48.85	032128	1	12
Pull - Oval	US4	48.85	021300		
Material: Brass, bronze, stainless steel	US10	53.45	026721		
Base: 1/2" x 3/4"	US10B	66.80	020045		
Projection: 2"	DBZ	53.45	-		
Clearance: 1-1/2"	US26	53.45	-		
CTC: 10"	US26D	53.45	068291		
Door Thickness: 1-3/4" standard	US32	54.50	112592		
Fasteners: 1/4"-20 x 2-1/4" FPHMS with washers	US32D	47.65	089049		
Not suitable for BTB Mounting.					
9L	US3	53.45	001447	1	12
Pull - Oval	US4	53.45	090944		
Material: Brass, bronze, stainless steel	US10	58.20	018507		
Base: 1/2" x 3/4"	US10B	72.75	095056		
Projection: 2"	DBZ	58.20	-		
Clearance: 1-1/2"	US26	58.20	-		
CTC: 12"	US26D	58.20	017368		
Door Thickness: 1-3/4" standard	US32	60.70	064516		
Fasteners: 1/4" x 2-1/4" FPHMS with washers	US32D	51.95	075733		
Not suitable for BTB Mounting.					
10L	US3	266.00	079250	1	8
Pull - Round	US4	266.00	094670		
Material: Brass, bronze, stainless steel	US10	295.30	002193		
Base: 1-1/4" diameter	US10B	369.15	084947		
Projection: 3"	DBZ	295.30	-		
Clearance: 1-3/4"	US26	295.30	030731		
CTC: 12"	US26D	295.30	023472		
Door Thickness: 1-3/4" standard	US32	263.90	097312		
Fasteners: 5/16" - 18 x 2-1/4" FPHMS with washers	US32D	224.05	067649		
10Q	US3	291.85	090612	2	8
Pull - Round	US4	291.85	010843		
Material: Brass, bronze, stainless steel	US10	312.35	034458		
Base: 1-1/4" diameter	US10B	390.45	087786		
Projection: 3"	DBZ	312.35	-		
Clearance: 1-3/4"	US26	312.35	-		
CTC: 18"	US26D	312.35	039520		
Door Thickness: 1-3/4" standard	US32	273.70	027254		
Fasteners: 5/16" - 18 x 2-1/4" FPHMS with washers	US32D	253.90	072664		





Description	Finish	2018 List	Stock No.	Box Qty.	Case Qty.
11E	US3	80.65	059597	-	2
90° Offset Pull - Round	US4	80.65	018312		
Material: Brass, bronze, aluminum, stainless steel	US10	84.30	060336		
Base: 3/4" diameter	US10B	105.40	060315		
Projection: 2-1/2"	DBZ	84.30	-		
Clearance: 1-3/4"	US26	84.30	040696		
CTC: 6"	US26D	84.30	075266		
Offset: 2-1/2"	US28	52.90	043401		
Door Thickness: 1-3/4" standard	US32	86.15	-		
Fasteners: 5/16" - 18 x 2-1/4" FPHMS with washers	US32D	67.25	057380		
Available with 45° offset					
11G	US3	84.95	063681	-	2
90° Offset Pull - Round	US4	84.95	047133		
Material: Brass, bronze, aluminum, stainless steel	US10	90.00	097774		
Base: 3/4" diameter	US10B	112.50	068662		
Projection: 2-1/2"	DBZ	90.00	-		
Clearance: 1-3/4"	US26	90.00	013867		
CTC: 8"	US26D	90.00	093586		
Offset: 2-1/2"	US28	59.90	067803		
Door Thickness: 1-3/4" standard	US32	91.40	109006		
Fasteners: 5/16" - 18 x 2-1/4" FPHMS with washers	US32D	73.85	066983		
Available with 45° offset					
11J	US3	89.90	073589	-	2
90° Offset Pull - Round	US4	89.90	087629		
Material: Brass, bronze, aluminum, stainless steel	US10	97.60	074842		
Base: 3/4" diameter	US10B	122.00	056958		
Projection: 2-1/2"	DBZ	97.60	-		
Clearance: 1-3/4"	US26	97.60	064743		
CTC: 10"	US26D	97.60	091336		
Offset: 2-1/2"	US28	63.30	075928		
Door Thickness: 1-3/4" standard	US32	94.95	091535		
Fasteners: 5/16" - 18 x 2-1/4" FPHMS with washers	US32D	77.30	066497		
Available with 45° offset					
11L	US3	97.60	096446	-	2
90° Offset Pull - Round	US4	97.60	-		
Material: Brass, bronze, aluminum, stainless steel	US10	109.40	023215		
Base: 3/4" diameter	US10B	136.75	070692		
Projection: 2-1/2"	DBZ	109.40	-		
Clearance: 1-3/4"	US26	109.40	062866		
CTC: 12"	US26D	109.40	086064		
Offset: 2-1/2"	US28	67.90	073571		
Door Thickness: 1-3/4" standard	US32	101.95	078494		
Fasteners: 5/16" - 18 x 2-1/4" FPHMS with washers	US32D	82.55	065800		
Available with 45° offset					
12G	US3	108.30	060314	-	2
90° Offset Pull - Round	US4	108.30	081233		
Material: Brass, bronze, aluminum, stainless steel	US10	124.30	043913		
Base: 1" diameter	US10B	197.50	076432		
Projection: 2-3/4"	DBZ	124.30	-		
Clearance: 1-3/4"	US26	124.30	078220		
CTC: 8"	US26D	124.30	062954		
Offset: 3"	US28	55.10	070404		
Door Thickness: 1-3/4" standard	US32	107.40	099416		
Fasteners: 5/16" - 18 x 2-1/4" FPHMS with washers	US32D	87.55	060905		
Available with 45° offset					

1. Items with the price in **bold and red** are Quick Ship items and ship in 24 hours.
Please use stock number when ordering. 2. U/M is each unless otherwise noted.



Trim & Auxiliary



Description	Finish	2018 List	Stock No.	Box Qty.	Case Qty.
12J	US3	113.10	060159	-	2
90° Offset Pull - Round	US4	113.10	082214		
Material: Brass, bronze, aluminum, stainless steel	US10	126.90	069370		
Base: 1" diameter	US10B	203.20	059163		
Projection: 2-3/4"	DBZ	126.90	-		
Clearance: 1-3/4"	US26	126.90	059778		
CTC: 10"	US26D	126.90	068450		
Offset: 3"	US28	61.00	070967		
Door Thickness: 1-3/4" standard	US32	119.30	059561		
Fasteners: 5/16" - 18 x 2-1/4" FPHMS with washers	US32D	94.35	055174		
Available with 45° offset					



12L	US3	120.75	056782	-	2
90° Offset Pull - Round	US4	120.75	063686		
Material: Brass, bronze, aluminum, stainless steel	US10	134.85	059327		
Base: 1" diameter	US10B	168.55	061587		
Projection: 2-3/4"	DBZ	134.85	-		
Clearance: 1-3/4"	US26	134.85	076229		
CTC: 12"	US26D	134.85	077083		
Offset: 3"	US28	66.70	062011		
Door Thickness: 1-3/4" standard	US32	131.30	067052		
Fasteners: 5/16" - 18 x 2-1/4" FPHMS with washers	US32D	98.15	059815		
Available with 45° offset					



13E	US3	128.10	061785	1	12
Push/Pull Set - Round	US4	128.10	095631		
Type 7 mounting	US10	130.55	002512		
Material: Brass, bronze, aluminum, stainless steel	US10B	163.20	028794		
Base: 3/4" diameter	DBZ	130.55	-		
Projection: 2-1/4"	US26	130.55	063688		
Clearance: 1-1/2"	US26D	130.55	060821		
Door Thickness: 1-3/4" - 2-1/8"	US28	89.00	076294		
CTC: 6"	US32	143.05	020838		
BTB Mounting type 7 concealed spanner (Required 3/8" min. holes in door)	US32D	117.20	055892		



13G	US3	147.10	002452	1	12
Push/Pull Set - Round	US4	147.10	018605		
Type 7 mounting	US10	152.55	056543		
Material: Brass, bronze, aluminum, stainless steel	US10B	190.70	057132		
Base: 3/4" diameter	DBZ	152.55	-		
Projection: 2-1/4"	US26	152.55	058650		
Clearance: 1-1/2"	US26D	152.55	096884		
Door Thickness: 1-3/4" - 2-1/8"	US28	97.30	057936		
CTC: 8"	US32	163.25	016398		
BTB Mounting type 7 concealed spanner (Required 3/8" min. holes in door)	US32D	127.00	059203		



13J	US3	162.40	067010	1	12
Push/Pull Set - Round	US4	162.40	058379		
Type 7 mounting	US10	169.75	013815		
Material: Brass, bronze, aluminum, stainless steel	US10B	212.20	006667		
Base: 3/4" diameter	DBZ	169.75	-		
Projection: 2-1/4"	US26	169.75	043759		
Clearance: 1-1/2"	US26D	169.75	068292		
Door Thickness: 1-3/4" - 2-1/8"	US28	109.05	014475		
CTC: 10"	US32	180.25	032231		
BTB Mounting type 7 concealed spanner (Required 3/8" min. holes in door)	US32D	139.00	063863		



10/06/2020

www.hagerco.com

1. Items with the price in **bold and red** are Quick Ship items and ship in 24 hours.
Please use stock number when ordering. 2. U/M is each unless otherwise noted.



Description	Finish	2018 List	Stock No.	Box Qty.	Case Qty.
13L	US3	174.90	095055	1	12
Push/Pull Set - Round	US4	174.90	110600		
Type 7 mounting	US10	198.55	060284		
Material: Brass, bronze, aluminum, stainless steel	US10B	248.20	039979		
Base: 3/4" diameter	DBZ	198.55	-		
Projection: 2-1/4"	US26	198.55	070322		
Clearance: 1-1/2"	US26D	198.55	070163		
Door Thickness: 1-3/4" - 2-1/8"	US28	121.65	037236		
CTC: 12"	US32	193.10	034594		
BTB Mounting type 7 concealed spanner (Required 3/8" min. holes in door)	US32D	159.95	084896		



14G	US3	183.85	056325	1	12
Push/Pull Set - Round	US4	183.85	123899		
Type 7 mounting	US10	197.70	027836		
Material: Brass, bronze, aluminum, stainless steel	US10B	247.15	019363		
Base: 1" diameter	DBZ	197.70	-		
Projection: 2-3/4"	US26	197.70	029353		
Clearance: 1-3/4"	US26D	197.70	077790		
Door Thickness: 1-3/4" - 2-1/8"	US28	126.20	091532		
CTC: 8"	US32	213.70	088849		
BTB Mounting type 7 concealed spanner (Required 3/8" min. holes in door)	US32D	172.00	070068		



14H	US3	202.45	125548	1	12
Push/Pull Set - Round	US4	212.75	143956		
Type 7 mounting	US10	214.75	-		
Material: Brass, bronze, aluminum, stainless steel	US10B	268.45	018727		
Base: 1" diameter	DBZ	214.75	-		
Projection: 2-3/4"	US26	214.75	-		
Clearance: 1-3/4"	US26D	214.75	034117		
Door Thickness: 1-3/4" - 2-1/8"	US28	126.45	147101		
CTC: 9"	US32	237.80	-		
BTB Mounting type 7 concealed spanner (Required 3/8" min. holes in door)	US32D	184.50	024734		



14J	US3	204.10	056432	1	8
Push/Pull Set - Round	US4	204.10	028831		
Type 7 mounting	US10	216.40	066033		
Material: Brass, bronze, aluminum, stainless steel	US10B	270.50	060441		
Base: 1" diameter	DBZ	216.40	-		
Projection: 2-3/4"	US26	216.40	059309		
Clearance: 1-3/4"	US26D	216.40	061594		
Door Thickness: 1-3/4" - 2-1/8"	US28	127.90	014601		
CTC: 10"	US32	239.40	084135		
BTB Mounting type 7 concealed spanner (Required 3/8" min. holes in door)	US32D	186.00	067342		



14L	US3	212.00	086803	1	8
Push/Pull Set - Round	US4	212.00	-		
Type 7 mounting	US10	241.90	071917		
Material: Brass, bronze, aluminum, stainless steel	US10B	302.40	071108		
Base: 1" diameter	DBZ	241.90	-		
Projection: 2-3/4"	US26	241.90	010126		
Clearance: 1-3/4"	US26D	241.90	023138		
Door Thickness: 1-3/4" - 2-1/8"	US28	141.75	100725		
CTC: 12"	US32	259.60	063460		
BTB Mounting type 7 concealed spanner (Required 3/8" min. holes in door)	US32D	210.55	057010		

1. Items with the price in **bold and red** are Quick Ship items and ship in 24 hours.
Please use stock number when ordering. 2. U/M is each unless otherwise noted.



Trim & Auxiliary



Description	Finish	2018 List	Stock No.	Box Qty.	Case Qty.
15C Heavy Duty Flush Cup Pull Material: Stainless steel Face: 3-1/2" x 5" Opening: 1-3/4" x 3-1/16" Projection: 1/8" Cup Depth: 3/4" (Cup welded to face plate) Fasteners: #6 x 5/8" OPHWS	US32D	64.65	026410	1	10
15N Flush Cup Pull Material: Brass, bronze, aluminum, stainless steel Face: 3-1/2" x 5" Opening: 1-3/4" x 3-1/16" Projection: 1/8" Cup Depth: 3/4" Fasteners: #6 x 5/8" OPHWS	US3 US4 US10 US10B DBZ US26 US26D US28 US32D	58.00 67.60 66.70 83.40 66.70 66.70 62.50 25.15 32.50	053114 053115 053116 053117 - 053118 053119 053120 053121	2	20
15P Heavy Duty Security Flush Cup Pull Material: Stainless steel Face: 3-1/2" x 5" Opening: 1-3/4" x 3-1/16" Projection: 3/16" Cup Depth: 3/4" (Cup welded to face plate) Welded studs for security (2) 6 -32 x 1-1/2" FPHMS (security torx)	US32D	68.45	085266	2	20
15S Light Duty Flush Cup Pull Material: Brass, bronze, aluminum, stainless steel Face: 3-1/2" x 5" Opening: 1-3/4" x 3-1/16" Projection: 1/8" Cup Depth: 3/4" Fasteners: #6 x 5/8" PPHWS Fasteners inside recessed cup	US3 US4 US10 US10B DBZ US26 US26D US28 US32D	52.05 58.95 66.70 83.40 66.70 66.70 66.70 42.30 43.90	014360 039342 025946 042147 - 089124 020841 091301 017661	2	20
16N Light Duty Flush Cup Pull Material: Brass, bronze Face: 1-15/16" x 3" Opening: 27/32" x 2-3/8" Projection: 1/16" Cup Depth: 5/8" Fasteners: #8 x 3/4" OPHWS Fasteners inside recessed cup	US3 US4 US10 US10B DBZ US26 US26D	24.40 31.50 25.30 31.65 25.30 31.50 25.30	073983 010007 074227 068253 - 068254 067702	2	20



10/06/2020

www.hagerco.com



Description	Finish	2018 List	Stock No.	Box Qty.	Case Qty.
16R	US3	74.70	018081	2	20
Finger Pull Plate	US4	81.85	141082		
Material: Brass, bronze, aluminum, stainless steel	US10	81.85	-		
Size: 4" x 16"	US10B	102.30	060151		
Opening: 1-3/4" x 3-1/16"	DBZ	81.85	-		
Cup Depth: 13/16"	US26	81.85	085308		
Fasteners: #6 x 5/8" OPHWS	US26D	81.85	009524		
	US28	57.30	092065		
	US32	92.25	-		
	US32D	63.75	057855		



17N	US3	21.45	068535	2	20
Light Duty Flush Cup Pull	US4	27.65	077871		
Material: Brass, bronze	US10	22.80	068096		
Face: 2-1/2" x 3-31/32"	US10B	28.50	068255		
Opening: 1-11/32" x 3-13/32"	DBZ	22.80	-		
Projection: 3/32"	US26	27.65	068256		
Cup Depth: 5/8"	US26D	22.00	067507		
Fasteners: #8 x 13/16" OPHWS					
Fasteners inside recessed cup					



19N	US3	67.80	068194	1	20
Cast Pull	US10	70.55	072477		
Material: Brass, bronze	US10B	90.95	076217		
Base Diameter: 1-1/2"	DBZ	72.75	-		
Projection: 3-1/8"	US26	72.75	063714		
Clearance: 1-11/16"	US26D	72.75	064247		
CTC: 6-3/16"					
Length O/A: 9"					
Fasteners: #8 x 1" OPHWS					
Suitable for BTB Mounting with sex nuts by special quotation					



20N	US3	67.80	058572	1	1
Cast Pull	US10	72.75	058573		
Material: Brass, bronze	US10B	90.95	095243		
Base Diameter: 1-1/2"	DBZ	72.75	-		
Projection: 3-1/8"	US26	72.75	017678		
Clearance: 1-11/16"	US26D	72.75	058574		
CTC: 5-7/32"					
Length O/A: 9"					
Fasteners: 1/4" - 20 thru bolts with washers					
Door Thickness: 1-3/4" standard					
Not suitable for BTB Mounting					



20L	US3	577.25	140460	1	4
Push/Pull Set - Round	US4	610.10	090986		
Type 7 mounting	US10	610.10	146334		
Material: Brass, bronze, stainless steel	US10B	762.65	019165		
Base: 1-1/4" diameter	DBZ	610.10	-		
Projection: 3"	US26	610.10	052420		
Clearance: 1-3/4"	US26D	610.10	022949		
CTC: 12"	US28	610.10	-		
Door Thickness: 1-3/4" - 2-1/8" standard	US32	539.60	030891		
BTB Mounting type 7 concealed spanner (Required 7/16" min. holes in door)	US32D	503.75	099136		

1. Items with the price in **bold and red** are Quick Ship items and ship in 24 hours. Please use stock number when ordering. 2. U/M is each unless otherwise noted.



Trim & Auxiliary



Description	Finish	2018 List	Stock No.	Box Qty.	Case Qty.
20Q	US3	641.45	-	1	4
Push/Pull Set - Round	US4	677.95	-		
Type 7 mounting	US10	677.95	-		
Material: Brass, bronze, stainless steel	US10B	847.45	105155		
Base: 1-1/4" diameter	DBZ	677.95	-		
Projection: 3"	US26	677.95	-		
Clearance: 1-3/4"	US26D	677.95	046330		
CTC: 18"	US28	677.95	-		
Door Thickness: 1-3/4" - 2-1/8" standard	US32	417.50	066386		
BTB Mounting type 7 concealed spanner (Required 7/16" min. holes in door)	US32D	559.75	067607		



21E	US3	202.05	138354	-	1
90° Offset Push/Pull Set - Round	US4	202.05	-		
Material: Brass, bronze, aluminum, stainless steel	US10	211.65	-		
Base: 3/4" diameter	US10B	264.55	012325		
Projection: 2-1/2"	DBZ	211.65	-		
Clearance: 1-3/4"	US26	211.65	071225		
CTC: 6"	US26D	211.65	028763		
Offset: 2-1/2"	US28	147.45	019295		
Door Thickness: 1-3/4" - 2-1/8" standard	US32	214.05	161045		
BTB Mounting Type 7 concealed spanner (Required 3/8" minimum holes in door)	US32D	176.30	089757		
Available with 45° offset					



21G	US3	213.00	058679	-	1
90° Offset Push/Pull Set - Round	US4	213.00	043225		
Material: Brass, bronze, aluminum, stainless steel	US10	222.90	-		
Base: 3/4" diameter	US10B	278.65	063310		
Projection: 2-1/2"	DBZ	222.90	-		
Clearance: 1-3/4"	US26	222.90	018016		
CTC: 8"	US26D	222.90	066826		
Offset: 2-1/2"	US28	161.50	-		
Door Thickness: 1-3/4" - 2-1/8" standard	US32	224.65	025013		
BTB Mounting Type 7 concealed spanner (Required 3/8" minimum holes in door)	US32D	189.45	058003		
Available with 45° offset					



21J	US3	220.20	078909	-	1
90° Offset Push/Pull Set - Round	US4	220.20	-		
Material: Brass, bronze, aluminum, stainless steel	US10	237.95	005255		
Base: 3/4" diameter	US10B	297.45	057372		
Projection: 2-1/2"	DBZ	237.95	-		
Clearance: 1-3/4"	US26	237.95	005678		
CTC: 10"	US26D	237.95	067008		
Offset: 2-1/2"	US28	165.65	112219		
Door Thickness: 1-3/4" - 2-1/8" standard	US32	231.50	019770		
BTB Mounting Type 7 concealed spanner (Required 3/8" minimum holes in door)	US32D	196.50	080009		
Available with 45° offset					





Description	Finish	2018 List	Stock No.	Box Qty.	Case Qty.
21L					
90° Offset Push/Pull Set - Round	US3	234.65	097140	-	1
Material: Brass, bronze, aluminum, stainless steel	US4	234.65	002578		
Base: 3/4" diameter	US10	261.70	-		
Projection: 2-1/2"	US10B	327.15	042312		
Clearance: 1-3/4"	DBZ	261.70	-		
CTC: 12"	US26	261.70	007396		
Offset: 2-1/2"	US26D	261.70	032790		
Door Thickness: 1-3/4" - 2-1/8" standard	US28	177.35	047803		
BTB Mounting Type 7 concealed spanner (Required 3/8" minimum holes in door)	US32	245.60	027578		
Available with 45° offset	US32D	207.05	069905		



22G	US3	255.15	079012	-	1
90° Offset Push/Pull Set - Round	US4	255.15	-		
Material: Brass, bronze, aluminum, stainless steel	US10	286.00	075421		
Base: 1" diameter	US10B	357.50	096184		
Projection: 2-3/4"	DBZ	286.00	-		
Clearance: 1-3/4"	US26	286.00	048693		
CTC: 8"	US26D	286.00	007328		
Offset: 3"	US28	155.45	024277		
Door Thickness: 1-3/4" - 2-1/8" standard	US32	256.85	098201		
BTB Mounting Type 7 concealed spanner (Required 3/8" minimum holes in door)	US32D	253.30	067908		
Available with 45° offset					



22J	US3	269.10	075192	-	1
90° Offset Push/Pull Set - Round	US4	269.10	-		
Material: Brass, bronze, aluminum, stainless steel	US10	301.40	050773		
Base: 1" diameter	US10B	376.75	058192		
Projection: 2-3/4"	DBZ	301.40	-		
Clearance: 1-3/4"	US26	301.40	005787		
CTC: 10"	US26D	301.40	085517		
Offset: 3"	US28	167.10	002376		
Door Thickness: 1-3/4" - 2-1/8" standard	US32	280.35	073277		
BTB Mounting Type 7 concealed spanner (Required 3/8" minimum holes in door)	US32D	272.90	076699		
Available with 45° offset					



22L	US3	283.00	073970	-	1
90° Offset Push/Pull Set - Round	US4	283.00	078417		
Material: Brass, bronze, aluminum, stainless steel	US10	320.05	000477		
Base: 1" diameter	US10B	400.05	080383		
Projection: 2-3/4"	DBZ	320.05	-		
Clearance: 1-3/4"	US26	320.05	015975		
CTC: 12"	US26D	320.05	038687		
Offset: 3"	US28	178.55	000794		
Door Thickness: 1-3/4" - 2-1/8" standard	US32	303.50	059202		
BTB Mounting Type 7 concealed spanner (Required 3/8" minimum holes in door)	US32D	292.90	064503		
Available with 45° offset					



22N	US3	71.95	086819	1	10
Concealed Edge Pull	US26D	78.20	086820		
Material: Solid brass					
Size: 3 1/32" x 4-1/4" x 3/8"					
Finger piece extends: 2-3/4"					
Fasteners: #6 x 3/4" FPHWS					

1. Items with the price in **bold and red** are Quick Ship items and ship in 24 hours.
Please use stock number when ordering. 2. U/M is each unless otherwise noted.



Trim & Auxiliary



Description	Finish	2018 List	Stock No.	Box Qty.	Case Qty.
23Q	US3	361.00	006390	-	2
90° Offset Pull - Round	US4	361.00	029999		
Material: Brass, bronze, aluminum, stainless steel	US10	380.50	021472		
Base Diameter: 1-1/4"	US10B	475.65	017369		
Projection: 3"	DBZ	380.50	-		
Clearance: 1-3/4"	US26	380.50	019785		
CTC: 18"	US26D	380.50	023673		
Offset: 3-3/4" standard	US28	135.45	049363		
Fasteners: 5/16" - 18 thru bolt w/ washer	US32	332.05	002751		
Door Thickness: 1-3/4" - 2-1/8" standard	US32D	284.60	080011		
Available with 45° offset					



24Q	US3	768.35	003843	-	1
90° Offset Push/Pull Set - Round	US4	768.35	134285		
Material: Brass, bronze, aluminum, stainless steel	US10	807.20	043201		
Base Diameter: 1-1/4"	US10B	1009.00	024989		
Projection: 3"	DBZ	807.20	-		
Clearance: 1-3/4"	US26	807.20	-		
CTC: 18"	US26D	807.20	-		
Offset: 3-3/4"	US28	289.40	095347		
Door Thickness: 1-3/4" - 2-1/8" standard	US32	710.95	-		
BTB Mounting Type 7 concealed spanner (Required 3/8" minimum holes in door)	US32D	614.35	067055		
Available with 45° offset					



190F	Powder Coated Aluminum	70.45	39832	-	100
Foot Pull					
Material: T6 aluminum					
Projection: 3"					
Door Thickness: 1-3/4" standard					
Fasteners: (3) #12 screws suitable for wood/metal doors + (1) sex nut & bolt					



25B	US32D	131.70	025035	1	10
Security Flush Pull Set					
Material: Stainless steel					
Face: 3-1/2" x 5"					
Opening: 1-3/4" x 3-1/16"					
Projection: 3/16"					
Cup Depth: 3/4"					
Fasteners: (2) 6 - 32 x 1-1/2" FPHMS (security torx)					



25C	US32D	127.75	008405	1	10
Heavy Duty Flush Pull Set					
Material: Stainless steel					
Face: 3-1/2" x 5"					
Opening: 1-3/4" x 3-1/16"					
Projection: 1/8"					
Cup Depth: 3/4"					
Fasteners: (4) 6 -32 OPHMS with sex nuts and bolts					
Consists of 2 ea. 15C pulls BTB					



25N	US3	127.80	057171	1	10
Flush Pull Set	US4	127.80	069686		
Material: Brass, bronze, aluminum, stainless steel	US10	131.50	064913		
Face: 3-1/2" x 5"	US10B	164.40	075384		
Opening: 1-3/4" x 3-1/16"	DBZ	131.50	-		
Projection: 1/8"	US26	131.50	087487		
Cup Depth: 3/4"	US26D	131.50	055307		
Fasteners: (4) 6 -32 OPHMS with sex nuts and bolts	US28	97.95	074843		
Consists of 2 ea. 15N pulls BTB	US32D	55.00	066502		





Description	Finish	2018 List	Stock No.	Box Qty.	Case Qty.
25P Security Finger Pull/Push Plate Set Material: Stainless steel Base: 4" x 16" Opening: 1-3/4" x 3-1/16" Projection: 1/8" Fasteners: 8 - 32 x 3/4" FPHMS (security torx) sex nuts and bolts	US32D	267.85	089518	1	10
26N Security Finger Pull Material: Brass, stainless steel Face: 4" x 5" Opening: 1-5/8" x 3" Projection: 1/8" Cup Depth: 13/16" Fasteners: 1/4" - 20 x 3/4" security torx FPHMS	US4 US26D US32D	71.30 97.60 102.55	024671 036321 017790	2	20
27N Security Flush Cup Pull Material: Stainless steel Face: 5" x 5" Opening: 3" x 3-1/2" Projection: 3/8" Cup Depth: 7/8" Fasteners: 10 - 24 FPHMS (security torx) sex nuts and thru bolts Not available for BTB Mounting	US32D	133.35	006749	2	20
27P Security Flush Cup Pull Material: Stainless steel Face: 5" x 5" Opening: 3" x 3-1/2" Projection: 3/8" Cup Depth: 7/8" Fasteners: 1/4 - 20 x 3/4" FPHMS (security torx) Not available for BTB Mounting	US32D	133.35	013714	2	20

1. Items with the price in **bold and red** are Quick Ship items and ship in 24 hours. Please use stock number when ordering. 2. U/M is each unless otherwise noted.

Trim & Auxiliary



Description	Finish	2018 List	Stock No.	Box Qty.	Case Qty.
305					
Push Plate - Square Corner					
Material: Brass, bronze, aluminum, stainless steel					
Gauge: 0.050					
Fasteners: #6 x 5/8" OPH tapping screws					
3" x 12"	US3	17.10	052473	5	50
	US4	17.10	053057		
	US10	20.40	052603		
	US10B	25.50	052604		
	DBZ	20.40	-		
	US26	20.40	052788		
	US26D	20.40	052605		
	US28	10.75	052606		
	US32	15.40	060400		
	US32D	12.50	052607		
3-1/2" x 15"	US3	23.05	051947	5	50
	US4	24.50	053058		
	US10	28.00	052474		
	US10B	35.00	052475		
	DBZ	28.00	-		
	US26	28.00	051948		
	US26D	27.00	052608		
	US28	10.20	051949		
	US32	14.00	067703		
	US32D	10.50	052476		
4" x 16"	US3	27.00	052477	5	50
	US4	26.50	053059		
	US10	29.50	052478		
	US10B	36.90	052479		
	DBZ	29.50	-		
	US26	29.50	052789		
	US26D	28.50	052480		
	US28	11.40	052481		
	US32	15.50	056570		
	US32D	11.05	052482		
6" x 16"	US3	38.50	052609	-	5
	US4	38.50	016001		
	US10	43.50	052610		
	US10B	54.40	052611		
	DBZ	43.50	-		
	US26	43.50	052612		
	US26D	42.50	052613		
	US28	15.75	052614		
	US32	23.40	059757		
	US32D	15.75	052615		
8" x 16"	US3	47.35	052616	-	5
	US4	47.35	053054		
	US10	54.30	052617		
	US10B	67.90	052618		
	DBZ	54.30	-		
	US26	54.30	052619		
	US26D	53.30	052620		
	US28	17.55	052621		
	US32	29.25	056697		
	US32D	21.40	052483		





Description	Finish	2018 List	Stock No.	Box Qty.	Case Qty.
A30S					
Push Plate - Square Corner					
Material: Brass, bronze, aluminum, stainless steel					
Gauge: 0.062					
Fasteners: #6 x 5/8" OPH tapping screws					
3" x 12"					
Diamond plate available at price of US10.					
	US3	28.10	088064	5	50
	US4	28.10	040610		
	US10	32.60	089728		
	US10B	40.75	057228		
	DBZ	32.60	-		
	US26	32.60	083774		
	US26D	32.60	002164		
	US28	13.75	-		
	US32	26.10	-		
	US32D	16.75	018593		
3-1/2" x 15"	US3	30.30	086010	5	50
	US4	30.30	125264		
	US10	36.65	060451		
	US10B	45.80	095370		
	DBZ	36.65	-		
	US26	36.65	041812		
	US26D	36.65	050973		
	US28	15.30	095372		
	US32	31.80	014761		
	US32D	21.25	095371		
4" x 16"	US3	34.25	088141	5	50
	US4	34.25	096314		
	US10	40.35	018240		
	US10B	50.45	026224		
	DBZ	40.35	-		
	US26	40.35	068218		
	US26D	40.35	088369		
	US28	16.50	098928		
	US32	33.45	071242		
	US32D	23.25	084940		
6" x 16"	US3	49.65	146109	-	5
	US4	49.65	147465		
	US10	55.80	008731		
	US10B	69.75	094683		
	DBZ	55.80	-		
	US26	55.80	098852		
	US26D	55.80	001249		
	US28	21.65	098000		
	US32	56.80	-		
	US32D	38.70	052271		
8" x 16"	US3	53.70	046204	-	5
	US4	53.70	065722		
	US10	59.75	089364		
	US10B	74.70	025549		
	DBZ	59.75	-		
	US26	59.75	053802		
	US26D	59.75	092477		
	US28	28.80	-		
	US32	70.00	104412		
	US32D	43.30	081011		

1. Items with the price in **bold and red** are Quick Ship items and ship in 24 hours.
 Please use stock number when ordering. 2. U/M is each unless otherwise noted.



Trim & Auxiliary



Description	Finish	2018 List	Stock No.	Box Qty.	Case Qty.
31E					
Pull Plate - Square Corner - Half Round Pull					
Material: Brass, bronze, aluminum, stainless steel					
Gauge: 0.050; CTC: 6"					
30S x 1E Pull					
Fasteners: #6 x 5/8" OPH tapping screws					
3-1/2" x 15"					
	US3	79.50	056433	1	10
	US4	79.50	060011		
	US10	84.50	055633		
	US10B	105.65	058712		
	DBZ	84.50	-		
	US26	84.50	078715		
	US26D	79.50	054517		
	US28	38.50	054428		
	US32	79.80	071221		
	US32D	57.00	054029		
4" x 16"	US3	80.50	052652	1	10
	US4	80.50	053049		
	US10	85.50	052653		
	US10B	106.90	052493		
	DBZ	85.50	-		
	US26	85.50	052800		
	US26D	80.75	054341		
	US28	39.50	052654		
	US32	90.00	062509		
	US32D	68.20	052494		



31G					
Pull Plate - Square Corner - Half Round Pull					
Material: Brass, bronze, aluminum, stainless steel					
Gauge: 0.050; CTC: 8"					
30S x 1G Pull					
Fasteners: #6 x 5/8" OPH tapping screws					
3-1/2" x 15"					
	US3	80.95	058350	1	10
	US4	80.95	085438		
	US10	88.90	057757		
	US10B	111.15	058681		
	DBZ	88.90	-		
	US26	88.90	064372		
	US26D	88.90	058351		
	US28	42.50	055483		
	US32	99.90	041049		
	US32D	65.00	055482		
4" x 16"	US3	86.00	056514	1	10
	US4	86.00	064373		
	US10	90.45	058057		
	US10B	113.05	059416		
	DBZ	90.45	-		
	US26	90.45	059035		
	US26D	90.45	056759		
	US28	45.00	056350		
	US32	105.80	095219		
	US32D	66.00	055297		





Description	Finish	2018 List	Stock No.	Box Qty.	Case Qty.
31J					
Pull Plate - Square Corner - Half Round Pull					
Material: Brass, bronze, aluminum, stainless steel					
Gauge: 0.050; CTC: 10"					
30S x 1J Pull					
Fasteners: #6 x 5/8" OPH tapping screws					
3-1/2" x 15"					
	US3	92.10	011268	1	10
	US4	95.90	065208		
	US10	99.35	700006		
	US10B	124.20	067881		
	DBZ	99.35	-		
	US26	99.35	-		
	US26D	99.35	081194		
	US28	49.30	116104		
	US32	111.15	077157		
	US32D	86.15	056322		
4" x 16"	US3	93.85	125465	1	10
	US4	97.10	049246		
	US10	103.00	063316		
	US10B	128.75	062373		
	DBZ	103.00	-		
	US26	103.00	-		
	US26D	103.00	021574		
	US28	51.55	050497		
	US32	104.75	068294		
	US32D	89.55	062377		
32E					
Pull Plate - Square Corner - Rectangular Pull					
Material: Brass, bronze, aluminum, stainless steel					
Gauge: 0.050; CTC: 6"					
Fasteners: #6 x 5/8" OPH tapping screws					
30S x 2E Pull					
3-1/2" x 15"					
	US3	63.70	052642	1	10
	US4	60.95	053047		
	US10	79.50	052643		
	US10B	99.40	052644		
	DBZ	79.50	-		
	US26	79.50	052797		
	US26D	79.50	052645		
	US28	33.50	052646		
	US32	66.95	067882		
	US32D	47.00	052647		
4" x 16"	US3	71.00	052648	1	10
	US4	71.00	053048		
	US10	81.50	052798		
	US10B	101.90	052492		
	DBZ	81.50	-		
	US26	81.50	052799		
	US26D	81.50	052649		
	US28	35.50	052650		
	US32	77.35	060399		
	US32D	49.00	052651		



1. Items with the price in **bold and red** are Quick Ship items and ship in 24 hours.
 Please use stock number when ordering. 2. U/M is each unless otherwise noted.



Trim & Auxiliary



Description	Finish	2018 List	Stock No.	Box Qty.	Case Qty.
32G					
Pull Plate - Square Corner - Rectangular Pull					
Material: Brass, bronze, aluminum, stainless steel					
Gauge: 0.050; CTC: 8"					
Fasteners: #6 x 5/8" OPH tapping screws					
30S x 2G Pull					
3-1/2" x 15"					
	US3	73.70	059981	1	10
	US4	73.70	085113		
	US10	86.05	-		
	US10B	106.90	066040		
	DBZ	85.50	-		
	US26	86.05	-		
	US26D	84.50	060646		
	US28	44.50	063926		
	US32	86.15	-		
	US32D	60.00	055010		
4" x 16"	US3	84.50	054727	1	10
	US4	84.50	003510		
	US10	89.50	056784		
	US10B	111.90	056756		
	DBZ	89.50	-		
	US26	89.00	065122		
	US26D	89.50	069514		
	US28	48.50	069513		
	US32	93.25	017637		
	US32D	64.00	055389		
32J					
Pull Plate - Square Corner - Rectangular Pull					
Material: Brass, bronze, aluminum, stainless steel					
Gauge: 0.050; CTC: 10"					
Fasteners: #6 x 5/8" OPH tapping screws					
30S x 2J Pull					
3-1/2" x 15"					
	US3	86.05	043039	1	10
	US4	88.55	-		
	US10	94.70	118724		
	US10B	118.40	022532		
	DBZ	94.70	-		
	US26	94.70	-		
	US26D	94.70	-		
	US28	40.65	-		
	US32	102.35	-		
	US32D	86.15	019279		
4" x 16"	US3	89.40	032063	1	10
	US4	94.25	139843		
	US10	97.60	117572		
	US10B	122.00	005155		
	DBZ	97.60	-		
	US26	97.60	029867		
	US26D	97.60	044540		
	US28	44.10	-		
	US32	106.65	040153		
	US32D	91.40	069243		





Description	Finish	2018 List	Stock No.	Box Qty.	Case Qty.
33E					
Pull Plate - Square Corner					
3/4" Round Pull					
Material: Brass, bronze, aluminum, stainless steel					
Gauge: 0.050; CTC: 6"					
Fasteners: #6 x 5/8" OPH tapping screws					
30S x 3E Pull					
3-1/2" x 15"					
	US3	67.00	052655	1	10
	US4	67.00	053044		
	US10	75.50	052656		
	US10B	94.40	052657		
	DBZ	75.50	041990		
	US26	75.50	052801		
	US26D	75.50	052658		
	US28	32.50	052659		
	US32	55.00	074228		
	US32D	37.40	052660		
4" x 16"	US3	73.00	052661	1	10
	US4	73.00	016002		
	US10	79.25	053045		
	US10B	99.05	052662		
	DBZ	79.25	041986		
	US26	79.25	052802		
	US26D	79.25	052663		
	US28	36.50	052664		
	US32	62.00	056516		
	US32D	38.50	052665		



33G					
Pull Plate - Square Corner - 3/4" Round Pull					
Material: Brass, bronze, aluminum, stainless steel					
Gauge: 0.050; CTC: 8"					
Fasteners: #6 x 5/8" OPH tapping screws					
30S x 3G Pull					
3-1/2" x 15"					
	US3	75.00	052667	1	10
	US4	75.00	053046		
	US10	82.50	052495		
	US10B	103.15	052668		
	DBZ	82.50	-		
	US26	82.50	052803		
	US26D	76.00	052669		
	US28	35.50	052670		
	US32	60.00	002398		
	US32D	37.60	052666		
4" x 16"	US3	80.10	052671	1	10
	US4	80.10	053060		
	US10	87.50	052672		
	US10B	109.40	052673		
	DBZ	87.50	041981		
	US26	87.50	052804		
	US26D	82.10	005274		
	US28	37.50	052675		
	US32	64.30	063728		
	US32D	39.60	052676		

1. Items with the price in **bold and red** are Quick Ship items and ship in 24 hours.
Please use stock number when ordering. 2. U/M is each unless otherwise noted.



Trim & Auxiliary



Description	Finish	2018 List	Stock No.	Box Qty.	Case Qty.
33J					
Pull Plate - Square Corner - 3/4" Round Pull					
Material: Brass, bronze, aluminum, stainless steel					
Gauge: 0.050; CTC: 10"					
Fasteners: #6 x 5/8" OPH tapping screws					
30S x 3J Pull					
3-1/2" x 15"	US3	76.95	076230	1	10
	US4	79.20	048521		
	US10	82.50	071881		
	US10B	103.15	006002		
	DBZ	82.50	-		
	US26	82.50	113458		
	US26D	82.50	112480		
	US28	45.35	054673		
	US32	91.25	067662		
	US32D	74.75	065235		
4" x 16"	US3	82.80	087358	1	10
	US4	86.55	080814		
	US10	90.30	059652		
	US10B	112.90	077870		
	DBZ	90.30	-		
	US26	90.30	135368		
	US26D	90.30	092249		
	US28	47.90	060024		
	US32	94.95	068874		
	US32D	77.25	057608		



34G					
Pull Plate - Square Corner - 1" Round Pull					
Material: Brass, bronze, aluminum, stainless steel					
Gauge: 0.050; CTC: 8"					
Fasteners: #6 x 5/8" OPH tapping screws					
30S x 4G Pull					
3-1/2" x 15"	US3	90.45	052888	1	10
	US4	97.60	022822		
	US10	101.75	052890		
	US10B	127.20	052891		
	DBZ	101.75	-		
	US26	101.75	068374		
	US26D	101.75	052893		
	US28	50.55	143095		
	US32	103.60	-		
	US32D	88.00	051944		
4" x 16"	US3	93.25	052894	1	10
	US4	99.35	052895		
	US10	104.70	052896		
	US10B	130.90	052897		
	DBZ	104.70	-		
	US26	104.70	052898		
	US26D	104.70	052899		
	US28	51.55	052900		
	US32	105.65	062950		
	US32D	91.25	052901		





Description	Finish	2018 List	Stock No.	Box Qty.	Case Qty.
34J					
Pull Plate - Square Corner - 1" Round Pull					
Material: Brass, bronze, aluminum, stainless steel					
Gauge: 0.050; CTC: 10"					
Fasteners: #6 x 5/8" OPH tapping screws					
30S x 4J Pull	US3	113.75	088937	1	10
3-1/2" x 15"	US4	113.75	023595		
	US10	123.45	065332		
	US10B	157.00	057755		
	DBZ	125.60	-		
	US26	119.00	040243		
	US26D	119.00	068488		
	US28	40.25	095443		
	US32	88.00	069479		
	US32D	68.50	059558		
4" x 16"	US3	114.50	058218	1	10
	US4	114.50	076042		
	US10	124.50	054937		
	US10B	161.25	056339		
	DBZ	129.00	-		
	US26	122.50	067490		
	US26D	122.50	063209		
	US28	41.00	065718		
	US32	91.10	074891		
	US32D	69.60	056278		



35D					
Pull Plate - Square Corner - 5/8" Round Pull					
Material: Brass, bronze, aluminum, stainless steel					
Gauge: 0.050; CTC: 5-1/2"					
Fasteners: #6 x 5/8" OPH tapping screws					
30S x 5D Pull					
3-1/2" x 15"	US3	58.50	048502	1	10
	US4	58.50	029931		
	US10	62.15	048500		
	US10B	77.70	048503		
	DBZ	62.15	-		
	US26	62.15	057278		
	US26D	62.15	024259		
	US28	29.10	048501		
	US32	59.90	163371		
	US32D	30.90	048505		
4" x 16"	US3	62.15	048508	1	10
	US4	62.15	028846		
	US10	64.15	048506		
	US10B	80.20	048509		
	DBZ	64.15	-		
	US26	64.15	012741		
	US26D	64.15	048510		
	US28	30.25	048507		
	US32	52.45	071154		
	US32D	33.75	048511		

1. Items with the price in **bold and red** are Quick Ship items and ship in 24 hours.
Please use stock number when ordering. 2. U/M is each unless otherwise noted.



Trim & Auxiliary



Description	Finish	2018 List	Stock No.	Box Qty.	Case Qty.
35N					
Pull Plate - Square Corner - Cast Pull					
Material: Brass, bronze, aluminum, stainless steel					
Gauge: 0.050; CTC: 5-1/2"					
Fasteners: #6 x 5/8" OPH tapping screws					
30S x 5N Pull	US3	61.65	052487	1	10
3-1/2" x 15"	US4	62.65	053051		
	US10	66.25	052637		
	US10B	82.80	052488		
	DBZ	66.25	-		
	US26	66.25	052794		
	US26D	66.25	053052		
	US28	39.25	052489		
	US32	90.35	057091		
	US32D	56.70	052490		
4" x 16"	US3	63.00	052639	1	10
	US4	64.65	007485		
	US10	69.75	052795		
	US10B	87.20	052640		
	DBZ	69.75	-		
	US26	69.75	028998		
	US26D	69.75	052641		
	US28	40.10	016004		
	US32	98.90	030733		
	US32D	58.70	052491		



36N					
Pull Plate - Square Corner					
Material: Brass, bronze, aluminum, stainless steel					
Gauge: 0.050; CTC: 5-1/2"					
Fasteners: #6 x 5/8" OPH tapping screws					
30S x 6N Pull	US3	57.85	052484	1	10
3-1/2" x 15"	US4	57.85	053056		
	US10	60.25	052628		
	US10B	75.30	052629		
	DBZ	60.25	041973		
	US26	60.25	052792		
	US26D	60.25	052630		
	US28	31.75	052485		
	US32	79.80	098946		
	US32D	46.00	052631		
4" x 16"	US3	59.85	052632	1	10
	US4	59.85	053050		
	US10	62.25	052633		
	US10B	77.80	052634		
	DBZ	62.25	041960		
	US26	62.25	052793		
	US26D	62.25	052635		
	US28	33.75	052636		
	US32	87.45	064685		
	US32D	46.75	052486		





Description	Finish	2018 List	Stock No.	Box Qty.	Case Qty.
39E					
Pull Plate - Square Corner - 3/4" Oval Pull					
Material: Brass, bronze, aluminum, stainless steel					
Gauge: 0.050; CTC: 6"					
Fasteners: #6 x 5/8" OPH tapping screws					
30S x 9E Pull	US3	57.50	066457		
3-1/2" x 15"	US4	57.50	068631	1	10
	US10	59.50	066451		
	US10B	74.40	066452		
	DBZ	59.50	-		
	US26	78.90	066453		
	US26D	65.90	064908		
	US32	70.00	092653		
	US32D	54.00	066454		
4" x 16"	US3	59.50	066242	1	10
	US4	59.50	094002		
	US10	63.50	066459		
	US10B	79.40	066460		
	DBZ	63.50	-		
	US26	82.80	-		
	US26D	67.90	066286		
	US32	74.00	083352		
	US32D	55.00	066241		



39G					
Pull Plate - Square Corner - 3/4" Oval Pull					
Material: Brass, bronze, aluminum, stainless steel					
Gauge: 0.050; CTC: 8"					
Fasteners: #6 x 5/8" OPH tapping screws					
30S x 9G Pull	US3	59.75	066446	1	10
3-1/2" x 15"	US4	59.75	022286		
	US10	64.30	066439		
	US10B	80.40	066440		
	DBZ	64.30	-		
	US26	82.45	125056		
	US26D	68.90	021978		
	US32	74.85	113343		
	US32D	55.00	066442		
4" x 16"	US3	63.75	066448	1	10
	US4	63.75	074705		
	US10	68.65	066449		
	US10B	85.80	066450		
	DBZ	68.65	-		
	US26	86.45	066443		
	US26D	72.85	070325		
	US32	78.85	019174		
	US32D	57.00	066444		

1. Items with the price in **bold and red** are Quick Ship items and ship in 24 hours.
 Please use stock number when ordering. 2. U/M is each unless otherwise noted.



Trim & Auxiliary



Description	Finish	2018 List	Stock No.	Box Qty.	Case Qty.
391					
Pull Plate - Square Corner - 3/4" Oval Pull					
Material: Brass, bronze, aluminum, stainless steel					
Gauge: 0.050; CTC: 10"					
Fasteners: #6 x 5/8" OPH tapping screws					
30S x 9J Pull					
3-1/2" x 15"	US3	76.35	086925	1	10
	US4	92.50	-		
	US10	92.50	124357		
	US10B	115.65	039926		
	DBZ	92.50	-		
	US26	103.20	-		
	US26D	98.40	-		
	US32	95.60	-		
	US32D	82.25	005157		
4" x 16"	US3	75.25	086628	1	10
	US4	93.05	-		
	US10	93.05	112185		
	US10B	116.30	033458		
	DBZ	93.05	-		
	US26	106.25	106111		
	US26D	103.00	076007		
	US32	96.35	-		
	US32D	83.75	074073		





Description	Finish	2018 List	Stock No.	Box Qty.	Case Qty.
40R					
Push Plate - Radius Corner - Beveled					
Material: Brass, bronze, aluminum, stainless steel					
Gauge: 0.050					
Fasteners: #6 x 5/8" OPH tapping screws					
3" x 12"	US3	22.70	073770	10	50
	US4	23.55	076051		
	US10	27.30	066942		
	US10B	34.15	003979		
	DBZ	27.30	-		
	US26	27.30	066131		
	US26D	27.30	074534		
	US28	14.20	043755		
	US32	21.25	066229		
	US32D	18.25	-		
3-1/2" x 15"	US3	26.20	058476	10	50
	US4	29.10	080655		
	US10	31.45	057093		
	US10B	39.30	025774		
	DBZ	31.45	-		
	US26	31.45	086949		
	US26D	31.45	059230		
	US28	15.30	066906		
	US32	24.60	059562		
	US32D	21.25	-		
4" x 16"	US3	28.90	058347	10	50
	US4	31.90	081497		
	US10	34.35	016005		
	US10B	42.95	060152		
	DBZ	34.35	-		
	US26	34.35	059245		
	US26D	34.35	085378		
	US28	16.05	016006		
	US32	26.50	088231		
	US32D	22.80	052790		
6" x 16"	US3	40.35	057640	-	5
	US4	43.40	047040		
	US10	47.15	006018		
	US10B	58.95	072734		
	DBZ	47.15	-		
	US26	47.15	-		
	US26D	47.15	114027		
	US28	20.85	010887		
	US32	49.75	088229		
	US32D	34.75	057637		
8" x 16"	US3	47.35	025145	-	5
	US4	52.65	022787		
	US10	56.80	015792		
	US10B	71.00	061212		
	DBZ	56.80	-		
	US26	56.80	126198		
	US26D	56.80	024628		
	US28	23.75	122600		
	US32	50.55	-		
	US32D	51.80	061211		

1. Items with the price in **bold and red** are Quick Ship items and ship in 24 hours.
 Please use stock number when ordering. 2. U/M is each unless otherwise noted.



Trim & Auxiliary



Description	Finish	2018 List	Stock No.	Box Qty.	Case Qty.
A40R					
Push Plate - Radius Corner - Beveled					
Material: Brass, bronze, aluminum, stainless steel					
Gauge: 0.062					
Fasteners: #6 x 5/8" OPH tapping screws					
3" x 12"	US3	33.45	032130	10	50
	US4	33.45	131011		
	US10	38.05	-		
	US10B	47.55	114771		
	DBZ	38.05	-		
	US26	38.05	039363		
	US26D	38.05	114030		
	US28	22.80	-		
	US32	33.25	-		
	US32D	23.25	048868		
3-1/2" x 15"	US3	35.70	-	10	50
	US4	35.70	049913		
	US10	42.00	-		
	US10B	52.50	074760		
	DBZ	42.00	-		
	US26	42.00	044606		
	US26D	42.00	038686		
	US28	20.50	-		
	US32	39.25	-		
	US32D	27.45	059304		
4" x 16"	US3	39.60	029232	10	50
	US4	39.60	014136		
	US10	45.85	140485		
	US10B	57.30	077017		
	DBZ	45.85	-		
	US26	45.85	-		
	US26D	45.85	015454		
	US28	21.70	047411		
	US32	41.30	135831		
	US32D	29.90	099623		
6" x 16"	US3	52.50	029232	-	5
	US4	57.10	-		
	US10	57.10	-		
	US10B	71.40	-		
	DBZ	57.10	-		
	US26	57.10	-		
	US26D	57.10	055405		
	US28	26.80	-		
	US32	64.65	-		
	US32D	46.95	070607		
8" x 16"	US3	58.40	076399	-	5
	US4	64.10	-		
	US10	65.05	-		
	US10B	81.30	077019		
	DBZ	65.05	-		
	US26	65.05	-		
	US26D	65.05	142995		
	US28	30.15	-		
	US32	81.90	-		
	US32D	49.75	001398		





Description	Finish	2018 List	Stock No.	Box Qty.	Case Qty.
50T					
Push Plate - Round - Beveled					
Material: Brass, bronze, aluminum, stainless steel					
Gauge: 0.050					
Fasteners: #6 x 5/8" OPH tapping screws					
3" x 12"	US3	27.45	078618	5	50
	US4	27.45	007196		
	US10	29.90	006322		
	US10B	37.40	071333		
	DBZ	29.90	-		
	US26	29.90	-		
	US26D	29.90	102851		
	US28	20.25	102662		
	US32	23.85	-		
	US32D	22.80	059934		
3-1/2" x 15"	US3	28.90	057418	5	50
	US4	28.90	077529		
	US10	34.25	088168		
	US10B	42.80	000846		
	DBZ	34.25	-		
	US26	34.25	075140		
	US26D	34.25	062792		
	US28	22.40	041167		
	US32	27.30	015650		
	US32D	25.05	072371		
4" x 16"	US3	31.90	056970	5	50
	US4	31.90	068950		
	US10	36.65	058204		
	US10B	45.80	075002		
	DBZ	36.65	-		
	US26	36.65	059593		
	US26D	36.65	092668		
	US28	23.85	018465		
	US32	26.50	000492		
	US32D	29.50	016007		

1. Items with the price in **bold and red** are Quick Ship items and ship in 24 hours.
 Please use stock number when ordering. 2. U/M is each unless otherwise noted.



Trim & Auxiliary



Description	Finish	2018 List	Stock No.	Box Qty.	Case Qty.
A50T					
Push Plate - Round - Beveled					
Material: Brass, bronze, aluminum, stainless steel					
Gauge: 0.062					
Fasteners: #6 x 5/8" OPH tapping screws					
3" x 12"	US3	43.40	094264	5	50
	US4	43.40	107968		
	US10	48.10	-		
	US10B	60.15	095264		
	DBZ	48.10	-		
	US26	48.10	075708		
	US26D	48.10	079997		
	US28	27.30	097574		
	US32	37.80	-		
	US32D	32.25	034543		
3-1/2" x 15"	US3	45.10	099962	5	50
	US4	45.10	094532		
	US10	52.90	-		
	US10B	66.15	054241		
	DBZ	52.90	-		
	US26	52.90	014282		
	US26D	52.90	069277		
	US28	31.70	-		
	US32	39.25	-		
	US32D	33.25	084951		
4" x 16"	US3	48.90	084171	5	50
	US4	48.90	075929		
	US10	56.65	130057		
	US10B	70.80	111705		
	DBZ	56.65	-		
	US26	56.65	134570		
	US26D	56.65	032134		
	US28	33.25	039648		
	US32	41.30	053431		
	US32D	36.35	031281		
60S					
Push Plate - Square Corner - Beveled					
Material: Plastic Laminate					
Gauge: 0.125					
Fasteners: #6 x 5/8" OPH tapping screws					
3" x 12"	PG - Gray	10.75	-	5	50
	PK - Black	10.75	067121		
	CO - Brown	10.75	035206		
3-1/2" x 15"	PG - Gray	11.55	-	5	50
	PK - Black	11.55	055792		
	CO - Brown	11.55	085523		
4" x 16"	PG - Gray	12.20	072811	5	50
	PK - Black	12.20	056442		
	CO - Brown	12.20	076032		
6" x 16"	PG - Gray	15.30	094770	5	50
	PK - Black	15.30	056581		
	CO - Brown	15.30	076033		
8" x 16"	PG - Gray	18.25	029886	5	50
	PK - Black	18.25	-		
	CO - Brown	18.25	061399		





Description	Finish	2018 List	Stock No.	Box Qty.	Case Qty.
70S					
Push Plate - Square Corner - Beveled					
Material: Clear Plastic Laminate					
Gauge: 0.125					
Fasteners: #6 x 5/8" OPH tapping screws					
3" x 12"	PC - Clear	10.75	057033	5	50
3-1/2" x 15"	PC - Clear	12.15	056757	5	50
6" x 16"	PC - Clear	17.35	058687	5	50
8" x 16"	PC - Clear	20.00	062760	5	50

1. Items with the price in **bold and red** are Quick Ship items and ship in 24 hours.
 Please use stock number when ordering. 2. U/M is each unless otherwise noted.



Trim & Auxiliary



Description	Finish	2018 List	Stock No.	Box Qty.	Case Qty.
80S					
Push Plate - Square Corner - Beveled					
Material: Brass, bronze, aluminum, stainless steel					
Gauge: 0.125					
Fasteners: #6 x 5/8" OPH tapping screws					
3" x 12"	US3	48.80	018566	5	50
	US4	51.55	-		
	US10	57.10	110525		
	US10B	71.40	053549		
	DBZ	57.10	-		
	US26	57.10	113461		
	US26D	57.10	064583		
	US28	24.15	147832		
	US32	52.05	142047		
	US32D	40.50	021042		
3-1/2" x 15"	US3	54.05	099583	5	50
	US4	59.20	000935		
	US10	62.85	080441		
	US10B	78.55	064035		
	DBZ	62.85	-		
	US26	62.85	023445		
	US26D	62.85	098464		
	US28	27.85	085960		
	US32	56.90	123564		
	US32D	29.50	066719		
4" x 16"	US3	67.50	069050	5	50
	US4	67.50	053351		
	US10	70.00	070736		
	US10B	87.50	080514		
	DBZ	70.00	-		
	US26	67.80	003451		
	US26D	67.80	099998		
	US28	29.40	000740		
	US32	59.15	081409		
	US32D	37.50	064974		
6" x 16"	US3	79.60	125266	-	5
	US4	81.85	138751		
	US10	84.40	134181		
	US10B	105.50	057343		
	DBZ	84.40	-		
	US26	84.40	-		
	US26D	84.40	024257		
	US28	43.40	111496		
	US32	75.55	033372		
	US32D	58.10	062560		
8" x 16"	US3	101.05	024903	-	5
	US4	103.00	122088		
	US10	103.00	042324		
	US10B	132.65	041316		
	DBZ	106.10	-		
	US26	106.10	078222		
	US26D	106.10	-		
	US28	52.90	-		
	US32	93.65	021592		
	US32D	72.15	073791		





Description	Finish	2018 List	Stock No.	Box Qty.	Case Qty.
90R					
Push Plate - Radius Corner - Not Beveled					
Material: Brass, bronze, aluminum, stainless steel					
Gauge: 0.125					
Fasteners: #6 x 5/8" OPH tapping screws					
3" x 12"	US3	65.00	-	5	50
	US4	68.80	013671		
	US10	73.30	-		
	US10B	91.65	056839		
	DBZ	73.30	-		
	US26	73.30	043374		
	US26D	73.30	097121		
	US28	39.25	026780		
	US32	68.10	-		
	US32D	53.15	099013		
3-1/2" x 15"	US3	70.15	116990	5	50
	US4	72.75	-		
	US10	78.95	140484		
	US10B	98.70	010106		
	DBZ	78.95	-		
	US26	78.95	068575		
	US26D	78.95	032458		
	US28	43.60	078511		
	US32	73.55	-		
	US32D	57.00	068865		
4" x 16"	US3	74.30	086539	5	50
	US4	79.60	002134		
	US10	84.05	077793		
	US10B	105.05	035806		
	DBZ	84.05	-		
	US26	84.05	013904		
	US26D	84.05	084672		
	US28	45.10	-		
	US32	78.90	-		
	US32D	58.10	075458		
6" x 16"	US3	95.90	092195	-	5
	US4	98.05	-		
	US10	100.60	-		
	US10B	125.75	087169		
	DBZ	100.60	-		
	US26	100.60	-		
	US26D	100.60	018872		
	US28	59.30	-		
	US32	91.25	-		
	US32D	69.60	080425		
8" x 16"	US3	117.35	-	-	5
	US4	119.25	-		
	US10	122.10	-		
	US10B	152.65	046733		
	DBZ	122.10	-		
	US26	122.10	-		
	US26D	122.10	-		
	US28	68.60	-		
	US32	109.40	-		
	US32D	82.50	018249		

1. Items with the price in **bold and red** are Quick Ship items and ship in 24 hours.
 Please use stock number when ordering. 2. U/M is each unless otherwise noted.



Trim & Auxiliary



Description	Finish	2018 List	Stock No.	Box Qty.	Case Qty.
100T					
Push Plate - Square Corner - Rounded Bevel - Top and Bottom					
Material: Brass, bronze, aluminum, stainless steel					
Gauge: 0.125					
Fasteners: #6 x 5/8" OPH tapping screws					
3" x 12"	US3	63.50	080351	5	50
	US4	65.60	093144		
	US10	71.40	-		
	US10B	89.25	016836		
	DBZ	71.40	-		
	US26	71.40	051749		
	US26D	71.40	025230		
	US28	37.95	-		
	US32	66.30	094651		
	US32D	51.65	094863		
3-1/2" x 15"	US3	68.40	069291	5	50
	US4	71.00	040912		
	US10	77.15	068702		
	US10B	96.45	069149		
	DBZ	77.15	-		
	US26	77.15	-		
	US26D	77.15	007779		
	US28	42.30	121532		
	US32	71.80	071048		
	US32D	55.70	078531		
4" x 16"	US3	72.65	079375	5	50
	US4	82.25	120436		
	US10	82.25	036191		
	US10B	102.80	069394		
	DBZ	82.25	-		
	US26	82.25	131710		
	US26D	82.25	068881		
	US28	50.10	-		
	US32	75.60	080612		
	US32D	59.15	071810		
6" x 16"	US3	82.25	-	-	5
	US4	88.55	-		
	US10	92.10	-		
	US10B	115.15	032106		
	DBZ	92.10	-		
	US26	92.10	028999		
	US26D	92.10	146901		
	US28	57.40	138277		
	US32	75.55	-		
	US32D	67.90	001305		
8" x 16"	US3	109.60	-	-	5
	US4	119.50	-		
	US10	124.10	-		
	US10B	155.15	016853		
	DBZ	124.10	-		
	US26	124.10	-		
	US26D	124.10	146776		
	US28	98.55	-		
	US32	96.80	134422		
	US32D	92.15	012977		





Description	Finish	2018 List	Stock No.	Box Qty.	Case Qty.
110S					
Half Circle Push Plate	US3	58.05	018809	1	10
8" x 16"	US4	58.05	023148		
Material: Brass, bronze, aluminum, stainless steel	US10B	81.15	017836		
Gauge: 0.050	DBZ	64.90	-		
Fasteners: #6 x 5/8" OPH tapping screws	US26	64.90	018083		
	US26D	64.90	004595		
	US28	37.05	043858		
	US32	55.80	032334		
	US32D	45.35	001030		



120L					
Pull Plate - w/ Lip (Not beveled)	US3	85.00	052718	2	20
3-1/2"x16"	US4	85.00	054479		
Material: Brass, bronze, aluminum, stainless steel	US10	76.50	052719		
Lip Projection: 1-1/8"	US10B	95.65	052720		
Gauge: 0.125	DBZ	76.50	-		
Fasteners: #6 x 5/8" OPH tapping screws	US26	76.50	052837		
	US26D	76.50	052721		
	US28	38.05	052517		
	US32	95.40	016965		
	US32D	41.55	052518		



121L					
Cylinder Pull	US3	49.50	082020	1	10
2" x 3-3/4"	US4	38.05	080813		
Material: Brass, bronze, aluminum, stainless steel	US10	52.50	074977		
Beveled Lip Projection: 1-1/8"	US10B	65.65	073385		
Gauge: 0.125	DBZ	52.50	-		
Cylinder Cutout: 1-1/4" diameter	US26	38.80	020459		
Cylinder sold separately. Stud installed on reverse to prevent twisting.	US26D	52.50	069510		
	US28	34.00	063605		
	US32	45.35	095790		
	US32D	43.00	068962		









122L					
Security Push/Pull Set	US32D	217.60	088047	1	10
Push Plate: 4" x 16"					
Pull Plate: 4" x 9-1/4"					
Fasteners: BTB by Type 6					
Lip Projection: 2-1/8"					
Gauge: 0.125					
Mounting with security torx screws and blank head sex nuts.					

1. Items with the price in **bold and red** are Quick Ship items and ship in 24 hours.
Please use stock number when ordering. 2. U/M is each unless otherwise noted.



Trim & Auxiliary

	Description	Finish	2018 List	Case Qty.	CTC Over 36"*	
	125S	US3	186.90			
	Bent Push Bar	US4	186.90	4	4.00	
	Material: Brass, bronze, aluminum, stainless steel	US10	193.35		4.00	
	Bar Size: 3/8" x 1-1/4"	US10B	241.70		4.00	
	Base Plate: 1" x 3"	DBZ	193.35		4.00	
	Projection: 2-1/8"	US28	115.90		2.75	
	*Add per linear inch or fraction thereof	US32	209.30		6.70	
	Standard fasteners are 1/4"-20 FPHMS and #8 x 3/4" FPH Tapping Screws.	US32D	168.40		5.65	
	<hr/>					
		126S	US3	193.35		
Push Bar		US4	242.00	4	4.00	
Material: Brass, bronze, aluminum, stainless steel		US10	286.90		4.00	
Bar Size: 3/8" x 1-1/4"		US10B	358.65		4.00	
Base Plate: 1" x 3"		DBZ	286.90		4.00	
Projection: 2-1/8"		US28	140.45		2.75	
*Add per linear inch or fraction thereof		US32	246.75		6.70	
Standard fasteners are #8 x 3/4" FPH Tapping Screws.		US32D	218.15		5.65	
Optional thru bolts available.		<hr/>				
		127S	US3	141.65	1	8.00
	Push Bar	US4	157.30		8.00	
	Material: Brass, bronze, aluminum, stainless steel	US10	157.30		8.00	
	Bar Size: 3/8" x 1-1/4"	US10B	196.65		8.00	
	Base: 1-1/4" Square	DBZ	157.30		8.00	
	Projection: 3/4"	US28	90.35		5.45	
	*Add per linear inch or fraction thereof	US32	165.50		12.90	
	Standard fasteners are 1/4"-20 FPHMS. Optional wood screws available no charge.	US32D	127.90		13.40	
	<hr/>					
		128P	US3	337.30	1	8.00
Wide Push Bar		US4	360.85		8.00	
Material: Brass, bronze, aluminum, stainless steel		US10	371.75		8.00	
Bar Size: 3/8" x 3"		US10B	464.70		8.00	
Base Plate: 1-1/2" x 4-1/2"		DBZ	371.75		8.00	
Projection: 2-1/8"		US28	313.45		5.45	
*Add per linear inch or fraction thereof		US32	392.85		12.90	
Standard fasteners are #8 x 3/4" FPH Tapping Screws.		US32D	330.75		13.40	
Optional thru bolts available.		<hr/>				
		128S	US3	317.55	1	8.00
	Wide Push Bar	US4	331.95		8.00	
	Material: Brass, bronze, aluminum, stainless steel	US10	347.90		8.00	
	Bar Size: 3/8" x 3"	US10B	434.90		8.00	
	Base: 3/8" x 3"	DBZ	347.90		8.00	
	Projection: 2"	US28	173.75		5.45	
	Door Thickness: 1-3/4" Standard	US32	368.25		12.90	
	*Add per linear inch or fraction thereof	US32D	306.90		13.40	
	Standard fasteners are 1/4"-20 x 2-1/4" FPHMS with finish washers.	<hr/>				
		129P	US3	268.90	1	8.00
Wide Push Bar		US4	285.00		8.00	
Bar Size: 3/8" x 3"		US10	301.40		8.00	
Base: 1" x 3"		US10B	376.75		8.00	
Projection: 3/4"		DBZ	301.40		8.00	
*Add per linear inch or fraction thereof		US28	124.85		5.45	
Standard fasteners are 1/4"-20 x 1-1/4" FPHMS. Optional thru bolts available. #14 FPH wood screws available.		US32	332.05		12.90	
		US32D	263.00		13.40	





Description	Finish	2018 List	Case Qty.	CTC Over 36"*
130S				
Push Bar	US3	184.10	4	4.00
Material: Brass, bronze, aluminum, stainless steel	US4	198.55		4.00
Bar Stock: 1" Round	US10	236.65		4.00
Projection: 2-1/2"	US10B	295.80		4.00
Door Thickness: 1-3/4"	DBZ	236.65		4.00
*Add per linear inch or fraction thereof	US28	87.10		2.75
Standard fasteners are 1/4"-20 x 2-1/4" FPHMS with finish washers. May be ordered with Type 5 mounting at an extra charge.	US32	219.40		6.70
	US32D	173.75		5.65



131S				
Push Bar	US3	189.60	4	4.00
Material: Brass, bronze, aluminum, stainless steel	US4	207.55		4.00
Bar Stock: 1" Round	US10	227.40		4.00
Base Plate: 2" Diameter	US10B	284.25		4.00
Projection: 2-5/8"	DBZ	227.40		4.00
Door Thickness: 1-3/4" Standard	US28	94.95		2.75
*Add per linear inch or fraction thereof	US32	229.60		6.70
Standard fasteners are 1/4"-20 x 2-1/4" FPHMS with finish washers. May be ordered with Type 5 mounting at an extra charge.	US32D	187.95		5.65



133S				
Push Bar	US3	156.00	4	4.00
Material: Brass, bronze, aluminum, stainless steel	US4	169.75		4.00
Bar Stock: 3/4" Round	US10	184.10		4.00
Projection: 2-1/4"	US10B	230.15		4.00
Door Thickness: 1-3/4" Standard	DBZ	184.10		4.00
*Add per linear inch or fraction thereof	US28	73.85		2.75
Standard fasteners are 1/4"-20 x 2-1/4" FPHMS with finish washers.	US32	188.15		6.70
	US32D	147.70		5.65



134S				
Push Bar	US3	162.30	4	4.00
Material: Brass, bronze, aluminum, stainless steel	US4	182.35		4.00
Bar Stock: 3/4" Round	US10	194.85		4.00
Base Plate: 1-1/4" Diameter	US10B	243.55		4.00
Projection: 2-3/8"	DBZ	194.85		4.00
Door Thickness: 1-3/4" Standard	US28	84.30		2.75
*Add per linear inch or fraction thereof	US32	206.60		6.70
Standard fasteners are 1/4"-20 x 2-1/4" FPHMS with finish washers. May be ordered with Type 5 mounting at an extra charge.	US32D	157.95		5.65







136S				
Push Bar	US3	388.00	4	8.00
Material: Brass, bronze, aluminum, stainless steel	US4	396.85		8.00
Bar Stock: 1-1/4" Round	US10	405.80		8.00
Projection: 3"	US10B	507.25		8.00
Fasteners: 5/16" - 18 x 2-1/4" with finish washers	DBZ	405.80		8.00
Door Thickness: 1-3/4" Standard	US28	280.65		5.45
*Add per linear inch or fraction thereof	US32	368.25		12.90
May be ordered with Type 5 mounting at an extra charge.	US32D	333.20		13.40

1. Items with the price in **bold and red** are Quick Ship items and ship in 24 hours.
Please use stock number when ordering. 2. U/M is each unless otherwise noted.



Trim & Auxiliary

	Description	Finish	2018 List	Case Qty.	CTC Over 36"*	
	137S					
	Push Bar	US3	397.20	4	8.00	
	Material: Brass, bronze, aluminum, stainless steel	US4	405.80		8.00	
	Bar Stock: 1-1/4" Round	US10	415.00		8.00	
	Base Plate: 2" Diameter	US10B	518.75		8.00	
	Projection: 3-1/8"	DBZ	415.00		8.00	
	Door Thickness: 1-3/4" Standard	US28	289.40		5.45	
	Fasteners: 5/16" - 18 x 2-1/4" with finish washers	US32	419.15		12.90	
	Additional bars by quotation	US32D	341.95		13.40	
	*Add per linear inch or fraction thereof May be ordered with Type 5 mounting at an extra charge.					
	138P	US3	411.10		16.10	
	Push/Pull Set	US4	447.30	2	16.10	
	Material: Brass, bronze, aluminum, stainless steel	US10	475.95		16.10	
	Bar Stock: 1" Round	US10B	594.95		16.10	
	Projection: 2-1/2"	DBZ	475.95		16.10	
	Fasteners: 1/4" - 20 type 3 concealed cone	US28	215.80		10.70	
	*Add per linear inch or fraction thereof	US32	480.50		23.65	
		US32D	389.25		26.80	
		139P	US3	354.90	2	16.10
		Push/Pull Set	US4	382.45		16.10
Material: Brass, bronze, aluminum, stainless steel		US10	411.10		16.10	
Bar Stock: 3/4" Round		US10B	513.90		16.10	
Projection: 2-1/4"		DBZ	411.10		16.10	
Fasteners: 1/4" - 20 type 3 concealed cone		US28	189.45		10.70	
*Add per linear inch or fraction thereof		US32	417.20		23.65	
		US32D	337.30		26.80	
		140P	US3	820.60	2	16.10
		Push/Pull Set	US4	836.55		16.10
	Material: Brass, bronze, aluminum, stainless steel	US10	854.55		16.10	
	Bar Stock: 1-1/4" Round	US10B	1068.20		16.10	
	Projection: 3"	DBZ	854.55		16.10	
	Fasteners: 5-16" - 18 Type 3 concealed cone	US28	620.50		10.70	
	*Add per linear inch or fraction thereof	US32	813.40		23.65	
		US32D	708.25		26.80	
		150B	US3	283.25	2	4.00
		Push/Pull Set	US4	296.00		4.00
Material: Brass, bronze, aluminum, stainless steel		US10	304.85		4.00	
Bar Stock: 3/4" Round		US10B	381.05		4.00	
Projection: 2-1/4"		DBZ	304.85		4.00	
CTC: 8"		US28	160.05		2.75	
Fasteners: Type 7 & (2) Type 8		US32	348.95		6.70	
Additional bars by quotation		US32D	278.85		5.65	
*Add per linear inch or fraction thereof For tempered glass only						



Description	Finish	2018 List	Case Qty.	CTC Over 36"*
150D				
Push/Pull Set	US3	238.65	2	4.00
	US4	250.85		4.00
Material: Brass, bronze, aluminum, stainless steel	US10	259.75		4.00
Bar Stock: 3/4" Round	US10B	324.70		4.00
Projection: 2-1/4"	DBZ	259.75		4.00
CTC: 8"	US28	124.70		2.75
Fasteners: Type 7 & (2) Type 1	US32	305.20		6.70
Additional bars by quotation	US32D	235.05		5.65
*Add per linear inch or fraction thereof				
Standard fastening method				



150V				
Push/Pull Set	US3	267.50	2	4.00
	US4	279.75		4.00
Material: Brass, bronze, aluminum, stainless steel	US10	288.60		4.00
Bar Stock: 3/4" Round	US10B	360.75		4.00
Projection: 2-1/4"	DBZ	288.60		4.00
CTC: 8"	US28	152.75		2.75
Fasteners: Type 7 & (2) Type 5	US32	333.20		6.70
Additional bars by quotation	US32D	263.00		5.65
*Add per linear inch or fraction thereof				
Fully concealed fastening method				



151B				
Push/Pull Set	US3	296.00	2	4.00
	US4	308.45		4.00
Material: Brass, bronze, aluminum, stainless steel	US10	319.90		4.00
Bar Stock: 3/4" Round	US10B	399.90		4.00
Projection: 2-1/4"	DBZ	319.90		4.00
CTC: 10"	US28	177.55		2.75
Fasteners: Type 7 & (2) Type 8	US32	317.40		6.70
Additional bars by quotation	US32D	289.40		5.65
*Add per linear inch or fraction thereof				
For tempered glass only				



151D				
Push/Pull Set	US3	250.85	2	4.00
	US4	263.60		4.00
Material: Brass, bronze, aluminum, stainless steel	US10	274.85		4.00
Bar Stock: 3/4" Round	US10B	343.55		4.00
Projection: 2-1/4"	DBZ	274.85		4.00
CTC: 10"	US28	135.35		2.75
Fasteners: Type 7 & (2) Type 1	US32	315.65		6.70
Additional bars by quotation	US32D	245.60		5.65
*Add per linear inch or fraction thereof				
Standard fastening method				







151V				
Push/Pull Set	US3	279.75	2	4.00
	US4	292.20		4.00
Material: Brass, bronze, aluminum, stainless steel	US10	303.70		4.00
Bar Stock: 3/4" Round	US10B	379.65		4.00
Projection: 2-1/4"	DBZ	303.70		4.00
CTC: 10"	US28	166.15		2.75
Fasteners: Type 7 & (2) Type 5	US32	343.70		6.70
Additional bars by quotation	US32D	273.55		5.65
*Add per linear inch or fraction thereof				
Fully concealed fastening method				

1. Items with the price in **bold and red** are Quick Ship items and ship in 24 hours.
Please use stock number when ordering. 2. U/M is each unless otherwise noted.



Trim & Auxiliary

	Description	Finish	2018 List	Case Qty.	CTC Over 36"*
	152B			2	4.00
	Push/Pull Set	US3	309.10		4.00
	Material: Brass, bronze, aluminum, stainless steel	US4	330.10		4.00
	Bar Stock: 3/4" Round	US10	333.75		4.00
	Projection: 2-1/4"	US10B	412.20		4.00
	CTC: 12"	DBZ	333.75		4.00
	Fasteners: Type 7 & (2) Type 8	US28	187.85		2.75
	Additional bars by quotation	US32	365.10		6.70
	*Add per linear inch or fraction thereof	US32D	299.95		5.65
	For tempered glass only				
	152D			2	4.00
	Push/Pull Set	US3	263.85		4.00
	Material: Brass, bronze, aluminum, stainless steel	US4	285.00		4.00
	Bar Stock: 3/4" Round	US10	288.60		4.00
	Projection: 2-1/4"	US10B	360.75		4.00
	CTC: 12"	DBZ	288.60		4.00
	Fasteners: Type 7 & (2) Type 1	US28	148.75		2.75
	Additional bars by quotation	US32	321.35		6.70
	*Add per linear inch or fraction thereof	US32D	256.25		5.65
	Standard fastening method				
	152V			2	4.00
	Push/Pull Set	US3	292.60		4.00
	Material: Brass, bronze, aluminum, stainless steel	US4	313.85		4.00
	Bar Stock: 3/4" Round	US10	317.55		4.00
	Projection: 2-1/4"	US10B	396.95		4.00
	CTC: 12"	DBZ	317.55		4.00
	Fasteners: Type 7 & (2) Type 5	US28	179.55		2.75
	Additional bars by quotation	US32	349.50		6.70
	*Add per linear inch or fraction thereof	US32D	284.15		5.65
	Fully concealed fastening method				
	153B			2	4.00
	Push/Pull Set	US3	317.05		4.00
	Material: Brass, bronze, aluminum, stainless steel	US4	355.25		4.00
	Bar Stock: 1" Round	US10	355.25		4.00
	Projection: 2-1/2"	US10B	444.05		4.00
	CTC: 10"	DBZ	355.25		4.00
	Fasteners: Type 7 & (2) Type 8	US28	180.60		2.75
	Additional bars by quotation	US32	369.00		6.70
	*Add per linear inch or fraction thereof	US32D	299.60		5.65
	For tempered glass only				
	153D			2	4.00
	Push/Pull Set	US3	272.10		4.00
	Material: Brass, bronze, aluminum, stainless steel	US4	310.20		4.00
	Bar Stock: 1" Round	US10	323.35		4.00
	Projection: 2-1/2"	US10B	407.40		4.00
	CTC: 10"	DBZ	325.90		4.00
	Fasteners: Type 7 & (2) Type 1	US28	136.85		2.75
	Additional bars by quotation	US32	325.20		6.70
	*Add per linear inch or fraction thereof	US32D	255.75		5.65
	Standard fastening method				



Description	Finish	2018 List	Case Qty.	CTC Over 36"*
153V				
Push/Pull Set	US3	301.40	2	4.00
Material: Brass, bronze, aluminum, stainless steel	US4	339.10		4.00
Bar Stock: 1" Round	US10	339.10		4.00
Projection: 2-1/2"	US10B	423.90		4.00
CTC: 10"	DBZ	339.10		4.00
Fasteners: Type 7 & (2) Type 5	US28	166.85		2.75
Additional bars by quotation	US32	353.25		6.70
*Add per linear inch or fraction thereof	US32D	283.75		5.65
Fully concealed fastening method				



154B				
Push/Pull Set	US3	327.80	2	4.00
Material: Brass, bronze, aluminum, stainless steel	US4	371.85		4.00
Bar Stock: 1" Round	US10	380.15		4.00
Projection: 2-1/2"	US10B	472.20		4.00
CTC: 12"	DBZ	380.15		4.00
Fasteners: Type 7 & (2) Type 8	US28	207.00		2.75
Additional bars by quotation	US32	381.70		6.70
*Add per linear inch or fraction thereof	US32D	308.80		5.65
For tempered glass only				



154D				
Push/Pull Set	US3	281.25	2	4.00
Material: Brass, bronze, aluminum, stainless steel	US4	320.55		4.00
Bar Stock: 1" Round	US10	336.60		4.00
Projection: 2-1/2"	US10B	420.75		4.00
CTC: 12"	DBZ	336.60		4.00
Fasteners: Type 7 & (2) Type 1	US28	152.75		2.75
Additional bars by quotation	US32	337.90		6.70
*Add per linear inch or fraction thereof	US32D	264.90		5.65
Standard fastening method				



154V				
Push/Pull Set	US3	310.10	2	4.00
Material: Brass, bronze, aluminum, stainless steel	US4	349.35		4.00
Bar Stock: 1" Round	US10	364.80		4.00
Projection: 2-1/2"	US10B	456.00		4.00
CTC: 12"	DBZ	364.80		4.00
Fasteners: Type 7 & (2) Type 5	US28	189.00		2.75
Additional bars by quotation	US32	366.05		6.70
*Add per linear inch or fraction thereof	US32D	292.90		5.65
Fully concealed fastening method				







155B				
Push/Pull Set	US3	365.10	2	4.00
Material: Brass, bronze, aluminum, stainless steel	US4	387.85		4.00
Bar Stock: 1" Round	US10	410.60		4.00
Projection: 2-1/2"	US10B	513.25		4.00
CTC: 18"	DBZ	410.60		4.00
Fasteners: Type 7 & (2) Type 8	US28	236.20		2.75
Additional bars by quotation	US32	414.85		6.70
*Add per linear inch or fraction thereof	US32D	334.95		5.65
For tempered glass only				

1. Items with the price in **bold and red** are Quick Ship items and ship in 24 hours.
Please use stock number when ordering. 2. U/M is each unless otherwise noted.



Trim & Auxiliary

	Description	Finish	2018 List	Case Qty.	CTC Over 36"*
	155D				
	Push/Pull Set	US3	320.05	2	4.00
	Material: Brass, bronze, aluminum, stainless steel	US4	361.30		4.00
	Bar Stock: 1" Round	US10	365.65		4.00
	Projection: 2-1/2"	US10B	457.05		4.00
	CTC: 18"	DBZ	365.65		4.00
	Fasteners: Type 7 & (2) Type 1	US28	162.40		2.75
	Additional bars by quotation	US32	371.00		6.70
	*Add per linear inch or fraction thereof	US32D	291.15		5.65
	Standard fastening method				
	155V				
	Push/Pull Set	US3	348.85	2	4.00
	Material: Brass, bronze, aluminum, stainless steel	US4	371.75		4.00
	Bar Stock: 1" Round	US10	394.30		4.00
	Projection: 2-1/2"	US10B	492.90		4.00
	CTC: 18"	DBZ	394.30		4.00
	Fasteners: Type 7 & (2) Type 5	US28	199.30		2.75
	Additional bars by quotation	US32	399.00		6.70
	*Add per linear inch or fraction thereof	US32D	319.30		5.65
	Fully concealed fastening method				
	156B				
	Offset Push/Pull Set	US3	326.50	1	4.00
	Material: Brass, bronze, aluminum, stainless steel	US4	326.50		4.00
	Bar Stock: 3/4" Round	US10	341.35		4.00
	Projection: 2-1/2"	US10B	426.70		4.00
	Offset: 2-1/2"	DBZ	341.35		4.00
	CTC: 8"	US28	208.90		2.75
	Fasteners: Type 7 & (2) Type 8	US32	388.10		6.70
	Handing Required	US32D	308.90		5.65
	Additional bars by quotation				
*Add per linear inch or fraction thereof					
For tempered glass only					
	156D				
	Offset Push/Pull Set	US3	270.65	1	4.00
	Material: Brass, bronze, aluminum, stainless steel	US4	281.35		4.00
	Bar Stock: 3/4" Round	US10	296.20		4.00
	Projection: 2-1/2"	US10B	370.25		4.00
	Offset: 2-1/2"	DBZ	296.20		4.00
	CTC: 8"	US28	165.05		2.75
	Fasteners: Type 7 & (2) Type 1	US32	344.40		6.70
	Handing Required	US32D	265.05		5.65
	Additional bars by quotation				
*Add per linear inch or fraction thereof					
Standard fastening method					



Description	Finish	2018 List	Case Qty.	CTC Over 36"*
156V				
Offset Push/Pull Set	US3	300.00	1	4.00
Material: Brass, bronze, aluminum, stainless steel	US4	310.20		4.00
Bar Stock: 3/4" Round	US10	325.10		4.00
Projection: 2-1/2"	US10B	406.40		4.00
Offset: 2-1/2"	DBZ	325.10		4.00
CTC: 8"	US28	193.10		2.75
Fasteners: Type 7 & (2) Type 5	US32	372.30		6.70
Handing Required	US32D	293.10		5.65
Additional bars by quotation				
*Add per linear inch or fraction thereof				
Fully concealed fastening method				



157B				
Offset Push/Pull Set	US3	332.70	1	4.00
Material: Brass, bronze, aluminum, stainless steel	US4	341.65		4.00
Bar Stock: 3/4" Round	US10	357.10		4.00
Projection: 2-1/2"	US10B	446.40		4.00
Offset: 2-1/2"	DBZ	357.10		4.00
CTC: 10"	US28	212.95		2.75
Fasteners: Type 7 & (2) Type 8	US32	398.40		6.70
Handing Required	US32D	316.10		5.65
Additional bars by quotation				
*Add per linear inch or fraction thereof				
For tempered glass only				



157D				
Offset Push/Pull Set	US3	278.30	1	4.00
Material: Brass, bronze, aluminum, stainless steel	US4	288.60		4.00
Bar Stock: 3/4" Round	US10	304.05		4.00
Projection: 2-1/2"	US10B	380.05		4.00
Offset: 2-1/2"	DBZ	304.05		4.00
CTC: 10"	US28	169.25		2.75
Fasteners: Type 7 & (2) Type 1	US32	354.70		6.70
Handing Required	US32D	272.35		5.65
Additional bars by quotation				
*Add per linear inch or fraction thereof				
Standard fastening method				











157V				
Offset Push/Pull Set	US3	307.70	1	4.00
Material: Brass, bronze, aluminum, stainless steel	US4	317.55		4.00
Bar Stock: 3/4" Round	US10	333.05		4.00
Projection: 2-1/2"	US10B	416.30		4.00
Offset: 2-1/2"	DBZ	333.05		4.00
CTC: 10"	US28	197.40		2.75
Fasteners: Type 7 & (2) Type 5	US32	382.85		6.70
Handing Required	US32D	300.25		5.65
Additional bars by quotation				
*Add per linear inch or fraction thereof				
Fully concealed fastening method				

1. Items with the price in **bold and red** are Quick Ship items and ship in 24 hours.
Please use stock number when ordering. 2. U/M is each unless otherwise noted.



Trim & Auxiliary





	Description	Finish	2018 List	Case Qty.	CTC Over 36"*
	158B				
	Offset Push/Pull Set	US3	337.00	1	4.00
	Material: Brass, bronze, aluminum, stainless steel	US4	361.75		4.00
	Bar Stock: 3/4" Round	US10	377.25		4.00
	Projection: 2-1/2"	US10B	471.55		4.00
	Offset: 2-1/2"	DBZ	377.25		4.00
	CTC: 12"	US28	231.50		2.75
	Fasteners: Type 7 & (2) Type 8	US32	417.40		6.70
	Handing Required	US32D	329.75		5.65
	Additional bars by quotation				
	*Add per linear inch or fraction thereof				
	For tempered glass only				
		158D			
Offset Push/Pull Set		US3	308.65	1	4.00
Material: Brass, bronze, aluminum, stainless steel		US4	308.45		4.00
Bar Stock: 3/4" Round		US10	319.70		4.00
Projection: 2-1/2"		US10B	399.65		4.00
Offset: 2-1/2"		DBZ	319.70		4.00
CTC: 12"		US28	187.85		2.75
Fasteners: Type 7 & (2) Type 1		US32	373.45		6.70
Handing Required		US32D	285.90		5.65
Additional bars by quotation					
*Add per linear inch or fraction thereof					
Standard fastening method					
		158V			
	Offset Push/Pull Set	US3	320.90	1	4.00
	Material: Brass, bronze, aluminum, stainless steel	US4	337.30		4.00
	Bar Stock: 3/4" Round	US10	348.60		4.00
	Projection: 2-1/2"	US10B	435.75		4.00
	Offset: 2-1/2"	DBZ	348.60		4.00
	CTC: 12"	US28	215.80		2.75
	Fasteners: Type 7 & (2) Type 5	US32	401.55		6.70
	Handing Required	US32D	313.95		5.65
	Additional bars by quotation				
	*Add per linear inch or fraction thereof				
	Fully concealed fastening method				
		159B			
Offset Push/Pull Set		US3	358.95	1	4.00
Material: Brass, bronze, aluminum, stainless steel		US4	387.85		4.00
Bar Stock: 1" Round		US10	402.20		4.00
Projection: 2-1/2"		US10B	502.75		4.00
Offset: 3"		DBZ	402.20		4.00
CTC: 10"		US28	217.60		2.75
Fasteners: Type 7 & (2) Type 8		US32	394.45		6.70
Handing Required		US32D	336.25		5.65
Additional bars by quotation					
*Add per linear inch or fraction thereof					
For tempered glass only					

	Description	Finish	2018 List	Case Qty.	CTC Over 36"*
	159D				
	Offset Push/Pull Set	US3	313.85	1	4.00
	Material: Brass, bronze, aluminum, stainless steel	US4	342.75		4.00
	Bar Stock: 1" Round	US10	381.05		4.00
	Projection: 2-1/2"	US10B	476.30		4.00
	Offset: 3"	DBZ	381.05		4.00
	CTC: 10"	US28	166.95		2.75
	Fasteners: Type 7 & (2) Type 1	US32	350.85		6.70
	Handing Required	US32D	292.40		5.65
	Additional bars by quotation *Add per linear inch or fraction thereof Standard fastening method				
	159V				
	Offset Push/Pull Set	US3	342.75	1	4.00
	Material: Brass, bronze, aluminum, stainless steel	US4	371.75		4.00
	Bar Stock: 1" Round	US10	386.10		4.00
	Projection: 2-1/2"	US10B	482.65		4.00
	Offset: 3"	DBZ	386.10		4.00
	CTC: 10"	US28	200.05		2.75
	Fasteners: Type 7 & (2) Type 5	US32	378.80		6.70
	Handing Required	US32D	320.45		5.65
	Additional bars by quotation *Add per linear inch or fraction thereof Fully concealed fastening method				
	160B				
	Offset Push/Pull Set	US3	367.60	1	4.00
	Material: Brass, bronze, aluminum, stainless steel	US4	395.05		4.00
	Bar Stock: 1" Round	US10	409.50		4.00
	Projection: 2-1/2"	US10B	511.90		4.00
	Offset: 3"	DBZ	409.50		4.00
	CTC: 12"	US28	235.05		2.75
	Fasteners: Type 7 & (2) Type 8	US32	412.05		6.70
	Handing Required	US32D	341.95		5.65
	Additional bars by quotation *Add per linear inch or fraction thereof For tempered glass only				
	160D				
	Offset Push/Pull Set	US3	322.60	1	4.00
	Material: Brass, bronze, aluminum, stainless steel	US4	350.05		4.00
	Bar Stock: 1" Round	US10	384.20		4.00
	Projection: 2-1/2"	US10B	484.50		4.00
	Offset: 3"	DBZ	387.60		4.00
	CTC: 12"	US28	173.75		2.75
	Fasteners: Type 7 & (2) Type 1	US32	368.25		6.70
	Handing Required	US32D	298.25		5.65
	Additional bars by quotation *Add per linear inch or fraction thereof Standard fastening method				

1. Items with the price in **bold and red** are Quick Ship items and ship in 24 hours.
Please use stock number when ordering. 2. U/M is each unless otherwise noted.



Trim & Auxiliary

	Description	Finish	2018 List	Case Qty.	CTC Over 36"*
	160V				
	Offset Push/Pull Set	US3	351.30	1	4.00
	Material: Brass, bronze, aluminum, stainless steel	US4	378.80		4.00
	Bar Stock: 1" Round	US10	392.60		4.00
	Projection: 2-1/2"	US10B	491.55		4.00
	Offset: 3"	DBZ	393.25		4.00
	CTC: 12"	US28	210.65		2.75
	Fasteners: Type 7 & (2) Type 5	US32	396.35		6.70
	Handing Required	US32D	326.20		5.65
	Additional bars by quotation				
	*Add per linear inch or fraction thereof				
	Fully concealed fastening method				
	161B				
	Offset Push/Pull Set	US3	364.25	1	4.00
	Material: Brass, bronze, aluminum, stainless steel	US4	395.20		4.00
	Bar Stock: 1" Round	US10	420.80		4.00
	Projection: 2-1/2"	US10B	526.00		4.00
	Offset: 3"	DBZ	420.80		4.00
	CTC: 18"	US28	233.95		2.75
	Fasteners: Type 7 & (2) Type 8	US32	425.85		6.70
	Handing Required	US32D	342.40		5.65
	Additional bars by quotation				
	*Add per linear inch or fraction thereof				
	For tempered glass only				
	161D				
	Offset Push/Pull Set	US3	340.85	1	4.00
	Material: Brass, bronze, aluminum, stainless steel	US4	369.80		4.00
	Bar Stock: 1" Round	US10	396.85		4.00
	Projection: 2-1/2"	US10B	496.05		4.00
	Offset: 3"	DBZ	396.85		4.00
	CTC: 18"	US28	189.85		2.75
	Fasteners: Type 7 & (2) Type 1	US32	403.40		6.70
	Handing Required	US32D	323.15		5.65
	Additional bars by quotation				
	*Add per linear inch or fraction thereof				
	Standard fastening method				
	161V				
	Offset Push/Pull Set	US3	366.20	1	4.00
	Material: Brass, bronze, aluminum, stainless steel	US4	398.65		4.00
	Bar Stock: 1" Round	US10	425.75		4.00
	Projection: 2-1/2"	US10B	532.20		4.00
	Offset: 3"	DBZ	425.75		4.00
	CTC: 18"	US28	305.20		2.75
	Fasteners: Type 7 & (2) Type 5	US32	431.35		6.70
	Handing Required	US32D	343.70		5.65
	Additional bars by quotation				
	*Add per linear inch or fraction thereof				
	Fully concealed fastening method				



Description	Finish	2018 List	Case Qty.	CTC Over 36"*
164B				
Push/Pull Set	US3	647.55	1	8.00
Material: Brass, bronze, aluminum, stainless steel	US4	673.85		8.00
Bar Stock: 1-1/4" Round	US10	686.55		8.00
Projection: 3"	US10B	858.20		8.00
CTC: 12"	DBZ	686.55		8.00
Fasteners: Type 7 & (2) Type 8	US28	510.15		5.45
Additional bars by quotation	US32	682.55		12.90
*Add per linear inch or fraction thereof	US32D	563.20		13.40
For tempered glass only				



164D				
Push/Pull Set	US3	589.05	1	8.00
Material: Brass, bronze, aluminum, stainless steel	US4	627.95		8.00
Bar Stock: 1-1/4" Round	US10	627.95		8.00
Projection: 3"	US10B	784.95		8.00
CTC: 12"	DBZ	627.95		8.00
Fasteners: Type 7 & (2) Type 1	US28	453.20		5.45
Additional bars by quotation	US32	563.20		12.90
*Add per linear inch or fraction thereof	US32D	506.25		13.40
Standard fastening method				



164V				
Push/Pull Set	US3	666.90	1	8.00
Material: Brass, bronze, aluminum, stainless steel	US4	666.90		8.00
Bar Stock: 1-1/4" Round	US10	680.65		8.00
Projection: 3"	US10B	850.80		8.00
CTC: 12"	DBZ	680.65		8.00
Fasteners: Type 7 & (2) Type 5	US28	491.10		5.45
Additional bars by quotation	US32	614.35		12.90
*Add per linear inch or fraction thereof	US32D	549.95		13.40
Fully concealed fastening method				



165B				
Push/Pull Set	US3	686.55	1	8.00
Material: Brass, bronze, aluminum, stainless steel	US4	725.40		8.00
Bar Stock: 1-1/4" Round	US10	725.40		8.00
Projection: 3"	US10B	906.75		8.00
CTC: 18"	DBZ	725.40		8.00
Fasteners: Type 7 & (2) Type 8	US28	530.95		5.45
Additional bars by quotation	US32	648.45		12.90
*Add per linear inch or fraction thereof	US32D	597.30		13.40
For tempered glass only				







165D				
Push/Pull Set	US3	627.95	1	8.00
Material: Brass, bronze, aluminum, stainless steel	US4	666.90		8.00
Bar Stock: 1-1/4" Round	US10	666.90		8.00
Projection: 3"	US10B	833.65		8.00
CTC: 18"	DBZ	666.90		8.00
Fasteners: Type 7 & (2) Type 1	US28	474.10		5.45
Additional bars by quotation	US32	591.60		12.90
*Add per linear inch or fraction thereof	US32D	534.65		13.40
Standard fastening method				

1. Items with the price in **bold and red** are Quick Ship items and ship in 24 hours.
Please use stock number when ordering. 2. U/M is each unless otherwise noted.



Trim & Auxiliary

	Description	Finish	2018 List	Case Qty.	CTC Over 36"*
	165V				
	Push/Pull Set	US3	697.90	1	8.00
	Material: Brass, bronze, aluminum, stainless steel	US4	705.95		8.00
	Bar Stock: 1-1/4" Round	US10	705.95		8.00
	Projection: 3"	US10B	882.45		8.00
	CTC: 18"	DBZ	705.95		8.00
	Fasteners: Type 7 & (2) Type 5	US28	511.95		5.45
	Additional bars by quotation	US32	642.70		12.90
	*Add per linear inch or fraction thereof	US32D	587.80		13.40
	Fully concealed fastening method				
	167B				
	Offset Push/Pull Set	US3	760.50	1	8.00
	Material: Brass, bronze, aluminum, stainless steel	US4	778.00		8.00
	Bar Stock: 1-1/4" Round	US10	799.55		8.00
	Projection: 3"	US10B	999.45		8.00
	Offset: 3-3/4"	DBZ	799.55		8.00
	CTC: 18"	US28	568.95		5.45
	Fasteners: Type 7 & (2) Type 8	US32	718.65		12.90
	Handing Required	US32D	635.05		13.40
	Additional bars by quotation				
*Add per linear inch or fraction thereof					
For tempered glass only					
	167D				
	Offset Push/Pull Set	US3	726.20	1	8.00
	Material: Brass, bronze, aluminum, stainless steel	US4	726.20		8.00
	Bar Stock: 1-1/4" Round	US10	764.50		8.00
	Projection: 3"	US10B	955.65		8.00
	Offset: 3-3/4"	DBZ	764.50		8.00
	CTC: 18"	US28	511.95		5.45
	Fasteners: Type 7 & (2) Type 1	US32	661.70		12.90
	Handing Required	US32D	572.65		13.40
	Additional bars by quotation				
*Add per linear inch or fraction thereof					
Standard fastening method					
	167V				
	Offset Push/Pull Set	US3	729.45	1	8.00
	Material: Brass, bronze, aluminum, stainless steel	US4	743.40		8.00
	Bar Stock: 1-1/4" Round	US10	743.40		8.00
	Projection: 3"	US10B	929.25		8.00
	Offset: 3-3/4"	DBZ	743.40		8.00
	CTC: 18"	US28	534.55		5.45
	Fasteners: Type 7 & (2) Type 5	US32	681.10		12.90
	Handing Required	US32D	610.40		13.40
	Additional bars by quotation				
*Add per linear inch or fraction thereof					
Fully concealed fastening method					
	170D				
	Push/Pull Set	US3	997.40	1	32.10
	Material: Brass, bronze, aluminum, stainless steel	US4	997.40		32.10
	Bar Stock: 3/8" x 1-1/4"	US10	997.40		32.10
	Base: 1-1/4" Square	US10B	1246.75		32.10
	Projection: Push Bar 3/4"	DBZ	997.40		32.10
	Projection: Pull Bar 2-1/2"	US28	530.95		21.50
	Fasteners: 1/4" 20 thru bolts Type 4	US32	969.75		51.50
	*Add per linear inch or fraction thereof	US32D	884.40		53.60

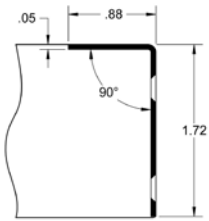

Description	Finish	2018 List	Case Qty.
180H			
Door Edgings - Mortise Type	≤42"	US28 40.10	10
Material: Aluminum, stainless steel		US32D 56.80	
Thickness: .045 - .050"	>42" - 96"	US28 80.20	10
Fasteners: #6 x 5/8" FPHSMS (Self drilling) #6 x 1" screws available on request.		US32D 113.60	
Standard edge guards made for 1-3/4" +0/-1/32" door thickness. Please provide actual door thickness. Cutouts will hand product, specify handling. Other lengths by quotation.			
Hinge Cutout (Add to list price) Per Cutout	US28	27.40	
	US32D	27.40	
Bolt Cutout (Add to list price) Per Cutout	US28	27.40	
	US32D	27.40	
Latch Cutout (Add to list price) Per Cutout	US28	27.40	
	US32D	27.40	
UL Rated (Add to list price) Per Cutout	US32D	16.55	

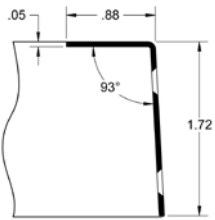

180K			
Door Edgings - Mortise Type	≤42"	US28 41.20	10
Material: Aluminum, stainless steel		US32D 64.25	
Thickness: .045 - .050"	>42" - 96"	US28 82.40	10
Fasteners: #6 x 5/8" FPHSMS (Self drilling) #6 x 1" screws available on request.		US32D 128.50	
Standard edge guards made for 1-3/4" +0/-1/32" door thickness. Please provide actual door thickness. Cutouts will hand product, specify handling. Other lengths by quotation.			
Hinge Cutout (Add to list price) Per Cutout	US28	27.40	
	US32D	27.40	
Bolt Cutout (Add to list price) Per Cutout	US28	27.40	
	US32D	27.40	
Latch Cutout (Add to list price) Per Cutout	US28	27.40	
	US32D	27.40	
UL Rated (Add to list price) Per Cutout	US32D	16.55	

1. Items with the price in **bold and red** are Quick Ship items and ship in 24 hours. Please use stock number when ordering. 2. U/M is each unless otherwise noted.



Trim & Auxiliary

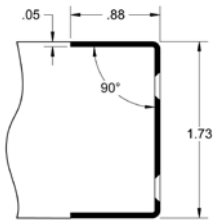

Description	Finish	2018 List	Case Qty.
180M			
Door Edgings - Mortise Type	≤42"	US28 64.25	10
Material: Aluminum, stainless steel		US32D 84.60	
Thickness: .045 - .050"	>42" - 96"	US28 128.50	10
Fasteners: #6 x 5/8" FPHSMS (Self drilling) #6 x 1" screws available on request.		US32D 169.20	
Standard edge guards made for 1-3/4" +0/-1/32" door thickness. Please provide actual door thickness.			
Cutouts will hand product, specify handling. Other lengths by quotation.			
Hinge Cutout (Add to list price) Per Cutout	US28	27.40	
	US32D	27.40	
Bolt Cutout (Add to list price) Per Cutout	US28	27.40	
	US32D	27.40	
Latch Cutout (Add to list price) Per Cutout	US28	27.40	
	US32D	27.40	
UL Rated (Add to list price) Per Cutout	US32D	16.55	

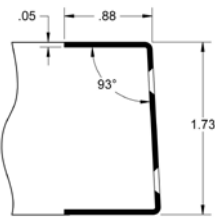

180P			
Door Edgings - Mortise Type	≤42"	US28 68.60	10
Material: Aluminum, stainless steel		US32D 89.45	
Thickness: .045 - .050"	>42" - 96"	US28 137.20	
Fasteners: #6 x 5/8" FPHSMS (Self drilling) #6 x 1" screws available on request.		US32D 178.90	
Standard edge guards made for 1-3/4" +0/-1/32" door thickness. Please provide actual door thickness.			
Cutouts will hand product, specify handling. Other lengths by quotation.			
Hinge Cutout (Add to list price) Per Cutout	US28	27.40	
	US32D	27.40	
Bolt Cutout (Add to list price) Per Cutout	US28	27.40	
	US32D	27.40	
Latch Cutout (Add to list price) Per Cutout	US28	27.40	
	US32D	27.40	
UL Rated (Add to list price) Per Cutout	US32D	16.55	



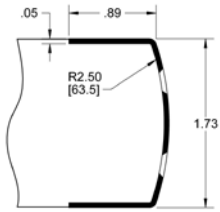

Description	Finish	2018 List	Case Qty.
180Q			
Door Edgings - Mortise Type	≤42"	US28 86.95	5
Material: Aluminum, stainless steel		US32D 110.05	
Thickness: .045 - .050"	>42" - 96"	US28 172.90	
Fasteners: #6 x 5/8" FPHSMS (Self drilling) #6 x 1" screws available on request.		US32D 220.10	
Standard edge guards made for 1-3/4" +0/-1/32" door thickness. Please provide actual door thickness. Cutouts will hand product, specify handling. Other lengths by quotation.			
Hinge Cutout (Add to list price) Per Cutout	US28	27.40	
	US32D	27.40	
Bolt Cutout (Add to list price) Per Cutout	US28	27.40	
	US32D	27.40	
Latch Cutout (Add to list price) Per Cutout	US28	27.40	
	US32D	27.40	
UL Rated (Add to list price) Per Cutout	US32D	16.55	

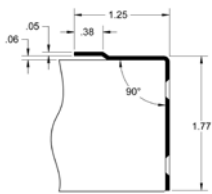

181H			
Door Edgings - Overlap Type	≤42"	US28 64.25	5
Material: Aluminum, stainless steel		US32D 89.70	
Thickness: .045 - .050"	>42" - 96"	US28 128.50	
Fasteners: #6 x 5/8" FPHSMS (Self drilling) #6 x 1" screws available on request.		US32D 179.40	
Standard edge guards made for 1-3/4" +0/-1/32" door thickness. Please provide actual door thickness. Cutouts will hand product, specify handling. Other lengths by quotation.			
Hinge Cutout (Add to list price) Per Cutout	US28	27.40	
	US32D	27.40	
Bolt Cutout (Add to list price) Per Cutout	US28	27.40	
	US32D	27.40	
Latch Cutout (Add to list price) Per Cutout	US28	27.40	
	US32D	27.40	
UL Rated (Add to list price) Per Cutout	US32D	16.55	

1. Items with the price in **bold and red** are Quick Ship items and ship in 24 hours. Please use stock number when ordering. 2. U/M is each unless otherwise noted.



Trim & Auxiliary



Description	Finish	2018 List	Case Qty.
181K			
Door Edgings - Overlap Type	≤42"	US28 60.05	5
Material: Aluminum, stainless steel	US32D	84.00	
Thickness: .045 - .050"	>42" - 96"	US28 120.10	5
Fasteners: #6 x 5/8" FPHSMS (Self drilling) #6 x 1" screws available on request.	US32D	168.00	
Standard edge guards made for 1-3/4" +0/-1/32" door thickness. Please provide actual door thickness.			
Cutouts will hand product, specify handling. Other lengths by quotation.			
Hinge Cutout (Add to list price) Per Cutout	US28	27.40	
	US32D	27.40	
Bolt Cutout (Add to list price) Per Cutout	US28	27.40	
	US32D	27.40	
Latch Cutout (Add to list price) Per Cutout	US28	27.40	
	US32D	27.40	
UL Rated (Add to list price) Per Cutout	US32D	16.55	

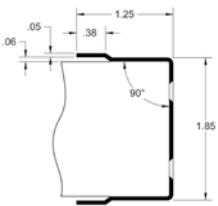

181M			
Door Edgings - Overlap Type	≤42"	US28 81.20	5
Material: Aluminum, stainless steel	US32D	102.85	
Thickness: .045 - .050"	>42" - 96"	US28 162.40	5
Fasteners: #6 x 5/8" FPHSMS (Self drilling) #6 x 1" screws available on request.	US32D	205.70	
Standard edge guards made for 1-3/4" +0/-1/32" door thickness. Please provide actual door thickness.			
Cutouts will hand product, specify handling. Other lengths by quotation.			
Hinge Cutout (Add to list price) Per Cutout	US28	27.40	
	US32D	27.40	
Bolt Cutout (Add to list price) Per Cutout	US28	27.40	
	US32D	27.40	
Latch Cutout (Add to list price) Per Cutout	US28	27.40	
	US32D	27.40	
UL Rated (Add to list price) Per Cutout	US32D	16.55	



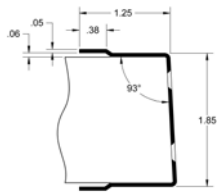

Description	Finish	2018 List	Case Qty.
181P			
Door Edgings - Overlap Type	≤42"	US28 85.30	10
U/M - each		US32D 106.60	
Material: Aluminum, stainless steel	>42" - 96"	US28 170.60	10
Thickness: .045 - .050"		US32D 213.20	
Fasteners: #6 x 5/8" FPHSMS (Self drilling) #6 x 1" screws available on request.			
Standard edge guards made for 1-3/4" +0/-1/32" door thickness. Please provide actual door thickness.			
Cutouts will hand product, specify handling. Other lengths by quotation.			
Hinge Cutout (Add to list price) Per Cutout	US28	27.40	
	US32D	27.40	
Bolt Cutout (Add to list price) Per Cutout	US28	27.40	
	US32D	27.40	
Latch Cutout (Add to list price) Per Cutout	US28	27.40	
	US32D	27.40	
UL Rated (Add to list price) Per Cutout	US32D	16.55	

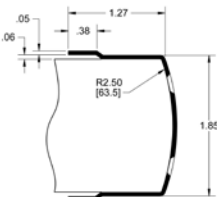

181Q			
Door Edgings - Overlap Type	≤42"	US28 90.95	5
Material: Aluminum, stainless steel		US32D 102.70	
Thickness: .045 - .050"	>42" - 96"	US28 181.90	5
		US32D 205.40	
Fasteners: #6 x 5/8" FPHSMS (Self drilling) #6 x 1" screws available on request.			
Standard edge guards made for 1-3/4" +0/-1/32" door thickness. Please provide actual door thickness.			
Cutouts will hand product, specify handling. Other lengths by quotation.			
Hinge Cutout (Add to list price) Per Cutout	US28	27.40	
	US32D	27.40	
Bolt Cutout (Add to list price) Per Cutout	US28	27.40	
	US32D	27.40	
Latch Cutout (Add to list price) Per Cutout	US28	27.40	
	US32D	27.40	
UL Rated (Add to list price) Per Cutout	US32D	16.55	

1. Items with the price in **bold and red** are Quick Ship items and ship in 24 hours. Please use stock number when ordering. 2. U/M is each unless otherwise noted.



Trim & Auxiliary

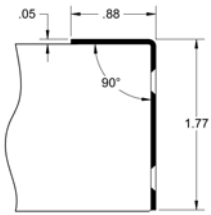

Description	Finish	2018 List	Case Qty.
182H			
Door Edgings - Surface	≤42"	US28 38.60	10
Non-Mortise Type		US32D 60.05	
Material: Aluminum, stainless steel	>42" - 96"	US28 77.20	10
Thickness: .045 - .050"		US32D 120.10	
Fasteners: #6 x 5/8" FPHSMS (Self drilling) #6 x 1" screws available on request.			
Standard edge guards made for 1-3/4" +0/-1/32" door thickness. Please provide actual door thickness.			
Cutouts will hand product, specify handling. Other lengths by quotation.			
Hinge Cutout (Add to list price) Per Cutout	US28	27.40	
	US32D	27.40	
Bolt Cutout (Add to list price) Per Cutout	US28	27.40	
	US32D	27.40	
Latch Cutout (Add to list price) Per Cutout	US28	27.40	
	US32D	27.40	
UL Rated (Add to list price) Per Cutout	US32D	16.55	

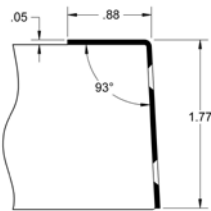

182K			
Door Edgings - Surface	≤42"	US28 41.20	10
Non-Mortise Type		US32D 49.05	
Material: Aluminum, stainless steel	>42" - 96"	US28 82.40	10
Thickness: .045 - .050"		US32D 98.10	
Fasteners: #6 x 5/8" FPHSMS (Self drilling) #6 x 1" screws available on request.			
Standard edge guards made for 1-3/4" +0/-1/32" door thickness. Please provide actual door thickness.			
Cutouts will hand product, specify handling. Other lengths by quotation.			
Hinge Cutout (Add to list price) Per Cutout	US28	27.40	
	US32D	27.40	
Bolt Cutout (Add to list price) Per Cutout	US28	27.40	
	US32D	27.40	
Latch Cutout (Add to list price) Per Cutout	US28	27.40	
	US32D	27.40	
UL Rated (Add to list price) Per Cutout	US32D	16.55	

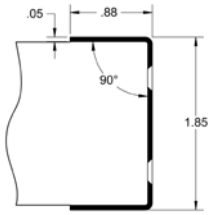

Description	Finish	2018 List	Case Qty.
182M			
Door Edgings - Surface	≤42"	US28 64.65	10
Non-Mortise Type		US32D 84.60	
Material: Aluminum, stainless steel	>42" - 96"	US28 129.30	10
Thickness: .045 - .050"		US32D 169.20	
Fasteners: #6 x 5/8" FPHSMS (Self drilling) #6 x 1" screws available on request.			
Standard edge guards made for 1-3/4" +0/-1/32" door thickness. Please provide actual door thickness.			
Cutouts will hand product, specify handling. Other lengths by quotation.			
Hinge Cutout (Add to list price) Per Cutout	US28	27.40	
	US32D	27.40	
Bolt Cutout (Add to list price) Per Cutout	US28	27.40	
	US32D	27.40	
Latch Cutout (Add to list price) Per Cutout	US28	27.40	
	US32D	27.40	
UL Rated (Add to list price) Per Cutout	US32D	16.55	

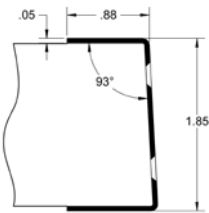

182P			
Door Edgings - Surface	≤42"	US28 68.60	10
Non-Mortise Type		US32D 89.45	
Material: Aluminum, stainless steel	>42" - 96"	US28 137.20	10
Thickness: .045 - .050"		US32D 178.90	
Fasteners: #6 x 5/8" FPHSMS (Self drilling) #6 x 1" screws available on request.			
Standard edge guards made for 1-3/4" +0/-1/32" door thickness. Please provide actual door thickness.			
Cutouts will hand product, specify handling. Other lengths by quotation.			
Hinge Cutout (Add to list price) Per Cutout	US28	27.40	
	US32D	27.40	
Bolt Cutout (Add to list price) Per Cutout	US28	27.40	
	US32D	27.40	
Latch Cutout (Add to list price) Per Cutout	US28	27.40	
	US32D	27.40	
UL Rated (Add to list price) Per Cutout	US32D	16.55	

1. Items with the price in **bold and red** are Quick Ship items and ship in 24 hours. Please use stock number when ordering. 2. U/M is each unless otherwise noted.



Trim & Auxiliary

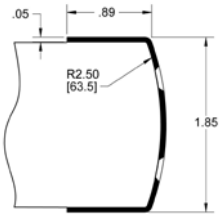

Description	Finish	2018 List	Case Qty.
182Q			
Door Edgings - Surface	US28	87.25	10
Non-Mortise Type	US32D	110.05	
Material: Aluminum, stainless steel	US28	174.50	10
Thickness: .045 - .050"	US32D	220.10	
Fasteners: #6 x 5/8" FPHSMS (Self drilling) #6 x 1" screws available on request.			
Standard edge guards made for 1-3/4" +0/-1/32" door thickness. Please provide actual door thickness.			
Cutouts will hand product, specify handling. Other lengths by quotation.			
Hinge Cutout (Add to list price) Per Cutout	US28	27.40	
	US32D	27.40	
Bolt Cutout (Add to list price) Per Cutout	US28	27.40	
	US32D	27.40	
Latch Cutout (Add to list price) Per Cutout	US28	27.40	
	US32D	27.40	
UL Rated (Add to list price) Per Cutout	US32D	16.55	



Description	Finish	2018 List	Stock No.	Box Qty.	Case Qty.
185G					
Corner Guard	US28	89.30	-	-	-
Material: Aluminum, stainless steel	w/tape				
Size: 3" x 3" x 40"	US32D w/tape	109.15	062999		
Thickness: .050"	US28	59.15	044109		
Fasteners: #6 x 5/8" FPHSMS self drilling	US32D	79.80	087970		
#6 x 1" screws available upon request.					
Other lengths by quotation.					
230W					
Convex Wall Stop	US3	9.00	053679	10	100
Concealed Mounting	US4	11.55	053680		
Material: Cast brass or bronze	US10	11.60	053681		
Stop: Rubber	US10B	11.60	053683		
Diameter: 2-15/32"	US15	16.15	094602		
Projection: 1-3/32"	US15A	16.15	054038		
Fastener: #10 x 1-1/2" PPHWS with plastic and toggle anchor	US19	16.15	073621		
Add optional 230T machine screw with metal toggle nut screwpack - 0.70 each list.	US26	14.45	053682		
	US26D	7.55	053684		
232W					
Convex Wall Stop	US3	3.90	051972	10	100
Concealed Mounting	US4	3.90	053231		
Material: Wrought brass, bronze or stainless steel	US5	9.95	072846		
Stop: Rubber	US9	9.85	017030		
Diameter: 2-7/16"	US10	3.90	051973		
Projection: 1"	US10B	3.90	051974		
Fastener: #10 x 1-1/2" PPHWS with plastic and toggle anchor	US15	10.00	046072		
Add optional 230T machine screw with metal toggle nut screwpack - 0.70 each list.	US15A	10.00	062556		
	US19	10.00	071703		
	US26	4.05	051975		
	US26D	3.80	051976		
	US32	10.00	053691		
	US32D	2.75	053678		
234W					
Concave Wall Stop	US3	9.00	053227	10	100
Material: Cast brass or bronze	US4	11.55	053228		
Stop: Rubber	US10	11.60	053229		
Diameter: 2-15/32"	US10B	11.60	053230		
Projection: 1-3/32"	US15	16.15	094603		
Fastener: #10 x 1-1/2" PPHWS with plastic and toggle anchor	US15A	16.15	054039		
Add optional 230T machine screw with metal toggle nut screwpack - 0.70 each list.	US19	16.15	067951		
	US26	14.45	053235		
	US26D	7.55	053236		

1. Items with the price in **bold and red** are Quick Ship items and ship in 24 hours.
 Please use stock number when ordering. 2. U/M is each unless otherwise noted.



Trim & Auxiliary



Description	Finish	2018 List	Stock No.	Box Qty.	Case Qty.
236W					
Concave Wall Stop	US3	3.90	051977	10	100
Material: Wrought brass, bronze or stainless steel	US4	3.90	053237		
Stop: Rubber	US5	9.95	072849		
Diameter: 2-7/16"	US9	9.85	018702		
Projection: 1"	US10	3.90	051978		
Fastener: #10 x 1-1/2" PPHWS with plastic and toggle anchor	US10B	3.90	051979		
Add optional 230T machine screw with metal toggle nut screwpack - 0.70 each list.	US15	9.95	014846		
	US15A	9.95	054522		
	US19	9.95	018437		
	US26	4.05	051980		
	US26D	3.80	051981		
	US32	9.85	053238		
	US32D	2.75	053239		



241F					
Dome Stop - Low	US3	6.75	051982	10	100
Material: Die cast brass	US4	6.65	053259		
Base Diameter: 1-11/16"	US5	10.85	072845		
Base: 1/8" Thick	US9	10.85	056749		
Height: 1"	US10	7.60	051983		
Fastener: #14 x 1-1/2" with plastic anchor and 1/4-20 x 3/4" FPHMS with lead anchor	US10B	6.70	051984		
	US15	8.30	034785		
	US15A	10.85	054041		
	US19	10.85	073625		
	US26	6.65	051985		
	US26D	6.25	052148		



242F					
Dome Stop - Universal	US3	10.45	075489	10	100
Material: Forged brass	US4	10.45	099613		
Base Diameter: 1-11/16"	US10B	11.00	075488		
Base: 7/32" Thick	US15	12.20	094363		
Height: 1-5/8"	US26	10.75	081314		
Fastener: #14 x 1-1/2" FPHWS with plastic anchor and 1/4 - 20 x 3/4" FPHMS with lead anchor	US26D	9.20	075487		



243F					
Dome Stop - High	US3	7.60	051986	10	100
Material: Die cast brass	US4	7.60	053268		
Base Diameter: 1-11/16"	US5	12.40	077629		
Base: 7/16" Thick	US9	12.40	056750		
Height: 1-9/32"	US10	8.60	052149		
Fastener: #14 x 1-1/2" FPHWS with plastic anchor and 1/4 - 20 x 1-1/4" FPHMS with lead anchor	US10B	7.75	052328		
	US15	9.15	035110		
	US15A	12.40	054043		
	US19	12.40	068921		
	US26	7.75	052329		
	US26D	6.45	052150		





Description	Finish	2018 List	Stock No.	Box Qty.	Case Qty.
244F	US10B	21.75	097345		
Cast Floor Stop	US26	22.45	097346	5	50
Material: Cast brass	US26D	13.90	097347		
Base: 1-3/4" x 4"					
Base Thickness: 5/32"					
O/A Height: 1"					
Fasteners: #14 x 1-1/2" FPHWS with plastic anchor; 1/4 - 20 x 3/4" FPHMS with lead anchor					



245F	US3	31.70	097348	5	50
Cast Floor Stop	US4	31.70	036320		
Material: Cast brass	US10	29.90	097349		
Base: 1-3/4" x 2"	US10B	31.05	097350		
Base Thickness: 1/2"	US26	31.05	097351		
O/A Height: 1-5/16"	US26D	20.75	097352		
Fasteners: #14 x 1-1/2" FPHWS with plastic anchor; 1/4 - 20 x 1-1/4" FPHMS with lead anchor					



246B	Mil	6.05	052934	10	100
Dome Stop Riser Plate	US3	3.45	054344		
Material: Brass	US4	3.45	066234		
Diameter: 1-3/4"	US10	3.70	059349		
Base: 3/8" thick	US10B	3.70	054443		
For use with 241F	US15	8.00	061758		
	US15A	8.00	054044		
	US19	8.00	054523		
	US26	3.45	066412		
	US26D	2.95	055308		



248G	US26D	19.90	159656	10	100
Modern Style Universal Stop					
Material: Brass w/ gray rubber bumper					
Diameter: 1-7/16"					
Height: 1-1/2"					
Fasteners: 1/4 - 20 x 1" FPHMS with lead anchor; #12 x 1-1/4" FPHWS with plastic anchor					



248F	US26	19.90	193603	10	100
Modern Style Universal Stop	US26D	19.90	023442	10	100
Material: Brass w/ black rubber bumper					
Diameter: 1-7/16"					
Height: 1-1/2"					
Fasteners: 1/4 - 20 x 1" FPHMS with lead anchor; #12 x 1-1/4" FPHWS with plastic anchor					









249F	US2C	8.55	011616	5	50
L-Shaped Floor Stop					
Material: Steel with rubber bumper					
Height: 2-5/8"					
Base: 1" x 2-1/2" x 7/32" thick					
Fastener: #14 x 1-1/2" FPHWS with plastic anchor					

1. Items with the price in **bold and red** are Quick Ship items and ship in 24 hours.
Please use stock number when ordering. 2. U/M is each unless otherwise noted.



Trim & Auxiliary

	Description	Finish	2018 List	Stock No.	Box Qty.	Case Qty.
	250W					
	Convex Wall Stop	US3	9.15	052784	20	200
	Material: Cast brass with rubber bumper	US4	9.15	056083		
	Diameter: 1"	US10	9.75	052785		
	Projection: 9/16"	US10B	9.75	052786		
	Fastener: #6 x 3/4" screw w/ anchor and .052" diameter nail	US15	12.50	061694		
		US15A	12.50	054045		
		US19	12.50	054526		
		US26	9.75	052787		
	US26D	9.75	053275			
	251W					
	Concave Wall Bumper	Grey	2.30	052935	20	200
	Material: Adhesive backed rubber					
	Diameter: 1-7/8"					
	Projection: 25/32"					
	252F					
	Floor Stop	US3	24.30	058522	5	50
	Material: Cast brass with rubber bumper	US10	26.25	058523		
	Diameter: 1-9/16" x 2-1/2"	US10B	24.20	058517		
	Height: 2-11/16"	US15	42.30	061610		
	Fastener: 1 ea. 1/4 - 20 x 3/4" FPHMS with lead anchor;	US15A	42.30	054046		
	5/16 - 18 x 2-1/2" stud with lead anchor;	US19	42.30	054531		
	#14 x 1-1/2 FPHWS with plastic anchor	US26	30.35	058518		
	2" max door to floor clearance	US26D	21.75	058519		
	254S					
	Wall Stop and Holder	US3	47.65	097810	5	50
	Material: Cast brass with rubber bumper	US4	47.65	030895		
	Base Diameter: 2-11/32"	US10B	55.70	097813		
	Base Projection: 3-1/2"	US15	55.70	061598		
	Engaged Projection: 5-19/32"	US26D	55.70	097814		
	Keeper: 1" x 2"					
	Fastener: #10 x 1" FPHWS with plastic anchor					
	254W					
	Wall Stop and Holder	US3	47.65	097805	5	50
	Material: Cast brass with rubber bumper	US4	47.65	071803		
	Base Diameter: 2-11/32"	US10	55.70	097806		
	Base Projection: 3-1/2"	US10B	55.70	097807		
	Engaged Projection: 5-19/32"	US26	55.70	097808		
	Keeper: 1" x 2"	US26D	55.70	097809		
	Fastener: #10 x 1" FPHWS with plastic anchor;					
	5/16 - 18 x 2-1/2" stud with lead anchor					
	255S					
	Wall Stop	US3	29.00	017532	5	50
	Material: Cast brass with rubber bumper	US4	29.00	017533		
	Base Diameter: 2-11/32"	US10	29.35	094583		
	Projection: 3-11/16"	US10B	29.35	017534		
	Fastener: #10 x 1" OPHWS with plastic anchor	US15	36.35	061568		
		US26	32.45	017531		
		US26D	21.20	000917		





Description	Finish	2018 List	Stock No.	Box Qty.	Case Qty.
255W					
Wall Stop	US3	29.00	058532	5	50
Material: Cast brass with rubber bumper	US4	29.00	075493		
Base Diameter: 2-11/32"	US10	29.35	058533		
Projection: 3-11/16"	US10B	29.35	058534		
Fastener: #10 x 1" OPHWS with plastic anchor;	US15	36.35	061567		
5/16" - 18 x 2-1/2" threaded stud, 5/16" lead anchor	US26	32.45	058675		
	US26D	21.20	058535		



256S					
Wall Stop & Holder	US3	52.20	068146	5	50
Material: Cast brass with rubber bumper	US10	41.60	070578		
Base Diameter: 2-1/4"	US10B	43.60	099449		
Engaged Projection: 5-11/16"	US26D	28.50	067225		
Projection: 3-25/32"					
Keeper: 25/32" x 1-1/2"					
Fastener: #10 x 1" OPHWS with plastic anchor					



256W					
Wall Stop & Holder	US3	52.20	058585	5	50
Material: Cast brass with rubber bumper	US10	41.60	058586		
Base Diameter: 2-1/4"	US10B	43.60	058587		
Engaged Projection: 5-11/16"	US15	51.20	060860		
Projection: 3-25/32"	US26	52.20	058520		
Keeper: 25/32" x 1-1/2"	US26D	28.50	058521		
Fastener: #10 x 1" OPHWS with plastic anchor;					
5/16" - 18 x 2-1/2" stud with lead anchor					



257F					
Floor Stop	US3	22.10	058546	5	50
Material: Cast brass with rubber bumper	US10	25.65	058547		
Base: 1-9/16" x 2-15/32"	US10B	22.70	058548		
Height: 2"	US15	42.30	060857		
Fastener: #14 x 1-1/2" FPHWS with plastic anchor;	US15A	42.30	054048		
1/4 - 20 x 3/4" FPHMS with lead anchor;	US19	42.30	054532		
5/16" - 18 x 2-1/2" stud with lead anchor	US26	28.75	058549		
	US26D	20.10	058550		



258F					
Floor Stop & Holder	US3	40.10	058551	5	50
Material: Cast brass with rubber bumper	US10	36.50	058552		
Base: 1-9/16" x 2-15/32"	US10B	36.50	058553		
Height: 3"	US15	63.30	060855		
Keeper: 1" x 2"	US26	41.35	058554		
Fasteners: #10 x 1" FPHWS with plastic anchor;	US26D	29.20	058555		
1/4 - 20 x 3/4" FPHMS with lead anchor;					
5/16 - 18 x 2-1/2" stud with lead anchor					



259F					
Tri Base Floor Stop	US10B	25.50	086567	5	50
Material: Cast brass with rubber bumper	US26D	21.45	084984		
Base: 2-1/2" wide x 1-9/16" deep					
Height: 1-11/16"					
Fasteners: #10 x 1-1/4" FPHWS with plastic anchor;					
10 - 32 x 3/4" FPHMS with lead anchor					

1. Items with the price in **bold and red** are Quick Ship items and ship in 24 hours.
Please use stock number when ordering. 2. U/M is each unless otherwise noted.



Trim & Auxiliary

	Description	Finish	2018 List	Stock No.	Box Qty.	Case Qty.
	259H Tri Base Floor Stop - Tall Material: Cast brass with rubber bumper Base: 2-1/2" wide x 1-9/16" deep Height: 2-1/4" Fasteners: #10 x 1-1/4" FPHWS with plastic anchor; 10 - 32 x 3/4" FPHMS with lead anchor	US10B	29.00	006004	5	50
		US26D	24.10	005661		
	260W Angled Wall Stop Material: Cast brass with rubber bumper Base: 2-3/16" wide x 2-15/16" tall Projection: 3-21/32" Fasteners: #14 x 1-1/2" FPHWS with plastic anchor and 1/4 - 20 x 3/4" FPHMS with lead anchor	US26D	42.40	059730	5	50
	267F Floor Stop Material: Cast brass with rubber bumper Base: 2-1/4" Height: 3-1/8" Fasteners: #10 x 1" OPHWS with plastic anchor; 5/16" - 18 x 2-1/2" stud with lead anchor	US3	28.00	058536	5	50
		US10	29.00	058537		
		US10B	29.00	058538		
		US15	36.35	060853		
		US15A	36.35	031421		
		US19	36.35	033541		
		US26	32.45	058539		
	US26D	21.75	058540			
	267S Cast Floor Stop Material: Cast brass with rubber bumper Base: 2-1/4" Height: 3-1/8" Fasteners: #10 x 1" OPHWS with plastic anchor	US3	23.10	097803	5	50
		US10	28.00	097804		
		US10B	29.20	097800		
		US15	36.35	060851		
		US26	32.45	097801		
		US26D	21.75	097802		
	268F Floor Stop & Holder Material: Cast brass with rubber bumper Base: 2-1/4" Height: 3-19/32" Keeper: 25/32" x 1-1/2" Fasteners: #10 x 1" OPHWS with plastic anchor; 5/16" - 18 x 2-1/2" stud with lead anchor	US3	52.95	058541	5	50
		US10	47.65	058542		
		US10B	49.80	058543		
		US15	47.65	075320		
		US15A	47.65	054050		
		US19	47.65	054533		
		US26	52.95	058544		
	US26D	29.70	058545			
	268S Cast Floor Stop & Holder Material: Cast brass with rubber bumper Base: 2-1/4" Height: 3-19/32" Keeper: 25/32" x 1-1/2" Fasteners: #10 x 1" OPHW with plastic anchors	US3	52.95	070926	5	50
		US10	47.65	088879		
		US10B	49.80	072110		
		US15	47.65	060840		
		US26	52.95	095114		
		US26D	29.70	068934		





Description	Finish	2018 List	Stock No.	Box Qty.	Case Qty.
269F Heavy Duty Floor Stop Material: 5/8" Steel pin with rubber bumper Bumper: 1-1/2" high Diameter: 2" Steel Bolt: 5/8" - 11 x 2-1/2" thread Special Grout by others	-	22.55	085062	5	50



269T Heavy Duty Floor Stop - Tall Material: 5/8" Steel pin with rubber bumper Bumper: 3-1/2" high Diameter: 2" Steel Bolt: 5/8" - 11 x 2-1/2" thread Special Grout by others	-	28.95	083131	3	30
---	---	--------------	--------	---	----



270C Kick Down Door Holder Material: Cast iron with rubber tip Base: 1-7/16" x 2-1/8" Arm: 3-13/16" Fasteners: #6 x 3/4" OPHTS S1 - Sprayed Alum., S2 - Sprayed Brass, S3 - Sprayed Bronze 270CR replacement rubber tips available, 6 per bag	S1 S2 S3	13.55 13.55 13.55	058588 058589 058590	5	50
--	----------------	--------------------------------	----------------------------	---	----



270D Kick Down Door Holder Material: Cast brass with rubber tip Base: 1-19/32" x 1-25/32" Arm: 3-1/2" Fasteners: #6 x 3/4" OPHWS	US3 US10 US10B US15 US15A US19 US26 US26D	27.15 30.25 26.70 42.30 42.30 42.30 39.50 24.35	058525 058526 058527 060822 054051 054542 058568 058569	5	50
--	--	---	--	---	----



270R Replacement Rubber Tips Material: Black rubber For use with 270D or 271D door holders Sold in packs of 10	Rubber	27.70	073663	10	100
---	--------	-------	--------	----	-----



271D Kick Down Door Holder Material: Cast brass with rubber bumper Base: 1-19/32" x 1-25/32" Arm: 4-7/16" Fasteners: #6 x 3/4" OPHWS	US3 US10 US10B US26 US26D	47.65 47.65 47.65 47.65 47.65	058570 058571 058564 058565 058566	5	50
--	---------------------------------------	--	--	---	----









271W Roller Bumper Material: Cast brass or bronze with rubber roller Base: 2" Projection: 4-1/2" Fasteners: #10 x 1" FPHWS with plastic anchor	US3 US10 US10B US26 US26D	28.95 31.00 31.60 30.30 23.50	123928 123929 123930 123931 123927	10	50
--	---------------------------------------	--	--	----	----

1. Items with the price in **bold and red** are Quick Ship items and ship in 24 hours.
Please use stock number when ordering. 2. U/M is each unless otherwise noted.



Trim & Auxiliary

	Description	Finish	2018 List	Stock No.	Box Qty.	Case Qty.
	272W					
	Material: Cast brass or bronze with rubber roller	US3	32.10	052779	10	100
	Base: 2"	US10	33.05	052780		
	Projection: 6-1/4"	US10B	33.00	052781		
	Fasteners: #10 x 1" FPHWS with plastic anchor	US26	39.20	052782		
		US26D	29.40	052783		
	273W					
	Curved Roller Bumper	US3	28.40	043325	5	50
	Material: Cast brass or bronze with rubber roller	US4	31.00	043326		
	Projection: 2-21/32"	US10B	31.00	043327		
	Fasteners: #10 x 1" FPHWS with plastic anchor	US26D	25.95	043328		
	274B					
	Door Guard Protective Plate	US3	5.75	048087	-	10
	Material: Brass	US4	5.75	046942		
	Fasteners: Double sided pressure sensitive tape	US10	5.75	048363		
	To be used with the 274D	US10B	5.75	048365		
		US15	5.75	060811		
	US26	5.75	048364			
	US26D	5.75	048366			
	274C					
	Shim for Door Guard	Black	2.05	158025	-	50
	Material: Resilient black rubber, 3/32" thick					
	To be used with the 274D					
	274D					
	Material: Cast brass	US3	27.15	158021	5	50
	Arm Length: 4-1/2"	US4	25.65	158022		
	Fasteners; #6 x 3/4" OPHWS; #6 x 1-1/2" OPHWS;	US10	28.20	158016		
	6 - 32 x 1/2" OPHMS	US10B	27.40	158017		
		US15	28.20	158018		
	US26	26.05	158019			
	US26D	23.10	158020			
	275D					
	Surface Bolt - 8"	US3	28.20	058752	1	12
	Material: Steel	US10	25.95	074243		
	Bolt Size: 1/4" x 3/4"	US10B	28.95	056786		
	Bolt Throw: 1"	US26D	23.10	052287		
	Fasteners: #10 x 1-1/4" FPHWS; 10 - 24 x 1" FPHMS					
	Universal and angle strikes included					
	276D					
	Surface Bolt - 12"	US3	21.00	083603	1	12
	Material: Steel	US10	28.00	025645		
	Bolt Size: 1/4" x 3/4"	US10B	73.60	073888		
	Bolt Throw: 1"	US26D	26.85	053325		
	Fasteners: #10 x 1-1/4" FPHWS; 10 - 24 x 1" FPHMS					
	Universal and angle strikes included					



Description	Finish	2018 List	Stock No.	Box Qty.	Case Qty.
277D					
Privacy Door Guard	US3	37.30	161173	1	60
Material: Cast Zinc	US4	37.30	161174		
Base: 2-5/8" x 1-9/16"	US10B	53.30	161149		
Projection: 2-3/16"	US15	50.65			
Fasteners: #12 x 1-3/4" FPHSMS	US19	53.30			
	US26	36.35	161171		
	US26D	34.30	161172		



277F					
Privacy Door Guard Bracket		11.25	63736	1	
Material: Cold Rolled Steel					
Finish: Primer Gray					
Fasteners: 12-24 FPH Self-tapping					

277R					
Release Tool	N/A	18.10	094396	1	



278D					
Surface Bolt - 6"	US3	20.15	086661	10	100
Material: Brass	US10B	21.90	020392		
Bolt Size: 7/16"	US26D	20.85	086662		
Bolt Throw: 31/32"					
Projection: 3/4"					
Fasteners: #5 x 5/8" FPHWS					
Mortise and universal strikes included					



279D					
Dutch Door Bolt	US10B	45.80	023685	10	100
Material: Brass	US26D	45.80	097354		
O/A Size: 1-11/16" x 4"					
Bolt Size: 5/8" half round					
Bolt Throw: 3/8"					
Projection: 1-1/4"					
Knob Diameter: 29/32"					
Fasteners: #6 x 3/4" FPHWS					
Universal and angle strikes included					



280X					
Dust Proof Strike	US3	19.65	052522	10	100
w/ Removable Plate	US4	18.55	053326		
Material: Brass	US9	26.05	021465		
Face Plate: 1-7/16" x 2-29/32"	US10	20.80	052559		
Barrel Diameter: 1"	US10B	20.20	052523		
Depth: 2-3/16"	US15	24.50	040347		
Plunger Diameter: 3/4"	US15A	26.05	054052		
Fasteners: #8 x 1" FPHWS with plastic anchors;	US19	26.05	067955		
spanner wrench	US26	20.10	052839		
	US26D	17.30	052524		

1. Items with the price in **bold and red** are Quick Ship items and ship in 24 hours.
Please use stock number when ordering. 2. U/M is each unless otherwise noted.



Trim & Auxiliary



Description	Finish	2018 List	Stock No.	Box Qty.	Case Qty.
281D					
Slide Flush Bolt	US3	13.45	056621	10	100
	US4	14.05	056789		
Material: Brass or bronze w/ steel components	US5	19.10	035600		
Face Plate: 3/4" x 6"	US10	14.05	052723		
Bolt Diameter: 1/2"	US10B	14.05	056790		
Bolt Throw: 1"	US15	19.10	036438		
Strike: 7/8" x 1-3/4"	US15A	19.10	054055		
Rod Backset: 7/16"	US19	19.10	054545		
Fasteners: #6 x 3/4" FPHWS	US26	16.25	052525		
	US26D	13.45	056791		



282D					
Manual Flush Bolt	US3	20.35	052281	2	80
Metal Doors	US4	20.55	052282		
Material: Brass w/ steel components	US5	33.55	062354		
Face Plate: 1" x 6-3/4"	US9	33.55	083207		
Bolt Throw: 3/4"	US10	20.75	052283		
Bolt Backset: 3/4"	US10B	20.75	052284		
Rod Length: 12"	US15	24.95	040346		
Strike: 15/16" x 2-1/4"	US15A	37.05	054056		
Fasteners: #8 x 3/4" combination screws	US19	37.05	067956		
#8 x 1-1/2" combination screws	US26	22.45	052285		
For use with A115 Frame Preparation	US26D	18.95	052286		
282S Strike plate bag and 282P bolt head available					
282R Optional rod length available: 18", 24" and 30" (bolt head not included) - \$2.75 net					
3-hour fire rating on metal doors up to 4 feet wide x 10 feet tall					
Priced as each and sold in sets of two					



283D					
Manual Flush Bolt	US3	30.95	052929	2	40
Wood Composite Door	US4	30.95	053328		
Material: Brass w/ steel components	US5	62.20	018995		
Face Plate: 1" x 6-25/32"	US9	62.20	032026		
Bolt Head: 1/2" Square	US10	30.95	052930		
Bolt Throw: 3/4"	US10B	30.00	052931		
Bolt Backset: 3/4"	US15	62.20	060810		
Strike: 15/16" x 2-1/4"	US15A	62.20	054057		
Fasteners: #8 x 3/4" combination screws;	US19	62.20	054567		
1-1/2 hour fire rating on wood doors up to 4 feet wide x 10 feet tall	US26	32.35	052932		
	US26D	30.00	052933		







291D					
Automatic Flush Bolts	US3	185.90	053297	1	10
Wood Door	US4	186.10	074059		
Material: Stainless steel/brass w/ steel components	US10	186.10	053298		
Face Plate: 1" x 8-1/2"	US10B	180.40	053299		
Bolt Heads: 1/2" square	US15	254.60	046049		
Bolt Throw: 3/4"	US32	254.60	117105		
Bolt Backset: 3/4"	US32D	175.05	117104		
Fasteners: #10 x 1" SMS; #8 x 1" combination screws					
Mortise Strike: 15/16" x 2-1/4"					
280X Dust Proof Strike recommended					
1-1/2 hour fire rating on wood doors up to 4 feet wide x 9 feet tall					



10/06/2020

www.hagerco.com

1. Items with the price in **bold and red** are Quick Ship items and ship in 24 hours. Please use stock number when ordering. 2. U/M is each unless otherwise noted.

Description	Finish	2018 List	Stock No.	Box Qty.	Case Qty.	
 291D Automatic Flush Bolts Wood Door Material: Stainless steel/brass w/ steel components Face Plate: 1" x 8-1/2" Bolt Heads: 1/2" square Bolt Throw: 3/4" Bolt Backset: 3/4" Fasteners: #10 x 1" SMS; #8 x 1" combination screws Mortise Strike: 15/16" x 2-1/4" 280X Dust Proof Strike recommended 1-1/2 hour fire rating on wood doors up to 4 feet wide x 9 feet tall	US3	185.90	053297	1	10	
	US4	186.10	074059			
	US10	186.10	053298			
	US10B	180.40	053299			
	US15	254.60	046049			
	US32	254.60	117105			
	US32D	175.05	117104			
	<hr/>					
	 292D Automatic Flush Bolts Metal Doors Material: Stainless steel/brass w/ steel components Face Plate: 1" x 6-3/4" Bolt Head: 1/2" square Bolt Throw: 3/4" Bolt Backset: 3/4" Fasteners: #8 x 1" combination screws Mortise Strike: 15/16" x 2-1/4" 280X Dust Proof Strike recommended 1-1/2 hour fire rating on wood doors up to 4 feet wide x 9 feet tall	US3	172.50	053301	1	10
		US4	172.50	084898		
US10		172.50	053302			
US10B		167.40	053303			
US15		237.40	046052			
US32		237.40	117106			
US32D		162.40	117107			
<hr/>						
 293D Constant Latching Flush Bolts Metal Doors Material: Stainless steel/brass w/ steel components Face Plate: 1" x 6-3/4" Bolt Head: 1/2" square Bolt Throw: 3/4" Bolt Backset: 3/4" Fasteners: #8 x 1" combination screws T-Strike: 1-1/8" x 2-3/4" 280X Dust Proof Strike recommended 1-1/2 hour fire rating on wood doors up to 4 feet wide x 9 feet tall		US3	172.50	058567	1	10
		US4	172.50	087519		
	US10	172.50	058560			
	US10B	167.40	058561			
	US15	237.40	093481			
	US32	237.40	117108			
	US32D	162.40	117109			
	<hr/>					
	 294D Constant Latching Flush Bolts Wood Door Material: Stainless steel/brass w/ steel components Face Plate: 1" x 8-1/2" Bolt Head: 1/2" square Bolt Throw: 3/4" Bolt Backset: 3/4" Fasteners: #10 x 1" SMS; #8 x 1" combination screws T-Strike: 1-1/8" x 2-3/4" 280X Dust Proof Strike recommended 1-1/2 hour fire rating on wood doors up to 4 feet wide x 9 feet tall	US3	185.90	058563	1	10
		US4	185.90	082014		
US10		185.90	058556			
US10B		180.40	058557			
US15		254.60	095081			
US32		254.60	117111			
US32D		175.05	117110			

1. Items with the price in **bold and red** are Quick Ship items and ship in 24 hours.
 Please use stock number when ordering. 2. U/M is each unless otherwise noted.



Trim & Auxiliary



Description	Finish	2018 List	Stock No.	Box Qty.	Case Qty.
295M					
Automatic Flush Bolt w/Fire Bolt	US3	137.15	080579	1	10
Metal Doors	US4	137.15	080582		
Material: Stainless steel/brass with steel components	US10	137.15	080583		
Face Plate: 1" x 6-3/4"	US10B	137.15	080584		
Bolt Head: 1/2" square	US15	189.90	060808		
Bolt Throw: 3/4"	US32	137.15	080585		
Bolt Backset: 3/4"	US32D	137.15	080586		
Fasteners: #8 x 1" combination screws					
T-strike: 15/16" x 2-1/4"					
3-hour fire rating for metal doors up to 4 feet wide x 9 feet tall					
295W					
Automatic Flush Bolt w/Fire Bolt	US3	147.70	080593	1	10
Wood Doors	US4	147.70	080594		
Material: Stainless steel/brass with steel components	US10	147.70	080592		
Face Plate: 1" x 8-1/2"	US10B	147.70	080591		
Bolt Head: Flattened 1/2" square	US15	163.55	060807		
Bolt Throw: 3/4"	US32	147.70	080590		
Backset: 3/4"	US32D	147.70	080589		
Fasteners: #10 x 1" SMS; #8 x 1" combination screws					
Mortise Strike: 15/16" x 2-1/4"					
20 minute fire rating for wood doors up to 4 feet wide x 9 feet tall					
296W					
Automatic Flush Bolt Set for Wood Doors	US3	330.30	083221	1	10
Backset: 1-1/2"	US4	330.30	083222		
Fasteners: Sixteen (16) #8 x 1" APS; four (4) plastic anchors	US10	330.30	083223		
Strike: 1-1/8" x 2-1/4"	US10B	330.30	083224		
1-1/2 hour fire rating for wood doors up to 4 feet wide x 9 feet tall	US15	330.30	060784		
	US32	330.30	083225		
	US32D	330.30	083226		
297C					
Carry Bar	USP	33.55	058524	2	20
Material: Stainless steel/brass	US3	59.70	058528		
Base: 1-3/4" x 2-1/4"	US10	59.70	058529		
Projection: 25/32"	US10B	59.70	058530		
Fasteners: 12 - 24 x 3/4" PPHMS with sex nuts	US15	59.70	060778		
For use on pairs of doors with astragal and 297D-298D coordinator.	US32	59.70	117361		
	US32D	59.70	117226		





Description	Finish	2018 List	Stock No.	Box Qty.	Case Qty.
-------------	--------	-----------	-----------	----------	-----------

297D Coordinator with Filler Bar Material: Steel Base: 1-5/8" x 5/8" Fasteners: 12-24 x 1-1/4" TPHMS; #8 x 1" combo screws If overall frame width is different than widths shown, consult Hager Customer Service. If active and inactive doors are unequal in length, consult Hager Customer Service for proper sizing. 60"	Black	118.95	069727	1	4
---	-------	---------------	--------	---	---

Coordinator with Filler Bar Material: Steel Fasteners: 12-24 x 1-1/4" TPHMS; #8 x 1" combo screws If overall frame width is different than widths shown, consult Hager Customer Service. If active and inactive doors are unequal in length, consult Hager Customer Service for proper sizing. 72"	Black	125.30	052312	1	4
96"	Black	139.45	052313	1	4



297F 297F Filler Bars Material: Steel Thickness: 5/8" standard 18-5/8"	Black FB1	24.80	098884	-	-
42-5/8"	Black FB1	34.50	073866	-	-



297B Mounting Bracket Material: Aluminum Stop Height: .58" (15mm) Soffit Width: 1-3/8" to 2-3/8" Fasteners: 12-24 x thread forming	Black	24.00	50841	-	-
--	-------	--------------	-------	---	---



298D Gravity Coordinator Material: Cast brass w/rubber roller Base: 1-1/8" x 5-1/2" Projection: 7" Fasteners: #12 x 1" OPHWS; #6 x 3/4" FPHWS; #8 x 3/4" FPHWS; #8 x 3/4" TPHWS	US3	79.65	055123	1	10
	US10	79.45	060271		
	US10B	77.10	055124		
	US26D	65.70	055125		

1. Items with the price in **bold and red** are Quick Ship items and ship in 24 hours. Please use stock number when ordering. 2. U/M is each unless otherwise noted.



Trim & Auxiliary



Description	Finish	2018 List	Stock No.	Box Qty.	Case Qty.
300D					
Chain Door Check					
Material: Steel chain					
Base Plate: Cast zinc base, galvanized steel chain, EPDM rubber cover					
1-1/2" x 1-1/2"					
Cover: EDPM Rubber					
Fasteners: #8 x 1" FPHSMS					
Optional grommet nut set available (part #1-320-9801)					
25"-1/2'+/- 1/2"	US26D	58.10	063667	1	10
30" +/- 1/2"	US26D	58.10	063668	1	10



301D					
Residential Hinge Pin Stop	US3	4.60	023366	5	50
Material: Wrought steel with rubber bumpers	US26D	4.60	023363		
Features: Works with both 1/4" and 5/16" hinge pins					
Must purchase an NRP hinge for use with this pin stop					



303W					
Handrail Bracket	US3	77.35	053306	5	50
Material: Cast brass	US4	77.35	067806		
Base Diameter: 3-5/32"	US10	82.65	052151		
Base to Center of Rail: 2-3/4"	US10B	82.65	053307		
Fasteners: #10 x 1-1/4" FPHWS with plastic anchor;	US26	82.65	052327		
10 - 24 x 13/16" FPHMS with lead anchors	US26D	82.65	052152		



305D					
Wire Pull					
Material: 5/16" brass rod					
Projection: 1-9/32"					
Fasteners: 8 - 32 x 1" TPHMS					
CTC: 3"	US3	10.25	086821	10	100
	US4	10.60	-		
	US10	10.60	020779		
	US10B	-	-		
	US26	10.60	086823		
	US26D	10.60	086822		
CTC: 3-1/2"	US3	10.25	086824	10	100
	US4	10.60	007767		
	US10	10.60	089114		
	US10B	-	-		
	US26	10.60	086826		
	US26D	10.60	086825		
CTC: 4"	US3	10.25	086827	10	100
	US4	10.60	019788		
	US10	10.60	090240		
	US10B	-	-		
	US26	10.60	086829		
	US26D	10.60	086828		



307D					
Metal Frame Silencer	Grey	11.05	052527	-	100
Material: Rubber					
Diameter: 1/2"					
Projection: 1/8"					
U/M Bag of 100					



Description	Finish	2018 List	Stock No.	Box Qty.	Case Qty.
308D Wood Frame Silencer Base: 3/8" x 3/4" Projection: 9/64" U/M Bag of 100	Grey	16.60	052526	-	100
310C Conversion Kit Strike: 1-11/16" x 2-1/4" Filler Plate: 1-1/8" x 3-3/8" Fasteners: #10 x 1-1/2" FPHWS; #10 x 1" FPHWS; 8 - 32 x 1/4" FPHMS; 10 - 24 x 1/2" FPHMS Converts Roller Latch to Push Pull Latch	US26D	53.40	711114	5	50
311H Push/Pull Latch Material: Zinc, stainless steel; Door Thickness: 1-3/4"; Bolt Throw: 1/2" Standard Backset: 2-3/4" Standard; 5" Optional; Projection: 2-5/8"; Strike: ASA 1-1/4" x 4-7/8" Standard T-Strike 1-1/8" x 2-3/4" Standard; Horizontal Mounting w/ 5" Backset Options: Engraving Handed: A (Standard) - "PUSH" down; "PULL" down. B - "PUSH" up; "PULL" down. C - "PUSH" up; "PULL" up. D - "PUSH" down; "PULL" up.					
2-3/4"	US26	240.60	161063	1	10
	US26D	195.45	161064		
	US32	296.40	161067		
	US32D	232.35	161068		
5"	US26	240.60	161069	1	10
	US26D	195.45	161070		
	US32	296.40	161071		
	US32D	232.35	161072		
Lead Lined 2-3/4"	US26	286.35		1	10
	US26D	232.55	161066		
	US32	335.95			
	US32D	319.95	161073		
Lead Lined 5"	US26	286.35		1	10
	US26D	232.55	161076		
	US32	335.95			
	US32D	319.95	161080		
313S Anti-Vandal Trim Material: 11 GA stainless steel Max Projection: 1-7/8" Size: 6-11/32" x 11" Door Thickness: 1-3/4" - 2" Fasteners: 1/4 - 20" FPHMS with finish washers Available with latchguard (313L). Cylinder cutout available. Can be used with exit devices and mortise locks.					
Please see the Exit Section for pricing with Hager Model 4500 Rim Devices. All other combinations, including those with alternate Exit and Lock manufacturers, are priced on application.					

1. Items with the price in **bold and red** are Quick Ship items and ship in 24 hours. Please use stock number when ordering. 2. U/M is each unless otherwise noted.



Trim & Auxiliary



Description	Finish	2018 List	Stock No.	Box Qty.	Case Qty.
318D					
Roller Latch	US3	32.35	055119	1	50
Material: Brass	US4	45.70	055120		
Latch Faceplate: 1" x 3-3/8"	US10	45.70	055121		
Strike: 1-1/4" x 2-3/4"	US10B	33.15	055122		
Strike Thickness: .171"	US15	61.65	078198		
Max Roller Projection: 3/8"	US15A	-	-		
Fasteners: #8 x 1" FPHWS; 8 - 32 x 3/4" FPHMS;	US19	61.65	054569		
#10 x 1-1/2" FPHWS	US26	33.90	055127		
	US26D	27.40	055126		



318S					
Roller Latch with Stop	US3	67.55	087304	1	50
Material: Brass	US4	67.65	087305		
Latch Face: 1-7/16" x 4-7/16"	US10	67.65	075533		
Angle Stop: 9/16" x 4-7/16"	US10B	65.70	055304		
Strike: 1-1/4" x 2-1/4"	US26	73.45	087306		
Strike Thickness: .171"	US26D	48.50	055305		
Max Roller Projection: 3/8"					
Fasteners: 8 - 32 x 3/4" FPHMS; #10 x 1-1/2" FPHWS					



320R					
Roller Latch	US3	41.95	049988	1	50
Material: Brass with nylon roller	US4	41.95	049989		
Latch Face: 2-1/4" x 1-1/8"	US9	84.30	049990		
Strike: 1-1/8" x 2-3/4"	US10	41.95	049987		
Strike Thickness: .058 wrought	US10B	44.75	049994		
Max Roller Projection: 7/16"	US15	46.10	060809		
Fasteners: #8 x 1" FPHWS	US26	41.95	049993		
	US26D	27.65	049995		



321R					
Adjustable Ball Catch	US3	17.85	055947	1	50
Material: Brass with steel ball roller	US4	17.85	055953		
Latch Face: 1" x 2-1/8"	US10	21.25	055944		
Strike: 1-1/2" x 2-1/8"	US10B	21.25	055960		
Strike Thickness: .050"	US15	21.25	075224		
Fasteners: #6 FPHWS	US15A	21.25	055961		
	US19	21.25	055945		
	US26D	17.85	055963		



322V					
Door Knocker w/ 115° Viewer	US3	29.45	056479	1	50
Material: Wrought brass	US4	-	-		
Knocker Size: 2-7/32" x 3-1/4"	US10	33.00	056593		
Projection: 19/32"	US26D	29.45	056478		
Fasteners: #6 x 3/4" TPHSMS					

Lettering available - up to four characters, Arial, 1/2" tall, black - \$6.00 total added to net price



323S					
Three-Way Ball Catch	US26D	18.30	158659	30	300
Material: Brass with Stainless Steel Balls					
Body: 1/2" x 2-3/16" x 1/2"					
Strike: 3/8" x 1-3/8" x 5/8"					





Description	Finish	2018 List	Stock No.	Box Qty.	Case Qty.
324W					
Light Duty Wall Bumper	US3	9.00	013810	1	50
Material: Brass or bronze	US4	9.60	013811		
Base: 1-1/4" diameter	US5	10.75	013814		
Projection: 3-1/4"	US10	10.75	013809		
Tip Diameter: 5/8"	US10B	10.75	013812		
Fasteners: #10 x 7/8" wood thread	US15	10.75	040348		
Replacement rubber tip available (Part # 1-269-3073)	US15A	10.75	013813		
	US19	10.75	030873		
	US26	9.30	013808		
	US26D	9.30	013807		



326F					
Automatic Floor Stop and Holder	US3	72.85	058510	5	30
Material: Cast brass	US10	76.85	058511		
Holder Base: 3-1/16" x 3-1/2"	US10B	76.85	058512		
Projection: 1-15/16"	US26	76.85	058507		
Floor Strike: 2" x 4-3/32"	US26D	76.85	058508		
Strike Height: 1-1/4"					
Max Door to Floor Clearance: 1/2" or less					
Fasteners: 4 ea. 12-24 x 1" TPHMS and #12 x 1" TPHWS;					
3 ea. #14 x 1-1/2" FPHWS and anchors;					
1/4 - 20 x 3/4" FPHMS with lead anchor					



326W					
Automatic Wall Stop and Holder	US3	80.90	058513	5	30
Material: Cast brass	US10	84.95	058514		
Holder Base: 2-13/32" x 2-25/32"	US10B	84.95	058515		
Holder Projection: 2-5/16"	US26	84.95	058516		
Engaged Projection: 3-5/8"	US26D	84.95	058509		
Strike Base: 1" x 2-1/16"					
Strike Projection: 2"					
Fasteners: #10 x 1" OPHWS and anchors;					
10 - 24 x 1-1/4" FPHMS					



327F					
Automatic Floor Stop and Holder	US3	72.85	034684	5	30
Material: Cast brass	US10	76.85	085315		
Holder Base: 3-1/16" x 3-1/2"	US10B	76.85	076374		
Projection: 1-15/16"	US26	76.85	037584		
Floor Strike: 2" x 4-3/32"	US26D	76.85	029249		
Strike Height: 1-3/4"					
Max Door to Floor Clearance: 9/16" to 1-1/16"					
Fasteners: 4 ea. x 12-24 x 1" TPHMS and #12 x 1" TPHWS;					
3 ea. #14 x 1-1/2" FPHWS and anchors;					
1/4 - 20 x 3/4" FPHMS with lead anchor					

1. Items with the price in **bold and red** are Quick Ship items and ship in 24 hours.
Please use stock number when ordering. 2. U/M is each unless otherwise noted.



Trim & Auxiliary



Description	Finish	2018 List	Stock No.	Box Qty.	Case Qty.
327W					
Automatic Wall Stop and Holder	US4	122.25	098619	5	20
Material: Cast brass	US10	122.25	098617		
Holder Base: 3-1/16" x 3-1/2"	US10B	122.25	098615		
Holder Projection: 1-15/16"	US26D	115.25	098612		
Engaged Projection: 3-1/2"					
Strike Diameter: 2-3/8"					
Strike Projection: 3-1/16"					
Fasteners: #12 x 1 TPHWS; 12-24 x 1" TPHMS;					
1/4" - 20 x 3/4" FPHMS with lead anchor;					
#14 x 1-1/2" FPHWS					
Strike is adjustable 45° left or right					



328F					
Automatic Floor Stop and Holder	US3	72.85	043083	5	30
Material: Cast brass	US10B	76.85	045516		
Holder Base: 3-1/16" x 3-1/2"	US26	76.85	-		
Projection: 1-15/16"	US26D	76.85	032493		
Floor Strike: 2" x 4-3/32"					
Strike Height: 2-1/4"					
Max Door to Floor Clearance: 1-1/8" to 1-9/16"					
Fasteners: 4 ea. 12-24 x 1" TPHMS and #12 x 1" TPHWS;					
3 ea. #14 x 1-1/2" FPHWS and anchors;					
1/4 - 20 x 3/4" FPHMS with lead anchor					



329F					
Automatic Floor Stop and Holder	US3	72.85	078700	5	30
Material: Cast brass	US10	76.85	040616		
Holder Base: 3-1/16" x 3-1/2"	US10B	76.85	044158		
Projection: 1-15/16"	US26	76.85	116003		
Strike Height: 2-3/4"	US26D	76.85	029252		
Floor Strike: 2" x 4-3/32"					
Max Door to Floor Clearance: 1-5/8" to 2-1/16"					
Fasteners: 4 ea. 12-24 x 1" TPHMS and #12 x 1" TPHWS;					
3 ea. #14 x 1-1/2" FPHWS and anchors;					
1/4 - 20 x 3/4" FPHMS with lead anchor					



330D					
Pocket Door Latch	US3		086840	1	20
Material: Brass	US5		086841		
Fits: 1-3/8" - 1-3/4" door	US10		066707		
Size: 2-3/4" x 2-1/2"	US10B	See Sliding Door Hardware Section for Pricing	056768		
Finger Pull Extends: 1-3/8"	US15		078972		
Fasteners: #6 x 5/8" OPHWS	US15A		054061		
	US19		054570		
	US26		086837		
	US26D		086838		



330L					
Privacy Pocket Door Latch	US3		143162	1	20
Material: Brass	US5		143164		
Size: 2-3/4" x 2-1/2"	US10	See Sliding Door Hardware Section for Pricing	143165		
Finger Pull Extends: 1-3/8"	US10B		143158		
Strike: 1" x 2-1/4"	US15		143159		
1-3/8" doors	US15A		143160		
Fasteners: #6 x 5/8" OPHWS; #6 x 3/4" FPHWS	US19		143166		
	US26		143167		
	US26D		143161		





Description	Finish	2018 List	Stock No.	Box Qty.	Case Qty.
330M					
Privacy Pocket Door Latch	US3		143172	1	20
Material: Brass	US5		143178		
Size: 2-3/4" x 2-1/2"	US10	See Sliding	143168		
Finger Pull Extends: 1-3/8"	US10B	Door	143169		
Strike: 1" x 2-1/4"	US15	Hardware	143173		
1-3/4" doors	US15A	Section for	143174		
Fasteners: #6 x 5/8" OPHWS; #6 x 3/4" FPHWS	US19	Pricing	143175		
	US26		143170		
	US26D		143171		



334V					
Door Knocker w/ 115° Viewer	US3	39.05		1	50
Material: Solid cast brass	US4	38.10			
Knocker Size: 3-9/16" x 6-3/4"	US10	41.45			
Fasteners:	US10B	41.45			
Two (2) 8-32 x 2 FHMS for standard 1-3/4" doors	US26	39.05			
Two (2) #8 finish washers	US26D	38.10			
Two (2) 8-32 x 1-5/8" FHMS for 1-3/8" doors					

Lettering available - up to four characters, Arial, 1/2" tall, black - \$6.00 total added to net price. Not available on US10B finish.



336A					
161 Prep - Door Edge Filler Plate	Primed steel	2.50	023352	25	250
Gauge: .134"					
Size: 1-1/8" x 2-1/4"					



336B					
86 Prep - Door Edge Filler Plate	Primed steel	4.00	023329	25	250
Gauge: .180					
Size: 1-1/4" x 8"					



336C					
Door Face Filler Plate	Primed steel	3.35	023346	25	250
Gauge: .055"					
Size: 1-3/4" Diameter					



336D					
Door Face Filler Plate	Primed steel	3.80	023343	25	250
Gauge: .055					
Size: 2-5/8" Diameter					



336E					
Square - Door Edge Filler Plate	Primed steel	3.20	023334	25	250
Gauge: .134					
Size: 1-3/4" x 4-1/2"					



336F					
Bevel - Door Edge Filler Plate	Primed steel	3.05	023332	25	250
Gauge: .134					
Size: 1-1/2" x 4-1/2"					



336G					
Square - Door Edge Filler Plate	Primed steel	3.35	023340	25	250
Gauge: .134					
Size: 1-3/4" x 5"					

1. Items with the price in **bold and red** are Quick Ship items and ship in 24 hours. Please use stock number when ordering. 2. U/M is each unless otherwise noted.



Trim & Auxiliary

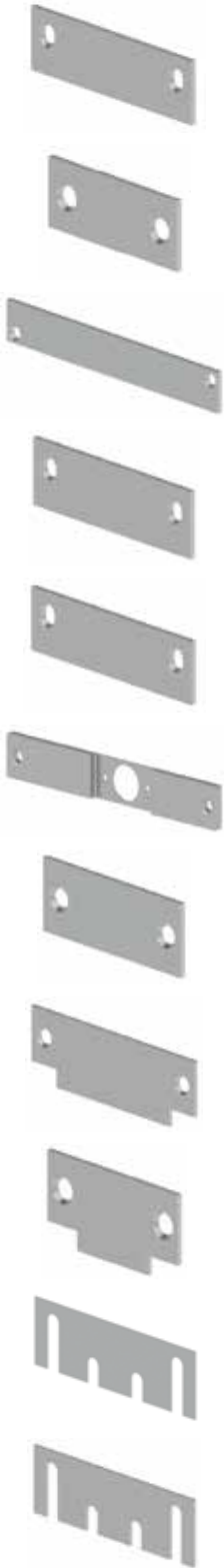

Description	Finish	2018 List	Stock No.	Box Qty.	Case Qty.
336H Bevel - Door Edge Shim Filler Plate Gauge: .134 Size: 1-1/2" x 5"	Primed steel	2.95	023336	25	250
336J Frame - Flush Bolt Strike Filler Plate Gauge: .083 Size: 15/16" x 2-1/4"	Primed steel	2.10	023342	25	250
336K Door - Flush Bolt Filler Plate Gauge: .134 Size: 1" x 6-3/4"	Primed steel	3.55	023341	25	250
336L Frame - Hinge Filler Plate Gauge: .134 Size: 1-5/8" x 4-1/2"	Primed steel	2.95	023330	25	250
336M Frame - Hinge Filler Plate Gauge: .134 Size: 1-5/8" x 5"	Primed steel	3.35	023331	25	250
336N 86 to 161 Edge Prep Latch Adapter Filler Plate Gauge: .238 Size: 1-1/4" x 8"	Primed steel	7.10	023351	25	100
336P Frame - Deadlock Strike Filler Plate Gauge: .083 Size: 1-1/8" x 2-3/4"	Primed steel	2.35	082122	25	250
336Q Frame - ASA Strike Filler Plate Gauge: .093 Size: 1-1/4" x 4-7/8"	Primed steel	2.65	023356	25	250
336R Frame - Cylindrical Lock Strike Filler Plate Gauge: .083 Size: 1-1/8" x 2-3/4"	Primed steel	2.25	023354	25	250
337A Template Hinge Shim Gauge: .028 Size: 1-7/16" x 4-1/2"	Primed steel	1.25	023347	50	500
337B Template Hinge Shim Gauge: .065 Size: 1-7/16" x 4-1/2"	Primed steel	1.60	023348	50	500





Description	Finish	2018 List	Stock No.	Box Qty.	Case Qty.
337C Template Hinge Shim Gauge: .028 Size: 1-7/16" x 5"	Primed steel	1.60	023349	50	500
337D Template Hinge Shim Gauge: .065 Size: 1-7/16" x 5"	Primed steel	1.70	023350	50	500
340D Latch Protector Plate with Frame Pin Material: 12 GA steel, stainless steel Size: 3" x 11" For 1-3/4" door thickness Fasteners: 5/16 - 20 x 1-1/2" carriage bolts with sex nuts For use w/ most mortise locks For use w/ cylindrical locksets with 3-3/4" backset or greater.	US2C US32D	14.00 27.65	041188 002179	1	10
341C Latch Protector Plate w/ Lock Cut Out Without Safety Studs Material: 12 GA steel, stainless steel Size: 3" x 11" For 1-3/4" door thickness Fasteners: 5/16 - 20 x 1-1/2" carriage bolts with sex nuts For use with cylindrical locksets with a 2-3/4" backset.	US32D	45.15	150739	1	10
341D Latch Protector Plate w/ Lock Cut Out with Frame Pin Material: 12 GA steel, stainless steel Size: 3" x 11" For 1-3/4" door thickness Fasteners: 5/16 - 20 x 1-1/2" carriage bolts with sex nuts For use with cylindrical locksets with a 2-3/4" backset.	US2C US32D	14.00 27.65	041191 002180	1	10
342D Latch Protector Plate w/ Escutcheon Cut Out Material: 12 GA steel, stainless steel Size: 3" x 11" For 1-3/4" door thickness Fasteners: 5/16 - 20 x 1-1/2" carriage bolts with sex nuts For use with cylindrical and mortise locksets	US32D	34.90	150740	1	10
345D Latch Protector Plate Material: 12 GA steel, stainless steel Size: 1-5/8" x 10" For 1-3/4" door thickness Fasteners: 5/16-20 x 1-1/2" carriage bolts with sex nuts For use with cylindrical and mortise locksets	US2C US32D	10.80 20.55	041194 002181	1	10

1. Items with the price in **bold and red** are Quick Ship items and ship in 24 hours.
Please use stock number when ordering. 2. U/M is each unless otherwise noted.



Trim & Auxiliary

	Description	Color	2018 List	Stock No.	Box Qty.	Case Qty.
MEN	350M					
	Lettered Plastic Sign - MEN	Brown (W1) w/ white lettering	15.85	089107	-	5
	Material: .125" thick plastic					
	Lettering: 3/4" Helvetica	Black (W2) w/ white lettering	15.85	092413		
	Size: 2" x 5"	Blue (W3) w/ white lettering	15.85	090948		
	Signs are individually packed in a polybag	Silver (B1) w/ black lettering	15.85	089108		
		Gold (B2) w/ black lettering	15.85	030383		
WOMEN	350W					
	Lettered Plastic Sign - WOMEN	Brown (W1) w/ white lettering	17.80	089103	-	5
	Material: .125" thick plastic					
	Lettering: 3/4" Helvetica	Black (W2) w/ white lettering	17.80	092414		
	Size: 2" x 5"	Blue (W3) w/ white lettering	17.80	091068		
	Fasteners: Double sided pressure sensitive tape, or screws (specify)	Silver (B1) w/ black lettering	17.80	089104		
Signs are individually packed in a polybag	Gold (B2) w/ black lettering	17.80	030384			
PUSH	350H					
	Lettered Plastic Sign - PUSH	Brown (W1) w/ white lettering	17.80	089109	-	5
	Material: .125" thick plastic					
	Lettering: 3/4" Helvetica	Black (W2) w/ white lettering	17.80	097215		
	Size: 2" x 4"	Blue (W3) w/ white lettering	17.80	032116		
	Fasteners: Double sided pressure sensitive tape, or screws (specify)	Silver (B1) w/ black lettering	17.80	089110		
Signs are individually packed in a polybag	Gold (B2) w/ black lettering	17.80	066158			
PULL	350L					
	Lettered Plastic Sign - PULL	Brown (W1) w/ white lettering	17.80	089111	-	5
	Material: .125" thick plastic					
	Lettering: 3/4" Helvetica	Black (W2) w/ white lettering	17.80	097216		
	Size: 2" x 4"	Blue (W3) w/ white lettering	17.80	032117		
	Fasteners: Double sided pressure sensitive tape, or screws (specify)	Silver (B1) w/ black lettering	17.80	089106		
Signs are individually packed in a polybag	Gold (B2) w/ black lettering	17.80	024447			
635	350R					
	Lettered Plastic Sign - Number	Brown (W1) w/ white lettering	15.85	000848	-	5
	Material: .125" thick plastic					
	Lettering: 3/4" Helvetica	Black (W2) w/ white lettering	15.85	010640		
	Size: 2" x 4"	Blue (W3) w/ white lettering	15.85	119668		
	Fasteners: Double sided pressure sensitive tape, or screws (specify)	Silver (B1) w/ black lettering	15.85	067081		
Signs are individually packed in a polybag						
Up to 3 characters (4 additional characters \$6.30)						

PUSH

PULL

 MEN

 WOMEN

Restroom

Description	Color	2018 List	Stock No.	Box Qty.	Case Qty.
351H					
Lettered Plastic Sign - PUSH Material: .125" thick plastic Lettering: 3/4" Helvetica Size: 1" x 4-1/2" Fasteners: Double sided pressure sensitive tape, or screws (specify) Signs are individually packed in a polybag	Brown (W1) w/ white lettering	15.85	011628	-	5
	Black (W2) w/ white lettering	15.85	016508		
	Blue (W3) w/ white lettering	15.85	017432		
	Silver (B1) w/ black lettering	15.85	097655		
	Gold (B2) w/ black lettering	15.85	009462		
351L					
Lettered Plastic Sign - PULL Material: .125" thick plastic Lettering: 3/4" Helvetica Size: 1" x 4-1/2" Fasteners: Double sided pressure sensitive tape, or screws (specify) Signs are individually packed in a polybag	Brown (W1) w/ white lettering	15.85	011623	-	5
	Black (W2) w/ white lettering	15.85	016509		
	Blue (W3) w/ white lettering	15.85	017433		
	Silver (B1) w/ black lettering	15.85	097656		
	Gold (B2) w/ black lettering	15.85	009464		
352M					
Lettered Plastic Sign - MEN Material: .125" thick plastic Lettering: 3/4" Helvetica Size: 2-1/2" x 6" Fasteners: Double sided pressure sensitive tape, or screws (specify) Signs are individually packed in a polybag	Brown (W1) w/ white lettering	20.70	092362	-	5
	Black (W2) w/ white lettering	20.70	089552		
	Blue (W3) w/ white lettering	20.70	089105		
	Silver (B1) w/ black lettering	20.70	092753		
	Gold (B2) w/ black lettering	20.70	098437		
352W					
Lettered Plastic Sign - WOMEN Material: .125" thick plastic Lettering: 3/4" Helvetica Size: 2-1/2" x 7" Fasteners: Double sided pressure sensitive tape, or screws (specify) Signs are individually packed in a polybag	Brown (W1) w/ white lettering	21.70	092363	-	5
	Black (W2) w/ white lettering	21.70	089553		
	Blue (W3) w/ white lettering	21.70	089100		
	Silver (B1) w/ black lettering	21.70	092754		
	Gold (B2) w/ black lettering	21.70	098438		
354A					
Lettered Plastic Sign - Restroom Material: .125" thick plastic Lettering: 3/4" Helvetica Size: 2" x 6" Fasteners: Double sided pressure sensitive tape Signs are individually packed in a polybag	Brown (W1) w/ white lettering	26.65	-	-	5
	Black (W2) w/ white lettering	26.65	024414		
	Blue (W3) w/ white lettering	26.65	035530		

1. Items with the price in **bold and red** are Quick Ship items and ship in 24 hours.
 Please use stock number when ordering. 2. U/M is each unless otherwise noted.



Trim & Auxiliary

Restrooms

Description	Color	2018 List	Stock No.	Box Qty.	Case Qty.
354B Lettered Plastic Sign - Restrooms Material: .125" thick plastic Lettering: 3/4" Helvetica Size: 2" x 6" Fasteners: Double sided pressure sensitive tape Signs are individually packed in a polybag	Brown (W1) w/ white lettering	26.65	-	-	5
	Black (W2) w/ white lettering	26.65	049899		
	Blue (W3) w/ white lettering	26.65	025589		





Description	Color	2018 List	Stock No.	Box Qty.	Case Qty.
364N Lasered International Symbol No Smoking Material: .125" thick plastic Size: 6" x 6" Fasteners: Pressure sensitive tape standard, or screws (specify) Signs are individually packed in a polybag	Red (W4) w/ raised white symbol	31.95	089099	-	5



364S International Handicap Symbol Material: .0625" thick plastic Raised HANDICAP symbol Size: 3" x 3" Fasteners: Pressure sensitive tape standard, or screws (specify) Signs are individually packed in a polybag	Blue (W3) w/ raised white symbol	19.10	099952	-	5
--	--	-------	--------	---	---



364M International Handicap Symbol Material: .0625" thick plastic Raised HANDICAP symbol Size: 4" x 4" Fasteners: Double sided pressure sensitive tape standard, or screws (specify) Signs are individually packed in a polybag	Blue (W3) w/ raised white symbol	23.85	092522	-	5
---	--	-------	--------	---	---



364L International Handicap Symbol Material: .125" thick plastic 1/32" raised HANDICAP symbol Size: 6" x 6" Fasteners: Double sided pressure sensitive tape standard, or screws (specify) Signs are individually packed in a polybag	Brown (W1) w/ raised white symbol	32.85	017405	-	5
	Black (W2) w/ raised white symbol	32.85	098102		
	Blue (W3) w/ raised white symbol	32.85	089101		



365M ADA Tactile Signage - MEN Material: .125" thick plastic Grade 2 Braille Translation Size: 6" x 8" Fasteners: Double sided pressure sensitive tape Signs are individually packed in a polybag	Brown (W1) w/ raised white symbol	53.65	089102	-	5
	Black (W2) w/ raised white symbol	53.65	089097		
	Blue (W3) w/ raised white symbol	53.65	089098		



365W ADA Tactile Signage - WOMEN Material: .125" thick plastic Grade 2 Braille Translation Size: 6" x 8" Fasteners: Double sided pressure sensitive tape Signs are individually packed in a polybag	Brown (W1) w/ raised white symbol	56.40	089116	-	5
	Black (W2) w/ raised white symbol	56.40	089117		
	Blue (W3) w/ raised white symbol	56.40	089118		

1. Items with the price in **bold and red** are Quick Ship items and ship in 24 hours.
Please use stock number when ordering. 2. U/M is each unless otherwise noted.



Trim & Auxiliary

325



Description	Color	2018 List	Stock No.	Box Qty.	Case Qty.
366R ADA Tactile Signage Room Number Material: .125" thick plastic Grade 2 Braille Translation Size: 2-1/2" x 5" Fasteners: Double sided pressure sensitive tape Up to 3 characters included Add \$6.30 for a fourth character Signs are individually packed in a polybag	Brown (W1) w/ raised white symbol	26.90	113411	-	5
	Black (W2) w/ raised white symbol	26.90	008919		
	Blue (W3) w/ raised white symbol	26.90	008910		
366S ADA Tactile Signage - STAIRS Material: .125" thick plastic Grade 2 Braille Translation Size: 6" x 8" Fasteners: Double sided pressure sensitive tape Signs are individually packed in a polybag	Brown (W1) w/ raised white symbol	47.80	089112	-	5
	Black (W2) w/ raised white symbol	47.80	089113		
	Blue (W3) w/ raised white symbol	47.80	089115		
368E ADA Tactile Signage - EXIT Material: .125" thick plastic Grade 2 Braille Translation Size: 6" x 8" Fasteners: Double sided pressure sensitive tape Signs are individually packed in a polybag	Brown (W1) w/ raised white symbol	47.80	089119	-	5
	Black (W2) w/ raised white symbol	47.80	090296		
	Blue (W3) w/ raised white symbol	47.80	089088		
368M ADA Tactile Signage - MEN Material: .125" thick plastic Grade 2 Braille Translation Size: 6" x 8" Fasteners: Double sided pressure sensitive tape Signs are individually packed in a polybag	Brown (W1) w/ raised white symbol	56.65	089089	-	5
	Black (W2) w/ raised white symbol	56.65	089456		
	Blue (W3) w/ raised white symbol	56.65	089090		
368W ADA Tactile Signage - WOMEN Material: .125" thick plastic Grade 2 Braille Translation Size: 6" x 8" Fasteners: Double sided pressure sensitive tape Signs are individually packed in a polybag	Brown (W1) w/ raised white symbol	59.45	089092	-	5
	Black (W2) w/ raised white symbol	59.45	090033		
	Blue (W3) w/ raised white symbol	59.45	089093		



Description	Color	2018 List	Stock No.	Box Qty.	Case Qty.
368U ADA Tactile Signage - UNISEX Material: .125" thick plastic Grade 2 Braille Translation Size: 8" x 8" Fasteners: Double sided pressure sensitive tape Signs are individually packed in a polybag	Brown (W1) w/ raised white symbol	65.55	089719	-	5
	Black (W2) w/ raised white symbol	65.55	090224		
	Blue (W3) w/ raised white symbol	65.55	089091		



369L ADA Tactile Signage - ACCESS LEFT Material: .125" thick plastic Grade 2 Braille translation Size: 6" x 8" Fasteners: Double sided pressure sensitive tape Signs are individually packed in a polybag	Brown (W1) w/ raised white symbol	53.65	089094	-	5
	Black (W2) w/ raised white symbol	53.65	094727		
	Blue (W3) w/ raised white symbol	53.65	089095		



369R ADA Tactile Signage - ACCESS RIGHT Material: .125" thick plastic Grade 2 Braille translation Size: 6" x 8" Fasteners: Double sided pressure sensitive tape Signs are individually packed in a polybag	Brown (W1) w/ raised white symbol	53.65	089096	-	5
	Black (W2) w/ raised white symbol	53.65	094726		
	Blue (W3) w/ raised white symbol	53.65	089120		



370M ADA Tactile Signage - RESTROOM MEN Material: 9/16" thick plastic Grade 2 Braille Translation Size: 10-1/2" side Fasteners: Double sided pressure sensitive tape Signs are individually packed in a polybag	Blue (W3) w/ raised white symbol and lettering	32.85	089558	-	5
--	---	-------	--------	---	---



370U ADA Tactile Signage - RESTROOM UNISEX Material: 9/16" thick plastic Grade 2 Braille Translation Size: 12" diameter Fasteners: Double sided pressure sensitive tape Signs are individually packed in a polybag	Blue (W3) w/ raised white symbol and lettering	32.85	091565	-	5
---	---	-------	--------	---	---



370W ADA Tactile Signage - RESTROOM WOMEN Material: 9/16" thick plastic Grade 2 Braille Translation Size: 12" diameter Fasteners: Double sided pressure sensitive tape Signs are individually packed in a polybag	Blue (W3) w/ raised white symbol and lettering	32.85	089557	-	5
--	---	-------	--------	---	---

1. Items with the price in **bold and red** are Quick Ship items and ship in 24 hours.
Please use stock number when ordering. 2. U/M is each unless otherwise noted.



Trim & Auxiliary



Description	Finish	2018 List	Stock No.	Box Qty.	Case Qty.
901P					
Coat Hook - Short single	US3	18.30	004095	1	-
Material: Brass	US26D	18.30	006028		
Diameter: 1"					
Projection: 1-1/4"					
Fasteners: #14 x 1-1/4" wood thread					
902P					
Coat Hook - Long Single	US3	25.70	004098	1	12
Material: Brass	US26D	25.70	011657		
Diameter: 1"					
Projection: 2-1/2"					
Fasteners: #14 x 1-1/4" wood thread					
903P					
Coat Hook - Long Double	US3	35.30	022247	1	12
Material: Brass	US26D	35.30	006364		
Diameter: 1"					
Projection: 2-1/2"					
Fasteners: #14 x 1-1/4" wood thread					
910P					
Offset Mounting Vertical Pull					
Pull Diameter: 1-1/4"					
Fasteners: 3/8 - 16 FPHMS with finish washers					
Clearance: 1-1/2"					
Projection: 2-3/4"					
Length: 36"	US3	329.90	-	1	12
CTC: 20"	US4	329.90	117797		
	US10	341.05	045611		
	US10B	341.05	075958		
	US15A	341.05	-		
	US26	341.05	013794		
	US26D	341.05	034212		
	US28	311.80	097652		
	US32D	249.50	034762		
Length: 72"	US3	396.80	-	1	12
CTC: 56"	US4	396.80	-		
	US10	420.95	-		
	US10B	420.95	001763		
	US15A	420.95	-		
	US26	420.95	013765		
	US26D	420.95	001766		
	US28	346.55	-		
	US32D	351.25	001767		





Description	Finish	2018 List	Stock No.	Box Qty.	Case Qty.
910B					
Offset Mounting Vertical Pull					
BTB Mounting					
Pull Diameter: 1-1/4"					
Clearance: 1-1/2"					
Projection: 2-3/4"					
Offset: 1-5/8"					
Length: 36"					
CTC: 20"					
	US3	679.55	141396	1	12
	US4	679.55	133716		
	US10	701.85	048451		
	US10B	701.85	043270		
	US15A	701.85	-		
	US26	701.85	-		
	US26D	701.85	048202		
	US28	643.40	-		
	US32D	518.75	022333		
Length: 72"	US3	813.35	-	1	12
CTC: 56"	US4	813.35	-		
	US10	861.60	-		
	US10B	861.60	045049		
	US15A	861.60	-		
	US26	861.60	145909		
	US26D	861.60	095610		
	US28	712.90	043452		
	US32D	722.25	034310		



915P					
Straight Mounting Vertical Pull					
Pull Diameter: 1-1/4"					
Fasteners: 3/8 - 16 FPHMS with finish washers					
Length: 36"					
CTC: 20"					
Clearance: 1-1/2"					
Projection: 2-3/4"					
	US3	311.80	-	1	12
	US4	311.80	030973		
	US10	328.95	-		
	US10B	328.95	024013		
	US15A	328.95	-		
	US26	328.95	011437		
	US26D	328.95	095117		
	US28	238.85	046879		
	US32D	272.35	022924		
Length: 72"	US3	363.35	026509	1	12
CTC: 56"	US4	363.35	093132		
Clearance: 1-1/2"	US10	386.15	-		
Projection: 2-3/4"	US10B	386.15	047686		
	US15A	386.15	-		
	US26	386.15	107976		
	US26D	386.15	076713		
	US28	311.80	147145		
	US32D	328.95	033534		

1. Items with the price in **bold and red** are Quick Ship items and ship in 24 hours.
 Please use stock number when ordering. 2. U/M is each unless otherwise noted.



Trim & Auxiliary



Description	Finish	2018 List	Stock No.	Box Qty.	Case Qty.
-------------	--------	-----------	-----------	----------	-----------

915B

915B
Straight Mounting Vertical Pull
BTB Mounting
Pull Diameter: 1-1/4"

Length: 36"	US3	643.40	083233	1	12
CTC: 20"	US4	643.40	095145		
Clearance: 1-1/2"	US10	677.65	127056		
Projection: 2-3/4"	US10B	677.65	045158		
	US15A	677.65	-		
	US26	677.65	042157		
	US26D	677.65	099445		
	US28	497.50	086258		
	US32D	564.45	036192		
Length: 72"	US3	746.45	079229	1	12
CTC: 56"	US4	746.45	030970		
Projection: 2-3/4"	US10	792.00	-		
	US10B	792.00	039857		
	US15A	792.00	-		
	US26	792.00	-		
	US26D	792.00	075209		
	US28	643.40	091752		
	US32D	677.65	038310		

920P

C-Shaped Pull
Projection: 2-1/4"
Base Diameter: 1"
Clearance: 1-3/4"
CTC: 8-1/2"
Fasteners: 3/8 - 16 FPHMS with finish washers

US3	396.80	175665	1	12
US4	396.80	023694		
US10	453.45	068045		
US10B	453.45	067513		
US15A	453.45	007029		
US26	453.45	-		
US26D	453.45	127861		
US28	254.60	-		
US32D	386.15	006521		

920B

C-Shaped Pull
BTB Mounting
Projection: 2-1/4"
Base Diameter: 1"
Clearance: 1-3/4"
CTC: 8-1/2"

US3	813.35	075752	1	12
US4	813.35	023825		
US10	926.65	-		
US10B	926.65	-		
US15A	926.65	-		
US26	926.65	-		
US26D	813.35	-		
US28	529.05	-		
US32D	792.00	028143		





Description	Finish	2018 List	Stock No.	Box Qty.	Case Qty.
921P					
C-Shaped Pull	US3	793.45	108557	1	12
Projection: 2-1/8"	US4	793.45	-		
Clearance: 1-1/2"	US10B	793.45	025579		
Offset: 8-1/2"	US15A	793.45	-		
CTC: 17-1/2"	US26	793.45	-		
Fasteners: 3/8 - 16 FPHMS with finish washers	US26D	793.45	063488		
	US32D	747.90	039887		
921B					
C-Shaped Pull	US3	1,606.65	-	1	12
BTB Mounting	US4	1,606.65	-		
Projection: 2-1/8"	US10B	1,606.65	-		
Clearance: 1-1/2"	US15A	1,606.65	-		
Offset: 8-1/2"	US26	1,606.65	-		
CTC: 17-1/2"	US26D	1,606.65	092126		
	US32D	1,515.55	021628		
922P					
C-Shaped Pull Continuous					
Pull Diameter: 1"					
Projection: 2-1/2"					
Fasteners: 3/8 - 16 FPHMS with finish washers					
Clearance: 1-1/2"					
CTC: 10"	US3	247.65	052183	1	12
	US4	247.65	-		
	US10	301.10	001074		
	US10B	301.10	076741		
	US15A	301.10	-		
	US26	301.10	080488		
	US26D	301.10	033046		
	US28	159.45	-		
	US32D	238.85	040459		
CTC: 12"	US3	284.40	007927	1	12
	US4	284.40	018417		
	US10	317.80	029399		
	US10B	317.80	029237		
	US15A	317.80	-		
	US26	317.80	031122		
	US26D	317.80	033048		
	US28	181.70	-		
	US32D	261.20	017908		

1. Items with the price in **bold and red** are Quick Ship items and ship in 24 hours.
 Please use stock number when ordering. 2. U/M is each unless otherwise noted.



Trim & Auxiliary



Description	Finish	2018 List	Stock No.	Box Qty.	Case Qty.
922B					
C-Shaped Pull Continuous					
BTB Mounting					
Pull Diameter: 1"					
Projection: 2-1/2"					
Clearance: 1-1/2"					
CTC: 10"					
	US3	515.10	043544	1	12
	US4	515.10	054798		
	US10	621.90	-		
	US10B	621.90	076740		
	US15A	621.90	-		
	US26	621.90	038676		
	US26D	621.90	028387		
	US28	338.65	047322		
	US32D	497.50	031463		
CTC: 12"					
	US3	588.55	025373	1	12
	US4	588.55	049391		
	US10	655.40			
	US10B	655.40	031604		
	US15A	655.40	-		
	US26	655.40	039882		
	US26D	655.40	054764		
	US28	383.25	-		
	US32D	542.15	032177		



923P					
C-Shaped Pull Flanged					
Pull Diameter: 1"					
Projection: 2-3/4"					
Clearance: 1-3/4"					
Base Diameter: 3/4"					
Fasteners: 3/8 - 16 FPHMS with finish washers					
CTC: 10"					
	US3	283.45	-	1	12
	US4	283.45	-		
	US10	300.15	-		
	US10B	300.15	042387		
	US15A	300.15	-		
	US26	300.15	-		
	US26D	300.15	-		
	US28	158.95	042579		
	US32D	237.95	107215		
CTC: 12"					
	US3	305.75	028028	1	12
	US4	305.75	041657		
	US10	317.80	-		
	US10B	317.80	086167		
	US15A	317.80	-		
	US26	317.80	007281		
	US26D	317.80	059492		
	US28	183.10	-		
	US32D	261.20	043111		





Description	Finish	2018 List	Stock No.	Box Qty.	Case Qty.
923B					
C-Shaped Pull Flanged					
BTB Mounting					
Pull Diameter: 1"					
Projection: 2-3/4"					
Clearance: 1-3/4"					
Base Diameter: 3/4"					
CTC: 10"	US3	586.65	-	1	12
	US4	586.65	-		
	US10	620.00	-		
	US10B	620.00	-		
	US15A	620.00	-		
	US26	620.00	056938		
	US26D	620.00	027475		
	US28	337.65	087162		
	US32D	495.65	097112		
CTC: 12"	US3	631.25	033306	1	12
	US4	631.25	-		
	US10	655.40	-		
	US10B	655.40	109525		
	US15A	655.40	-		
	US26	655.40	036898		
	US26D	655.40	100390		
	US28	385.95	-		
	US32D	542.15	032950		
924P					
C-Shaped Pull	US3	351.25	047324	1	12
O/A Height: 15"	US4	351.25	081526		
Projection: 2-1/2"	US10B	386.15	039224		
Clearance: 1-1/2"	US15A	386.15	112695		
Offset: 6-1/2"	US26	386.15	-		
Fasteners: 3/8 -16 FPHMS with finish washers	US26D	351.25	033435		
	US32D	511.00	091516		
924B					
C-Shaped Pull	US3	722.25	-	1	12
BTB Mounting	US4	722.25	094302		
O/A Height: 15"	US10B	792.00	027198		
Projection: 2-1/2"	US15A	792.00	113505		
Clearance: 1-1/2"	US26	792.00	-		
Offset: 6-1/2"	US26D	722.25	034830		
	US32D	1,041.75	044848		



1. Items with the price in **bold and red** are Quick Ship items and ship in 24 hours.
Please use stock number when ordering. 2. U/M is each unless otherwise noted.



Trim & Auxiliary



Description	Finish	2018 List	Stock No.	Box Qty.	Case Qty.
925P					
C-Shaped Pull					
Pull Diameter: 1-1/4"					
Fasteners: 3/8 - 16 FPHMS with finish washers					
6-1/2"	US3	311.80	-	1	12
	US4	311.80	-		
	US10	328.95	-		
	US10B	328.95	-		
	US15A	328.95	-		
	US26	328.95	-		
	US26D	328.95	-		
	US28	225.80	-		
	US32D	254.60	082874		
8-1/2"	US3	317.80	105030	1	12
	US4	317.80	-		
	US10	340.10	-		
	US10B	340.10	009660		
	US15A	340.10	-		
	US26	340.10	-		
	US26D	340.10	020046		
	US28	237.95	-		
	US32D	272.35	093311		
12-1/2"	US3	374.45	063609	1	12
	US4	374.45	022243		
	US10	396.80	-		
	US10B	396.80	095383		
	US15A	396.80	-		
	US26	396.80	-		
	US26D	396.80	015911		
	US28	272.35	-		
	US32D	363.35	019494		





Description	Finish	2018 List	Stock No.	Box Qty.	Case Qty.
925B					
C-Shaped Pull					
BTB Mounting					
Pull Diameter: 1-1/4"					
6-1/2"	US3	643.40	-	1	12
	US4	643.40	-		
	US10	677.65	-		
	US10B	677.65	-		
	US15A	677.65	-		
	US26	677.65	-		
	US26D	631.25	-		
	US28	677.65	-		
	US32D	529.05	032601		
8-1/2"	US3	655.40	-	1	12
	US4	655.40	-		
	US10	699.95	-		
	US10B	699.95	126789		
	US15A	699.95	-		
	US26	699.95	-		
	US26D	699.95	-		
	US28	495.65	-		
	US32D	564.45	091632		
12-1/2"	US3	768.75	084531	1	12
	US4	768.75	-		
	US10	813.35	-		
	US10B	813.35	-		
	US15A	813.35	-		
	US26	813.35	-		
	US26D	813.35	-		
	US28	564.45	-		
	US32D	746.45	-		
926P					
Curved Shaped Pull	US3	363.35	087555	1	12
Base Diameter: 1-1/4"	US4	363.35	-		
Projection: 3"	US10B	407.95	000085		
Clearance: 1-13/16"					
Offset: 5-9/32"					
CTC: 12"					
Pull Diameter: 1-3/16"					
Fasteners: 3/8 - 16 FPHMS with finish washers					
926B					
Curved Shaped Pull	US3	746.45	-	1	12
BTB Mounting	US4	746.45	-		
Base Diameter: 1-1/4"	US10B	835.65	-		
Projection: 3"					
Clearance: 1-13/16"					
Offset: 5-9/32"					
CTC: 12"					
Pull Diameter: 1-3/16"					



1. Items with the price in **bold and red** are Quick Ship items and ship in 24 hours.
 Please use stock number when ordering. 2. U/M is each unless otherwise noted.



Trim & Auxiliary



Description	Finish	2018 List	Stock No.	Box Qty.	Case Qty.
930P					
90° Pull					
Fasteners: 3/8 - 16 FPHMS with finish washers					
Projection: 3"					
Clearance: 1-3/4"					
10" x 10", 14-5/32 CTC	US3	238.85	-	1	12
	US4	238.85	-		
	US10B	272.35	104490		
	US15A	272.35	-		
	US26	272.35	-		
	US26D	272.35	038630		
	US28	146.85	-		
	US32D	226.75	041518		
12" x 12" 16-31/32" CTC	US3	255.55	-	1	12
	US4	255.55	-		
	US10B	295.10	-		
	US15A	295.10	-		
	US26	249.50	063600		
	US26D	249.50	-		
	US28	159.45	-		
	US32D	238.85	063295		



930B					
90° Pull					
BTB Mounting					
Projection: 3"; Clearance: 1-3/4"					
10" x 10", 14-5/32 CTC	US3	497.50	078218	1	12
	US4	497.50	-		
	US10B	564.45	104485		
	US15A	564.45	-		
	US26	564.45	-		
	US26D	564.45	-		
	US28	313.50	-		
	US32D	473.25	102505		
12" x 12" 16-31/32" CTC	US3	530.90	-	1	12
	US4	530.90	-		
	US10B	609.90	-		
	US15A	609.90	-		
	US26	518.75	-		
	US26D	518.75	-		
	US28	338.65	-		
	US32D	497.50	048305		



932P					
S-Shaped Pull					
Projection: 3"					
Clearance: 2"					
Pull Diameter: 1"					
Fasteners: 3/8 - 16 FPHMS with finish washers					
	US3	476.15	017835	1	12
	US4	476.15	019496		
	US10B	521.75	039480		
	US15A	521.75	020472		
	US26	521.75	-		
	US26D	476.15	019495		
	US28	386.15	-		
	US32D	465.55	021879		



Description	Finish	2018 List	Stock No.	Box Qty.	Case Qty.
932B					
S-Shaped Pull	US26D	1,613.00	-	1	12
BTB Mounting	US32D	1,268.20	-		
Projection: 3"					
Clearance: 2"					
Pull Diameter: 1"					
Fasteners: 3/8 - 16 FPHMS with finish washers					
Note: must specify handing					
933P					
Colonial Style Door Pull	US3	91.15	021632	1	12
Projection: 2-3/16"	US4	80.05	025560		
Pull Diameter: 1"	US10B	107.85	041459		
Base Diameter: 15/16"	US26	107.85	140775		
Fasteners: 3/8 - 16 FPHMS with finish washers					
Clearance: 1-3/16"					
CTC: 6"					
933B					
Colonial Style Door Pull	US3	202.10	-	1	12
BTB Mounting	US4	179.90	-		
Projection: 2-3/16"	US10B	235.50	020879		
Pull Diameter: 1"	US26	235.50	-		
Base Diameter: 15/16"					
Clearance: 1-3/16"					
CTC: 6"					
934P					
Offset Pull					
Projection: 3-1/8"					
Pull Diameter: 1-1/4"					
Base Diameter: 1"					
Clearance: 1-7/8"					
Fasteners: 3/8 - 16 FPHMS with finish washers					
CTC: 12"	US3	328.95	015408	1	12
	US4	328.95	055245		
	US10B	328.95	018229		
	US15A	328.95	022244		
	US26	328.95	024963		
	US26D	328.95	009614		
	US28	325.20	-		
	US32D	396.80	087258		
CTC: 16"	US3	340.55	015588	1	12
	US4	340.55	-		
	US10B	340.55	018887		
	US15A	340.55	014454		
	US26	340.55	-		
	US26D	340.55	081586		
	US28	334.55	-		
	US32D	410.65	055788		
CTC: 18"	US3	373.05	012816	1	12
	US4	373.05	-		
	US10B	373.05	018219		
	US15A	373.05	-		
	US26	373.05	024883		
	US26D	373.05	-		
	US28	367.00	-		
	US32D	449.70	089638		

1. Items with the price in **bold and red** are Quick Ship items and ship in 24 hours.
Please use stock number when ordering. 2. U/M is each unless otherwise noted.



Trim & Auxiliary



Description	Finish	2018 List	Stock No.	Box Qty.	Case Qty.
934B					
Offset Pull					
BTB Mounting					
Base Diameter: 1"					
Projection: 3-1/8"					
Clearance: 1-7/8"					
Pull Diameter: 1-1/4"					
CTC: 12"	US3	677.65	-	1	12
	US4	677.65	048154		
	US10B	677.65	042701		
	US15A	677.65	-		
	US26	677.65	-		
	US26D	677.65	-		
	US28	670.20	-		
	US32D	813.35	120341		
CTC: 16"	US3	700.90	083864	1	12
	US4	700.90	-		
	US10B	700.90	-		
	US15A	700.90	-		
	US26	700.90	-		
	US26D	700.90	-		
	US28	688.85	-		
	US32D	841.10	-		
CTC: 18"	US3	765.90	-	1	12
	US4	765.90	048152		
	US10B	765.90	-		
	US15A	765.90	-		
	US26	765.90	-		
	US26D	765.90	-		
	US28	753.75	-		
	US32D	919.10	098230		
936P					
Coat Hook Single/Angled	US3	48.40	021976	1	12
Material: Brass	US26D	48.40	009820		
Base Diameter: 1-15/16"					
Hook Diameter: 11/16"					
Projection: 3-5/16"					
937P					
Coat Hook	US3	49.60	028259	1	12
Material: Brass	US26D	49.60	009821		
Projection: 3-3/4" top hook; 2-1/2" bottom hook					
940P					
Double Coat Hook	US3	18.10	028110	1	12
Material: Brass	US26D	18.10	022327		
Top Projection: 3-15/16"					
Bottom Projection: 2-1/8"					
Thickness: 1/4"					
Fasteners: #10 x 1" FPHWS					





Description	Finish	2018 List	Stock No.	Box Qty.	Case Qty.
941P Single Coat Hook Material: Brass Projection: 2-1/8" Thickness: 1/4" Fasteners: #10 x 1" FPHWS	US3 US26D	16.85 16.85	043274 017192	1	12
945P Double Coat Hook - Surface mounting Material: Brass O/A Height: 5-1/2" Projection: 3-5/16" Fasteners: #10 x 1" FPHWS w/ anchors	US3 US26D	45.95 45.95	041591 000986	1	12
946P Double Coat Hook w/ Concealed Mounting Material: Brass O/A Height: 5-1/2" Projection: 3-11/16" Fasteners: #10 x 1" FPHWS w/ anchors	US3 US26D	87.60 87.60	035563 016502	1	12
951P Double Coat Hook/Straight Material: Brass O/A Height: 5-3/4" Projection: 2-3/4"	US3 US26D	87.60 87.60	009815 007030	1	12
952P Single Coat Hook/Straight Material: Brass O/A Height: 2-13/16" Projection: 2-7/32"	US3 US26D	70.30 70.30	009818 009816	1	12
956P Double Coat Hook/Angled Material: Brass O/A Height: 5-11/16" Projection: 3-23/32"	US3 US4 US26D	85.30 85.30 85.30	022248 190569 009823	1	12
957P Coat Hook Materials: Brass Projection: 1-3/4" Base Diameter: 3/4" Fasteners: #10 x 1" wood thread	US3 US26D	21.55 21.55	038315 010738	1	12
960P Square Tip Pull O/A Height: 16" Base Diameter: 1-1/4" Pull Diameter: 1" Projection: 3-1/4" Clearance: 1-3/4" Fasteners: 3/8 - 16 FPHMS with finish washers CTC: 12"	US3 US4 US10B US15A US26 US26D	430.65 430.65 430.65 430.65 430.65 430.65	009259 038157 011621 013611 020471 015493	1	12

1. Items with the price in **bold and red** are Quick Ship items and ship in 24 hours.
Please use stock number when ordering. 2. U/M is each unless otherwise noted.



Trim & Auxiliary



Description	Finish	2018 List	Stock No.	Box Qty.	Case Qty.
960B					
Square Tip Pull	US3	881.10	-	1	12
BTB Mounting	US4	881.10	044725		
O/A Height: 16"	US10B	881.10	075667		
Base Diameter: 1-1/4"	US15A	881.10	-		
Pull Diameter: 1"	US26	881.10	-		
Projection: 3-1/4"	US26D	881.10	069324		
Clearance: 1-3/4"					
CTC: 12"					
961P					
Steeple Tip Pull	US3	407.95	000571	1	12
O/A Height: 16-5/16"	US4	407.95	-		
Base Diameter: 2"	US10B	407.95	015679		
Pull Diameter: 1"	US15A	407.95	009262		
Projection: 3"	US26	407.95	-		
Clearance: 1-3/4"	US26D	407.95	015011		
Fasteners: 3/8 - 16 FPHMS with finish washers					
CTC: 12"					
961B					
Steeple Tip Pull	US3	835.65	026830	1	12
BTB Mounting	US4	835.65	074979		
O/A Height: 16-5/16"	US10B	835.65	078830		
Base Diameter: 2"	US15A	835.65	-		
Pull Diameter: 1"	US26	835.65	-		
Projection: 3"	US26D	835.65	092283		
Clearance: 1-3/4"					
CTC: 12"					
962P					
Acorn Tip Pull	US3	407.95	007923	1	12
O/A Height: 16-5/16"	US4	407.95	011372		
Base Diameter: 2"	US10B	407.95	011629		
Pull Diameter: 1"	US15A	407.95	000573		
Projection: 3"	US26	407.95	009264		
Clearance: 1-7/8"	US26D	407.95	-		
Fasteners: 3/8 - 16 FPHMS with finish washers					
CTC: 12"					



Description	Finish	2018 List	Stock No.	Box Qty.	Case Qty.
963P					
Acorn Tip Pull - Offset					
Pull Diameter: 1"					
Fasteners: 3/8 - 16 FPHMS with finish washers					
CTC: 12"	US3	442.30	090673	1	12
	US4	425.60	-		
	US10B	442.30	093281		
	US15A	442.30	-		
	US26	442.30	-		
	US26D	442.30	-		
CTC: 16"	US3	544.55	-	1	12
	US4	515.75	-		
	US10B	544.55	125026		
	US15A	544.55	-		
	US26	544.55	-		
	US26D	544.55	089733		
CTC: 18"	US3	549.15	068942	1	12
	US4	441.35	080532		
	US10B	553.40	099640		
	US15A	553.40	-		
	US26	553.40	-		
	US26D	553.40	015561		
CTC: 24"	US3	575.10	-	1	12
	US4	545.75	-		
	US10B	575.10	049909		
	US15A	575.10	-		
	US26	575.10	-		
	US26D	575.10	073269		
CTC: 30"	US3	597.90	-	1	12
	US4	570.95	-		
	US10B	597.90	049907		
	US15A	597.90	-		
	US26	597.90	-		
	US26D	597.90	-		
967P					
Curved Pull	US3	1,076.75	024430	1	12
O/A Height: 20-1/2"	US4	1,076.75	009305		
Clearance: 3-9/16"	US10B	1,245.90	016556		
Projection: 5-9/16"	US15A	1,245.90	006769		
Specify handing	US26	1,245.90	011769		
Fasteners: 3/8 - 16 FPHMS with finish washers	US26D	1,245.90	008614		



1. Items with the price in **bold and red** are Quick Ship items and ship in 24 hours.
Please use stock number when ordering. 2. U/M is each unless otherwise noted.



Trim & Auxiliary



Description	Finish	2018 List	Case Qty.	Over 36"*
970P				
970P	US3	493.25	12	8.00
Push/Pull Set	US4	493.25		8.00
Base Diameter: 1"	US10	493.25		8.00
Pull Projection: 3"	US10B	493.25		8.00
Pull Clearance: 2"	US15A	493.25		8.00
CTC Length: 16-3/4"	US26	493.25		8.00
Push clearance: 1-3/4"	US26D	493.25		8.00
Push projection: 2-3/4"	US32D	476.00		13.40
Fasteners: Type 3 Mounting				
Handing Required				
Additional Bars by Quotation				
*Add per linear inch or fraction thereof				



Description	Finish	2018 List	Stock No.	Box Qty.	Case Qty.
974P					
Door Pull					
Pull Diameter: 1" (25 mm)					
Base Diameter: 2" (51 mm)					
Projection: 2-1/2"					
Fasteners: 3/8 - 16 FPHMS with finish washers					
CTC: 12"	US3	489.70	096812	1	12
	US4	489.70	-		
	US10B	489.70	077525		
	US26	489.70	-		
	US26D	489.70	067183		
	US32D	489.70	090347		
CTC: 18"	US3	509.65	-	1	12
	US4	509.65	-		
	US10B	509.65	-		
	US26	509.65	-		
	US26D	509.65	077942		
	US32D	509.65	008568		
CTC: 24"	US3	532.40	-	1	12
	US4	532.40	-		
	US10B	532.40	-		
	US26	532.40	-		
	US26D	532.40	118329		
	US32D	532.40	065323		
CTC: 30"	US3	555.15	-	1	12
	US4	555.15	-		
	US10B	555.15	-		
	US26	555.15	-		
	US26D	555.15	-		
	US32D	555.15	-		
CTC: 36"	US3	555.15	-	1	12
	US4	555.15	-		
	US10B	555.15	-		
	US26	555.15	-		
	US26D	555.15	117957		
	US32D	555.15	138337		



Description	Finish	2018 List	Stock No.	Box Qty.	Case Qty.
974B					
Door Pull					
BTB Mounting					
Pull Diameter: 1" (25 mm)					
Base Diameter: 2" (51 mm)					
Projection: 2-1/2"					
Fasteners: 3/8 - 16 FPHMS with finish washers					
CTC: 12"	US3	999.15	-	1	12
	US4	999.15	-		
	US10B	999.15	094407		
	US26	999.15	-		
	US26D	999.15	-		
	US32D	999.15	094083		
CTC: 18"	US3	1,039.05	-	1	12
	US4	1,039.05	-		
	US10B	1,039.05	-		
	US26	1,039.05	-		
	US26D	1,039.05	091914		
	US32D	1,039.05	080540		
CTC: 24"	US3	1,084.60	-	1	12
	US4	1,084.60	-		
	US10B	1,084.60	031371		
	US26	1,084.60	111278		
	US26D	1,084.60	094396		
	US32D	1,084.60	080541		
CTC: 30"	US3	1,130.05	-	1	12
	US4	1,130.05	-		
	US10B	1,130.05	-		
	US26	1,130.05	-		
	US26D	1,130.05	107473		
	US32D	1,130.05	124943		
CTC: 36"	US3	1,130.05	-	1	12
	US4	1,130.05	-		
	US10B	1,130.05	-		
	US26	1,130.05	-		
	US26D	1,130.05	-		
	US32D	1,130.05	091943		

1. Items with the price in **bold and red** are Quick Ship items and ship in 24 hours.
 Please use stock number when ordering. 2. U/M is each unless otherwise noted.



Trim & Auxiliary



Description	Finish	2018 List	Stock No.	Box Qty.	Case Qty.
975P					
Vertical Pull					
Pull Diameter: 1"					
Projection: 2-3/4"					
Fasteners: 3/8 - 16 FPHMS with finish washers					
Length: 36"	US3	268.60	119311	1	12
CTC: 20"	US4	268.60	-		
	US10	268.60	068796		
	US10B	268.60	042466		
	US15A	268.60	012591		
	US26	268.60	050339		
	US26D	268.60	012278		
	US32D	268.60	010891		
Length: 72"	US3	386.15	119290	1	12
CTC: 56"	US4	386.15	074642		
	US10	386.15	070431		
	US10B	386.15	022804		
	US15A	386.15	012601		
	US26	386.15	030738		
	US26D	386.15	029768		
	US32D	386.15	028382		



975B					
Vertical Pull					
BTB Mounting					
Pull Diameter: 1"					
Projection: 2-3/4"					
Length: 36"	US3	557.00	-	1	12
CTC: 20"	US4	557.00	-		
	US10	557.00	-		
	US10B	557.00	025610		
	US15A	557.00	-		
	US26	557.00	030737		
	US26D	557.00	021401		
	US32D	557.00	028442		
Length: 72"	US3	792.00	-	1	12
CTC: 56"	US4	792.00	-		
	US10	792.00	070432		
	US10B	792.00	021488		
	US15A	792.00	-		
	US26	792.00	030738		
	US26D	792.00	021402		
	US32D	792.00	021547		



976P					
Door Pull Offset					
Overall: 29-1/2"; CTC: 19-13/16"					
Base Diameter: 1-1/4"					
Pull Diameter: 1-1/4"					
Projection: 5-3/8"					
Clearance: 4-1/8"					
Offset: 1-3/4"					
Fasteners: 3/8 - 16 FPHMS with finish washers					
	US32D	593.75	088820	1	12



Description	Finish	2018 List	Stock No.	Box Qty.	Case Qty.
976B					
Door Pull Offset	US32D	1,207.25	062051	1	12
Overall: 29-1/2"; CTC: 19-13/16"					
BTB Mounting					
Base Diameter: 1-1/4"					
Pull Diameter: 1-1/4"					
Projection: 5-3/8"					
Clearance: 4-1/8"					
Offset: 1-3/4"					
980P					
Segment Shape - Straight					
Fasteners: 3/8 - 16 FPHMS with finish washers					
CTC: 9"	US3	179.40	-	1	12
	US4	179.40	-		
	US10B	179.40	012840		
	US15A	179.40	076601		
	US26	179.40	-		
	US26D	179.40	-		
	US32D	179.40	027302		
CTC: 12"	US3	179.40	-	1	12
	US4	179.40	095352		
	US10B	179.40	083262		
	US15A	179.40	-		
	US26	179.40	014517		
	US26D	179.40	049530		
	US32D	179.40	031717		
CTC: 18"	US3	198.85	-	1	12
	US4	198.85	-		
	US10B	198.85	012799		
	US15A	198.85	014455		
	US26	198.85	064564		
	US26D	198.85	057861		
	US32D	198.85	016625		
CTC: 24"	US3	198.85	041663	1	12
	US4	198.85	085204		
	US10B	198.85	065896		
	US15A	198.85	-		
	US26	198.85	011979		
	US26D	198.85	036275		
	US32D	198.85	024698		

1. Items with the price in **bold and red** are Quick Ship items and ship in 24 hours.
 Please use stock number when ordering. 2. U/M is each unless otherwise noted.

Trim & Auxiliary



Description	Finish	2018 List	Stock No.	Box Qty.	Case Qty.
980B					
Segment Shape - Straight					
BTB Mounting					
CTC: 9"					
	US3	378.55	-	1	12
	US4	378.55	-		
	US10B	378.55	116185		
	US15A	378.55	114829		
	US26	378.55	-		
	US26D	378.55	-		
	US32D	378.55	083497		
CTC: 12"					
	US3	378.55	-	1	12
	US4	378.55	-		
	US10B	378.55	101513		
	US15A	378.55	-		
	US26	378.55	-		
	US26D	378.55	039876		
	US32D	378.55	032307		
CTC: 18"					
	US3	417.45	-	1	12
	US4	417.45	-		
	US10B	417.45	077056		
	US15A	417.45	077533		
	US26	417.45	088558		
	US26D	417.45	044015		
	US32D	417.45	022336		
CTC: 24"					
	US3	417.45	-	1	12
	US4	417.45	-		
	US10B	417.45	017774		
	US15A	417.45	-		
	US26	417.45	-		
	US26D	417.45	027476		
	US32D	417.45	032023		

Description	Finish	2018 List	Stock No.	Box Qty.	Case Qty.
981P					
Segment Shape - Offset Pull					
Projection: 2-3/8"					
Fasteners: 3/8 - 16 FPHMS with finish washers					
CTC: 9"	US3	204.00	-	1	12
	US4	204.00	-		
	US10B	204.00	047545		
	US15A	204.00	087991		
	US26	204.00	-		
	US26D	204.00	047907		
	US32D	204.00	046757		
CTC: 12"	US3	211.90	026794	1	12
	US4	211.90	111689		
	US10B	211.90	027812		
	US15A	211.90	026777		
	US26	211.90	011836		
	US26D	211.90	035056		
	US32D	211.90	004578		
CTC: 18"	US3	238.85	053460	1	12
	US4	238.85	-		
	US10B	238.85	075906		
	US15A	238.85	019090		
	US26	238.85	042120		
	US26D	238.85	010525		
	US32D	238.85	015319		
CTC: 24"	US3	295.10	011702	1	12
	US4	295.10	006783		
	US10B	295.10	039910		
	US15A	295.10	020401		
	US26	295.10	092955		
	US26D	295.10	010526		
	US32D	295.10	033975		

1. Items with the price in **bold and red** are Quick Ship items and ship in 24 hours.
Please use stock number when ordering. 2. U/M is each unless otherwise noted.



Trim & Auxiliary



Description	Finish	2018 List	Stock No.	Box Qty.	Case Qty.
981B					
Segment Shape - Offset Pull					
BTB Mounting					
Projection: 2-3/8"					
CTC: 9"	US3	427.75	-	1	12
	US4	427.75	-		
	US10B	427.75	089663		
	US15A	427.75	-		
	US26	427.75	-		
	US26D	427.75	-		
	US32D	427.75	076275		
CTC: 12"	US3	443.50	027231	1	12
	US4	443.50	-		
	US10B	443.50	078949		
	US15A	443.50	-		
	US26	443.50	-		
	US26D	443.50	023547		
	US32D	443.50	037048		
CTC: 18"	US3	497.50	-	1	12
	US4	497.50	050164		
	US10B	497.50	001599		
	US15A	497.50	-		
	US26	497.50	022355		
	US26D	497.50	022637		
	US32D	497.50	028505		
CTC: 24"	US3	609.90	-	1	12
	US4	609.90	-		
	US10B	609.90	085243		
	US15A	609.90	-		
	US26	609.90	049864		
	US26D	609.90	027598		
	US32D	609.90	031349		
982P					
Straight Pull	US3	442.30	087996	1	12
Base Diameter: 1-5/16"	US4	442.30	-		
Projection: 3-1/8"	US10B	476.15	084256		
Clearance: 1-13/16"	US15A	476.15	-		
CTC: 20"	US26	476.15	-		
Fasteners: 3/8 - 16 FPHMS with finish washers	US26D	476.15	058080		
	US32D	544.55	080284		
982B					
Straight Pull	US3	904.35	-	1	12
BTB Mounting	US4	904.35	-		
Base Diameter: 1-5/16"	US10B	972.15	-		
Projection: 3-1/8"	US15A	972.15	-		
Clearance: 1-13/16"	US26	972.15	-		
CTC: 20"	US26D	972.15	009491		
	US32D	1,108.85	091255		





Description	Finish	2018 List	Stock No.	Box Qty.	Case Qty.
983P					
Curved Pull					
Base Diameter: 14-1/4"					
Projection: 3-1/8"					
Clearance: 1-7/8"					
Fasteners: 3/8 - 16 FPHMS with finish washers					
Specify handing					
Left Hand	US3	442.30	-	1	12
	US4	442.30	072498		
	US10B	476.15	099179		
	US15A	476.15	-		
	US26	476.15	072454		
	US26D	476.15	-		
	US32D	544.55	-		
Right Hand	US3	442.30	-	1	12
	US4	442.30	072483		
	US10B	476.15	099018		
	US15A	476.15	-		
	US26	476.15	072461		
	US26D	476.15	105909		
	US32D	544.55	-		



983B					
Curved Pull					
BTB Mounting					
Base Diameter: 14-1/4"					
Projection: 3-1/8"					
Clearance: 1-7/8"					
Specify handing					
Left Hand	US3	904.35	099638	1	12
	US4	904.35	-		
	US10B	972.15	044345		
	US15A	972.15	-		
	US26	972.15	072463		
	US26D	972.15	065560		
	US32D	1,108.85	085556		
Right Hand	US3	904.35	098156	1	12
	US4	904.35	-		
	US10B	972.15	044347		
	US15A	972.15	-		
	US26	972.15	-		
	US26D	972.15	065559		
	US32D	1,108.85	085557		

1. Items with the price in **bold and red** are Quick Ship items and ship in 24 hours.
 Please use stock number when ordering. 2. U/M is each unless otherwise noted.



Trim & Auxiliary



Description	Finish	2018 List	Stock No.	Box Qty.	Case Qty.
984P					
Curved Pull					
Projection: 3"					
Fasteners: 3/8 - 16 FPHMS with finish washers					
CTC: 12"	US3	295.10	-	1	12
	US4	295.10	021651		
	US10B	295.10	067449		
	US15A	295.10	-		
	US26	295.10	-		
	US26D	295.10	013764		
	US32D	368.00	078894		
CTC: 20"	US3	440.45	077926	1	12
	US4	440.45	-		
	US10B	440.45	092541		
	US15A	440.45	-		
	US26	440.45	-		
	US26D	440.45	014652		
	US32D	569.10	082549		



984B					
Curved Pull					
BTB Mounting					
Projection: 3"					
CTC: 12"	US3	609.90	-	1	12
	US4	609.90	-		
	US10B	609.90	033349		
	US15A	609.90	-		
	US26	609.90	-		
	US26D	609.90	-		
	US32D	755.75	057306		
CTC: 20"	US3	900.70	-	1	12
	US4	900.70	039804		
	US10B	900.70	033348		
	US15A	900.70	-		
	US26	900.70	-		
	US26D	900.70	032543		
	US32D	1,158.00	114348		



985P					
Curved Pull	US3	249.50	006990	1	12
O/A Height: 14"	US4	249.50	020375		
Base Diameter: 2"	US10B	284.40	009303		
Projection: 3"	US15A	284.40	014456		
Clearance: 1-9/16"	US26	284.40	055276		
Offset: 1-5/8"	US26D	249.50	007482		
CTC: 12"	US32D	363.35	010406		
Fasteners: 3/8 - 16 FPHMS with finish washers					



Description	Finish	2018 List	Stock No.	Box Qty.	Case Qty.
985B					
Curved Pull	US3	518.75	025851	1	12
BTB Mounting	US4	518.75	029159		
O/A Height: 14"	US10B	588.55	024891		
Base Diameter: 2"	US15A	588.55	027680		
Projection: 3"	US26	588.55	-		
Offset: 1-5/8"	US26D	518.75	025866		
Clearance: 1-9/16"	US32D	746.45	023384		
CTC: 12"					
986P					
Curved Pull	US3	623.45	081279	1	12
O/A Height: 22"	US4	623.45	033174		
Pull Diameter: 1-1/4"	US10B	623.45	014868		
Base Diameter: 2"	US15A	623.45	021822		
Projection: 3-7/8"	US26	623.45	016593		
Offset: 3"	US26D	623.45	010418		
Clearance: 2-5/8"	US32D	566.75	011392		
CTC: 20"					
Fasteners: 3/8 - 16 FPHMS with finish washers					
986B					
Curved Pull	US3	1,266.65	-	1	12
BTB Mounting	US4	1,266.65	032338		
O/A Height: 22"	US10B	1,266.65	013369		
Pull Diameter: 1-1/4"	US15A	1,266.65	042684		
Base Diameter: 2"	US26	1,266.65	-		
Projection: 3-7/8"	US26D	1,266.65	022069		
Offset: 3"	US32D	1,153.25	040173		
Clearance: 2-5/8"					
CTC: 20"					
987P					
Double Curved Pull	US3	544.55	-	1	12
Base Diameter: 1-1/4"	US4	544.55	-		
Projection: 3"	US10B	544.55	038422		
Clearance: 2"	US15A	544.55	014457		
CTC: 20"	US26	544.55	080621		
Fasteners: 3/8 - 16 FPHMS with finish washers	US26D	544.55	017011		
	US32D	532.40	018215		
987B					
Double Curved Pull	US3	1,108.85	-	1	12
BTB Mounting	US4	1,108.85	-		
Base Diameter: 1-1/4"	US10B	1,108.85	062018		
Projection: 3"	US15A	1,108.85	080604		
Clearance: 2"	US26	1,108.85	083130		
CTC: 20"	US26D	1,108.85	025865		
	US32D	1,084.60	022332		
988P					
Offset Pull	US3	295.10	-	1	12
Projection: 3"	US26	295.10	-		
CTC: 24"	US32D	295.10	032028		
Fasteners: 3/8 - 16 FPHMS with finish washers					

1. Items with the price in **bold and red** are Quick Ship items and ship in 24 hours.
Please use stock number when ordering. 2. U/M is each unless otherwise noted.



Trim & Auxiliary



Description	Finish	2018 List	Stock No.	Box Qty.	Case Qty.
988B					
Offset Pull	US3	609.90	-	1	12
BTB Mounting	US26	609.90	-		
Projection: 3"	US32D	609.90	032030		
CTC: 24"					
990P					
18° Pull Bar - Handed					
Pull Diameter: 1"					
O/A Height: 25"					
Projection: 2-3/4"					
Clearance: 1-3/4"					
CTC: 24"					
Specify handing					
Fasteners: 3/8 - 16 FPHMS with finish washers					
Left Hand	US3	680.10	-	1	12
	US4	680.10	-		
	US10B	680.10	-		
	US15A	680.10	-		
	US26	680.10	-		
	US26D	680.10	097531		
	US32D	611.35	078681		
Right Hand	US3	680.10	-	1	12
	US4	680.10	-		
	US10B	680.10	098837		
	US15A	680.10	-		
	US26	680.10	-		
	US26D	680.10	097700		
	US32D	611.35	078682		



Description	Finish	2018 List	Stock No.	Box Qty.	Case Qty.
990B					
18° Pull Bar - Handed					
BTB Mounting					
Pull Diameter: 1"					
O/A Height: 25"					
Projection: 2-3/4"					
Clearance: 1-3/4"					
CTC: 24"					
Specify handing					
Left Hand	US3	1,379.95	-	1	12
	US4	1,379.95	-		
	US10B	1,379.95	055038		
	US15A	1,379.95	-		
	US26	1,379.95	-		
	US26D	1,379.95	105210		
	US32D	1,242.55	124116		
Right Hand	US3	1,379.95	-	1	12
	US4	1,379.95	-		
	US10B	1,379.95	054966		
	US15A	1,379.95	-		
	US26	1,379.95	-		
	US26D	1,379.95	105211		
	US32D	1,242.55	124120		
1442					
Roller Latch with Full Lip Strike	US3	32.35	070478	1	12
Material: Forged brass	US4	45.70	011444		
Latch Face: 1" x 3-3/8"	US10	45.70	011442		
Strike: 1-11/16" x 2-1/4" x 5/32" thick	US10B	34.45	070462		
Max Roller Projection: 3/8"	US15	38.35	060770		
Fasteners: #8 x 1" FPHWS; 8 - 32 x 3/4" FPHMS; #10 x 1-1/2" FPHWS	US15A	61.65	054026		
Non-Ferrous Version available on US3, US10B, US15, and US26D with extended lead time and 500 piece MOQ- 13.85 adder (NF) comp	US19	61.65	054513		
	US26	33.95	064292		
	US26D	27.45	011443		
1443					
Roller Latch w/ ASA Strike	US3	35.50	061158	1	12
Material: Forged brass	US4	47.75	-		
Latch Face: 1" x 3-3/8"	US10	-	-		
Strike: 1-1/4" x 4-7/8" w/ 5/8" Lip	US10B	40.45	061159		
Strike Thickness: .093"	US15	53.60	060765		
Max Roller Projection: 3/8"	US15A	61.65	054032		
Fasteners: 12 - 24 x 1/2" FPHMS; #12 x 3/4" FPHWS; #10 x 1-1/2" FPHWS	US19	61.65	054515		
	US26	45.70	088079		
	US26D	30.20	011446		
2610					
Finger Pull	US3		013049	-	500
Material: Brass	US4		071953		
Overall Diameter: 31/32"	US5		067282		
Finger Pull Diameter: 3/4"	US10A		068711		
Pull Clearance: 5/16"	US15		040589		
Projection: 1/32"	US15A		040590		
	US26		013047		
	US26D		071169		



1. Items with the price in **bold and red** are Quick Ship items and ship in 24 hours. Please use stock number when ordering. 2. U/M is each unless otherwise noted.



Trim & Auxiliary



Description	Finish	2018 List	Stock No.	Box Qty.	Case Qty.
2620					
Round Flush Pull	US3		013081	-	50
Material: Brass	US4	See Sliding	072997		
Overall Diameter: 2-1/16"	US5	Door	072148		
Finger Pull Diameter: 1-11/16"	US10A	Hardware	072534		
Pull Clearance: 11/32"	US15	Section for	072624		
Projection: 5/64"	US15A	Pricing	072158		
	US26		072554		
	US26D		075322		



2630					
Round Flush Pull	US3		051919	-	50
Material: Brass	US4	See Sliding	073783		
Overall Diameter: 2-7/16"	US5	Door	053163		
Finger Pull Diameter: 2-1/16"	US10A	Hardware	073053		
Pull Clearance: 11/32"	US15	Section for	073056		
Projection: 3/32"	US15A	Pricing	054307		
	US26		023430		
	US26D		023431		



2640					
Oblong Flush Pull	US3		096760	-	50
Material: Brass	US4	See Sliding	075056		
Size: 1-5/16" x 2-3/4"	US5	Door	074270		
Cup Clearance: 5/16"	US10A	Hardware	074533		
Fasteners: #6 x 5/8" OPHWS	US15	Section for	074711		
	US15A	Pricing	074350		
	US26		026751		
	US26D		074664		



9558					
Wood Knob	Wood	See Sliding Door	096567	-	100
Knob Diameter: 1-1/2"		Hardware Section			
Base Diameter: 15/16"		for Pricing			
Fasteners: #8 x 1-3/4" PPHWS					



9566					
Knob	US3		099824	-	100
Material: Zinc	US4	See Sliding	098635		
Knob Diameter: 1-1/4"	US5	Door	028859		
Projection: 1"	US10A	Hardware	098634		
Fasteners: #8 - 32 x 2" PPHMS;	US10B	Section for	098633		
#8 - 32 x 1-3/4" PPHMS	US15	Pricing	098632		
	US15A		098629		
	US26		098628		
	US26D		098627		



9567					
Rose - For use with 9566 knob	US3		099825	-	100
Material: Zinc	US4	See Sliding	098626		
Base Diameter: 1-3/4"	US5	Door	018102		
Projection: 15/32"	US10A	Hardware	098625		
Fasteners: #8 - 32 x 2" PPHMS;	US10B	Section for	098624		
#8 - 32 x 1-3/4" PPHMS	US15	Pricing	098623		
	US15A		098622		
	US26		098621		
	US26D		098620		





Description	Finish	2018 List	Stock No.	Box Qty.	Case Qty.
9865 Plastic Pull Overall Diameter: 1-31/32" Finger Pull Diameter: 1-19/32" Pull Clearance: 11/32" Projection: 5/64"	Plastic	1.00	098993	-	100
9882 Pocket Door Edge Pull Material: Brass Finger Pull Extends: 3/4" Faceplate: 3/4" x 3-7/8" Fasteners: #6 x 5/8" FPHWS Note: See Sliding Door section for pricing and multiplier.	US3 US4 US10 US10B US26 US26D	14.60 17.65 14.60 17.65 17.65 17.65	049582 049583 049578 049580 049579 049581	-	100
9884 Pocket Door Edge Pull Material: Zinc Finger Pull Extends: 1-1/16" Faceplate: 21/32" x 3-1/2" Fasteners: #6 x 5/8" FPHWS Note: See Sliding Door section for pricing and multiplier.	US3	See Sliding Door Hardware Section for Pricing	099056	-	20
208 Kick Down Door Holder Material: Aluminum alloy Base: 1-5/8" x 1-7/8" Arm: 3-7/8" Fasteners: #6 x 3/4" FPHWS	US15A/AN US26 US26D	6.80 6.80 6.80	039115 001104 075679	5	50 780
209 Floor Door Stop Material: Zinc Height: 1-1/4" Base Diameter: 1-3/32" Tip Diameter: 19/32" Fasteners: #8 x 2" FPHWS U/M - 1 each	US26 US3	1.15 1.15	76165 76168	5	50 780

1. Items with the price in **bold and red** are Quick Ship items and ship in 24 hours.
Please use stock number when ordering. 2. U/M is each unless otherwise noted.



Trim & Auxiliary



Description	Finish	2018 List	Stock No.	Box Qty.	Case Qty.	Disc Code
210						
Door Stop - Rigid	US3	1.90	076443	5	50	780
Material: Zinc	US4	1.65	078852			
Projection: 3"	US5/ABA	1.75	078854			
Base Diameter: 1"	US10A	1.75	075736			
Tip Diameter: 11/16"	US10R	1.75	097367			
Fasteners: #8 x 5/8" wood thread	US15A/AN	1.75	039117			
U/M - 1 each	US15	1.75	039118			
	US26	1.70	076171			
	US26D	1.90	076170			



211						
Door Stop - Flexible	US3	1.50	076206	10	100	780
Material: Zinc	US4	1.25	001109			
Projection: 3-1/8"	US5/ABA	1.65	053162			
Base Diameter: 1"	US10A	1.65	076199			
Tip Diameter: 9/16"	US10R	1.65	097368			
Fasteners: #8 x 3/4" PPHWS	US15A/AN	1.65	039126			
U/M - 1 each	US15	1.65	039121			
	US26	1.35	076205			
	US26D	1.50	076203			



212						
Hinge Pin Door Bumper	US3	2.00	056477	10	100	780
Material: Zinc	US4	1.90	023084			
U/M - 1 each	US5/ABA	2.00	023083			
Adjustable from 180° to 120°	US10A	1.65	076219			
For use with residential hinges	US10R	1.65	097369			
Works with 1/4" hinge pins	US15A/AN	2.00	034530			
	US15	1.95	034492			
	US26	1.50	076221			
	US26D	1.50	076220			



1412						
Door Guard	US3	8.55	056475	5	50	780
Arm Length: 4"	US10A	6.60	076222			
Material: Zinc	US15A/AN	6.60	035285			
Fasteners: #6 x 3/4" FPHWS	US15	6.60	035279			
U/M - 1 each with screws	US26	6.60	011431			
	US26D	8.55	076223			



1413						
Flush Bolt - Square Corners	US3	8.65	051915	10	100	780
Material: Brass w/ steel components	US4	8.65	055562			
Bolt Diameter: 1/2"	US5/ABA	10.60	051916			
Bolt Throw: 15/16"	US10A	10.60	055563			
Faceplate: 3/4" x 6"	US10R	10.60	072931			
Backset: 7/16"	US15A/AN	10.60	035457			
Strike: 7/8" x 1-3/4"	US15	8.65	035457			
Fasteners: #6 x 3/4" FPHWS	US26	8.65	055568			
U/M - 1 each with screws	US26D	8.65	055561			



Description	Finish	2018 List	Stock No.	Box Qty.	Case Qty.	Disc Code
1414						
Flush Bolt	US3	8.65	0519177	10	100	780
Material: Brass w/ steel components	US5/ABA	10.60	051918			
Bolt Diameter: 1/2"	US10A	10.60	055586			
Bolt Throw: 15/16"	US10R	10.60	097374			
Faceplate: 3/4" x 6"	US15A/AN	10.60	040832			
Backset: 7/16"	US15	8.65	040830			
Strike: 7/8" x 1-3/4"	US26	8.65	055570			
Fasteners: #6 x 3/4" FPHWS	US26D	8.65	055589			
Strikeplate and screws, U/M - 1 each						



1415						
Strike Plate	US3	2.00	081300	100	500	780
Material: Brass	US10A	2.00	081308			
Size: 7/8" x 1-3/4"	US15A/AN	2.00	081311			
Fasteners: #6 x 3/4" FPHWS	US15	2.00	081305			
U/M - 1 each with screws	US26D	2.00	081307			



1416						
Flush Bolt - Single Route	US3	10.25	078952	10	100	780
Material: Brass w/ steel components	US4	10.25	076239			
Bolt Diameter: 5/16"	US5/ABA	12.15	076225			
Backset: 3/8"	US10A	12.15	076236			
Faceplate: 3/4" x 7-1/8"	US10R	12.15	097375			
Strike: 21/32" x 1-1/2"	US15A/AN	12.15	035990			
Bolt Throw: 7/8"	US15	12.15	036004			
Fasteners: #8 x 1-1/2" FPHWS; #6 x 3/4" FPHWS	US26	10.25	076238			
U/M - 1 each with strikeplate and screws	US26D	10.25	076237			



1418						
Flush Bolt with Extension Rod	US3	12.05	068407	10	100	780
Material: Brass w/ steel components	US4	12.05	068337			
Bolt Diameter: 5/16"	US5/ABA	12.05	068263			
Backset: 3/8"	US10A	13.85	068467			
Faceplate: 23/32" x 7-3/8"	US10R	13.25	072930			
Strike: 5/8" x 1-1/2"	US15A/AN	13.85	068249			
Bolt Throw: 3/4"	US15	12.05	068448			
Extended Rod Length: 16"	US26	12.05	068447			
Fasteners: #8 x 1-1/2" FPHWS; #6 x 3/4" FPHWS	US26D	12.05	068436			
U/M - 1 each wit						







1419						
Flip/Foot Bolt Flush Bolt	US3	9.60	019228	10	100	485
Material: Brass with steel components	US4	9.60	019227			
Faceplate: 3/4" x 7-1/8"	US5/ABA	12.05	019224			
Strike: 5/8" x 1-1/2"	US10A	12.05	019627			
Bolt Diameter: 5/16"	US10R	12.05	019212			
Bolt Throw: 3/4"	US15A/AN	9.60	019216			
Backset: 5/16"	US15	9.60	019231			
Fasteners: #8 x 1-1/2" FPHWS; #6 x 3/4" FPHWS	US26	9.60	019230			
U/M - 1 each	US26D	9.60	019229			

1. Items with the price in **bold and red** are Quick Ship items and ship in 24 hours.
Please use stock number when ordering. 2. U/M is each unless otherwise noted.



Trim & Auxiliary

	Description	Finish	2018 List	Stock No.	Box Qty.	Case Qty.	Disc Code
	1439 Magnetic Catch Material: Plastic Catch: 1-1/16" x 2" Strike: 7/8" x 1" Fasteners: #6 x 1/2" TPHWS; #4 x 1/2" FPHWS U/M - 1 each with screws	-	2.00	011439	25	100	780
	1446 Ball Catch Material: Zinc Faceplate: 1" x 2-1/4" Strike: 1-3/8" x 2-1/4" Fasteners: #6 FPHWS U/M - 1 each with two strikeplates and screws	US3 US4 US5/ABA US10A US10R US15A/AN US15 US26 US26D	3.85 3.85 4.35 4.35 4.35 4.35 4.35 3.85 3.85	051902 055624 051903 055634 097376 036870 036878 055635 055608	10	50	780
	1447 Drive in Ball Catch Material: Zinc Faceplate: 1" diameter Strike: 1-3/8" x 2-1/4" Fasteners: #6 FPHWS U/M - 1 each with 2 strikeplates and screws	US3 US4 US5/ABA US10A US10R US15A/AN US15 US26 US26D	3.50 3.85 4.35 4.35 4.35 4.35 4.35 3.50 3.85	043896 055638 055636 055639 097377 037445 036882 055640 055637	10	50	780
	1448 Strike Plate for 1446 or 1447 Size: 1-3/8" x 2-1/4" Fasteners: #6 FPHWS U/M - 1 each with screws	US3 US4 US5/ABA US10A US10R US15A/AN US15 US26 US26D	2.00 2.00 2.00 2.00 2.00 2.00 2.00 2.00 2.00	079333 079334 079351 079339 097378 079340 079335 079337 079338	100	500	780
	1449 Drive In Ball Catch for 1448 Material: Zinc Faceplate: 1" diameter U/M - 1 each	US4	1.75	101876	100	300	780



Description	Finish	2018 List	Stock No.	Box Qty.	Case Qty.	Disc Code
1755						
115° One Way Door Viewer	US3	6.10	056866	10	100	490
UL Listed	US4	6.10	011919			490
U/M - 1 each	US5/ABA	6.00	076270			780
90 min. fire rated	US10A	6.00	076272			780
Door Thickness: 1-3/8" - 2-1/8"	US10R	6.00	097475			780
	US15A/AN	6.00	076271			780
	US15	6.00	076276			780
	US26	5.85	076274			780
	US26D	5.90	055225			490



1756						
185° One Way Door Viewer	US3	9.20	011920	-	50	490
UL Listed	US4	9.20	066884			490
U/M - 1 each	US5/ABA	13.75	072679			780
90 Minute Fire-Rated	US10A	13.75	076442			780
Door Thickness: 1-3/8" - 2-1/8"	US10R	13.75	097476			780
	US15A/AN	13.75	076441			780
	US15	13.75	067422			780
	US26	13.60	044337			780
	US26D	9.55	086149			490



1758						
115° One Way Door Viewer with Privacy Flap	US3	9.70	146215	10	100	490
Door Thickness: 1-3/8" - 2-1/8"	US10A	9.45	146216			780
UL Listed	US26	9.45	146217			780
U/M - 1 each	US26D	9.40	146218			490
90 Minute Fire-Rated						



1759						
185° One Way Door Viewer with Privacy Flap	US3	12.60	146219	-	50	490
Door Thickness: 1-3/8" - 2-1/8"	US10A	17.95	146220			780
UL Listed	US26	17.95	146221			780
U/M - 1 each	US26D	12.25	146222			490
90 Minute Fire-Rated						



1765						
Privacy Flap for 115° One Way Viewer 1755	US3	4.70	146207	1	200	490
	US10A	4.20	146208			780
	US26	4.20	146209			780
	US26D	4.70	146210			490



1766						
Privacy Flap for 185° One Way Viewer 1756	US3	5.40	146211	1	200	490
	US10A	5.00	146212			780
	US26	5.00	146213			780
	US26D	5.25	146214			490

1. Items with the price in **bold and red** are Quick Ship items and ship in 24 hours.
Please use stock number when ordering. 2. U/M is each unless otherwise noted.



Trim & Auxiliary



Description	Finish	2018 List	Stock No.	Box Qty.	Case Qty.	Disc Code
BL6209 Floor Door Stop Height: 1-3/8" Base Diameter: 13/16" Tip Diameter: 1/2" Fastener: #8 x 11/32" thread U/M - 1 each	US26D/ABA	1.05	056231	-	150	780





Description	Finish	2018 List	Stock No.	Box Qty.	Case Qty.	Disc Code
BL6211						
Door Stop Flexible	US3	0.90	056256	-	150	780
Projection: 3"	US4	0.80	058289			
Tip Diameter: 7/16"	US5/ABA	0.85	058295			
Base Diameter: 3/4"	US10A	0.85	056269			
Fastener: #8 x 1 1/32" thread	US10R	0.85	097482			
U/M - 1 each	US15	0.85	040032			
	US26D	0.85	040031			



BL6212						
Hinge Pin Door Bumper	US3	1.10	056320	-	100	780
U/M - 1 each	US4	1.05	058298			
Adjustable from 180° to 120°	US5/ABA	1.05	058296			
For use with residential hinges	US10A	1.05	056321			
Works with 1/4" hinge pins	US10R	1.05	097483			
	US15A/AN	1.05	056315			
	US15	1.05	040033			
	US26	1.10	056323			
	US26D	1.05	040035			

1. Items with the price in **bold and red** are Quick Ship items and ship in 24 hours.
 Please use stock number when ordering. 2. U/M is each unless otherwise noted.



Series



Description	Finish	2018 List	Stock No.	Box Qty.	Case Qty.	Disc Code
6601						
Handrail Bracket	US3	2.15	011385	-	300	780
Material: Cast Aluminum	US4	2.15	011380			
Base to Center of Rail: 2-3/4"	US5/ABA	2.75	011328			
Projection: 3-1/4"	US10A	2.90	011374			
Fasteners: #8 x 1-1/2" OPHWS; #8 x 3/4" OPHWS	US10R	2.90	011371			
U/M - 1 each with screws	US15A/AN	2.75	011327			
	US15	2.75	011335			
	US26	2.15	011332			
	US26D	2.75	011331			



BL6610						
Coat & Hat Hook	US3	1.05	056300	-	100	780
Max. Projection: 2-13/16"	US4	1.00	058317			
Min. Projection: 1-5/16"	US5/ABA	1.05	058329			
Fastener: #6 x 3/4" FPHWS	US10A	1.05	056299			
U/M - 1 each with screws	US15	1.05	040045			
	US26	1.05	056298			
	US26D	1.05	040046			



BL6793						
Pole Sockets	2D	1.50	013512	-	100	780
Material: Steel						
U/M - 2 each with screws						



BL6794						
Pole Sockets		0.90	013514	-	100	780
Material: Plastic						
U/M - 2 each with screws						



One Family. One Brand. One Vision.™

www.hagerco.com

TABLE OF CONTENTS

A		I	
Astragal	21, 23-27	Interlocking Thresholds	12
Acoustic Pad	15	Interlocking Weatherstripping	15
B		Intumescent Weatherstripping	15-17
Barrier Free Ramps	9	J	
Bumper Thresholds	9-10	Jamb Weatherstripping	
Bumper/Stop Strips	10	Jamb Weatherstripping	22-23, 25-27
C		Adjustable	25
Carpet Thresholds	10-11	Magnetic	25
Cast Abrasive Aluminum Thresholds		L	
Saddle Thresholds	13-14	Lead Times	5
Cover Plate	14-15	M	
D		Materials and Finishes	2
Door Bottoms		P	
Automatic Door Bottoms	19	Panic Thresholds	11-12
Door Shoes	21-22, 28-29	Press-On Weatherstripping	15-18
Door Sweeps	20-21, 23, 26-27	Product Information	2
Rain Drip	21-23	R	
E		Rain Drips	
Edge Sealing Systems	15-18	DoorBottom Rain Drip	21-22
Elevator	10	Overhead Rain Drip	23
F		Replacement Inserts	4
Fabrication Options	5	Residential Thresholds	6-7
Fasteners	2	S	
Fastener Options	3	Smoke Seals	15-18
Finish Options	2,5	Saddle Thresholds	6-10, 13-14
Fire Labeling	2	Stock Numbers	29-43
Floor Closer Thresholds	13-14	Sure-Step	5
Floor Plates and Supports	9-10	T	
G		Thermal Barrier Thresholds	
Garage Weatherstripping	22	Saddle Thresholds	7-9
H		Panic Thresholds	11-12
Half Saddle Thresholds	6, 8-9, 12	W	
How to Order	3	Water Return - Interlocking	12



Thresholds & Weatherstripping

PRODUCT INFORMATION

Drawings or illustrations used in the Price Book are subject to change without notice. Questions regarding any dimensions should be directed to Hager Companies Customer Service.

MATERIALS AND FINISHES

Metals

All aluminum extrusions are of alloy 6063-T5. For stock finishes, refer to the code listed below each individual item throughout the price book. Please inquire for the availability on non-stock finishes.

MIL-	Mill Finish Aluminum	LBA -	Light Bronze Anodized Aluminum
300-	Polished Bronze (CDA385)	GYP-	Primed Steel (Grey)
CAL-	Cast Aluminum	BLA-	Black Anodized Aluminum
DBA-	Dark Bronze Anodized Aluminum	32D-	Matte Stainless Steel (Non-Extruded)
SCA-	Hager Carb-Coat on Aluminum	WH-	White Paint on Aluminum
SCB-	Hager Carb-Coat on Bronze	CLR-	Clear Anodized Aluminum
GLD-	Gold Anodized Aluminum	BCA-	Bright Clear Anodized Aluminum
10B-	Antique Bronze, Oiled		

Gaskets

Gasketing is available in a wide variety of materials. Vinyl is an economical choice and remains flexible down to -40°F. Neoprene gasketing is supplied both as a solid (dense) and as a closed cell sponge with a tough outer skin, remaining flexible down to -50°F. Silicone gasketing provides the best resistance to cold by remaining flexible down to -70°F. To order gasket only, see how to order example on page 3.

B-	Nylon Brush (Black)	V-	Vinyl
N-	Neoprene, Solid EPDM	W-	Pile (Thread May Be Removed To Allow Expansion) (Grey)
	Closed Cell Sponge EPDM, TPE (Black)		
S-	Silicone		

Colors for Press-On Gasketing

- B - Brown
- S - Charcoal or Black
- T - Tan
- W - White
- G - Grey

FASTENERS

All products are furnished with appropriate fasteners as listed, except where noted. Most thresholds are furnished with mounting holes and #10 x 1-1/2" flat head sheet metal screws. Most weatherstripping products are furnished with slotted holes and #6 x 5/8" pan head sheet metal screws. Brass screws are furnished with bronze products.

FIRE LABELING

All products containing non-metallic seals have been listed and labeled resulting from a determination by a certified fire laboratory that these products do not adversely affect the fire resistance of the door or frame. All products are regularly checked under a labeling and listing inspection service.



HOW TO ORDER

When placing your order, please specify item number, gasket code, size and finish code. Also be sure to state any special fabrication needs or optional fasteners desired. Thresholds are fabricated in standard sizes with 1/2" extra on thresholds 50" and under. Thresholds over 50" are supplied with 1" extra length for fitting.

Example: 891S V 36 x 84 MIL

Item #	Gasketing	Size	Finish
516S	S-Silicone	36"	GLD
575S	W-Pile	48"	MIL
750S	N-Neoprene	36" x 84"	32D
802S	B-Nylon Brush	48" x 96"	MIL
885S	V-Vinyl	36" x 84"	DBA
881S*	N-Neoprene	48" x 84"	000

*Use Finish 000 to receive gasket only

Thresholds must be purchased and billed at 4" increments, except for Abrasive Cast Aluminum Thresholds and Automatic Door Bottoms. Weatherstripping must be purchased and billed at 4" increments. Threshold and weatherstripping products supplied in lengths up to 12'.

FASTENER OPTIONS

Thresholds

Add to List Price

#10 Wood Screws and Plastic Anchors.....	\$ 0.60 /ft
#10 Wood Screws and Lead Anchors	0.80 /ft
#10 Machine Screws and Lead Anchors.....	0.90 /ft
#10 S.S. Machine Screws and Lead Anchors	1.50 /ft
#10 S.S. Wood Screws	1.00 /ft
#10 S.S. Wood Screws and Plastic Anchors	1.40 /ft
#10 S.S. Wood Screws and Lead Anchors.....	1.60 /ft
#10 Torx Wood Screws	1.90 /ft
#10 S.S. Torx Wood Screws	2.90 /ft
#10 Torx Machine Screws.....	1.80 /ft
1/4-20 Machine Screws and Lead Anchors.....	1.30 /ft
1/4-20 S.S. Machine Screws and Lead Anchors.....	1.90 /ft
1/4-20 Flat Head Sleeve Anchor	2.40 /ft
1/4 Tap-Con Type (Self-Tapping Concrete).....	1.30 /ft
Cast-On Anchors (Cast Products Only)	8.00/ea
Thru-bolts 1/4 - 20 x 1-1/4" FPHM with 1-1/4" post	2.90 /ft

Note: Standard fasteners included: #10 x 1-1/2" Phillips flat-head sheet metal screws.

Weatherstripping

Add to List Price

#6 x 5/8" Phillips Pan-head Stainless Steel Screws.....	\$ 0.50 /ft
#6 x 5/8" Phillips Self-drilling (TEK) Screws	0.30 /ft
#6 x 5/8" S.S. Phillips Self-drilling (TEK) Screws	0.40 /ft
#6 x 5/8" Phillips Pan-head Torx Sheet Metal Screws.....	1.50 /ft
Two-way Self-adhesive Tape	1.40 /ft

Note: Standard fasteners included: #6 x 5/8" Phillips pan-head sheet metal screws.



Thresholds & Weatherstripping

REPLACEMENT INSERTS

Vinyl - Grey

List Price (Per Foot)

434S, 435S, 477S, 478S, 481S, 516S, 518S, 520S, 532S, 541S, 552S, 560S, 565S, 570S, 575S, 580S, 599S, 771S, 837S, 860S	0.80
756S, 770S, 884S	1.10
774S, 777S, 778S, 779S, 780S, 782S, 783S	1.30
881S, 885S, 890S, 891S, 896S	0.80

Vinyl - Black

Black inserts are supplied standard with DBA aluminum extrusions. Must specify on order for black replacement gaskets.

434S, 435S, 477S, 478S, 481S, 516S, 518S, 520S, 532S, 541S, 552S, 560S, 565S, 570S, 575S, 580S, 599S, 771S, 837S, 860S	0.80
881S, 885S, 890S, 891S, 896S	0.70

Silicone - Grey

434S, 435S, 477S, 478S, 481S, 516S, 518S, 520S, 532S, 541S, 552S, 560S, 565S, 570S, 575S, 580S, 599S, 771S, 837S, 860S	2.30
730S, 740S	4.70
750S	1.30
875S	1.50
881S, 885S, 890S, 891S, 896S	1.60

Silicone - Black

Black inserts are supplied standard with DBA aluminum extrusions. Must specify on order for black replacement gaskets.

434S, 435S, 477S, 478S, 481S, 516S, 518S, 520S, 532S, 541S, 552S, 560S, 565S, 570S, 575S, 580S, 599S, 771S, 837S, 860S	2.30
881S, 885S, 890S, 891S, 896S	1.60

Neoprene - Black

434S, 435S, 477S, 478S, 481S, 516S, 518S, 520S, 532S, 541S, 552S, 560S, 565S, 570S, 575S, 580S, 599S, 771S, 837S, 860S	2.10
730S, 740S, 864S, 870S, 872S*, 873S, 877S, 878S, 880S, 892S	1.30
743S, 747S, 861S	2.50
754S, 774S, 777S, 778S, 779S, 780S, 782S	1.30
750S, 753S, 785S, 862S, 863S	1.40
858S, 865S, 866S	3.60
871S, 874S, 875S	1.40
881S, 885S, 890S, 891S, 896S	1.00

Pile - Grey

434S, 435S, 477S, 478S, 516S, 518S, 520S, 532S, 541S, 552S, 560S, 565S, 570S, 575S, 580S, 599S, 728S, 771S, 789S, 837S, 845S, 847S	0.90
---	------

Nylon Brush - Black

770S, 800S, 802S, 882S, 883S	2.80
801S, 803S, 806S, 808S	5.60



FABRICATION OPTIONS

	Add to List Price
Bevel One Edge of Threshold.....	\$ 5.50 /ft
Rip One Edge (Width) of Threshold.....	5.50 /ft
L-Notch Both Ends of Threshold	10.50 /ea
L-Notch setup charge on less than 100 pieces	45.00
U-Notch Both Ends of Threshold.....	20.90 /ea
U-Notch setup charge on less than 100 pieces.....	75.00
Cast Abrasive Notching.....	POA
Tack Weld One Line of Threshold	POA
Pan for Water Return Threshold.....	1.00 /ft
End Caps for Automatic Door Bottoms (Mortised Models).....	DBA 7.20 /2 Caps
.....	GLD 7.20 /2 Caps
Lead Lining (Automatic Door Bottoms) - Up to 48".....	121.70

FINISH OPTIONS

	Add to List Price
Clear Anodized (CLR).....	Price on Application
Black Anodized (BLA).....	Price on Application
White Paint (WHP).....	Price on Application

SURE-STEP

	Add to List Price
Up to 4" Width	21.10 /ft
Up to 5" Width	26.40 /ft
Up to 6" Width	31.60 /ft
Up to 7" Width	37.00 /ft
Up to 8" Width	42.20 /ft

QUICK SHIP

Products denoted with **bold and red** in the stock number listing in the back of the pricing section are available to order through the QuickShip program and ship within 24 hours. When ordering these products please visit www.hagerco.com and log in to MyHager to access the 'Quick Ship' portal. Due to the promptness of the fulfillment process, Quick Ship orders are non-cancellable.

LEAD TIMES

Stock items will typically ship in five working days or less from the order entry date. Made-to-order items will typically ship in 15 working days depending on seasonal volume and order complexity. Special orders including industrials, special machining, and large quantities may need to be scheduled. The anticipated ship date will be included with each order acknowledgement. Please contact Customer Service if product availability is in question.

CANCELLATION NOTIFICATION

Cancellation for made-to-order items must be communicated within 48 hours of order placement.



Thresholds and Weatherstripping

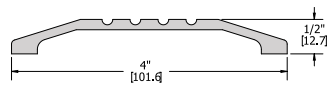
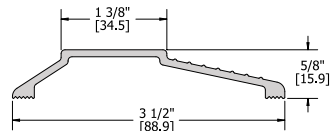
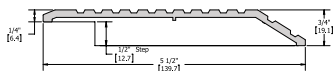
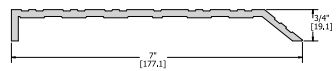
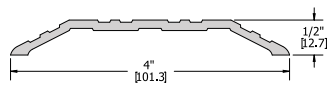
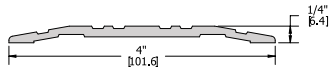
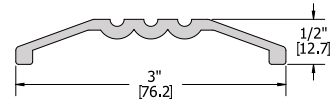
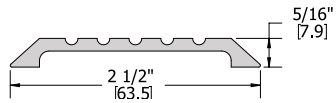

Description	Finish	Without Insert		With Insert		Comparison Numbers
		N	S	V	W	
401S Threshold - Saddle 2-1/2" x 5/16"	MIL		6.90			NGP: 211 Pemko: 166 ANSI: J32130
	DBA		9.50			
	GLD		11.00			
402S Threshold - Saddle 3" x 1/2"	MIL		7.10			Pemko: 169 ANSI: J32100
	DBA		9.70			
	GLD		11.30			
403S Threshold - Saddle 4" x 1/4"	MIL		7.00			NGP: 413 Pemko: 270 ANSI: J32130
	DBA		11.80			
	GLD		13.30			
404S Threshold - Saddle 4" x 1/2"	MIL		8.00			NGP: 424E NGP: 412SS Pemko: 170 ANSI: J32130
	DBA		11.70			
	GLD		12.90			
406S Threshold - Half Saddle 7" x 3/4"	MIL		23.10			NGP: 458 Pemko: 1877 ANSI: J33100
	DBA		24.90			
	GLD		27.20			
407S Threshold - Half Saddle 1/2" Step 5-1/2" x 3/4"	MIL		13.40			NGP: 655 Pemko: 157 ANSI: J33180
	DBA		20.70			
	GLD		23.00			
408S Threshold - Saddle 3-1/2" x 5/8"	MIL		6.30			Pemko: 212 ANSI: J30100
	DBA		8.90			
	GLD		10.10			
410S Threshold - Saddle 4" x 1/2"	MIL		8.10			NGP: 424 Pemko: 170 ANSI: J32130
	DBA		11.70			
	GLD		12.90			

Thresholds and Weatherstripping

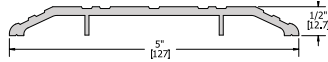

Description	Finish	Without Insert		With Insert			Comparison Numbers
		N	S	V	W		
412S Threshold - Saddle 5" x 1/2"	MIL		10.60				NGP: 425E NGP: 512SS Pemko: 171 ANSI: J32130
	DBA		15.50				
	GLD		16.90				

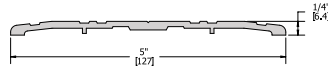

413S Threshold - Saddle 5" x 1/4"	MIL		10.10				NGP: 513 Pemko: 271 ANSI: J32130
	DBA		15.30				
	GLD		16.50				
	32D		132.60				

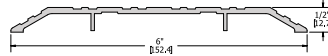

415S Threshold - Saddle 6" x 1/2"	MIL		13.20				NGP: 426 Pemko: 172 ANSI: J32130
	DBA		18.30				
	GLD		20.60				

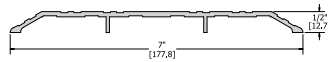

416S Threshold - Saddle 7" x 1/2"	MIL		17.40				NGP: 427 Pemko: 176 ANSI: J32130
	DBA		22.70				
	GLD		25.00				

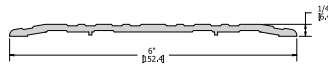

417S Threshold - Saddle 6" x 1/4"	MIL		12.70				NGP: 613 Pemko: 272 ANSI: J32130
	DBA		17.40				
	GLD		20.40				

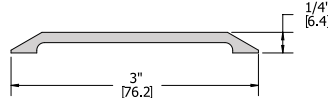

418S Threshold - Saddle 3" x 1/4"	MIL		7.30				NGP: 411 Pemko: 151 ANSI: J32330
	DBA		9.80				
	GLD		11.60				

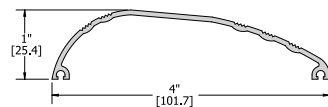

419S Threshold - Saddle 4" x 1"	MIL		7.00				Pemko: 219 ANSI: J30100
	DBA		8.70				
	GLD		9.70				

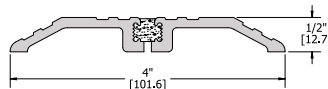

420S Threshold - Saddle Thermal Barrier 4" x 1/2"	MIL		15.00				NGP: 8424 Pemko: 252X2FG ANSI: J32193
	DBA		19.40				
	GLD		21.50				

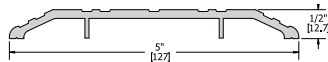

421S Threshold - Saddle Thermal Barrier 5" x 1/2"	MIL		16.80				NGP: 8425 Pemko: 252X3FG ANSI: J32193
	DBA		21.80				
	GLD		24.50				

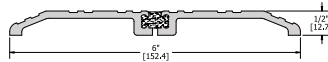

422S Threshold - Saddle Thermal Barrier 6" x 1/2"	MIL		18.90				NGP: 8426 Pemko: 253X3FG ANSI: J32193
	DBA		24.60				
	GLD		26.70				

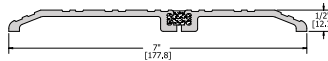

423S Threshold - Saddle Thermal Barrier 7" x 1/2"	MIL		20.60				NGP: 8427 Pemko: 253X4FG ANSI: J32193
	DBA		27.00				
	GLD		30.40				

Price Code: POA - Price on Application
 Insert Codes: V - Vinyl; N - Neoprene, EDPM, or TPE; S - Silicone; W - Pile; B - Nylon Brush; F - Vinyl Fin
 Finish Codes: MIL - Mill Finished Aluminum; DBA - Dark Bronze Anodized; GLD - Gold Anodized; Anodized; CAL - Cast Aluminum



Thresholds and Weatherstripping

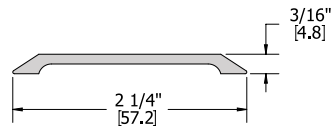
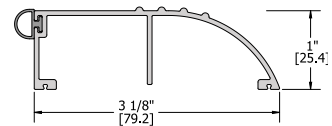
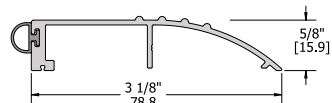
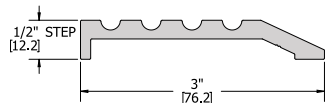
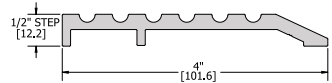
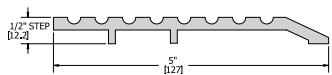
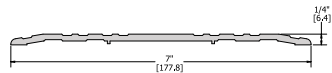
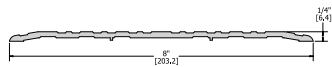
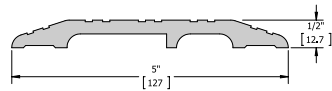
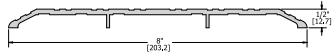
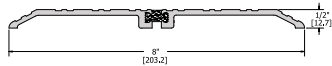

Description	Finish	Without Insert		With Insert			Comparison Numbers
		Insert	N	S	V	W	
424S Threshold - Saddle Thermal Barrier 8" x 1/2"	MIL	21.60					NGP: 8428 Pemko: 254X4FG ANSI: J32193
	DBA	29.00					
	GLD	31.70					
426S Threshold - Saddle 8" x 1/2"	MIL	21.50					NGP: 428E Pemko: 2548 ANSI: J32130
	DBA	28.70					
	GLD	33.00					
427S Threshold - Saddle Heavy Duty 5" x 1/2"	MIL	28.50					NGP: 425HD Pemko: 1715 ANSI: J32130
	DBA	37.50					
428S Threshold - Saddle 8" x 1/4"	MIL	20.20					NGP: 813 Pemko: 2748 ANSI: J32130
	DBA	26.70					
	GLD	31.20					
430S Threshold - Saddle 7" x 1/4"	MIL	17.30					NGP: 713 Pemko: 276 ANSI: J32130
	DBA	22.40					
	GLD	26.70					
431S Threshold - Half Saddle 5" x 1/2"	MIL	20.30					NGP: 325 Pemko: 229 ANSI: J33130
	DBA	27.80					
	GLD	31.30					
432S Threshold - Half Saddle 4" x 1/2"	MIL	17.90					NGP: 324 Pemko: 227 ANSI: J33130
	DBA	25.20					
	GLD	27.80					
433S Threshold - Half Saddle 3" x 1/2"	MIL	8.00					NGP: 322 Pemko: 168 ANSI: J33130
	DBA	10.40					
	GLD	12.70					
434S Threshold - Bumper Vinyl insert supplied unless other material specified 3-1/8" x 5/8"	MIL		8.00	8.00	6.10	6.10	Pemko: 205 ANSI: J30100
	DBA		10.20	10.20	7.60	7.60	
	GLD		11.60	11.60	8.80	8.80	
435S Threshold - Bumper Vinyl insert supplied unless other material specified 3-1/8" x 1"	MIL		9.60	9.60	7.20	7.20	Pemko: 2051 ANSI: J30100
	DBA		12.20	12.20	9.10	9.10	
	GLD		14.00	14.00	10.60	10.60	
436S Threshold - Saddle 2-1/4" x 3/16"	MIL	5.20					NGP: 410 Pemko: 173 ANSI: J32330
	DBA	7.70					



Thresholds and Weatherstripping

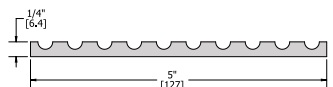
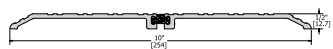
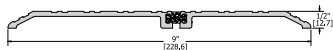
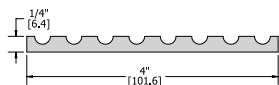
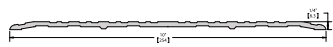
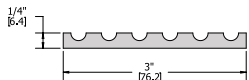
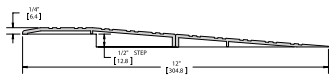
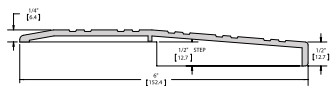
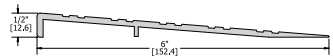
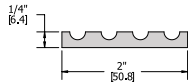
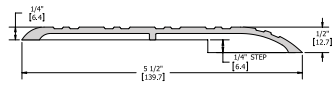

Description	Finish	Without Insert		With Insert			Comparison Numbers
		N	S	V	W		
438S Threshold - Half Saddle 1/4" Step 5-1/2" x 1/2"	MIL DBA	13.10 19.40				NGP: 653 Pemko: 158 ANSI: J32330	
440S Threshold - Floor Plate 2" x 1/4"	MIL DBA GLD	8.00 10.20 11.70				NGP: 8142 Pemko: 190 ANSI: J37100	
442S Threshold Barrier Free Ramp 1/2" Rise 6" x 1/2"	MIL DBA GLD	12.40 16.60 19.20				NGP: 657 Pemko: 259 ANSI: J38130	
443S Threshold Barrier Free Ramp 1/4" Rise 6" x 3/4"	MIL DBA GLD	14.10 18.70 21.30				Pemko: 257 ANSI: J30180	
444S Threshold Barrier Free Ramp 3/4" Rise 12" x 3/4"	MIL DBA GLD	29.50 36.20 42.40				NGP: R050 Pemko: 257X259 ANSI: J38183	
445S Threshold - Floor Plate 3" x 1/4"	MIL DBA GLD	10.80 14.70 17.00				NGP: 8143 Pemko: 191 ANSI: J37100	
448S Threshold - Saddle 10" x 1/4"	MIL DBA	26.90 34.80				NGP: 1013 ANSI: J37100 Pemko: 2750	
450S Threshold - Floor Plate 4" x 1/4"	MIL DBA GLD	14.60 19.20 20.20				NGP: 8144 Pemko: 192 ANSI: J37100	
451S Threshold - Saddle Thermal Barrier 9" x 1/2"	MIL DBA GLD	26.50 33.90 36.80				NGP: 8429 Pemko: 254X5FG ANSI: J32193	
452S Threshold - Saddle Thermal Barrier 10" x 1/2"	MIL DBA GLD	29.30 37.10 41.40				NGP: 8430 Pemko: 255X5FG ANSI: J32193	
455S Threshold - Floor Plate 5" x 1/4"	MIL DBA GLD	17.80 23.80 27.50				NGP: 8145 ANSI: J37100	

Price Code: POA - Price on Application
 Insert Codes: V - Vinyl; N - Neoprene, EDPM, or TPE; S - Silicone; W - Pile; B - Nylon Brush; F - Vinyl Fin
 Finish Codes: MIL - Mill Finished Aluminum; DBA - Dark Bronze Anodized; GLD - Gold Anodized; Anodized; CAL - Cast Aluminum



Thresholds and Weatherstripping

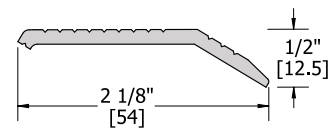
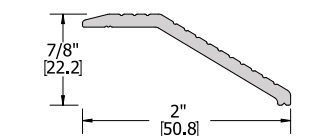
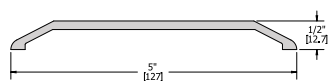
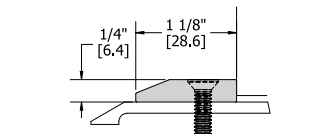
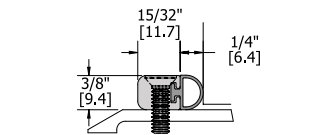
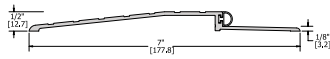
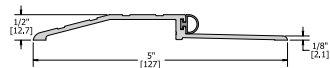
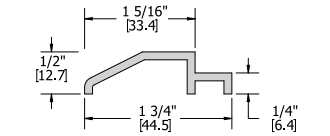
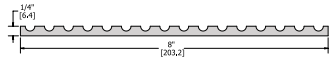
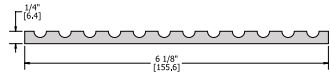

Description	Finish	Without Insert		With Insert			Comparison Numbers
		Insert	N	S	V	W	
460S Threshold - Floor Plate 6-1/8" x 1/4"	MIL	20.80					NGP: 8146 Pemko: 193 ANSI: J37100
	DBA	27.70					
	GLD	31.20					
465S Threshold - Floor Plate 8" x 1/4"	MIL	27.10					NGP: 8148 Pemko: 228 ANSI: J37100
	DBA	37.70					
	GLD	41.60					
470S Threshold Plate Support 1-3/4" x 1/2"	MIL	5.10					NGP: 8140 Pemko: 195
	DBA	7.30					
	GLD	8.10					
477S Threshold - Bumper 5" x 1/2"	MIL		12.30	12.90	11.60	11.60	NGP: 950 Pemko: 2001 ANSI: J36100
	DBA		16.10	17.20	15.40	15.40	
	GLD		17.60	18.20	16.90	16.90	
478S Threshold - Bumper 7" x 1/2"	MIL		18.20	19.00	17.30	17.30	ANSI: J30100
	DBA		23.90	24.60	22.90	22.90	
	GLD		25.10	26.20	24.20	24.20	
481S Threshold Bumper Strip 23/32" x 3/8"	MIL		6.00	6.30	5.40	5.40	NGP: 2 Pemko: 184
	DBA		7.80	8.20	7.00	7.00	
	GLD		9.00	8.70	8.50	8.50	
484S Threshold Bumper Strip 1-1/8" x 1/4"	MIL	5.20					NGP: 8136 Pemko: 196
	DBA	7.80					
	GLD	8.20					
492S Threshold - Saddle 5" x 1/2"	MIL	12.80					Pemko: 154 ANSI: J32330 Pemko: 2132
	DBA	16.00					
	GLD	18.50					
503S Threshold - Carpet Edge 2" x 7/8"	MIL	6.10					NGP: 416 ANSI: J32180 Pemko: 2134
	DBA	9.70					
	GLD	11.00					
504S Threshold - Carpet Edge 2-1/8" x 1/2"	MIL	8.30					NGP: 417 Pemko: 174 ANSI: J32183
	DBA	10.80					
	GLD	12.30					

Thresholds and Weatherstripping

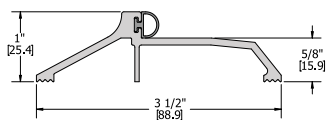
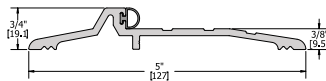
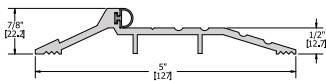
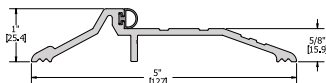
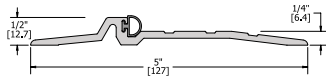
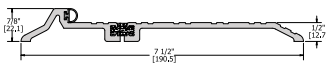
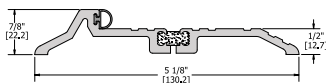
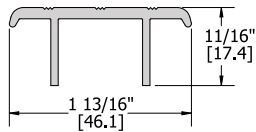
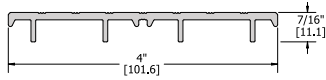
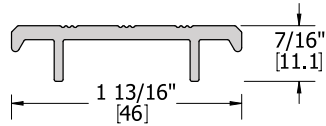

Description	Finish	Without Insert				With Insert			Comparison Numbers
		Insert	N	S	V	W			
505S Threshold - Carpet Divider 1-13/16" x 7/16"	MIL		5.60					NGP: 414	
	DBA		7.50					Pemko: 236	
	GLD		8.50					ANSI: J32113	
506S Threshold - Carpet Divider 4" x 7/16"	MIL		9.80					NGP: 404	
	DBA		13.30					Pemko: 2364	
	GLD		15.30					ANSI: J32113	
508S Threshold - Carpet Divider 1-13/16" x 11/16"	MIL		5.90					NGP: 414	
	DBA		7.70					Pemko: 236	
	GLD		8.30					ANSI: J32140	
516S Threshold - Panic Thermal Barrier 5-1/8" x 7/8"	MIL			18.80	18.80	17.90	17.90	NGP: 8435	
	DBA			25.00	25.00	23.30	23.30	Pemko: 253X226FG	
	GLD			26.30	26.30	25.10	25.10	ANSI: J36190	
518S Threshold - Panic Thermal Barrier 7-1/2" x 7/8"	MIL			23.80	23.80	22.50	22.50	NGP: 8437	
	DBA			31.70	31.70	29.90	29.90	Pemko: 255X226FG	
	GLD			34.90	34.90	34.10	34.10	ANSI: J36190	
520S Threshold - Panic 5" x 1/2"	MIL			11.90	11.90	11.00	11.00	NGP: 896	
	DBA			15.40	15.40	14.20	14.20	Pemko: 2005	
	GLD			17.10	17.10	15.80	15.80	ANSI: J36130	
532S Threshold - Panic 5" x 1"	MIL			14.60	14.60	13.50	13.50	NGP: 803	
	DBA			19.40	19.40	18.00	18.00	Pemko: 181	
	GLD			21.20	21.20	19.60	19.60	ANSI: J36100	
541S Threshold - Panic 5" x 7/8"	MIL			14.30	14.30	13.30	13.30	NGP: 804	
	DBA			19.30	19.30	18.90	18.90	Pemko: 177	
	GLD			21.40	21.40	21.40	21.40	ANSI: J36100	
552S Threshold - Panic 5" x 3/4"	MIL			14.10	14.10	13.40	13.40	NGP: 890	
	DBA			18.70	18.70	18.00	18.00	Pemko: 179	
	GLD			21.40	21.40	20.30	20.30	ANSI: J36100	
560S Threshold - Panic 3-1/2" x 1"	MIL			12.30	12.30	11.50	11.50	NGP: 891	
	DBA			17.20	17.20	16.10	16.10	Pemko: 185	
	GLD			19.10	19.10	17.90	17.90	ANSI: J36300	

Price Code: POA - Price on Application
 Insert Codes: V - Vinyl; N - Neoprene, EDPM, or TPE; S - Silicone; W - Pile; B - Nylon Brush; F - Vinyl Fin
 Finish Codes: MIL - Mill Finished Aluminum; DBA - Dark Bronze Anodized; GLD - Gold Anodized; Anodized; CAL - Cast Aluminum



Thresholds and Weatherstripping

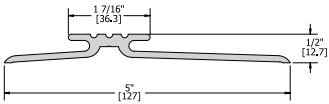
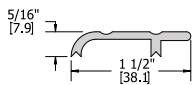
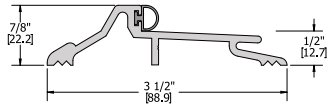
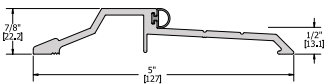
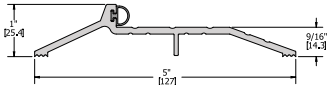
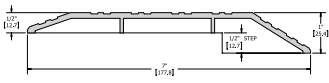
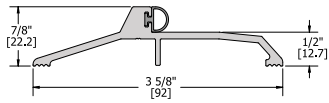

Description	Finish	Without Insert		With Insert		Comparison Numbers
		Insert	N	S	V	
565S Threshold - Panic 3-5/8" x 7/8"	MIL		12.60	12.60	11.70	Pemko: 1855 ANSI: J36300
	DBA		17.10	17.10	16.50	
	GLD		18.90	18.90	17.20	
572S Threshold - Half Saddle 1/2" Offset 7" x 1"	MIL	17.70				Pemko: 182 ANSI: J33180 NGP: 656
	DBA	24.00				
	GLD	28.40				
575S Threshold - Panic 5" x 1"	MIL		14.40	14.40	13.60	Pemko: 181 ANSI: J36100
	DBA		19.50	19.50	18.30	
	GLD		21.20	21.20	19.90	
580S Threshold - Panic 5" x 7/8"	MIL		16.80	16.80	16.10	NGP: 897 Pemko: 277 ANSI: J36100
	DBA		21.90	21.90	20.90	
	GLD		23.60	23.60	22.50	
599S Threshold - Panic 3-1/2" x 7/8"	MIL		13.90	13.90	13.30	Pemko: 159 ANSI: J36300
	DBA		19.70	19.70	18.50	
	GLD		19.20	19.20	20.20	
600S Threshold - Interlock Cap 1-1/2" x 5/16"	MIL	5.60				Pemko: 101 ANSI: J34170
	DBA	6.20				
	GLD	8.10				
604S Threshold - Interlock 5" x 1/2" *701S Interlocking Hook provided	MIL	13.80				Pemko: 114 ANSI: J34170
	DBA	17.20				

Thresholds and Weatherstripping

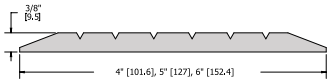

Description	Finish	Without Insert		With Insert			Comparison Numbers
		Insert	N	S	V	W	
626S Threshold - Saddle Cast Abrasive Aluminum 8' Max Length							ANSI: J37230
4" x 3/8"	CAL	96.40					
5" x 3/8"	CAL	115.70					
6" x 3/8"	CAL	134.90					

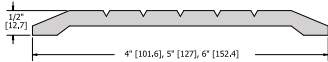

627S Threshold - Saddle Cast Abrasive Aluminum 8' Max Length							ANSI: J32230 NGP: 4425
4" x 1/2"	CAL	96.40					
5" x 1/2"	CAL	115.90					
6" x 1/2"	CAL	134.90					

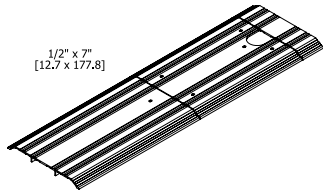

651S Threshold - Saddle for floor closers center hung without mitered end 7" x 1/2"							NGP: Type 1 Pemko: Type 11 ANSI: J39130
Up to 36"	MIL	137.90					
	DBA	153.90					
Up to 72"	MIL	274.90					
	DBA	307.60					
Lengths over 72" add the following per inch	MIL	1.70					
	DBA	2.00					

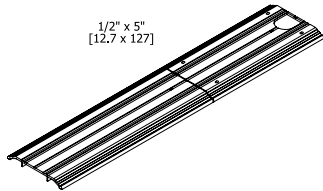

652S Threshold - Saddle for floor closers center hung without mitered end 5" x 1/2"							NGP: Type 1 Pemko: Type 11 ANSI: J39130
Up to 36"	MIL	110.50					
	DBA	123.30					
Up to 72"	MIL	225.00					
	DBA	251.10					
Lengths over 72" add the following per inch	MIL	1.70					
	DBA	2.00					

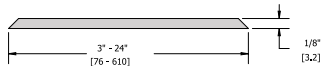

676S Cover Plate 8' Max. Length 1/8" Height	MIL	7.10					NGP: 818 Pemko: 18/1A ANSI: J17300
Charges: length X per foot charge X width in inches (3" min.) Example: 6 (ft. length) x \$7.10 (ft. list) x 6 (in. width)							

Price Code: POA - Price on Application
 Insert Codes: V - Vinyl; N - Neoprene, EDPM, or TPE; S - Silicone; W - Pile; B - Nylon Brush; F - Vinyl Fin
 Finish Codes: MIL - Mill Finished Aluminum; DBA - Dark Bronze Anodized; GLD - Gold Anodized; Anodized; CAL - Cast Aluminum



Thresholds and Weatherstripping

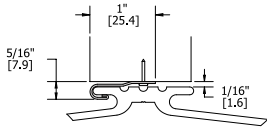
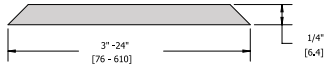

Description	Finish	Without Insert		With Insert			Comparison Numbers
		N	S	V	W		
677S Cover Plate 8' Max. Length 1/4" Height Charges: length X per foot charge X width in inches (3" min.) Example: 6 (ft. length) x \$11.40 (ft. list) x 6 (in. width)	MIL		11.40				NGP: 814 Pemko: 14/1A ANSI: J17300
701S Weatherstrip Interlock "J" Hook	MIL		3.50				NGP: 80 Pemko: 61 ANSI: ROY016

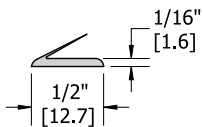
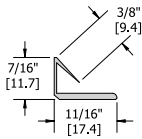
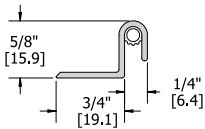
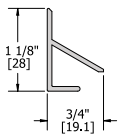
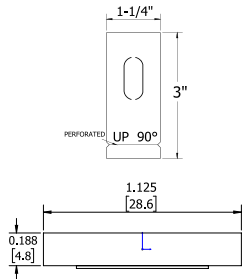

<p>709S Acoustic Foam Pad Pack of 10</p>	Black	26.50	NGP: 60FP
<p>710S Press-On Mullion Smoke Seal Sponge Neoprene Note: Available in 120" only</p>	Black	23.30/roll	NGP: 5100 Pemko: 5110 ANSI: ROC004
<p>717S Weatherstrip Interlock Overhead Rain Drip</p>	MIL DBA	4.00 6.40	NGP: 124 Pemko: 347 ANSI: R3Y106
<p>718S Weatherstrip Interlock Overhead w/ Vinyl</p>	MIL DBA	3.90 5.90	NGP: 123 Pemko: 68 ANSI: R3D036
<p>719 Press-on Weatherstrip Edge Sealing System & Smoke Seal Intumescent material</p>			NGP: 9450 ANSI: ROW154
7'	Brown	32.27	
8'	Charcoal	36.88	
9'		41.49	
3' x 7'		78.37	
4' x 7'		82.98	
4' x 8'		92.20	
6' x 7'		92.20	
7' x 7'		96.81	
<p>720 Press-on Weatherstrip Edge Sealing System & Smoke Seal Intumescent material</p>			NGP: 9850 Pemko: HSS2000XS44 ANSI: ROW154
3' x 7'	Brown	65.28	
4' x 7'	Charcoal	69.12	
4' x 8'	White	76.80	
6' x 7'		76.80	
7' x 7'		80.64	
6' x 8'		84.48	
8' x 8'		92.16	

Price Code: POA - Price on Application
 Insert Codes: V - Vinyl; N - Neoprene, EDPM, or TPE; S - Silicone; W - Pile; B - Nylon Brush; F - Vinyl Fin
 Finish Codes: MIL - Mill Finished Aluminum; DBA - Dark Bronze Anodized; GLD - Gold Anodized; Anodized; CAL - Cast Aluminum



Thresholds and Weatherstripping

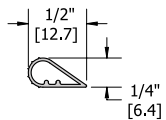
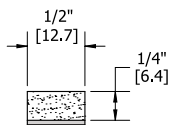
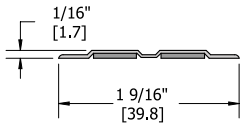
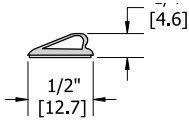
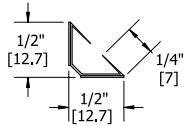

Description	Finish	Without Insert		With Insert		Comparison Numbers
		Insert	N	S	V	
721 Press-on Weatherstrip Smoke Seal TPE						NGP: 5020 ANSI: ROW154
7'	Brown	14.20				
8'	Gray	16.30				
9'	Charcoal	18.30				
3' x 7'	White	34.60				
4' x 7'		36.60				
4' x 8'		40.70				
6' x 7'		40.70				
7' x 7'		42.70				
722 Press-on Weatherstrip Edge Sealing System & Smoke Seal Intumescent material						HSS2000xs88 ANSI: ROW154 NGP: 9750
3' x 7'	Charcoal	65.80				
4' x 7'	Brown	69.70				
4' x 8'		77.50				
6' x 7'		77.50				
7' x 7'		81.30				
6' x 8'		85.20				
8' x 8'		93.00				
724 Press-on Weatherstrip Edge Sealing System Intumescent material						NGP: 9500 ANSI: ROW156
7'	Brown	38.90				
8'	Charcoal	44.40				
9'		50.00				
3' x 7'		94.40				
4' x 8'		111.10				
725 Press-on Weatherstrip Sponge Neoprene	Charcoal		0.95			Pemko: P493 ANSI: ROC156
726 Press-on Weatherstrip Smoke Seal						NGP: 5050 Pemko: S88 ANSI: ROE154
17'	Brown			24.30		
18'	Charcoal			26.50		
19'	Tan			27.50		
20'	White			28.60		
21'				30.90		
22'				32.40		
25'				36.80		
260'				363.30		
520'				726.60		



Thresholds and Weatherstripping

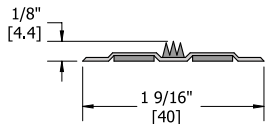
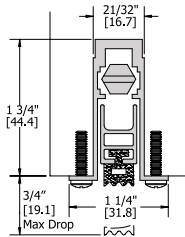
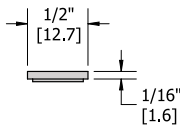
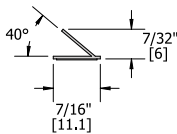
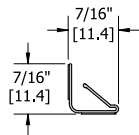

Description	Finish	Without Insert		With Insert			Comparison Numbers
		N	S	V	W		
727 Press-on Weatherstrip TPE material							NGP: PF180 ANSI: ROY156
7'	Charcoal		11.10				
8'			12.60				
3' x 7'			26.90				
4' x 8'			31.60				
728 Press-on Weatherstrip TPE							NGP: 5040 Pemko: S44 ANSI: R00154
17'	Charcoal			23.80			
20'				27.90			
21'				29.10			
25'				34.70			
260'				328.70			
520'				656.80			
729 Press-on Weatherstrip Edge Sealing System Intumescent material							NGP: 9800 Pemko: HSS2000 ANSI: ROW156
17'	Brown	32.50					
19'	Charcoal	36.20					
21'	White	40.10					
25'		47.70					
150'		280.40					
730S Automatic Door Bottom Mortise Application End Caps Furnished (max. drop 3/4")							NGP: 225 Pemko: 411 ANSI: R3Y326
12" to 23"	MIL		93.50	105.80			
24" to 36"	MIL		61.50	73.80			
37" to 48"	MIL		82.00	98.40			
49" to 60"	MIL		102.50	123.00			
734 Press-on Weatherstrip Edge Sealing System & Smoke Seal Intumescent material							NGP: 9550 ANSI: ROW154
7'	Brown	39.40					
8'	Charcoal	45.00					
9'		50.60					
3' x 7'		95.60					
6' x 7'		112.40					
8' x 8'		135.00					

Price Code: POA - Price on Application
 Insert Codes: V - Vinyl; N - Neoprene, EDPM, or TPE; S - Silicone; W - Pile; B - Nylon Brush; F - Vinyl Fin
 Finish Codes: MIL - Mill Finished Aluminum; DBA - Dark Bronze Anodized; GLD - Gold Anodized; Anodized; CAL - Cast Aluminum

Thresholds and Weatherstripping

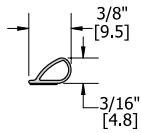

Description	Finish	Without Insert		With Insert		Comparison Numbers
		Insert	N	S	V	
736 Press-on Weatherstrip Smoke Seal						NGP: 2525 Pemko: PK33 ANSI: ROE154
17'	Charcoal			24.40		
18'	White			26.40		
19'				27.60		
20'				28.80		
21'				30.80		
22'				32.20		
25'				36.60		
260'				361.20		
520'				722.50		

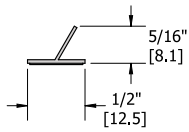

737 Press-on Weatherstrip Smoke Seal						NGP: 5060 Pemko: S77 ANSI: ROE154
17'	Charcoal			27.30		
18'				28.90		
19'				30.50		
20'				32.10		
21'				33.50		
22'				35.10		
25'				39.80		
260'				339.60		
520'				627.70		

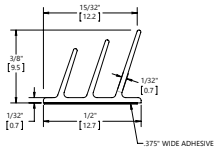

738 Press-on Weatherstrip Smoke Seal						NGP: 5075 Pemko: S773 ANSI: ROE154
17'	Charcoal			31.80		
18'				34.50		
20'				37.70		
21'				40.30		
22'				42.20		

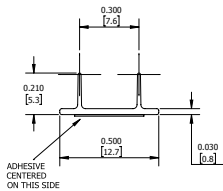

739 Press-on Weatherstrip Smoke Seal						NGP: 5070 Pemko: S772 ANSI: ROE154
17'	Brown			41.65		
18'	Clear			44.10		
19'				46.55		
20'				49.00		
21'				51.45		
22'				53.90		

Thresholds and Weatherstripping

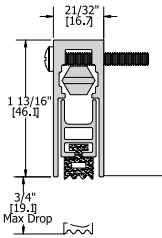

Description	Finish	Without Insert		With Insert		Comparison Numbers	
		Insert	N	S	V		
740S Automatic Door Bottom - Surface Applied End Caps Furnished (max. drop 3/4") 12" to 23"	CLR		101.00	114.00		NGP: 222 Pemko: 4131 ANSI: R3Y336	
	DBA		111.00	124.00			
	GLD		128.00	143.00			
	<hr/>						
	24" to 36"	CLR		68.75	81.50		
		DBA		78.50	91.75		
		GLD		96.00	111.00		
	<hr/>						
	37" to 48"	CLR		91.50	108.75		
		DBA		104.60	122.50		
		GLD		128.00	148.00		
	<hr/>						
49" to 60"	CLR		114.60	135.90			
	DBA		130.75	153.25			
	GLD		160.00	185.00			

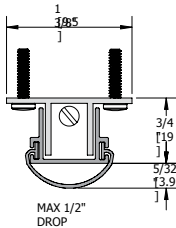

742S Automatic Door Bottom - Hollow Metal Door Application (max. drop 1/2") 24" to 36" 37" to 48" 49" to 60"	MIL			54.50		NGP: 320 Pemko: 420 ANSI: R3D326
	MIL			72.50		
	MIL			95.50		
	<hr/>					

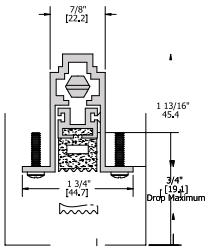

743S Automatic Door Bottom Mortise Application End Caps Furnished (max drop 3/4") 12" to 23" 24" to 36" 37" to 48" 49" to 60"	MIL		131.00			NGP: 422 Pemko: 434 ANSI: R3C326
	MIL		99.00			
	MIL		132.00			
	MIL		165.00			
	<hr/>					

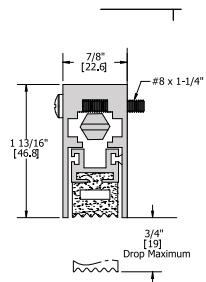

747S Automatic Heavy Duty Door Bottom - Surface Applied End Caps Furnished in Listed Furnishes (max. drop 3/4") 12" to 23" 24" to 36" 37" to 48" 49" to 60"	CLR		139.00			NGP: 420 Pemko: 4301 ANSI: R3C336	
	DBA		151.00				
	GLD		175.00				
	<hr/>						
	24" to 36"	CLR		106.50			
		DBA		118.50			
		GLD		143.75			
	<hr/>						
	37" to 48"	CLR		142.00			
		DBA		158.00			
		GLD		191.50			
	<hr/>						
	49" to 60"	CLR		177.50			
		DBA		197.50			
		GLD		239.50			

Price Code: POA - Price on Application
 Insert Codes: V - Vinyl; N - Neoprene, EDPM, or TPE; S - Silicone; W - Pile; B - Nylon Brush; F - Vinyl Fin
 Finish Codes: MIL - Mill Finished Aluminum; DBA - Dark Bronze Anodized; GLD - Gold Anodized; 32D - Matte Stainless Steel; GYP - Primed for Painting; CLR - Clear Anodized; CAL - Cast Aluminum



Thresholds and Weatherstripping

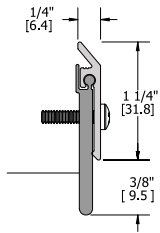

Description	Finish	Without Insert		With Insert		Comparison Numbers
		Insert	N	S	V	
750S Door Bottom - Sweep	CLR		4.50	6.70		NGP: 200 Pemko: 315 ANSI: R0Y436
	DBA		5.90	8.20		
	GLD		6.50	8.80		
	32D		27.30	30.30		

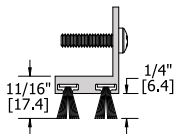

751S Door Bottom - Shoe	MIL		7.10		7.30	7.60	NGP: 317 ANSI: R0Y436
	DBA		8.60		9.00	9.30	
	GLD		9.60		9.40	9.50	

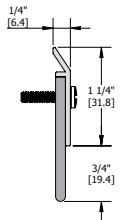

752S Door Bottom - Sweep	MIL				5.70		NGP: 102V ANSI: R3D436
	DBA				6.90		
	GLD				6.80		

#6 x 5/8" PAN HEAD SHEET METAL SCREWS (FACTORY PROVIDED)

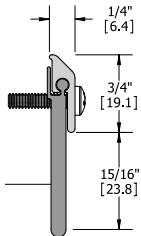

753S Door Bottom - Sweep	MIL		6.70				NGP: 114 Pemko: 3151 ANSI: R3B436
	DBA		7.70				
	GLD		8.30				

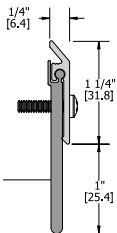

754S Door Bottom - Sweep	CLR		6.80				NGP: 197 Pemko: 3151 ANSI: R3B436
	DBA		8.90				
	GLD		9.60				

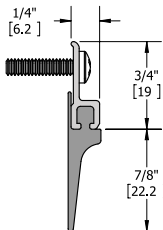

756S Door Bottom - Sweep or Astragal*	MIL				3.00		NGP: 97 Pemko: 307 ANSI: R3D434
	DBA				4.10		
	GLD				4.40		

*Order 2 for a set



Thresholds and Weatherstripping

Description	Finish	Without Insert		With Insert			Comparison Numbers
		Insert	N	S	V	W	

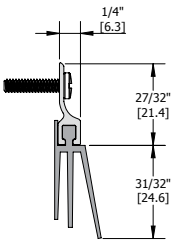

759S Door Bottom - Sweep	MIL				4.40		NGP: 96
	DBA				5.20		Pemko: 57
	GLD				5.70		ANSI: R3D436

Description	Finish	Without Insert		With Insert			Comparison Numbers
		Insert	B	S	V	W	

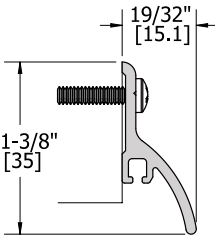

770S Door Bottom - Sweep w/ Rain Drip	MIL	2.70	6.50		4.30		NGP: 17
	DBA	4.80	8.00		5.70		NGP: 101
	GLD	5.30	8.20		6.30		NGP: C627 Pemko: 345 ANSI: R3Y534

Description	Finish	Without Insert		With Insert			Comparison Numbers
		Insert	N	S	V	W	

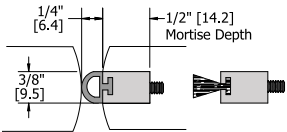

771S Astragal	MIL		10.30	10.70	9.90	9.50	NGP: 143
	DBA		11.30	11.70	10.80	12.10	Pemko: 300 ANSI: R3Y725

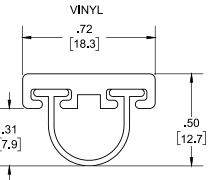

772S Door Bottom - Shoe or Astragal	MIL		6.40		6.60	6.30	NGP: 116
	DBA		7.90		8.10	7.10	Pemko: 313
	GLD		8.40		8.40	8.00	ANSI: R3Y726

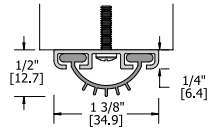

774S Door Bottom - Shoe or Astragal	MIL		4.20		3.50		NGP: 112
	DBA		5.50		4.50		Pemko: 234 ANSI: R3Y725

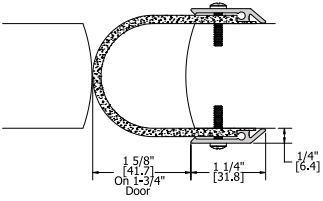

776S Door Bottom - Shoe or Astragal 1-3/4" Door	CLR		11.90				NGP: 14RA
	DBA		14.10				ANSI: R3C735

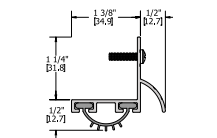

777S Door Bottom - Shoe w/ Rain Drip	MIL		6.10		5.10		NGP: 318
	DBA		7.90		6.60		Pemko: 210
	GLD		8.80		7.30		ANSI: R3D536

Price Code: POA - Price on Application
 Insert Codes: V - Vinyl; N - Neoprene, EDPM, or TPE; S - Silicone; W - Pile; B - Nylon Brush; F - Vinyl Fin
 Finish Codes: MIL - Mill Finished Aluminum; DBA - Dark Bronze Anodized; GLD - Gold Anodized; Anodized; CAL - Cast Aluminum

Thresholds and Weatherstripping

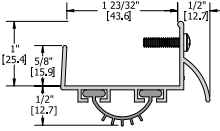
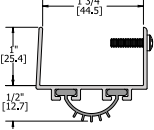
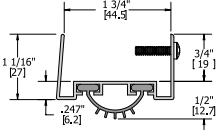
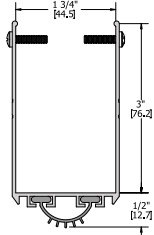
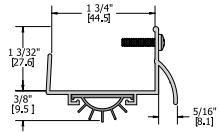
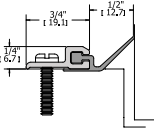
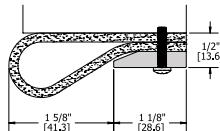
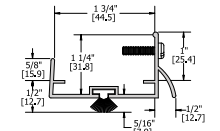
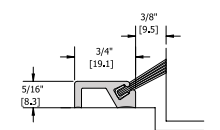
Description	Finish	Without Insert		With Insert		Comparison Numbers
		Insert	N	S	V	
 778S Door Bottom - Shoe w/ Rain Drip	MIL		6.10		5.10	NGP: 319E
	DBA		7.90		6.60	Pemko: 215
	GLD		8.80		7.30	ANSI: R3D536
 779S Door Bottom - Shoe	MIL		6.10		5.10	NGP: 36
	DBA		7.90		6.60	Pemko: 217
	GLD		8.80		7.30	ANSI: R3D436
 780S Door Bottom - Shoe	MIL		7.40		6.20	NGP: 35
	DBA		9.60		8.00	Pemko: 222
	GLD		10.80		9.00	ANSI: R3D436
 782S Door Bottom - Shoe	MIL		16.40		13.50	NGP: 99
	DBA		21.10		17.60	Pemko: 221
	GLD		22.60		20.30	ANSI: R3D436
 783S Door Bottom - Shoe w/ Rain Drip Low Profile	MIL				5.10	NGP: 319E
	DBA				7.20	ANSI: R3D536
	GLD				7.70	
 785S Jamb Weatherstrip up to 96"	MIL		4.30			NGP: 188
	DBA		6.20			ANSI: R3D164
	GLD		6.60			
 787S Garage Weatherstrip	MIL		37.60			NGP: 81369
						Pemko: E199
 789S Door Bottom Rain Drip	MIL					ANSI: R3F536
	DBA					9.20
	GLD					13.30
 800S Jamb Weatherstrip	MIL		5.50			NGP: A626A
	DBA		7.90			Pemko: 45041
	GLD		8.50			ANSI: R3F164



Thresholds and Weatherstripping

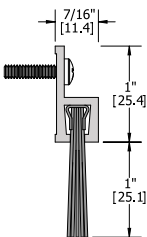

Description	Finish	B	N	With Insert			Comparison Numbers
				S	V	W	
801S Door Sweep or Jamb Weatherstrip or Astragal*	MIL	6.40					NGP: D608 Pemko: 18100 ANSI: R3D434
	DBA	8.30					
	GLD	8.40					
*Order 2 for a set							

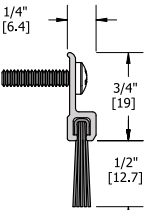

802S Door Sweep or Jamb Weatherstrip or Astragal*	MIL	4.10					NGP: B606 Pemko: 18061 ANSI: R3F164
	DBA	5.40					
	GLD	5.80					
*Order 2 for a set							

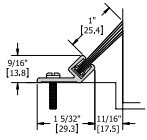

803S Jamb Weatherstrip	MIL	6.90					NGP: D620 Pemko: 45100 ANSI: R3F164
	DBA	8.20					
	GLD	8.80					

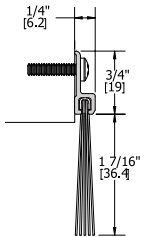

806S Door Sweep	MIL	9.10					Pemko: 18137 ANSI: R3F436
	DBA	13.10					
	GLD	13.60					

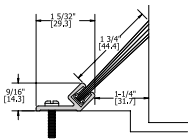

808S Jamb Weatherstrip	MIL	12.10					NGP: G622 Pemko: 45175 ANSI: R3F164
	DBA	16.90					
	GLD	17.30					

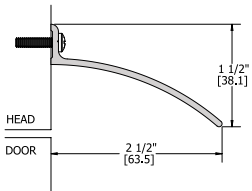

Description	Finish	Without Insert	N	With Insert			Comparison Numbers
				S	V	W	
810S Overhead Rain Drip	MIL	4.80					NGP: 16 Pemko: 346 ANSI: R3Y036
	DBA	6.50					
	GLD	7.50					

Price Code: POA - Price on Application
 Insert Codes: V - Vinyl; N - Neoprene, EDPM, or TPE; S - Silicone; W - Pile; B - Nylon Brush; F - Vinyl Fin
 Finish Codes: MIL - Mill Finished Aluminum; DBA - Dark Bronze Anodized; GLD - Gold Anodized; Anodized; CAL - Cast Aluminum



Thresholds and Weatherstripping

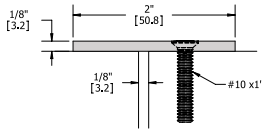

Description	Finish	Without Insert		With Insert			Comparison Numbers
		Insert	N	S	V	W	
835S Astragal - Bar Type 10' Max length	MIL	6.20					NGP: 139 Pemko: 357 ANSI: R0Y636
	DBA	7.90					
	GLD	8.90					
	GYP	6.40					
	32D	28.30					

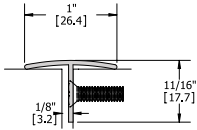

836S Astragal T-Type	MIL	5.30					NGP: 176 Pemko: 359 ANSI: R3Y616
	DBA	7.10					
	GLD	7.60					

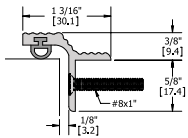

837S Astragal T-Type	MIL		7.00	7.30	6.00	6.00	NGP: 158 Pemko: 355 ANSI: R3Y714
	DBA		9.40	9.50	8.20	8.20	
	GLD		9.80	9.80	8.70	8.70	

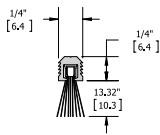

Description	Finish	B	N	With Insert			Comparison Numbers
				S	V	W	
839S Kerf-in Mortise Astragal Sweep *Brush insert	MIL	4.50					Pemko: 5041AP ANSI: R3A425

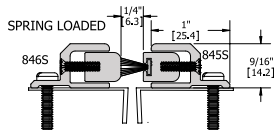

Description	Finish	Without Insert		With Insert			Comparison Numbers
		Insert	N	S	V	W	
845S Astragal - Surface Applied Adjustable Spring Loaded w/ Pile Must also order 846 for a set.	MIL						NGP: 140P Pemko: 351P ANSI: R3F834
	DBA					16.20	
	GLD					19.40	
						21.00	

846S Astragal - Surface Applied Adjustable Spring Loaded Must also order 845 for a set	MIL	15.80					NGP: 140P Pemko: 351P ANSI: R3F834
	DBA	18.90					
	GLD	20.80					

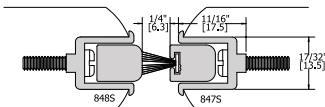

847S Astragal - Mortise Type Adjustable Spring Loaded w/ Pile Must also order 848 for a set	MIL						NGP: 144P Pemko: 354P ANSI: R3F824
	DBA					15.30	
	GLD					19.10	
						21.20	

848S Astragal - Mortise Type Adjustable Spring Loaded Must also order 847 for a set	MIL	15.40					NGP: 144P Pemko: 354P ANSI: R3F824
	DBA	19.30					
	GLD	21.50					



Thresholds and Weatherstripping

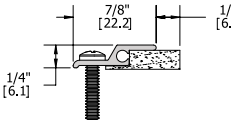
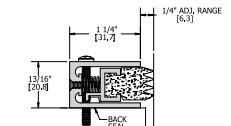
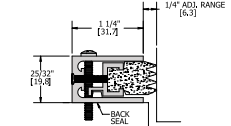
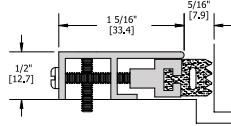
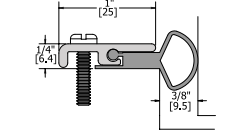
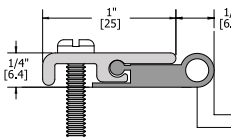
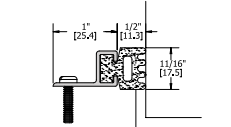
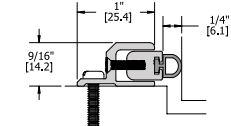
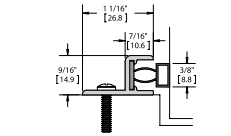
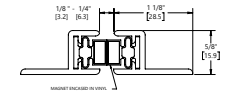

Description	Finish	Without Insert		With Insert			Comparison Numbers
		Insert	N	S	V	W	
849S Adjustable Astragals Magnetic 80" to 96" Doors only (sold as set ONLY)	MIL DBA	40.80 49.00					NGP: 149MA ANSI: R3L835
859S Magnetic Weatherstrip	MIL DBA	8.70 10.80					NGP: 159M Pemko: 2815 ANSI: R3L264
860S Jamb Weatherstrip Adjustable	MIL DBA GLD		15.70 18.80 19.90	16.20 19.40 20.50	15.20 18.20 19.30	15.20 18.20 19.30	NGP: 106 Pemko: 351 ANSI: R3B264
861S Jamb Weatherstrip	MIL DBA GLD		7.90 9.10 9.90				NGP: 108 Pemko: 285 ANSI: R3C164
862S Jamb Weatherstrip	CLR DBA GLD		6.10 7.00 7.70				NGP: 137 Pemko: 319 ANSI: R3B164
863S Jamb Weatherstrip	CLR DBA GLD		6.80 8.00 8.30				ANSI: R3B164
864S Jamb Weatherstrip Adjustable	CLR DBA GLD		11.30 14.10 14.60				NGP: 107 Pemko: 379 ANSI: R3C164
865S Jamb Weatherstrip Adjustable	MIL DBA GLD		15.50 18.20 19.20				NGP: 103N Pemko: 350 ANSI: R3C264
866S Jamb Weatherstrip Adjustable Spring Loaded	MIL DBA		16.20 19.20				NGP: 303N ANSI: R3C264
870S Jamb Weatherstrip	CLR DBA GLD		3.80 4.90 5.80				NGP: 127 NPG: 120SS Pemko: 305 ANSI: ROC164

Price Code: POA - Price on Application
 Insert Codes: V - Vinyl; N - Neoprene, EDPM, or TPE; S - Silicone; W - Pile; B - Nylon Brush; F - Vinyl Fin
 Finish Codes: MIL - Mill Finished Aluminum; DBA - Dark Bronze Anodized; GLD - Gold Anodized; Anodized; CAL - Cast Aluminum

Thresholds and Weatherstripping

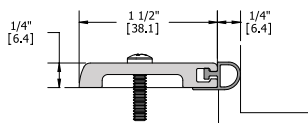
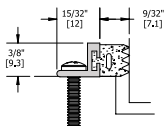
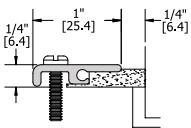
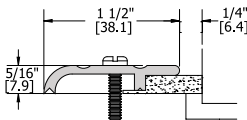
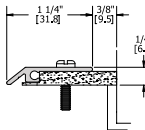
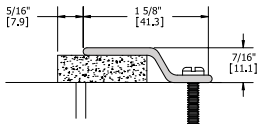
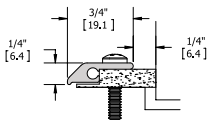
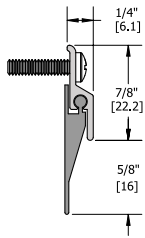
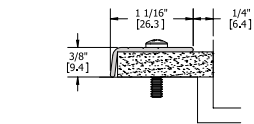

Description	Finish	Without Insert		With Insert			Comparison Numbers
		Insert	N	S	V	W	
871S Jamb Weatherstrip	MIL		5.40				NGP: 132N
	DBA		6.90				Pemko: 368
	GLD		7.10				ANSI: R3C164
872S Door Bottom Sweep or Astragal Order 2 for set	CLR		5.40				NGP: 115
	DBA		6.30				Pemko: 305
	GLD		7.30				ANSI: ROB634
873S Jamb Weatherstrip	MIL		4.10				NGP: 110
	DBA		5.30				Pemko: 332
	GLD		6.10				ANSI: R3C164
874S Astragal/Jamb Weatherstrip	MIL		6.20				NGP: 109
	DBA		8.40				Pemko: 375
	GLD		9.10				ANSI: R3C164
	32D		32.30				
875S Jamb Weatherstrip	CLR		4.90	6.60			NGP: 130
	DBA		6.10	8.20			Pemko: 315
	GLD		6.80	8.90			ANSI: ROY134
877S Jamb Weatherstrip	MIL		5.80				ANSI: R3C164
	DBA		7.20				NGP: 133
	GLD		8.10				
878S Jamb Weatherstrip	CLR		4.60				NGP: 134
	DBA		5.30				Pemko: 312
	GLD		5.50				ANSI: R3C164
880S Jamb Weatherstrip	MIL		4.30				NGP: 165
	DBA		5.80				Pemko: 296
	GLD		6.20				ANSI: R3C164
881S Jamb Weatherstrip Hardware Compatible	MIL		6.60	7.10	5.90	7.60	NGP: 700E
	DBA		8.30	8.90	7.30	9.40	Pemko: 290
	GLD		9.20	9.90	8.20	10.60	ANSI: R3Y164

Thresholds and Weatherstripping

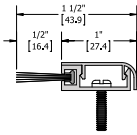

Description	Finish	B	N	With Insert		W	Comparison Numbers
				S	V		
882S Door Sweep, Astragal or Jamb Weatherstrip with Snap Cover	CLR	6.40					NGP: 675
	DBA	8.90					Pemko: 29326
	GLD	9.50					ANSI: R3Y164

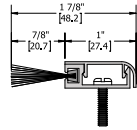

883S Door Sweep with Snap Cover	CLR	7.60					NGP: 678
	DBA	9.80					Pemko: 293100
	GLD	10.60					ANSI: R3Y164

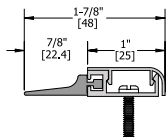

Description	Finish	N	With Insert		W	Comparison Numbers
			S	V		
884S Astragal, Door Sweep with Snap Cover	CLR			6.10		ANSI: R3Y164
	DBA			7.60		
	GLD			8.10		

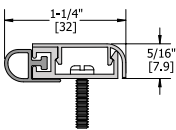

885S Jamb Weatherstrip with Snap Cover	CLR	6.40	6.90	5.70	6.30	NGP: 170
	DBA	8.90	9.60	8.30	8.80	Pemko: 29310
	GLD	9.50	10.00	8.80	9.30	ANSI: R3Y164

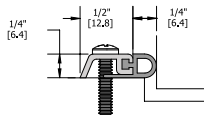

890S Jamb Weatherstrip	MIL	2.30	2.90	1.60		NGP: 152
	DBA	3.50	4.50	2.70		Pemko: 316
	GLD	3.60	4.60	2.80		ANSI: R3Y164

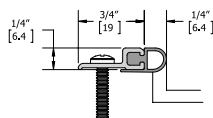

891S Jamb Weatherstrip	MIL	2.30	2.90	1.60		NGP: 160
	DBA	3.50	4.50	2.70		Pemko: 303
	GLD	3.60	4.60	2.80		ANSI: R3Y164

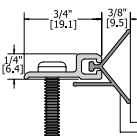

892S Jamb Weatherstrip Insert: Gray Neoprene	MIL	2.50				Pemko: 294
	DBA	3.90				ANSI: R3B164
	GLD	4.00				

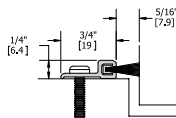

893S Jamb Weatherstrip	MIL				2.70	NGP: A605
	DBA				4.10	Pemko: 309
	GLD				4.20	ANSI: R3F164

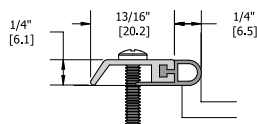

896S Jamb Weatherstrip	MIL	2.30	2.90	1.60		NGP: 156
	DBA	3.50	4.50	2.70		Pemko: 297
	GLD	3.60	4.60	2.80		ANSI: R3Y164

Price Code: POA - Price on Application
 Insert Codes: V - Vinyl; N - Neoprene, EDPM, or TPE; S - Silicone; W - Pile; B - Nylon Brush; F - Vinyl Fin
 Finish Codes: MIL - Mill Finished Aluminum; DBA - Dark Bronze Anodized; GLD - Gold Anodized; Anodized; CAL - Cast Aluminum



Thresholds and Weatherstripping

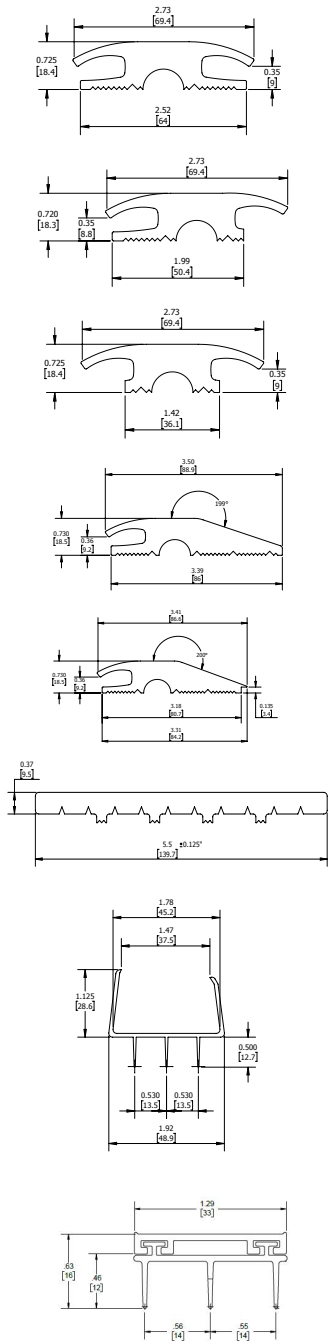

Description	Size	Finish	Without Insert	With Insert V	Comparison Numbers
900S Vinyl Threshold Carpet to Carpet	36" 48"	Black Black	36.45 48.60		NGP: 401 Pemko: EV232BL
901S Vinyl Threshold Carpet to Tile	36" 48"	Black Black	38.45 51.25		NGP: 402 Pemko: EV2325BL
902S Vinyl Threshold Tile to Tile	36" 48"	Black Black	36.45 48.60		NGP: 407 Pemko: EV2326BL
903S Vinyl Threshold Carpet	36" 48"	Black Black	38.45 51.25		NGP: 398 Pemko: EV2320BL
904S Vinyl Threshold Carpet to Tile	36" 48"	Black Black	39.09 52.12		NGP: 399 Pemko: EV2322BL
905S Vinyl Threshold Transition	36" 48"	Black Black	49.80 66.40		NGP: 400
906S Door Bottom - Shoe Triple Fin - Unnotched	36" 48"	Brown Brown	23.10 30.80		NGP: 344 Pemko: 2170UN
Door Bottom Shoe Triple Fin - Notched	36" 48"	Brown Brown	31.50 42.00		NGP: 344NF Pemko: 2170
907S Door Bottom - Shoe Triple Fin - Unnotched		MIL DBA GLD		5.34 6.50 9.42	NGP: 12T Pemko: 2343UN
Door Bottom Shoe Triple Fin - Notched		MIL DBA GLD		7.92 9.17 10.84	NGP: 12TNF Pemko: 2343



Thresholds and Weatherstripping

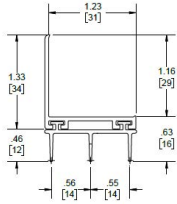

Description	Size	Finish	Without Insert	With Insert V	Comparison Numbers
908S					
Door Bottom - Shoe		MIL		7.84	NGP: 13T
Triple Fin - Unnotched		DBA		10.09	Pemko: 2113UN
		GLD		11.84	
		CLR		8.50	
Door Bottom Shoe		MIL		10.84	NGP: 13TNF
Triple Fin - Notched		DBA		13.50	Pemko: 2113
		GLD		15.25	
		CLR		11.70	

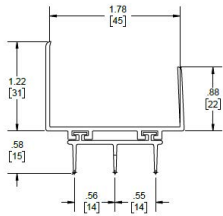

909S					
Door Bottom - Shoe		MIL		8.04	NGP: 36ET
Triple Fin - Unnotched		DBA		10.67	Pemko: 2173UN
		GLD		12.75	
		CLR		8.84	
Door Bottom Shoe		MIL		11.00	NGP: 36ETNF
Triple Fin - Notched		DBA		13.25	Pemko: 2173
		GLD		16.09	
		CLR		12.00	



Thresholds

Thresholds

400S 36" DBA VINYL	.057047
401S 36" DBA	.069704
401S 36" MIL	.051003
401S 72" SCA	.134225
402S 36" MIL	.051415
403S 36" US3	.055207
403S 36" US9	.073874
403S 36" DBA	.054097
403S 36" LBA	.002372
403S 36" MIL	051829
403S 36" SCA	.007258
403S 48" US10B	.046127
403S 48" US3	.055216
403S 48" MIL	.051420
403S 72" MIL	.051422
403S 72" DBA	.054098
404S 36" US3	.066258
404S 36" DBA	.053510
404S 36" MIL	051423
404S 48" DBA	.058788
404S 48" MIL	051424
404S 72" US3	.066324
404S 72" MIL	051426
404S 96" MIL	.053016
406S 36" MIL	.051431
406S 72" GLD	.025728
406S 72" MIL	.051434
407S 36" DBA	.069696
407S 36" GLD	.022070
407S 36" MIL	.051435
407S 48" MIL	.051436
407S 72" GLD	.082336
407S 96" MIL	.077245
410S 36" DBA	.058997
410S 36" MIB	.063300
410S 36" MIL	051009
410S 48" DBA	.061578
410S 48" MIL	.051011
410S 72" DBA	.061579
410S 72" GLD	.038946
410S 72" MIB	.059484
410S 72" MIL	051013
410S 96" MIL	.056399
411S 36" BLA	.081343
411S 36" MIL	.051015
412S 36" DBA	053693

Thresholds and Weatherstripping - Stock Numbers

Thresholds

412S 36" GLD	.053738
412S 36" MIL	051021
412S 36" MIL WSPA	.091344
412S 36" SCA	.055441
412S 36" SCB	.017067
412S 48" US10B	.040516
412S 48" DBA	.054063
412S 48" MIL	051023
412S 48" SCA	.074258
412S 72" DBA	.053067
412S 72" GLD	.063301
412S 72" MIL	051025
412S 72" SCA	.060167
412S 72" SCB	.129267
412S 96" GLD	.055211
412S 96" MIL	.052764
413S 36" US3	.052029
413S 36" US32D	.025717
413S 36" DBA	.015900
413S 36" MIL	051027
413S 48" US32D	.039101
413S 48" DBA	.065227
413S 48" MIL	051029
413S 72" US3	.052031
413S 72" US32D	.023441
413S 72" DBA	.054295
413S 72" MIL	051031
413S 96" US3	.052032
413S 96" MIL	.054157
414S 36" DBA	.000955
414S 36" MIL	.051451
414S 72" DBA	.117097
415S 36" US3	.047179
415S 36" DBA	.057305
415S 36" MIL	051033
415S 36" SCA	.071687
415S 48" DBA	.023733
415S 48" MIL	051035
415S 48" SCA	.066494
415S 72" US9	.074543
415S 72" MIL	051037
416S 36" DBA	.060723
416S 36" GLD	.081665
416S 36" MIL	.051051
416S 36" SCA	.090216
416S 48" DBA	.063049

Items with the price in **bold and red** are Quick Ship Items and ship in 24 hours.



Thresholds

416S 48" MIL	.051053
416S 72" EBRP	.061273
416S 72" DBA	.016047
416S 72" MIL	.051055
416S 96" MIL	.052960
417S 36" US9	.066359
417S 36" DBA	.059553
417S 36" MIL	056494
417S 36" SCA	.058889
417S 48" DBA	.024802
417S 48" MIL	.057023
417S 72" DBA	.075007
417S 72" MIL	.057024
417S 96" MIL	.060172
418S 36" US10B	.031199
418S 36" MIL	056495
418S 48" MIL	.062685
418S 72" US3	.048580
418S 72" MIL	.059607
418S 96" MIL	.066488
419S 36" MIL	.056496
419S 48" DBA	.108927
420S 36" MIL	.061332
420S 48" MIL	.030506
420S 72" MIL	.073999
421S 36" MIL	059872
421S 72" DBA	.068739
421S 72" MIL	.064918
422S 36" MIL	.064486
422S 48" MIL	.085099
422S 72" MIL	.064485
423S 72" MIL	.082531
424S 36" MIL	.066013
424S 48" MIL	.095418
426S 36" DBA	.002015
426S 36" MIL	061695
426S 48" MIL	.077225
426S 72" MIL	064254
426S 96" MIL	.064253
427S 36" MIL	.061190
427S 48" MIL	.061133
427S 72" MIL	.061125
427S 96" DBA	.134871
428S 36" MIL	069001
428S 48" MIL	.030450
428S 72" DBA	.066973

Thresholds

428S 72" MIL	059870
428S 96" DBA	.021942
430S 36" MIL	.062855
430S 48" MIL	.088799
430S 72" DBA	.095313
430S 72" MIL	.070161
430S 72" SCA	.084515
431S 36" DBA	.070641
431S 36" GLD	.048973
431S 36" MIB	.053331
431S 36" MIL	.051455
431S 48" DBA	.078959
431S 48" MIL	.051456
431S 72" DBA	.055522
431S 72" GLD	.066756
431S 72" MIB	.067194
431S 72" MIL	.051458
431S 96" MIL	.096450
432S 36" BLA	.095183
432S 36" DBA	.059786
432S 36" MIL	.053172
432S 48" US10B	.095706
432S 48" MIL	.062853
432S 72" US10B	.095703
432S 72" BLA	.095185
432S 72" DBA	.057872
432S 72" MIL	.053822
433S 36" DBA	.054825
433S 36" GLD	.058459
433S 36" MIL	.051463
433S 48" MIL	.051464
433S 72" DBA	.063629
433S 72" GLD	.062034
433S 72" MIL	.051466
434S 36" MIL	.052038
434S 36" MIL NEOPRENE	.026655
434S 36" MIL SILICONE	.031084
434S 36" MIL VINYL	.056329
435S 36" GLD	.106702
435S 36" MIL NEOPRENE	.028335
435S 72" MIL NEOPRENE	.080550
435S 36" MIL VINYL	.056497
435S 72" MIL VINYL	.056644
436S 36" DBA	.038944
436S 36" MIL	.027686
436S 48" DBA	.093704



Thresholds

Thresholds

436S 48" MIL	.023620
436S 72" DBA	.075861
436S 72" MIL	.032198
436S 96" MIL	.054106
438S 36" DBA	.046790
438S 36" MIL	.013799
438S 72" DBA	.045585
440S 72" GLD	.140089
442S 36" MIL	.065007
442S 36" SCA	.071626
442S 48" MIL	.063483
442S 72" MIL	.086139
443S 36" MIL	.065346
444S 36" MIL	.089632
444S 48" MIL	.094554
445S 72" MIL	.051471
445S 96" MIL	.062261
448S 36" DBA	.117092
448S 36" MIL	.038781
448S 48" MIL	.111712
448S 72" DBA	.130861
448S 72" MIL	.037440
448S 96" MIL	.066757
448S 96" MIL NH	.139421
450S 36" GLD	.131762
450S 48" MIL	.051473
450S 72" GLD	.060490
450S 96" MIL	.012758
451S 48" MIL	.098765
451S 72" MIL	.073016
452S 72" MIL	.092409
455S 72" GLD	.031990
455S 96" MIL	.070042
460S 72" MIL	.051483
460S 96" MIL	.075035
465S 72" MIL	.051488
470S 36" MIL	.051492
470S 72" GLD	.062275
470S 72" MIL	.051494
477S 48" DBA	.144656
477S 36" BLA NEOPRENE	.072390
477S 48" MIL NEOPRENE	.025060
477S 36" MIL VINYL	.089975
477S 48" DBA VINYL	.021980
477S 48" MIL VINYL	.017278
477S 72" MIL VINYL	.094703

Thresholds and Weatherstripping - Stock Numbers

Thresholds

478S 36" MIL	.144368
478S 36" GLD SILICONE	.088825
481S 36" MIL NEOPRENE	.055791
481S 48" MIL NEOPRENE	.076605
481S 72" MIL NEOPRENE	.055980
481S 36" MIL SILICONE	.072476
481S 36" DBA VINYL	.006126
481S 36" MIL VINYL	.056073
481S 48" DBA VINYL	.063958
481S 48" MIL VINYL	.051940
481S 72" DBA VINYL	.050881
481S 72" MIL VINYL	.054902
484S 36" DBA	.079872
484S 36" MIL	.051516
484S 48" DBA	.050841
484S 48" MIL	.051517
484S 72" DBA	.050882
484S 72" MIL	.051519
484S 96" MIL	.088497
492S 36" MIL	.032347
504S 36" MIL	.051534
504S 72" MIL	.056390
505S 36" MIL	.051542
506S 36" BLA	.052729
506S 36" MIL	.054719
506S 72" BLA	.016492
508S 36" DBA	.020721
508S 36" MIL	.034315
508S 96" DBA	.110506
516S 36" MIL	.124421
516S 72" MIL	.128226
516S 36" MIL NEOPRENE	.034721
516S 36" MIL SILICONE	.064022
516S 36" MIL VINYL	.033033
516S 72" MIL VINYL	.034574
517S 72" MIL NEOPRENE	.013993
517S 72" GLD VINYL	.133469
518S 48" GLD VINYL	.055794
518S 72" GLD VINYL	.138533
520S 36" MIL	.033055
520S 72" MIL	.051539
520S 36" US10B NEOPRENE	.029314
520S 36" US10B NEOPRENE NH	.029318
520S 36" MIL NEOPRENE	.054613
520S 48" MIL NEOPRENE	.056182
520S 72" US10B NEOPRENE	.029312



Thresholds

520S 72" US10B NEOPRENE NH	.029315
520S 72" MIL NEOPRENE	.055935
520S 72" SCA NEOPRENE	.046841
520S 36" MIL SILICONE	.064059
520S 48" MIL SILICONE	.080333
520S 72" MIL SILICONE	.064061
520S 36" DBA VINYL	.054218
520S 36" MIL VINYL	.051061
520S 36" SCA VINYL	.001850
520S 36" SCB VINYL	.120773
520S 48" DBA VINYL	.079046
520S 48" MIL VINYL	.051062
520S 72" DBA VINYL	.054454
520S 72" MIL VINYL	.051066
520S 72" SCA VINYL	.017347
520S 72" SCB VINYL	.120774
520S 96" MIL VINYL	.057442
532S 36" MIL	.051548
532S 36" DBA NEOPRENE	.071073
532S 36" MIL SILICONE	.073124
532S 72" MIL SILICONE	.054919
532S 36" MIL VINYL	.051552
532S 48" MIL VINYL	.051830
532S 72" VINYL	.062282
532S 72" MIL VINYL	.051555
532S 96" MIL VINYL	.053837
541S 36" 10B NEOPRENE	.078694
541S 36" MIL NEOPRENE	.054211
541S 48" 10B NEOPRENE	.078680
541S 48" DBA NEOPRENE	.000896
541S 48" MIL NEOPRENE	.054059
541S 72" MIL NEOPRENE	.054060
541S 36" CLR VINYL	.095393
541S 36" DBA VINYL	.053658
541S 36" MIL VINYL	.051068
541S 48" CLR VINYL	.095382
541S 48" MIL VINYL	.051070
541S 72" MIL VINYL	.051074
552S 36" 32D VINYL	.108523
552S 36" MIL VINYL	.051568
552S 48" MIL VINYL	.051569
552S 96" MIL VINYL	.057479
560S 36" MIL VINYL	.051076
560S 36" MIL VINYL NH	.008752
560S 48" MIL VINYL	.051078
560S 48" MIL VINYL NH	.012801

Thresholds

560S 72" MIL VINYL	.051082
560S 72" MIL VINYL NH	.009223
565S 36" SCA NEOPRENE	.145379
565S 48" MIL NEOPRENE	.008593
565S 48" SCA NEOPRENE	.145380
565S 36" MIL VINYL	.057025
565S 36" SCA VINYL	.137796
565S 48" SCA VINYL	.137797
572S 36" DBA	.025594
572S 72" MIL	.030908
575S 36" DBA VINYL	.052358
575S 36" MIL VINYL	.051084
575S 48" MIL VINYL	.051086
575S 72" MIL VINYL	.051090
575S 96" MIL VINYL	.052982
580S 36" MIL VINYL	.021041
599S 48" DBA VINYL	.134849
600S 36" MIL	.051584
600S 48" MIL	.022772
603S 36" US10B	.076299
603S 36" US3	.104453
603S 36" DBA	.078404
603S 36" MIL	.051590
603S 48" MIL	.051591
603S 72" DBA	.098807
604S 36" DBA	.053623
604S 36" MIL	.051592
604S 36" SCA	.071847
604S 48" DBA	.074415
604S 48" MIL	.051593
604S 72" US3	.048329
604S 72" DBA	.068183
604S 72" MIL	.063979
604S 72" SCA	.094430
604S 96" MIL	.062565
859S 36" DBA	.021458
859S 36" MIL	.031358

Press-On Weatherstripping

7/1/2019 BLACK	.094197
726B 204" BROWN	.108247
726B 216" BROWN	.141854
726B 240" BROWN	.110396
726B 252" BROWN	.103765
726B 300" BROWN	.137455
726S 204" CHARCOAL	.052216
726S 216" CHARCOAL	.052583

Thresholds

Press-On Weatherstripping

726S 240" CHARCOAL	052217
726S 252" CHARCOAL	052437
726S 260-Ft CHARCOAL053002
726S 264" CHARCOAL052582
726S 300" CHARCOAL052737
726S 520-Ft CHARCOAL	053070
726T 204" TAN068315
726T 240" TAN068312
726T 252" TAN139885
726W 204" WHITE054222
726W 216" WHITE054799
726W 240" WHITE054223
726W 252" WHITE054224
726W 260-Ft WHITE054226
726W 264" WHITE060177
726W 300" WHITE054225
726W 520-Ft WHITE054227
728S 204" CHARCOAL048276
728S 216" CHARCOAL051094
728S 240" CHARCOAL049528
728S 252" CHARCOAL061881
728S 260-Ft CHARCOAL047334
728S 264" CHARCOAL061882
728S 300" CHARCOAL064421
728S 520-Ft CHARCOAL002601
729B 204" BROWN045920
729B 216" BROWN055100
729B 252" BROWN046133
729B 300" BROWN079208
729S 204" BLACK015885
729S 252" BLACK068776
729S 300" BLACK068777
729W 204" WHITE024763
729W 252" WHITE027429
729W 300" WHITE027430
736S 204" CHARCOAL	089698
736S 216" CHARCOAL093251
736S 240" CHARCOAL	096054
736S 252" CHARCOAL096055
736S 260-Ft CHARCOAL095015
736S 264" CHARCOAL098132
736S 300" CHARCOAL090886
736S 520-Ft CHARCOAL095014
736W 204" WHITE096056
736W 216" WHITE098957
736W 240" WHITE096057

Thresholds and Weatherstripping - Stock Numbers

Press-On Weatherstripping

736W 252" WHITE096088
736W 260-Ft WHITE095017
736W 264" WHITE046032
736W 300" WHITE096033
736W 520-Ft WHITE095016
737S 204" CHARCOAL035450
737S 216" CHARCOAL035449
737S 240" CHARCOAL035447
737S 252" CHARCOAL035422
737S 260-Ft CHARCOAL035383
737S 264" CHARCOAL035393
737S 300" CHARCOAL035392
737S 520-Ft CHARCOAL035382
719B 36" x 84" BROWN082481
719B 48" x 84" BROWN085139
719B 72" x 84" BROWN082483
719B 84" BROWN082511
719B 84" x 84" BROWN082484
719B 96" BROWN082514
719B 108" BROWN082515
719S 36" x 84" CHARCOAL082491
719S 48" X 84" CHARCOAL085084
719S 72" x 84" CHARCOAL082494
719S 84" CHARCOAL082522
719S 84" x 84" CHARCOAL082496
719S 96" CHARCOAL082524
719S 108" CHARCOAL082525
720B 36" x 84" BROWN FLEX INTUMESCENT SINGLE WING107435
720B 48" X 84" BROWN FLEX INTUMESCENT SINGLE WING107433
720B 72" X 84" BROWN FLEX INTUMESCENT SINGLE WING107434
720B 84" x 84" BROWN FLEX INTUMESCENT SINGLE WING112842
720S 36" x 84" CHARCOAL FLEX INTUM SINGLE WING105952
720S 48" X 84" CHARCOAL FLEX INTUM SINGLE WING105953
720S 72" X 84" CHARCOAL FLEX INTUM SINGLE WING105954
720S 84" x 84" CHARCOAL FLEX INTUM SINGLE WING105955
720S 96" X 96" CHARCOAL FLEX INTUM SINGLE WING118211
721B 36" x 84" BROWN029485
721B 48" x 84" BROWN029488
721B 72" x 84" BROWN029491
721B 84" BROWN047510
721B 84" x 84" BROWN143529
721B 96" BROWN047517
721B 108" BROWN047518
721G 36" x 84" GREY013457
721G 48" x 84" GREY108615
721G 72" x 84" GREY089314



Press-On Weatherstripping

721G 84" GREY	.087654
721G 96" GREY	.087652
721S 36" x 84" BLACK	.029493
721S 48" x 84" BLACK	.029494
721S 72" x 84" BLACK	.029496
721S 84" BLACK	.081187
721S 84" x 84" BLACK	.000002
721S 96" BLACK	.081186
721S 96" x 96" BLACK	.142009
721S 108" BLACK	.081735
721W 36" x 84" WHITE	.029520
721W 48" x 84" WHITE	.029521
721W 72" x 84" WHITE	.029523
721W 84" WHITE	.059248
721W 84" x 84" WHITE	.074859
721W 96" WHITE	.059123
721W 108" WHITE	.059122
722B 36" x 84" BROWN	.086961
722B 48" x 84" BROWN	.086929
722B 72" x 84" BROWN	.086793
722B 84" x 84" BROWN	.086791
722B 96" x 96" BROWN	.086780
722S 36" x 84" CHARCOAL	.087124
722S 48" x 84" CHARCOAL	.087063
722S 72" x 84" CHARCOAL	.087055
722S 84" x 84" CHARCOAL	.087054
722S 96" x 96" CHARCOAL	.087005
724B 36" x 84" BROWN	.047696
724B 48" x 84" BROWN	.138515
724B 72" x 84" BROWN	.086997
724B 84" BROWN	.047527
724B 96" BROWN	.047528
724B 108" BROWN	.047530
724S 36" x 84" CHARCOAL	.089572
724S 84" CHARCOAL	.061283
724S 84" x 84" CHARCOAL	.109589
724S 96" CHARCOAL	.000241
724S 108" CHARCOAL	.014723
727S 36" x 84" CHARCOAL	.051140
727S 72" x 84" CHARCOAL	.054064
727S 84" CHARCOAL	.051139
727S 96" CHARCOAL	.053646
734S 36" X 84" BROWN	.026246
734B 72" X 84" BROWN	.026201
734B 84" BROWN	.026247
734B 96" BROWN	.026244

Press-On Weatherstripping

734B 96" X 96" BROWN	.026200
734B 108" BROWN	.026211
734S 36" X 84" BLACK	.026327
734S 72" X 84" BLACK	.026322
734S 84" BLACK	.026357
734S 96" BLACK	.026330
734S 96" X 96" BLACK	.026321
734S 108" BLACK	.026329
725S 84" NEOPRENE	.060206
725S 96" NEOPRENE	.060504
738S 204" CHARCOAL	.164037
738S 240" CHARCOAL	.164039

Auto-Door Bottoms

730S 36" MIL NEOPRENE	.072966
730S 36" MIL NEOPRENE	.051857
730S 42" MIL NEOPRENE	.054841
730S 48" MIL NEOPRENE	.051390
730S 36" MIL SILICONE	.046487
730S 42" MIL SILICONE	.034849
730S 48" MIL SILICONE	.087236
740S 36" NEOPRENE	.076463
740S 36" CLR NEOPRENE	.055452
740S 36" DBA NEOPRENE	.052434
740S 36" GLD NEOPRENE	.057701
740S 42" CLR NEOPRENE	.085096
740S 42" DBA NEOPRENE	.059866
740S 42" GLD NEOPRENE	.074922
740S 48" NEOPRENE	.080708
740S 48" CLR NEOPRENE	.087513
740S 48" DBA NEOPRENE	.052435
740S 48" GLD NEOPRENE	.066177
740S 36" CLR SILICONE	.068926
740S 42" CLR SILICONE	.069035
740S 48" CLR SILICONE	.068927
742S 36" MIL NEOPRENE	.054065
742S 42" MIL NEOPRENE	.061380
742S 48" MIL NEOPRENE	.000739
742S 36" MIL VINYL	.053529
742S 42" MIL VINYL	.058976
742S 48" MIL VINYL	.053865
743S 36" MIL NEOPRENE	.052842
743S 42" MIL NEOPRENE	.056039
743S 48" MIL NEOPRENE	.053078
747S 36" CLR NEOPRENE	.053563
747S 36" DBA NEOPRENE	.053781
747S 36" GLD NEOPRENE	.016063

Auto-Door Bottoms

747S 42" CLR NEOPRENE	.087210
747S 42" DBA NEOPRENE	.057863
747S 48" CLR NEOPRENE	.084717
747S 48" DBA NEOPRENE	.053735
747S 48" GLD NEOPRENE	.058145

Door Bottoms & Sweeps

750S 36" US10B NEOPRENE	.010703
750S 36" US32D NEOPRENE	.023937
750S 36" CLR NEOPRENE	053564
750S 36" DBA NEOPRENE	053069
750S 36" GLD NEOPRENE	.052905
750S 42" US32D NEOPRENE	.037601
750S 42" CLR NEOPRENE	.053565
750S 42" DBA NEOPRENE	.064869
750S 42" GLD NEOPRENE	.071669
750S 48" US3 NEOPRENE	.054200
750S 48" US32D NEOPRENE	.076771
750S 48" CLR NEOPRENE	057658
750S 48" DBA NEOPRENE	.053013
750S 48" GLD NEOPRENE	.058143
750S 36" US32D SILICONE	.040289
750S 36" CLR SILICONE	.043444
750S 36" DBA SILICONE	.006348
750S 42" US32D SILICONE	.095058
750S 48" US32D SILICONE	.055864
750S 48" CLR SILICONE	.070213
752S 36" DBA VINYL	.015097
752S 36" GLD VINYL	.057972
752S 36" MIL VINYL	061376
752S 42" DBA VINYL	.027712
752S 42" GLD VINYL	.088346
752S 42" MIL VINYL	.067894
752S 48" DBA VINYL	.040624
752S 48" GLD VINYL	.039647
752S 48" MIL VINYL	.007958
752S 48" MIL VINYL TEK	.078452
753S 36" DBA NEOPRENE	.061082
753S 36" GLD NEOPRENE	.077227
753S 36" MIL NEOPRENE	051337
753S 42" MIL NEOPRENE	.067110
753S 48" MIL NEOPRENE	.051338
754S 36" CLR NEOPRENE	083440
754S 36" DBA NEOPRENE	.052427
754S 42" CLR NEOPRENE	.083370
754S 42" DBA NEOPRENE	.005796
754S 48" CLR NEOPRENE	083372

Door Bottoms & Sweeps

756S 36" DBA VINYL	.054378
756S 36" GLD VINYL	.058375
756S 36" MIL VINYL	052010
756S 42" MIL VINYL	.061396
756S 48" DBA VINYL	.055418
756S 48" MIL VINYL	052011
759S 36" DBA VINYL	.027134
759S 36" GLD VINYL	.066852
759S 36" MIL VINYL	.060170
759S 42" DBA VINYL	.027167
759S 42" GLD VINYL	.104864
759S 42" MIL VINYL	.036002
759S 48" DBA VINYL	.066858
759S 48" GLD VINYL	.093917
759S 48" MIL VINYL	.032110
770S 36" MIL	051349
770S 36" DBA BRUSH	.065591
770S 36" GLD BRUSH	.040794
770S 36" MIL BRUSH	061333
770S 42" DBA BRUSH	.065066
770S 42" MIL BRUSH	.033809
770S 48" DBA BRUSH	046311
770S 48" MIL BRUSH	.084855
770S 36" VINYL	.075567
770S 36" DBA VINYL	.057644
770S 36" GLD VINYL	.055454
770S 36" MIL VINYL	054681
770S 36" WHP VINYL	.048479
770S 42" GLD VINYL	.016288
770S 42" MIL VINYL	.067931
770S 48" DBA VINYL	.070746
770S 48" GLD VINYL	.038496
770S 48" MIL VINYL	063484
774S 36" NEOPRENE	.062304
774S 36" DBA NEOPRENE	.064438
774S 36" MIL NEOPRENE	.051357
774S 48" MIL NEOPRENE	.051358
774S 36" MIL VINYL	.051359
774S 48" DBA VINYL	.061377
774S 48" MIL VINYL	.051360
776S 42" CLR NEOPRENE	.094490
777S 36" DBA NEOPRENE	.035004
777S 36" MIL NEOPRENE	.027008
777S 36" DBA VINYL	.054611
777S 36" MIL VINYL	.051363
778S 36" DBA NEOPRENE	.015955



Door Bottoms & Sweeps

778S 36" MIL NEOPRENE015977
778S 48" DBA NEOPRENE058254
778S 36" VINYL062294
778S 36" DBA VINYL053780
778S 36" GLD VINYL055193
778S 36" MIL VINYL	051365
778S 42" DBA VINYL054862
778S 42" GLD VINYL062642
778S 42" MIL VINYL059750
778S 48" VINYL062641
778S 48" DBA VINYL054896
778S 48" MIL VINYL051366
779S 36" DBA NEOPRENE022886
779S 36" MIL NEOPRENE025961
779S 42" MIL NEOPRENE035071
779S 48" MIL NEOPRENE026920
779S 36" DBA VINYL057067
779S 36" GLD VINYL066396
779S 36" LBA VINYL062297
779S 36" MIL VINYL054773
779S 42" DBA VINYL021025
779S 42" GLD VINYL068655
779S 42" MIL VINYL058978
779S 48" DBA VINYL012715
779S 48" GLD VINYL032823
779S 48" MIL VINYL057028
780S 36" MIL NEOPRENE027342
780S 48" MIL NEOPRENE029354
780S 36" DBA VINYL059252
780S 36" GLD VINYL086619
780S 36" MIL VINYL054821
780S 42" DBA VINYL053662
780S 42" MIL VINYL065433
780S 48" DBA VINYL071002
780S 48" MIL VINYL055420
782S 36" BLA NEOPRENE081341
782S 36" DBA NEOPRENE048578
782S 36" MIL NEOPRENE032350
782S 42" GLD NEOPRENE044501
782S 48" MIL NEOPRENE032330
782S 36" VINYL005870
782S 36" DBA VINYL034338
782S 36" GLD VINYL039678
782S 36" MIL VINYL	022288
782S 36" WHP VINYL106288
782S 42" DBA VINYL014122

Door Bottoms & Sweeps

782S 42" MIL VINYL054861
782S 48" MIL VINYL034603
783S 36" MIL115282
783S 36" GLD VINYL098197
783S 36" MIL VINYL037956
783S 48" MIL VINYL037965
787S 36" MIL NEOPRENE055268
789S 36" BLA PILE037433
789S 36" DBA PILE044987
789S 36" GLD PILE032351
789S 36" MIL PILE036194
789S 42" MIL PILE036195
789S 48" MIL PILE036617
801S 36" DBA BRUSH059618
801S 36" GLD BRUSH063248
801S 36" MIL BRUSH	053035
801S 42" MIL BRUSH055943
801S 48" DBA BRUSH067890
801S 48" MIL BRUSH	054070
802S 36" DBA BRUSH	054610
802S 36" GLD BRUSH054786
802S 36" MIL BRUSH	053194
802S 42" GLD BRUSH052346
802S 42" MIL BRUSH065250
802S 48" DBA BRUSH061397
802S 48" GLD BRUSH067474
802S 48" MIL BRUSH	054074
806S 36" DBA BRUSH032352
806S 36" MIL BRUSH	035673
806S 48" DBA BRUSH029484
806S 48" MIL BRUSH031581
872S 36" CLR NEOPRENE095928

Jamb Weatherstripping

785S 36" MIL NEOPRENE120166
785S 36" x 84" MIL NEOPRENE120162
785S 36" x 96" GLD NEOPRENE120178
785S 36" x 96" MIL NEOPRENE122126
785S 48" DBA NEOPRENE122470
785S 72" x 84" DBA NEOPRENE120174
785S 72" x 84" MIL NEOPRENE120163
785S 84" DBA NEOPRENE120177
785S 84" GLD NEOPRENE120173
785S 84" MIL NEOPRENE120164
785S 96" DBA NEOPRENE120172
785S 96" MIL NEOPRENE120171
800S 36" MIL BRUSH054784



Jamb Weatherstripping

800S 36" x 84" MIL BRUSH	.051373
800S 48" x 84" MIL BRUSH	.051374
800S 72" x 84" MIL BRUSH	.051375
800S 72" x 96" MIL BRUSH	.019037
800S 84" DBA BRUSH	.030583
800S 84" MIL BRUSH	.056636
800S 96" MIL BRUSH	.061569
802S 36" DBA BRUSH	.054610
802S 36" GLD BRUSH	.054786
802S 36" MIL BRUSH	.053194
802S 36" x 84" MIL BRUSH	.051379
802S 48" DBA BRUSH	.061397
802S 48" GLD BRUSH	.067474
802S 48" MIL BRUSH	.054074
802S 48" x 84" MIL BRUSH	.051380
802S 72" MIL BRUSH	.055939
802S 72" x 84" MIL BRUSH	.051381
802S 84" BCA BRUSH	.101313
802S 84" BLA BRUSH	.016491
802S 84" DBA BRUSH	.055941
802S 84" GLD BRUSH	.054500
802S 84" MIL BRUSH	.052979
802S 96" BCA BRUSH	.020711
802S 96" DBA BRUSH	.054257
802S 96" MIL BRUSH	.058708
803S 36" MIL BRUSH	.054075
803S 36" x 84" MIL BRUSH	.051382
803S 48" x 96" MIL BRUSH	.048945
803S 72" x 84" MIL BRUSH	.051394
803S 72" x 96" BLA BRUSH	.015019
803S 72" x 96" DBA BRUSH	.030527
803S 84" MIL BRUSH	.053077
808S 48" MIL BRUSH	.043629
808S 72" MIL BRUSH	.040087
808S 84" DBA BRUSH	.072589
808S 84" MIL BRUSH	.038341
859S 36" x 84" DBA	.031883
859S 36" x 84" MIL	.080290
859S 36" x 96" MIL	.030375
859S 36" x 108" MIL	.030376
859S 48" MIL	.067767
859S 48" x 84" MIL	.071926
859S 48" x 96" MIL	.042801
859S 72" DBA	.090769
859S 72" MIL	.095946
859S 72" x 84" MIL	.070969

Jamb Weatherstripping

859S 72" x 96" MIL	.091951
859S 84" DBA	.086427
859S 84" MIL	.028610
859S 96" MIL	.091966
859S 120" MIL	.042496
860S 36" x 84" MIL NEOPRENE	.051234
860S 36" x 84" MIL VINYL	.091326
861S 36" MIL NEOPRENE	.065452
861S 36" x 84" MIL NEOPRENE	.051235
861S 72" x 84" MIL NEOPRENE	.051237
861S 84" MIL NEOPRENE	.065463
862S 36" CLR NEOPRENE	.083520
862S 36" x 84" CLR NEOPRENE	.083522
862S 48" CLR NEOPRENE	.060040
862S 48" x 84" CLR NEOPRENE	.084994
862S 72" x 84" CLR NEOPRENE	.083517
862S 72" x 84" DBA NEOPRENE	.058008
862S 72" x 96" CLR NEOPRENE	.083632
862S 72" x 96" DBA NEOPRENE	.055343
862S 84" CLR NEOPRENE	.083616
862S 84" DBA NEOPRENE	.073092
862S 96" DBA NEOPRENE	.061765
863S 36" x 84" CLR NEOPRENE	.058992
863S 48" x 84" CLR NEOPRENE	.092863
863S 72" x 84" CLR NEOPRENE	.087142
863S 84" CLR NEOPRENE	.084707
864S 36" CLR NEOPRENE	.083568
864S 36" x 84" CLR NEOPRENE	.057659
864S 36" x 96" CLR NEOPRENE	.083570
864S 36" x 108" CLR NEOPRENE	.062579
864S 48" x 84" CLR NEOPRENE	.086659
864S 48" x 96" CLR NEOPRENE	.032695
864S 72" x 84" CLR NEOPRENE	.083572
864S 72" x 84" DBA NEOPRENE	.065293
864S 84" CLR NEOPRENE	.083573
864S 96" CLR NEOPRENE	.094658
865S 36" DBA NEOPRENE	.010688
865S 36" GLD NEOPRENE	.055359
865S 36" MIL NEOPRENE	.087913
865S 36" x 84" DBA NEOPRENE	.036985
865S 36" x 84" GLD NEOPRENE	.091572
865S 36" x 84" MIL NEOPRENE	.062415
865S 36" x 96" DBA NEOPRENE	.096197
865S 36" x 96" MIL NEOPRENE	.017295
865S 36" x 108" DBA NEOPRENE	.079468
865S 36" x 108" MIL NEOPRENE	.083004



Jamb Weatherstripping

865S 48" MIL NEOPRENE	102562
865S 48" x 84" DBA NEOPRENE	101633
865S 48" x 84" GLD NEOPRENE	060542
865S 48" x 84" MIL NEOPRENE	028997
865S 48" x 96" DBA NEOPRENE	125536
865S 48" x 96" MIL NEOPRENE	075191
865S 48" x 108" MIL NEOPRENE	092260
865S 72" MIL NEOPRENE	087915
865S 72" x 84" DBA NEOPRENE	081104
865S 72" x 84" GLD NEOPRENE	091571
865S 72" x 84" MIL NEOPRENE	022917
865S 72" x 96" DBA NEOPRENE	036353
865S 72" x 96" MIL NEOPRENE	037449
865S 84" MIL NEOPRENE	025286
865S 96" GLD NEOPRENE	083908
865S 96" MIL NEOPRENE	054907
866S 36" DBA NEOPRENE TEK.	103187
866S 36" MIL NEOPRENE	055632
866S 36" x 84" DBA NEOPRENE	040799
866S 36" x 84" MIL NEOPRENE	056313
866S 36" x 96" MIL NEOPRENE	031942
866S 48" MIL NEOPRENE	006290
866S 48" x 84" MIL NEOPRENE	037712
866S 48" x 108" MIL NEOPRENE	089576
866S 72" MIL NEOPRENE	055553
866S 72" x 84" DBA NEOPRENE	092913
866S 72" x 84" MIL NEOPRENE	007786
866S 72" x 96" MIL NEOPRENE	103804
866S 84" MIL NEOPRENE	042719
866S 96" DBA NEOPRENE	031357
866S 96" MIL NEOPRENE	055485
866S 120" MIL NEOPRENE	074592
870S 36" x 84" US10B NEOPRENE	020778
870S 36" x 84" CLR NEOPRENE	059054
870S 36" x 84" DBA NEOPRENE	053497
870S 36" x 84" GLD NEOPRENE	016082
870S 36" x 84" WHP NEOPRENE	044674
870S 36" x 96" CLR NEOPRENE	083619
870S 36" x 108" US10B NEOPRENE	048667
870S 48" CLR NEOPRENE	068708
870S 48" x 84" CLR NEOPRENE	063110
870S 48" x 96" CLR NEOPRENE	091229
870S 72" CLR NEOPRENE	083870
870S 72" x 84" CLR NEOPRENE	083596
870S 72" x 84" DBA NEOPRENE	053881
870S 72" x 84" WHP NEOPRENE	044675

Jamb Weatherstripping

870S 72" x 96" CLR NEOPRENE	084596
870S 72" x 96" WHP NEOPRENE	044676
870S 84" CLR NEOPRENE	083597
870S 84" DBA NEOPRENE	060876
870S 96" CLR NEOPRENE	083884
871S 36" MIL NEOPRENE	023335
871S 36" x 84" MIL NEOPRENE	051255
871S 48" x 84" MIL NEOPRENE	051198
871S 72" x 84" BLA NEOPRENE	106806
871S 72" x 84" MIL NEOPRENE	051257
871S 84" MIL NEOPRENE	063621
873S 36" MIL NEOPRENE	053862
873S 36" x 84" DBA NEOPRENE	053712
873S 36" x 84" MIL NEOPRENE	051263
873S 36" x 96" MIL NEOPRENE	058799
873S 48" x 84" MIL NEOPRENE	051264
873S 72" x 84" MIL NEOPRENE	051265
873S 84" DBA NEOPRENE	063162
873S 84" MIL NEOPRENE	053864
874S 36" US32D NEOPRENE	105906
874S 36" x 84" US32D NEOPRENE	064413
874S 36" x 84" MIL NEOPRENE	054083
874S 48" US32D NEOPRENE	113653
874S 48" x 84" US32D NEOPRENE	102263
874S 72" x 84" US32D NEOPRENE	102266
874S 72" x 96" US32D NEOPRENE	064095
874S 72" x 96" MIL NEOPRENE	087114
874S 84" MIL NEOPRENE	052592
874S 96" CLR NEOPRENE	130963
874S 96" MIL NEOPRENE	057221
874S 120" US32D NEOPRENE	078861
875S 36" CLR NEOPRENE	083401
875S 36" x 84" CLR NEOPRENE	058096
875S 36" x 108" CLR NEOPRENE	053915
875S 48" CLR NEOPRENE	083402
875S 48" x 84" CLR NEOPRENE	084882
875S 72" x 84" CLR NEOPRENE	059921
875S 84" CLR NEOPRENE	084251
875S 36" x 84" CLR SILICONE	003880
877S 36" x 84" MIL NEOPRENE	072544
878S 36" DBA NEOPRENE	005555
878S 36" x 84" CLR NEOPRENE	058993
880S 36" x 84" BLA NEOPRENE	064900
880S 36" x 84" MIL NEOPRENE	051275
880S 72" x 84" MIL NEOPRENE	051277
881S 36" MIL NEOPRENE	065849

Jamb Weatherstripping

881S 36" x 84" NEOPRENE035415
881S 36" x 84" DBA NEOPRENE084186
881S 36" x 84" MIL NEOPRENE051279
881S 36" x 96" MIL NEOPRENE087921
881S 48" MIL NEOPRENE058998
881S 48" x 84" GLD NEOPRENE058764
881S 48" x 84" MIL NEOPRENE051280
881S 72" GLD NEOPRENE092855
881S 72" MIL NEOPRENE068703
881S 72" x 84" DBA NEOPRENE062108
881S 72" x 84" GLD NEOPRENE034678
881S 72" x 84" MIL NEOPRENE051281
881S 72" x 96" MIL NEOPRENE087923
881S 84" MIL NEOPRENE054328
881S 96" MIL NEOPRENE087019
881S 36" MIL SILICONE065435
881S 36" x 84" GLD SILICONE076415
881S 36" x 84" MIL SILICONE055461
881S 36" x 96" MIL SILICONE080370
881S 36" x 108" MIL SILICONE049936
881S 48" MIL SILICONE070160
881S 48" x 84" MIL SILICONE075414
881S 48" x 96" MIL SILICONE022364
881S 48" x 108" MIL SILICONE056004
881S 72" MIL SILICONE062770
881S 72" x 84" MIL SILICONE062773
881S 72" x 96" MIL SILICONE080371
881S 84" MIL SILICONE054669
881S 96" MIL SILICONE080374
881S 36" DBA VINYL074308
881S 36" MIL VINYL053349
881S 36" x 84" VINYL000159
881S 36" x 84" DBA VINYL058981
881S 36" x 84" MIL VINYL052013
881S 36" x 96" MIL VINYL078158
881S 36" x 108" MIL VINYL072388
881S 48" MIL VINYL055205
881S 48" x 84" MIL VINYL052014
881S 48" x 96" MIL VINYL073151
881S 72" MIL VINYL053348
881S 72" x 84" DBA VINYL058982
881S 72" x 84" MIL VINYL056386
881S 72" x 96" DBA VINYL058983
881S 72" x 96" MIL VINYL063628
881S 84" MIL VINYL055208
881S 96" MIL VINYL062481

Jamb Weatherstripping

881S 36" MIL PILE061446
881S 36" x 84" MIL PILE065534
881S 36" x 96" MIL PILE050803
881S 48" x 84" MIL PILE079361
881S 48" x 96" MIL PILE055447
881S 72" MIL PILE073013
881S 72" x 84" MIL PILE068518
882S 84" CLR BRUSH092969
882S 84" DBA BRUSH092972
882S 84" GLD BRUSH092977
882S 96" CLR BRUSH092971
882S 96" DBA BRUSH092975
882S 96" GLD BRUSH092978
883S 36" CLR BRUSH092979
883S 36" DBA BRUSH092980
883S 36" GLD BRUSH092983
883S 84" CLR BRUSH022506
884S 36" CLR VINYL092987
884S 36" x 84" GLD VINYL	145335
884S 48" CLR VINYL092988
884S 84" VINYL	112086
884S 84" CLR VINYL092989
884S 84" DBA VINYL092992
884S 84" GLD VINYL093003
884S 96" CLR VINYL092990
884S 96" DBA VINYL093002
884S 96" GLD VINYL093004
885S 72" x 84 CLR NEOPRENE095035
885S 84" NEOPRENE062195
885S 84" CLR SILICONE098428
885S 36" x 84" CLR VINYL094826
885S 36" x 84" DBA VINYL064909
885S 72" x 84" DBA VINYL026261
885S 72" x 96" DBA VINYL098563
885S 84" CLR VINYL054716
885S 96" DBA PILE	135972
890S 36" x 84" DBA NEOPRENE054834
890S 36" x 84" MIL NEOPRENE064142
890S 48" x 84" MIL NEOPRENE091396
890S 72" x 84" DBA NEOPRENE054835
890S 72" x 84" MIL NEOPRENE064143
890S 72" x 96" MIL NEOPRENE078079
890S 84" MIL NEOPRENE072200
890S 36" x 84" MIL SILICONE060628
890S 72" x 96" MIL SILICONE093708
890S 36" MIL VINYL065300



Jamb Weatherstripping

890S 36" x 84" DBA VINYL053199
890S 36" x 84" MIL VINYL051287
890S 48" MIL VINYL053842
890S 48" x 84" MIL VINYL051288
890S 72" MIL VINYL069373
890S 72" x 84" MIL VINYL051302
890S 72" x 96" MIL VINYL056203
890S 84" MIL VINYL053181
890S 96" MIL VINYL053841
891S 36" x 84" DBA NEOPRENE055108
891S 36" x 84" GLD NEOPRENE093250
891S 36" x 84" MIL NEOPRENE056722
891S 36" x 96" DBA NEOPRENE014000
891S 36" x 96" MIL NEOPRENE057549
891S 48" x 84" DBA NEOPRENE057018
891S 48" x 84" MIL NEOPRENE057511
891S 48" x 96" DBA NEOPRENE033393
891S 72" x 84" DBA NEOPRENE057019
891S 72" x 84" GLD NEOPRENE074600
891S 72" x 84" MIL NEOPRENE057020
891S 72" x 96" DBA NEOPRENE019682
891S 72" x 96" MIL NEOPRENE061748
891S 84" DBA NEOPRENE008359
891S 84" MIL NEOPRENE073792
891S 96" MIL NEOPRENE025113
891S 36" x 84" DBA SILICONE057068
891S 36" x 84" MIL SILICONE057519
891S 48" x 84" MIL SILICONE059552
891S 72" GASKET ONLY, SILICONE BLACK134581
891S 72" GASKET ONLY, SILICONE BLACK BKG134598
891S 72" x 84" MIL SILICONE061696
891S 72" x 96" MIL SILICONE081032
891S 84" GASKET ONLY, SILICONE BLACK BKG134783
891S 84" MIL SILICONE056283
891S 96" MIL SILICONE056284
891S 36" DBA VINYL003929
891S 36" MIL VINYL052986
891S 36" x 84" CLR VINYL033882
891S 36" x 84" DBA VINYL052356
891S 36" x 84" GLD VINYL052599
891S 36" x 84" MIL VINYL051304
891S 36" x 84" MIL VINYL TEK053838
891S 36" x 96" DBA VINYL054437
891S 36" x 96" MIL VINYL053667
891S 36" x 108" MIL VINYL057520
891S 48" MIL VINYL055375

Jamb Weatherstripping

891S 48" x 84" DBA VINYL052432
891S 48" x 84" GLD VINYL057871
891S 48" x 84" MIL VINYL051305
891S 48" x 96" DBA VINYL054216
891S 48" x 96" MIL VINYL056032
891S 72" MIL VINYL053692
891S 72" x 84" DBA VINYL052357
891S 72" x 84" GLD VINYL054126
891S 72" x 84" MIL VINYL051306
891S 72" x 96" DBA VINYL052433
891S 72" x 96" MIL VINYL052431
891S 84" DBA VINYL064207
891S 84" MIL VINYL053031
891S 96" DBA VINYL071086
891S 96" MIL VINYL053015
892S 36" x 84" DBA NEOPRENE044791
892S 36" x 84" GLD NEOPRENE047155
892S 36" x 84" MIL NEOPRENE044788
892S 48" x 84" MIL NEOPRENE044785
892S 72" x 84" DBA NEOPRENE048297
892S 72" x 84" GLD NEOPRENE071107
892S 72" x 84" MIL NEOPRENE044786
892S 84" MIL NEOPRENE044967
893S 36" DBA PILE055134
893S 36" MIL PILE051285
893S 36" x 84" MIL PILE051314
893S 72" x 84" MIL PILE051313
893S 72" x 84" WHP PILE048452
893S 84" CLR PILE085233
893S 84" DBA PILE058449
893S 84" GLD PILE064959
893S 84" MIL PILE053666
893S 96" MIL PILE056263
896S 36" x 84" DBA NEOPRENE036879
896S 36" x 84" MIL NEOPRENE033668
896S 48" x 84" MIL NEOPRENE037316
896S 48" x 96" MIL NEOPRENE050091
896S 72" x 84" MIL NEOPRENE035258
896S 84" MIL NEOPRENE035980
896S 96" MIL NEOPRENE049422
896S 36" x 84" MIL SILICONE066836
896S 48" x 84" MIL SILICONE051154
896S 36" MIL VINYL063497
896S 36" x 84" GLD VINYL087327
896S 36" x 84" MIL VINYL073543
896S 72" x 84" MIL VINYL074012

Jamb Weatherstripping

896S 84" MIL VINYL033779

Astragals

756S 84" DBA VINYL054120
756S 84" MIL VINYL059622
756S 96" DBA VINYL020114
756S 96" MIL VINYL075551
771S 84" MIL NEOPRENE097923
771S 96" MIL SILICONE123173
771S 84" MIL VINYL037527
771S 96" MIL VINYL046239
771S 84" MIL PILE052983
774S 96" MIL NEOPRENE059422
774S 84" MIL VINYL085136
802S 84" BCA BRUSH101313
802S 84" BLA BRUSH016491
802S 84" DBA BRUSH055941
802S 84" GLD BRUSH054500
802S 84" MIL BRUSH052979
802S 96" BCA BRUSH020711
802S 96" DBA BRUSH054257
802S 96" MIL BRUSH058708
822S 96" MIB060612
822S 96" MIB BULK086203
835S 84" US32D057965
835S 84" DBA054076
835S 84" GLD052598
835S 84" GYP052218
835S 84" MIL	051399
835S 96" US32D082492
835S 96" DBA054077
835S 96" GYP054078
835S 96" MIL051401
835S 120" US32D019549
835S 120" DBA028190
835S 120" GYP066347
835S 120" MIL072577
836S 84" DBA052438
836S 84" GLD067594
836S 84" MIL051402
836S 96" DBA065451
836S 96" GLD013885
836S 96" MIL051404
836S 120" DBA056267
836S 120" MIL070159
837S 84" DBA NEOPRENE058049
837S 84" GLD NEOPRENE060491

Astragals

837S 84" MIL NEOPRENE051407
837S 96" DBA NEOPRENE052767
837S 96" MIL NEOPRENE051408
837S 120" MIL NEOPRENE069420
837S 84" DBA SILICONE058625
837S 84" GLD SILICONE062464
837S 84" MIL SILICONE056392
837S 96" DBA SILICONE058626
837S 96" GLD SILICONE079237
837S 96" MIL SILICONE058141
837S 84" DBA VINYL052439
837S 84" GLD VINYL054867
837S 84" MIL VINYL051405
837S 84" WHP VINYL076481
837S 96" BCA VINYL020677
837S 96" DBA VINYL059436
837S 96" GLD VINYL090519
837S 96" MIL VINYL051406
837S 120" GLD VINYL068238
837S 120" MIL VINYL059619
839SW 84" MIL BRUSH141943
839S 84" MIL BRUSH141944
839S 96" MIL BRUSH141947
839S 120" MIL BRUSH141949
845S 84" MIL PILE051409
846S 84" MIL051410
847S 84" DBA PILE075287
847S 84" GLD PILE000606
847S 96" GLD PILE135979
848S 84" DBA075288
848S 84" GLD128894
849S 84" DBA038794
849S 84" MIL014074
849S 96" DBA075587
849S 96" MIL031904
872S 84" CLR NEOPRENE	053566
872S 84" DBA NEOPRENE052859
872S 84" GLD NEOPRENE053173
872S 96" CLR NEOPRENE083594
872S 120" CLR NEOPRENE084691
874S 84" MIL NEOPRENE052592
874S 96" CLR NEOPRENE130963
874S 96" MIL NEOPRENE057221
874S 120" US32D NEOPRENE078861

Spring Bronze

822S 96" MIB060612



Spring Bronze

822S 96" MIB BULK086203

Rain Drips

810S 40" AWP057538

810S 40" DBA052360

810S 40" GLD052597

810S 40" MIL051396

810S 40" WHP038074

810S 52" MIL054095

810S 76" DBA052924

810S 76" GLD075081

810S 76" MIL051398

810S 76" WHP038076



One Family. One Brand. One Vision.™

www.hagerco.com

TABLE OF CONTENTS

B		Q	
Barn Door Hardware		Quick Ship.....	2
9400 Series Barn Door Packaged Sets	35		
Barn Door Privacy Lock.....	37		
eConestoga Series Barn Door Hardware	38		
Bi-Fold Door Hardware		S	
9570 Packaged Sets	15	Side Mount Selection Chart.....	2
9860 Packaged Sets and 9861 Packaged Sets.....	16		
9890 Packaged Sets and 9891 Packaged Sets.....	17		
By-Pass Door Hardware		W	
9110 Packaged Sets and 9130 Packaged Sets	4	Wall Mount 9710 Series	24
9514 Packaged Sets and 9583 Packaged Sets.....	5		
9611 Packaged Sets and 9612 Packaged Sets.....	6		
9614 Packaged Sets and 9683 Packaged Sets.....	7		
9673 Packaged Sets and 9674 Packaged Sets.....	9		
9675 Packaged Sets and 9676 Packaged Sets.....	10		
9844 Packaged Sets and 9845 Packaged Sets.....	11		
9875 Packaged Sets	13		
9885 Packaged Sets and 9886 Packaged Sets.....	14		
C			
Components for Barn Door Hardware.....	36-37		
Components for Sliding Door Hardware.....	25-34		
Conestoga - How to Order and Pricing.....	38-39		
D			
Door Selection Chart.....	3		
H			
How to Order	2		
L			
Lead Times	2		
P			
Pocket Door Hardware			
9110 Packaged Sets and 9130 Packaged Sets	18		
9628 9629 9630 9631 Framed Kits.....	19		
9678 Packaged Sets	20		
9850 Framed Kits.....	21		
9878 Packaged Sets	22		
9901 Packaged Sets	23		



Sliding Door Hardware

GENERAL INFORMATION

Lead Times

Stock items will typically ship in five working days or less from the order entry date. Made-to-order items will typically ship in 15 working days depending on seasonal volume and order complexity. Special orders including industrials, special machining, and large quantities may need to be scheduled. The anticipated ship date will be included with each order acknowledgement. Please contact Customer Service if product availability is in question.

Quick Ship

Products denoted with **red and bold** pricing are available to order through the Quick Ship program and ship within 24 hours. When ordering these products please visit www.hagerco.com and log in to MyHager to access the 'Quick Ship' portal. Due to the promptness of the fulfillment process, Quick Ship orders are non-cancellable.

Cancellation Notification

Cancellation for made-to-order items must be communicated within 48 hours of order placement.

HOW TO ORDER:

EXAMPLE: 9710 Wall Mount Packaged Set For 1 Door CLA 72"

STOCK NUMBER: 160958

ITEM NUMBER: 971000720000CLA

Side Mount Selection Chart					
Door thickness	3/4" (19mm)	1" (25.4mm)	1-1/8" (29mm)	1-3/8" (35mm)	1-3/4" (44mm)
Front hanger	B	B	A or B	B	A
Rear hanger	A	A	Same as front	B	B
Door gap	3/4"	1/2"	11/16"	9/16"	3/8"
Item #	Description				
Hanger A	9200	Single wheel hanger-offset A			
Hanger B	9201	Single wheel hanger-offset B			
Hanger B	9202	Twin wheel hanger- offset B			
Hanger A	9203	Twin wheel hanger- offset A			
Hanger A	9400	Micro cam hanger-offset A			
Hanger B	9401	Micro cam hanger-offset B			

Hanger Mount Selection Example:

Door thickness: 1-1/8"

Door weight: 60 lbs.

Select single, twin or micro cam hanger

Front hanger: 9400

Rear hanger: 9400

Note: Hanger is stamped "A" or "B" for easy identification for consideration for 9514, 9583, 9614, 9683, 9844 and 9845 by-pass packaged sets located on pages 5, 7 and 10.



Sliding Door Hardware

Maximum Weight Per Door	Packaged Sets	Description	Parts Bags	Track	Page #
By-Pass					
60#	9514	Aluminum track & hardware for 3/4" - 1-3/8" thick doors.	9814	9810	5
60#	9583	Aluminum track & hardware for 3/4" - 1-3/8" thick doors, for 3 doors.	9814	9810	5
60#	9614	Aluminum track with grooved fascia - hardware for 1-3/8" thick doors.	9540	9820	7
60#	9683	Aluminum track with grooved fascia - hardware for 1-3/8" thick doors.	9401 hangers	9820	7
60#	9844	Galvanized steel & hardware for 1-1/8" - 1-3/8" thick doors.	9540	9840	11
60#	9845	Galvanized steel & hardware for 1-1/8" - 1-3/8" thick doors for 3 doors.	9400/9401 hangers	9840	11
125#	9673	Heavy duty aluminum box track with grooved fascia & hardware for 1-3/8" - 1-3/4" thick doors.	9679	9603	9
125#	9675	Heavy duty aluminum box track & hardware for 1-3/8" & 1-3/4" thick doors.	9679	9602	9
150#	9611	Aluminum double box track & hardware for 1-3/8" & 1-3/4" thick doors.	9892	9821	6
150#	9674	Heavy duty aluminum box track with grooved fascia & hardware for 1-3/8" & 1-3/4" thick doors.	9680	9603	9
150#	9676	Heavy duty aluminum box track & hardware for 1-3/8" & 1-3/4" thick doors.	9680	9602	10
175#	9110	Heavy duty aluminum I-beam track and hardware for 1" - 1-3/4" thick doors. *Must order 2 per by pass.*	9109	9101	4
250#	9612	Aluminum double box track & hardware for 1-3/8" & 1-3/4" thick doors.	9893	9821	6
250#	9875	Heavy duty aluminum box track & hardware for 1-3/8" & 1-3/4" thick doors.	9827 hangers	9801	13
250#	9885	Heavy duty aluminum double track with smooth fascia & hardware for 1-3/8" & 1-3/4" thick doors.	9827 hangers	9803	13
250#	9886	Heavy duty aluminum double track with smooth fascia & hardware for 1-3/8" & 1-3/4" thick doors.	9827 hangers	9803	13
275#	9130	Heavy duty aluminum I-beam track and hardware for 1" thick doors and up. *Must order 2 per by pass.*	9129	9101	4
Bi-Fold Sets					
50#	9570	Aluminum track & hardware for 1-1/8" & 1-3/4" thick doors.	9571	9601	15
125#	9860	Heavy duty aluminum box track & hardware for 1-3/8" & 1-3/4" thick doors.	9894	9821	16
125#	9861	Heavy duty aluminum box track & hardware for 1-3/8" & 1-3/4" thick doors.	9894	9821	14
125#	9890	Heavy duty aluminum box track & hardware for for 1-1/8" & 1-3/4" thick doors. Up to 75 lbs per panel for multi fold applications.	9827 hangers	9801	17
125#	9891	"Heavy duty aluminum box track & hardware for 1-1/8" & 1-3/4" thick doors.	9827 hangers	9801	17
Pocket Door Sets					
125#	9678	Heavy duty aluminum box track & hardware for 1-3/8" & 1-3/4" thick doors.	9632	9601	20
150#	9678	Heavy duty aluminum box track & hardware for 1-3/8" & 1-3/4" thick doors.	9633	9101	20
175#	9110	Heavy duty aluminum I-beam track & hardware for 1" thick doors and up.	9109	9101	18
250#	9878	Aluminum box track & hardware for 1-3/8" thick doors and up.	9742	9801	22
250#	9901	Extra heavy duty aluminum box track & hardware for 1-3/8" & 1-3/4" thick doors.	9895	9821	23
275#	9130	Heavy duty aluminum I-beam track & hardware for 1" thick doors and up.	9129	9101	18
Pocket Door Frame Kits All Pocket Door Framed Kits for 1-3/8" Thick Doors					
75#	9631	Pocket Door Packaged Sets for 3'0" wide 6'8" high door	9606 hangers	9601	19
75#	9628	Pocket Door Packaged Sets for 3'0" wide 7'0" high door	9606 hangers	9601	19
75#	9629	Pocket Door Packaged Sets for 3'0" wide 8'0" high door	9606 hangers	9601	19
75#	9630	Pocket Door Packaged Sets for 3'0" wide 9'0" high door	9606 hangers	9601	19
250#	9850	Pocket Door Packaged Sets for 4'0" wide 8'0" high door	9827 hangers	9801	21
250#	9850	Pocket Door Packaged Sets for 4'0" wide 8'6" high door	9827 hangers	9801	21
Wall Mount Sets					
250#	9710	Heavy duty aluminum track & hardware for 1" & 1-3/4" thick doors.	9711	9703	24
Barn Door Pakaged Sets					
250#	All	9400 Series Stainless Steel Barn Door	N/A	N/A	35
250#	All	Conestoga	N/A	N/A	38



Sliding Door Hardware - 9110 and 9130 Packaged Sets - By-Pass



Description	Finish	2018 List	Stock No.	Case Qty.
9110 Packaged Sets for doors up to 175 lbs (79 kg) per door.				
Contents: 9101 track, 9109 parts bag Heavy duty aluminum I-beam track & hardware for 1" - 1-3/4" (25mm - 45mm) thick doors.				
9110-60 - Packaged set for 2'6" door	60" (1524 mm)	117.55	135334	5
9110-72 - Packaged set for 3'0" door	72" (1829 mm)	129.95	135335	
9110-84 - Packaged set for 3'6" door	84" (2134 mm)	141.55	135336	
9110-96 - Packaged set for 4'0" door	96" (2438 mm)	154.05	135337	
9110-120 - Packaged set for 5'0" door	120" (3048 mm)	158.60	135338	
9110-144 - Packaged set for 6'0" door	144" (3658 mm)	185.75	135339	

Note: Must order 2 each 9110 packaged sets

9130 Packaged Sets for doors up to 275 lbs (125 kg) per door.

Contents: 9101 track, 9129 parts bag

9130-60 - Packaged set for 2'6" door	60" (1524 mm)	150.15	135340	5
9130-72 - Packaged set for 3'0" door	72" (1829 mm)	161.00	135341	
9130-84 - Packaged set for 3'6" door	84" (2134 mm)	162.60	135342	
9130-96 - Packaged set for 4'0" door	96" (2438 mm)	177.25	135343	
9130-120 - Packaged set for 5'0" door	120" (3048 mm)	209.80	135344	
9130-144 - Packaged set for 6'0" door	144" (3658 mm)	234.10	135346	

Note: Must order 2 each 9130 packaged sets



9101-60 - I-beam track only, heavy duty aluminum	60" (1524 mm)	AL	54.85	023278	5
9101-72 - I-beam track only, heavy duty aluminum	72" (1829 mm)	AL	68.65	096508	
9101-84 - I-beam track only, heavy duty aluminum	84" (2134 mm)	AL	81.80	096509	
9101-96 - I-beam track only, heavy duty aluminum	96" (2438 mm)	AL	87.45	096707	
9101-120 - I-beam track only, heavy duty aluminum	120" (3048 mm)	AL	114.40	096511	
9101-144 - I-beam track only, heavy duty aluminum	144" (3658 mm)	AL	137.65	096512	
9101-192 - I-beam track only, heavy duty aluminum	192" (4877 mm)	AL	182.75	096513	

Parts Description

9109 - 2 ea. 9102 two wheel hangers, 1 ea. 9115 floor guide. <i>*Up to 175 lbs (79 kg) per door.*</i>		56.95	135690	10
9129 - 2 ea. 9105 four wheel hangers, 1 ea. 9115 floor guide. <i>*Up to 275 lbs (125 kg) per door.*</i>		84.05	135315	10

Components Description

9102 2 Wheel Hanger - For use with 9101 track	US2C	25.00	135310	20
9105 4 Wheel Hanger - For use with 9101 track	US2C	37.50	135312	40
9115 Bottom Door Guide	US2C	8.85	096522	50



Sliding Door Hardware - 9514 and 9583 Packaged Sets - By-Pass



Description	Finish	2018 List	Stock No.	Case Qty.
9514 Packaged Sets for doors up to 60 lbs (27 kg) each for two (2) doors.				
Contents: 9810 track, 9814 parts bag. Refer to side mount selection chart for combination of hangers. Aluminum track & hardware For 3/4" (19 mm) and 1-3/8" (35mm) thick doors.				
9514-48 - By-pass set for two 24" doors	48" (1219 mm)	37.50	099662	5
9514-60 - By-pass set for two 30" doors	60" (1524 mm)	40.60	099663	
9514-72 - By-pass set for two 36" doors	72" (1829 mm)	45.20	099666	
9514-96 - By-pass set for two 48" doors	96" (2438 mm)	60.05	017418	
9583 Packaged Sets for doors up to 60 lbs (27 kg) each for three (3) doors.				
Contents: 9810 track, 2 ea. 9400 hangers, 4 ea. 9401 hangers, 2 ea. 9353 guides, 3 ea. 2610 pulls				
9583-96 -	96" (2438 mm)	68.65	029415	5
9810-46 - Aluminum track	46-3/8" (1178 mm)	AL 15.80	019702	10
9810-58 - Aluminum track	58-3/8" (1483 mm)	AL 18.85	019703	
9810-70 - Aluminum track	70-3/8" (1788 mm)	AL 22.90	019704	
9810-93 - Aluminum track	93-3/8" (2372 mm)	AL 29.65	019705	
9810-120 - Aluminum track	120" (3048 mm)	AL 37.50	016570	
9810-144 - Aluminum track	144" (3658 mm)	AL 49.90	026064	
Parts Description				
9814 - 2 ea. 9400 hangers, 2 ea. 9401 hangers, 2 ea. 2610 pulls, 1 ea. 9353 guide		14.95	016772	10
9841 - For 1" to 1-1/8", specify 9841 parts bag. 4 ea. 9401 hangers, 2 ea. 9865 pulls, 1 ea. 9351 guide		8.10	099665	10
Components Description				
2610				
Finger Pull	US3	.95	013049	500
	US4	.95	071953	
Material: Brass	US5	.95	067282	
Overall Diameter: 31/32"	US10A	.95	068711	
Finger Pull Diameter: 3/4"	US15	.95	040589	
Pull Clearance: 5/16"	US15A	.95	040590	
Projection: 1/32"	US26	.95	013047	
	US26D	.95	071169	
9351		2.65	096563	50
Door Guide				
9353		2.65	096564	20
Adjustable Door Guide				
9400	US2C	3.35	017417	100
Cam Adjustable Hanger - Small 3/8" (10 mm) offset A				
9401	US2C	3.35	096566	100
Cam Adjustable Hanger - Large 11/16" (18 mm) offset B				
9865	Plastic	1.00	098993	50
Plastic Pull Overall Diameter: 1-31/32" Finger Pull Diameter: 1-19/32" Pull Clearance: 11/32" Projection: 5/64"				

- For additional components, refer to component section.
- Items with the price in **bold and red** are Quick Ship items and ship in 24 hours. Please use stock number when ordering.
- U/M is each unless otherwise noted.
- Packaged sets and parts bags are available with optional components by special quotation.

08/21/2020

www.hagerco.com



Sliding Door Hardware - 9611 and 9612 Packaged Sets - By-Pass



Description	Finish	2018 List	Stock No.	Case Qty.	
9611 Packaged Sets for doors up to 150 lbs (68 kg) each.					
9573 spacer kit is used for 1-3/4" (4 mm) doors. No spacer kit required for 1-3/8" (35 mm) doors.					
Contents: 2 ea. 9821 tracks, 9892 parts bag					
For 1-3/8" (35 mm) and 1-3/4" (44 mm) thick doors.					
9611-60 - By-pass set for two 30" doors	60" (1524 mm)	126.85	019404	5	
9611-72 - By-pass set for two 36" doors	72" (1829 mm)	136.40	019402		
9611-96 - By-pass set for two 48" doors	96" (2438 mm)	165.00	019389		
9612 Packaged Sets for doors up to 250 lbs (113 kg) each.					
Contents: 2 pcs 9821 Track, 9893 Parts bag					
9612-60 - By-pass set for two 30" doors	60" (1524 mm)	159.45	019368	5	
9612-72 - By-pass set for two 36" doors	72" (1829 mm)	170.45	019362		
9612-96 - By-pass set for two 48" doors	96" (2438 mm)	185.60	019378		
9821-59 - Aluminum box track	59" (1499 mm)	AL	30.90	019084	10
9821-71 - Aluminum box track	71" (1803 mm)	AL	38.30	019062	
9821-96 - Aluminum box track	96" (2438 mm)	AL	51.05	019061	
9821-144 - Aluminum box track	144" (3658 mm)	AL	73.95	019050	
Grooved fascia for painting					
9709-48 - Aluminum grooved fascia, 2-3/4" (70 mm) wide	48" (1219 mm)	AL	34.40	023321	10
9709-60 - Aluminum grooved fascia, 2-3/4" (70 mm) wide	60" (1524 mm)	AL	51.55	023322	
9709-72 - Aluminum grooved fascia, 2-3/4" (70 mm) wide	72" (1829 mm)	AL	59.15	096603	
9709-96 - Aluminum grooved fascia, 2-3/4" (70 mm) wide	96" (2438 mm)	AL	67.00	096604	
Parts Description					
9892 - 4 ea. 9824 four-wheel hangers w/ top mount plate, 1 ea. 9909 guide, 9573 spacer kit		52.70	019421	10	
9893 - 4 ea. 9825 four-wheel ball bearing hangers w/ top mount plate, 1 ea. 9909 guide, 9573 spacer kit		98.60	019418	10	
Components Description					
9573 Spacer Kit - 3/8" use with 9821 track - For doors 1-3/4" thick		4.95	019014	5	
9824 4 Wheel Hanger w/ Top Mount Plate		27.80	135320	20	
9825 4 Wheel Ball Bearing Hanger w/ Top Mount Plate		34.95	135321	10	
9909 Heavy Duty Adjustable Door Guide From 3/4" to 1-3/4" (19 mm to 44 mm)	US2C	8.10	097528	20	



Sliding Door Hardware - 9614 and 9683 Packaged Sets - By-Pass



Description	Finish	2018 List	Stock No.	Case Qty.
9614 Packaged Sets for doors up to 60 lbs (27 kg).				
Contents: 9820 track, 9540 parts bag. Refer to side mount selection chart on page 2 for combination of hangers. Aluminum track & hardware with 1-3/4" (44 mm) grooved fascia. For 1-3/8" (35 mm) thick doors.				
9614-48 - By-pass set for two 24" doors	48" (1219 mm)	46.85	099091	5
9614-60 - By-pass set for two 30" doors	60" (1524 mm)	53.10	099756	
9614-72 - By-pass set for two 36" doors	72" (1829 mm)	60.75	016652	
9683 Packaged Sets for three (3) 32" doors and doors up to 60 lbs. (27 kg) each.				
Contents: 9820 track, 6 ea. 9401 hangers, 2 ea. 9351 guides, and 3 ea. 2610 pulls				
9683-96 - By-pass set for three 32" doors	96" (2438 mm)	85.70	022329	
Grooved fascia for painting				
9820-48 - Aluminum track with 1-3/4" grooved fascia	48" (1219 mm)	AL	29.05	000461
9820-60 - Aluminum track with 1-3/4" grooved fascia	60" (1524 mm)	AL	36.05	000462
9820-72 - Aluminum track with 1-3/4" grooved fascia	72" (1829 mm)	AL	42.15	000463
9820-84 - Aluminum track with 1-3/4" grooved fascia	84" (2134 mm)	AL	56.95	028175
9820-96 - Aluminum track with 1-3/4" grooved fascia	96" (2438 mm)	AL	62.30	099664
9820-120 - Aluminum track with 1-3/4" grooved fascia	120" (3048 mm)	AL	71.75	000464
9820-144 - Aluminum track with 1-3/4" grooved fascia	144" (3658 mm)	AL	93.45	000460
Parts Description				
9540 - 4 ea. 9401 hangers, 2 ea. 2610 pull, 1 ea. 9351 guide		9.55	017419	10
9544 - 4 ea. 9202 hangers, 2 ea. 2630 pull, 1 ea. 9351 guide <i>*Used to increase door weight capacity to 75 lbs*</i>		14.15	017035	
9841 - 4 ea. 9401 hangers, 2 ea. 9865 pull, 1 ea. 9351 guide		8.10	099665	
9842 - 4 ea. 9401 hangers, 2 ea. 2630 pull, 1 ea., 9351 guide		11.10	017424	
9843 - 4 ea. 9202 hangers, 2 ea. 9865 pull, 1 ea. 9351 guide <i>*Used to increase door weight capacity to 75 lbs*</i>		12.65	016912	
Components Description				
2610		US3	0.95	013049
Finger Pull		US4	0.95	071953
Material: Brass		US5	0.95	067282
Overall Diameter: 31/32"		US10A	0.95	068711
Finger Pull Diameter: 3/4"		US15	0.95	040589
Pull Clearance: 5/16"		US15A	0.95	040590
Projection: 1/32"		US26	0.95	013047
		US26D	0.95	071169
2630		US3	4.15	051919
Round Flush Pull		US4	4.15	073783
Material: Brass		US5	4.15	053163
Overall Diameter: 2-7/16"		US10A	4.15	073053
Finger Pull Diameter: 2-1/16"		US15	4.15	073056
Pull Clearance: 11/32"		US15A	4.15	005307
Projection: 3/32"		US26	4.15	023430
		US26D	4.15	023431
9202		US2C	3.35	096562
Twin Wheel Hanger - Large 11/16" (18 mm) offset B				100

- For additional components, refer to component section. 2. Items with the price in **bold and red** are Quick Ship items and ship in 24 hours. Please use stock number when ordering. 3. U/M is each unless otherwise noted.
4. Packaged sets and parts bags are available with optional components by special quotation.

08/21/2020

www.hagerco.com



Sliding Door Hardware - 9614 and 9683 Packaged Sets - By-Pass



Components Description	Finish	2018 List	Stock No.	Case Qty.
9351 Door Guide		2.65	096563	50
9401 Cam Adjustable Hanger - Large 1 1/16" (18 mm) offset B	US2C	3.35	096566	100
9865 Plastic Pull Overall Diameter: 1-31/32" Finger Pull Diameter: 1-19/32" Pull Clearance: 1 1/32" Projection: 5/64"	Plastic	1.00	098993	50



Sliding Door Hardware - 9673 and 9674 Packages Sets - By-Pass

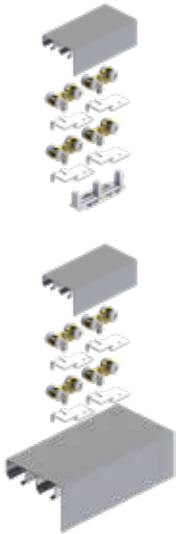

Description	Finish	2018 List	Stock No.	Case Qty.	
9673 Packaged Sets for doors up to 125 lbs (57 kg).					
Contents: 9603 track, 9679 parts bag					
Heavy duty aluminum double box track & hardware with 2-5/8" (66 mm) grooved fascia. For 1-3/8" (35 mm) and 1-3/4" (44 mm) thick doors.					
9673-48 - By-pass set for two 24" doors	48" (1219 mm)	135.40	137170	5	
9673-60 - By-pass set for two 30" doors	60" (1524 mm)	146.20	137171		
9673-72 - By-pass set for two 36" doors	72" (1829 mm)	154.75	137172		
9673-96 - By-pass set for two 48" doors	96" (2438 mm)	189.80	137173		
9674 Packaged Sets for doors up to 150 lbs (68 kg).					
9674-48 - By-pass set for two 24" doors	48" (1219 mm)	177.25	136345	5	
9674-60 - By-pass set for two 30" doors	60" (1524 mm)	187.40	136346		
9674-72 - By-pass set for two 36" doors	72" (1829 mm)	202.15	136347		
9674-96 - By-pass set for two 48" doors	96" (2438 mm)	234.10	136349		
Grooved fascia for painting.					
Double box track w/ built in grooved fascia.					
9603-48 - Aluminum box track with grooved fascia	48" (1219 mm)	AL	60.75	135288	5
9603-60 - Aluminum box track with grooved fascia	60" (1524 mm)	AL	73.25	135289	
9603-72 - Aluminum box track with grooved fascia	72" (1829 mm)	AL	87.20	135290	
9603-96 - Aluminum box track with grooved fascia	96" (2438 mm)	AL	113.70	135291	
9603-120 - Aluminum box track with grooved fascia	120" (3048 mm)	AL	142.40	029359	
9603-144 - Aluminum box track with grooved fascia	144" (3658 mm)	AL	175.05	029360	
Parts Description					
9575 - 4 ea. 9572 hangers w/ top mount plate, 1 ea. 9909 guide		27.45	137167	5	
9679 - 4 ea. 9605 hangers w/ top mount plate, 1 ea. 9909 guide		38.30	096600		
9680 - 4 ea. 9606 ball bearing hangers w/ top mount plate, 1 ea. 9909 guide		90.30	136357		
Components Description					
9572	4 Wheel Hanger w/ Top Mount Plate	US2D	11.85	135316	20
9605	4 Wheel Hanger w/ Top Mount Plate	US2D	5.55	135317	20
9606	4 Wheel Ball Bearing Hanger w/ Top Mount Plate	US2D	17.30	135318	20
9909	Heavy Duty Adjustable Door Guide From 3/4" to 1-3/4" (19 mm to 44 mm)	US2C	8.10	097528	20

1. For additional components, refer to component section. 2. Items with the price in **bold and red** are Quick Ship items and ship in 24 hours. Please use stock number when ordering. 3. U/M is each unless otherwise noted.
4. Packaged sets and parts bags are available with optional components by special quotation.



Sliding Door Hardware - 9675 and 9676 Packaged Sets - By-Pass



Description	Finish	2018 List	Stock No.	Case Qty.	
9675 Packaged Sets for doors up to 125 lbs (57 kg) each.					
Contents: 9602 track, 9679 parts bag					
Heavy duty aluminum double box track & hardware					
For 1-3/8" (35 mm) and 1-3/4" (44 mm) thick doors.					
9675-48 - By-pass set for two 24" doors	48" (1219 mm)	88.80	137175	5	
9675-60 - By-pass set for two 30" doors	60" (1524 mm)	95.00	137176		
9675-72 - By-pass set for two 36" doors	72" (1829 mm)	104.30	137177		
9675-96 - By-pass set for two 48" doors	96" (2438 mm)	123.00	137178		
9676 Packaged Sets for doors up to 150 lbs (68 kg) each.					
9676-48 - By-pass set for two 24" doors	48" (1219 mm)	135.40	136350	5	
9676-60 - By-pass set for two 30" doors	60" (1524 mm)	136.90	136351		
9676-72 - By-pass set for two 36" doors	72" (1829 mm)	150.95	136352		
9676-96 - By-pass set for two 48" doors	96" (2438 mm)	167.25	136353		
Grooved fascia for painting					
9709-48 - Aluminum grooved fascia, 2-3/4" (70 mm) wide	48" (1219 mm)	AL	34.40	023321	10
9709-60 - Aluminum grooved fascia, 2-3/4" (70 mm) wide	60" (1524 mm)	AL	51.55	023322	
9709-72 - Aluminum grooved fascia, 2-3/4" (70 mm) wide	72" (1829 mm)	AL	59.15	096603	
9709-96 - Aluminum grooved fascia, 2-3/4" (70 mm) wide	96" (2438 mm)	AL	67.00	096604	
9602-46 - Double box track only, heavy duty aluminum	46" (1168 mm)	AL	32.90	096582	5
9602-58 - Double box track only, heavy duty aluminum	58" (1473 mm)	AL	40.60	096583	
9602-70 - Double box track only, heavy duty aluminum	70" (1778 mm)	AL	46.85	096584	
9602-94 - Double box track only, heavy duty aluminum	94" (2388 mm)	AL	60.75	096585	
9602-118 - Double box track only, heavy duty aluminum	118" (2997 mm)	AL	73.25	096586	
9602-142 - Double box track only, heavy duty aluminum	142" (3607 mm)	AL	87.20	096587	
Parts Description					
9575 - 4 ea. 9572 hangers w/ top mount plate, 1 ea. 9909 guide		27.45	137167	5	
9679 - 4 ea. 9605 hangers w/ top mount plate, 1 ea. 9909 guide		38.30	096600	5	
9680 - 4 ea. 9606 ball bearing hangers w/ top mount plate, 1 ea. 9909 guide		90.30	136357	5	
Components Description					
9572 - 4 Wheel Hanger w/ Top Mount Plate	US2D	11.85	135316	20	
9605 - 4 Wheel Hanger w/ Top Mount Plate	US2D	5.55	135317	20	
9606 - 4 Wheel Ball Bearing Hanger w/ Top Mount Plate	US2D	17.30	135318	20	
9909 - Heavy Duty Adjustable Door Guide From 3/4" to 1-3/4" (19 mm to 44 mm)	US2C	8.10	097528	20	



Sliding Door Hardware - 9844 and 9845 Packaged Sets - By-Pass



Description	Finish	2018 List	Stock No.	Case Qty.
9844 Packaged Sets for doors up to 60 lbs (27 kg).				
Contents: 9840 track and 9540 parts bag. Refer to side mount selection chart on page 2 for combination of hangers. Galvanized steel track & hardware For 1-1/8" (29 mm) and 1-3/8" (35 mm) thick doors, use 9844 pkg set. For doors 3/4" (19 mm), 1" (25 mm), and 1-3/4" (44 mm) thick, use track 9840.				
9844-48 - By-pass set for two 24" doors	48" (1219 mm)	29.65	096652	5
9844-60 - By-pass set for two 30" doors	60" (1524 mm)	32.90	096653	
9844-72 - By-pass set for two 36" doors	72" (1829 mm)	36.05	096654	
9844-96 - By-pass set for two 48" doors	96" (2438 mm)	46.05	096655	
9845 Packaged Sets for three (3) doors and doors up to 60 lbs. (27 kg) per door.				
Contents: 9840 track, 2 ea. 9400 hangers, 4 ea. 9401 hangers, 2 ea. 9353 guides, and 3 ea. 2610 pulls				
9845-96 - By-pass set for three 32" doors	96" (2438 mm)	53.10	096668	5
9840-46 - Galvanized steel track	45-1/2" (1156 mm)	US2H 9.55	000931	10
9840-58 - Galvanized steel track	57-1/2" (1461 mm)	US2H 11.10	000932	
9840-70 - Galvanized steel track	69-1/2" (1765 mm)	US2H 13.45	000933	
9840-81 - Galvanized steel track	80-1/2" (2045 mm)	US2H 15.80	017893	
9840-93 - Galvanized steel track	92-1/2" (2350 mm)	US2H 17.30	017006	
9840-120 - Galvanized steel track	120" (3048 mm)	US2H 22.30	017854	
9840-144 - Galvanized steel track	144" (3658 mm)	US2H 26.80	017855	
Parts Description				
9540 - 4 ea. 9401 hangers, 2 ea. 2610 pulls, 1 ea., 9351 guide		9.55	017419	10
9544 - 4 ea. 9202 hangers, 2 ea. 2630 pulls, 1 ea., 9351 guide <i>*Used to increase door weight capacity to 75 pounds*</i>		14.15	017035	
9841 - 4 ea. 9401 hangers, 2 ea. 9865 pulls, 1 ea., 9351 guide		8.10	099665	
9842 - 4 ea. 9401 hangers, 2 ea. 2630 pulls, 1 ea., 9351 guide		11.10	017424	
9843 - 4 ea. 9202 hangers, 2 ea. 9865 pulls, 1 ea., 9351 guide <i>*Used to increase door weight capacity to 75 pounds*</i>		12.65	016912	
Components Description				
2610		US3 0.95	013049	500
Finger Pull		US4 0.95	071953	
Material: Brass		US5 0.95	067282	
Overall Diameter: 31/32"		US10A 0.95	068711	
Finger Pull Diameter: 3/4"		US15 0.95	040589	
Pull Clearance: 5/16"		US15A 0.95	040590	
Projection: 1/32"		US26 0.95	013047	
		US26D 0.95	071169	
2630		US3 4.15	051919	50
Round Flush Pull		US4 4.15	073783	
Material: Brass		US5 4.15	053163	
Overall Diameter: 2-7/16"		US10A 4.15	073053	
Finger Pull Diameter: 2-1/16"		US15 4.15	073056	
Pull Clearance: 11/32"		US15A 4.15	005307	
Projection: 3/32"		US26 4.15	023430	
		US26D 4.15	023431	
9202		US2C 3.35	096562	100
Twin Wheel Hanger - Large 11/16" (18 mm) offset B				

- For additional components, refer to component section. 2. Items with the price in **bold and red** are Quick Ship items and ship in 24 hours. Please use stock number when ordering. 3. U/M is each unless otherwise noted.
4. Packaged sets and parts bags are available with optional components by special quotation.

08/21/2020

www.hagerco.com



Sliding Door Hardware - 9844 and 9845 Packaged Sets - By-Pass



Components Description	Finish	2018 List	Stock No.	Case Qty.
9351 Door Guide		2.65	096563	50
9400 Cam Adjustable Hanger - Small 3/8" (10 mm) offset A	US2C	3.35	017417	100
9401 Cam Adjustable Hanger - Large 11/16" (18 mm) offset B	US2C	3.35	096566	100
9865 Plastic Pull Overall Diameter: 1-31/32", Finger Pull Diameter: 1-19/32", Pull Clearance: 11/32", Projection: 5/64"	Plastic	1.00	098993	50



Sliding Door Hardware - 9875 Packaged Sets- By-Pass



Description	Finish	2018 List	Stock No.	Case Qty.		
9875 Packaged Sets for doors up to 250 lbs (113 kg).						
Contents: 2 ea. 9801 tracks, 4 ea. 9827 hangers w/ top mount plate, 1 ea. 9574 spacer, 1 ea. 9909 guide						
Heavy duty Aluminum box track & hardware						
For 1-3/8" (35 mm) and 1-3/4" (44 mm) thick doors.						
9574 spacer kit is used for 1-3/4" (4 mm) doors.						
No spacer kit required for 1-3/8" (35 mm) doors.						
9875-48 - By-pass set for two 24" doors		48" (1219 mm)	183.60	137420	6	
9875-60 - By-pass set for two 30" doors		60" (1524 mm)	231.70	137421		
9875-72 - By-pass set for two 36" doors		72" (1829 mm)	244.10	137422		
9875-96 - By-pass set for two 48" doors		96" (2438 mm)	273.60	137423		
Grooved fascia for painting						
9809-72 - Aluminum grooved fascia, 3-7/8" (98 mm) thick		72" (1829 mm)	AL	92.65	096646	10
9809-96 - Aluminum grooved fascia, 3-7/8" (98 mm) thick		96" (2438 mm)	AL	121.35	096647	
9801-72 - Aluminum box track		72" (1829 mm)	AL	49.90	096641	10
9801-96 - Aluminum box track		96" (2438 mm)	AL	67.00	096642	
9801-120 - Aluminum box track		120" (3048 mm)	AL	84.05	096643	
9801-144 - Aluminum box track		144" (3658 mm)	AL	109.75	096644	
9801-192 - Aluminum box track		192" (4877 mm)	AL	146.20	096645	
Components Description						
9574				4.95	015991	5
Spacer Kit - For use with 9801 - For doors 1-3/8" and 1-3/4" thick						
9827				40.60	018292	10
4 Wheel Ball bearing Hanger w/ Top Mount Plate						
9909			US2C	8.10	097528	20
Heavy Duty Adjustable Door Guide						
From 3/4" to 1-3/4" (19 mm to 44 mm)						

1. For additional components, refer to component section. 2. Items with the price in **bold and red** are Quick Ship items and ship in 24 hours. Please use stock number when ordering. 3. U/M is each unless otherwise noted.
4. Packaged sets and parts bags are available with optional components by special quotation.



Sliding Door Hardware - 9885 and 9886 Packaged Sets - By-Pass



Description	Finish	2018 List	Stock No.	Case Qty.	
9885 Packaged Sets for two (2) doors up to 250 lbs (113 kg) each.					
Contents: 9803 track, 4 ea. 9827 hangers w/ top mount plate, 1 ea. 9909 guide, 1 ea. 9815 center stop for 9886 only. Heavy duty aluminum double box track with 3-1/2" (89 mm) smooth fascia & hardware, for two doors. For 1-3/8" (35 mm) and 1-3/4" (44 mm) thick doors.					
9885-48 - By-pass set for two 24" doors	48" (1219 mm)	209.25	137463	1	
9885-60 - By-pass set for two 30" doors	60" (1524 mm)	234.80	137464		
9885-72 - By-pass set for two 36" doors	72" (1829 mm)	261.30	137465		
9885-96 - By-pass set for two 48" doors	96" (2438 mm)	297.55	137470		
9886 Packaged Sets for four (4) 24" doors up to 250 lbs. (113 kg) each.					
Contents: 9803 track, 8 ea. 9827 hangers w/ top mount plate, 2 ea. 9815 center stops, 2 ea. 9909 adjustable door guides.					
9886-96 - By-pass set for four 24" doors	96" (2438 mm)	424.25	137471	1	
Fascia is meant to be accompanied by decorative trim.					
9803-48 - Double box track w/ smooth fascia, heavy duty aluminum	48" (1219 mm)	AL	104.30	022482	2
9803-60 - Double box track w/ smooth fascia, heavy duty aluminum	60" (1524 mm)	AL	130.75	022483	
9803-72 - Double box track w/ smooth fascia, heavy duty aluminum	72" (1829 mm)	AL	155.60	022484	
9803-96 - Double box track w/ smooth fascia, heavy duty aluminum	96" (2438 mm)	AL	208.35	022485	
9803-120 - Double box track w/ smooth fascia, heavy duty aluminum	120" (3048 mm)	AL	259.70	022486	
9803-144 - Double box track w/ smooth fascia, heavy duty aluminum	144" (3658 mm)	AL	311.85	022487	
Components Description					
9815 Bumper Stop		7.10	096648	20	
9827 4 Wheel Ball bearing Hanger w/ Top Mount Plate		40.60	018292	10	
9909 Heavy Duty Adjustable Door Guide From 3/4" to 1-3/4" (19 mm to 44 mm)	US2C	8.10	097528	20	



Sliding Door Hardware - 9570 Packaged Sets - Bi-Fold



Description	Finish	2018 List	Stock No.	Case Qty.	
9570 Packaged Sets for doors up to 50 lbs (23 kg) bi-fold, 30 lbs per multi fold.					
Contents for 2 door set: 9601 Track, 9569 parts bag. Aluminum box track & hardware for 1" (25 mm) - 1-3/4" (44 mm) thick doors.					
9570-36 - Bi-fold set for two 18" doors	36" (914 mm)	AL	53.10	137161	6
9570-48 - Bi-fold set for four 12" doors	48" (1219 mm)	AL	77.95	137162	
9570-60 - Bi-fold set for four 15" doors	60" (1524 mm)	AL	84.05	137163	
9570-72 - Bi-fold set for four 18" doors	72" (1829 mm)	AL	90.30	137164	
9570-96 - Bi-fold set for four 24" doors	96" (2438 mm)	AL	102.00	137165	
9601-35 - Aluminum box track	35" (889 mm)	AL	12.65	097461	10
9601-47 - Aluminum box track	47" (1194 mm)	AL	17.30	096576	
9601-59 - Aluminum box track	59" (1499 mm)	AL	22.35	096577	
9601-71 - Aluminum box track	71" (1803 mm)	AL	24.35	096578	
9601-96 - Aluminum box track	96" (2438 mm)	AL	37.75	096579	
9601-120 - Aluminum box track	120" (3048 mm)	AL	42.15	096580	
9601-144 - Aluminum box track	144" (3658 mm)	AL	49.90	096581	
Parts Description					
9569 - 1 ea. 9572 hanger w/ top mount plate, 9618 pivot set, 9559 aligner, 9558 knob and 9815 bumper stop, 3 ea. 9220 hinges			23.50	016913	10
Components Description					
9220 Non-Mortise Bi-Fold Hinge with Screws		US2D	1.80	099119	600
9558 Wood Knob Knob Diameter: 1-1/2" Base Diameter: 15/16" Fasteners: #8 x 1-3/4" PPHWS		Wood	1.80	096567	100
9559 Aligner		US2D	1.00	096568	200
9572 4 Wheel Hanger w/ Top Mount Plate		US2D	11.85	135316	20
9815 Bumper Stop			7.10	096648	20
9618 Pivot Set - For 9570 series		-	8.10	137182	10



- For additional components, refer to component section. 2. Items with the price in **bold and red** are Quick Ship items and ship in 24 hours. Please use stock number when ordering. 3. U/M is each unless otherwise noted.
4. Packaged sets and parts bags are available with optional components by special quotation.



Sliding Door Hardware - 9860 and 9861 Packaged Sets - Bi-Fold



Description	Finish	2018 List	Stock No.	Case Qty.	
9860 Packaged Sets for doors up to 125 lbs (57 kg) per panel bi-fold.					
Contents: 9821 track, 1 ea. 9894 parts bag, and 3 ea. 1741 hinges Heavy duty Aluminum box track & hardware. For 1-3/8"(35mm) and 1-3/4"(44mm) thick doors.					
9860-30 - Bi-fold set for two 15" doors	30" (762 mm)	99.45	019456	6	
9860-36 - Bi-fold set for two 18" doors	36" (914 mm)	107.15	019452		
9860-48 - Bi-fold set for two 24" doors	48" (1219 mm)	119.75	019451		
9861 Packaged Sets for doors up to 125 lbs. (57 kg) per panel for multi-fold.					
Contents: 9821 track, 2 ea. 9894 parts bag, and 6 ea. 1741 hinges					
9861-48 - Bi-fold set for four 12" doors	48" (1219 mm)	191.10	019446	6	
9861-60 - Bi-fold set for four 15" doors	60" (1524 mm)	198.10	019439		
9861-72 - Bi-fold set for four 18" doors	72" (1829 mm)	211.85	019438		
9861-96 - Bi-fold set for four 24" doors	96" (2438 mm)	232.35	019437		
9821-59 - Aluminum box track	59" (1499 mm)	AL	30.90	019084	10
9821-71 - Aluminum box track	71" (1803 mm)	AL	38.30	019062	
9821-96 - Aluminum box track	96" (2438 mm)	AL	51.05	019061	
9821-144 - Aluminum box track	144" (3658 mm)	AL	73.95	019050	
Parts Description					
9894 - 1 ea. 9825 hanger w/ top mount plate, 9828 bi-fold pivot, 9815 bumper stop, 9559 aligner		88.00	019435	10	
Components Description					
1741 Full Mortise Plain Bearing Hinges with Screws 3-1/2" x 3-1/2"	US2D	1.90	029658	50	
9559 Aligner	US2D	1.00	096568	200	
9815 Bumper Stop		7.10	096648	20	
9825 Ball Bearing Hanger w/ Top Mount Plate		34.95	135321	10	
9828 Heavy Duty Pivot Set with 9815 Bumper Stop		50.50	018286	10	

1. For additional components, refer to component section. 2. Items with the price in **bold and red** are Quick Ship items and ship in 24 hours. Please use stock number when ordering. 3. U/M is each unless otherwise noted. 4. Packaged sets and parts bags are available with optional components by special quotation.

Sliding Door Hardware - 9890 and 9891 Packaged Sets - Bi-Fold



Description	Finish	2018 List	Stock No.	Case Qty.
9890 Packaged Sets for doors up to 125 lbs (57 kg).				
Contents: 9801 track, 9827 hangers w/ top mount plate, 9828 pivots & 1741 hinges (3 ea. for 2 doors, 6 ea. for 4 doors) Heavy duty aluminum box track & hardware for 1-1/8"(29mm) and 1-3/4"(44mm) thick doors.				
9890-30 - Bi-fold set for two 15" doors	30" (762 mm)	106.70	017732	6
9890-36 - Bi-fold set for two 18" doors	36" (914 mm)	111.15	017444	
9890-48 - Bi-fold set for two 24" doors	48" (1219 mm)	124.55	017439	
9891-48 - Bi-fold set for four 12" doors	48" (1219 mm)	189.50	017438	6
9891-60 - Bi-fold set for four 15" doors	60" (1524 mm)	199.85	017437	
9891-72 - Bi-fold set for four 18" doors	72" (1829 mm)	214.65	017436	
9891-96 - Bi-fold set for four 24" doors	96" (2438 mm)	236.15	017434	
9801-48 - Aluminum box track	48" (1219 mm)	AL 33.25	040426	6
9801-72 - Aluminum box track	72" (1829 mm)	AL 49.90	096641	
9801-96 - Aluminum box track	96" (2438 mm)	AL 67.00	096642	
9801-120 - Aluminum box track	120" (3048 mm)	AL 84.05	096643	
9801-144 - Aluminum box track	144" (3658 mm)	AL 109.75	096644	
9801-192 - Aluminum box track	192" (4877 mm)	AL 146.20	096645	
Components Description				
1741		US2D 1.90	029658	50
Full Mortise Plain Bearing Hinges with Screws 3-1/2" x 3-1/2"				
9827		40.60	018292	10
4 Wheel Ball bearing Hanger w/ Top Mount Plate				
9828		50.50	018286	10
Heavy Duty Pivot Set with 9815 Bumper Stop				



1. For additional components, refer to component section. 2. Items with the price in **bold and red** are Quick Ship items and ship in 24 hours. Please use stock number when ordering. 3. U/M is each unless otherwise noted.
4. Packaged sets and parts bags are available with optional components by special quotation.



Sliding Door Hardware - 9110 and 9130 Packaged Sets - Pocket Door



Description	Finish	2018 List	Stock No.	Case Qty.
9110 Packaged Sets for doors up to 175 lbs (79 kg) per door.				
Contents: 9101 track, 9109 parts bag Heavy duty aluminum I-beam track & hardware for 1"(25mm) thick doors.				
9110-60 - Packaged set for 2'6" door	60" (1524 mm)	117.55	135334	5
9110-72 - Packaged set for 3'0" door	72" (1829 mm)	129.95	135335	
9110-84 - Packaged set for 3'6" door	84" (2134 mm)	141.55	135336	
9110-96 - Packaged set for 4'0" door	96" (2438 mm)	154.05	135337	
9110-120 - Packaged set for 5'0" door	120" (3048 mm)	158.60	135338	
9110-144 - Packaged set for 6'0" door	144" (3658 mm)	185.75	135339	
9130 Packaged Sets for doors up to 275 lbs (125 kg) per door.				
Contents: 9101 track, 9129 parts bag				
9130-60 - Packaged set for 2'6" door	60" (1524 mm)	150.15	135340	5
9130-72 - Packaged set for 3'0" door	72" (1829 mm)	161.00	135341	
9130-84 - Packaged set for 3'6" door	84" (2134 mm)	162.60	135342	
9130-96 - Packaged set for 4'0" door	96" (2438 mm)	177.25	135343	
9130-120 - Packaged set for 5'0" door	120" (3048 mm)	209.80	135344	
9130-144 - Packaged set for 6'0" door	144" (3658 mm)	234.10	135346	
9101-60 - I-beam track only, heavy duty aluminum	60" (1524 mm)	AL 54.85	023278	5
9101-72 - I-beam track only, heavy duty aluminum	72" (1829 mm)	AL 68.65	096508	
9101-84 - I-beam track only, heavy duty aluminum	84" (2134 mm)	AL 81.80	096509	
9101-96 - I-beam track only, heavy duty aluminum	96" (2438 mm)	AL 87.45	096707	
9101-120 - I-beam track only, heavy duty aluminum	120" (3048 mm)	AL 114.40	096511	
9101-144 - I-beam track only, heavy duty aluminum	144" (3658 mm)	AL 137.65	096512	
9101-192 - I-beam track only, heavy duty aluminum	192" (4877 mm)	AL 182.75	096513	
Parts Description				
9109 - 2 ea. 9102 two wheel hangers, 1 ea. 9115 floor guide. <i>*Up to 175 lbs (79 kg) per door.*</i>		56.95	135690	10
9129 - 2 ea. 9105 four wheel hangers, 1 ea. 9115 floor guide <i>*Up to 275 lbs (125 kg) per door.*</i>		84.05	135315	10
Components Description				
9102 2 Wheel Hanger - For use with 9101 track	US2C	25.00	135310	20
9105 4 Wheel Hanger - For use with 9101 track	US2C	37.50	135312	40
9115 Bottom Door Guide	US2C	8.85	096522	50



1. For additional components, refer to component section. 2. Items with the price in **bold and red** are Quick Ship items and ship in 24 hours. Please use stock number when ordering. 3. U/M is each unless otherwise noted.
4. Packaged sets and parts bags are available with optional components by special quotation.

Sliding Door Hardware - 9628 | 9629 | 9630 | 9631 - Pocket Door Framed Kits



Description		Finish	2018 List	Stock No.	Case Qty.
9628 - For 3'0" wide x 9'0" high doors up to 75 lbs (34 kg) per door.	108" (2743 mm)	AL	245.70	136339	1
9629 - For 3'0" wide x 8'0" high doors up to 75 lbs (34 kg) per door.	96" (2134 mm)	AL	223.85	136341	1
9630 - For 3'0" wide x 7'0" high doors up to 75 lbs (34 kg) per door.	84" (2134 mm)	AL	219.30	136343	1
9631 - For 3'0" wide x 6'8" high doors up to 75 lbs (34 kg) per door.	80" (2032 mm)	AL	140.10	137180	1

Note: Packaged sets contents: 9601 track, 1 header assembly, 2 pair of split studs, 2 floor plates and 2 end brackets, 2 each 9606 ball bearing hangers w/ top mount plate, 1 each 9881 bumper, and 1 each 9883 door guide set. For 1-3/8"(35mm) and 1-3/4"(44 mm) thick doors.



Replacement Description					
9601-71 - Aluminum box track	71" (1803 mm)	AL	24.35	096578	10
9601-84 - Aluminum box track	84" (2134 mm)	AL	32.90	045141	
9601-96 - Aluminum box track	96" (2438 mm)	AL	37.75	096579	
9601-120 - Aluminum box track	120" (3048 mm)	AL	42.15	096580	
9601-144 - Aluminum box track	144" (3658 mm)	AL	49.90	096581	
9606 4 Wheel Ball Bearing Hanger w/ Top Mount Plate		US2D	17.30	135318	20
9881 Rubber Bumper			1.00	096685	80
9883 2-Piece Door Guide set with screws			3.70	096686	100



- For additional components, refer to component section. 2. Items with the price in **bold and red** are Quick Ship items and ship in 24 hours. Please use stock number when ordering. 3. U/M is each unless otherwise noted.
4. Packaged sets and parts bags are available with optional components by special quotation.

08/21/2020

www.hagerco.com



Sliding Door Hardware - 9678 Packaged Sets - Pocket Door

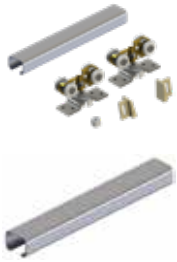

Description	Finish	2018 List	Stock No.	Case Qty.	
9678 Packaged Sets up to 125 lbs. (57 kg) per door.					
Contents: 9601 track, 9632 parts bag. For 1-3/8" (35mm) and 1-3/4" (44mm) thick doors. Heavy duty Aluminum box track & hardware					
9678-72 - Pocket set for 3' door		72" (1829 mm)	83.20	136354	6
9678-96 - Pocket set for 4' door		96" (2438 mm)	99.65	136356	
9601-71 - Box track only, heavy duty aluminum		71" (1803 mm)	AL 24.35	096578	6
9601-84 - Box track only, heavy duty aluminum		84" (2134 mm)	AL 32.90	045141	
9601-96 - Box track only, heavy duty aluminum		96" (2438 mm)	AL 37.75	096579	
9601-120 - Box track only, heavy duty aluminum		120" (3048 mm)	AL 42.15	096580	
9601-144 - Box track only, heavy duty aluminum		144" (3658 mm)	AL 49.90	096581	
Parts Description					
9632 - 2 ea. 9605 hangers w/ top mount plate, 1 ea. 9883 door guide, 1 ea. 9881 bumper. <i>*Up to 125 lbs (57 kg) per door.*</i>			32.90	135322	10
9633 - 2 ea. 9606 ball bearing hangers w/ top mount plate, 1 ea. 9883 door guide, 1 ea. 9881 bumper. <i>*Up to 150 lbs (69 kg) per door.*</i>			54.55	135323	
Components Description					
9605 4 Wheel Hanger w/ Top Mount Plate	US2D		5.55	135317	20
9606 4 Wheel Ball Bearing Hanger w/ Top Mount Plate	US2D		17.30	135318	20
9881 Rubber Bumper			1.00	096685	80
9883 2-Piece Door Guide set with screws			3.70	096686	100



Sliding Door Hardware - 9850 - Pocket Door Framed Kits



Description		Finish	2018 List	Stock No.	Case Qty.
9850 - For 4'0" wide x 8'0" high doors, up to 250 lbs.(113 kg) per door.	96" (2438 mm)	AL	393.25	139083	1
9850 - For 4'0" wide x 8'6" high doors, up to 250 lbs.(113 kg) per door.	102" (2591 mm)	AL	458.45	139085	1
Note: Packaged sets contents: 9801 track, 1 header assembly, 3 pairs of split studs, 2 each 9827 hangers w/ top mount plate, 1 ea. 9881 bumper, 1ea. 9883 door guide set, 3 floor plates and 2 end brackets. For 1-3/8"(35mm) and 1-3/4"(44mm) thick doors.					
Replacement Description					
9801-72 - Box Track only, Heavy Duty Aluminum	72" (1829 mm)	AL	49.90	096641	5
9801-96 - Box Track only, Heavy Duty Aluminum	96" (2438 mm)	AL	67.00	096642	
9801-120 - Box Track only, Heavy Duty Aluminum	120" (3048 mm)	AL	84.05	096643	
9801-144 - Box Track only, Heavy Duty Aluminum	144" (3658 mm)	AL	109.75	096644	
9801-192 - Box Track only, Heavy Duty Aluminum	192" (4877 mm)	AL	146.20	096645	
9827 4 Wheel Ball bearing Hanger w/ Top Mount Plate			40.60	018292	10
9881 Rubber Bumper			1.00	096685	80
9883 2-Piece Door Guide set with screws			3.70	096686	100

1. For additional components, refer to component section. 2. Items with the price in **bold and red** are Quick Ship items and ship in 24 hours. Please use stock number when ordering. 3. U/M is each unless otherwise noted.
4. Packaged sets and parts bags are available with optional components by special quotation.



Sliding Door Hardware - 9878 Packaged Sets - Pocket Door



Description	Finish	2018 List	Stock No.	Case Qty.		
9878 Packaged Sets for doors up to 250 lbs. (113 kg) per door.						
For doors 1-3/8" (35 mm) thick and up. Contents: 9801 track, 9742 parts bag						
9878-72 - Pocket set for 3' door		72" (1829 mm)	134.95	137425	6	
9878-96 - Pocket set for 4' door		96" (2438 mm)	179.80	137426		
9801-72 - Box track only, heavy duty aluminum		72" (1829 mm)	AL	49.90	096641	10
9801-96 - Box track only, heavy duty aluminum		96" (2438 mm)	AL	67.00	096642	
9801-120 - Box track only, heavy duty aluminum		120" (3048 mm)	AL	84.05	096643	
9801-144 - Box track only, heavy duty aluminum		144" (3658 mm)	AL	109.75	096644	
9801-192 - Box track only, heavy duty aluminum		192" (4877 mm)	AL	146.20	096645	
Parts Description						
9742 - 2 ea. 9827 hangers w/ top mount plate, 1 ea. 9883 guide set, 1 ea. 9881 bumper			85.70	137418	10	
Components Description						
9827 4 Wheel Ball bearing Hanger w/ Top Mount Plate			40.60	018292	10	
9881 Rubber Bumper			1.00	096685	80	
9883 2-Piece Door Guide set with screws			3.70	096686	100	



Sliding Door Hardware - 9901 Packaged Sets - Pocket Door

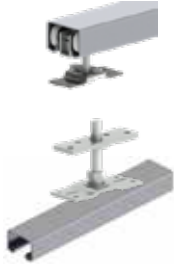

Description	Finish	2018 List	Stock No.	Case Qty.
9901 Packaged Sets for doors up to 250 lbs. (113 kg)				
Contents: 9821 track, 9895 parts bag				
Extra heavy duty Aluminum box track & hardware for 1-3/8"(35mm) and 1-3/4"(44mm) thick doors.				
9901-72 - Pocket set for 3' doors	72" (1829 mm)	141.70	019361	6
9901-96 - Pocket set for 4' doors	96" (2438 mm)	158.60	019358	
9821-59 - Aluminum box track	59" (1499 mm)	AL 30.90	019084	10
9821-71 - Aluminum box track	71" (1803 mm)	AL 38.30	019062	
9821-96 - Aluminum box track	96" (2438 mm)	AL 51.05	019061	
9821-144 - Aluminum box track	144" (3658 mm)	AL 73.95	019050	
Parts Description				
9895 - 2 ea. 9825 hangers w/ top mount plate, 1 ea. 9883 guide set, 1 ea. 9881 bumper		69.90	019408	10
Components Description				
9825 Ball Bearing Hanger w/ Top Mount Plate		34.95	135321	10
9881 Rubber Bumper		1.00	096685	80
9883 2-Piece Door Guide set with screws		3.70	096686	100

1. For additional components, refer to component section. 2. Items with the price in **bold and red** are Quick Ship items and ship in 24 hours. Please use stock number when ordering. 3. U/M is each unless otherwise noted.
4. Packaged sets and parts bags are available with optional components by special quotation.



Sliding Door Hardware - 9710 Packaged Sets - Wall-Mount

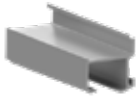

Description	Finish	2018 List	Stock No.	Case Qty.	
9710 Packaged Sets for heavy duty single doors and bi-parting doors up to 250 lbs. (113kg)					
Contents of Packaged Sets: 9703 track, 9704 fascia, 9705 end caps and 9711 parts bags. (2 ea. 9711 parts bags included in 144" pkg set.) Heavy duty aluminum wall-mount box track, anodized fascia, end caps and hardware for 1"(25mm and 1-3/4"(44mm) thick doors.					
9710-60 - Wall-Mount Packaged Set for 1 Door	60" (1524 mm)	CLA	222.05	160955	1
9710-72 - Wall-Mount Packaged Set for 1 Door	72" (1829 mm)	CLA	235.65	160958	
9710-96 - Wall-Mount Packaged Set for 1 Door	96" (2438 mm)	CLA	271.90	160959	
9710-144 - Wall-Mount Packaged Set for 1 or 2 Doors	144" (3658 mm)	CLA	453.20	160991	
9710-60 - Wall-Mount Packaged Set for 1 Door	60" (1524 mm)	DBA	277.60	160961	1
9710-72 - Wall-Mount Packaged Set for 1 Door	72" (1829 mm)	DBA	294.60	160962	
9710-96 - Wall-Mount Packaged Set for 1 Door	96" (2438 mm)	DBA	339.90	160963	
9710-144 - Wall-Mount Packaged Set for 1 or 2 Doors	144" (3658 mm)	DBA	577.05	160989	
9703-60 - Wall-Mount Track-mill finish	60" (1524 mm)	ALM	66.65	160984	5
9703-72 - Wall-Mount Track-mill finish	72" (1829 mm)	ALM	70.70	160985	
9703-96 - Wall-Mount Track-mill finish	96" (2438 mm)	ALM	81.60	160986	
9703-144 - Wall-Mount Track-mill finish	144" (3658 mm)	ALM	156.55	160988	
9703-60 - Wall-Mount Track- dark bronze anodized	60" (1524 mm)	DBA	103.00	160993	5
9703-72 - Wall-Mount Track- dark bronze anodized	72" (1829 mm)	DBA	109.70	160994	
9703-96 - Wall-Mount Track- dark bronze anodized	96" (2438 mm)	DBA	126.70	160995	
9703-144 - Wall-Mount Track- dark bronze anodized	144" (3658 mm)	DBA	243.10	160996	
9704-60 - Wall-Mount Fascia- clear anodized	60" (1524 mm)	CLA	86.65	161003	5
9704-72 - Wall-Mount Fascia- clear anodized	72" (1829 mm)	CLA	91.95	161004	
9704-96 - Wall-Mount Fascia- clear anodized	96" (2438 mm)	CLA	106.10	161005	
9704-144 - Wall-Mount Fascia- clear anodized	144" (3658 mm)	CLA	203.95	161006	
9704-60 - Wall-Mount Fascia-dark bronze anodized	60" (1524 mm)	DBA	133.90	161009	5
9704-72 - Wall-Mount Fascia-dark bronze anodized	72" (1829 mm)	DBA	142.85	161010	
9704-96 - Wall-Mount Fascia-dark bronze anodized	96" (2438 mm)	DBA	164.55	161011	
9704-144 - Wall-Mount Fascia-dark bronze anodized	144" (3658 mm)	DBA	315.20	161012	
Parts Description					
9705 - End Cap Set- anodized		CLA	68.00	161013	10
		DBA	81.60	161014	10
9711 - Parts Bag: 2 ea. 9827 hangers w/ top mount plate, 1 ea. 9115 bottom door guide, 4 ea 9815 bumper stops			66.95	161015	10
Components Description					
9115 Bottom Door Guide		US2C	8.85	096522	50
9815 Bumper Stop			7.10	096648	20
9827 4 Wheel Ball Bearing Hanger w/ Top Mount Plate			40.60	018292	10



Sliding Door Hardware - Components



Description	Finish	2018 List	Stock No.	Case Qty.
330D	US3	11.78	086840	20
Pocket Door Latch	US5	11.78	086841	
Material: Cast brass	US10	13.18	066707	
Fits: 1-3/8" - 1-3/4" door	US10B	14.70	056768	
Size: 2-3/4" x 2-1/2"	US15	11.78	078972	
Finger Pull Extends: 1-3/8"	US15A	12.55	054061	
Fasteners: #6 x 5/8" OPHWS	US19	7.45	054570	
	US26	11.78	086837	
	US26D	12.55	086838	



330L	US3	13.75	143162	20
Privacy Pocket Door Latch	US5	14.08	143164	
Material: Brass	US10	9.53	014365	
Size: 2-3/4" x 2-1/2"	US10B	16.68	143158	
Finger Pull Extends: 1-3/8"	US15	14.18	143159	
Strike: 1" x 2-1/4"	US15A	14.08	143160	
1-3/8" doors	US19	14.08	143166	
Fasteners: #6 x 5/8" OPHWS; #6 x 3/4" FPHWS	US26	13.75	143167	
	US26D	14.50	143161	



330M	US3	14.55	143172	20
Privacy Pocket Door Latch	US5	25.20	143178	
Material: Brass	US10	33.55	143168	
Size: 2-3/4" x 2-1/2"	US10B	15.40	143169	
Finger Pull Extends: 1-3/8"	US15	33.55	143173	
Strike: 1" x 2-1/4"	US15A	33.55	143174	
1-3/4" doors	US19	33.55	143175	
Fasteners: #6 x 5/8" OPHWS; #6 x 3/4" FPHWS	US26	14.55	143170	
	US26D	13.70	143171	



1741	US2D	1.90	029658	50
Full Mortise Plain Bearing Hinges with Screws				
3-1/2" x 3-1/2"				



2610	US3	0.95	013049	500
Finger Pull	US4	0.95	071953	
Material: Brass	US5	0.95	067282	
Overall Diameter: 31/32"	US10A	0.95	068711	
Finger Pull Diameter: 3/4"	US15	0.95	040589	
Pull Clearance: 5/16"	US15A	0.95	040590	
Projection: 1/32"	US26	0.95	013047	
	US26D	0.95	071169	



2620	US3	1.60	013081	50
Round Flush Pull	US4	1.60	072997	
Material: Brass	US5	1.60	072148	
Overall Diameter: 31/32"	US10A	1.60	072534	
Finger Pull Diameter: 1-11/16"	US15	1.60	072624	
Pull Clearance: 11/32"	US15A	1.60	072158	
Projection: 5/64"	US26	1.60	072554	
	US26D	1.60	075322	











- For additional components, refer to component section.
- Items with the price in **bold and red** are Quick Ship items and ship in 24 hours. Please use stock number when ordering.
- U/M is each unless otherwise noted.
- Packaged sets and parts bags are available with optional components by special quotation.

08/21/2020

www.hagerco.com



Sliding Door Hardware - Components

	Description	Finish	2018 List	Stock No.	Case Qty.	
	2630	US3	4.15	051919	50	
	Round Flush Pull	US4	4.15	073783		
	Material: Brass	US5	4.15	053163		
	Overall Diameter: 2-7/16"	US10A	4.15	073053		
	Finger Pull Diameter: 2-1/16"	US15	4.15	073056		
	Pull Clearance: 11/32"	US15A	4.15	005307		
	Projection: 3/32"	US26	4.15	023430		
		US26D	4.15	023431		
	2640	US3	5.85	096760	50	
	Oblong Flush Pull	US4	5.85	075056		
	Material: Brass	US5	5.85	074270		
	Size: 1-5/16" x 2-3/4"	US10A	5.85	074533		
	Cup Clearance: 5/16"	US15	5.85	074711		
	Fasteners: #6 x 5/8" OPHWS	US15A	5.85	074350		
		US26	5.85	026751		
		US26D	5.85	074664		
	9101-60	60" (1524 mm)	AL	54.85	023278	5
	I-beam track, heavy duty aluminum	72" (1829 mm)	AL	68.65	096508	
		84" (2134 mm)	AL	81.80	096509	
		96" (2438 mm)	AL	87.45	096707	
		120" (3048 mm)	AL	114.40	096511	
		144" (3658 mm)	AL	137.65	096512	
	192" (4877 mm)	AL	182.75	096513		
	9102	US2C	25.00	135310	20	
	2 Wheel Hanger					
	9105	US2C	37.50	135312	40	
	4 Wheel Hanger					
	9109		56.95	135690	10	
	Parts Bag: 2 ea. 9102 two wheel hangers, 1 ea. 9115 floor guide					
	9111	US2C	4.10	096516	20	
	Bottom Roller Guide					
	9113	AL	53.90	135314	10	
	Stop					
	9114-72 - Bottom Guide Track- 72"	72" (1829 mm)	AL	40.60	096519	5
	9114-96 - Bottom Guide Track- 96"	96" (2438 mm)	AL	53.90	096520	5
	9114-144 - Bottom Guide Track- 144"	144" (3658 mm)	AL	81.00	096521	5
	9115	US2C	8.85	096522	50	
	Bottom Door Guide					



Sliding Door Hardware - Components



Description	Finish	2018 List	Stock No.	Case Qty.
9121 Roller Guide - For use with 9122 guide	US2C	16.65	137181	20
9122-48 - Bottom Guide Channel - 3/4" wide x 5/8" tall	AL	21.15	096557	5
9122-60 - Bottom Guide Channel - 3/4" wide x 5/8" tall	AL	26.65	096558	5
9122-72 - Bottom Guide Channel - 3/4" wide x 5/8" tall	AL	31.25	096559	5
9122-96 - Bottom Guide Channel - 3/4" wide x 5/8" tall	AL	41.45	096560	5
9122-120 - Bottom Guide Channel - 3/4" wide x 5/8" tall	AL	52.20	096605	5
9122-132 - Bottom Guide Channel - 3/4" wide x 5/8" tall	AL	56.95	096606	5
9122-144 - Bottom Guide Channel - 3/4" wide x 5/8" tall	AL	62.30	096607	5
9122-192 - Bottom Guide Channel - 3/4" wide x 5/8" tall	AL	83.20	096608	5
9128 Bottom Pivot Bolt and Door Plate with Bottom Pivot Floor Bracket	US2C	39.60	023150	10
9129 Parts Bag: 2 ea. 9105 4-wheel hangers, 1 ea. 9115 floor guide		84.05	135315	10
9169 Top Pivot Assembly	US2C	8.85	096635	10
9200 Hanger - Small 3/8" (10 mm) offset A		1.80	016575	100
9201 Hanger - Large 1 1/16" (18 mm) offset B	US2C	1.80	096561	100
9202 Twin Wheel Hanger - Large 1 1/16" (18 mm) offset B	US2C	3.35	096562	100
9203 Twin Wheel Hanger - Small 3/8" (10 mm) offset A	US2C	3.35	017007	100
9220 Non-Mortise Bi-Fold Hinge with Screws	US2D	1.80	099119	600
9262 - Keyed Lock for pocket door applications	US3	43.70	098994	6
	US26D	44.85	016724	
9264 - Keyed Lock for bifold applications	US3	37.50	016725	6
Keyed Lock - Keyed Alike	US3	37.50	002801	
9268 - Keyed Lock for bypass applications	US3	42.15	016726	6
	US26D	42.95	099251	
Keyed Lock - Keyed Alike	US3	42.15	002804	6
	US26D	42.95	002802	

- For additional components, refer to component section.
- Items with the price in **bold and red** are Quick Ship items and ship in 24 hours. Please use stock number when ordering.
- U/M is each unless otherwise noted.
- Packaged sets and parts bags are available with optional components by special quotation.

08/21/2020

www.hagerco.com



Sliding Door Hardware - Components



Description	Finish	2018 List	Stock No.	Case Qty.
9351 Door Guide		2.65	096563	50
9353 Adjustable Door Guide		2.65	096564	20
9354 Carpet Riser	US2C	1.80	003633	50
	US2D	1.80	096565	50
9400 Cam Adjustable Hanger - Small 3/8" (10 mm) offset A	US2C	3.35	017417	100
9401 Cam Adjustable Hanger - Large 11/16" (18 mm) offset B	US2C	3.35	096566	100
9540 Parts Bag: 4 ea. 9401 hangers, 2 ea. 2610 pulls, 1 ea. 9351 guide		9.55	017419	10
9544 Parts Bag: 4 ea. 9202 hangers, 2 ea. 2630 pulls, 1 ea. 9351 guide Used to increase door weight capacity to 75 lbs		14.15	017035	10
9558 Wood Knob Knob Diameter: 1-1/2" Base Diameter: 15/16" Fasteners: #8 x 1-3/4" PPHWS	Wood	1.80	096567	100
9559 Aligner	US2D	1.00	096568	200
9566 Knob Material: Zinc Knob Diameter: 1-1/4" Projection: 1" Fasteners: #8 - 32 x 2" PPHMS; #8 - 32 x 1-3/4" PPHMS	US3	6.80	099824	100
	US4	7.65	098635	
	US5	7.65	028859	
	US10A	7.65	098634	
	US10B	7.65	098633	
	US15	7.65	098632	
	US15A	7.65	098629	
	US26	6.80	098628	
US26D	7.65	098627		





Description	Finish	2018 List	Stock No.	Case Qty.		
9567 Rose - For use with 9566 knob Material: Zinc Base Diameter: 1-3/4" Projection: 15/32" Fasteners: #8 - 32 x 2" PPHMS; #8 - 32 x 1-3/4" PPHMS	US3	3.20	099825	100		
	US4	3.40	098626			
	US5	3.40	018102			
	US10A	3.40	098625			
	US10B	3.40	098624			
	US15	3.40	098623			
	US15A	3.40	098622			
	US26	3.20	098621			
	US26D	3.40	098620			
9569 Parts Bag: 1 ea. 9572 hanger w/ top mount plate, 9618 pivot set, 9559 aligner, 9558 knob and 9815 bumper stop, 3 ea. 9220 hinges		23.50	016913	10		
9572 4-Wheel Hanger w/ Top Mount Plate	US2D	11.85	135316	20		
9573 Spacer Kit - 3/8" use with 9821 track - For doors 1-3/4" thick		4.95	019014	5		
9574 Spacer Kit - For use with 9801 - For doors 1-3/8" and 1-3/4" thick		4.95	015991	5		
9575 Parts Bag: 4 ea. 9572 hangers w/ top mount plate, 1 ea. 9909 guide		27.45	137167	5		
9601-71 - Aluminum box track		71" (1803 mm)	AL	24.35	096578	
9601-84 - Aluminum box track		84" (2134 mm)	AL	32.90	045141	
9601-96 - Aluminum box track		96" (2438 mm)	AL	37.75	096579	
9601-120 - Aluminum box track		120" (3048 mm)	AL	42.15	096580	
9601-144 - Aluminum box track		144" (3658 mm)	AL	49.90	096581	
9602-46 - Double box track only, heavy duty aluminum		46" (1168 mm)	AL	32.90	096582	5
9602-58 - Double box track only, heavy duty aluminum		58" (1473 mm)	AL	40.60	096583	
9602-70 - Double box track only, heavy duty aluminum		70" (1778 mm)	AL	46.85	096584	
9602-94 - Double box track only, heavy duty aluminum		94" (2388 mm)	AL	60.75	096585	
9602-118 - Double box track only, heavy duty aluminum		118" (2997 mm)	AL	73.25	096586	
9602-142 - Double box track only, heavy duty aluminum		142" (3607 mm)	AL	87.20	096587	
9603-48 - Aluminum box track with fascia		48" (1219 mm)	AL	60.75	135288	5
9603-60 - Aluminum box track with fascia		60" (1524 mm)	AL	73.25	135289	
9603-72 - Aluminum box track with fascia		72" (1829 mm)	AL	87.20	135290	
9603-96 - Aluminum box track with fascia		96" (2438 mm)	AL	113.70	135291	
9603-120 - Aluminum box track with fascia		120" (3048 mm)	AL	142.40	029359	
9603-144 - Aluminum box track with fascia		144" (3658 mm)	AL	175.05	029360	
9605 4-Wheel Hanger w/ Top Mount Plate	US2D	5.55	135317	20		

1. For additional components, refer to component section. 2. Items with the price in **bold and red** are Quick Ship items and ship in 24 hours. Please use stock number when ordering. 3. U/M is each unless otherwise noted.
 4. Packaged sets and parts bags are available with optional components by special quotation.



Sliding Door Hardware - Components



Description	Finish	2018 List	Stock No.	Case Qty.	
9606 4-Wheel Ball Bearing w/ Top Mount Plate	US2D	17.30	135318	20	
9610 Replacement Top Mount Plate	US2C	1.80	142410	20	
9618 Pivot Set - For 9570 series	-	8.10	137182	10	
9632 Pocket Parts Bag -125 lbs (57 kg) Consists of: 2 ea. 9605 hangers w/ top mount plate, 1 ea. 9883 guide set, 1 ea. 9881 bumper		32.90	135322	10	
9633 Parts Bag : 2 ea. 9606 ball bearing hangers w/ top mount plate, 1 ea. 9883 guide set, 1 ea. 9881 bumper		54.55	135323	10	
9634 Pocket Door Adapter Kit For 1-3/4" (45 mm) thick doors		8.50	097519	10	
9639 Double Pocket Door Adapter Kit Joins two frames in middle of doorway	US2C	24.35	096595	1	
9679 4 ea. 9605 hangers w/ top mount plate, 1 ea. 9909 guide		38.30	137179	20	
9680 4 ea. 9606 ball bearing hangers w/ top mount plate, 1 ea. 9909 guide		90.30	136357	20	
9703-60 - Wall-Mount Track-mill finish	60" (1524 mm)	ALM	66.65	160984	5
9703-72 - Wall-Mount Track-mill finish	72" (1829 mm)	ALM	70.70	160985	
9703-96 - Wall-Mount Track-mill finish	96" (2438 mm)	ALM	81.60	160986	
9703-144 - Wall-Mount Track-mill finish	144" (3658 mm)	ALM	156.55	160988	
9703-60 - Wall-Mount Track- dark bronze anodized	60" (1524 mm)	DBA	103.00	160993	5
9703-72 - Wall-Mount Track- dark bronze anodized	72" (1829 mm)	DBA	109.70	160994	
9703-96 - Wall-Mount Track- dark bronze anodized	96" (2438 mm)	DBA	126.70	160995	
9703-144 - Wall-Mount Track- dark bronze anodized	144" (3658 mm)	DBA	243.10	160996	



Sliding Door Hardware - Components



Description		Finish	2018 List	Stock No.	Case Qty.
9704-60 - Wall-Mount Fascia- clear anodized	60" (1524 mm)	CLA	86.65	161003	5
9704-72 - Wall-Mount Fascia- clear anodized	72" (1829 mm)	CLA	91.95	161004	
9704-96 - Wall-Mount Fascia- clear anodized	96" (2438 mm)	CLA	106.10	161005	
9704-144 - Wall-Mount Fascia- clear anodized	144" (3658 mm)	CLA	203.95	161006	
9704-60 - Wall-Mount Fascia-dark bronze anodized	60" (1524 mm)	DBA	133.90	161009	5
9704-72 - Wall-Mount Fascia-dark bronze anodized	72" (1829 mm)	DBA	142.85	161010	
9704-96 - Wall-Mount Fascia-dark bronze anodized	96" (2438 mm)	DBA	164.55	161011	
9704-144 - Wall-Mount Fascia-dark bronze anodized	144" (3658 mm)	DBA	315.20	161012	
9705 - End Cap Set- anodized		CLA	68.00	161013	10
		DBA	81.60	161014	10
9709-60 - Fascia only, 2-3/4" (70 mm) wide	60" (1524 mm)	AL	51.55	023322	
9709-72 - Fascia only, 2-3/4" (70 mm) wide	72" (1829 mm)	AL	59.15	096603	
9709-96 - Fascia only, 2-3/4" (70 mm) wide	96" (2438 mm)	AL	67.00	096604	
9711			66.95	161015	10
Parts Bag: 2 ea. 9827 hangers w/ top mount plate, 1 ea. 9115 bottom door guide, 4 ea. 9815 bumper stops					
9742			85.70	137418	10
Parts Bag: 2 ea. 9816 hangers w/ top mount plate, 1 ea. 9883 guide set, 1 ea. 9881 bumper					
9801-72 - Box Track, Heavy Duty Aluminum	72" (1829 mm)	AL	49.90	096641	5
9801-96 - Box Track, Heavy Duty Aluminum	96" (2438 mm)	AL	67.00	096642	
9801-120 - Box Track, Heavy Duty Aluminum	120" (3048 mm)	AL	84.05	096643	
9801-144 - Box Track, Heavy Duty Aluminum	144" (3658 mm)	AL	109.75	096644	
9801-192 - Box Track, Heavy Duty Aluminum	192" (4877 mm)	AL	146.20	096645	
9803-48 - Double Box Track w/ Fascia, Heavy Duty Aluminum	48" (1219 mm)	AL	104.30	022482	2
9803-60 - Double Box Track w/ Fascia, Heavy Duty Aluminum	60" (1524 mm)	AL	130.75	022483	
9803-72 - Double Box Track w/ Fascia, Heavy Duty Aluminum	72" (1829 mm)	AL	155.60	022484	
9803-96 - Double Box Track w/ Fascia, Heavy Duty Aluminum	96" (2438 mm)	AL	208.35	022485	
9803-120 - Double Box Track w/ Fascia, Heavy Duty Aluminum	120" (3048 mm)	AL	259.70	022486	
9803-144 - Double Box Track w/ Fascia, Heavy Duty Aluminum	144" (3658 mm)	AL	311.85	022487	
9809-72 - Aluminum Fascia, 3-7/8" (98 mm) high	72" (1829 mm)	AL	92.65	096646	10
9809-96 - Aluminum Fascia, 3-7/8" (98 mm) high	96" (2438 mm)	AL	121.35	096647	
9810-46 - Aluminum Track	46-3/8" (1178 mm)	AL	15.80	019702	10
9810-58 - Aluminum Track	58-3/8" (1483 mm)	AL	18.85	019703	
9810-70 - Aluminum Track	70-3/8" (1788 mm)	AL	22.90	019704	
9810-93 - Aluminum Track	93-3/8" (2372 mm)	AL	29.65	019705	
9810-120 - Aluminum Track	120" (3048 mm)	AL	37.50	016570	
9810-144 - Aluminum Track	144" (3658 mm)	AL	49.90	026064	

1. For additional components, refer to component section. 2. Items with the price in **bold and red** are Quick Ship items and ship in 24 hours. Please use stock number when ordering. 3. U/M is each unless otherwise noted.
4. Packaged sets and parts bags are available with optional components by special quotation.

08/21/2020

www.hagerco.com



Sliding Door Hardware - Components



Description	Finish	2018 List	Stock No.	Case Qty.	
9814 Parts bag: 2 ea. 9400 hangers, 2 ea. 9401 hangers, 2 ea. 2610 pulls, 1 ea. 9353 guide set. For 1" to 1-1/8" doors, specify 9841 parts bag.		14.95	016772	10	
9815 Bumper Stop		7.10	096648	20	
9820-48 - Aluminum track with 1-3/4" grooved fascia	48" (1219 mm)	AL	29.05	000461	5
9820-60 - Aluminum track with 1-3/4" grooved fascia	60" (1524 mm)	AL	36.05	000462	
9820-72 - Aluminum track with 1-3/4" grooved fascia	72" (1829 mm)	AL	42.15	000463	
9820-84 - Aluminum track with 1-3/4" grooved fascia	84" (2134 mm)	AL	56.95	028175	
9820-96 - Aluminum track with 1-3/4" grooved fascia	96" (2438 mm)	AL	62.30	099664	
9820-120 - Aluminum track with 1-3/4" grooved fascia	120" (3048 mm)	AL	71.75	000464	
9820-144 - Aluminum track with 1-3/4" grooved fascia	144" (3658 mm)	AL	93.45	000460	
9821-59 - Aluminum box track	59" (1499 mm)	AL	30.90	019084	10
9821-71 - Aluminum box track	71" (1803 mm)	AL	38.30	019062	
9821-96 - Aluminum box track	96" (2438 mm)	AL	51.05	019061	
9821-144 - Aluminum box track	144" (3658 mm)	AL	73.95	019050	
9824 4-Wheel Hanger w/ Top Mount Plate		27.80	135320	20	
9825 4-Wheel Ball Bearing Hanger w/ Top Mount Plate		34.95	135321	10	
9827 4-Wheel Ball bearing Hanger w/ Top Mount Plate		40.60	018292	10	
9828 Heavy Duty Pivot Set with 9815 Bumper Stop		50.50	018286	10	
9840-46 - Galvanized steel track	45-1/2" (1156 mm)	US2H	9.55	000931	10
9840-58 - Galvanized steel track	57-1/2" (1461 mm)	US2H	11.10	000932	
9840-70 - Galvanized steel track	69-1/2" (1765 mm)	US2H	13.45	000933	
9840-81 - Galvanized steel track	80-1/2" (2045 mm)	US2H	15.80	017893	
9840-93 - Galvanized steel track	92-1/2" (2350 mm)	US2H	17.30	017006	
9840-120 - Galvanized steel track	120" (3048 mm)	US2H	22.30	017854	
9840-144 - Galvanized steel track	144" (3658 mm)	US2H	26.80	017855	



Sliding Door Hardware - Components



Description	Finish	2018 List	Stock No.	Case Qty.
9841 Parts Bag: 4 ea. 9402 hangers, 2 ea. 9865 pulls, 1 ea. 9351 guide		8.10	099665	10



9842 Parts Bag: 4 ea. 9402 hangers, 2 ea. 9630 pulls, 1 ea. 9351 guide		11.10	017424	10
--	--	-------	--------	----



9843 Parts Bag: 4 ea. 9401 hangers, 2 ea. 9865 pulls, 1 ea. 9351 guide. Used to increase door weight capacity to 75 lbs		12.65	016912	10
---	--	-------	--------	----



9865 Plastic Pull Overall Diameter: 1-31/32" Finger Pull Diameter: 1-19/32" Pull Clearance: 11/32" Projection: 5/64"	Plastic	1.00	098993	50
--	---------	------	--------	----



9877 Door Guide, 2 pieces required per door		1.80	016843	50
---	--	------	--------	----



9880 Stop	US2C	1.80	096684	10
---------------------	------	------	--------	----



9881 Rubber Bumper		1.00	096685	80
------------------------------	--	------	--------	----



9882 Pocket Door Edge Pull Material: Brass Finger Pull Extends: 3/4" Faceplate: 3/4" x 3-7/8" Fasteners: #6 x 5/8" FPHWS	US3	14.60	049582	100
	US4	17.65	049583	
	US10	14.60	049578	
	US10B	17.65	049580	
	US26	17.65	049579	
	US26D	17.65	049581	



9883 2-Piece Door Guide Set with Screws		3.70	096686	100
---	--	------	--------	-----



9884 Pocket Door Edge Pull Material: Zinc Finger Pull Extends: 1-1/16" Faceplate: 21/32" x 3-1/2" Fasteners: #6 x 5/8" FPHWS	US3	7.75	099056	40
--	-----	------	--------	----

- For additional components, refer to component section.
- Items with the price in **bold and red** are Quick Ship items and ship in 24 hours. Please use stock number when ordering.
- U/M is each unless otherwise noted.
- Packaged sets and parts bags are available with optional components by special quotation.

08/21/2020

www.hagerco.com



Sliding Door Hardware - Components



Description	Finish	2018 List	Stock No.	Case Qty.
9889 1-Piece Guide		1.80	096687	20
9892 Parts Bag: 4 ea. 9824 4-wheel hangers w/ top mount plate, 1 ea. 9909 guide, 1 ea. 9573 spacer kit		52.70	019421	10
9893 Parts Bag: 4 ea. 9825 4-wheel ball bearing hangers w/ top mount plate, 1 ea. 9909 guide, 1ea. 9573 spacer kit		98.60	019418	10
9894 Parts Bag: 1 ea. 9825 4-wheel ball bearing hanger w/ top mount plate, 1 ea. 9828 pivot set with 9815 bumper stop, 9559 aligner		88.00	019435	10
9895 Parts Bag: 2 ea. 9825 4-wheel ball bearing hangers w/ top mount plate, 1 ea. 9883 guide, 1 ea. 9881 bumper		69.90	019408	10
9900 Reversible Side Mount Bracket	US2C	7.10	003775	20
9909 Heavy Duty Adjustable Door Guide From 3/4" to 1-3/4" (19 mm to 44 mm)	US2C	8.10	097528	20



Sliding Door Hardware - 9400 Series Stainless Barn Door



Description

9432 Packaged Sets - Top Mount Stick 2m SS Round Rail

Includes stainless steel track with two end caps, hangers with wall brackets, one bottom door guide, two track stops, mounting and installation hardware

9432-78 - Top Mount Stick 2m (78-3/4") SS Round Rail

32D

525.00

183635

1

9432-96 - Top Mount Stick 2m (96-3/4") SS Round Rail

32D

610.00

183636

1

Finish

2018 List

Stock No.

Case Qty.



9435 Packaged Sets - Top Mount Spoke Wheel 2m SS Round Rail

Includes stainless steel track with two end caps, hangers with wall brackets, one bottom door guide, two track stops, mounting and installation hardware

9435-78 - Top Mount Spoke Wheel 2m (78-3/4") SS Round Rail

32D

530.00

183641

1

9435-96 - Top Mount Spoke Wheel 2m (96-3/4") SS Round Rail

32D

595.00

183642

1



9436 Packaged Sets - Face Mount Strap Stick 2m SS Round Rail

Includes stainless steel track with two end caps, hangers with wall brackets, one bottom door guide, two track stops, mounting and installation hardware

9436-78 - Face mount Strap Stick 2m (78-3/4") SS Round Rail

32D

580.00

183643

1

9436-96 - Face mount Strap Stick 2m (96-3/4") SS Round Rail

32D

605.00

183644

1



9438 Packaged Sets - Face Mount Strap Triangle 2m SS Round Rail

Includes stainless steel track with two end caps, hangers with wall brackets, one bottom door guide, two track stops, mounting and installation hardware

9438-78 - Face Mount Strap Triangle 2m (78-3/4") SS Round Rail

32D

760.00

183650

1

9438-96 - Face Mount Strap Triangle 2m (96-3/4") SS Round Rail

32D

840.00

183651

1



9462 Packaged Sets - Flat Rail Stick Strap SS Flat Track

Includes stainless steel track, hangers with wall brackets, one bottom door guide, two track stops, mounting and installation hardware

9462-78 - Flat Rail Stick Strap SS 72" Flat Track

32D

666.70

183683

1

9462-96 - Flat Rail Stick Strap SS 96" Flat Track

32D

733.35

183684

1

1. For additional components, refer to component section. 2. Items with the price in **bold and red** are Quick Ship items and ship in 24 hours. Please use stock number when ordering. 3. U/M is each unless otherwise noted.
4. Packaged sets and parts bags are available with optional components by special quotation.

08/21/2020

www.hagerco.com



How to Order

9458

Product Group

2D

Backset / Faceplate

2D (2-1/4")

35 (3-1/2")

BLK

Finish

BLK (Black)

US32D

US10B

For 1-3/8" (35mm) to 1-3/4"(40mm) thick doors standard.

- Non-handed.
- ADA Compliant thumb turn for commercial applications
- 2-1/4" or 3-1/2" backset options (see specifications for corresponding wall thickness).
- Drive in bolt casing diameter: 1" (25mm).
- Lock bolt: 1/2" (13mm) diameter, stainless Steel material.
- Lock bolt has 1" projection allowing up to 1/2" door to wall gap. Extra spacer ring accommodates up to 3/4" gap between barn door and wall.
- 1-1/4" diameter spring-loaded dust proof strike provides ample space to receive 1/2" bolt, allows easy locking from privacy side. Strike mounted in barn door for standard door.



Description	Finish	2018 List	Stock No.
94582D-32D Round ADA TT Stainless 2-1/4" Backset	32D	176.80	86683
94582D-10B Round ADA TT Oil Rubbed Bronze 2-1/4" Backset	10B	176.80	86672
94582D-BLK Round ADA TT Black 2-1/4" Backset	BLK	176.80	86664
945835-32D Round ADA TT Stainless Steel 3-1/2" Backset	32D	176.80	86663
945835-10B Round ADA TT Oil Rubbed Bronze 3-1/2" Backset	10B	176.80	86657
945835-BLK Round ADA TT Black 3-1/2" Backset	BLK	176.80	86653



Description	Finish	2018 List	Stock No.
9459-32D Surface Jamb Barn Door Lock ADA 1-9/16" Thumb Lever	32D	187.50	35624
9459-BLK Surface Jamb Barn Door Lock ADA 1-9/16" Thumb Lever	BLK	187.50	35617



Sliding Door Hardware - Stainless Barn Door Components



Description	Finish	2018 List	Stock No.	Case Qty.
1-269-8650 Spring-Loaded Cushion Stop for 9400 Barn Door Series	32D	28.67	86376	1
1-269-8663 Round Rail Connector SS304 satin nickel	32D	32.95	181901	1
1-269-8664 Flat Rail Connector SS304 satin nickel	32D	32.95	181902	1
1-269-8665 Tool set for 05WG; 06WG; 07WG (round rail)		3.45	183156	1
1-269-8666 Tool set for 01W; 02W (round rail)	32D	3.45	183163	1
1-269-8667 End Cap	32D	8.80	183164	1
1-269-8668 Guide for wood door		5.50	183165	1
1-269-8669 Door Stop	32D	38.45	183166	1
1-269-8670 Guide for glass door	32D	27.50	183167	1
1-269-8671 Top Mount Stick Sliding Door Roller for Wood, SS304 Satin	32D	137.35	183168	1
1-269-8672 Top Mount Dual Wheel Sliding Door Roller for Wood, SS304 Satin	32D	384.55	183170	1
1-269-8673 Top Mount Spoke Wheel Sliding Door Roller for Wood, SS304 Satin	32D	329.60	183171	1
1-269-8674 Strap Stick Sliding Door Roller for Wood and Glass, SS304 Satin	32D	274.70	183172	1
1-269-8675 Strap Dual Wheel Sliding Door Roller for Wood and Glass, SS304 Satin	32D	466.95	183173	1
1-269-8676 Strap Triangle Sliding Door Roller for Wood and Glass, SS304 Satin	32D	329.60	183176	1



Sliding Door Hardware - Stainless Barn Door Components



Description	Finish	2018 List	Stock No.	Case Qty.
1-269-8677 Flat Rail Stick Sliding Door Carrier for Wood SS304 Satin	32D	184.05	183179	1
1-269-8678 Flat Rail Door Stopper Left, SS304 Satin	32D	54.95	183180	1
1-269-8679 Flat Rail Door Stopper Right, SS304 Satin	32D	54.95	183181	1
1-269-8680 Flat Rail Anti Jump	32D	3.30	183182	1



eConestoga Barn Door Hardware Series



Description	Finish	2018 List	Stock No.
9456-72 Flat Rail Steel Black Top Mount 72" Track Kit Includes Track	BLK	212.50	96467



9456-96 Flat Rail Steel Black Top Mount 96" Track Kit Includes Track	BLK	237.50	96466
---	-----	--------	-------



9457-72 Flat Rail Steel Black 3" Hook 72" Track Kit Includes Track	BLK	237.50	96427
---	-----	--------	-------



9457-96 Flat Rail Steel Black 3" Hook 96" Track Kit Includes Track	BLK	262.50	96388
---	-----	--------	-------



1-269-8649 Flat Rail Track Connector	BLK	12.50	96361
--	-----	-------	-------



1-269-8648 72" Rail Only	BLK	87.50	96355
------------------------------------	-----	-------	-------



1-269-8647 96" Rail Only	BLK	100.00	96353
------------------------------------	-----	--------	-------



1-269-8646 Flat Rail Soft Close Add On	BLK	62.50	96352
--	-----	-------	-------

- For additional components, refer to component section. 2. Items with the price in **bold and red** are Quick Ship items and ship in 24 hours. Please use stock number when ordering. 3. U/M is each unless otherwise noted.
4. Packaged sets and parts bags are available with optional components by special quotation.



Conestoga Barn Door - How to Order

IMPORTANT:

1. Track is ordered separately from hardware kit.
2. Track and Carrier Hardware are shipped in separate cartons.

Single Door Solution:

1. **9450 Track:** Specify length (72" or 96").
2. **Carrier Hardware Kit:** Specify style – Includes all mounting hardware.

Example:

9450 - 72 / 9450 - 96

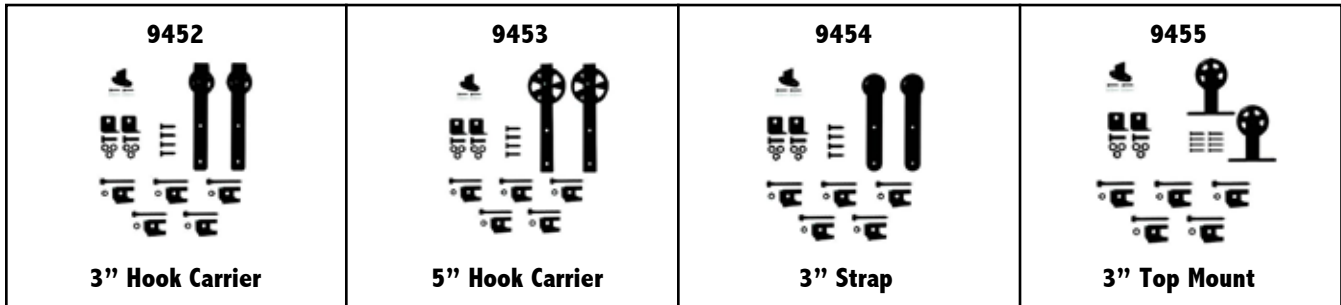

Bi-Part Door Solution:

If using two doors that are 3' wide, order a 6' track per door, for a total of 12'. This allows the doors to clear the door opening when in the open position. Order one carrier hardware kit per door and one Splice Kit.

To Order:

1. **9450 Track:** Specify quantity and length.
2. **Carrier Hardware Kit:** Specify quantity and carrier style. Example: Order 2 of part number 9453, 5" hook carrier style – Includes all mounting hardware.

Example:

9450 - 72 / 9450 - 96

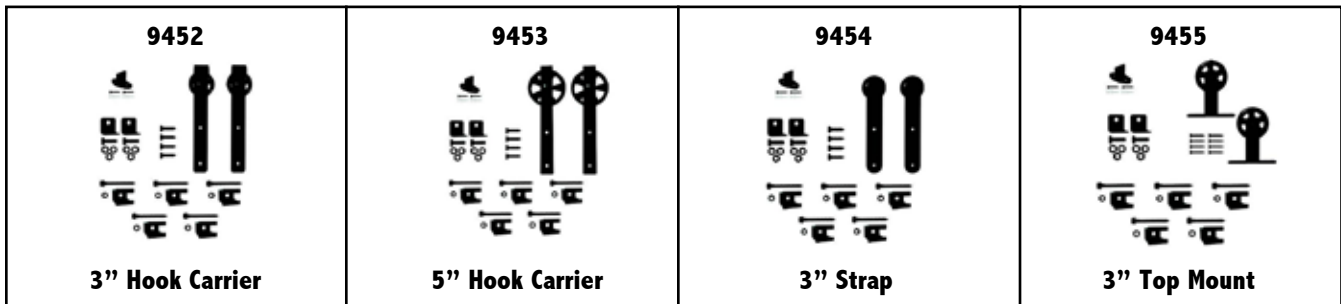

3. **Splice Kit:** Order 1 of part number 1-269-8691 Flat Rail Splice Kit.



Conestoga Barn Door - Price Sheet

Stock Number	Hager Part Number	Description	2018 List
Conestoga Barn Door			
Rail Only			
186243	9450-72	72" Black Powder Coated Flat Rail	\$113.35
186251	9450-96	96" Black Powder Coated Flat Rail	\$158.70
Hanger Kits Less Rail: All kits include two carriers, stops, floor guide and rail mounting brackets and fasteners.			
188467	9452	3" Hook Carrier Kit Less Rail - Black Powder Coated	\$570.70
188468	9453	5" Hook Carrier Kit Less Rail - Black Powder Coated	\$733.35
188469	9454	3" Strap Carrier Kit Less Rail - Black Powder Coated	\$526.65
188470	9455	3" Top Mount Carrier Kit Less Rail - Black Powder Coated	\$555.45
Optional Components			
Single Carrier w/ Fastners			
186264	1-269-8685	3" Hook Carrier - Black Powder Coated	\$274.50
186266	1-269-8686	5" Hook Carrier - Black Powder Coated	\$381.20
186267	1-269-8687	3" Strap Carrier - Black Powder Coated	\$205.90
186270	1-269-8688	3" Top Mount Carrier - Black Powder Coated	\$222.30
Privacy Latch and Pull			
186296	1-269-8693	Sliding Door Privacy Latch & Strike Plate - Black Powder Coated	\$57.35
186299	1-269-8694	4" x 1-3/4" x 7/16" Flush Pull - Black Powder Coated	\$57.35
Accessories			
186289	1-269-8689	Brack Kit: Includes 1 wall mount braket with fastener	\$25.50
186290	1-269-8690	Stop Kit: Inclues 2 end Stops with fasteners	\$76.00
186292	1-269-8691	Splice Kit: Includes splice components and fastners for joining rails	\$48.30





One Family. One Brand. One Vision.™

www.hagerco.com

TABLE OF CONTENTS

D

Door Controls

Concealed Door Closers 12
 Door Closers Accessories..... 13
 Floor Springs..... 12
 Patch Fittings 13
 Surface Door Closers..... 12

E

Euroline Hinges

1191..... 18
 1279..... 18
 7191..... 17
 7192..... 17
 BB1168..... 18
 BB1191 18
 BB1199..... 18
 BB1279..... 18
 BB6191 17

Exit Devices

Exit Devices 14
 Exit Trim 14
 Miscellaneous 14

L

Locks

Lever Sets7-10
 Lock Bodies.....5-6
 Lock Cylinders 11
 Lock Functions2-4
 Miscellaneous Lock Accessories6-7

T

Trim and Auxiliary

Coat & Hat Hooks..... 15
 Door Stops 15
 Flushbolts 15
 Miscellaneous 16
 Signage..... 15-16



Euroline Introduction

Most of us in the door hardware industry are familiar with ANSI - American National Standards Institute, BHMA - Builders Hardware Manufacturers Association, along with UL - Underwriters Laboratories and Intertek. However these standards and fire codes, which are strictly enforced in the United States and Canada, are not customary in approximately 90% of the rest of the world.

European standards - EN and CE - are dominant in Europe, the Middle East and most of Asia. Any hardware products sold into areas that embrace these standards must meet their cycle and fire tests, which are completely different than those of ANSI and UL.

Hager Companies launched the Euroline in late 2008 to provide a comprehensive product line that meets and exceeds EN and CE standards. It currently consists of a complete product portfolio including hinges, trim and auxiliary, door controls, exit devices, mortise locks, cylinders, levers, and accessories.

Since that time the product line has expanded and Hager Companies has been successful in marketing in Latin America, the Middle East and Asia. In addition, our Euroline products recently passed separate stringent fire tests in Mainland China. This will allow Hager Companies to furnish our products throughout the Peoples Republic of China on commercial buildings.

As always, service is our number one priority and that is true for our global customers as well. We have representatives across the globe as well as distribution centers in Dubai, United Arab Emirates and Zhuhai, China.





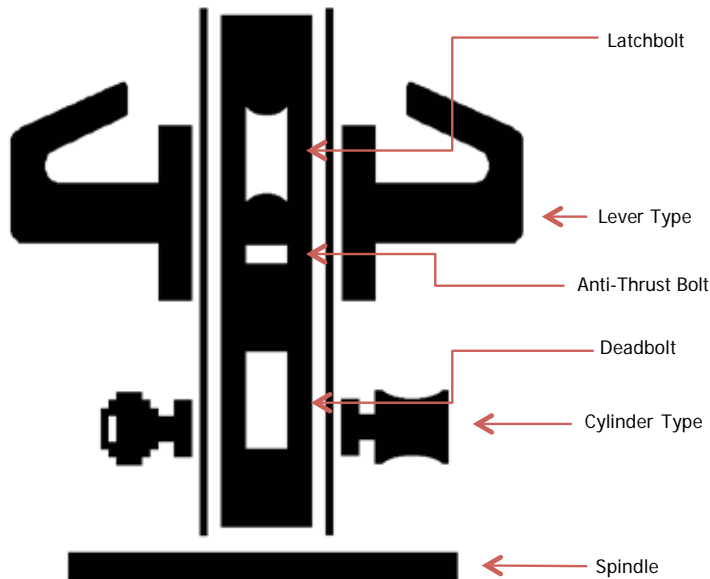

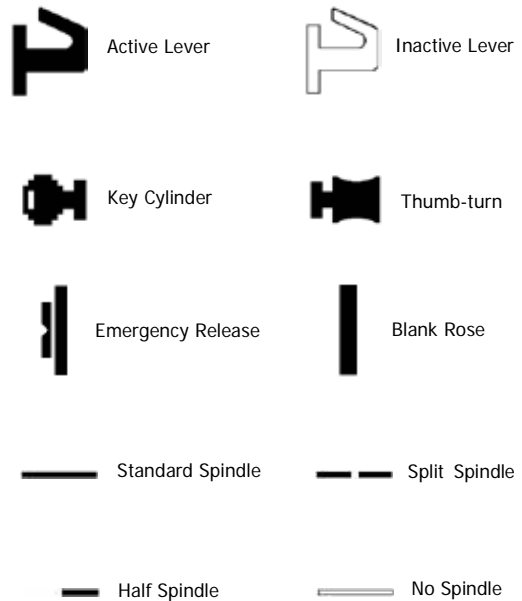

European locksets are sold in component form: lock body, lever set and cylinder. This allows end users to mix and match cylinders, levers and lock bodies. It also allows multiple mechanical and electronic keyways to be used interchangeably. This modular approach allows for greater flexibility on the jobsite.

Lock Components



Symbol Key











Picture	Function	Function Description	Required Parts
	Passage	Latchbolt operated by lever from either side at all times.	3800U-55L Leverset
	Bathroom Indicator	Latchbolt operated by lever from either side at all times. Deadbolt operated by thumbturn from inside and by emergency release with indicator from outside.	3800U-55B Leverset 2-669-0736
	Privacy	Latchbolt operated by lever from either side at all times. Deadbolt operated by thumbturn from inside and by emergency release from outside.	3800U-55S Leverset 3000R
	Classroom	Latchbolt operated by lever from either side. Deadbolt operated by key from outside. Operating inside lever retracts both latchbolt and deadbolt simultaneously.	3800U-55P Leverset Split Spindle* 3000H
	Storeroom	Latchbolt operated by key from outside or by operating inside lever. Outside lever never retracts latchbolt.	3800U-55M Leverset Half Spindle** 3000H
	Security Storeroom	Latchbolt operated by key from outside or by operating inside lever. Outside lever never retracts latch. Anti-thrust bolt.	3800U-55T Leverset Half Spindle** 3000H
	Exit	Latchbolt operated by lever from either side. Deadbolt operated by key from outside and by thumbturn from inside. Operating inside lever retracts both latchbolt and deadbolt simultaneously.	3800U-55P Leverset Split Spindle* 3000C
	Entrance	Latchbolt operated by lever from either side. Deadbolt operated by key from either side.	3800U-55S Leverset 3000D

* Use the split spindle in place of the spindle that comes with the leverset.

** Use the half spindle going into the inside lever in place of the spindle that comes with the leverset.











Picture	Function	Function Description	Required Parts
	Bedroom	Latchbolt operated by lever from either side. Deadbolt operated by thumbturn from inside and emergency release from outside. Operating inside lever retracts both latchbolt and deadbolt simultaneously.	3800U-55P Leverset Split Spindle* 3000R
	Dormitory	Latchbolt operated by lever from either side. Deadbolt operated by key from outside and thumbturn from inside.	3800U-55S Leverset 3000C
	Institutional	Latchbolt operated by key from either side. Neither lever retracts latchbolt.	3800U-55M Leverset** 3000D
	Security Institutional	Latchbolt operated by key from either side. Neither lever retracts latchbolt. Anti-thrust bolt.	3800U-55T Leverset** 3000D
	Security Classroom	Latchbolt operated by lever from either side. Deadbolt operated by key from inside or outside. Operating inside lever retracts both latchbolt and deadbolt simultaneously.	3800U-55P Leverset Split Spindle* 3000D
	Double Deadbolt	Deadbolt operated by key from either side. No latchbolt.	3800U-55F 3000D
	Privacy Deadbolt	Deadbolt operated by key from outside and by thumbturn from inside. No latchbolt.	3800U-55F 3000C
	Single Deadbolt	Deadbolt operated by key from outside only. No latchbolt.	3800U-55F 3000H

* Use the split spindle in place of the spindle that comes with the leverset.

** Do not install the spindle that comes with the leverset.



	Description	Finish	2018 List	Stock No.	Case Qty.	Box Qty.
	Lock Bodies					
	3800U-20H Sliding Door Mortise Lock	US32D	26.65	138187	20	1
	3800U-60H Sliding Door Mortise Lock	US32D	26.65	138188	20	1
	3800U-55B Bathroom Mortise Lock CE: 3X510F-BG20 CertiFire: CF5283	US32D	28.85	136178	20	1
	3800U-55D Small Mortise Lock	US32D	24.05	136175	20	1
	3800U-55F Deadbolt Mortise Lock CE: 3X510F3BC00 CertiFire: CF5283	US32D	28.85	136179	20	1
	3800U-55L Latch Mortise Lock CE: 3X510F-B020 CertiFire: CF5283	US32D	28.85	136181	20	1
	3800U-55M Nightlatch Mortise Lock CE: 3X510F-B020 CertiFire: CF5283 Requires 2-669-0732 Half Spindle	US32D	28.85	136180	20	1
	3800U-60N Latch Small Mortise Lock	US32D	24.05	150655	20	1

Lock Body Finish Price Adder

US3: \$6.50

US4: \$4.25

US5: \$6.50



US10B: \$4.25

US32: \$3.15

U/M - Each

- 50 Piece Minimum Order Quantity per Lock for Above Finishes
- Above Finishes Not Available on 3800U-20H or 3800U-60H







	Description	Finish	2018 List	Stock No.	Case Qty.	Box Qty.
	Lock Bodies					
	3800U-55P Anti-Panic Mortise Lock CE: 376B1342A B/D CertiFire: CF5283 Requires 2-669-0733 Split Spindle	US32D	28.85	136182	20	1
	3800U-55S Sash Mortise Lock CE: 3X510F3BC20 CertiFire: CF5283	US32D	26.15	136177	20	1
	3800U-55T Nightlatch w/ Anti-Thrust Bolt Mortise Lock CE: 3X510F2BB20 CertiFire: CF5283 Requires 2-669-0732 Half Spindle	US32D	28.85	136183	20	1





Lock Body Finish Price Adder





U/M - Each

- US3: \$6.50
- US4: \$4.25
- US5: \$6.50
- US10B: \$4.25
- US32: \$3.15

- 50 Piece Minimum Order Quantity per Lock for Above Finishes
- Above Finishes Not Available on 3800U-20H or 3800U-60H

	Description	Finish	2018 List	Stock No.	Case Qty.	Box Qty.
	Miscellaneous Lock Accessories					
	3910 Padlock	US26D	51.25	152895	54	1
	2-669-1364 Blank Cylinder Rose	US32D	3.25	174072	200	20
	2-669-0644 Replacement Rose Kit	US32D	6.10	125929	20	10
	2-669-0645 Lever Spindle Extension Kit - Round Rose Levers	US32D	9.15	125930	100	N/A
	2-669-1363 Lever Spindle Extension Kit - Square Rose Levers	US32D	9.15	172838	100	N/A

	Description	Finish	2018 List	Stock No.	Case Qty.	Box Qty.
	Miscellaneous Lock Accessories					
	2-669-0732 Half Spindle	US32D	6.45	136184	500	1
	2-669-0733 Split Spindle	US32D	8.05	136185	500	1
	2-669-0735 Strike Dust Box	US32D	1.70	140210	100	1
	2-669-0736 Bathroom Turn Indicator w/ Emergency Release	US32D	23.25	140211	50	1









	Description	Finish	2018 List	Stock No.	Case Qty.	Box Qty.
	Lever Sets					
	6801 Tube Lever	US32D	24.35	114777	20	1
	6802 Tube Lever	US32D	24.35	146399	20	1
	6803 Tube Lever	US32D	24.35	114782	20	1
	6805 Tube Lever	US32D	24.35	114785	20	1

Lever Set Finish Price Adder
 US3: \$15.00
 US4: \$6.50
 US5: \$6.50
 US10B: \$6.50
 US32: \$8.50

U/M - Each

- 200 Piece Minimum Order Quantity per Lever Set for Above Finishes











	Description	Finish	2018 List	Stock No.	Case Qty.	Box Qty.
	Lever Sets					
	6806 Tube Lever	US32D	24.35	114803	20	1
	6807 Solid Lever	US32D	53.10	114804	20	1
	6808 Solid Lever	US32D	53.10	114805	20	1
	6809 Solid Lever	US32D	56.15	114806	20	1
	6810 Cast Hollow Lever	US32D	53.10	114807	20	1
	6811 Tube Lever	US32D	26.00	114808	20	1
	6812 Tube Lever	US32D	28.85	114809	20	1
	6813 Tube Lever	US32D/ US32 Dual Finish	28.85	114810	20	1
	6814 Cast Hollow Lever	US32D/ US32 Dual Finish	51.85	138154	20	1

Lever Set Finish Price Adder

- US3: \$15.00
- US4: \$6.50
- US5: \$6.50
- US10B: \$6.50
- US32: \$8.50

U/M - Each

- 200 Piece Minimum Order Quantity per Lever Set for Above Finishes

	Description	Finish	2018 List	Stock No.	Case Qty.	Box Qty.
	Lever Sets					
	6815 Solid Lever	US32D	46.50	138155	20	1
	6816 Cast Hollow Lever	US32D/ US32 Dual Finish	52.75	138157	20	1
	6817 Solid Lever	US32D	45.75	138158	20	1
	6818 Solid Lever	US32D	50.80	138159	20	1
	6819 Cast Hollow Lever	US32D/ US32 Dual Finish	50.40	138160	20	1
	6820 Tube Lever	US32D	24.00	138161	20	1
	6821 Tube Lever	US32D/ US32 Dual Finish	25.50	138162	20	1
	6822 Solid Lever	US32D	43.20	138163	20	1
	6823 Solid Lever Handed	US32D	67.35	RH: 172831 LH: 172832	20	1









Lever Set Finish Price Adder

- US3: \$15.00
- US4: \$6.50
- US5: \$6.50
- US10B: \$6.50
- US32: \$8.50

U/M - Each

- 200 Piece Minimum Order Quantity per Lever Set for Above Finishes







	Description	Finish	2018 List	Stock No.	Case Qty.	Box Qty.
	Lever Sets					
	6824 Solid Lever	US32D	50.80	138165	20	1
	6825 Cast Hollow Lever	US32D	46.40	138166	20	1
	6826 Solid Lever	US32D	40.50	138167	20	1
	6827 Solid Lever	US32D	52.10	138168	20	1
	6828 Cast Hollow Lever	US32D	48.55	138169	20	1
	6829 Cast Hollow Lever	US32D	46.75	138170	20	1
	6830 Solid Lever Handed	US32D/ US32 Dual Finish	73.60	RH: 172833 LH: 172834	20	1
	6831 Solid Lever Handed	US32D	63.20	RH: 172835 LH: 172836	20	1
	6832 Solid Lever	US32D/ US32 Dual Finish	50.05	138174	20	1

Lever Set Finish Price Adder
 US3: \$15.00
 US4: \$6.50
 US5: \$6.50
 US10B: \$6.50
 US32: \$8.50

U/M - Each

- 200 Piece Minimum Order Quantity per Lever Set for Above Finishes

	Description	Finish	Size	2018 List	Stock No.	Case Qty.	Box Qty.
	Lock Cylinders						
	3000 - H Series	US15	40mm	18.80	175593	60	1
	Half Cylinders		45mm	21.15	175616		
			50mm*	21.15	**		
	3000 - C Series	US15	60mm	24.35	175599	60	1
	Thumbturn Cylinder		70mm	28.10	175602		
			75mm*	28.10	**		
			80mm	30.40	175612		
	3000 - D Series	US15	60mm	21.40	175598	60	1
	Double Cylinder		70mm	24.90	175601		
			75mm*	24.90	**		
			80mm	27.50	175611		
	3000 - R Series	US15	60mm	20.55	175597	60	1
	Thumbturn Cylinder with Emergency Release		70mm	22.40	175600		
			80mm	26.55	175610		

Keying Charges

Keyed Different (KD): No Charge

Keyed Alike (KA): No Charge

Master Keyed (MK/GMK): Add \$21.10 to list price of cylinder

Extra Cut Keys: \$6.05

Blank Keys: \$3.30

Key Markings (Standard Key Symbols): No Charge

Key Markings (Non-Standard Key Symbols): \$6.05

Bitting Lists (No Charge if ordered with Master Keying): \$83.95

7 Pin Cylinders for Master Keying Only

U/M - Each

Cylinder Finish Price Adder

US3: No Charge



US26: No Charge

- 200 Piece Minimum Order Quantity per Lock for Above Finishes





* H1 Keyway

** Master keyed item only. Inquire with Hager Customer Service for SKU.







		Description	Finish	2018 List	Stock No.	Case Qty.	Box Qty.
		Surface Door Closers					
	5800V Surface Door Closer Size 3 CE - 4:8:3:1:1:3	ALM	62.85	142378	10	1	
	5800R Surface Door Closer Size 2-5 CE - 4:8:2/5:1:1:3 CertiFire: CF5390	ALM	141.40	069791	10	1	
	5800X Surface Door Closer Size 3-6 CE - 4:8:3/6:1:1:3 CertiFire: CF5390	ALM	135.10	069792	10	1	

		Description	Finish	2018 List	Stock No.	Case Qty.	Box Qty.
		Concealed Door Closers					
	5800C Concealed Door Closer Size 3	ALM	88.00	142358	10	1	
	5800D Concealed Door Closer Size 2-4 CE - 4:8:2/4:1:1:3 CertiFire: CF5392	ALM	207.35	069790	10	1	

		Description	Finish	2018 List	Stock No.	Case Qty.	Box Qty.
		Floor Springs					
	5800F Floor Spring Size 3 CE - 3:8:3:1:1:3	US32D	178.10	177677	4	1	
	5815F Floor Spring w/ 90 Degree Hold Open Size 3	US32D	178.10	177680	4	1	
	5800H Heavy Duty Floor Spring Size 3-6 CE - 3:8:3/6:1:1:3	US32D	391.40	181055	4	1	
	5815H Heavy Duty Floor Spring w/ 90 Degree Hold Open Size 3-6	US32D	391.40	181056	4	1	







Note: Additional finishes available on most items. Inquire with Hager Customer Service for pricing.

U/M - Each

	Description	Finish	2018 List	Stock No.	Case Qty.	Box Qty.
	Door Closers Accessories					
	2-659-0087 Surface Closer Track Arm For 5800R, X, V	ALM	37.25	122869	25	1
	2-659-0088 Surface Closer Cover For 5800R	US32D	35.75	122870	17	1
	2-659-0097 Surface Closer Parallel Arm Bracket For 5800R, X, V	ALM	8.85	138151	100	1
	2-659-0149 Surface Closer Hold Open Arm For 5800R, X, V	ALM	41.00	153843	10	1

Note: Additional finishes available on most items. Inquire with Hager Customer Service for pricing.



U/M - Each

	Description	Finish	2018 List	Stock No.	Case Qty.	Box Qty.
	Patch Fittings					
	651 Bottom Patch Fitting	US32	25.15	134144	10	1
	652 Top Patch Fitting	US32	25.15	134145	10	1
	653 Overpanel Patch Fitting	US32	25.15	134146	10	1
	654 Corner Overpanel and Sidelight Patch Fitting	US32	40.55	134147	10	1
	655 Bottom Lock Patch Fitting	US32	53.45	134148	10	1
	2-659-0150 Heavy Duty Top Pivot	ALM	18.20	154746	10	1



Note: Additional finishes available on most items. Inquire with Hager Customer Service for pricing.

U/M - Each







	Description	Finish	Size	2018 List	Stock No.	Case Qty.	Box Qty.
	Exit Devices						
	4201R	ALM	915mm	149.35	143111	4	1
	Push Bar Rim Exit Device	ALM	1219mm	200.85	143137	4	1
	CE - 3:7:6:B:1:4:2:2:B:A	US32D	915mm	164.80	143108	4	1
		US32D	1219mm	216.30	143117	4	1
	4201S	ALM	915mm x 2135mm	195.70	143187	4	1
	Push Bar Surface Vertical Rod Exit Device	ALM	1219mm x 2135mm	242.05	143189	4	1
	CE - 3:7:6:B:1:4:2:2:B:C	US32D	915mm x 2135mm	211.15	143184	4	1
		US32D	1219mm x 2135mm	257.50	143188	4	1



	Description	Finish	2018 List	Stock No.	Case Qty.	Box Qty.
	Exit Trim					
	42CE	US32D	119.45	193685	20	1
	Cylinder Escutcheon Trim William Lever					
	42KE	US32D	70.15	170013	12	1
	Key-in-Lever Trim Withnell Lever					

	Description	Finish	2018 List	Stock No.	Case Qty.	Box Qty.
	Miscellaneous					
	2-649-5011	US32D	13.05	195626	1	
	Double Door Strike					
	2-649-5014	ALM	13.50	70059	10	1
	SVR Top Rod Extension					

Note: Additional finishes available on most items. Inquire with Hager Customer Service for pricing.

U/M - Each

	Description	Finish	2018 List	Stock No.	Case Qty.	Box Qty.
	Flushbolts					
	280E Dust Proof Strike	US32D	9.85	114930	300	10
	281E Cast Flush Bolt	US32D	26.65	95617	50	1
	282E Stamped Flush Bolt	US32D	24.00	95616	50	1
	1420 Manual Flush Bolt	US32D	17.90	114811	100	2

	Description	Finish	2018 List	Stock No.	Case Qty.	Box Qty.
	Door Stops					
	241E Dome Door Stop	US32D	6.65	95525	100	1
	248E Pedestal Door Stop	US32D	9.00	114951	200	10
	248U Pedestal Door Stop	US32D	14.95	123266	100	10

	Description	Finish	2018 List	Stock No.	Case Qty.	Box Qty.
	Coat & Hat Hooks					
	6630 Coat & Hat Hook	US32D	9.30	114948	200	10
	6640 Coat & Hat Hook	US32D	9.50	114950	200	10



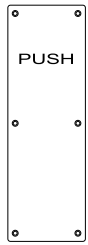

Description	Finish	2018 List	Stock No.	Case Qty.	Box Qty.
Push/Pull Plates					

090E Push Plate 4"x12"	US32D	16.00	95514	40	1
-------------------------------------	-------	-------	-------	----	---

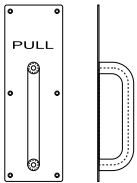

095E Pull Plate 4"x12"	US32D	24.00	95499	20	1
-------------------------------------	-------	-------	-------	----	---

Description	Finish	2018 List	Stock No.	Case Qty.	Box Qty.
Signage					



371F Signage Female	US32D	9.00	122875	20	10
----------------------------------	-------	------	--------	----	----



371M Signage Male	US32D	9.00	122873	20	10
--------------------------------	-------	------	--------	----	----







371U Signage Universal	US32D	9.00	122877	20	10
-------------------------------------	-------	------	--------	----	----



371H Signage Disabled	US32D	9.00	122876	20	10
------------------------------------	-------	------	--------	----	----



371S Signage No Smoking	US32D	9.00	122874	20	10
--------------------------------------	-------	------	--------	----	----

	Description	Finish	2018 List	Stock No.	Case Qty.	Box Qty.
	Miscellaneous					
	1757 Door Viewer	US26D US3	7.95 7.95	133689 133690	200	1
	277E Surface Bolt	US15	11.05	133809	50	1
	277T Indicator Thumbturn Bolt	US32D	16.55	138118	50	1
	298E Door Selector	US32D	27.15	95516	50	1
	299D Concealed Door Chain	US32D	25.35	114952	48	1

Note: Additional finishes available on most items. Inquire with Hager Customer Service for pricing.

U/M - Each





Description	Size	Finish	2018 List	Stock No.	Case Qty.	Box Qty.
BB6191 Stainless Full Mortise Standard Weight Ball Bearing CE Certified CertiFire: CF5288	89mm x 89mm	US3	19.10	117673	48	2
		US5	16.50	117306		
		US10B	16.50	117296		
		US32D	13.25	117686		
	102mm x 76mm	US3	22.00	117308	48	2
		US5	16.50	117691		
		US10B	16.50	117688		
		US32D	12.55	117689		
	102mm x 89mm	US3	24.55	117702	48	2
		US5	18.20	117758		
		US10B	18.20	117309		
		US32D	14.55	117729		
102mm x 102mm	US3	25.35	117311	48	2	
	US5	19.70	117780			
	US10B	19.75	117310			
	US32D	15.40	117777			
127mm x 89mm	US3	29.80	117359	48	2	
	US5	22.80	117362			
	US10B	22.80	117344			
	US32D	18.45	117782			



7191 Rising Butt Hinge Stainless Full Mortise Raises Door Upon Opening Handed	102mm x 76mm (LH)	US32D	12.40	135300	60	2
	102mm x 76mm (RH)		12.40	135304		
	102mm x 102mm (LH)		15.15	146537		
	102mm x 102mm (RH)		15.15	146538		



7192 Falling Butt Hinge Stainless Full Mortise Lowers Door Upon Opening Handed	102mm x 76mm (LH)	US32D	13.60	146542	60	2
	102mm x 76mm (RH)		13.60	146541		
	102mm x 102mm (LH)		15.60	146540		
	102mm x 102mm (RH)		15.60	146539		

Non-Removable Pin (NRP) Adder: \$3.65 each
 Protective Clear Coat Adder: \$0.50 each

U/M - Each

Please note that minimum order in case quantities only, no broken cases.

- Notes:
- Additional finishes available on most items. Inquire with Hager Customer Service for pricing on US10, US4, and US32.
 - For pricing on sizes not listed, please contact your Hager Sales Representative or Hager Customer Service.









Description	Size	Finish	2018 List	Stock No.	Case Qty.	Box Qty.
1200 Series Invisible Hinges	19mm x 95mm	US32D	45.45	95673	50	1
Stainless	25.4mm x 117.2mm	US32D	74.65	95669	20	1
	28.2mm x 117.2mm	US32D	84.00	95665	20	1
	34.7mm x 139.65mm	US32D	132.00	95663	12	1

Please note that minimum order for case quantities only, no broken cases.

U/M - Each

- Notes:
- Additional finishes available on most items. Inquire with Hager Customer Service for pricing on US10, US4, and US32.



	Description	Size	Finish	2018 List	Stock No.	Case Qty.	Box Qty.
	1279	76mm x 76mm	US26D	11.35	53908	100	2
	Steel	89mm x 89mm		11.60	36829	48	3
	Full Mortise	102mm x 102mm		11.90	36832	48	3
	Standard Weight	114mm x 102mm		12.35	36678	48	3
		114mm x 114mm		12.35	37714	48	3
	BB1279	89mm x 89mm	US26D	13.50	36822	48	3
	Steel	102mm x 102mm		16.65	37710	48	3
	Full Mortise	114mm x 102mm		18.50	34213	48	3
	Standard Weight Ball Bearing	114mm x 114mm		18.50	34215	48	3
	BB1168	114mm x 102mm	US26D	34.35	37715	48	3
	Steel	114mm x 114mm		34.35	36680	48	3
	Full Mortise Heavy Weight Ball Bearing						
	1191	76mm x 76mm	US32D	16.35	53021	100	2
	Stainless	89mm x 89mm		21.00	52987	48	3
	Full Mortise	102mm x 102mm		24.20	37716	48	3
	Standard Weight	114mm x 102mm		31.00	36679	48	3
		114mm x 114mm		31.00	38646	48	3
	BB1191	89mm x 89mm	US32D	22.85	61669	48	3
	Stainless	102mm x 102mm		29.85	37717	48	3
	Full Mortise	114mm x 102mm *		38.60	35597	48	3
	Standard Weight	114mm x 114mm *		38.60	35419	48	3
	Ball Bearing	127mm x 114mm		58.25	82255	48	3
	BB1199	114mm x 102mm *	US32D	61.35	36817	48	3
	Stainless	114mm x 114mm *		61.35	35433	48	3
	Full Mortise Heavy Weight Ball Bearing	127mm x 114m		90.05	44553	48	3

Non-Removable Pin (NRP) Adder: \$3.65 each
 Hospital Tip (HT) Adder: \$7.30 each
 Safety Stud (SH) Adder: \$5.10 each
 Round Corner (RC) Adder: \$2.90 each
 Stainless Steel Pin (114mm) Adder: \$3.65 each
 Protective Clear Coat Adder: \$0.50 each

U/M - Each

- Notes:
- Additional finishes available on most items. Inquire with Hager Customer Service for pricing on US10, US4, and US32
 - For pricing on sizes not listed, please contact Hager Customer Service.

* Available in 316 Stainless Steel. Add \$20.25 to list price of hinge



One Family. One Brand. One Vision.™

www.hagerco.com

2310	5	3810E	45
2317	5	3810S	43
2327	5	3817E	45
2340	5	3817S	43
2510	8	3827E	45
2517	8	3827S	43
2525	8	3830S	49
2527	8	3831S	49
2540	8	3832S*	49
2550	8	3833S	49
2553	8	3834S	49
2570	8	3840E	46
2580	8	3840S	44
2903	24	3844E	46
2903	47	3844S	44
2904	24	3850E	46
2904	47	3850S	44
2908	24	3853E	46
2908	47	3853S	44
2909	24	3856E	46
2909	47	3856S	44
3114	12	3857E*	46
3115	12	3857S*	44
3118	12	3860S	48
3214	16	3861E*	46
3215	16	3861S*	44
3216	16	3862S*	48
3220	16	3863S	48
3221	16	3864S	48
3222	16	3870E	44
3410	22	3870S	42
3417	22	3880E	44
3440	22	3880S	44
3450	23	3881E	46
3453	23	3881S	44
3470	23	3882E*	46
3473	23	3882EL	47
3480	23	3882S*	44
3480ELEU	24	3896E	46
3495	23	3896S	44
3510	30	3901	58
3517	30	3901	62
3525	30	3901	64
3527	30	3902	59
3540	31	3902	62
3550	31	3902	64
3553	31	3903	58
3570	31	3904	59
3573	31	3905	59
3579	31	3907	57
3580	31	3907	61
3610	36	3908	57
3617	36	3908	60
3640	36	3908	61
3653	36	3911	11
3670	36	3911	27
3680	36	3911	65
3710	39	3912	35
3753	39	3912	65
3796	39	3914	37



3915 37
 3916 25
 3917 9
 3917 33
 3918 51
 3919-C 63
 3919-Z 63
 3920 40
 3921 40
 3922 9
 3922 34
 3923 9
 3923 34
 3924 10
 3924 34
 3925 9
 3925 34
 3926 10
 3926 34
 3927 10
 3927 34
 3928 51
 3929 13
 3929 17
 3930 13
 3930 17
 3930 40
 3932 25
 3932 29
 3933 6
 3933 10
 3933 29
 3933 34
 3933 38
 3933 41
 3934 10
 3934 26
 3934 34
 3934 38
 3934 41
 3935 6
 3935 10
 3935 26
 3935 29
 3935 34
 3936 25
 3937 9
 3937 33
 3938 37
 3939 37
 3940 13
 3940 17
 3941 13
 3941 17
 3942 17
 3943 24
 3944 25
 3945 24
 3946 25
 3947 9

3947 32
 3947 40
 3948 9
 3948 32
 3948 40
 3949 9
 3949 32
 3949 40
 3950 9
 3950 32
 3950 40
 3951 37
 3952 37
 3953 37
 3954 37
 3955 56
 3956 56
 3956 63
 3958 10
 3958 26
 3958 34
 3958 38
 3958 41
 3959 6
 3959 9
 3959 17
 3959 33
 3959 38
 3959 40
 3959 65
 3960 or 3906 (Hager Keyway Only) 57
 3961 56
 3962 57
 3962 63
 3964 24
 3965 9
 3965 32
 3966 25
 3967 9
 3967 32
 3968 65
 3968 65
 3971 59
 3972 59
 3973 59
 3974 59
 3975 60
 3976 60
 3977 60
 3978 60
 3979 65
 3980 66
 3981-BLU or RED (Best A) 60
 3981-C 60
 3981-U 60
 3982-BLU or RED (Best A) 60
 3982-C or 3969 (Hager SFIC Only) 60
 3982-U or 3909 (Hager SFIC Only) 60
 3983 61
 3984 60

3984	58	2-300-0066	38
3985	51	2-300-0068	38
3986	51	2-300-0074	38
3987	51	2-300-0091	7
3988	51	2-300-0092	7
3989	51	2-300-0093	7
3990	51	2-300-0105	18
3991	51	2-300-0106	18
3992	25	2-300-0107	18
3993	25	2-300-0108	18
3994	32	2-300-0109	18
3995	33	2-300-0110	18
3996	34	2-300-0111	18
3997	34	2-300-0112	18
3998	56	2-300-0113	18
3998	60	2-300-0114	18
3999	52	2-300-0115	18
2-300-0001	14	2-300-0116	18
2-300-0002	14	2-300-0118	59
2-300-0003	14	2-300-0138	41
2-300-0004	14	2-300-0140	41
2-300-0005	14	2-300-0141	41
2-300-0006	14	2-300-0175	64
2-300-0007	14	2-639-3109	13
2-300-0008	14	2-639-3109	17
2-300-0009	14	2-639-3109	41
2-300-0010	14	2-639-3151	13
2-300-0011	14	2-639-3152	14
2-300-0018	18	2-639-3153	14
2-300-0019	18	2-639-3154	14
2-300-0020	18	2-639-3155	14
2-300-0021	18	2-639-3156	14
2-300-0022	18	2-639-3157	14
2-300-0023	18	2-639-3168	13
2-300-0024	18	2-639-3218	19
2-300-0025	18	2-639-3219	19
2-300-0026	18	2-639-3220	19
2-300-0027	18	2-639-3221	19
2-300-0028	18	2-639-3222	19
2-300-0029	18	2-639-3223	19
2-300-0036	27	2-639-3230	19
2-300-0038	27	2-639-3231	19
2-300-0039	27	2-639-3233	19
2-300-0041	27	2-639-3234	19
2-300-0042	27	2-639-3235	19
2-300-0043	27	2-639-3236	19
2-300-0044	27	2-639-3238	14
2-300-0045	27	2-639-3238	19
2-300-0045	35	2-639-3239	14
2-300-0048	10	2-639-3239	19
2-300-0048	35	2-639-3490	26
2-300-0050	10	2-639-3490	29
2-300-0050	35	2-639-3523	10
2-300-0052	10	2-639-3523	35
2-300-0052	35	2-639-3577	10
2-300-0058	10	2-639-3577	32
2-300-0058	35	2-639-3703	19
2-300-0059	35	2-639-3704	19
2-300-0060	35	2-639-3705	19
2-300-0064	38	2-639-3706	19



2-639-3707 19
 2-639-3708 19
 2-639-7000 57
 2-639-7001 57
 2-639-7002 57
 2-639-7003 57
 2-639-7005 57
 2-639-7006 58
 2-639-7007 58
 2-639-7008 58
 2-639-7018 58
 2-639-7058 59
 2-639-7060 61
 2-639-7061 62
 2-639-7082 62
 2-639-7083 62
 2-639-7084 62
 2-639-7085 63
 2-639-7086 63
 2-639-7087 58
 2-639-7090 62
 2-639-7091 62
 2-639-7094 58
 2-639-7095 62
 2-639-7143 20
 2-639-7144 20
 2-639-7146 13
 2-639-7147 13
 2-639-7148 13
 2-639-7149 13
 2-639-7150 13
 2-639-7151 19
 2-639-7152 19
 2-639-7153 19
 2-639-7154 20
 2-639-7155 20
 2-639-7156 20
 2-639-7157 20
 2-639-7158 20
 2-639-7159 38
 2-639-7160 15
 2-639-7160 20
 2-639-7161 15
 2-639-7161 20
 2-639-7163 15
 2-639-7163 20
 2-639-7164 15
 2-639-7164 20
 2-639-7165 20
 2-639-7166 20
 2-639-7167 15
 2-639-7167 20
 2-639-7192 58
 2-639-7322 58
 2-639-7511 67
 2-639-7512 67
 2-639-7513 67
 2-639-7517 67
 2-639-7518 67
 2-639-7519 67

2-639-7520 67
 2-639-7522 67
 2-639-7523 68
 2-639-7524 68
 2-639-7526 68
 2-639-7527 68
 2-639-7528 68
 2-639-7530 68
 2-639-7531 68
 2-639-7532 68
 2-639-7534 68
 2-639-7535 68
 2-639-7536 68
 2-639-7536 68
 2-639-7537 68
 2-639-7536 65
 2-639-7570 65
 2-639-7572 65
 2-639-7573 65
 2-639-7574 65
 2-639-7578 64
 2-639-7601 7
 2-639-7603 7
 2-639-7604 7
 2-639-7605 7
 2-639-7606 7
 2-639-7607 6
 2-639-7608 6
 2-639-7609 6
 2-639-7610 6
 2-639-7617 6
 2-639-7619 6
 2-639-7620 6
 2-639-7621 6
 2-639-7622 6
 2-639-7645 64
 2-639-7646 64
 2-639-7647 64
 2-639-7649 63
 2-639-7680 66
 2-647-0012 66
 2-647-0013 66
 2-647-0014 66
 2-647-0015 66
 2-647-0016 66
 2-647-0017 66
 2-647-0018 66
 2-647-0019 66
 2-647-0020 66
 2-649-0045 66
 2-649-0046 66
 2-649-0047 66
 2-649-0048 66
 2-649-0050 66
 2-649-0051 66
 2-649-0052 66
 2-649-0053 67
 2-649-0054 67
 2-649-0055 67

2-649-0056.....	67	2-669-0389.....	52
2-649-0057.....	67	2-669-0408.....	53
2-649-0058.....	67	2-669-0410.....	53
2-649-0059.....	67	2-669-0411.....	53
2-649-0137.....	59	2-669-0415.....	53
2-669-0111.....	53	2-669-0417.....	53
2-669-0112.....	53	2-669-0418.....	53
2-669-0115.....	53	2-669-0422.....	53
2-669-0116.....	54	2-669-0424.....	53
2-669-0119.....	54	2-669-0425.....	53
2-669-0120.....	54	2-669-0597.....	55
2-669-0123.....	54	2-669-0600.....	55
2-669-0124.....	54	2-669-0603.....	55
2-669-0127.....	54	2-669-0604.....	55
2-669-0128.....	54	2-669-0605.....	55
2-669-0131.....	54	2-669-0613.....	55
2-669-0132.....	54	2-669-0615.....	55
2-669-0135.....	54	2-669-0616.....	55
2-669-0136.....	54	2-669-0635.....	55
2-669-0139.....	54	2-669-0636.....	55
2-669-0140.....	54	2-669-0641.....	55
2-669-0143.....	54	2-669-0643.....	55
2-669-0144.....	54	DPM.....	47
2-669-0147.....	54	LM.....	47
2-669-0148.....	54	RX.....	47
2-669-0157.....	54	Stainless Mortise Lock Levers (each).....	51
2-669-0158.....	54	Zinc Mortise Lock Levers (each).....	51
2-669-0167.....	54		
2-669-0168.....	54		
2-669-0224.....	52		
2-669-0226.....	52		
2-669-0230.....	52		
2-669-0232.....	52		
2-669-0236.....	52		
2-669-0238.....	52		
2-669-0242.....	52		
2-669-0244.....	52		
2-669-0248.....	52		
2-669-0250.....	52		
2-669-0254.....	52		
2-669-0256.....	52		
2-669-0296.....	52		
2-669-0298.....	52		
2-669-0302.....	52		
2-669-0304.....	52		
2-669-0308.....	53		
2-669-0310.....	53		
2-669-0314.....	53		
2-669-0316.....	53		
2-669-0320.....	53		
2-669-0322.....	53		
2-669-0326.....	53		
2-669-0328.....	53		
2-669-0365.....	53		
2-669-0366.....	54		
2-669-0389.....	11		
2-669-0389.....	26		
2-669-0389.....	29		
2-669-0389.....	35		
2-669-0389.....	38		



380F	21	5905	17
380G	21	5905	20
380H	21	5906	12
380R	21	5906	17
380S	21	5907	12
381A	22	5907	17
381B	22	5908	12
381C	22	5908	17
381D	22	5909	7
381E	22	5911	12
381H	23	5911	17
381S	23	5912	12
381W	23	5912	17
5100 Series	5	5913	12
5101	6	5913	17
5102	6	5913	20
5103	6	5914	12
5104	6	5914	17
5106	6	5915	17
5107	6	5916	17
5108	7	5917	17
5109	7	5918	12
5110	7	5919	12
5111	7	5920	13
5112	7	5921	13
5113	7	5922	13
5114	7	5923	13
5115	7	5932	13
5125	7	5935	7
5200 Series	10	5936	13
5201	11	5936	18
5202	11	5940	7
5203	11	5941	8
5204	11	5942	8
5207	11	5943	8
5300 Series	15	5946	8
5301	16	5950	8
5302	16	5950	13
5303	16	5950	18
5304	16	5954	8
5307	16	5955	8
5400 Series	19	5956	13
5401	19	5956	13
5403	20	5957	13
5404	20	5957	13
5900	11	5961	8
5900	16	5962	8
5900	18	6000 Series Accessories	25
5901	11	6000 Series Screwpacks	25
5901	16	6000 Series Screwpacks	26
5902	11	6015 Series - Medium Duty Concealed Mount	24
5902	16	6015 Series - Medium Duty Surface Mount	24
5902	20	6016 Series - Medium Duty Concealed Mount	24
5903	12	6016 Series - Medium Duty Surface Mount	24
5903	16	6017 Series - Medium Duty Concealed Mount	25
5903	20	6017 Series - Medium Duty Surface Mount	25
5904	12	7000 Series Accessories	27
5904	17	7000 Series Accessories	27
5904	20	7000 Series Screwpacks	27
5905	12	7015 Series - Heavy Duty Concealed Mount	26

7015 Series - Heavy Duty Surface Mount 26
7016 Series - Heavy Duty Concealed Mount 26
7016 Series - Heavy Duty Surface Mount 26
7017 Series - Heavy Duty Concealed Mount 27
7017 Series - Heavy Duty Surface Mount 27
2-659-0187 8
2-659-0188 8
2-659-0189 8
2-659-0190 8
2-659-0191 13
2-659-0191 18
2-659-0192 13
2-659-0192 18
2-659-0193 13
2-659-0193 18
2-659-0194 13
2-659-0194 18
2-659-0195 9
2-659-0196 9
2-659-0197 9
2-659-0198 9
2-659-0199 14
2-659-0199 18
2-659-0200
2-659-0200 18
2-659-0201 14
2-659-0201 18
2-659-0202 14
2-659-0202 18
2-659-0203 9
2-659-0204 9
2-659-0205 9
2-659-0206 9
2-659-0207 9
2-659-0208 9
2-659-0209 9
2-659-0210 9
2-659-0211 14
2-659-0212 14
2-659-0213 14
2-659-0214 14
2-659-0215 14
2-659-0216 14
2-659-0217 14
2-659-0218 14



45BE	13	4916	46
45CE	15	4917	41
45DT	17	4918	41
45MB	14	4919	41
45MC	16	4920	22
45MD	18	4920	33
45MN	20	4920F	22
45NL	19	4920F	33
45PD	21	4921	22
45PN	21	4923	23
45PT	21	4923F	23
46BE	30	4924	23
46CE	31	4924F	23
46DT	31	4925R	33
46NK	32	4926	23
46NL	32	4927	23
47BE	36	4928	24
47BT	40	4929	24
47CE	37	4929C	24
47DT	37	4930R	42
47KD	38	4930S	42
47KE	39	4931R	24
47KN	39	4931S	25
47KP	40	4932C	25
47NL	38	4932R	42
47PD	40	4932S	42
47PN	40	4933R	42
47PT	40	4933S	42
47RD	41	4934	25
47RN	41	4934F	42
313LE (313LF w/Plastisol)	22	4936	25
313SE (313SF w/Plastisol)	22	4936	42
3901	46	4937	25
3902	47	4937	42
4501 CLB	12	4940	25
4501 CVR	11	4941R	34
4501 D	13	4945	26
4501 M	12	4945F	26
4501 N	13	4950	34
4501 RIM	9	4951	34
4501 SVR	10	4952	34
4501 SVR LBR	9	4953	45
4601 RIM	30	4953	46
4701 RIM	36	4960R	34
4701 SVR	36	4965R	35
4900T	45	2-647-0012	48
4900U	45	2-647-0013	48
4902	46	2-647-0014	48
4904	45	2-647-0015	48
4905	45	2-649-0010	42
4907	46	2-649-0011	43
4910	41	2-649-0012	43
4911	41	2-649-0013	43
4912	46	2-649-0014	43
4912	45	2-649-0021	43
4913	46	2-649-0022	43
4914	41	2-649-0023	43
4915	41	2-649-0024	43
4915	22	2-649-0025	43
4916	45	2-649-0026	43



2-649-0027	43	2-649-0096	43
2-649-0028	43	2-649-0097	43
2-649-0031	26	2-649-0098	43
2-649-0032	26	2-649-0099	43
2-649-0033	26	2-649-0100	43
2-649-0034	26	2-649-0101	43
2-649-0035	26	2-649-0102	43
2-649-0036	26	2-649-0103	43
2-649-0037	26	2-649-0137	44
2-649-0038	26	2-649-0141	47
2-649-0038	35	2-649-0142	44
2-649-0039	26	2-649-0144	44
2-649-0039	35	2-649-0145	44
2-649-0040	26	2-649-0146	44
2-649-0040	35	2-649-0147	44
2-649-0041	26	2-649-0164	44
2-649-0041	35	2-649-0166	28
2-649-0042	26	2-649-0167	28
2-649-0042	35	2-649-0168	28
2-649-0043	26	2-649-0168	35
2-649-0043	35	2-649-0177	28
2-649-0044	26	2-649-0177	44
2-649-0044	35	2-649-0178	28
2-649-0045	47	2-649-0179	28
2-649-0046	47	2-649-0180	28
2-649-0047	47	2-649-0181	28
2-649-0048	47	2-649-0182	28
2-649-0049	27	2-649-0183	28
2-649-0050	47	2-649-0183	44
2-649-0051	47	2-649-0184	44
2-649-0052	47	2-649-0185	44
2-649-0053	47	2-649-0203	29
2-649-0054	47	2-649-0204	29
2-649-0055	47	2-649-0205	29
2-649-0056	47	2-649-0206	29
2-649-0057	47	2-649-0207	29
2-649-0058	48	2-649-0208	29
2-649-0059	48	2-649-0214	26
2-649-0060	27	2-649-0214	35
2-649-0061	27	2-649-0215	26
2-649-0062	27	2-649-0215	35
2-649-0063	27	2-649-0216	26
2-649-0064	27	2-649-0216	35
2-649-0065	27	2-649-0217	26
2-649-0066	27	2-649-0217	35
2-649-0074	27	2-649-0218	26
2-649-0075	27	2-649-0218	35
2-649-0076	27	2-649-0219	26
2-649-0077	27	2-649-0219	35
2-649-0078	27	2-649-0220	26
2-649-0079	27	2-649-0220	35
2-649-0080	27	2-649-1074	29
2-649-0081	27	2-649-1074	35
2-649-0082	28	2-649-1090	29
2-649-0083	28	2-649-1090	35
2-649-0084	28	2-649-1108	29
2-649-0085	28	2-649-1109	29
2-649-0086	28	2-649-4703	44
2-649-0087	28		
2-649-0088	28		
2-649-0095	28		



29KS ADD	3	2-659-0171	18
29KS ASD	3	2-659-0172	18
29KS MDD	3	2-659-0173	18
29KS MSD	3	2-659-0174	19
2901	3	2-659-0175	19
2902	3	2-659-0176	19
2903	3	2-659-0177	19
2904	3	2-659-0178	19
2908	3	2-659-0179	19
2909	3	2-659-0180	19
2915	4	2-659-0181	19
2916	4	2-659-0182	20
2916P	4	2-659-0183	20
2925	5	2-659-0184	20
2928 RC	5	2-659-0185	20
2928 SC	5	2-659-0186	20
2930 CYL	5	2-659-0220	13
2930 MDB	5	2-659-0221	13
2930 MOR	5	2-659-0222	13
2941 Magnetic Lock	6	2-659-0223	13
2942 Magnetic Lock	6	2-659-0224	13
2951 Magnetic Lock	6	2-659-0225	13
2952 Magnetic Lock	7	2-659-0226	13
2953 Magnetic Lock	7	2-659-0227	13
2954 Magnetic Lock	7	2-659-0228	13
2958 Delayed Egress Magnetic Lock	9	2-659-0229	13
2958 T Tandem Delayed Egress Magnetic Lock	9	2-659-0230	13
2961 Magnetic Shear Lock	9	2-659-0231	13
2965 Magnetic Shear Lock	9	2-659-0232	13
2972 Exit Switch	10	2-659-0233	13
2972T Exit Switch with Integrated Adjustable Timer	10	2-659-0234	14
2973 Code Compliant Exit Switch	10	2-659-0235	14
2977 Exit Switch	10	2-659-0236	14
2978 Touchless Exit Switch	10	2-659-0237	14
4801 Pressure Sense Bar	10	2-659-0240	20
8218 Single Operator	15	2-659-0241	18
8219 Simultaneous Pair Operator	15	2-659-0242	19
8221 Double Egress Simultaneous Pair Operator	15	2-659-0243	19
8418 Single Operator	12	2-659-0275	15
8419 Simultaneous Pair	12	2-659-0276	15
8420 Independent Pair	12	2-659-0277	15
8421 Double Egress Simultaneous Pair	12	2-659-0278	15
8422 Double Egress Independent Pair	12	2-659-0279	15
8423 Single Operator with Mechanical Closer	12	2-659-0280	15
2928 6R	5	2-659-0283	16
2928 7R	5	2-659-0284	16
2-659-0151	13	2-659-0285	16
2-659-0152	13	2-659-0286	16
2-659-0153	13	2-659-0287	16
2-659-0154	13	2-659-0288	16
2-659-0161	17	2-659-0289	16
2-659-0162	17	2-659-0290	16
2-659-0163	17	2-659-0291	16
2-659-0164	17	2-659-0292	16
2-659-0165	18	2-659-0293	16
2-659-0166	18	2-659-0294	16
2-659-0167	18	2-659-0295	16
2-659-0168	18	2-659-0296	16
2-659-0169	18	2-659-0297	16
2-659-0170	18	2-659-0298	16

2-659-0299	16	2-679-0581	9
2-659-0300	16	2-679-0583	9
2-659-0301	16	2-679-0600	9
2-659-0303	17	2-679-0601	9
2-659-0304	17	2-679-0611 PIR Egress Sensor	11
2-659-0305	17	2-679-0612 PIR Egress Sensor	11
2-659-0306	17	2-679-0620	11
2-679-0021	4	2-679-0621	11
2-679-0022	4	2-679-0622	11
2-679-0023	4	2-679-0623	11
2-679-0024	4	2-679-0624	11
2-679-0028	6	2-679-0625	11
2-679-0029	6	2-679-0626	11
2-679-0100	6	2-679-0640	11
2-679-0101	6	2-679-0641	11
2-679-0102	6	2-679-0642	11
2-679-0103	6	2-679-0650	11
2-679-0104	6	2-679-0661	3
2-679-0105	6	2-679-0662	3
2-679-0106	6	2-679-0664	3
2-679-0107	6	2-679-0669	4
2-679-0108	6	2-679-0700	4
2-679-0120	7	2-679-0703	4
2-679-0121	7	2-679-0704	4
2-679-0130	7	2-679-0705	4
2-679-0131	7	2-679-0706	4
2-679-0160	7	2-679-0708	4
2-679-0161	7	2-679-0708	11
2-679-0180	7		
2-679-0181	7		
2-679-0190	7		
2-679-0191	7		
2-679-0200	7		
2-679-0201	7		
2-679-0204	7		
2-679-0205	8		
2-679-0210	8		
2-679-0220	8		
2-679-0281	8		
2-679-0283	8		
2-679-0291	8		
2-679-0293	8		
2-679-0311	8		
2-679-0313	8		
2-679-0321	8		
2-679-0323	8		
2-679-0381	8		
2-679-0383	8		
2-679-0391	8		
2-679-0393	8		
2-679-0411	8		
2-679-0413	8		
2-679-0421	8		
2-679-0423	8		
2-679-0491	9		
2-679-0493	9		
2-679-0501	9		
2-679-0503	9		
2-679-0571	9		
2-679-0573	9		



100	12	1279 - Continued 2	58
251	12	1303	64
252	12	1577	64
253	12	1578	65
254	12	1712	65
263	12	1713	65
265	12	1716	65
305	12	1717	65
417	12	1722	65
430	12	1723	65
451	12	1728	66
452	12	1729	66
453	12	1850	66
454	13	1850 LP	66
455	13	AB700	17
456	13	AB700 - Continued..	18
457	13	AB7001	68
458	13	AB7002	69
495	13	AB701	20
496	13	AB702	20
497	13	AB703	20
500	14	AB750	20
510	14	AB750 - Continued..	21
511	14	AB7501	69
512	14	AB7502	69
550	14	AB7505	69
551	14	AB7506	70
600	14	AB7507	70
610	14	AB7508	70
611	15	AB7509	70
612	15	AB751	22
615	15	AB7511	70
700	15	AB7512	71
700 - Continued..	16	AB752	22
800	23	AB7523	71
920	29	AB753	23
990	31	AB7534	71
992	31	AB800	24
1129	32	AB801	26
1150	32	AB802	26
1173	38	AB803	26
1191	39	AB850	26
1191 - Continued..	40	AB850 - Continued..	27
1250	50	AB8505	71
1251	50	AB8506	71
1251 - Continued..	51	AB8507	71
1252	51	AB8508	72
1253	51	AB8509	72
1255	52	AB851	28
1256	52	AB852	29
1257	52	AB853	29
1258	53	AB920	30
1259	53	AB923	30
1260	53	AB930	31
1260 - Continued..	54	AB933	31
1267	55	BB1109	32
1277	55	BB1129	32
1278	56	BB1138	32
1279	56	BB1160	33
1279 - Continued..	57	BB1162	33

BB1163	33	EC1101	73
BB1165	33	EC1105	74
BB1166	34	ECBB1100	73
BB1167	34	ECBB1100 NRP	73
BB1168	35	ECBB1101	73
BB1168 - Continued.	36	ECBB1101 NRP	73
BB1168 Drop Leaf	75	ECBB1102	73
BB1168 Short Leaf	75	ECBB1102 NRP	73
BB1168 Unequal Leaf Centered	76	ECBB1103	74
BB1173	38	ECBB1103 NRP	74
BB1190	39	ECRC1100	73
BB1191	41	ECRCBB1100	73
BB1191 - Continued.	42	IHTAB750	22
BB1191 - Continued 2	43	IHTAB850	28
BB1191 Drop Leaf	75	IHTHB953	31
BB1191 Short Leaf	75	WT1191	44
BB1191 Unequal Leaf Centered	76	WT1191 - Continued.	45
BB1192	46	WT1279	63
BB1195	46	WT1279 - Continued.	64
BB1196	46	WTAB700	19
BB1197	46	WTAB700 - Continued.	20
BB1199	47	WTAB750	21
BB1199 - Continued.	48	WTAB750 - Continued.	22
BB1199 Drop Leaf	75	WTAB800	25
BB1199 Short Leaf	75	WTAB800 - Continued.	26
BB1199 Unequal Leaf Centered	76	WTAB850	27
BB1260	54	WTAB850 - Continued.	28
BB1261	54	WTBB1168	37
BB1262	54	WTBB1168 - Continued.	38
BB1263	54	WTBB1191	44
BB1264	55	WTBB1191 - Continued.	45
BB1265	55	WTBB1191 - Continued 2	46
BB1266	55	WTBB1199	49
BB1270	55	WTBB1199 - Continued.	50
BB1277	55	WTBB1279	62
BB1278	57	WTBB1279 - Continued.	63
BB1279	59		
BB1279 - Continued.	60		
BB1279 - Continued 2	61		
BB1279 Drop Leaf	75		
BB1279 Short Leaf	75		
BB1279 Unequal Leaf Centered	76		
BB1360	64		
BB1361	64		
BB1362	64		
BB1363	64		
BB1577	65		
BB1578	65		
BB2098	66		
BB2108	66		
BB2109	66		
BB2110	67		
BB2112	67		
BB2113	67		
BB2168	67		
BB2169	68		
BB2171	68		
CB1191	43		
EC1100	72		
EC1100 NRP	72		



1340	4
1541	4
1543	5
1700	18
1710	19
1720	19
1734	5
1741	6
1744	9
1750	10
1751	10
1752	11
1754	11
1760	11
1761	12
1762	12
1764	12
1816	12
1817	12
1818	13
1819	13
1848	16
2617	16
2817	17
7741	17
8741	18
8744	18
8746	18
BB1541	4
BB1543	5
BB1741	7
BB1816	12
BB1817	13
RC1541	4
RC1542	5
RC1641	3
RC1741	7
RC1741	8
RC1748	9
RC1749	9
RC1841	14
RC1842	14
RC1843	15
RC1843	15
RC1846	15
RC1846	16
RC1847	16
RC1847	16
RCBB1541	4
RCBB1542	5
RCBB1741	8
RCBB1842	15

500-048.....	15
500-200.....	15
500-220.....	15
750-134.....	15
750-138.....	15
780-041HD.....	16
780-041LL.....	16
780-045HD.....	16
780-046HD.....	17
780-053.....	17
780-053HD.....	17
780-054HD.....	18
780-057HD.....	18
780-110HD.....	18
780-111.....	19
780-111HD.....	19
780-111LL.....	19
780-112.....	20
780-112HD.....	20
780-112LL.....	20
780-113HD.....	21
780-114HD.....	21
780-124HD.....	21
780-124LL.....	22
780-155HD.....	22
780-157.....	22
780-157HD.....	23
780-208HD.....	23
780-210.....	23
780-210HD.....	24
780-211HD.....	24
780-213HD.....	24
780-224.....	25
780-224HD.....	25
780-224LL.....	25
780-226HD.....	26
780-226LL.....	26
780-235HD.....	26
780-257HD.....	27
780-259HD.....	27
780-300HD.....	27
1200-600XHD.....	28
1200-650XHD.....	28



790-900.....	6
790-903.....	6
790-904.....	6
790-905.....	6
790-906.....	6
790-909.....	7
790-911.....	7
790-915.....	7
790-926.....	7



1E	9	22N	21
1G	9	23Q	22
1J	9	24Q	22
1L	9	25B	22
2E	9	25C	22
2G	10	25N	22
2J	10	25P	23
2L	10	26N	23
3E	10	27N	23
3G	10	27P	23
3J	11	30S	24
3L	11	31E	26
4G	11	31G	26
4H	12	31J	27
4J	12	32E	27
4L	12	32G	28
5D	12	32J	28
5N	12	33E	29
6N	13	33G	29
7N	13	33J	30
8N	13	34G	30
9E	13	34J	31
9G	14	35D	31
9J	14	35N	32
9L	14	36N	32
10L	14	39E	33
10Q	14	39G	33
11E	15	39J	34
11G	15	40R	35
11J	15	50T	37
11L	15	60S	38
12G	15	70S	39
12J	16	80S	40
12L	16	90R	41
13E	16	100T	42
13G	16	110S	43
13J	16	120L	43
13L	17	121L	43
14G	17	122L	43
14H	17	125S	44
14J	17	126S	44
14L	17	127S	44
15C	18	128P	44
15N	18	128S	44
15P	18	129P	44
15S	18	130S	45
16N	18	131S	45
16R	19	133S	45
17N	19	134S	45
19N	19	136S	45
20L	19	137S	46
20N	19	138P	46
20Q	20	139P	46
21E	20	140P	46
21G	20	150B	46
21J	20	150D	47
21L	21	150V	47
22G	21	151B	47
22J	21	151D	47
22L	21	151V	47



152B	48	204S	7
152D	48	208	119
152V	48	209	119
153B	48	210	120
153D	48	211	120
153V	49	212	120
154B	49	214S	7
154D	49	220S	7
154V	49	225S	8
155B	49	230W	65
155D	50	232W	65
155V	50	234W	65
156B	50	236W	66
156D	50	241F	66
156V	51	242F	66
157B	51	243F	66
157D	51	244F	67
157V	51	245F	67
158B	52	246B	67
158D	52	248F	67
158V	52	248G	67
159B	52	249F	67
159D	53	250W	68
159V	53	251W	68
160B	53	252F	68
160D	53	254S	68
160V	54	254W	68
161B	54	255S	68
161D	54	255W	69
161V	54	256S	69
164B	55	256W	69
164D	55	257F	69
164V	55	258F	69
165B	55	259F	69
165D	55	259H	70
165V	56	260W	70
167B	56	267F	70
167D	56	267S	70
167V	56	268F	70
170D	56	268S	70
180H	57	269F	71
180K	57	269T	71
180M	58	270C	71
180P	58	270D	71
180Q	59	270R	71
181H	59	271D	71
181K	60	271W	71
181M	60	272W	72
181P	61	273W	72
181Q	61	274B	72
182H	62	274C	72
182K	62	274D	72
182M	63	275D	72
182P	63	276D	72
182Q	64	277D	73
185G	65	278D	73
190S	7	279D	73
198S	7	280X	73
199B	7	281D	73
199B	119	282D	74

283D	74	340D	85
291D	74	341D	85
292D	75	342D	85
293D	75	345D	85
294D	75	350H	86
295M	76	350L	86
295W	76	350M	86
296W	76	350R	87
297C	76	350W	86
297D	77	351H	87
297F	77	351L	87
297M	77	352M	87
297N	77	352W	87
298D	77	354A	88
300D	78	354B	88
301D	78	360M	88
303W	78	360W	88
305D	78	361H	88
307D	78	361L	88
308D	79	362H	88
310C	79	362L	89
311H	79	364L	89
313S	79	364M	89
318D	80	364N	89
318S	80	364S	89
320R	80	365M	89
321R	80	365W	90
322V	80	366R	90
323S	80	366S	90
324W	81	368E	90
326F	81	368M	90
326W	81	368U	91
327F	81	368W	91
327W	82	369L	91
328F	82	369R	91
329F	82	370M	91
330D	82	370U	91
330L	82	370W	92
330M	83	901P	92
334V	83	902P	92
336A	83	903P	92
336B	83	910B	93
336C	83	910P	92
336D	83	915B	94
336E	83	915P	93
336F	83	920B	94
336G	83	920P	94
336H	84	921B	95
336J	84	921P	95
336K	84	922B	96
336L	84	922P	95
336M	84	923B	97
336N	84	923P	96
336P	84	924B	97
336Q	84	924P	97
336R	84	925B	99
337A	84	925P	98
337B	84	926B	99
337C	85	926P	99
337D	85	930B	100



930P	100	1446	122
932P	100	1447	122
933B	101	1448	122
933P	101	1449	122
934B	102	1755	122
934P	101	1756	123
936P	102	1758	123
937P	102	1759	123
940P	102	1765	123
941P	103	1766	123
945P	103	1795	123
946P	103	1797	124
951P	103	1798	124
952P	103	1799	124
956P	103	1801	124
957P	103	2610	117
960B	104	2620	118
960P	103	2630	118
961B	104	2640	118
961P	104	6601	125
962P	104	9558	118
963P	105	9566	118
967P	105	9567	118
970P	106	9865	119
974B	107	9882	119
974P	106	9884	119
975B	108	A30S	25
975P	108	A40R	36
976B	109	A50T	38
976P	108	BL6209	124
980B	110	BL6211	124
980P	109	BL6212	124
981B	112	BL6610	125
981P	111	BL6793	125
982B	112	BL6794	125
982P	112	CSK	8
983B	113	P4E	11
983P	113	P8N	13
984B	114	SA	8
984P	114	T4E	11
985B	115		
985P	114		
986B	115		
986P	115		
987B	115		
987P	115		
988B	116		
988P	115		
990B	117		
990P	116		
1412	120		
1413	120		
1414	121		
1415	121		
1416	121		
1418	121		
1419	121		
1439	122		
1442	117		
1443	117		

400S	6	518S	11
401S	6	520S	11
402S	6	532S	11
403S	6	541S	11
404S	6	552S	12
406S	6	560S	12
407S	6	565S	12
408S	6	572S	12
410S	6	575S	12
411S	6	580S	12
412S	7	599S	13
413S	7	600S	13
415S	7	603S	13
416S	7	604S	13
417S	7	608S	13
418S	7	626S	13
419S	7	627S	13
420S	7	651S	13
421S	7	652S	13
422S	7	653S	14
423S	7	654S	15
424S	8	655S	15
426S	8	676S	15
427S	8	677S	15
428S	8	701S	15
430S	8	710S	15
431S	8	717S	15
432S	8	718S	15
433S	8	719	15
434S	8	720	15
435S	8	721	16
436S	8	722	16
438S	9	724	16
440S	9	725	16
442S	9	726	16
443S	9	727	17
444S	9	728	17
445S	9	729	17
448S	9	730S	17
450S	9	734	17
451S	9	736	18
452S	9	737	18
455S	10	738	18
460S	10	739	18
465S	10	740S	19
470S	10	742S	19
477S	10	743S	19
478S	10	747S	19
480S	10	750S	20
481S	10	752S	20
484S	10	753S	20
492S	10	754S	20
503S	10	756S	20
504S	10	759S	21
505S	10	770S	21
506S	11	771S	21
508S	11	774S	21
515S	11	776S	21
516S	11	777S	21
517S	11		



778S	21	896S	27
779S	22	900S	28
780S	22	901S	28
782S	22	902S	28
783S	22	903S	28
785S	22	904S	28
787S	22	905S	28
789S	22	906S	28
800S	22		
801S	23		
802S	23		
803S	23		
806S	23		
808S	23		
810S	23		
822S	23		
835S	24		
836S	24		
837S	24		
838S	24		
839S	24		
844S	24		
845S	24		
846S	25		
847S	24		
848S	24		
849S	24		
859S	25		
860S	25		
861S	25		
862S	25		
863S	25		
864S	25		
865S	25		
866S	25		
870S	25		
871S	26		
872S	26		
873S	26		
874S	26		
875S	26		
877S	26		
878S	26		
880S	26		
881S	26		
882S	27		
883S	27		
884S	27		
885S	27		
890S	27		
891S	27		
892S	27		
893S	27		

330D	25	9353	5
330L	25	9353	28
330M	25	9354	28
1741	16	9400	5
1741	17	9400	12
1741	25	9400	28
2610	5	9401	5
2610	7	9401	8
2610	11	9401	12
2610	25	9401	28
2620	25	9432-78.....	35
2630	7	9433-78.....	35
2630	11	9435-78.....	35
2630	26	9435-96.....	35
2640	26	9436-78.....	35
9101-60.....	4	9437-78.....	35
9101-60.....	26	9438-78.....	35
9101-72.....	18	9462-78.....	35
9102	4	9462-96.....	35
9102	18	9514-48.....	5
9102	26	9540	7
9105	4	9540	11
9105	18	9540	28
9105	26	9544	7
9109	4	9544	11
9109	18	9544	28
9109	26	9558	15
9110-60.....	4	9558	28
9110-60.....	18	9559	15
9111	26	9559	16
9113	26	9559	28
9114-72.....	26	9566	28
9115	4	9567	29
9115	18	9569	15
9115	24	9569	29
9115	26	9570-36.....	15
9121	27	9572	9
9122-48.....	27	9572	10
9128	27	9572	15
9129	4	9572	29
9129	18	9573	6
9129	27	9573	29
9130-60.....	4	9574	13
9130-60.....	18	9574	29
9169	27	9575	9
9200	27	9575	10
9201	27	9575	29
9202	7	9583-96.....	5
9202	11	9601-35.....	15
9202	27	9601-71.....	19
9203	27	9601-71.....	20
9220	15	9601-71.....	29
9220	27	9602-46.....	10
9262	27	9602-46.....	29
9264	27	9602-58.....	10
9268	27	9603-48.....	9
9351	5	9603-48.....	29
9351	8	9605	9
9351	12	9605	10
9351	28	9605	20



9605	30	9815	14
9606	9	9815	15
9606	10	9815	16
9606	19	9815	24
9606	20	9815	32
9606	30	9820-48.....	7
9610	30	9820-48.....	32
9611-60.....	6	9821-59.....	6
9614-48.....	7	9821-59.....	16
9618	15	9821-59.....	23
9618	30	9821-59.....	32
9628	19	9824	6
9629	19	9824	32
9630	19	9825	6
9631	19	9825	16
9632	20	9825	23
9632	30	9825	32
9633	20	9827	13
9633	30	9827	14
9634	30	9827	17
9639	30	9827	21
9673-48.....	9	9827	22
9674-48.....	9	9827	24
9675-48.....	10	9827	32
9676-48.....	10	9828	16
9678-72.....	20	9828	17
9679	9	9828	32
9679	10	9840-46.....	11
9679	30	9840-46.....	32
9680	9	9841	5
9680	10	9841	7
9680	30	9841	11
9683-96.....	7	9841	33
9703-60.....	24	9842	7
9703-60.....	30	9842	11
9704-60.....	24	9842	33
9704-60.....	31	9843	7
9705	24	9843	11
9705	31	9843	33
9709-48.....	6	9844-48.....	11
9709-48.....	10	9845-96.....	11
9709-60.....	31	9850	21
9710-60.....	24	9860-30.....	16
9711	24	9861-48.....	16
9711	31	9865	5
9742	22	9865	8
9742	31	9865	12
9801-48.....	17	9865	33
9801-72.....	13	9875-48.....	13
9801-72.....	21	9877	33
9801-72.....	22	9878-72.....	22
9801-72.....	31	9880	33
9803-48.....	14	9881	19
9803-48.....	31	9881	20
9809-72.....	13	9881	21
9809-72.....	31	9881	22
9810-46.....	5	9881	23
9810-46.....	31	9881	33
9814	5	9882	33
9814	32	9883	19

988320
988321
988322
988323
988333
988433
9885-48.....14
9886-96.....14
988934
9890-30.....17
98926
989234
98936
989334
989416
989434
989523
989534
990034
9901-72.....23
99096
99099
990910
990913
990914
990934
1-269-8663.....36
1-269-8664.....36
1-269-8665.....36
1-269-8666.....36
1-269-8667.....36
1-269-8668.....36
1-269-8669.....36
1-269-8670.....36
1-269-8671.....36
1-269-8672.....36
1-269-8673.....36
1-269-8674.....36
1-269-8675.....36
1-269-8676.....36
1-269-8677.....37
1-269-8678.....37
1-269-8679.....37
1-269-8680.....37

