



DOOR HARDWARE

PRICE BOOK #13

Effective 4/1/2018

webmaster@hagerco.com

139 Victor Street
Saint Louis, MO 63104

800-325-9995 (main phone)
314-772-4400 (local phone)
800-782-0149 (main fax)
314-772-0744 (local fax)

Part # 5-500-2018



One Family. One Brand. One Vision.™

www.hagerco.com

CONTACT INFORMATION

Corporate Office

139 Victor Street
St. Louis, Missouri 63104
800-325-9995 (Sales and Service)
800-255-3590 (Main Office)
314-772-4400 (Local Main Office)
800-782-0149 (Fax)
314-772-0744 (Local Fax)
webmaster@hagerco.com
www.hagerco.com

Montgomery Plant

150 Folmar Parkway
Montgomery, AL 36105
334-284-4700 (Main Phone)

Montgomery Distribution Center

200 County Court
Montgomery, AL 36105
334-288-0432 (Main Phone)

SoCal Office

12440 Firestone Boulevard, Suite 310
Norwalk, CA 90650
855-557-0010 (Main Phone)

Canada Office

P.O. Box 124
Kitchener, Ontario N2G 3W9
800-255-3590 (Main Phone)
800-552-1926 (Main Fax)

A CLEANER, GREENER PRICE BOOK

- Our Printer** uses sophisticated ink-mixing technology that reduces VOCs and reduces ink waste to less than one percent. They consistently recycle, reuse, and reduce both paper and ink consumption.
- Our Inks** are soy-based, reducing harmful VOCs and preventing harmful chemicals from entering the wastewater system.
- Our Company** is concerned about how our company and products affect the environment. As a result, we've taken steps to minimize our impact—and we're continually reviewing ways to do more. Throughout the production of this Price Book, we made every effort to recycle and use both sides of the paper.



General Information

TERMS AND CONDITIONS

General

Prices indicated will be in effect from the date on the cover and are subject to change without notice. If, under any law now or hereafter passed, the seller is required to pay a tax on sales or an excise tax, the amount of these taxes will be added to the invoice value. We shall not be responsible for any loss or damage resulting from delay in filling orders caused by fire, flood, strikes, differences with workmen, government regulations, accidents, transportation delays, shortages of materials, or other causes beyond our control. Should raw material prices rise substantially, it may become necessary to add a surcharge by material type at the time of shipment. Orders are processed in order of receipt, but lead times will vary in relation to production specifications. Errors or omissions in published prices are subject to correction.

Payments

Accounts are net 30 days, or 1% for cash if paid within 15 days following the date of invoice. Cash discounts do not apply to credit card payments. Accounts unpaid at expiration of 60 days from the date of invoice will be subject to a late payment charge of 1-1/2% per month of the total balance. Also, accounts unpaid after 60 days will be subject to C.O.D. shipments. Accounts unpaid after 90 days will be placed for collection. All collection charges, attorney fees, and court costs will be added to the amount due. An NSF (insufficient fund) check fee in the amount of \$30.00 will be added to the account.

Minimum Order Charges

Orders with a net value of less than \$50.00 will be invoiced at \$50.00.

Minimum Annual Purchase Requirement

A minimum annual amount of \$15,000.00 is required to maintain open account status with Hager Companies.

Packaging

- A charge of \$100.00 net will be made when requested to itemize and special package in accordance with such schedules.
- A charge of \$50.00 net will be made when requested to make changes on itemized jobs after the orders have been processed.
- A charge of \$15.60 net for crating certain products will be added to invoices at time of shipment.

Quick Ship

The items throughout this price book that have prices in **bold and red** are items included in the Hager Quick Ship Program and typically ship within 24 hours. When ordering these products, please visit www.hagerco.com and click on 'Quick Ship' in the footer. You will be prompted to log in with your My Hager account name and password and then you may begin ordering.

Shipments and Freight Charges

All shipments are F.O.B. Point of Origin. Freight prepaid on shipments having a value of \$2,000.00 net or more, route of our selection. Less than \$2,000.00 net shipped prepay and add. Shipments by Express, Air Freight, or United Parcel Service are F.O.B. Point of Origin, without any freight allowance. Any request for shipments not falling under these guidelines may be subject to a handling charge. Hager will not provide consignee or third party freight billing.

There will be a \$25.00 net charge for furnishing proof of delivery receipt. This charge will be canceled if delivery was not made. Proof of delivery may be obtained by visiting www.hagerco.com and establishing an account with "My Hager." Due to size limitations by certain carriers, some orders may require LTL shipment.

Please note that for next day air shipments, written consent with an authorized signature must be sent via fax or e-mail to Hager Companies before an order will be released for overnight delivery. Next day air requests must be received prior to 1:00 p.m. CDT.



Cancellations and Make-to-Order Items

Orders for non-stock goods, accepted by Hager, are non-cancelable except with prior written consent, and then subject to a service charge based on the manufacturing expenses incurred. Under no circumstances will non-stock, make-to-order or discontinued product be accepted for return unless it is due to a Hager error.

Return Goods Policy

No credit will be issued for returned goods unless such return is authorized by our St. Louis office. There will be a minimum 35% handling and restocking charge invoked in connection with the return. Freight terms will be specified on return goods authorization forms. Return goods must be in saleable condition or no credit will be issued and goods will be destroyed. No goods will be accepted for return after 6 months. No return goods authorization will be issued for less than \$25.00.

Warranty Returns

A credit in the amount of the original purchase order will be issued after the returned product is inspected and the defect is found to be valid.

Inspection and Delivery

Customer will inspect all product deliveries immediately upon receipt. Hager will assume acceptance of delivered product if not notified within 5 days of receipt of product. If damage is visible upon receipt, note that on the Bill of Lading and notify Hager immediately.

Claims

All claims should be submitted to Hager as follows:

- All claims for pricing adjustments must be submitted within 30 days of invoice date
- All claims for order quantity discrepancies must be submitted within 5 days
- All claims for damaged material prior to acceptance by customer must be submitted within 5 days

Limited Warranty

Subject to the limitations of liability set forth below, Hager Companies (the "Company") warrants to purchasers that the products which the Company sells under the "Hager" trademark or trade name are free from defects in workmanship and materials under normal use and regular service and maintenance from date of delivery.

This is the sole and exclusive warranty given by the company with respect to the products and is in lieu of any and all other warranties, express or implied, arising by operation of law or otherwise. All implied warranties, including but not limited to the warranties of merchantability, non-infringement and fitness for a particular purpose, are hereby excluded.

This warranty does not cover defects or damage arising from improper installation, incorrect application, lack of or improper maintenance, improper storage, shipping and handling, excessive wear and tear, misuse, abuse, accident, unauthorized service, or use with unauthorized products or parts.

The sole and exclusive liability of the Company under this warranty or otherwise, shall be limited to the repair or replacement of any product or component part which shall prove defective to the original purchaser from the Company. The Company will not pay for the costs or repair performed other than in accordance with this warranty. The company shall not be liable for damages caused by delay in performance and in no event, regardless of the form of the claim or cause of action (whether based on contract, infringement, negligence, strict liability, other tort or otherwise), shall the company's liability to purchaser and/or its customers exceed the price paid by purchaser for the specific products giving rise to the claim or cause of action. Purchaser agrees that in no event shall the company's liability to purchaser and/or its customers extend to include incidental, consequential or punitive damages resulting from use of these products, or arising out of any breach of this warranty. The term "consequential damages" shall include, but not limited to, loss of anticipated profits, business interruption, loss of use or revenue, cost of capital or loss or damage to property or equipment. The foregoing limitations and exclusions are intended to be effective



General Information

to the maximum extent permitted by law. This warranty is governed by the law of the State of Missouri without regard to its conflicts of law principles. The company and purchaser agree that the United Nations Convention on Contracts for the International Sale of Goods and the United Nations Convention on the Limitation Period in the International Sale of Goods shall not apply to sales of the products covered by this warranty.

Written notice of a product believed to be defective as covered by this warranty should be sent to Hager Companies, 139 Victor Street, St. Louis, Missouri 63104 within 30 days from the discovery of the alleged defects, and should include the purchaser's name and address, identification of the product, and brief description of the defect. Upon receipt of such notice, the Company will inform the purchaser where to ship such product, shipping charges prepaid, for examination. In the event such examination reveals a defect covered by this warranty, the Company will, at its own option, repair or replace the product, and return it or the replacement to the purchaser, with charge only for transportation.

Hager Advantage Program

Please note that the terms of your Hager Advantage Program override any terms found in this price book. If you are not active in our Hager Advantage Program and would like to take advantage of the many benefits, please contact your Hager Sales Representative today.

CODES AND ILLUSTRATIONS

Units of Measure

EACH	Item in a box either with or without screws.
PACK	Items poly bagged (1 or more) per bag.
PAIR	Items (1 or more) pair per box.
SET	Items (1 or more) sets per box.

Illustrations

Pictures shown in this Price Book are for general product information only and are not meant to be used as templates. Contact Hager Companies Sales and Service for final product identification for installation, or go to www.hagerco.com to download templates or installation instructions.

Packaging

The following codes have been established to provide clarification of packaging methods. The basic code letter(s) are shown in parenthesis in the unit column of each page. The letter designation refers to the standard Hager Pack.

Hager Companies reserves the right to change the packaging methods when deemed necessary and to increase or decrease quantities to make full case quantities on a specific item.

B = Boxed
PB = Poly Bag
BLK = Bulk Pack
SET = Set



DISCOUNTS

Customer Number

Architectural Hinges

Residential Hinges

Roton Continuous Geared Hinges

Stainless Steel Continuous Hinges

Trim & Auxiliary

Thresholds & Weatherstripping

Sliding Door Hardware

Locks

Door Closers

Exit Devices

Electrified Products

Notes





One Family. One Brand. One Vision.™

www.hagerco.com

TABLE OF CONTENTS

A		E	
Armor Fronts (Mortise)	52-53	Electric Options	
		Cylindrical Locks	24
		Mortise Locks	47
B		Electric Standalone Locks	
Backset Extension Links		34K1	28-29
2500.....	8	34K2.....	28-29
3400.....	24		
3500.....	30	F	
Blocking Rings.....	65	Faceplate Adapter	6
C		I	
Cams (Fixed Cylinder).....	59-60	Interchangeable Cores (Small Format)	60
Cams (LFIC)	65	Interchangeable Cores (Large Format).....	63
Cams (SFIC).....	62-63	Interconnected Locks	
Cash Box Nut.....	66	3700, Grade 2	39-41
Cores		K	
Small Format Interchangeable.....	60	Key Blanks (Fixed Cylinder).....	56-57
Large Format Interchangeable	63	Key Blanks (SFIC).....	61
Cylinders		Key Blanks (LFIC).....	63
Key-In-Lever	57	Keying Charges (Fixed Cylinder)	56
Mortise (Fixed Cylinder)	59	Keying Charges (SFIC).....	61
Mortise (SFIC).....	62	Keying Charges (LFIC).....	63
Mortise Dummy.....	59	Keying, Tools and Accessories.....	67-68
Mortise ADA Turn Knob.....	59	Keys, Cut (Fixed Cylinder)	56-57
Rim (Fixed Cylinder)	58	Keys, Cut (SFIC).....	61
Rim (SFIC).....	62	Keys, Cut (LFIC).....	63-64
Rim Dummy.....	58	L	
Cylinder Aligning Sleeves.....	10, 26, 29, 35, 38	Latchbolts	
Cylinder Collars.....	51, 66-67	2300, Tubular	6
Cylindrical Locks		2500, Grade 2 Cylindrical.....	8-11
2500, Grade 2.....	8-11	3400, Grade 1 Cylindrical.....	22-27
3400, Grade 1.....	22-27	34K1/K2, Grade 1 Standalone.....	28
3500, Grade 2.....	30-35	3500, Grade 2 Cylindrical.....	30-31
		3600, Grade 2 Tubular	36
		3700, Grade 2 Interconnected.....	39
D		Lead Lining	8, 22, 30, 43, 45, 48
Deadbolts		Lead Times	3
3100, Grade 1.....	12		
3200, Grade 2.....	16		
3700, Interconnected.....	39		
Deadlocks			
3100, Grade 1.....	12-15		
3200, Grade 2.....	16-20		
Dustbox (Mortise).....	52		
Dustbox (Deadbolt)	13,17		
Decorative Locks			
2300.....	5-7		



Locks

M

Mortise Cam Screws	65-66
Mortise Cylinder	59, 62, 64

Mortise Locks

Mortise Locks (Deadlocks).....	48
Mortise Locks (Small Case Deadlocks)	49
Mortise Locks (Sectional).....	43-44
Mortise Locks (Escutcheon).....	45-46
Mortise Locks (Sliding Door).....	50
Mortise Lock Accessories	51-55

P

Power Supplies

Cylindrical Lock.....	24
Mortise Lock.....	47

R

Rim Cylinder	58 62, 64
--------------------	-----------

S

Software

34K1	28
34K2.....	28

Screw Packs

2300, Tubular	7
2500, Grade 1 Deadlock.....	10
3100, Grade 2 Cylindrical.....	14
3200, Grade 2 Deadlock	18
3400, Grade 1 Cylindrical.....	27
34K1/K2, Grade 1 Standalone.....	29
3500, Grade 2 Cylindrical.....	35
3600, Grade 2 Tubular	38
3700, Grade 2 Interconnected.....	41
3800, Grade 1 Mortise.....	53
Stock Numbers	72-86

Strikes

2300, Tubular	6
2500, Grade 1 Deadlock.....	10
3100, Grade 1 Deadlock.....	13
3200, Grade 2 Deadlock.....	17
3300, Grade 3 Tubular.....	21
3400, Grade 1 Cylindrical.....	26
34K1/K2, Grade 1 Standalone	29
3500, Grade 2 Cylindrical.....	34
3600, Grade 2 Tubular	38
3700, Grade 2 Interconnected.....	41
3800, Grade 1 Mortise.....	50-52

T

Tactile Warning	8, 22, 28, 30, 43, 45
Tailpieces (Fixed Cylinder)	57-58
Tailpieces (SFIC).....	61-62
Tailpieces (Rim Cylinder)	59, 64
Thumbturns (Mortise Lock).....	53
Thru-bolt Jigs.....	11, 29, 35

Tubular Locks

2300	5-7
3300, Grade 3.....	21
3600, Grade 2.....	36-38

INTRODUCTION

Hager Companies offers a variety of locks to meet a wide range of applications and solutions. Heavy Duty Grade 1 deadlocks, cylindrical locks, and mortise locks are ideal for schools, hospitals, and other high-use environments. Grade 2 deadlocks and cylindrical locks are ideal for less abusive environments, while Grade 2 tubular locks are suitable for heavy duty residential or medium duty commercial environments.

All Hager locks have been rigorously tested and certified to the highest standards. Most lock series are BHMA certified per the ANSI A156.2 standards. They are also UL/cUL Listed for all functions up to and including 3 hours for "A" labeled doors. In addition to the certifications, all Hager leversets are ADA compliant and most come with a lifetime warranty.

Most Hager locksets are either non-handed or field reversible in the case of the 3800 Series mortise lock. Conventional cylinder and small format interchangeable core are available on keyed functions. Most lock series offer three lever style options along with one knob style. Please check appropriate section for series specific options.

QUICK SHIP

Products denoted with **red and bold** in the stock number listing in the back of the pricing section are available to order through the QuickShip program and ship within 24 hours. When ordering these products please visit www.hagerco.com and log in to MyHager to access the 'Quick Ship' portal. Due to the promptness of the fulfillment process, Quick Ship orders are non-cancellable.

LEAD TIMES

Stock items will typically ship in five working days or less from the order entry date. Made-to-order items will typically ship in 15 working days depending on seasonal volume and order complexity. Special orders including industrials, special machining, and large quantities may need to be scheduled. The anticipated ship date will be included with each order acknowledgement. Please contact Customer Service if product availability is in question.

Keyed lock orders will typically ship in 10-15 working days from the order entry date. All appropriate information and paperwork must be supplied for Hager to schedule and acknowledge master keyed lead times.

CANCELLATION NOTIFICATION

Cancellation for made-to-order items must be communicated within 48 hours of order placement.



3453 2³/₄" US26D US26 WTN SCC KD ASA TW

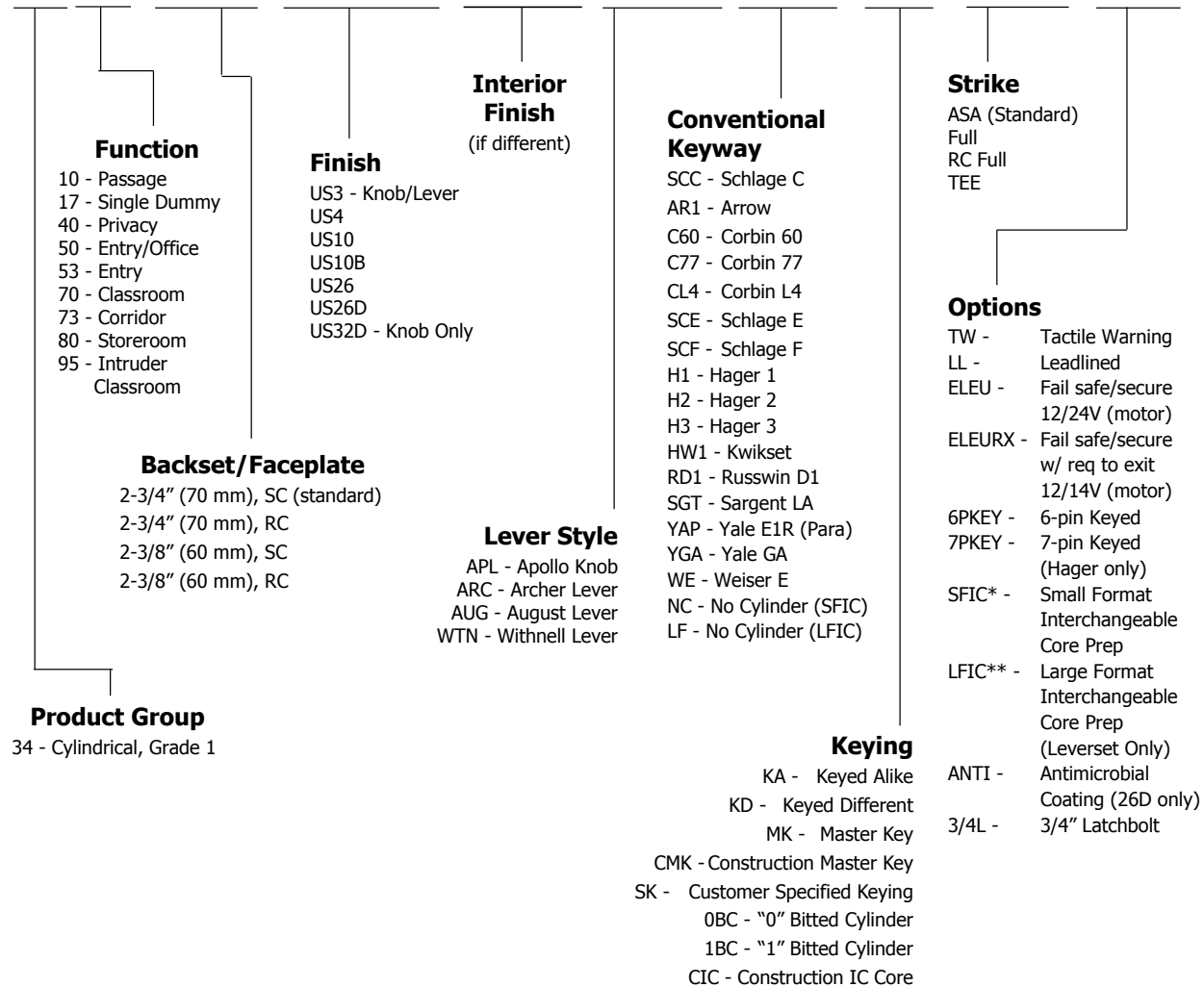

Notes:

- If master-keyed, include master key instruction sheet with order (available online).
- For additional keying information, please refer to cylinder, core, and keying section of catalog.
- Quick Connect option available on 3400 series electrified models (EL, EU, RX). **Ordering example: 3480 2-3/4" US26D WTN SCC KD ASA ELEUQC.**
- Interchangeable construction core will be included with the lockset if "CIC" is specified in keying section. Customer must specify BLUE or RED color for SFIC.

* Small format interchangeable core sold separately. Available in Best Keyways or Hager Keyways, A Standard. **Ordering example: 3453 2-3/4" US26D WTN NC ASA SFIC.**

Please refer to our Catalog or website (www.hagerco.com) for more detailed and series specific ordering information along with additional information including functions available, additional options, and keying information. Ordering forms such as Master Keying Instruction Sheet and Cylinder Instructions and Ordering Guide are also available on our website (www.hagerco.com).

Description

2300 Series

Decorative Tubular Locks

2-3/8" (60 mm) backset (optional)

2-3/4" (70 mm) backset (standard)

2-1/4" x 1" (57 mm x 25 mm) SC and RC Faceplate (standard)

Round and square corner full lip strikes (standard)

Optional strikes available. For ASA strike, add \$7.00 adder to list price of the lock.

Refer to catalog or website for more detailed information on functions.

Finishes other than US10B, US15, and US26D, are subject to extended lead-times. Consult customer service for availability.

When ordering handed lever designs, LH=LHR and RH=RHR

Split finish available at extended lead time. Handing information required when ordering split finish.



Charles 



Johnston 



Joshua 



Louis 



Warren 

Function	Finish	2018 List	Case Qty.
2310 Passage	US3	105.70	24
	US10B	105.70	
	US15	101.60	
	US26	105.70	
	US26D	101.60	
2317 Single Dummy (Specify handing on Johnston and Warren Levers)	US3	47.50	24
	US10B	47.50	
	US15	45.70	
	US26	47.50	
	US26D	45.70	

Function	Finish	2018 List	Case Qty.
2327 Double Dummy	US3	95.00	24
	US10B	95.00	
	US15	91.35	
	US26	95.00	
	US26D	91.35	
2340 Privacy	US3	112.50	24
	US10B	112.50	
	US15	108.15	
	US26	112.50	
	US26D	108.15	



Locks - 2300 Series



Latchbolts		Finish	2018 List	Box Qty.
Description				
2-639-7607 Passage Spring Latch - (2300) 2-3/4" (70 mm) backset		n/a	17.45	10
2-639-7609 Passage Spring Latch - (2300) 2-3/8" (60 mm) backset		n/a	17.45	10
2-639-7608 Privacy Latch - (2300) 2-3/4" (70 mm) backset		n/a	17.45	10
2-639-7610 Privacy Latch - (2300) 2-3/8" (60 mm) backset		n/a	17.45	10
Strikes		Finish	2018 List	Box Qty.
Description				
3933 T-Strike with Plastic Dust Box 1-1/8" x 2-3/4" (29 mm x 70 mm), square corner		US3	8.10	10
		US10B	8.10	
		US15	8.10	
		US26	8.10	
		US26D	8.10	
2-639-7617 Full lip replacement strikes (2300) (Includes square and round corner)		US3	12.10	10
2-639-7619 Full lip replacement strikes (2300) (Includes square and round corner)		US10B	12.10	10
2-639-7620 Full lip replacement strikes (2300) (Includes square and round corner)		US15	12.10	10
2-639-7621 Full lip replacement strikes (2300) (Includes square and round corner)		US26	12.10	10
2-639-7622 Full lip replacement strikes (2300) (Includes square and round corner)		US26D	12.10	10
3935 ASA Strike 1-1/4" x 4-7/8" (32 mm x 124 mm), square corner		US3	12.25	10
		US10B	13.00	
		US15	12.25	
		US26	12.25	
		US26D	12.25	
3959 Faceplate Adapter Converts 1" (25 mm) to 1/8" (29 mm) width		NF	2.65	10





Components and Screwpacks				
Description	Finish	2018 List	Box Qty.	
2-639-7601 Privacy Accessory Kit	US3	8.50	10	
2-639-7603 Privacy Accessory Kit	US10B	8.50	10	
2-639-7604 Privacy Accessory Kit	US15	8.50	10	
2-639-7605 Privacy Accessory Kit	US26	8.50	10	
2-639-7606 Privacy Accessory Kit	US26D	8.50	10	
2-300-0091 Replacement Screw Packs	US3	10.50	10	
2-300-0092 Replacement Screw Packs	US10B	10.50	10	
2-300-0093 Replacement Screw Packs	US15/26/26D	10.50	10	



Locks - 2500 Series



Archer  



Withnell  

Description

2500 Series

Grade 2 Cylindrical - Economy
 Fixed Cylinder, Standard
 6 Pin Cylinders, 5-pin Keyed
 Schlage C Keyway - KD Standard
 2-3/4" (70 mm) Backset
 2-1/4" x 1-1/8" (57 mm x 29 mm) SC Faceplate
 ASA Strike

Small Format Interchangeable Core option Available (cores sold separately - refer to Keying/Core section).

If construction SFIC core is included with the lockset, \$51.20 will be added to the list price of the lock. Refer to keying/cores section for construction core options.

Lead Lined available. Add \$137.00 to the list price of the lock.

Tactile Warning available (levers only). Add \$42 to the list price of the lock.

Optional backsets, faceplates and strikes available.

Optional keying/keyways available.

Refer to catalog or website for more detailed information on functions.

Function	Finish	2018 List	Case Qty.
2510 (F75) Passage	US3	97.10	6
	US10B	97.10	
	US26D	97.10	
2517 Single Dummy	US3	58.30	12
	US10B	58.30	
	US26D	58.30	
2525 (F111) Exit	US3	87.45	6
	US10B	87.45	
	US26D	87.45	
2527 BTB Dummy	US3	114.35	6
	US10B	114.35	
	US26D	114.35	

Function	Finish	2018 List	Case Qty.
2540 (F76A) Privacy	US3	99.20	6
	US10B	99.20	
	US26D	99.20	
2550 (F82A) Office	US3	110.65	6
	US10B	110.65	
	US26D	110.65	
2553 (F109) Entry	US26D	110.65	
2570 (F84) Classroom	US3		
	US26D		
2580 (F86) Storeroom	US3		





Latchbolts	Finish	2018 List	Box Qty.
Description			
3947 Spring Latch - Passage Only (2510) 2-3/4" (70 mm) Backset 2-1/4" x 1-1/8" (57 mm x 29 mm) Faceplate Must specify square or round corner.	US3 US10B US26D	28.00 28.00 28.00	10
3949 Spring Latch - Passage Only (2510) 2-3/8" (60 mm) Backset 2-1/4" x 1" (57 mm x 25 mm) Faceplate Must specify square or round corner.	US3 US10B US26D	28.00 28.00 28.00	10
3965 Spring Latch - Privacy Only (2540) 2-3/4" (70 mm) Backset 2-1/4" x 1-1/8" (57 mm x 29 mm) Faceplate Must specify square or round corner.	US3 US10B US26D	28.00 28.00 28.00	10
3967 Spring Latch - Privacy Only (2540) 2-3/8" (60 mm) Backset 2-1/4" x 1" (57 mm x 25 mm) Faceplate Must specify square or round corner.	US3 US10B US26D	28.00 28.00 28.00	10
3948 Dead Latch - 2525 and all keyed functions (2500 Series) 2-3/4" (70 mm) Backset 2-1/4" x 1-1/8" (57 mm x 29 mm) Faceplate Must specify square or round corner.	US3 US10B US26D	28.00 28.00 28.00	10
3950 Dead Latch - 2525 and all keyed functions (2500 Series) 2-3/8" (60 mm) Backset 2-1/4" x 1" (57 mm x 25 mm) Faceplate Must specify square or round corner.	US3 US10B US26D	28.00 28.00 28.00	10
3959 Faceplate Adapter Can be used with 2500 2-3/8" (60 mm) backset latchbolt. Converts 1" (25 mm) to 1-1/8" (29 mm) width.	NF	2.65	10
3917 3-3/4" (95 mm) Backset Extension Link Must be used with 2-3/8" (60 mm) backset latchbolt to achieve 3-3/4" total backset.	NF	18.50	
3937 5" (127) Backset Extension Link Must be used with 2-3/4" (70 mm) backset latchbolt to achieve 5" total backset.	NF	20.00	
Drive-In Latchbolts	Finish	2018 List	Box Qty.
Description			
3922 2-3/4" (70 mm) Drive-In Spring Latch - Passage only (2510)	NF	28.00	20
3923 2-3/4" (70 mm) Drive-In Spring Latch - Privacy only (2540)	NF	28.00	20
3925 2-3/8" (60 mm) Drive-In Spring Latch - Passage only (2510)	NF	28.00	20



Locks - 2500 Series

Drive-In Latchbolts			
Description	Finish	2018 List	Box Qty.
3926 2-3/8" (60 mm) Drive-In Spring Latch - Privacy only (2540)	NF	28.00	20
3924 2-3/4" (70 mm) Drive-In Dead Latch - All keyed functions (2500 Series)	NF	28.00	20
3927 2-3/8" (60 mm) Drive-In Dead Latch - All keyed functions (2500 Series)	NF	28.00	20
Strikes			
Description	Finish	2018 List	Box Qty.
3933 T-Strike with Plastic Dust Box 1-1/8" x 2-3/4" (29 mm x 70 mm), square corner	US3 US10B US26D	8.10 8.10 8.10	10
3934 Full Lip Strike 1-5/8" x 2-1/4" (41 mm x 57 mm), square corner	US3 US10B US26D	8.10 8.10 8.10	10
3935 ASA Strike Plate Shipped standard with 2500 Series 1-1/4" x 4-7/8" (32 mm x 124 mm), square corner 1-5/16" lip Order dust box separately	US3 US10B US26D	12.25 13.00 12.25	10
3958 Round Corner Full Lip Strike 1-5/8" x 2-1/4" (41 mm x 57 mm), round corner (1/4" radius)	US3 US10B US26D	8.10 8.10 8.10	10
Components and Screwpacks			
Description	Finish	2018 List	
2-639-3577 Cylinder Aligning Sleeve (10 pack)	NF	3.05	
2-300-0048 Screwpack - 2500 Series Lever Locksets	US3	12.15	
2-300-0050 Screwpack - 2500 Series Lever Locksets	US10B	12.15	
2-300-0052 Screwpack - 2500 Series Lever Locksets	US26D	12.15	
2-300-0058 Screwpack - 2517/2527 Lever Locksets only	NF	12.15	
2-639-3523 2500 Series Thru Bolt Posts	NF	4.00	





Components and Screwpacks			
Description	Finish	2018 List	
2-669-0389 ASA Metal Dust Box	NF	5.70	
3911 2500 Series Leverset Thru-Post Drill Jig	NF	18.75	ea



Locks - 3100 Series



Description

3100 Series

Grade 1
 Fixed Cylinder Standard
 6 Pin Cylinders, 5-pin Keyed
 Schlage C Keyway - KD Standard
 2-3/4" (70 mm) Backset
 2-1/4" x 1-1/8" (57 mm x 29 mm) Square Corner Faceplate
 Square Corner Strike

If construction SFIC core is included with the lockset, \$51.20 will be added to list price of the lock. Refer to keying/cores section for construction core options.

Small Format Interchangeable Core option available (cores sold separately - refer to Keying/Core section).

Optional backsets, faceplates, and strikes available (see below).

ASA Strike Available. Add \$7.00 to list price of deadlock.

Optional keying/keyways available.

Refer to catalog or website for more detailed information on functions.

Function	Finish	2018 List	Case Qty.
3114 (E2141) Double Cylinder	US3	186.10	12
	US4	186.10	
	US10	186.10	
	US10B	186.10	
	US26	186.10	
	US26D	178.95	
3115 (E2151) Cylinder x Thumbturn	US3	164.10	12
	US4	164.10	
	US10	164.10	
	US10B	164.10	
	US26	164.10	
	US26D	157.80	

Function	Finish	2018 List	Case Qty.
3118 (E2171) Classroom	US3	169.80	12
	US4	169.80	
	US10	169.80	
	US10B	169.80	
	US26	169.80	
	US26D	163.25	





Deadbolts			
Description	Finish	2018 List	Box Qty.
3940 2-3/4" (70 mm) Backset - Standard 2-1/4" x 1-1/8" (57 mm x 29 mm) Faceplate Must Specify Square or Round Corner	US3	28.00	10
	US4	29.80	
	US10	29.80	
	US10B	28.00	
	US26D	28.00	
3941 2-3/8" (60 mm) Backset 2-1/4" x 1" (57 mm x 25 mm) Faceplate Must specify square or round corner	US3	28.00	10
	US4	29.80	
	US10	29.80	
	US10B	28.00	
	US26D	28.00	
Strikes			
Description	Finish	2018 List	Box Qty.
3929 ASA Deadlock Strike 1-1/4" x 4-7/8" (32 mm x 124 mm), Square Corner 1 5/16" lip Order dust box separately.	US3	19.70	10
	US4	20.95	
	US10	20.95	
	US10B	19.70	
	US26	19.70	
	US26D	19.70	
3930 Strike with plastic dust box 1-1/8" x 2-3/4" (29 mm x 70 mm), Square corner	US3	8.00	10
	US4	8.45	
	US10	8.45	
	US10B	8.00	
	US26D	8.00	
2-639-3109 Deadlock Dust Box	NF	3.85	10
Components and Screwpacks			
Description	Finish	2018 List	
2-639-3151 Collar Handing Keys - 3118 - (RH and LH w/ set screw)	NF	6.40	
2-639-7146 Thumbturn Repair Kit - 3100 Series	US3	11.60	
2-639-7147 Thumbturn Repair Kit - 3100 Series	US4	11.60	
2-639-7148 Thumbturn Repair Kit - 3100 Series	US10	11.60	
2-639-7149 Thumbturn Repair Kit - 3100 Series	US10B	11.60	
2-639-7150 Thumbturn Repair Kit - 3100 Series	US26	11.60	
2-639-3168 Thumbturn Repair Kit - 3100 Series	US26D	11.60	



Locks - 3100 Series

Components and Screwpacks		Finish	2018 List
Description			
	2-639-3152 Thumbturn Rose - 3100 Series	US3	9.30
	2-639-3153 Thumbturn Rose - 3100 Series	US4	9.30
	2-639-3154 Thumbturn Rose - 3100 Series	US10	9.30
	2-639-3155 Thumbturn Rose - 3100 Series	US10B	9.30
	2-639-3156 Thumbturn Rose - 3100 Series	US26	9.30
	2-639-3157 Thumbturn Rose - 3100 Series	US26D	9.30
	2-300-0000 Screwpack 3115/3118	US3/US10	11.15
2-300-0001 Screwpack 3115/3118	US4	11.15	
2-300-0003 Screwpack 3115/3118	US10B	11.15	
2-300-0004 Screwpack 3115/3118	US26	11.15	
2-300-0005 Screwpack 3115/3118	US26D	11.15	
2-300-0006 Screwpack 3114	US3/US10	11.15	
2-300-0007 Screwpack 3114	US4	11.15	
2-300-0009 Screwpack 3114	US10B	11.15	
2-300-0010 Screwpack 3114	US26	11.15	
2-300-0011 Screwpack 3114	US26D	11.15	
2-639-3167 Tailpiece Kit for 2" - 2-1/4" Thick Door (3114/3118 Fixed Cylinder Only)		8.60	
2-639-3236 Tailpiece Kit for 2" - 2-1/4" Thick Door (3114 Fixed Cylinder Only)	US3/US4/ US10	8.60	
2-639-3238 Tailpiece Kit for 2" - 2-1/4" Thick Door (3114 Fixed Cylinder Only)	US10B	8.60	
2-639-3239 Tailpiece Kit for 2" - 2-1/4" Thick Door (3114 Fixed Cylinder Only)	US26/US26D	8.60	





Components and Screwpacks		
Description	Finish	2018 List
2-639-7164 SFIC Deadlock Cylinder Assembly - 3115/3118	US3	20.00
2-639-7167 SFIC Deadlock Cylinder Assembly - 3115/3118	US4	20.00
2-639-7160 SFIC Deadlock Cylinder Assembly - 3115/3118	US10	20.00
2-639-7161 SFIC Deadlock Cylinder Assembly - 3115/3118	US10B	20.00
2-639-7163 SFIC Deadlock Cylinder Assembly - 3115/3118	US26D	20.00



Locks - 3200 Series



Description

3200 Series

Grade 2
 Fixed Cylinder, Standard
 6 Pin Cylinders, 5-pin Keyed
 Schlage C Keyway - KD Standard
 2-3/4" (70 mm) Backset
 2-1/4" x 1-1/8" SC Faceplate
 (57 mm x 29 mm)
 Square Corner Strike

Small Format Interchangeable Core option available (cores sold separately - refer to Keying/Core section).

If construction SFIC core is included with the lockset, \$51.20 will be added to list price of the lock. Refer to keying/cores section for construction core options.

Refer to Catalog or website for more detailed information on functions.

Optional backsets, faceplates, and strikes available (see next page).

ASA Strike Available. Add \$7.00 to list price of deadlock.

Optional keying/keyways available.

Function	Finish	2018 List	Case Qty.
3214 (E2142) Double Cylinder	US3	108.60	12
	US4	108.60	
	US10	108.60	
	US10B	108.60	
	US26D	103.45	
	US32	94.90	
	US32D	94.90	
3215 (E2152) Cylinder x Thumbturn	US3	88.45	12
	US4	88.45	
	US10	88.45	
	US10B	88.45	
	US26D	84.25	
	US32	77.30	
3216 Thumbturn x Occupancy Indicator	US3	70.35	20
	US4	70.35	
	US10	70.35	
	US10B	70.35	
	US26D	67.00	
	US32	61.45	
US32D	61.45		

Function	Finish	2018 List	Case Qty.
3220 (E21112) Thumbturn only w/ Blank Plate	US3	65.75	20
	US4	65.75	
	US10	65.75	
	US10B	65.75	
	US26D	62.60	
	US32	57.45	
	US32D	57.45	
3221 (E2192) Thumbturn only (Replaced 3219)	US3	54.05	20
	US4	54.05	
	US10	54.05	
	US10B	54.05	
	US26D	51.50	
3222 Retrofit Kit for use w/ 3220 or 3221	US3	35.15	20
	US4	35.15	
	US10	35.15	
	US10B	35.15	
	US26D	33.50	
	US32	30.75	
US32D	30.75		



Deadbolts Description	Finish	2018 List	Box Qty.
3940 2-3/4" (70 mm) Backset - Standard 2-1/4" x 1-1/8" (57 mm x 29 mm) Faceplate Must Specify Square or Round Corner US32 and US32D available in square corner only	US3	28.00	10
	US4	29.80	
	US10	29.80	
	US10B	28.00	
	US26D	28.00	
	US32	28.00	
	US32D	28.00	



3941 2-3/8" (60 mm) Backset 2-1/4" x 1" (57 mm x 25 mm) Faceplate Must specify square or round corner US32 and US32D available in square corner only	US3	28.00	10
	US4	29.80	
	US10	29.80	
	US10B	28.00	
	US26D	28.00	
	US32	28.00	
	US32D	28.00	



3942 2-3/8" - 2-3/4" (60 mm - 70 mm) Adjustable 2-1/4" x 1-1/8" (57 mm x 29 mm) Square Corner Faceplate For use with 3220, 3221 deadlocks only Round corner optional 1" Wide faceplate available in square corner or round corner US32 and US32D available in square corner only	US3	28.00	10
	US4	29.80	
	US10	29.80	
	US10B	28.00	
	US26D	28.00	
	US32	28.00	
	US32D	28.00	



3959 Faceplate Adapter Can be used with 3220 and 3221 deadlock Converts 1" (25 mm) to 1-1/8" (29 mm) width	NF	2.65	10
--	----	------	----



Strikes Description	Finish	2018 List	Box Qty.
3929 ASA Deadlock Strike 1-1/4" x 4-7/8" (32 mm x 124 mm), Square Corner 1-5/16" lip Optional Strike can be used with 3100/3200 Series. Order dust box separately. For use with 3200 Series US32/US32D, order US26/US26D.	US3	19.70	10
	US4	20.95	
	US10	20.95	
	US10B	19.70	
	US26	19.70	
	US26D/US32D	19.70	



3930 Strike with plastic dust box 1-1/8" x 2-3/4" (29 mm x 70 mm), Square corner	US3	8.00	10
	US4	8.45	
	US10	8.45	
	US10B	8.00	
	US26D	8.00	
	US32	8.00	
	US32D	8.00	



2-639-3109 Deadlock Dust Box For use with standard strike, 3930.	NF	3.85	10
---	----	------	----



Locks - 3200 Series



Components and Screwpacks Description

	Finish	2018 List
2-300-0018 Screwpack for 3214	US3/US10	11.15
2-300-0019 Screwpack for 3214	US4	11.15
2-300-0021 Screwpack for 3214	US10B	11.15
2-300-0022 Screwpack for 3214	US32	11.15
2-300-0023 Screwpack for 3214	US26D/US32D	11.15



2-300-0024 Screwpack for 3215	US3/US10	11.15
2-300-0025 Screwpack for 3215	US4	11.15
2-300-0027 Screwpack for 3215	US10B	11.15
2-300-0028 Screwpack for 3215	US32	11.15
2-300-0029 Screwpack for 3215	US26D/US32D	11.15





2-300-0105 Screwpack 3216/3220/3222	US3/US10	11.15
2-300-0106 Screwpack 3216/3220/3222	US4	11.15
2-300-0108 Screwpack 3216/3220/3222	US10B	11.15
2-300-0109 Screwpack 3216/3220/3222	US32	11.15
2-300-0110 Screwpack 3216/3220/3222	US26D/US32D	11.15



2-300-0111 Screwpack 3221	US3/US10	11.15
2-300-0112 Screwpack 3221	US4	11.15
2-300-0114 Screwpack 3221	US10B	11.15
2-300-0115 Screwpack 3221	US32	11.15
2-300-0116 Screwpack 3221	US26D/US32D	11.15



Components and Screwpacks		Finish	2018 List
Description			
	2-639-3218 Thumbturn Assembly - 3215	US3/US10	11.40
	2-639-3219 Thumbturn Assembly - 3215	US4	11.40
	2-639-3221 Thumbturn Assembly - 3215	US10B	11.40
	2-639-7153 Thumbturn Assembly - 3215	US26D	11.40
	2-639-3222 Thumbturn Assembly - 3215	US32	11.40
	2-639-3223 Thumbturn Assembly - 3215	US32D	11.40
	2-639-3230 Tailpiece Kit for 2" - 2-1/4" Door (3215 Fixed Cylinder Only)	US3/US10	8.60
	2-639-3231 Tailpiece Kit for 2" - 2-1/4" Door (3215 Fixed Cylinder Only)	US4	8.60
	2-639-3233 Tailpiece Kit for 2" - 2-1/4" Door (3215 Fixed Cylinder Only)	US10B	8.60
	2-639-3234 Tailpiece Kit for 2" - 2-1/4" Door (3215 Fixed Cylinder Only)	US32	8.60
	2-639-3235 Tailpiece Kit for 2" - 2-1/4" Door (3215 Fixed Cylinder Only)	US26D	8.60
	2-639-7151 Tailpiece Kit for 2" - 2-1/4" Door (3215 Fixed Cylinder Only)	US32D	8.60
	2-639-3236 Tailpiece Kit for 2" - 2-1/4" Door (3214 Fixed Cylinder Only)	US3/US4/ US10	8.60
	2-639-3238 Tailpiece Kit for 2" - 2-1/4" Door (3214 Fixed Cylinder Only)	US10B	8.60
	2-639-3239 Tailpiece Kit for 2" - 2-1/4" Door (3214 Fixed Cylinder Only)	US26D/US32/ US32D	8.60
	2-639-3703 Exterior Deadlock Scalp - 3200 Series	US3	8.50
	2-639-3704 Exterior Deadlock Scalp - 3200 Series	US4	8.50
	2-639-3705 Exterior Deadlock Scalp - 3200 Series	US10	8.50
	2-639-3706 Exterior Deadlock Scalp - 3200 Series	US10B	8.50
	2-639-7152 Exterior Deadlock Scalp - 3200 Series	US26D	8.50
	2-639-3707 Exterior Deadlock Scalp - 3200 Series	US32	8.50
	2-639-3708 Exterior Deadlock Scalp - 3200 Series	US32D	8.50



Locks - 3200 Series

Components and Screwpacks Description

Finish 2018 List



2-639-7157

3215 SFIC Deadlock Spacer

US3 6.85

2-639-7158

3215 SFIC Deadlock Spacer

US4 6.85

2-639-7154

3215 SFIC Deadlock Spacer

US10 6.85

2-639-7155

3215 SFIC Deadlock Spacer

US10B 6.85

2-639-7156

3215 SFIC Deadlock Spacer

US26D 6.85

2-639-7143

3215 SFIC Deadlock Spacer

US32 6.85

2-639-7144

3215 SFIC Deadlock Spacer

US32D 6.85

2-639-7164

SFIC Deadlock Cylinder Assembly - 3215

US3 20.00

2-639-7167

SFIC Deadlock Cylinder Assembly - 3215

US4 20.00

2-639-7160

SFIC Deadlock Cylinder Assembly - 3215

US10 20.00

2-639-7161

SFIC Deadlock Cylinder Assembly - 3215

US10B 20.00

2-639-7163

SFIC Deadlock Cylinder Assembly - 3215

US26D 20.00

2-639-7165

SFIC Deadlock Cylinder Assembly - 3215

US32 20.00

2-639-7166

SFIC Deadlock Cylinder Assembly - 3215

US32D 20.00

2-639-7641

3216 Emergency Key (10Pk)

NF 8.70



Description

3300 Series

Grade 3 Tubular - Residential
 Fixed Cylinder, Standard
 5 Pin Keyed Different Cylinder only - no keying services available
 Schlage C Keyway only
 2-3/8" - 2-3/4" (60mm - 70mm) adjustable backset
 2-1/4" - 1" (57mm x 25mm) RC Faceplate (Square corner faceplate loose in the box)

Refer to catalog or website for more detailed information on functions.

Finishes other than US10B, US15 and US26D will be subject to extended lead times. Consult customer service for availability.

When ordering handed lever designs, LH=LHR and RH=RHR.

1-3/4" x 2-1/4" Full lip round corner strike, no box (standard)

Optional strikes must be purchased separately.



Archer



August



Johnston



Withnell

Function	Finish	2018 List	Case Qty.
3310	US3	\$46.50	18
Passage	US10B	\$54.00	18
	US15	\$46.50	18
	US26	\$49.00	18
	US26D	\$49.00	18
3317	US3	\$22.25	27
Single Dummy (Specify Handing for Johnston lever)	US10B	\$26.00	27
	US15	\$22.25	27
	US26	\$24.00	27
	US26D	\$24.00	27

Function	Finish	2018 List	Case Qty.
3340	US3	\$49.00	18
Privacy	US10B	\$56.50	18
	US15	\$49.00	18
	US26	\$51.50	18
	US26D	\$51.50	18
3353	US3	\$57.50	18
Entry	US10B	\$65.00	18
	US15	\$57.50	18
	US26	\$60.00	18
	US26D	\$60.00	18

Strikes

Description	Finish	2018 List
2-639-7790 Full Lip Strike 1-3/4" x 2-1/4" (45mm x 57mm), square corner	US3	\$2.10
2-639-7792 Full Lip Strike	US10B	\$2.10
2-639-7793 Full Lip Strike	US15/US26/US26D	\$2.10
2-639-7795 T-Strike 1-1/8" x 2-3/4" (29mm x 70mm), square corner	US3	\$2.10
2-639-7797 T-Strike	US10B	\$2.10
2-639-7798 T-Strike	US15/US26/US26D	\$2.10



Locks - 3400 Series

Description

3400 Series

Grade 1 Cylindrical
 Fixed Cylinder, Standard
 6 Pin Cylinders, 5-pin Keyed
 Schlage C Keyway - KD Standard
 2-3/4" (70 mm) Backset
 2-1/4" x 1-1/8" SC Faceplate (57 mm x 29 mm)
 ASA Strike

Small and Large Format Interchangeable Core option available (cores sold separately - refer to Keying/Core section).

If construction core is included with the lockset, \$51.20 (SFIC) or \$64.75 (LFIC) will be added to the list price of the lock. Refer to keying/cores section for construction core options.

Apollo knob with SFIC will be subject to extended lead times - consult factory for availability.

Extended Lip ASA strike available. Add \$12.00 to list price of the lock.

Lead Lined available. Add \$137.00 to the list price of the lock.

Tactile Warning available on levers only. Add \$42.00 to the list

price of lock.

Anti-microbial available on 26D finish only. Add \$40.00 to the list price of the lock.

3/4" latchbolt available. Add \$103.00 to the list price of lock.

Split finish available. Priced at higher finish.

Optional backsets, faceplates, and strikes available (see next page).

Security Torx screws available. Add \$14.00 to list price of the lock.

Optional keying/keyways available.

*3473 Corridor and 3495 Intruder Classroom functions are not available on Apollo knob.

3495 Intruder Classroom includes locking indicator rose.

Refer to catalog or website for more detailed information on functions.

LFIC is not available with knobsets.



Apollo



Archer



August



Withnell



Function	Finish	Lever 2018 List	Case Qty.	Knob 2018 List	Case Qty.
3410 (F75) Passage	US3	283.30	6	252.50	10
	US4	283.30			
	US10	283.30			
	US10B	283.30			
	US26	283.30			
	US26D	272.40			
	US32D				252.50
3417 Single Dummy	US3	133.25	12	122.00	10
	US4	133.25			
	US10	133.25			
	US10B	133.25			
	US26	133.25			
	US26D	128.10			
	US32D				122.00
3440 (F76A) Privacy	US3	326.25	6	288.35	10
	US4	326.25			
	US10	326.25			
	US10B	326.25			
	US26	326.25			
	US26D	313.70			
	US32D				288.35





Description

3400 Series (Continued)
Continued

Function	Finish	Lever 2018 List	Case Qty.	Knob 2018 List	Case Qty.
3450 (F82A) Office	US3	379.95	6	339.20	10
	US4	379.95			
3453 (F109) Entry	US10	379.95			
	US10B	379.95			
3470 (F84) Classroom	US26	379.95			
	US26D	365.35			
3473 (F90) Corridor*/Dormitory	US32D			339.20	
3480 (F86) Storeroom					
3495 (F110) Intruder Classroom*	US3	463.00	6		
	US4	463.00			
	US10	463.00			
	US10B	463.00			
	US26	463.00			
	US26	463.00			
	US26D	445.20			



Locks - 3400 Series



3400 Series Electrified Cylindrical Lockset Description	Add electrified charges to the list price of the lock Function	2018 List
Outside lever continuously locked (EL) or unlocked (EU) by 12 or 24V. Latchbolt retracted by key outside or lever inside. Auxiliary latch deadlocks latchbolt when door is closed. Inside always free for immediate egress.	3480 ELEU 12V/24V Storeroom - Fail Safe/Fail Secure	210.00
Monitors inside lever rotation. Incorporates into fire alarm systems or in conjunction with an electromagnet.	RX Request to Exit	179.00

QUICK CONNECT OPTION: Locks will come with molex connector attached. Quick connect option allows rapid installation of locks when used with the Hager Quick Connect harness cable. See Commercial Hinges section (page 7) for available harness sizes.

QUICK CONNECT ORDERING EXAMPLE: 3480 US26D WTN ELEUQC

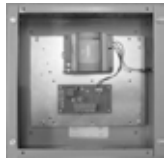

Power Supplies Description	Add electrified charges to the list price of the lock Function	2018 List
Provides power for Fail Safe or Fail Secure locking devices and interface with building alarm controls, card readers, keypads, and other door controls.	2903 24 Volt Power Supply	Reference Electrified products section
Provides power and control for openings with an electrified locking device and automatic door operator.	2904 24 Volt Power Supply	Reference Electrified products section
Provides up to 1 amp of 12 or 24 Volt DC Power for all Hager Electrified Products.	2908 24 Volt Power Supply	Reference Electrified products section
Provides up to 2 amps of 12 or 24 Volt DC Power for all Hager Electrified Products.	2909 24 Volt Power Supply	Reference Electrified products section



Latchbolts Description	Finish	2018 List	Box Qty.
3943 Spring Latch - Passage Only (3410) - Standard 2-3/4" (70 mm) Backset 2-1/4" x 1-1/8" (57 mm x 29 mm) Faceplate *Must specify square or round corner.	US3	29.40	10
	US4	31.30	
	US10	31.30	
	US10B	29.40	
	US26	29.40	
	US26D	29.40	
3945 Spring Latch - Passage Only (3410) 2-3/8" (60 mm) Backset 2-1/4" x 1-1/8" (57 mm x 29 mm) Faceplate *Must specify square or round corner.	US3	29.40	10
	US4	31.30	
	US10	31.30	
	US10B	29.40	
	US26	29.40	
	US26D	29.40	
3964 Spring Latch - Privacy Only (3440) 2-3/4" (70 mm) Backset 2-1/4" x 1-1/8" (57 mm x 29 mm) Faceplate *Must specify square or round corner.	US3	29.40	10
	US4	31.30	
	US10	31.30	
	US10B	29.40	
	US26	29.40	
	US26D	29.40	



Locks - 3400 Series



Strikes		Finish	2018 List	Box Qty.
Description				
3933	T-Strike with Plastic Dust Box	US3	8.10	10
	1-1/8" x 2-3/4" (29 x 70 mm), square corner	US4	8.50	
	For use with US32D knobs, order US26D.	US10	8.50	
		US10B	8.10	
		US26	8.10	
		US26D	8.10	
3934	Full Lip Strike	US3	8.10	10
	1-5/8" x 2-1/4" (41 mm x 57 mm), square corner	US4	8.50	
	For use with US32D knobs, order US26D.	US10	8.50	
		US10B	8.10	
		US26	8.10	
		US26D	8.10	
3935	ASA Strike	US3	12.25	10
	Shipped standard with 3400 Series	US4	13.00	
	1-1/4" x 4-7/8" (32 mm x 124 mm), square corner	US5	12.25	
	1-5/16" lip	US10	12.25	
	Order dust box separately	US15	12.25	
		US10B	13.00	
		US26	12.25	
		US26D	12.25	
		US32D	12.25	
3958	Round Corner Full Lip Strike	US3	8.10	10
	1-5/8" x 2-1/4" (41 mm x 57 mm), round corner	US4	8.50	
	(1/4" radius)	US10	8.50	
	For use with US32D knobs, order US26D	US10B	8.10	
		US26	8.10	
		US26D	8.10	
2-669-0389	ASA Metal Dust Box	NF	5.70	10
Components and Screwpacks		Finish	2018 List	
Description				
2-639-3490	Cylinder Aligning Sleeve (10 pack)	NF	2.80	





Components and Screwpacks		Finish	2018 List
Description			
2-300-0036 Screwpack - 3400 Series Lever Lockset		US3/US4/ US10	12.15
2-300-0039 Screwpack - 3400 Series Lever Lockset		US10B	12.15
2-300-0041 Screwpack - 3400 Series Lever Lockset		US26/US26D	12.15
2-300-0043 Screwpack - 3400 Series Lever Lockset		US3	12.15
2-300-0044 Screwpack - 3400 Series Lever Lockset		US32D	12.15
2-300-0042 Screwpack - 3417 Dummy Lever Only		NF	5.15
2-300-0045 Screwpack - 3417 Dummy Knob Only		NF	5.15
3911 3400 Series Leverset Thru-Post Drill Jig		NF	18.75 ea



Locks - 34K Series

Description

34K Series

Grade 1 Cylindrical Standalone
 Fixed Cylinder, Standard
 6 Pin Cylinders, 5-pin keyed Standard
 Schlage C Keyway – KD Standard
 2-3/4" (70mm) Backset
 2-1/4" x 1-1/8" SC Faceplate (57mm x 29mm)
 ASA Strike Standard

Small Format Interchangeable Core option available (Core sold separately – refer to Keying/Core section).

If construction SFIC core is included with the lockset, \$51.20 will

be added to list price of the lock. Refer to keying/cores section for construction core options.

Extended Lip ASA strike available. Add \$12.00 to list price of the lock.

Tactile Warning available. Add \$42.00 to the list price of lock.

3/4" latchbolt available. Add \$103.00 to the list price of lock.

Optional faceplates and strikes available

Optional keying/keyways available.



Function	Finish	2018 List	Case Qty.
34K1	US10B	1082.00	2
Keypad - Entry/ Storeroom	US26D	1043.00	

Function	Finish	2018 List	Case Qty.
34K2	US10B	1550.00	2
Keypad + Prox - Entry/ Storeroom	US26D	1494.00	

34K SERIES LOCKS HOW TO ORDER

34K1 2-3/4" US26D WTN SCC KD ASA 6P KEY

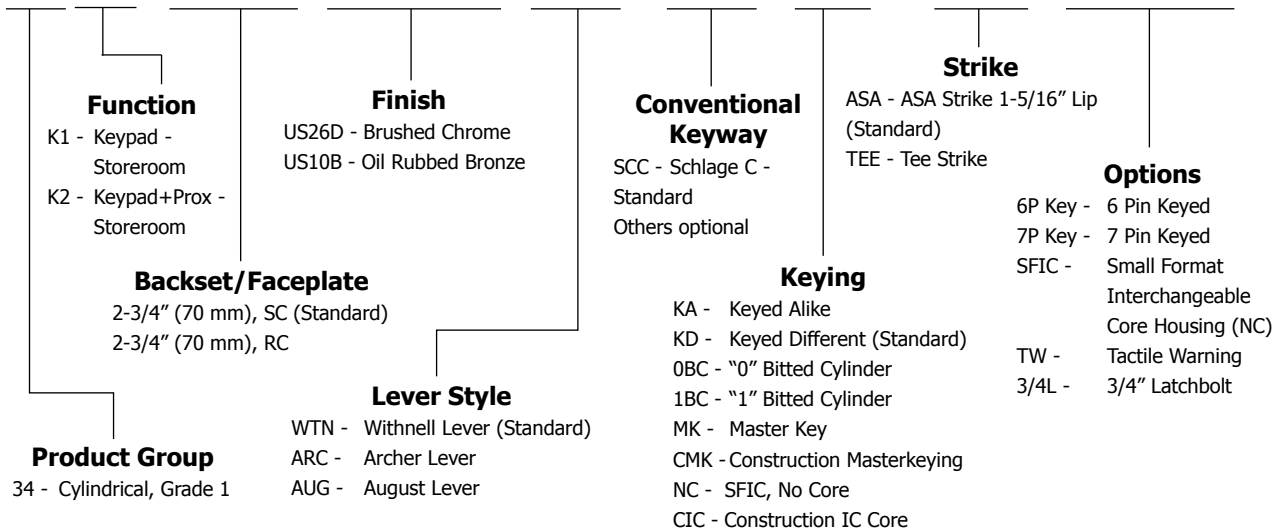

Audit Trail Accessories			
Description	Finish	2018 List	
2-639-6000 34K1 Software Kit – Includes Disc, USB Cable and Programming manual	n/a	130.00	
2-639-6001 34K2 Software Kit – Includes Disc, Prox card reader/enroller, USB Cable and Programming manual	n/a	460.00	
Latchbolts			
Description	Finish	2018 List	Box Qty.
3944 Dead Latch 2-3/4" (70 mm) Backset 2-1/4" x 1-1/8" (57 mm x 29 mm) Faceplate *Must specify square or round corner.	US10B US26D	29.40 29.40	10
3932 3/4" Dead Latch 2-3/4" (70 mm) Backset 2-1/4" x 1-1/8" (57 mm x 29 mm) square corner faceplate	US10B US26D	102.90 102.90	10
Strikes			
Description	Finish	2018 List	Box Qty.
3933 T-Strike with Plastic Dust Box 1-1/8" x 2-3/4" (29 mm x 70 mm), square corner	US10B US26D	8.10 8.10	10
3935 ASA Strike Plate Shipped standard 1-1/4" x 4-7/8" (32 mm x 124 mm), square corner 1-5/16" lip Order dust box separately:	US10B US26D	13.00 13.00	10
2-669-0389 ASA Metal Dust Box	NF	5.70	10
Components and Screwpacks			
Description	Finish	2018 List	
2-300-0300 Screwpack - 34K Series Lockset	US10B	13.25	
2-300-0301 Screwpack - 34K Series Lockset	US26D	13.25	
2-300-0302 Screwpack - 34K Battery Cover (10 pack)	NF	10.50	
2-639-3490 Cylinder Aligning Sleeve (10 pack)	NF	2.80	
2-639-7714 Thru-bolt Posts (2 pack)	NF	4.00	



Locks - 3500 Series

Description

3500 Series

Grade 2 Cylindrical
 Fixed Cylinder, Standard
 6 Pin Cylinders, 5-pin Keyed
 Schlage C Keyway - KD Standard
 2-3/4" (70 mm) Backset
 2-1/4" x 1-1/8" (57 mm x 29 mm) SC Faceplate
 ASA Strike

Small Format Interchangeable Core option available (cores sold separately - refer to Keying/Core section).

If construction SFIC core is included with the lockset, \$51.20 will be added to list price of the lock. Refer to keying/cores section for construction core options.

Extended Lip ASA strike available. Add \$10.00 to list price of the lock.

Lead Lined available. Add \$137.00 to the list price of the lock.

Tactile Warning available (Levers only). Add \$42.00 to the list price of the lock.

Anti-microbial available on 26D finish only. Add \$40.00 to list price of lock.

3/4" latchbolt available. Add \$103.00 to the list price of the lock.

Split finish available. Priced at higher finish.

Optional backsets, faceplates and strikes available (see next page).

Security Torx screws available. Add \$12.00 to list price of the lock.

Optional keying/keyways available.

Apollo knob with SFIC will be subject to extended lead times, consult factory for availability.

*3525 Exit, 3527 BTB Dummy, and 3573 Corridor functions are not available on Apollo knob.

Refer to catalog or website for more detailed information on functions.



Apollo



Archer



August



Withnell



Function	Finish	Lever 2018 List	Case Qty.	Knob 2018 List	Case Qty.
3510 (F75) Passage	US3	171.15	6	57.65	20
	US4	171.15			
	US10	171.15			
	US10B	171.15			
	US26	171.15			
	US26D	159.25			
	US32D			57.65	20
3517 Single Dummy	US3	67.75	12	33.00	60
	US4	67.75			
	US10	67.75			
	US10B	67.75			
	US26	67.75			
	US26D	63.00			
	US32D			33.00	60
3525 (F111) Exit*	US3	171.15	6		
	US4	171.15			
	US10	171.15			
	US10B	171.15			
	US26	171.15			
	US26D	159.25			
3527 BTB Dummy*	US3	135.45	6		
	US4	135.45			
	US10	135.45			
	US10B	135.45			
	US26	135.45			
	US26D	126.00			

Description

3500 Series (Continued)

Continued

	Function	Finish	Lever 2018 List	Case Qty.	Knob 2018 List	Case Qty.
3540 (F76A) Privacy		US3	194.40	6	60.80	20
		US4	194.40			
		US10	194.40			
		US10B	194.40			
		US26	194.40			
		US26D	180.85			
		US32D			60.80	20
3550 (F82A) Office		US3	215.70	6	87.85	20
		US4	215.70			
3553 (F109) Entry		US10	215.70			
		US10B	215.70			
3570 (F84) Classroom		US26	215.70			
		US26D	200.65			
3573 (F90) Corridor*/Dormitory		US32D			87.85	20
3579 (F113) Keyed Communicating						
3580 (F86) Storeroom						



Locks - 3500 Series



Latchbolts	Finish	2018 List	Box Qty.
Description			
3947	US3	28.00	10
Spring Latch - Passage only (3510) - Standard	US4	29.80	
2-3/4" (70 mm) Backset	US10	29.80	
2-1/4" x 1-1/8" (57 mm x 29 mm) Faceplate	US10B	28.00	
Must specify square or round corner.	US26	28.00	
	US26D	28.00	
	US32D	28.00	
3949	US3	28.00	10
Spring Latch - Passage only (3510)	US4	29.80	
2-3/8" (60 mm) Backset	US10	29.80	
2-1/4" x 1" (57 mm x 25 mm) Faceplate	US10B	28.00	
Must specify square or round corner.	US26	28.00	
	US26D	28.00	
	US32D	28.00	
3965	US3	28.00	10
Spring Latch - Privacy only (3540) - Standard	US4	29.80	
2-3/4" (70 mm) Backset	US10	29.80	
2-1/4" x 1-1/8" (57 mm x 29 mm) Faceplate	US10B	28.00	
Must specify square or round corner.	US26	28.00	
	US26D	28.00	
	US32D	28.00	
3967	US3	28.00	10
Spring Latch - Privacy only (3540)	US4	29.80	
2-3/8" (60 mm) Backset	US10	29.80	
2-1/4" x 1" (57 mm x 25 mm) Faceplate	US10B	28.00	
Must specify square or round corner.	US26	28.00	
	US26D	28.00	
	US32D	28.00	
3948	US3	28.00	10
Dead Latch - 3525 and all keyed functions except Corridor	US4	29.80	
2-3/4" (70 mm) Backset	US10	29.80	
2-1/4" x 1-1/8" (57 mm x 29 mm) Faceplate	US10B	28.00	
Must specify square or round corner.	US26	28.00	
	US26D	28.00	
	US32D	28.00	
3950	US3	28.00	10
Dead Latch - 3525 and all keyed functions except Corridor	US4	29.80	
2-3/8" (60 mm) Backset	US10	29.80	
2-1/4" x 1" (57 mm x 25 mm) Faceplate	US10B	28.00	
Must specify square or round corner.	US26	28.00	
	US26D	28.00	
	US32D	28.00	
3994	US3	28.00	10
Dead Latch - Corridor (3573)	US4	29.80	
2-3/8" (60 mm) Backset	US10	29.80	
2-1/4" x 1" (57 mm x 25 mm) Faceplate	US10B	28.00	
Must specify square or round corner.	US26	28.00	
	US26D	28.00	
	US32D	28.00	



Latchbolts Description	Finish	2018 List	Box Qty.
3995 Dead Latch - Corridor (3573) 2-3/4" (70 mm) Backset 2-1/4" x 1-1/8" (57 mm x 29 mm) Faceplate Must specify square or round corner.	US3 US4 US10 US10B US26 US26D US32D	28.00 29.80 29.80 28.00 28.00 28.00 28.00	10
3959 Faceplate Adapter Can be used with 3500 2-3/8" backset latchbolt. Converts to 1" (25 mm) to 1-1/8" (29 mm) width.	NF	2.65	10
3932 3/4" Dead Latch (3550, 3553, 3570, 3580) 2-3/4" (70 mm) Backset 2-1/4" x 1-1/8" (57 mm x 29 mm) square corner faceplate	US3 US4 US10 US10B US26 US26D	102.90 102.90 102.90 102.90 102.90 102.90	10
3917 3-3/4" (95 mm) Backset extension link Must be used with 2-3/8" backset latchbolt to achieve 3-3/4" total backset.	NF	18.50	10
3937 5" (127 mm) Backset extension link Must be used with 2-3/4" backset latchbolt to achieve 5" total backset.	NF	20.00	10



Locks - 3500 Series



Drive-in Latchbolts	Finish	2018 List	Box Qty.
Description			
3922 2-3/4" (70 mm) Drive-In Spring Latch - Passage only (3510)	NF	28.00	20
3923 2-3/4" (70 mm) Drive-In Spring Latch - Privacy only (3540)	NF	28.00	20
3925 2-3/8" (60 mm) Drive-In Spring Latch - Passage only (3510)	NF	28.00	20
3926 2-3/8" (60 mm) Drive-In Spring Latch - Privacy only (3540)	NF	28.00	20
3924 2-3/4" (70 mm) Drive-In Dead Latch - All keyed functions except corridor	NF	28.00	20
3927 2-3/8" (60 mm) Drive-In Dead Latch - All keyed functions except corridor	NF	28.00	20
3996 2-3/8" (60 mm) Drive-In Dead Latch - Corridor (3573)	NF	28.00	20
3997 2-3/4" (70 mm) Drive-In Dead Latch - Corridor (3573)	NF	28.00	20



Strikes	Finish	2018 List	Box Qty.
Description			
3933 T-Strike with Plastic Dust Box 1-1/8" x 2-3/4" (29 mm x 70 mm), square corner For use with US32D knobs, order US26D.	US3 US4 US10 US10B US26 US26D US32D	8.10 8.50 8.50 8.10 8.10 8.10 8.10	10
3934 Full Lip Strike 1-5/8" x 2-1/4" (41 mm x 57 mm), square corner For use with US32D knobs, order US26D.	US3 US4 US10 US10B US26 US26D US32D	8.10 8.50 8.50 8.10 8.10 8.10 8.10	10
3935 ASA Strike Shipped Standard with 3500 Series 1-1/4" x 4-7/8" (32 mm x 124 mm), square corner 1-5/16" lip Order dust box separately.	US3 US4 US5 US10 US15 US10B US26 US26D US32D	12.25 13.00 12.25 12.25 12.25 13.00 12.25 12.25 12.25	10
3958 Round Corner Full Lip Strike 1-5/8" x 2-1/4" (41 mm x 57 mm), round corner (1/4" radius) For use with US32D knobs, order US26D.	US3 US4 US10 US10B US26 US26D US32D	8.10 8.50 8.50 8.10 8.10 8.10 8.10	10



Strikes Description	Finish	2018 List	Box Qty.
2-669-0389 ASA Metal Dust Box	NF	5.70	10

Components and Screwpacks Description	Finish	2018 List	
2-300-0048 Screwpack - 3500 Series Lever Locksets	US3/US4/ US10	12.15	
2-300-0050 Screwpack - 3500 Series Lever Locksets	US10B	12.15	
2-300-0052 Screwpack - 3500 Series Lever Locksets	US26/US26D	12.15	
2-300-0059 Screwpack - 3500 Series Knob Locksets	US3	12.15	
2-300-0060 Screwpack - 3500 Series Knob Locksets	US32D	12.15	
2-300-0058 Screwpack - 3517/3527 Lever Locksets only	NF	12.15	
2-300-0045 Screwpack - 3517 Knob Lockset only	NF	5.15	
2-639-3523 3500 Series thru bolt posts	NF	4.20	
2-639-3577 Cylinder Aligning Sleeve (10 pack)	NF	3.05	
3912 3500 Series Leverset Thru-Post Drill Jig	NF	18.75	ea



Locks - 3600 Series



Archer  



August  



Withnell  

Description

3600 Series

Grade 2 Tubular Locks
 Fixed Cylinder, Standard
 6 Pin Cylinders, 5-Pin Keyed
 Schlage C Keyway - KD Standard
 2-3/8" - 2-3/4" (60 mm - 70 mm) adjustable backset
 2-1/4" x 1" (57 mm x 25 mm) SC Faceplate
 ASA Strike
 Levers only

Small Format Interchangeable Core option available (cores sold separately - refer to Keying/Core section).

If construction SFIC core is included with the lockset, \$51.20 will be added to the list price of the lock. Refer to keying/cores section for construction core options.

Extended Lip ASA strike available. Add \$10.00 to list price of the lock.

Split finish available, priced at higher finish.

Optional backsets, faceplates and strikes available (see next page).

Optional keying/keyways available.

Refer to catalog or website for more detailed information on functions.

Function	Finish	2018 List	Case Qty.
3610 (F75) Passage	US3	117.60	12
	US4	117.60	
	US10	117.60	
	US10B	117.60	
	US26	117.60	
	US26D	109.40	
3617 Single Dummy	US3	58.40	20
	US4	58.40	
	US10	58.40	
	US10B	58.40	
	US26	58.40	
	US26D	54.30	

Function	Finish	2018 List	Case Qty.
3640 (F76B) Privacy	US3	125.80	12
	US4	125.80	
	US10	125.80	
	US10B	125.80	
	US26	125.80	
	US26D	117.00	
3653 (F82A) Entry/Office	US3	159.80	12
	US4	159.80	
3670 (F84) Classroom	US10	159.80	
	US10B	159.80	
3680 (F86) Storeroom	US26	159.80	
	US26D	148.70	



Latchbolts		Finish	2018 List	Box Qty.
Description				
3951	Spring Latch - Non-keyed Functions (3600) - Standard 2-3/8" - 2-3/4" (60 mm - 70 mm) adjustable backset 2-1/4" x 1" (57 mm x 25 mm) square corner faceplate	US3 US4 US10 US10B US26 US26D	23.50 25.00 25.00 23.50 23.50 23.50	10
3952	Dead Latch - All keyed functions (3600) - Standard 2-3/8" - 2-3/4" (60 mm - 70 mm) adjustable backset 2-1/4" x 1" (57 mm x 25 mm) square corner faceplate	US3 US4 US10 US10B US26 US26D	23.50 25.00 25.00 23.50 23.50 23.50	10
3953	Spring Latch - Non-keyed Functions (3600) 2-3/8" - 2-3/4" (60 mm - 70 mm) adjustable backset 2-1/4" x 1" (57 mm x 25 mm) round corner faceplate	US3 US4 US10 US10B US26 US26D	23.50 25.00 25.00 23.50 23.50 23.50	10
3954	Dead Latch - All keyed functions (3600) 2-3/8" - 2-3/4" (60 mm - 70 mm) adjustable backset 2-1/4" x 1" (57 mm x 25 mm) round corner faceplate	US3 US4 US10 US10B US26 US26D	23.50 25.00 25.00 23.50 23.50 23.50	10
3938	Dead Latch - All keyed functions (3600) 5" (127 mm) Backset 2-1/4" x 1" (57 mm x 25 mm) Faceplate Must specify square or round corner.	US3 US4 US10 US10B US26 US26D	25.00 26.30 26.30 25.00 25.00 25.00	10
3939	Spring Latch - Non-keyed functions (3600) 5" (127 mm) Backset 2-1/4" x 1" (57 mm x 25 mm) Faceplate Must specify square or round corner.	US3 US4 US10 US10B US26 US26D	25.00 26.30 26.30 25.00 25.00 25.00	10
Drive-in Latchbolts		Finish	2018 List	Box Qty.
Description				
3914	2-3/8" - 2-3/4" (60 mm - 70 mm) Adjustable Drive-In Spring Latch - All non-keyed functions	NF	23.50	20
3915	2-3/8" - 2-3/4" (60 mm - 70 mm) Adjustable Drive-In Dead Latch - All keyed functions	NF	23.50	20



Locks - 3600 Series

Strikes Description	Finish	2018 List	Box Qty.
3933 T-Strike with Plastic Dust Box 1-1/8" x 2-3/4" (29 mm x 70 mm), square corner	US3	8.10	10
	US4	8.50	
	US10	8.50	
	US10B	8.10	
	US26	8.10	
	US26D	8.10	
3934 Full Lip Strike 1-5/8" x 2-1/4" (41 mm x 57 mm), square corner	US3	8.10	10
	US4	8.50	
	US10	8.50	
	US10B	8.10	
	US26	8.10	
	US26D	8.10	
3935 ASA Strike Shipped standard w/ 3600 Series 1-1/4" x 4-7/8" (32 mm x 124 mm), square corner 1-5/16" lip Order dust box separately	US3	12.25	10
	US4	13.00	
	US5	12.25	
	US10	12.25	
	US15	12.25	
	US10B	13.00	
	US26	12.25	
	US26D	12.25	
3958 Round Corner Full Lip Strike 1-5/8" x 2-1/4" (41 mm x 57 mm) round corner (1/4" radius)	US3	8.10	10
	US4	8.50	
	US10	8.50	
	US10B	8.10	
	US26	8.10	
	US26D	8.10	
2-669-0389 ASA Metal Dust Box	NF	5.70	10
3959 Faceplate Adapter 3600 Series Standard Converts 1" (25 mm) to 1-1/8" (29 mm) width	NF	2.65	10
Components and Screwpacks			
Description	Finish	2018 List	
2-300-0064 Screwpack - 3600 Series Lever Locksets	US3/US4	11.05	
2-300-0066 Screwpack - 3600 Series Lever Locksets	US10B	11.05	
2-300-0068 Screwpack - 3600 Series Lever Locksets	US26/US26D	11.05	
2-300-0074 Screwpack - 3617 Lever Locksets only	NF	11.05	
2-639-7159 Cylinder Aligning Sleeve (10 pack)	NF	2.80	





Description

3700 Series
 Grade 2 Interconnected
 Fixed Cylinder, Standard
 6 Pin Cylinders, 5-Pin Keyed
 Schlage C Keyway - KD Standard
 2-3/4" (70 mm) Backset
 2-1/4" x 1-1/8" (57 mm x 29 mm) SC Faceplate
 T-Strike
 Levers only
 Small Format Interchangeable Core option available (cores sold separately - refer to Keying/Core section).

If construction SFIC core is included with the lockset, \$51.20 will be added to list price of the lock. Refer to keying/cores section for construction core options.



Split finish available, priced at higher finish.

Optional backsets, faceplates and strikes available (see next page).

Optional keying / keyways available.

Refer to catalog or website for more detailed information on functions.



Archer  

Function	Finish	2018 List	Case Qty.
3710 (F95) Entry Single Locking	US3	318.40	6
	US4	318.40	
	US10	318.40	
	US10B	318.40	
	US26	318.40	
	US26D	309.10	

Function	Finish	2018 List	Case Qty.
3796 Privacy Single Locking w/ Indicator	US3	354.85	6
	US4	354.85	
	US10	354.85	
	US10B	354.85	
	US26	354.85	
	US26D	344.50	



August  

3753 (F97) Entry Double Locking	US3	350.45	6
	US4	350.45	
	US10	350.45	
	US10B	350.45	
	US26	350.45	
	US26D	340.25	



Withnell  



Locks - 3700 Series



Latchbolts Description	Finish	2018 List	Box Qty.
3920	US3	28.00	10
2-3/4" (70 mm) Backset - Standard	US4	29.80	
2-1/4" x 1-1/8" (57 mm x 29 mm) Faceplate	US10	29.80	
Must specify square or round corner.	US10B	28.00	
	US26	28.00	
	US26D	28.00	

3921	US3	28.00	10
2-3/8" (60 mm) Backset	US4	29.80	
2-1/4" x 1" (57 mm x 25 mm) Faceplate	US10	29.80	
Must specify square or round corner.	US10B	28.00	
	US26	28.00	
	US26D	28.00	



3947	US3	28.00	10
Spring Latch - Entry Single Locking (3710) - Standard	US4	29.80	
2-3/4" (70 mm) Backset	US10	29.80	
2-1/4" x 1-1/8" (57 mm x 29 mm) Faceplate	US10B	28.00	
Must specify square or round corner.	US26	28.00	
	US26D	28.00	

3949	US3	28.00	10
Spring Latch - Entry Single Locking (3710)	US4	29.80	
2-3/8" (60 mm) Backset	US10	29.80	
2-1/4" x 1" (57 mm x 25 mm) Faceplate	US10B	28.00	
Must specify square or round corner.	US26	28.00	
	US26D	28.00	



3948	US3	28.00	10
Dead Latch - Entry Double Locking (3753) - Standard	US4	29.80	
2-3/4" (70 mm) Backset	US10	29.80	
2-1/4" x 1-1/8" (57 mm x 29 mm) Faceplate	US10B	28.00	
Must specify square or round corner.	US26	28.00	
	US26D	28.00	



3950	US3	28.00	10
Dead Latch - Entry Double Locking (3753)	US4	29.80	
2-3/8" (60 mm) Backset	US10	29.80	
2-1/4" x 1" (57 mm x 25 mm) Faceplate	US10B	28.00	
Must specify square or round corner.	US26	28.00	
	US26D	28.00	



3959	NF	2.65	10
Faceplate Adapter			
Can be used with 3700 2-3/8" backset latchbolt.			
Converts 1" (25 mm) to 1-1/8" (29 mm) width.			

Strikes Description	Finish	2018 List	Box Qty.
3930	US3	8.00	10
3700 Series Deadlock, Standard	US4	8.45	
Strike with Plastic Dust Box	US10	8.45	
1-1/8" x 2-3/4" (29 mm x 70 mm), square corner	US10B	8.00	
	US26	8.00	
	US26D	8.00	



Strikes Description	Finish	2018 List	Box Qty.
3933 T-Strike with Plastic Dust Box 3700 Series Latchbolt, Standard 1-1/8" x 2-3/4" (29 mm x 70 mm), square corner	US3	8.10	10
	US4	8.50	
	US10	8.50	
	US10B	8.10	
	US26	8.10	
	US26D	8.10	
3934 Full Lip Strike 1-5/8" x 2-1/4" (41 mm x 57 mm), square corner	US3	8.10	10
	US4	8.50	
	US10	8.50	
	US10B	8.10	
	US26	8.10	
	US26D	8.10	
3958 Round Corner Full Lip Strike 1-5/8" x 2-1/4" (41 mm x 57 mm), round corner (1/4" radius)	US3	8.10	10
	US4	8.50	
	US10	8.50	
	US10B	8.10	
	US26	8.10	
	US26D	8.10	
2-639-3109 Deadlock Dust Box, Plastic	NF	3.85	10
Components and Screwpacks			
Description	Finish	2018 List	
2-300-0138 Screwpack - 3700 Series Lever Lockset	US3/US4/ US10	11.60	
	US10B	11.60	
2-300-0140 Screwpack - 3700 Series Lever Lockset	US10B	11.60	
	US26/US26D	11.60	
2-300-0141 Screwpack - 3700 Series Lever Lockset	US26/US26D	11.60	
2-639-7641 3976 Emergency Key (10Pk)	NF	8.70	



HOW TO ORDER EXAMPLE

3853 ESC US3 US26 ARC Full6 SCC KD 0 0 0 TW

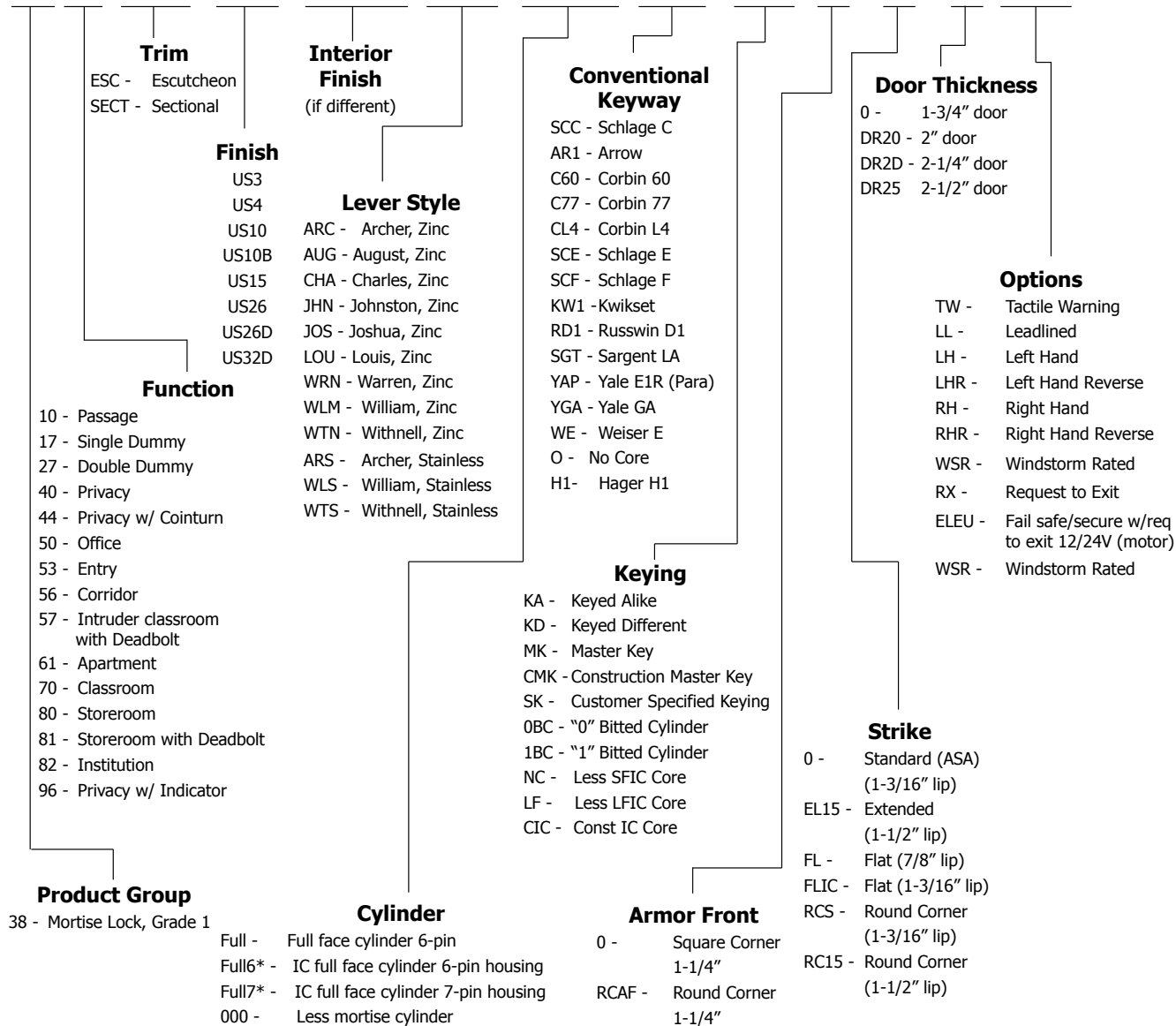

Notes:

- Finishes other than US10B, US15, US26D and US32D are subject to 90 day extended lead time.
- If master-keyed, include master key instruction sheet with order (available online).
- For additional keying information, refer to cylinder, core, and keying section of catalog.
- Quick Connect option available on 3800Series Electrified Sectional and Escutcheon models (EL, EU, RX, DPM, and LM).

Ordering example: 3880 SECT US26D WTN ELEUQC

- Door width greater than 2-1/2", or doors with offset prep are POA with 90 day extended lead time.

Please refer to our Catalog or website (www.hagerco.com) for more detailed and series specific ordering information along with additional information including functions available, additional options, and keying information.



Description

3800 Series Sectional

Grade 1 Mortise
 Fixed Cylinder, Supplied Standard
 1-1/8" Mortise Cylinder w/ Schlage L Cam - Standard
 6 Pin Cylinders, 5-pin Keyed
 Schlage C Keyway - KD Standard
 2-3/4" (70 mm) Backset
 ASA Strike, 3985

Price includes mortise cylinder(s) where applicable and standard cylinder will be shipped with lock unless specified.

If keyed functions ordered less cylinder, subtract \$48.00 for each cylinder from list price.

Small and Large Format Interchangeable Core option available (cores sold separately - refer to Keying/Core section).

If construction core is included with the lockset, \$51.20 (SFIC) or \$64.75 (LFIC) will be added to list price of the lock. Refer to keying/cores section for construction core options.

*3857, 3861, and 3882 require two cylinders.

Must specify "Full" for fixed cylinder, "ICFULL6" for SFIC 6-Pin / LFIC 6-Pin, and "ICFull7" for SFIC 7-Pin.

Options

- Lead Lined available. Add \$175.00 to the list price of lock.
- Tactile Warning available. Add \$42.00 to the list price of lock.
- For Severe Windstorm Rating, add \$40.00 to the list price of lock (3853 and 3881 only).
- Optional strikes and armor fronts available.
- Optional keying/keyways available.
- Anti-microbial available for 26D and 32D only. Add \$40.00 list price to lock.
- Extended Lip ASA strike available, add \$15.00 to list price of the lock.
- Lock Handing available, add \$12.00 to list price of the lock.
- ADA thumbturn available, add \$16 to list price of the lock.
- Security Torx screws available, add \$18 to the list price of the lock.

Finishes

Finishes other than 10B, 15, 26D and 32D will be subject to an extended lead time. Consult factory for availability.

**32D look on cast zinc lever; for a true 32D, specify stainless steel levers (Archer = ARS, William = WLS, Withnell = WTS).

Special door thicknesses are POA and will be subject to long lead time.

Handing required when ordering Johnston and Warren lever design.



Archer



August



William



Withnell



Charles



Johnston



Joshua



Louis



Warren

Function	Finish	Zinc 2018 List	Case Qty.	S.S. 2018 List	Case Qty.
3810S (F01) Passage	US3	384.45	6		6
	US4	384.45			
	US10	384.45			
	US10B	384.45			
	US15	384.45			
	US26	384.45			
	US26D	369.65			
	US32D**	369.65		480.50	
3817S Single Dummy	US3	130.75	6		6
	US4	130.75			
	US10	130.75			
	US10B	130.75			
	US15	130.75			
	US26	130.75			
	US26D	125.70			
	US32D**	125.70		163.40	
3827S Double Dummy	US3	260.60	6		6
	US4	260.60			
	US10	260.60			
	US10B	260.60			
	US15	260.60			
	US26	260.60			
	US26D	250.55			
	US32D**	250.55		325.75	



Locks - 3800 Series



Description

3800 Series Sectional (Continued)

Continued

Function	Finish	Zinc 2018 List	Case Qty.	S.S. 2018 List	Case Qty.
3840S (F02) Privacy	US3	441.60	6		6
	US4	441.60			
	US10	441.60			
	US10B	441.60			
	US15	441.60			
	US26	441.60			
	US26D	424.65			
	US32D**	424.65		552.05	
3844S (F22) Privacy w/ Cointurn	US3	480.90	6		6
	US4	480.90			
	US10	480.90			
	US10B	480.90			
	US15	480.90			
	US26	480.90			
	US26D	462.45			
	US32D**	462.45		601.20	
3850S (F04) Office	US3	493.05	6		6
	US4	493.05			
3870S (F05) Classroom	US10	493.05			
	US10B	493.05			
3880S (F07) Storeroom	US15	493.05			
	US26	493.05			
	US26D	474.10			
	US32D**	474.10		616.35	
3853S (F20) Entry	US3	510.85	6		6
	US4	510.85			
3856S (F13) Corridor	US10	510.85			
	US10B	510.85			
	US15	510.85			
	US26	510.85			
	US26D	491.20			
	US32D**	491.20		638.55	

Function	Finish	Zinc 2018 List	Case Qty.	S.S. 2018 List	Case Qty.
3857S* (F33) Intruder Classroom w/ Deadbolt	US3	548.70	6		6
	US4	548.70			
3861S* (F09) Apartment Entrance	US10	548.70			
	US10B	548.70			
3882S* (F30) Institution	US15	548.70			
	US26	548.70			
	US26D	527.60			
	US32D**	527.60		685.85	
3881S Storeroom w/ Deadbolt	US3	536.50	6		6
	US4	536.50			
	US10	536.50			
	US10B	536.50			
	US15	536.50			
	US26	536.50			
	US26D	515.85			
	US32D**	515.85		670.65	
3896S Privacy w/ Indicator	US3	501.45	6		6
	US4	501.45			
	US10	501.45			
	US10B	501.45			
	US15	501.45			
	US26	501.45			
	US26D	482.15			
	US32D**	482.15		626.85	



Description

3800 Series Escutcheon

Grade 1 Mortise
 Fixed Cylinder, Supplied Standard
 1-1/8" Mortise Cylinder w/ Schlage L Cam - Standard
 6 Pin Cylinders, 5-pin Keyed
 Schlage C Keyway - KD Standard
 2-3/4" (70 mm) Backset
 ASA Strike, 3985

Price includes mortise cylinder(s) where applicable and standard cylinder will be shipped with lock unless specified.

If keyed functions ordered less cylinder, subtract \$48.00 for each cylinder from list price.

Small and Large Format Interchangeable Core option available (cores sold separately - refer to Keying/Core section).

If included with the lockset, \$51.20 will be added to list price of the lock. Refer to keying/cores section for construction core options.

*3857, 3861, and 3882 require two cylinders.

Must specify "Full" for fixed cylinder, "ICFULL6" for SFIC 6-Pin / LFIC 6-Pin, and "ICFull7" for SFIC 7-Pin.

Options

- Lead Lined available. Add \$175.00 to the list price of lock.

- Tactile Warning available. Add \$42.00 to the list price of lock.
- For Severe Windstorm Rating, add \$40.00 to the list price of lock (3853 and 3881 only).
- Optional strikes and armor fronts available.
- Optional keying/keyways available
- Anti-microbial available for 26D and 32D finishes only. Add \$40.00 to list price of lock.
- Extended Lip ASA strike available. Add \$15.00 to list price of the lock.
- Lock Handing Available. Add \$12.00 to list price of the lock.
- Security Torx screws available, add \$18.00 to the list price of the lock.

Finishes

Finishes other than 10B, 15, 26D and 32D will be subject to an extended lead time. Consult factory for availability.

**32D look on cast zinc lever; for a true 32D, specify stainless steel levers (Archer = ARS, William = WLS, Withnell = WTS).

Special door thicknesses are POA and will be subject to long lead time.

Handing required when ordering Johnston and Warren lever design.



Archer 



August 



William 



Withnell 



Charles 



Johnston 



Joshua 



Louis 



Warren 

Function	Finish	Zinc 2018 List	Case Qty.	S.S. 2018 List	Case Qty.
3810E (F10) Passage	US3	417.10	6		6
	US4	417.10			
	US10	417.10			
	US10B	417.10			
	US15	417.10			
	US26	417.10			
	US26D	401.05			
	US32D**	401.05		521.35	
3817E Single Dummy	US3	141.85	6		6
	US4	141.85			
	US10	141.85			
	US10B	141.85			
	US15	141.85			
	US26	141.85			
	US26D	136.40			
	US32D**	136.40		177.35	
3827E Double Dummy	US3	282.70	6		6
	US4	282.70			
	US10	282.70			
	US10B	282.70			
	US15	282.70			
	US26	282.70			
	US26D	271.85			
	US32D**	271.85		353.40	



Locks - 3800 Series



Description

3800 Series Escutcheon (Continued)

Continued

Function	Finish	Zinc 2018 List	Case Qty.	S.S. 2018 List	Case Qty.
3840E (F02) Privacy	US3	479.15	6		6
	US4	479.15			
	US10	479.15			
	US10B	479.15			
	US15	479.15			
	US26	479.15			
	US26D	460.75			
	US32D**	460.75		598.95	
3844E (F22) Privacy w/ Cointurn	US3	521.85	6		6
	US4	521.85			
	US10	521.85			
	US10B	521.85			
	US15	521.85			
	US26	521.85			
	US26D	501.75			
	US32D**	501.75		652.30	
3850E (F04) Office	US3	535.00	6		6
	US4	535.00			
3870E (F05) Classroom	US10	535.00			
	US10B	535.00			
3880E (F07) Storeroom	US15	535.00			
	US26	535.00			
	US26D	514.40			
	US32D**	514.40		668.75	
3853E (F20) Entry	US3	554.25	6		6
	US4	554.25			
3856E (F13) Corridor	US10	554.25			
	US10B	554.25			
	US15	554.25			
	US26	554.25			
	US26D	532.95			
	US32D**	532.95		692.80	

Function	Finish	Zinc 2018 List	Case Qty.	S.S. 2018 List	Case Qty.
3857E* (F33) Intruder Classroom w/ Deadbolt	US3	595.30	6		6
	US4	595.30			
3861E* (F09) Apartment Entrance	US10	595.30			
	US10B	595.30			
3882E* (F30) Institution	US15	595.30			
	US26	595.30			
	US26D	572.40			
	US32D**	572.40		744.10	
3881E Storeroom w/ Deadbolt	US3	582.10	6		6
	US4	582.10			
	US10	582.10			
	US10B	582.10			
	US15	582.10			
	US26	582.10			
	US26D	559.70			
	US32D**	559.70		727.60	
3896E Privacy w/ Indicator	US3	544.10	6		6
	US4	544.10			
	US10	544.10			
	US10B	544.10			
	US15	544.10			
	US26	544.10			
	US26D	523.15			
	US32D**	523.15		680.10	



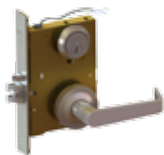

3800 Series Electrified Options - Sectional or Escutcheon Models Description	Add electrified charges to the list price of the lock Function	2018 List
Outside lever continuously locked (EL) or unlocked (EU) by 12 or 24V. Latchbolt retracted by key outside or lever inside. Auxiliary latch deadlocks latchbolt when door is closed. Inside always free for immediate egress.	3880ELEU 12V/24V Storeroom - Fail Safe/Fail Secure	370.00
Both levers continuously locked (EL) or unlocked (EU) by 12 or 24V. Latchbolt retracted by key inside or outside. Auxiliary latch deadlocks latchbolt when door is closed.	3882ELEU 12V/24V Institution - Fail Safe/Fail Secure	370.00
Monitors inside lever rotation. Incorporates into fire alarm systems or in conjunction with an electromagnet. Available on 3880 or in conjunction with 3880ELEU.	RX Request to Exit	198.00
Single switch (SPDT) mounted inside lockset monitors the full extension of the latchbolt. Available on 3880, 3882, or in conjunction with 3880ELEU or 3882ELEU.	LM Latchbolt Monitoring	198.00
Single switch (SPDT Reed Magnetic Switch) mounted inside the lock monitors whether the door is fully closed. Available on 3880, 3882, or in conjunction with 3880ELEU or 3882ELEU.	DPM Door Position Monitoring	218.00

Quick Connect Option: Locks will come with molex connector attached. Quick connect option allows rapid installation of locks when used with the Hager Quick Connect harness cable. See Commercial Hinge section (page 7) for available harness sizes.

Quick Connect Ordering Example: 3880 SECT US26D WTN ELEUQC



Power Supplies Description	Add electrified charges to the list price of the lock Function	2018 List
Provides power for locking devices and interfaces with building alarm controls, card readers, keypads, and other door controls.	2903 24 Volt Power Supply	Reference Electrified products section
Provides power and control for openings with an electrified locking device and automatic door operator.	2904 24 Volt Power Supply	Reference Electrified products section
Provides up to 1 amp of 12 or 24 Volt DC Power for all Hager Electrified Products	2908 24 Volt Power Supply	Reference Electrified products section
Provides up to 2 amp of 12 or 24 Volt DC Power for all Hager Electrified Products	2909 24 Volt Power Supply	Reference Electrified products section



Locks - 3800 Series



Description

3800 Series Deadlock

Grade 1 Mortise - Deadlock
 Fixed Cylinder, Standard
 1-1/8" Mortise Cylinder w/ Schlage `L' Cam Standard
 6 Pin Cylinders, 5-pin Keyed
 Schlage C Keyway - KD Standard
 2-3/4" (70 mm) Backset
 No Lip Strike, 3991

Price includes mortise cylinder(s) where applicable and standard cylinder will be shipped with deadlock unless specified.

If keyed deadlocks ordered less cylinder, subtract \$48.00 for each cylinder from list price.

Small and Large Format Interchangeable Core option available (cores sold separately - refer to Keying/Core section).

*3862 requires two cylinders

Must specify "Full" for fixed cylinder, "ICFULL6" for SFIC 6-Pin / LFIC 6-Pin, and "ICFull7" for SFIC 7-Pin.

Options

- Lead Lined available. Add \$175.00 to the list price of lock.
- Optional keying/keyways available.

**Hager Keyway is 7-Pin Only

Finishes other than 26D will be subject to an extended lead time. Consult factory for availability.

Refer to catalog or website for more detailed information on functions.

Function	Finish	2018 List	Case Qty.
3860S (F17) Cylinder x Thumbturn	US3	268.25	6
	US4	268.25	
	US10	268.25	
	US10B	268.25	
	US26	268.25	
	US26D	255.45	
3862S* (F16) Double Cylinder	US3	325.75	6
	US4	325.75	
	US10	325.75	
	US10B	325.75	
	US26	325.75	
	US26D	310.20	

Function	Finish	2018 List	Case Qty.
3863S (F29) Classroom (Specify Handing)	US3	325.75	6
	US4	325.75	
	US10	325.75	
	US10B	325.75	
	US26	325.75	
	US26D	310.20	
3864S (F18) Cylinder	US3	224.40	6
	US4	224.40	
	US10	224.40	
	US10B	224.40	
	US26	224.40	
	US26D	213.75	



Description

3800 Series Small Case Deadlock

Grade 1 Mortise - Deadlock
 Fixed Cylinder, Standard
 1-1/8" Mortise Cylinder w/ Schlage `L' Cam Standard
 6 Pin Cylinders, 5-pin Keyed
 Schlage C Keyway - KD Standard
 2-3/4" (70 mm) Backset
 No Lip Strike, 3999
 Price includes mortise cylinder(s) where applicable and standard cylinder will be shipped with deadlock unless specified.
 If keyed deadlocks ordered less cylinder, subtract \$48.00 for each cylinder from list price.
 Small and Large Format Interchangeable Core option available (cores sold separately - refer to Keying/Core section).

*3832 requires two cylinders
 Must specify "Full" for fixed cylinder, "ICFULL6" for SFIC 6-Pin / LFIC 6-Pin, and "ICFull7" for SFIC 7-Pin.

Options
 - Optional keying/keyways available.
 **Hager Keyway is 7-Pin Only

Finishes other than 26D will be subject to an extended lead time. Consult factory for availability.

Refer to catalog or website for more detailed information on functions.

Function	Finish	2018 List	Case Qty.
3830S (E06071) Cylinder x Thumbturn	US3	234.35	6
	US4	234.35	
	US10	234.35	
	US10B	234.35	
	US26	234.35	
	US26D	223.20	
3831S (E06181) Door Bolt Thumbturn only	US3	200.35	6
	US4	200.35	
	US10	200.35	
	US10B	200.35	
	US26	200.35	
	US26D	190.80	
3832S* (E06061) Double Cylinder	US3	284.45	6
	US4	284.45	
	US10	284.45	
	US10B	284.45	
	US26	284.45	
	US26D	270.90	

Function	Finish	2018 List	Case Qty.
3833S (E06091) Classroom (Specify Handing)	US3	284.45	6
	US4	284.45	
	US10	284.45	
	US10B	284.45	
	US26	284.45	
	US26D	270.90	
3834S (E06081) Cylinder	US3	196.00	6
	US4	196.00	
	US10	196.00	
	US10B	196.00	
	US26	196.00	
	US26D	186.70	



Locks - 3800 Series



Description

3800 Series Sliding Door Mortise Lock

Sliding Door Mortise Lock
 Fixed Cylinder, Standard
 1-1/8" Mortise Cylinder w/ Schlage `L' Cam Standard
 6 Pin Cylinders, 5-pin Keyed
 Schlage C Keyway - KD Standard
 2-3/4" (70 mm) Backset
 No Lip Strike

Price includes mortise cylinder(s) where applicable and standard cylinder will be shipped with deadlock unless specified.

If keyed deadlocks ordered less cylinder, subtract \$48.00 for each cylinder from list price.

Small and Large Format Interchangeable Core option available (cores sold separately - refer to Keying/Core section).

*3837 requires two cylinders

Must specify "Full" for fixed cylinder, "ICFULL6" for SFIC 6-Pin / LFIC 6-Pin, and "ICFull7" for SFIC 7-Pin.

Options

- Optional keying/keyways available.

**Hager Keyway is 7-Pin Only

Refer to catalog or website for more detailed information on functions.

Function	Finish	2018 List	Case Qty.
3835S Cylinder x Thumbturn	US26D	177.35	6
3836S Single Cylinder	US26D	177.35	6
3837S Double Cylinder	US26D	208.85	6

Function	Finish	2018 List	Case Qty.
3838S Thumbturn Only	US26D	157.50	6
3839S Thumbturn w/ Emergency Key (Privacy)	US26D	170.10	6

Components, Strikes, and Screwpacks		
Description	Finish	2018 List
Zinc Mortise Lock Levers (each) Consult factory for part numbers and other finishes. (May be subject to extended lead times)	US26D/US32D	56.45
Stainless Mortise Lock Levers (each) Consult factory for part numbers and other finishes. (May be subject to extended lead times)	US32D	85.35
3918 Tapered Cylinder Collar For use with sectional mortise lock, standard with 1-1/8" cylinder, 1-3/4" door. Includes wave washer and shim.	US26D US10B US15 / US32D	11.65 13.65 11.65
3928 Flat Cylinder Collar 1-3/8" diameter, 11/32" thick For use with double cylinder sectional mortise locks and other special cylinders and door thicknesses. Consult factory. Includes wave washer and shim.	US26D US10B US15 / US32D	11.65 13.65 11.65
3985 Standard Lip Strike Square corner 1-1/4" x 4-7/8" x 1-3/16" (32 mm x 124 mm x 30 mm)	US10B US32D*	18.25 17.05
3986 Extended Lip Strike Square corner 1-1/4" x 4-7/8" x 1-1/2" (32 mm x 124 mm x 38 mm)	US10B US32D*	18.25 17.05
3987 Standard Lip Strike Round corner 1-1/4" x 4-7/8" x 1-3/16" (32 mm x 124 mm x 30 mm)	US10B US32D*	18.25 17.05
3988 Extended Lip Strike Round corner 1-1/4" x 4-7/8" x 1-1/2" (32 mm x 124 mm x 38 mm)	US10B US32D*	18.25 17.05
3989 Flat Lip Strike Square corner 1-1/4" x 4-7/8" x 7/8" (32 mm x 124 mm x 22 mm)	US10B US32D*	18.25 17.05
3990 Extended Flat Lip Strike Square corner 1-1/4" x 4-7/8" x 1-3/16" (32 mm x 124 mm x 30 mm)	US10B US26D	18.25 17.05
3991 Square corner Full Case Deadlock Strike (3860, 3862, 3863, 3864) 1-1/4" x 4-7/8" (32 mm x 124 mm)	US10B US26D	18.25 17.05



Locks - 3800 Series

Components, Strikes, and Screwpacks

Description	Finish	2018 List
3999	US10B	18.25
For Small Case	US32D*	17.05
No Lip Strike		
Square corner		
1-1/8" x 3- 1/2" (29 mm x 89 mm)		
2-669-0389	NF	5.70
ASA Metal Dust Box		
2-669-0224	US10B	12.50
Armor Front 1-1/4" Square corner (Latch x Aux Latch x Deadbolt) - 3853, 3881		
2-669-0226	US32D*	12.00
Armor Front 1-1/4" Square corner (Latch x Aux Latch x Deadbolt) - 3853, 3881		
2-669-0230	US10B	12.50
Armor Front 1-1/4" Square corner (Latch x Aux Latch) - 3850, 3861, 3870, 3880, 3882		
2-669-0232	US32D*	12.00
Armor Front 1-1/4" Square corner (Latch x Aux Latch) - 3850, 3861, 3870, 3880, 3882		
2-669-0236	US10B	12.50
Armor Front 1-1/4" Square corner (Latch x Deadbolt) - 3856, 3857		
2-669-0238	US32D*	12.00
Armor Front 1-1/4" Square corner (Latch x Deadbolt) - 3856, 3857		
2-669-0242	US10B	12.50
Armor Front 1-1/4" Square corner (Latch) - 3810, 3840, 3844, 3896		
2-669-0244	US32D*	12.00
Armor Front 1-1/4" Square corner (Latch) - 3810, 3840, 3844, 3896		
2-669-0248	US10B	12.50
Armor Front 1-1/4" Square corner (Blank)		
2-669-0250	US32D*	12.00
Armor Front 1-1/4" Square corner (Blank)		
2-669-0254	US10B	12.50
Armor Front 1-1/4" Square corner (Deadbolt) - 3860, 3862, 3863, 3864		
2-669-0256	US32D*	12.00
Armor Front 1-1/4" Square corner (Deadbolt) - 3860, 3862, 3863, 3864		
2-669-0296	US10B	12.50
Armor Front 1-1/4" Round corner (Latch x Aux Latch x Deadbolt) - 3853, 3881		
2-669-0298	US32D*	12.00
Armor Front 1-1/4" Round corner (Latch x Aux Latch x Deadbolt) - 3853, 3881		
2-669-0302	US10B	12.50
Armor Front 1-1/4" Round corner (Latch x Aux Latch) - 3850, 3861, 3870, 3880, 3882		
2-669-0304	US32D*	12.00
Armor Front 1-1/4" Round corner (Latch x Aux Latch) - 3850, 3861, 3870, 3880, 3882		



Components, Strikes, and Screwpacks Description	Finish	2018 List
2-669-0308 Armor Front 1-1/4" Round corner (Latch x Deadbolt) - 3856, 3857	US10B	12.50
2-669-0310 Armor Front 1-1/4" Round corner (Latch x Deadbolt) - 3856, 3857	US32D*	12.00
2-669-0314 Armor Front 1-1/4" Round corner (Latch) - 3810, 3840, 3844, 3896	US10B	12.50
2-669-0316 Armor Front 1-1/4" Round corner (Latch) - 3810, 3840, 3844, 3896	US32D*	12.00
2-669-0320 Armor Front 1-1/4" Round corner (Blank)	US10B	12.50
2-669-0322 Armor Front 1-1/4" Round corner (Blank)	US32D*	12.00
2-669-0326 Armor Front 1-1/4" Round corner (Deadbolt) - 3860, 3862, 3863, 3864	US10B	12.50
2-669-0328 Armor Front 1-1/4" Round corner (Deadbolt) - 3860, 3862, 3863, 3864	US32D*	12.00
2-669-0408 Thumbturn (3850, 3853, 3856, 3860, 3881)	US10B	34.15
2-669-0410 Thumbturn (3850, 3853, 3856, 3860, 3881)	US26D	31.90
2-669-0411 Thumbturn (3850, 3853, 3856, 3860, 3881)	US15/US32D	31.90
*For use with US15 and US26D mortise locks, order US32D finish.		
2-669-0415 Thumbturn (3840, 3844, 3896)	US10B	34.15
2-669-0417 Thumbturn (3840, 3844, 3896)	US26D	31.90
2-669-0418 Thumbturn (3840, 3844, 3896)	US15/US32D	31.90
2-669-0422 Emergency Release (3840, 3896)	US10B	7.45
2-669-0424 Emergency Release (3840, 3896)	US26D	6.95
2-669-0425 Emergency Release (3840, 3896)	US32D	6.95
2-669-0111 Screwpack (3850S, 3853S, 3856S, 3840S, 3844S, 3896S)	US10B	27.20
2-669-0112 Screwpack (3850S, 3853S, 3856S, 3840S, 3844S, 3896S)	US32D	25.40
2-669-0115 Screwpack (3870S, 3861S, 3857S, 3865S, 3810S)	US10B	27.20



Locks - 3800 Series

Components, Strikes, and Screwpacks Description	Finish	2018 List
2-669-0116 Screwpack (3870S, 3861S, 3857S, 3865S, 3810S)	US32D	25.40
2-669-0119 Screwpack (3850E, 3853E, 3870E, 3861E, 3857E, 3856E, 3840E, 3844E, 3810E, 3896E)	US10B	27.20
2-669-0120 Screwpack (3850E, 3853E, 3870E, 3861E, 3857E, 3856E, 3840E, 3844E, 3810E, 3896E)	US32D	25.40
2-669-0123 Screwpack (3881S)	US10B	27.20
2-669-0124 Screwpack (3881S)	US32D	25.40
2-669-0127 Screwpack (3880S)	US10B	27.20
2-669-0128 Screwpack (3880S)	US32D	25.40
2-669-0131 Screwpack (3880E, 3881E)	US10B	27.20
2-669-0132 Screwpack (3880E, 3881E)	US32D	25.40
2-669-0135 Screwpack (3862S, 3863S, 3864S)	US10B	13.60
2-669-0136 Screwpack (3862S, 3863S, 3864S)	US32D	12.70
2-669-0147 Screwpack (3860S)	US10B	13.60
2-669-0148 Screwpack (3860S)	US32D	12.70
2-669-0139 Screwpack (3882S)	US10B	17.70
2-669-0140 Screwpack (3882S)	US32D	16.55
2-669-0143 Screwpack (3882E)	US10B	17.70
2-669-0144 Screwpack (3882E)	US32D	16.55
2-669-0157 Screwpack (3827S)	NF	10.20
2-669-0158 Screwpack (3827E)	NF	10.20
2-669-0167 Screwpack (3817S)	NF	7.10
2-669-0168 Screwpack (3817E)	NF	7.10
2-669-0365 Thru-Bolt Bag (2 each) 1-3/8" to 2" door	NF	8.70
2-669-0366 Thru-Bolt Bag (2 each) Over 2" to 2-1/2" door	NF	9.65



Components, Strikes, and Screwpacks		
Description	Finish	2018 List
2-669-0613 Square Spindles - 5-pk	NF	26.50
2-669-0597 Armor Front Screws - 10-pk	26D	11.10
2-669-0615 Lock Case (3853)	NF	182.00
2-669-0616 Lock Case (3881)	NF	182.00
2-669-0600 Lock Case (3856, 3857)	NF	216.00
2-669-0603 Lock Case (3850, 3870, 3861, 3876)	NF	178.75
2-669-0604 Lock Case (3880)	NF	178.75
2-669-0605 Lock Case (3810)	NF	127.85
2-669-0641 Lock Case (3840, 3844, 3896)	NF	178.75
2-669-0635 Lock Case (3853 Windstorm Rated)	NF	216.00
2-669-0636 Lock Case (3881 Windstorm Rated)	NF	216.00
2-669-0643 Lever Adapters (Keepers) for Stainless Levers	NF	6.40

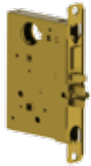

Locks - Cylinders/Keying



Fixed Cylinders/Key-in-Lever - Keying Charges		
Description	Finish	2018 List
Keyed Different (KD) 5-pin (Standard), 6-pin, 7-pin (Hager Keyway only) available		N/C
Keyed Alike (KA) 5-pin (Standard), 6-pin, 7-pin (Hager Keyway Only). 0-Bitted and 1-Bitted available*		N/C
Master Keyed (MK) - Add to list price of lock**		21.10
Construction Master Keyed (CMK) - Add to the standard master key charge and the list price of lock (Schlage C / Hager H1 only)**		14.15
Keyed to specific or existing number - Add to list price of lock		7.50
Extra Cut Keys - specify change key, MK, GMK or CMK (3961 - 5-pin, 3962 - 6-pin, 3908 - 7-pin Hager only)		6.05
Key Markings - Standard key symbols (AA1) - Visual Key Control (VKC)		No Charge
Key Markings - Non-standard code - Visual Key Control (VKC)		6.05
Custom Cylinder Markings		6.05
3998 - Bitting List (No charge if ordered with master keying) - Factory Keyed		175.00
Bitting List - Hager designed system - Keyed by others		175.00
Other keyways available (refer to Catalog or website) - Add to list price of lock		15.65

*Allow 7 working days for 0-bitted, 1-bitted, and KA orders

** Allow 20 working days for factory master key orders.

Notes:

1. Lock prices do not include keying charges.
2. Locks furnished with 6-pin cylinder, 5-pin keyed, Schlage C keyway keyed different unless otherwise specified.
3. 0 Bitted and 1 Bitted cylinders provided 6 pin only
4. Please include Master Key Instruction Sheet with order, available online or in catalog. Failure to provide will delay order.

Fixed Cylinder Key			
Description	Finish	2018 List	Box Qty.
3955 Key Blank 5-Pin C Keyway Other keyways available*	NF	1.60	50
3956 Key Blank 6-Pin C Keyway Other keyways available*	NF	2.20	50
3961 Cut 5-Pin Key 5-Pin C Keyway Other keyways available*	NF	6.35	50





Fixed Cylinder Key		Finish	2018 List	Box Qty.
3962	Cut 6-Pin Key 6-Pin C Keyway Other keyways available*	NF	6.35	50
3907	Key Blank 7-Pin H Keyways	NF	2.20	50
3908	Cut 7-Pin Key 7-Pin H Keyways	NF	6.35	50











*Refer to catalog or website for more information on available keyways.



Fixed Cylinder/Tailpieces		Finish	2018 List
3960 or 3906 (Hager Keyway Only)	Fixed Cylinder Kit - Includes two keys 3960 - C Keyway; 6-pin cylinder, 5-pin keyed - Standard 3906 - H Keyways, 7-pin cylinder - Standard Additional options and keyways available at additional cost (refer to catalog or website). Tailpiece optional when ordering (No Charge) Please include cylinder instructions and ordering guide sheet with order (available online).	US4 US26D	51.30 51.30
2-639-7000	Tailpiece 1 Pack of 10 tailpieces for use with 3453L, 3450L, 3480L, 2580L	NF	11.75
2-639-7001	Tailpiece 2 Pack of 10 tailpieces for use with 3470L.	NF	11.75
2-639-7002	Tailpiece 3 Pack of 10 tailpieces for use with 3453K, 3480K, 3550L, 3553L, 3553K, 3579L, 3580L, 3580K, 3753L, 2550L, 2553L	NF	11.75
2-639-7003	Tailpiece 4 Pack of 10 tailpieces for use with 3470K, 3570K	NF	11.75
2-639-7005	Tailpiece 6 Pack of 10 tailpieces for use with 3114 (Exterior Cyl.), 3214 (Exterior	NF	11.75



Locks - Cylinders/Keying

Fixed Cylinder/Tailpieces		Finish	2018 List	
Description				
 2-639-7006 Tailpiece 7 Pack of 10 tailpieces for use with 3114 (Interior Cyl.), 3214 (Interior)		NF	11.75	
 2-639-7007 Tailpiece 8 Pack of 10 tailpieces for use with 3115, 3118, 3215, 3710L, 3753L		NF	11.75	
 2-639-7008 Tailpiece 9 Pack of 10 tailpieces for use with 3653L, 3670L, 3680L		NF	11.75	
 2-639-7018 Tailpiece W Pack of 10 tailpieces for use with 3473L		NF	11.75	
 2-639-7192 Tailpiece K Pack of 10 tailpieces for use with 47KE, 47KN		NF	11.75	
 2-639-7087 Tailpiece Z Pack of 10 tailpieces for use with 3570L and 3573L		NF	11.75	
 2-639-7094 Tailpiece X Pack of 10 tailpieces for use with 3495L		NF	11.75	
 2-639-7322 Tailpiece V Pack of 10 tailpieces for use with 3473L		NF	11.75	
Fixed Cylinder - Rim Cylinder		Finish	2018 List	Box Qty.
Description				
 3901 Fixed Rim Cylinder 6-Pin Cylinder, 5-Pin Keyed; 7-Pin Cylinder (Hager Keyway Only) Schlage C Keyway or Hager Keyway - Keyed Different Standard Shipped with breakoff tailpiece attached. Shipped with collar, mounting plate, and breakoff screws.		US3	48.50	1
		US4	51.55	
		US10	51.55	
		US10B	48.50	
		US26	48.50	
		US26D	48.50	
 3903 Rim Dummy Cylinder Shipped with mounting plate, and breakoff screws.		US3	32.40	1
		US4	32.40	
		US10	32.40	
		US10B	32.40	
		US26	32.40	
		US26D	32.40	





Fixed Cylinder - Rim Cylinder Accessories	Finish	2018 List	Box Qty.
---	--------	-----------	----------

2-639-7058 Long breakoff tailpiece - 2-3/8" (60 mm)	NF	2.45	1
---	----	------	---

2-300-0118 Extra long breakoff screws - 2-3/8" (60 mm) (2 each)	NF	1.70	2
---	----	------	---

2-649-0137 Retaining cup Can be used with 45PN, 47PN, and 47RN	NF	8.95	1
---	----	------	---

Fixed Cylinder - Mortise Cylinder	Finish	2018 List	Box Qty.
-----------------------------------	--------	-----------	----------

3902 Fixed Cylinder Mortise Cylinder 6-Pin Cylinder, 5-Pin Keyed, 7-Pin Cylinder (Hager Keyway Only) Schlage C Keyway or Hager Keyways - Keyed Different Standard Specify 1-1/8" (29 mm), 1-1/4" (32 mm) or 1-5/8" (41 mm) Shipped with standard cam attached and Adams Rite cam loose in box; specify if different. Specify Schlage L cam when ordering cylinders for use in Hager mortise locks.	US3 US4 US10 US10B US26 US26D	48.50 51.55 51.55 48.50 48.50 48.50	1
---	--	--	---

3904 Mortise Dummy Specify 1-1/8" (29 mm) or 1-1/4" (32 mm)	US3 US4 US10 US10B US26 US26D	40.00 42.50 42.50 40.00 40.00 40.00	1
--	--	--	---

3905 Mortise ADA Turn Knob Specify 1-1/8" (29 mm) or 1-1/4" (32 mm) Shipped with Schlage L cam attached, specify if different.	US3 US10B US26D	69.95 69.95 69.95	1
--	-----------------------	-------------------------	---

Fixed Cylinder - Mortise Cylinder Cams	Finish	2018 List	Box Qty.
--	--------	-----------	----------

3971 Yale Cam .722" (18 mm)	US2C	3.70 ea.	10
--	------	----------	----

3972 Adams Rite Cam .560" (14 mm) Shipped Loose in box w/ standard 3902	US2C	3.70 ea.	10
---	------	----------	----

3973 Standard Cloverleaf .741" (19 mm)	US2C	3.70 ea.	10
---	------	----------	----

3974 Marks Cam R.755" (19 mm)	US2C	3.70 ea.	10
--	------	----------	----



Locks - Cylinders/Keying



Fixed Cylinder - Mortise Cylinder Cams			
Description	Finish	2018 List	Box Qty.
3975 Standard Cam R.723" (18 mm) Shipped standard w/ 3902	US2C	3.70 ea.	10
3976 Schlage L Cam .637" (16 mm) For use w/ all keyed function 3800 Series Mortise Locks.	US2C	3.70 ea.	10
3977 Sargent/Yale Cam .733" (18.6 mm)	US2C	3.70 ea.	10
3978 Corbin Russwin/Best Cloverleaf Cam .725" (18.5 mm)	US2C	3.70 ea.	10
Small Format Interchangeable Core - Keying Charges/Cores			
Description	Finish	2018 List	
3981-U Uncombined Core 6-Pin (includes two key blanks), specify US4 or US26D		41.90	
3982-U or 3909 (Hager SFIC Only) Uncombined Core 7-Pin (includes two key blanks), specify US4 or US26D		41.90	
3981-C Combined Core 6-Pin (includes two operating keys), specify US4, US26D. Specify KA*, KD*, MK**. Specify number of control keys needed.		51.20	
3982-C or 3969 (Hager SFIC Only) Combined Core 7-Pin (includes two operating keys), specify US4, US26D. Specify KA*, KD*, MK**. Specify number of control keys needed.		51.20	
3981-BLU or RED (Best A) Construction Core 6-Pin (includes two operating keys). Specify number of control keys. Two control keys provided as a default.		51.20	
3982-BLU or RED (Best A) Construction Core 7-Pin (includes two operating keys). Specify number of control keys. Two control keys provided as a default.		51.20	
Key Markings: Standard key symbols (AA1) - Visual Key Control (VKC)		N/C	
Key Markings: Non-standard code - Visual Key Control (VKC)		6.05	
Core Markings		6.05	
3984 Cut Keys - Control Keys, Extra change keys, or Master Keys		6.05	
3908 Cut Keys (Hager Keyway Only) - Control Keys, Extra change keys, or Master Keys		6.05	
3998 Bitting list (no charge if ordered with master key) - Factory keyed		175.00	
Bitting list - Hager designed system - Keyed by others		175.00	



Small Format Interchangeable Core - Keying Charges/Cores	Finish	2018 List
--	--------	-----------

Description

*Allow 7 working days for KD and KA orders
 ** Allow 20 working days for factory master key orders.

Notes:

1. Lock price includes keying charges.
2. Cores are supplied Best A keyed different unless otherwise specified.
3. Please include Master Key Instruction Sheet with order, available online or in catalog. Failure to provide will delay order.
4. Construction Cores - Receive full credit, less shipping, of original cost upon return of cores and keys.

Small Format Interchangeable Core - Keys	Finish	2018 List	Box Qty.
--	--------	-----------	----------



3983 Small Format Interchangeable Core Key Blanks Best Keyways Used with 6-pin and 7-pin cores	NF	2.20	50
--	----	------	----

3984 Small Format Interchangeable Core Cut Key Best Keyways Used with 6-pin and 7-pin cores	NF	6.35	50
---	----	------	----

2-639-7168 SFIC 6-pin "BLUE" Construction Control Key Best A Keyway	NF	6.35	1
--	----	------	---

2-639-7169 SFIC 7-pin "BLUE" Construction Control Key Best A Keyway	NF	6.35	1
--	----	------	---

2-639-7113 SFIC 6-pin "RED" Construction Control Key Best A Keyway	NF	6.35	1
---	----	------	---

2-639-7170 SFIC 7-pin "RED" Construction Control Key Best A Keyway	NF	6.35	1
---	----	------	---



3907 Small Format Interchangeable Core Key Blanks Hager Keyways (7-pin cores only)	NF	2.20	50
---	----	------	----



3908 Small Format Interchangeable Core Cut Key Hager Keyways (7-pin cores only)	NF	6.35	50
--	----	------	----

Small Format Interchangeable Core - Tailpieces	Finish	2018 List	Box Qty.
--	--------	-----------	----------



2-639-7060 Pack of 10 tailpieces and compression springs for use with 2500/3500 Series SFIC lever locksets. 6-pin/7-pin cores	NF	13.55	10
--	----	-------	----



Locks - Cylinders/Keying

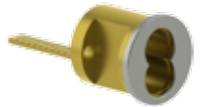

Small Format Interchangeable Core - Tailpieces			
Description	Finish	2018 List	Box Qty.

2-639-7061 Pack of 10 tailpieces and compression springs for use with 3400/3500 Series SFIC knob locksets. 6-pin/7-pin cores	NF	13.55	10
---	----	-------	----

2-639-7090 Pack of 10 tailpieces and compression springs for use with 3753 interconnected lock SFIC lever locksets. 6-pin/7-pin cores	NF	13.55	10
--	----	-------	----

2-639-7091 Pack of 10 tailpieces for use with 3114/3214 SFIC housing deadlock. 6-pin/7-pin cores	NF	13.55	10
---	----	-------	----

2-639-7095 Pack of 10 tailpieces for use with 3115/3118/3215/3710DL/3753DL SFIC housing deadlock. 6-pin/7-pin cores	NF	13.55	10
--	----	-------	----

Small Format Interchangeable Core - Rim Cylinder Housing			
Description	Finish	2018 List	Box Qty.

3901 Rim Cylinder - Small Format Interchangeable Core Housing Specify 6-pin or 7-pin Supplied with long tailpiece standard, collar, mounting plate, and breakoff screws. Cores sold separately.	US3 US4 US10 US10B US26 US26D	48.50 51.55 51.55 48.50 48.50 48.50	1
--	--	--	---

Small Format Interchangeable Core - Mortise Cylinder Housing			
Description	Finish	2018 List	Box Qty.

3902 Mortise Cylinder - Small Format Interchangeable Core Housing Specify length 1-1/4" (6-pin) or 1-3/8" (7-pin) or 1-5/8" for mortise exit devices. Shipped with standard cam attached and Adams Rite cam loose in box (specify if different). Cores sold separately. 1/4" blocking ring included. Specify Schlage L cam when ordering new cylinders for use in Hager mortise lock.	US3 US4 US10 US10B US26 US26D	48.50 51.55 51.55 48.50 48.50 48.50	1
---	--	--	---

Small Format Interchangeable Core - Mortise Cylinder Cams			
Description	Finish	2018 List	Box Qty.

2-639-7082 Yale Standard Cam Shipped standard w/ 3902 Small Format Interchangeable Core (SFIC) Housing.	US2C	3.70 ea	10
--	------	---------	----

2-639-7083 Adams Rite Cam Shipped loose in box w/ standard 3902 Small Format Interchangeable Core (SFIC) Housing.	US2C	3.70 ea	10
--	------	---------	----

2-639-7084 Corbin/Best Cloverleaf Cam	US2C	3.70 ea	10
---	------	---------	----





Small Format Interchangeable Core - Mortise Cylinder Cams			
Description	Finish	2018 List	Box Qty.

2-639-7085 Schlage 'L' Cam For use w/ all keyed functions on 3800 Series Mortise Locks and 46CE.	US2C	3.70 ea	10
---	------	---------	----

2-639-7086 Sargent Yale Cam	US2C	3.70 ea	10
---------------------------------------	------	---------	----

Large Format Interchangeable Core - Keying Charges/Cores		
Description	Finish	2018 List

3919-Z Zero Bitted Core 6-Pin (includes two key blanks), specify US4 or US26D		53.00
---	--	-------

3919-C Combinated Core 6-Pin (includes two change keys), specify US4 or US26D. Specify KA*, KD*, MK**. Specify number of control keys needed.		64.75
--	--	-------

3919-BLA (Schlage C) Construction Core 6-Pin (includes two operating keys). Specify number of control keys. Two control keys provided as a default.		64.75
---	--	-------

Key Markings: Standard key symbols (AA1) - Visual Key Control (VKC)		N/C
---	--	-----

Key Markings: Non-standard code - Visual Key Control (VKC)		6.05
--	--	------

Core Markings (Visual or Concealed)		6.05
-------------------------------------	--	------

3998 Bitting list (no charge if ordered with master key) - Factory keyed		175.00
--	--	--------

Bitting list - Hager designed system - Keyed by others		175.00
--	--	--------

*Allow 7 working days for KD and KA orders

** Allow 20 working days for factory master key orders.

Notes:

1. Lock prices do not include keying charges.
2. Cores are available in Schlage C keyway only.
3. Please include Master Key Instruction Sheet with order, available online or in catalog. Failure to provide will delay order.
4. Construction Cores - Receive full credit, less shipping, of original cost upon return of cores and keys.

Large Format Interchangeable Core - Keys		
Description	Finish	2018 List

3956 LFIC Key Blanks Schlage C Keyway		2.20
--	--	------

3962 LFIC Cut Keys Schlage C Keyway		6.35
--	--	------

2-639-7649 LFIC Control Key Blanks Schlage C Keyway		2.20
--	--	------



Locks - Cylinders/Keying

Large Format Interchangeable Core - Keys		
Description	Finish	2018 List
3963 LFIC Control Cut Keys Schlage C Keyway		6.35



2-639-7132 LFIC 6-Pin "Black" Construction Control Key Schlage C Keyway		6.35
--	--	------

Large Format Interchangeable Core - Tailpieces			
Description	Finish	2018 List	Box Qty.



2-639-7645 For use with 3450, 3453, and 3480 LFIC lever locksets		2.45	1
--	--	------	---



2-639-7646 For use with 3470 LFIC lever locksets		2.45	1
--	--	------	---



2-639-7647 For use with 3473 and 3495 LFIC lever locksets		2.45	1
---	--	------	---

Large Format Interchangeable Core - Rim Cylinder Housing			
Description	Finish	2018 List	Box Qty.



3901 Rim Cylinder - Large Format Interchangeable Core Housing Supplied with tailpiece, collar, mounting plate, and breakoff screws. 6-Pin Only Cores sold separately.	US3	48.50	1
	US4	51.55	
	US10	51.55	
	US10B	48.50	
	US26	48.50	
	US26D	48.50	

LFIC - Rim Cylinder Accessories			
Description	Finish	2018 List	Box Qty.



2-639-7578 Breakoff Tailpiece Assembly	NF	3.00	1
--	----	------	---



2-300-0175 Breakoff Screws - 2-1/8" (54mm) (2each)	NF	1.70	2
--	----	------	---

Large Format Interchangeable Core - Mortise Cylinder Housing			
Description	Finish	2018 List	Box Qty.



3902 Mortise Cylinder - Large Format Interchangeable Core Housing 1-1/2" Length Shipped with standard cam attached and Adams Rite cam loose in box (specify if different). Cores sold separately. Specify Schlage L cam when ordering cylinders for use in Hager mortise locks.	US3	48.50	1
	US4	51.55	
	US10	51.55	
	US10B	48.50	
	US26	48.50	
	US26D	48.50	





Large Format Interchangeable Core - Mortise Cylinder Cams			
Description	Finish	2018 List	Box Qty.
2-639-7570 Yale Standard Cam Shipped standard w/ 3902 Large Format Interchangeable Core (LFIC) Housing.	US2C	3.90 ea	1
2-639-7571 Adams Rite Cam Shipped loose in box w/ standard 3902 Large Format Interchangeable Core (LFIC) Housing.	US2C	3.90 ea	1
2-639-7572 Schlage 'L' Cam For use w/ all keyed functions on 3800 Series Mortise Locks and 46CE.	US2C	3.90 ea	1
2-639-7573 Corbin/Best Cloverleaf Cam	US2C	3.90 ea	1
2-639-7574 Sargent/Yale Cam	US2C	3.90 ea	1
Miscellaneous			
Description	Finish	2018 List	Box Qty.
3911 2500/3400 Series Lever Thru-Bolt Jig - Steel	NF	18.75	ea
3912 3500 Series Lever Thru-Bolt Jig - Steel	NF	18.75	ea
3959 Faceplate Adaptor Can be used with a 2-3/8" backset on the 2500, 3500, 3600, and 3700 Series lockset and 3200 Series deadlocks. Converts 1" (25 mm) to 1-1/8" (29 mm) width.	NF	2.65	ea
3968 Aluminum Blocking Rings Sizes available 1/8" (3.2 mm), 3/16" (4.8 mm), 1/4" (6.4 mm), 5/16" (7.9 mm), 3/8" (9.5 mm), 1/2" (12.5 mm)	BGA CLR DBA US10	5.85 5.85 5.85 5.85	ea
3968 Aluminum Blocking Rings Sizes available 1/8" (3.2 mm), 1/4" (6.4 mm),	US3 US4 US10B US26 US26D	5.85 5.85 5.85 5.85 5.85	
3979 Mortise Cam Screws - Fixed Cylinder Mortise Cylinder Only	NF	0.35	each



Locks - Cylinders/Keying



Miscellaneous Description	Finish	2018 List	Box Qty.
3980 Cash Box Nut	NF	8.40	each



2-639-7680 Mortise Cam Screws - SFIC Mortise Cylinder Only	NF	0.35	each
--	----	------	------



Cylinder Collars Description	Finish	2018 List	Box Qty.
2-647-0012 Cylinder Collar - 7/8" projection	US3	19.10	each
2-647-0013 Cylinder Collar - 7/8" projection	ALM	19.10	each
2-647-0014 Cylinder Collar - 7/8" projection	DBZ	19.10	each
2-647-0015 Cylinder Collar - 7/8" projection	US15 / US32D	19.10	each
2-647-0016 Cylinder Collar - 7/8" projection	US4	19.10	each
2-647-0017 Cylinder Collar - 7/8" projection	US10	19.10	each
2-647-0018 Cylinder Collar - 7/8" projection	US10B	19.10	each
2-647-0019 Cylinder Collar - 7/8" projection	US26	19.10	each
2-647-0020 Cylinder Collar - 7/8" projection	US26D	19.10	each

Above cylinder collars can be used with 4700 Series exit device trim and 1-1/8" - 1-3/8" long mortise cylinders.



2-649-0045 Cylinder Collar - 7/16" projection	US3	19.10	each
2-649-0046 Cylinder Collar - 7/16" projection	US4	19.10	each
2-649-0047 Cylinder Collar - 7/16" projection	US10	19.10	each
2-649-0048 Cylinder Collar - 7/16" projection	US10B	19.10	each
2-649-0050 Cylinder Collar - 7/16" projection	US26	19.10	each
2-649-0051 Cylinder Collar - 7/16" projection	US26D	19.10	each
2-649-0052 Cylinder Collar - 7/16" projection	US15 / US32D	19.10	each

Above cylinder collars can be used with 4500 Series exit device trim and 1-1/8" long mortise cylinders.





Cylinder Collars	Finish	2018 List	Box Qty.
2-649-0053 Cylinder Collar - 11/16" projection	US3	19.10	each
2-649-0054 Cylinder Collar - 11/16" projection	US4	19.10	each
2-649-0055 Cylinder Collar - 11/16" projection	US10	19.10	each
2-649-0056 Cylinder Collar - 11/16" projection	US10B	19.10	each
2-649-0057 Cylinder Collar - 11/16" projection	US26	19.10	each
2-649-0058 Cylinder Collar - 11/16" projection	US26D	19.10	each
2-649-0059 Cylinder Collar - 11/16" projection	US15 / US32D	19.10	each

Above cylinder collars can be used with 4500 Series exit device trim and 1-1/4" or 1-3/8" long mortise cylinders.

Cylinder Parts	Finish	2018 List
2-650-3998 SFIC Capping Strip		59.00/ per 50
2-639-7511 Pin Kit 100 each of all pins and springs, additional top pins. Please note that pin kit does NOT include SFIC caps.		345.00
2-639-7512 Cylinder Lubricant		50.00
2-639-7513 Shims Opens a locked conventional cylinder (at the workbench).		49.50/ per 100
2-639-7517 Construction Ball Used for lost ball construction keying. (#6 increment)		55.00/ per 1,000
2-639-7518 Cylinder Spring Pin tumbler spring for use in all cylinders.		6.60/ per 100
2-639-7519 Cap Pin Spring Key-in-Knob/Lever cylinders including Retrofit, and Full Size (Schlage Retrofit) Interchangeable Core.		15.00/ per 100
2-639-7520 Individual SFIC Cap For use with the individual capping block tool #6.		9.00/ per 100
2-639-7522 Profile Cylinder Set Screws Caps the profile cylinder chambers		7.00/ per 10
2-639-7523 Hager Screw Cap - (.280") height		15.00/ per 10



Locks - Cylinders/Keying

Cylinder Parts Description	Finish	2018 List
2-639-7524 Retrofit Screw Cap - (.230") height For use in competitor cylinders with thinner tailpiece driver		15.00/ per 10
2-639-7526 Screw Cap Pin (KIK / LFIC)		15.00/ per 100
2-639-7527 Follower (KIK) Holds top pins in place during assembly or disassembly		19.00
2-639-7528 Tweezers		38.00
2-639-7530 Capping Punch		57.00
2-639-7531 Decombinating Block (punch included)		175.00
2-639-7532 Manual Capping Block (punch included) (140 Spacing)		218.90
2-639-7534* Capping Press (includes 156 spacing toolset)		2,440.00
2-639-7535 Key Punch (140 Spacing)		3,540.00
2-639-7536 HPC 1200 Series Code Card (140 Spacing)		38.50
2-639-7537 Block and Punch Set (140 Spacing) Toolset must be purchased in order to cap Hager H1, H2, or H3 Keyway SFIC cores with Hager capping press (2-639-7534)		274.00

*Purchase 2-639-7537 toolset to cap Hager Keyway SFIC Cores.



Top Pins (sold in multiples of 100)	2018 List
Description	
2-639-8188 #2 (0.025")	6.65/ per 100
2-639-8189 #3 (0.037")	6.65/ per 100
2-639-8190 #4 (0.050")	6.65/ per 100
2-639-8191 #5 (0.062")	6.65/ per 100
2-639-8192 #6 (0.075")	6.65/ per 100
2-639-8193 #7 (0.087")	6.65/ per 100
2-639-8194 #8 (0.100")	6.65/ per 100
2-639-8195 #9 (0.112")	6.65/ per 100
2-639-8196 #10 (0.125")	6.65/ per 100
2-639-8197 #11 (0.137")	6.65/ per 100
2-639-8198 #12 (0.150")	6.65/ per 100
2-639-8199 #13 (0.162")	6.65/ per 100
2-639-8200 #14 (0.175")	6.65/ per 100
2-639-8201 #15 (0.187")	6.65/ per 100
2-639-8202 #16 (0.200")	6.65/ per 100
2-639-8203 #17 (0.212")	6.65/ per 100
2-639-8204 #18 (0.225")	6.65/ per 100
2-639-8205 #19 (0.237")	6.65/ per 100



Locks - Full Bottom Pins

Full Bottom Pins (sold in multiples of 100) Description	2018 List
2-639-8210 #0 (0.185")	6.65/ per 100
2-639-8211 #1 (0.1975")	6.65/ per 100
2-639-8212 #2 (0.210")	6.65/ per 100
2-639-8213 #3 (0.2225")	6.65/ per 100
2-639-8214 #4 (0.2350")	6.65/ per 100
2-639-8215 #5 (0.2475")	6.65/ per 100
2-639-8216 #6 (0.2600")	6.65/ per 100
2-639-8217 #7 (0.2725")	6.65/ per 100
2-639-8218 #8 (0.2850")	6.65/ per 100
2-639-8219 #9 (0.2975")	6.65/ per 100



SFIC Bottom Pins (sold in multiples of 100)	2018 List
Description	
2-639-8220 #0 (0.110")	6.65/ per 100
2-639-8221 #1 (0.122")	6.65/ per 100
2-639-8222 #2 (0.135")	6.65/ per 100
2-639-8223 #3 (0.147")	6.65/ per 100
2-639-8224 #4 (0.160")	6.65/ per 100
2-639-8225 #5 (0.172")	6.65/ per 100
2-639-8226 #6 (0.185")	6.65/ per 100
2-639-8227 #7 (0.197")	6.65/ per 100
2-639-8228 #8 (0.210")	6.65/ per 100
2-639-8229 #9 (0.222")	6.65/ per 100



2310

2310 2-3/8" US15 JOS	174156
2310 2-3/8" 26D CHA	173293
2310 2 3/4" US10B JOS	169469
2310 2 3/4" US10B JHN	169738
2310 2 3/4" US10B WRN	169741
2310 2 3/4" US10B LOU	169744
2310 2 3/4" US10B CHA	169747
2310 2 3/4" US15 JOS	169686
2310 2 3/4" US15 JHN	169701
2310 2 3/4" US15 WRN	169709
2310 2 3/4" US15 LOU	169716
2310 2 3/4" US15 CHA	169722
2310 2 3/4" US26 JOS	169698
2310 2 3/4" US26 JHN	169737
2310 2 3/4" US26 WRN	169740
2310 2 3/4" US26 LOU	169743
2310 2 3/4" US26 CHA	169746
2310 2 3/4" US26D JOS	169453
2310 2 3/4" US26D JHN	169453
2310 2 3/4" US26D JOS	169453
2310 2 3/4" US26D JHN	169617
2310 2 3/4" US26D WRN	169622
2310 2 3/4" US26D LOU	169628
2310 2 3/4" US26D CHA	169631
2310 2 3/4" US3 JOS	169689
2310 2 3/4" US3 JHN	169704
2310 2 3/4" US3 WRN	169712
2310 2 3/4" US3 LOU	169718
2310 2 3/4" US3 CHA	169724
2310 2 3/4" US4 JOS	169695
2310 2 3/4" US4 JHN	169735
2310 2 3/4" US4 WRN	169739
2310 2 3/4" US4 LOU	169742
2310 2 3/4" US4 CHA	169745

2317

2317 US10B JOS	169754
2317 US10B JHN HL	171905
2317 US10B JHN RH	171906
2317 US10B WRN LH	171917
2317 US10B WRN RH	171918
2317 US10B LOU	169772
2317 US10B CHA	169778
2317 US15 JOS	169748
2317 US15 JHN LH	171895
2317 US15 JHN RH	171896
2317 US15 WRN LH	171909
2317 US15 WRN RH	171910
2317 US15 LOU	169768
2317 US15 CHA	169774
2317 US10B JOS	169753
2317 US26 JHN LH	171902
2317 US26 JHN RH	171903
2317 US26 WRN LH	171915
2317 US26 WRN RH	171916
2317 US26 LOU	169771

2317

2317 US26 CHA	169777
2317 US26D JOS	167921
2317 US26D JHN LH	171893
2317 US26D JHN RH	171894
2317 US26D WRN LH	171907
2317 US26D WRN RH	171908
2317 US26D LOU	169767
2317 US26D CHA	169773
2317 US3 JOS	169751
2317 US3 JHN LH	171897
2317 US3 JHN RH	171898
2317 US3 WRN LH	171911
2317 US3 WRN RH	171912
2317 US3 LOU	169769
2317 US3 CHA	169775
2317 US4 LOU	169770
2317 US4 CHA	169776
2317 US4 JOS	169752
2317 US4 JHN LH	171900
2317 US4 JHN RH	171901
2317 US4 WRN LH	171913
2317 US4 WRN RH	171914

2340

2340 2-3/8" US15 JOS	174157
2340 2-3/8" 26D JOS	175754
2340 2-3/8" 26D CHA	173294
2340 2 3/4" US10B JOS	169471
2340 2 3/4" US10B JHN	169819
2340 2 3/4" US10B WRN	169822
2340 2 3/4" US10B LOU	169825
2340 2 3/4" US10B CHA	169828
2340 2 3/4" US15 JOS	169688
2340 2 3/4" US15 JHN	169703
2340 2 3/4" US15 WRN	169711
2340 2 3/4" US15 LOU	169730
2340 2 3/4" US15 CHA	169732
2340 2 3/4" US26 JOS	169700
2340 2 3/4" US26 JHN	169818
2340 2 3/4" US26 WRN	169821
2340 2 3/4" US26 LOU	169824
2340 2 3/4" US26 CHA	169827
2340 2 3/4" US26D JOS	169455
2340 2 3/4" US26D JHN	169455
2340 2 3/4" US26D JHN	169619
2340 2 3/4" US26D WRN	169682
2340 2 3/4" US26D LOU	169729
2340 2 3/4" US26D CHA	169733
2340 2 3/4" US3 JOS	169694
2340 2 3/4" US3 JHN	169706
2340 2 3/4" US3 WRN	169728
2340 2 3/4" US3 LOU	169731
2340 2 3/4" US3 CHA	169734
2340 2 3/4" US4 JOS	169697
2340 2 3/4" US4 JHN	169817
2340 2 3/4" US4 WRN	169820

Items with the price in **bold and red** are Quick Ship Items and ship in 24 hours.

2340

2340 2 3/4" US4 LOU	169823
2340 2 3/4" US4 CHA	169826

2510

2510 2-3/8" US10B ARC ASA	143873
2510 2-3/8" US10B WTN ASA	147186
2510 2-3/8" US26D ARC ASA	134474
2510 2-3/8" US26D WTN ASA	136277
2510 2-3/8" US3 WTN ASA	137318
2510 2-3/4" US10B ARC ASA	128993
2510 2-3/4" US10B WTN ASA	129000
2510 2-3/4" US26D ARC ASA	129001
2510 2-3/4" US26D WTN ASA	129002
2510 2-3/4" US3 ARC ASA	129003
2510 2-3/4" US3 WTN ASA	129004

2517

2517 US10B ARC	130785
2517 US10B WTN	130786
2517 US10B WTN	130786
2517 US10B WTN	130786
2517 US26D ARC	130787
2517 US26D WTN	130788
2517 US26D WTN	130788
2517 US3 ARC	130789
2517 US3 WTN	130790

2525

2525 2-3/8" US10B ARC ASA	176278
2525 2-3/8" US26D ARC ASA	156965
2525 2-3/8" US26D WTN ASA	147316
2525 2-3/8" US3 WTN ASA	167674
2525 2-3/4" US10B ARC ASA	129012
2525 2-3/4" US10B WTN ASA	129013
2525 2-3/4" US26D ARC ASA	129016
2525 2-3/4" US26D WTN ASA	129017
2525 2-3/4" US3 ARC ASA	129018
2525 2-3/4" US3 WTN ASA	129020

2540

2540 2-3/8" US10B ARC ASA	135767
2540 2-3/8" US10B WTN ASA	147189
2540 2-3/8" US26D ARC ASA	134473
2540 2-3/8" US26D WTN ASA	144640
2540 2-3/8" US3 WTN ASA	137317
2540 2-3/4" US10B ARC ASA	129021
2540 2-3/4" US10B WTN ASA	129022
2540 2-3/4" US26D ARC ASA	129023
2540 2-3/4" US26D WTN ASA	129024
2540 2-3/4" US3 ARC ASA	129025
2540 2-3/4" US3 WTN ASA	129026

2550

2550 2-3/8" US26D ARC SCC KD ASA	150263
2550 2-3/8" US26D WTN SCC KD ASA	148604
2550 2-3/4" US10B ARC SCC KD ASA	129637
2550 2-3/4" US10B WTN SCC KD ASA	129638
2550 2-3/4" US26D ARC SCC KD ASA	129639

2550

2550 2-3/4" US26D WTN SCC KD ASA	129642
2550 2-3/4" US26D WTN SCC KD ASA	129642
2550 2-3/4" US3 ARC SCC KD ASA	129643
2550 2-3/4" US3 WTN SCC KA ASA	134149
2550 2-3/4" US3 WTN SCC KD ASA	129644

2553

2553 2-3/8" US10B ARC SCC KA ASA	135787
2553 2-3/8" US10B ARC SCC KD ASA	140478
2553 2-3/8" US10B WTN SCC KD ASA	160465
2553 2-3/8" US26D ARC SCC KD ASA	134768
2553 2-3/8" US26D WTN SCC KD ASA	136279
2553 2-3/8" US3 ARC SCC KD ASA	163970
2553 2-3/8" US3 WTN SCC KD ASA	150220
2553 2-3/4" US10B ARC SCC KD ASA	129645
2553 2-3/4" US10B WTN SCC KD ASA	129646
2553 2-3/4" US26D ARC SCC KD ASA	129647
2553 2-3/4" US26D WTN SCC KD ASA	129648
2553 2-3/4" US3 ARC SCC KD ASA	129649
2553 2-3/4" US3 WTN SCC KD ASA	129650
2553 2-3/4" US3/US26D WTN SCC KD ASA	152111

2570

2570 2-3/8" US10B WTN SCC KD ASA	164364
2570 2-3/8" US26D WTN SCC KD ASA	143635
2570 2-3/8" US3 WTN SCC KD ASA	170761
2570 2-3/4" US10B ARC SCC KD ASA	129651
2570 2-3/4" US10B WTN SCC KD ASA	129652
2570 2-3/4" US26D ARC SCC KD ASA	129653
2570 2-3/4" US26D WTN SCC KD ASA	129654
2570 2-3/4" US3 ARC SCC KD ASA	129655
2570 2-3/4" US3 WTN SCC KD ASA	129656

2580

2580 2-3/8" US10B WTN SCC KD ASA	151209
2580 2-3/8" US26D WTN SCC KD ASA	132617
2580 2-3/4" US10B ARC SCC KD ASA	129657
2580 2-3/4" US10B WTN SCC KD ASA	129658
2580 2-3/4" US26D ARC SCC KD ASA	129659
2580 2-3/4" US26D WTN SCC KD ASA	129660
2580 2-3/4" US3 ARC SCC KD ASA	129661
2580 2-3/4" US3 WTN SCC KD ASA	129662

3114

3114 2-3/4" US10 NC IC034812
3114 2-3/4" US10 SCC KD012596
3114 2-3/4" US10B NC IC034811
3114 2-3/4" US10B SCC KD012597
3114 2-3/4" US26 NC IC034810
3114 2-3/4" US26 SCC KD028119
3114 2-3/4" US26D NC IC	034807
3114 2-3/4" US26D SCC KD	028118
3114 2-3/4" US3 NC IC034815
3114 2-3/4" US3 SCC KD012594
3114 2-3/4" US4 NC IC034814
3114 2-3/4" US4 SCC KD012595

Items with the price in **bold and red** are Quick Ship Items and ship in 24 hours.



3115		3215	
3115 2-3/4" US10 NC IC	.040420	3215 2-3/4" US10B SCC KD	012652
3115 2-3/4" US10 SCC KD	.012588	3215 2-3/8" US26D NC IC	.046832
3115 2-3/4" US10B NC IC	.040418	3215 2-3/8" US26D SCC KD	.065836
3115 2-3/4" US10B SCC KD	.012592	3215 2-3/4" US26D NC IC	098280
3115 2-3/4" US26 NC IC	.040449	3215 2-3/4" US26D SCC KD	098341
3115 2-3/4" US26 SCC KD	.028121	3215 2-3/8" US3 NC IC	.005743
3115 2-3/4" US26D NC IC	098283	3215 2-3/8" US3 SCC KD	.096177
3115 2-3/4" US26D SCC KD	028120	3215 2-3/4" US3 NC IC	.084949
3115 2-3/4" US3 NC IC	.040425	3215 2-3/4" US3 SCC KD	.012655
3115 2-3/4" US3 SCC KD	.012590	3215 2-3/8" US32 SCC KD	.140554
3115 2-3/4" US4 NC IC	.050868	3215 2-3/4" US32 NC IC	.038839
3115 2-3/4" US4 SCC KD	.012589	3215 2-3/4" US32 SCC KD	.012656
3118		3215 2-3/8" US32D NC IC	.031595
3118 2-3/4" US10 NC IC	.038894	3215 2-3/8" US32D SCC KD	.097015
3118 2-3/4" US10 SCC KD	.028133	3215 2-3/4" US32D NC IC	.098220
3118 2-3/4" US10B NC IC	.038887	3215 2-3/4" US32D SCC KD	012657
3118 2-3/4" US10B SCC KD	.050113	3215 2-3/8" US4 NC IC	.108489
3118 2-3/4" US26 NC IC	.039335	3215 2-3/8" US4 SCC KD	.067222
3118 2-3/4" US26 SCC KD	.028126	3215 2-3/4" US4 NC IC	.038847
3118 2-3/4" US26D NC IC	098282	3215 2-3/4" US4 SCC KD	.012654
3118 2-3/4" US26D SCC KD	028123	3216	
3118 2-3/4" US3 NC IC	.038920	3216 ADJ US10	.143039
3118 2-3/4" US3 SCC KD	.028129	3216 ADJ US10B	.143040
3118 2-3/4" US4 NC IC	.038899	3216 ADJ US26D	143041
3118 2-3/4" US4 SCC KD	.028131	3216 ADJ US3	.143037
3214		3216 ADJ US32	.143042
3214 2-3/8" US10 SCC KD	.099243	3216 ADJ US32D	.143043
3214 2-3/4" US10 NC IC	.034800	3216 ADJ US4	.143038
3214 2-3/4" US10 SCC KD	.012650	3220	
3214 2-3/8" US10B SCC KD	.058093	3220 ADJ US10	.111391
3214 2-3/4" US10B NC IC	.034769	3220 ADJ US10B	.111392
3214 2-3/4" US10B SCC KD	.012651	3220 ADJ US26D	118136
3214 2-3/8" US26D SCC KD	.113487	3220 ADJ US3	.111393
3214 2-3/4" US26D NC IC	.034759	3220 ADJ US32	.111394
3214 2-3/4" US26D SCC KD	098342	3220 ADJ US32D	.111395
3214 2-3/8" US3 SCC KD	.044086	3220 ADJ US4	.111396
3214 2-3/4" US3 NC IC	.034803	3221	
3214 2-3/4" US3 SCC KD	.012647	3221 ADJ US10	.111825
3214 2-3/4" US32 NC IC	.034758	3221 ADJ US10B	.111832
3214 2-3/4" US32 SCC KD	.012646	3221 ADJ US26D	.118140
3214 2-3/8" US32D SCC KD	.096051	3221 ADJ US3	.111833
3214 2-3/4" US32D NC IC	.034749	3221 ADJ US32	.111834
3214 2-3/4" US32D SCC KD	012645	3221 ADJ US32D	.111835
3214 2-3/8" US4 SCC KD	.130567	3221 ADJ US4	.111837
3214 2-3/4" US4 NC IC	.034801	3222	
3214 2-3/4" US4 SCC KD	.012649	3222 ADJ US10	.111415
3215		3222 ADJ US10B	.111416
3215 2-3/8" US10 NC IC	.136009	3222 ADJ US26D	.118139
3215 2-3/8" US10 SCC KD	.054763	3222 ADJ US3	.111417
3215 2-3/4" US10 NC IC	.048992	3222 ADJ US32	.111418
3215 2-3/4" US10 SCC KD	.012653	3222 ADJ US32D	.111419
3215 2-3/8" US10B NC IC	.007223	3222 ADJ US4	.111421
3215 2-3/8" US10B SCC KD	.097759		
3215 2-3/4" US10B NC IC	.038848		

Items with the price in **bold and red** are Quick Ship Items and ship in 24 hours.

3410

3410 2-3/4" US10 ARC ASA012557
3410 2-3/4" US10 AUG ASA041178
3410 2-3/4" US10 WTN ASA012548
3410 2-3/4" US10B ARC ASA012560
3410 2-3/4" US10B AUG ASA041148
3410 2-3/4" US10B WTN ASA012549
3410 2-3/4" US26 ARC ASA012553
3410 2-3/4" US26 AUG ASA041141
3410 2-3/4" US26 WTN ASA012526
3410 2-3/4" US26D ARC ASA012550
3410 2-3/4" US26D AUG ASA041139
3410 2-3/4" US26D WTN ASA012525
3410 2-3/4" US3 ARC ASA012554
3410 2-3/4" US3 APL ASA012520
3410 2-3/4" US3 AUG ASA041082
3410 2-3/4" US3 WTN ASA012528
3410 2-3/4" US32D APL ASA012524
3410 2-3/4" US4 ARC ASA012555
3410 2-3/4" US4 AUG ASA040960
3410 2-3/4" US4 WTN ASA012530

3417

3417 US10 ARC012576
3417 US10 AUG028522
3417 US10 WTN012569
3417 US10B ARC012577
3417 US10B AUG028542
3417 US10B WTN012570
3417 US26 ARC012572
3417 US26 AUG028516
3417 US26 WTN012566
3417 US26D ARC012571
3417 US26D AUG028530
3417 US26D WTN012563
3417 US3 ARC012573
3417 US3 APL012561
3417 US3 AUG028515
3417 US3 WTN012567
3417 US32D APL012562
3417 US4 ARC012575
3417 US4 AUG028529
3417 US4 WTN012568

3440

3440 2-3/4" US10 ARC ASA012518
3440 2-3/4" US10 AUG ASA040751
3440 2-3/4" US10 WTN ASA012509
3440 2-3/4" US10B ARC ASA012519
3440 2-3/4" US10B AUG ASA040748
3440 2-3/4" US10B WTN ASA012510
3440 2-3/4" US26 ARC ASA012515
3440 2-3/4" US26 AUG ASA040718
3440 2-3/4" US26 WTN ASA012504
3440 2-3/4" US26D ARC ASA012514
3440 2-3/4" US26D AUG ASA040658
3440 2-3/4" US26D WTN ASA012499
3440 2-3/4" US3 ARC ASA012516

3440

3440 2-3/4" US3 APL ASA012502
3440 2-3/4" US3 AUG ASA040639
3440 2-3/4" US3 WTN ASA012505
3440 2-3/4" US32D APL ASA012503
3440 2-3/4" US4 ARC ASA012517
3440 2-3/4" US4 AUG ASA040618
3440 2-3/4" US4 WTN ASA012508

3450

3450 2-3/4" US10 ARC NC ASA IC038099
3450 2-3/4" US10 ARC SCC KD ASA038133
3450 2-3/4" US10 AUG NC ASA IC024940
3450 2-3/4" US10 AUG SCC KD ASA028445
3450 2-3/4" US10 WTN NC ASA IC038088
3450 2-3/4" US10 WTN SCC KD ASA038127
3450 2-3/4" US10B ARC NC ASA IC038087
3450 2-3/4" US10B ARC SCC KD ASA038116
3450 2-3/4" US10B AUG NC ASA IC024141
3450 2-3/4" US10B AUG SCC KD ASA028440
3450 2-3/4" US10B WTN NC ASA IC038048
3450 2-3/4" US10B WTN SCC KD ASA038113
3450 2-3/4" US26 ARC NC ASA IC038824
3450 2-3/4" US26 ARC SCC KD ASA038170
3450 2-3/4" US26 AUG NC ASA IC024933
3450 2-3/4" US26 AUG SCC KD ASA028439
3450 2-3/4" US26 WTN NC ASA IC038823
3450 2-3/4" US26 WTN SCC KD ASA038169
3450 2-3/4" US26D ARC NC ASA IC098296
3450 2-3/4" US26D ARC SCC KD ASA098330
3450 2-3/4" US26D AUG NC ASA IC024987
3450 2-3/4" US26D AUG SCC KD ASA028481
3450 2-3/4" US26D WTN NC ASA IC098323
3450 2-3/4" US26D WTN SCC KD ASA098333
3450 2-3/4" US3 ARC NC ASA IC038539
3450 2-3/4" US3 ARC SCC KD ASA038167
3450 2-3/4" US3 AUG NC ASA IC024928
3450 2-3/4" US3 AUG SCC KD ASA028431
3450 2-3/4" US3 WTN NC ASA IC038293
3450 2-3/4" US3 WTN SCC KD ASA038140
3450 2-3/4" US4 ARC NC ASA IC038135
3450 2-3/4" US4 ARC SCC KD ASA038139
3450 2-3/4" US4 AUG NC ASA IC024949
3450 2-3/4" US4 AUG SCC KD ASA028446
3450 2-3/4" US4 WTN NC ASA IC038112
3450 2-3/4" US4 WTN SCC KD ASA038134

3453

3453 2-3/4" US10 ARC NC ASA IC037850
3453 2-3/4" US10 ARC SCC KD ASA012442
3453 2-3/4" US10 AUG NC ASA IC024866
3453 2-3/4" US10 AUG SCC KD ASA028404
3453 2-3/4" US10 WTN NC ASA IC037795
3453 2-3/4" US10 WTN SCC KD ASA012435
3453 2-3/4" US10B ARC NC ASA IC088953
3453 2-3/4" US10B ARC SCC KD ASA012443
3453 2-3/4" US10B AUG NC ASA IC024855
3453 2-3/4" US10B AUG SCC KD ASA028393

Items with the price in **bold and red** are Quick Ship Items and ship in 24 hours.



3453

3453 2-3/4" US10B WTN NC ASA IC037776
3453 2-3/4" US10B WTN SCC KD ASA	012437
3453 2-3/4" US26 ARC NC ASA IC038229
3453 2-3/4" US26 ARC SCC KD ASA012439
3453 2-3/4" US26 AUG NC ASA IC024761
3453 2-3/4" US26 AUG SCC KD ASA028391
3453 2-3/4" US26 WTN NC ASA IC038044
3453 2-3/4" US26 WTN SCC KD ASA012429
3453 2-3/4" US26D ARC NC ASA IC	098295
3453 2-3/4" US26D ARC SCC KD ASA	012438
3453 2-3/4" US26D AUG NC ASA IC024713
3453 2-3/4" US26D AUG SCC KD ASA	028390
3453 2-3/4" US26D WTN NC ASA IC	098322
3453 2-3/4" US26D WTN SCC KD ASA	012427
3453 2-3/4" US3 ARC NC ASA IC038042
3453 2-3/4" US3 ARC SCC KD ASA012440
3453 2-3/4" US3 AUG NC ASA IC024712
3453 2-3/4" US3 AUG SCC KD ASA028389
3453 2-3/4" US3 WTN NC ASA IC038040
3453 2-3/4" US3 WTN SCC KD ASA012433
3453 2-3/4" US4 ARC NC ASA IC038018
3453 2-3/4" US4 ARC SCC KD ASA012441
3453 2-3/4" US4 AUG NC ASA IC024616
3453 2-3/4" US4 AUG SCC KD ASA028381
3453 2-3/4" US4 WTN NC ASA IC037886
3453 2-3/4" US4 WTN SCC KD ASA012434
3453 2-3/4" US3 APL SCC KD ASA012423
3453 2-3/4" US32D APL NC ASA IC060301
3453 2-3/4" US32D APL SCC KD ASA012425

3470

3470 2-3/4" US10 ARC NC ASA IC037656
3470 2-3/4" US10 ARC SCC KD ASA012473
3470 2-3/4" US10 AUG NC ASA IC024615
3470 2-3/4" US10 AUG SCC KD ASA028346
3470 2-3/4" US10 WTN NC ASA IC037616
3470 2-3/4" US10 WTN SCC KD ASA012458
3470 2-3/4" US10B ARC NC ASA IC037613
3470 2-3/4" US10B ARC SCC KD ASA012474
3470 2-3/4" US10B AUG NC ASA IC024467
3470 2-3/4" US10B AUG SCC KD ASA028344
3470 2-3/4" US10B WTN NC ASA IC037532
3470 2-3/4" US10B WTN SCC KD ASA012462
3470 2-3/4" US26 ARC NC ASA IC038100
3470 2-3/4" US26 ARC SCC KD ASA012467
3470 2-3/4" US26 AUG NC ASA IC024613
3470 2-3/4" US26 AUG SCC KD ASA028343
3470 2-3/4" US26 WTN NC ASA IC037742
3470 2-3/4" US26 WTN SCC KD ASA012453
3470 2-3/4" US26D ARC NC ASA IC098293
3470 2-3/4" US26D ARC SCC KD ASA	012463
3470 2-3/4" US26D AUG NC ASA IC024554
3470 2-3/4" US26D AUG SCC KD ASA	028339
3470 2-3/4" US26D WTN NC ASA IC	098321
3470 2-3/4" US26D WTN SCC KD ASA	012451
3470 2-3/4" US3 ARC NC ASA IC037741

Items with the price in **bold and red** are Quick Ship Items and ship in 24 hours.

3470

3470 2-3/4" US3 ARC SCC KD ASA012468
3470 2-3/4" US3 AUG NC ASA IC024543
3470 2-3/4" US3 AUG SCC KD ASA028324
3470 2-3/4" US3 WTN NC ASA IC037724
3470 2-3/4" US3 WTN SCC KD ASA012454
3470 2-3/4" US4 ARC NC ASA IC037686
3470 2-3/4" US4 ARC SCC KD ASA012470
3470 2-3/4" US4 AUG NC ASA IC024405
3470 2-3/4" US4 AUG SCC KD ASA028330
3470 2-3/4" US4 WTN NC ASA IC037657
3470 2-3/4" US4 WTN SCC KD ASA012455
3470 2-3/4" US3 APL SCC KD ASA012445
3470 2-3/4" US32D APL NC ASA IC143141
3470 2-3/4" US32D APL SCC KD ASA012447

3473

3473 2-3/4" US10 ARC NC ASA IC (REV1)138464
3473 2-3/4" US10 ARC SCC KD ASA (REV1)138465
3473 2-3/4" US10 AUG NC ASA IC (REV1)138466
3473 2-3/4" US10 AUG SCC KD ASA (REV1)138467
3473 2-3/4" US10 WTN NC ASA IC (REV1)138468
3473 2-3/4" US10 WTN SCC KD ASA (REV1)138469
3473 2-3/4" US10B ARC NC ASA IC (REV1)138470
3473 2-3/4" US10B ARC SCC KD ASA (REV1)138471
3473 2-3/4" US10B AUG NC ASA IC (REV1)138472
3473 2-3/4" US10B AUG SCC KD ASA (REV1)138473
3473 2-3/4" US10B WTN NC ASA IC (REV1)138474
3473 2-3/4" US10B WTN SCC KD ASA (REV1)138475
3473 2-3/4" US26 ARC NC ASA IC (REV1)138476
3473 2-3/4" US26 ARC SCC KD ASA (REV1)138477
3473 2-3/4" US26 AUG NC ASA IC (REV1)138478
3473 2-3/4" US26 AUG SCC KD ASA (REV1)138479
3473 2-3/4" US26 WTN NC ASA IC (REV1)138480
3473 2-3/4" US26 WTN SCC KD ASA (REV1)138481
3473 2-3/4" US26D ARC NC ASA IC (REV1)138482
3473 2-3/4" US26D ARC SCC KD ASA (REV1)138485
3473 2-3/4" US26D AUG NC ASA IC (REV1)138487
3473 2-3/4" US26D AUG SCC KD ASA (REV1)138488
3473 2-3/4" US26D WTN NC ASA IC (REV1)138489
3473 2-3/4" US26D WTN SCC KD ASA (REV1)138490
3473 2-3/4" US3 ARC NC ASA IC (REV1)138491
3473 2-3/4" US3 ARC SCC KD ASA (REV1)138492
3473 2-3/4" US3 AUG NC ASA IC (REV1)138493
3473 2-3/4" US3 AUG SCC KD ASA (REV1)138494
3473 2-3/4" US3 WTN NC ASA IC (REV1)138495
3473 2-3/4" US3 WTN SCC KD ASA (REV1)138496
3473 2-3/4" US4 ARC NC ASA IC (REV1)138497
3473 2-3/4" US4 ARC SCC KD ASA (REV1)138498
3473 2-3/4" US4 AUG NC ASA IC (REV1)138499
3473 2-3/4" US4 AUG SCC KD ASA (REV1)138500
3473 2-3/4" US4 WTN NC ASA IC (REV1)138501
3473 2-3/4" US4 WTN SCC KD ASA (REV1)138502

3480

3480 2-3/4" US10 ARC NC ASA IC037343
3480 2-3/4" US10 ARC SCC KD ASA012495
3480 2-3/4" US10 AUG NC ASA IC024368

3480

3480 2-3/4" US10 AUG SCC KD ASA028031
3480 2-3/4" US10 WTN NC ASA IC037330
3480 2-3/4" US10 WTN SCC KD ASA012483
3480 2-3/4" US10B ARC NC ASA IC037326
3480 2-3/4" US10B ARC SCC KD ASA012496
3480 2-3/4" US10B AUG NC ASA IC024348
3480 2-3/4" US10B AUG SCC KD ASA028017
3480 2-3/4" US10B WTN NC ASA IC037325
3480 2-3/4" US10B WTN SCC KD ASA012490
3480 2-3/4" US26 ARC NC ASA IC038085
3480 2-3/4" US26 ARC SCC KD ASA012492
3480 2-3/4" US26 AUG NC ASA IC024328
3480 2-3/4" US26 AUG SCC KD ASA027994
3480 2-3/4" US26 WTN NC ASA IC037531
3480 2-3/4" US26 WTN SCC KD ASA012479
3480 2-3/4" US26D ARC NC ASA IC	098292
3480 2 3/4 26D ARC SCC KD ASA	012491
3480 2-3/4" US26D AUG NC ASA IC024264
3480 2-3/4" US26D AUG SCC KD ASA	027993
3480 2-3/4" US26D WTN NC ASA IC	098651
3480 2-3/4" US26D WTN SCC KD ASA	012478
3480 2-3/4" US3 ARC NC ASA IC037516
3480 2-3/4" US3 ARC SCC KD ASA012493
3480 2-3/4" US3 AUG NC ASA IC024233
3480 2-3/4" US3 AUG SCC KD ASA027990
3480 2-3/4" US3 WTN NC ASA IC037444
3480 2-3/4" US3 WTN SCC KD ASA012481
3480 2-3/4" US4 ARC NC ASA IC037408
3480 2-3/4" US4 ARC SCC KD ASA012494
3480 2-3/4" US4 AUG NC ASA IC024187
3480 2-3/4" US4 AUG SCC KD ASA027988
3480 2-3/4" US4 WTN NC ASA IC037388
3480 2-3/4" US4 WTN SCC KD ASA012482
3480 2-3/4" US3 APL SCC KD ASA012475
3480 2-3/4" US32D APL NC ASA IC143142
3480 2-3/4" US32D APL SCC KD ASA012477

3495

3495 2-3/4" US10 ARC NC ASA IC006810
3495 2-3/4" US10 ARC SCC KD ASA007195
3495 2-3/4" US10 AUG NC ASA IC006739
3495 2-3/4" US10 AUG SCC KD ASA006847
3495 2-3/4" US10 WTN NC ASA IC006765
3495 2-3/4" US10 WTN SCC KD ASA007081
3495 2-3/4" US10B ARC NC ASA IC006803
3495 2-3/4" US10B ARC SCC KD ASA007192
3495 2-3/4" US10B AUG NC ASA IC006738
3495 2-3/4" US10B AUG SCC KD ASA006846
3495 2-3/4" US10B WTN NC ASA IC006758
3495 2-3/4" US10B WTN SCC KD ASA007074
3495 2-3/4" US26 ARC NC ASA IC006798
3495 2-3/4" US26 ARC SCC KD ASA007182
3495 2-3/4" US26 AUG NC ASA IC006735
3495 2-3/4" US26 AUG SCC KD ASA006841
3495 2-3/4" US26 WTN NC ASA IC006754
3495 2-3/4" US26 WTN SCC KD ASA007071

3495

3495 2-3/4" US26D ARC NC ASA IC006797
3495 2-3/4" US26D ARC SCC KD ASA007180
3495 2-3/4" US26D AUG NC ASA IC006705
3495 2-3/4" US26D AUG SCC KD ASA006840
3495 2-3/4" US26D WTN NC ASA IC006753
3495 2-3/4" US26D WTN SCC KD ASA	007070
3495 2-3/4" US3 ARC NC ASA IC007292
3495 2-3/4" US3 ARC SCC KD ASA007295
3495 2-3/4" US3 AUG NC ASA IC006745
3495 2-3/4" US3 AUG SCC KD ASA007063
3495 2-3/4" US3 WTN NC ASA IC006795
3495 2-3/4" US3 WTN SCC KD ASA007176
3495 2-3/4" US4 ARC NC ASA IC006819
3495 2-3/4" US4 ARC SCC KD ASA007199
3495 2-3/4" US4 AUG NC ASA IC006743
3495 2-3/4" US4 AUG SCC KD ASA006848
3495 2-3/4" US4 WTN NC ASA IC006792
3495 2-3/4" US4 WTN SCC KD ASA007170

3510

3510 2-3/4" US10 ARC ASA000319
3510 2-3/4" US10 AUG ASA038966
3510 2-3/4" US10 WTN ASA000261
3510 2-3/4" US10B ARC ASA	000320
3510 2-3/4" US10B AUG ASA	037082
3510 2-3/4" US10B WTN ASA	000262
3510 2-3/4" US26 ARC ASA000316
3510 2-3/4" US26 AUG ASA036933
3510 2-3/4" US26 WTN ASA000258
3510 2-3/4" US26D ARC ASA	000313
3510 2-3/4" US26D AUG ASA	036892
3510 2-3/4" US26D WTN ASA	000256
3510 2-3/4" US3 ARC ASA000317
3510 2-3/4" US3 AUG ASA036825
3510 2-3/4" US3 WTN ASA000259
3510 2-3/4" US4 ARC ASA000318
3510 2-3/4" US4 AUG ASA036813
3510 2-3/4" US4 WTN ASA000260
3510 2-3/4" US3 APL ASA091147
3510 2-3/4" US32D APL ASA	091148

3517

3517 US10 ARC000329
3517 US10 AUG027799
3517 US10 WTN000277
3517 US10B ARC111284
3517 US10B AUG111285
3517 US10B WTN111286
3517 US26 ARC000322
3517 US26 AUG027791
3517 US26 WTN111288
3517 US26D ARC	111289
3517 US26D AUG	111290
3517 US26D WTN	111291
3517 US3 ARC000323
3517 US3 AUG027775
3517 US3 WTN111294

Items with the price in **bold and red** are Quick Ship Items and ship in 24 hours.

3517

3517 US4 ARC	.000325
3517 US4 AUG	.027768
3517 US4 WTN	.000276
3517 US3 APL	.000102
3517 US32D APL	.000105

3525

3525 2-3/4" US10 ARC ASA	.095545
3525 2-3/4" US10 AUG ASA	.038501
3525 2-3/4" US10 WTN ASA	.095536
3525 2-3/4" US10B ARC ASA	.095546
3525 2-3/4" US10B AUG ASA	.038434
3525 2-3/4" US10B WTN ASA	.095537
3525 2-3/4" US26 ARC ASA	.095547
3525 2-3/4" US26 AUG ASA	.038492
3525 2-3/4" US26 WTN ASA	.095543
3525 2-3/4" US26D ARC ASA	.095550
3525 2-3/4" US26D AUG ASA	.038430
3525 2-3/4" US26D WTN ASA	.095544
3525 2-3/4" US3 ARC ASA	.095533
3525 2-3/4" US3 AUG ASA	.038519
3525 2-3/4" US3 WTN ASA	.095532
3525 2-3/4" US4 ARC ASA	.095534
3525 2-3/4" US4 AUG ASA	.038390
3525 2-3/4" US4 WTN ASA	.095535

3527

3527 US10 ARC	.111169
3527 US10 AUG	.111189
3527 US10 WTN	.111191
3527 US10B ARC	.111192
3527 US10B AUG	.111193
3527 US10B WTN	.111194
3527 US26 ARC	.111195
3527 US26 AUG	.111196
3527 US26 WTN	.111197
3527 US26D ARC	.111198
3527 US26D AUG	.111199
3527 US26D WTN	.111200
3527 US3 ARC	.111201
3527 US3 AUG	.111202
3527 US3 WTN	.111203
3527 US4 ARC	.111205
3527 US4 AUG	.111206
3527 US4 WTN	.111204

3540

3540 2-3/4" US10 ARC ASA	.000311
3540 2-3/4" US10 AUG ASA	.038384
3540 2-3/4" US10 WTN ASA	.000252
3540 2-3/4" US10B ARC ASA	.000312
3540 2-3/4" US10B AUG ASA	.038280
3540 2-3/4" US10B WTN ASA	.000254
3540 2-3/4" US26 ARC ASA	.000308
3540 2-3/4" US26 AUG ASA	.038266
3540 2-3/4" US26 WTN ASA	.000248
3540 2-3/4" US26D ARC ASA	.000307

Items with the price in **bold and red** are Quick Ship Items and ship in 24 hours.

3540

3540 2-3/4" US26D AUG ASA	.038034
3540 2-3/4" US26D WTN ASA	.000247
3540 2-3/4" US3 ARC ASA	.000309
3540 2-3/4" US3 AUG ASA	.037999
3540 2-3/4" US3 WTN ASA	.000249
3540 2-3/4" US4 ARC ASA	.000310
3540 2-3/4" US4 AUG ASA	.037979
3540 2-3/4" US4 WTN ASA	.000250
3540 2-3/4" US3 APL ASA	.091121
3540 2-3/4" US32D APL ASA	.091146

3550

3550 2-3/4" US10 ARC NC ASA IC	.037229
3550 2-3/4" US10 ARC SCC KD ASA	.037173
3550 2-3/4" US10 AUG NC ASA IC	.023439
3550 2-3/4" US10 AUG SCC KD ASA	.027728
3550 2-3/4" US10 WTN NC ASA IC	.037227
3550 2-3/4" US10 WTN SCC KD ASA	.037170
3550 2-3/4" US10B ARC NC ASA IC	.037208
3550 2-3/4" US10B ARC SCC KD ASA	.037169
3550 2-3/4" US10B AUG NC ASA IC	.023588
3550 2-3/4" US10B AUG SCC KD ASA	.027729
3550 2-3/4" US10B WTN NC ASA IC	.037206
3550 2-3/4" US10B WTN SCC KD ASA	.037162
3550 2-3/4" US26 ARC NC ASA IC	.038039
3550 2-3/4" US26 ARC SCC KD ASA	.037205
3550 2-3/4" US26 AUG NC ASA IC	.023554
3550 2-3/4" US26 AUG SCC KD ASA	.027726
3550 2-3/4" US26 WTN NC ASA IC	.037256
3550 2-3/4" US26 WTN SCC KD ASA	.037203
3550 2-3/4" US26D ARC NC ASA IC	.098290
3550 2-3/4" US26D ARC SCC KD ASA	.098325
3550 2-3/4" US26D AUG NC ASA IC	.023493
3550 2-3/4" US26D AUG SCC KD ASA	.027719
3550 2-3/4" US26D WTN NC ASA IC	.098291
3550 2-3/4" US26D WTN SCC KD ASA	.098329
3550 2-3/4" US3 ARC NC ASA IC	.037245
3550 2-3/4" US3 ARC SCC KD ASA	.050365
3550 2-3/4" US3 AUG NC ASA IC	.023438
3550 2-3/4" US3 AUG SCC KD ASA	.027713
3550 2-3/4" US3 WTN NC ASA IC	.037234
3550 2-3/4" US3 WTN SCC KD ASA	.037202
3550 2-3/4" US4 ARC NC ASA IC	.037232
3550 2-3/4" US4 ARC SCC KD ASA	.037200
3550 2-3/4" US4 AUG NC ASA IC	.023453
3550 2-3/4" US4 AUG SCC KD ASA	.027704
3550 2-3/4" US4 WTN NC ASA IC	.037230
3550 2-3/4" US4 WTN SCC KD ASA	.037191

3553

3553 2-3/4" US10 ARC NC ASA IC	.048993
3553 2-3/4" US10 ARC SCC KD ASA	.000290
3553 2-3/4" US10 AUG NC ASA IC	.023437
3553 2-3/4" US10 AUG SCC KD ASA	.027702
3553 2-3/4" US10 WTN NC ASA IC	.037888
3553 2-3/4" US10 WTN SCC KD ASA	.000095
3553 2-3/4" US10B ARC NC ASA IC	.037159

3553

3553 2-3/4" US10B ARC SCC KD ASA000291
3553 2-3/4" US10B AUG NC ASA IC023436
3553 2-3/4" US10B AUG SCC KD ASA027701
3553 2-3/4" US10B WTN NC ASA IC045784
3553 2-3/4" US10B WTN SCC KD ASA	000096
3553 2-3/4" US26 ARC SCC KD ASA000286
3553 2-3/4" US26 AUG NC ASA IC023435
3553 2-3/4" US26 AUG SCC KD ASA027684
3553 2-3/4" US26 WTN NC ASA IC014395
3553 2-3/4" US26 WTN SCC KD ASA000092
3553 2-3/4" US26D ARC NC ASA IC098289
3553 2-3/4" US26D ARC SCC KD ASA	000284
3553 2-3/4" US26D AUG NC ASA IC023393
3553 2-3/4" US26D AUG SCC KD ASA	027683
3553 2-3/4" US26D WTN NC ASA IC	098655
3553 2-3/4" US26D WTN SCC KD ASA	000091
3553 2-3/4" US3 ARC NC ASA IC053986
3553 2-3/4" US3 ARC SCC KD ASA000288
3553 2-3/4" US3 AUG NC ASA IC023377
3553 2-3/4" US3 AUG SCC KD ASA027682
3553 2-3/4" US3 WTN NC ASA IC084942
3553 2-3/4" US3 WTN SCC KD ASA000093
3553 2-3/4" US4 ARC NC ASA IC086632
3553 2-3/4" US4 ARC SCC KD ASA000289
3553 2-3/4" US4 AUG NC ASA IC023296
3553 2-3/4" US4 AUG SCC KD ASA027677
3553 2-3/4" US4 WTN NC ASA IC037153
3553 2-3/4" US4 WTN SCC KD ASA000094
3553 2-3/4" US3 APL SCC KD ASA090526
3553 2-3/4" US32D APL NC ASA IC117596
3553 2-3/4" US32D APL SCC KD ASA	091096

3570

3570 2-3/4" US10 ARC NC ASA IC037112
3570 2-3/4" US10 ARC SCC KD ASA000297
3570 2-3/4" US10 AUG NC ASA IC023292
3570 2-3/4" US10 AUG SCC KD ASA027675
3570 2-3/4" US10 WTN NC ASA IC037111
3570 2-3/4" US10 WTN SCC KD ASA000130
3570 2-3/4" US10B ARC NC ASA IC037110
3570 2-3/4" US10B ARC SCC KD ASA000299
3570 2-3/4" US10B AUG NC ASA IC023281
3570 2-3/4" US10B AUG SCC KD ASA027667
3570 2-3/4" US10B WTN NC ASA IC037109
3570 2-3/4" US10B WTN SCC KD ASA	000129
3570 2-3/4" US26 ARC NC ASA IC037760
3570 2-3/4" US26 ARC SCC KD ASA000294
3570 2-3/4" US26 AUG NC ASA IC023249
3570 2-3/4" US26 AUG SCC KD ASA027652
3570 2-3/4" US26 WTN NC ASA IC037152
3570 2-3/4" US26 WTN SCC KD ASA000098
3570 2-3/4" US26D ARC NC ASA IC098287
3570 2-3/4" US26D ARC SCC KD ASA	000293
3570 2-3/4" US26D AUG NC ASA IC023248
3570 2-3/4" US26D AUG SCC KD ASA	027649
3570 2-3/4" US26D WTN NC ASA IC098288

3570

3570 2-3/4" US26D WTN SCC KD ASA	000097
3570 2-3/4" US3 ARC NC ASA IC037145
3570 2-3/4" US3 ARC SCC KD ASA000295
3570 2-3/4" US3 AUG NC ASA IC023247
3570 2-3/4" US3 AUG SCC KD ASA027645
3570 2-3/4" US3 WTN NC ASA IC084961
3570 2-3/4" US3 WTN SCC KD ASA000099
3570 2-3/4" US4 ARC NC ASA IC037129
3570 2-3/4" US4 ARC SCC KD ASA000296
3570 2-3/4" US4 AUG NC ASA IC023246
3570 2-3/4" US4 AUG SCC KD ASA027647
3570 2-3/4" US4 WTN NC ASA IC037113
3570 2-3/4" US4 WTN SCC KD ASA000101
3570 2-3/4" US3 APL SCC KD ASA090544
3570 2-3/4" US32D APL SCC KD ASA	091099

3573

3573 2-3/4" US10 ARC NC ASA IC (REV1)138416
3573 2-3/4" US10 ARC SCC KD ASA (REV1)138417
3573 2-3/4" US10 AUG NC ASA IC (REV1)138418
3573 2-3/4" US10 AUG SCC KD ASA (REV1)138419
3573 2-3/4" US10 WTN NC ASA IC (REV1)138420
3573 2-3/4" US10 WTN SCC KD ASA (REV1)138421
3573 2-3/4" US10B ARC NC ASA IC (REV1)138422
3573 2-3/4" US10B ARC SCC KD ASA (REV1)138423
3573 2-3/4" US10B AUG NC ASA IC (REV1)138424
3573 2-3/4" US10B AUG SCC KD ASA (REV1)138426
3573 2-3/4" US10B WTN NC ASA IC (REV1)138427
3573 2-3/4" US10B WTN SCC KD ASA (REV1)138428
3573 2-3/4" US26 ARC NC ASA IC (REV1)138429
3573 2-3/4" US26 ARC SCC KD ASA (REV1)138430
3573 2-3/4" US26 AUG NC ASA IC (REV1)138431
3573 2-3/4" US26 AUG SCC KD ASA (REV1)138432
3573 2-3/4" US26 WTN NC ASA IC (REV1)138433
3573 2-3/4" US26 WTN SCC KD ASA (REV1)138434
3573 2-3/4" US26D ARC NC ASA IC (REV1)138405
3573 2-3/4" US26D ARC SCC KD ASA (REV1)138435
3573 2-3/4" US26D AUG NC ASA IC (REV1)138407
3573 2-3/4" US26D AUG SCC KD ASA (REV1)138409
3573 2-3/4" US26D WTN NC ASA IC (REV1)138441
3573 2-3/4" US26D WTN SCC KD ASA (REV1)138412
3573 2-3/4" US3 ARC NC ASA IC (REV1)138448
3573 2-3/4" US3 ARC SCC KD ASA (REV1)138449
3573 2-3/4" US3 AUG NC ASA IC (REV1)138450
3573 2-3/4" US3 AUG SCC KD ASA (REV1)138452
3573 2-3/4" US3 WTN NC ASA IC (REV1)138453
3573 2-3/4" US3 WTN SCC KD ASA (REV1)138454
3573 2-3/4" US4 ARC NC ASA IC (REV1)138455
3573 2-3/4" US4 ARC SCC KD ASA (REV1)138456
3573 2-3/4" US4 AUG NC ASA IC (REV1)138457
3573 2-3/4" US4 AUG SCC KD ASA (REV1)138458
3573 2-3/4" US4 WTN NC ASA IC (REV1)138459
3573 2-3/4" US4 WTN SCC KD ASA (REV1)138460

3579

3579 2-3/4" US10 ARC SCC KD ASA095564
3579 2-3/4" US10 AUG NC ASA IC023240

Items with the price in **bold and red** are Quick Ship Items and ship in 24 hours.



3579

3579 2-3/4" US10 AUG SCC KD ASA027417
3579 2-3/4" US10 WTN SCC KD ASA095555
3579 2-3/4" US10B ARC SCC KD ASA095563
3579 2-3/4" US10B AUG NC ASA IC023129
3579 2-3/4" US10B AUG SCC KD ASA027411
3579 2-3/4" US10B WTN NC ASA IC100241
3579 2-3/4" US10B WTN SCC KD ASA095556
3579 2-3/4" US26 ARC SCC KD ASA095560
3579 2-3/4" US26 AUG NC ASA IC023053
3579 2-3/4" US26 AUG SCC KD ASA027410
3579 2-3/4" US26 WTN SCC KD ASA095557
3579 2-3/4" US26D ARC NC ASA IC098284
3579 2-3/4" US26D ARC SCC KD ASA095559
3579 2-3/4" US26D AUG NC ASA IC023041
3579 2-3/4" US26D AUG SCC KD ASA027408
3579 2-3/4" US26D WTN NC ASA IC098285
3579 2-3/4" US26D WTN SCC KD ASA095558
3579 2-3/4" US3 ARC SCC KD ASA095566
3579 2-3/4" US3 AUG NC ASA IC022986
3579 2-3/4" US3 AUG SCC KD ASA027420
3579 2-3/4" US3 WTN SCC KD ASA095552
3579 2-3/4" US4 ARC SCC KD ASA095565
3579 2-3/4" US4 AUG NC ASA IC023241
3579 2-3/4" US4 AUG SCC KD ASA027421
3579 2-3/4" US4 WTN SCC KD ASA095553

3580

3580 2-3/4" US10 ARC NC ASA IC037088
3580 2-3/4" US10 ARC SCC KD ASA000305
3580 2-3/4" US10 AUG NC ASA IC022937
3580 2-3/4" US10 AUG SCC KD ASA027351
3580 2-3/4" US10 WTN NC ASA IC037034
3580 2-3/4" US10 WTN SCC KD ASA000156
3580 2-3/4" US10B ARC NC ASA IC037031
3580 2-3/4" US10B ARC SCC KD ASA000306
3580 2-3/4" US10B AUG NC ASA IC022831
3580 2-3/4" US10B AUG SCC KD ASA027349
3580 2-3/4" US10B WTN NC ASA IC037018
3580 2-3/4" US10B WTN SCC KD ASA000160
3580 2-3/4" US26 ARC NC ASA IC037752
3580 2-3/4" US26 ARC SCC KD ASA000301
3580 2-3/4" US26 AUG NC ASA IC022737
3580 2-3/4" US26 AUG SCC KD ASA027347
3580 2-3/4" US26 WTN NC ASA IC037103
3580 2-3/4" US26 WTN SCC KD ASA000144
3580 2-3/4" US26D ARC NC ASA IC098286
3580 2-3/4" US26D ARC SCC KD ASA000300
3580 2-3/4" US26D AUG NC ASA IC022700
3580 2-3/4" US26D AUG SCC KD ASA027338
3580 2-3/4" US26D WTN NC ASA IC098652
3580 2-3/4" US26D WTN SCC KD ASA000143
3580 2-3/4" US3 ARC NC ASA IC037098
3580 2-3/4" US3 ARC SCC KD ASA000302
3580 2-3/4" US3 AUG NC ASA IC022615
3580 2-3/4" US3 AUG SCC KD ASA027337
3580 2-3/4" US3 WTN NC ASA IC084892

3580

3580 2-3/4" US3 WTN SCC KD ASA000154
3580 2-3/4" US4 ARC NC ASA IC086636
3580 2-3/4" US4 ARC SCC KD ASA000303
3580 2-3/4" US4 AUG NC ASA IC022602
3580 2-3/4" US4 AUG SCC KD ASA027328
3580 2-3/4" US4 WTN NC ASA IC037089
3580 2-3/4" US4 WTN SCC KD ASA000155
3580 2-3/4" US3 APL SCC KD ASA090565
3580 2-3/4" US32D APL SCC KD ASA091101

3610

3610 ADJ 2-3/8 TO 2-3/4 US10 ARC ASA092398
3610 ADJ 2-3/8 TO 2-3/4 US10 AUG ASA027301
3610 ADJ 2-3/8 TO 2-3/4 US10 WTN ASA092402
3610 ADJ 2-3/8 TO 2-3/4 US10B ARC ASA092404
3610 ADJ 2-3/8 TO 2-3/4 US10B AUG ASA027299
3610 ADJ 2-3/8 TO 2-3/4 US10B WTN ASA092403
3610 ADJ 2-3/8 TO 2-3/4 US26 ARC ASA092406
3610 ADJ 2-3/8 TO 2-3/4 US26 AUG ASA027295
3610 ADJ 2-3/8 TO 2-3/4 US26 WTN ASA092405
3610 ADJ 2-3/8 TO 2-3/4 US26D ARC ASA092408
3610 ADJ 2-3/8 TO 2-3/4 US26D AUG ASA027294
3610 ADJ 2-3/8 TO 2-3/4 US26D WTN ASA092410
3610 ADJ 2-3/8 TO 2-3/4 US3 ARC ASA092416
3610 ADJ 2-3/8 TO 2-3/4 US3 AUG ASA027292
3610 ADJ 2-3/8 TO 2-3/4 US3 WTN ASA092411
3610 ADJ 2-3/8 TO 2-3/4 US4 ARC ASA092418
3610 ADJ 2-3/8 TO 2-3/4 US4 AUG ASA027291
3610 ADJ 2-3/8 TO 2-3/4 US4 WTN ASA092419

3617

3617 US10 ARC013176
3617 US10 AUG027277
3617 US10 WTN013170
3617 US10B ARC013175
3617 US10B AUG027275
3617 US10B WTN013169
3617 US26 ARC013172
3617 US26 AUG027276
3617 US26 WTN013166
3617 US26D ARC013171
3617 US26D AUG027272
3617 US26D WTN013165
3617 US3 ARC013173
3617 US3 AUG027262
3617 US3 WTN013167
3617 US4 ARC013174
3617 US4 AUG027278
3617 US4 WTN013168

3640

3640 ADJ 2-3/8 TO 2-3/4 US10 ARC ASA092422
3640 ADJ 2-3/8" TO 2-3/4" US10 AUG ASA027238
3640 ADJ 2-3/8 TO 2-3/4 US10 WTN ASA092421
3640 ADJ 2-3/8 TO 2-3/4 US10B ARC ASA092423
3640 ADJ 2-3/8" TO 2-3/4" US10B AUG ASA027232
3640 ADJ 2-3/8 TO 2-3/4 US10B WTN ASA092424

Items with the price in **bold and red** are Quick Ship Items and ship in 24 hours.

3640

3640 ADJ 2-3/8 TO 2-3/4 US26 ARC ASA092428
 3640 ADJ 2-3/8" TO 2-3/4" US26 AUG ASA027230
 3640 ADJ 2-3/8 TO 2-3/4 US26 WTN ASA092427
3640 ADJ 2-3/8 TO 2-3/4 US26D ARC ASA 092429
3640 ADJ 2-3/8" TO 2-3/4" US26D AUG ASA 027229
3640 ADJ 2-3/8 TO 2-3/4 US26D WTN ASA 092430
 3640 ADJ 2-3/8 TO 2-3/4 US3 ARC ASA092431
 3640 ADJ 2-3/8" TO 2-3/4" US3 AUG ASA027227
 3640 ADJ 2-3/8 TO 2-3/4 US3 WTN ASA092433
 3640 ADJ 2-3/8 TO 2-3/4 US4 ARC ASA092435
 3640 ADJ 2-3/8" TO 2-3/4" US4 AUG ASA027225
 3640 ADJ 2-3/8 TO 2-3/4 US4 WTN ASA092434

3653

3653 ADJ 2-3/8" TO 2-3/4" US10 ARC NC ASA IC007193
 3653 ADJ 2-3/8 TO 2-3/4 US10 ARC SCC KD ASA092436
 3653 ADJ 2-3/8" TO 2-3/4" US10 AUG NC ASA IC020652
 3653 ADJ 2-3/8" TO 2-3/4" US10 AUG SCC KD ASA026938
 3653 ADJ 2-3/8" TO 2-3/4" US10 WTN NC ASA IC007154
 3653 ADJ 2-3/8 TO 2-3/4 US10 WTN SCC KD ASA092439
 3653 ADJ 2-3/8" TO 2-3/4" US10B ARC NC ASA IC006959
 3653 ADJ 2-3/8 TO 2-3/4 US10B ARC SCC KD ASA092440
 3653 ADJ 2-3/8" TO 2-3/4" US10B AUG NC ASA IC020622
 3653 ADJ 2-3/8" TO 2-3/4" US10B AUG SCC KD ASA026695
 3653 ADJ 2-3/8" TO 2-3/4" US10B WTN NC ASA IC007153
 3653 ADJ 2-3/8 TO 2-3/4 US10B WTN SCC KD ASA092452
 3653 ADJ 2-3/8" TO 2-3/4" US26 ARC NC ASA IC007181
 3653 ADJ 2-3/8 TO 2-3/4 US26 ARC SCC KD ASA092442
 3653 ADJ 2-3/8" TO 2-3/4" US26 AUG NC ASA IC020621
 3653 ADJ 2-3/8" TO 2-3/4" US26 AUG SCC KD ASA026868
 3653 ADJ 2-3/8" TO 2-3/4" US26 WTN NC ASA IC007148
 3653 ADJ 2-3/8 TO 2-3/4 US26 WTN SCC KD ASA092450
 3653 ADJ 2-3/8" TO 2-3/4" US26D ARC NC ASA IC007177
3653 ADJ 2-3/8 TO 2-3/4 US26D ARC SCC KD ASA . . 092443
 3653 ADJ 2-3/8" TO 2-3/4" US26D AUG NC ASA IC020617
3653 ADJ 2-3/8" TO 2-3/4" US26D AUG SCC KD ASA 026836
 3653 ADJ 2-3/8" TO 2-3/4" US26D WTN NC ASA IC007138
3653 ADJ 2-3/8 TO 2-3/4 US26D WTN SCC KD ASA . . 092449
 3653 ADJ 2-3/8" TO 2-3/4" US3 ARC NC ASA IC007198
 3653 ADJ 2-3/8 TO 2-3/4 US3 ARC SCC KD ASA092444
 3653 ADJ 2-3/8" TO 2-3/4" US3 AUG NC ASA IC020559
 3653 ADJ 2-3/8" TO 2-3/4" US3 AUG SCC KD ASA026788
 3653 ADJ 2-3/8" TO 2-3/4" US3 WTN NC ASA IC007173
 3653 ADJ 2-3/8 TO 2-3/4 US3 WTN SCC KD ASA092447
 3653 ADJ 2-3/8" TO 2-3/4" US4 ARC NC ASA IC007197
 3653 ADJ 2-3/8 TO 2-3/4 US4 ARC SCC KD ASA092445
 3653 ADJ 2-3/8" TO 2-3/4" US4 AUG NC ASA IC020489
 3653 ADJ 2-3/8" TO 2-3/4" US4 AUG SCC KD ASA026834
 3653 ADJ 2-3/8" TO 2-3/4" US4 WTN NC ASA IC007162
 3653 ADJ 2-3/8 TO 2-3/4 US4 WTN SCC KD ASA092446

3670

3670 REV 1 ADJ 2-3/8" - 2-3/4" US10 ARC NC ASA IC127307
 3670 REV 1 ADJ 2-3/8" - 2-3/4" US10 ARC SCC KD ASA127308
 3670 REV 1 ADJ 2-3/8" - 2-3/4" US10 AUG NC ASA IC127309
 3670 REV 1 ADJ 2-3/8" - 2-3/4" US10 AUG SCC KD ASA127310
 3670 REV 1 ADJ 2-3/8" - 2-3/4" US10 WTN NC ASA IC127311

3670

3670 REV 1 ADJ 2-3/8 - 2-3/4 US10 WTN SCC KD ASA127312
 3670 REV 1 ADJ 2-3/8" - 2-3/4" US10B ARC NC ASA IC127291
 3670 REV 1 ADJ 2-3/8 - 2-3/4 US10B ARC SCC KD ASA127292
 3670 REV 1 ADJ 2-3/8" - 2-3/4" US10B AUG NC ASA IC127293
 3670 REV1 ADJ 2-3/8" - 2-3/4" US10B AUG SCC KD ASA127294
 3670 REV 1 ADJ 2-3/8" - 2-3/4" US10B WTN NC ASA IC127295
 3670 REV 1 ADJ 2-3/8 - 2-3/4 US10B WTN SCC KD ASA127296
 3670 REV 1 ADJ 2-3/8" - 2-3/4" US26 ARC NC ASA IC127313
 3670 REV 1 ADJ 2-3/8" - 2-3/4" US26 ARC SCC KD ASA127314
 3670 REV 1 ADJ 2-3/8" - 2-3/4" US26 AUG NC ASA IC127315
 3670 REV 1 ADJ 2-3/8" - 2-3/4" US26 AUG SCC KD ASA127316
 3670 REV 1 ADJ 2-3/8" - 2-3/4" US26 WTN NC ASA IC127317
 3670 REV 1 ADJ 2-3/8" - 2-3/4" US26 WTN SCC KD ASA127318
 3670 REV 1 ADJ 2-3/8" - 2-3/4" US26D ARC NC ASA IC127279
 3670 REV 1 ADJ 2-3/8 TO 2-3/4 US26D ARC SCC KD ASA127280
 3670 REV 1 ADJ 2-3/8" - 2-3/4" US26D AUG NC ASA IC127281
 3670 REV1 ADJ 2-3/8" - 2-3/4" US26D AUG SCC KD ASA127282
 3670 REV 1 ADJ 2-3/8" - 2-3/4" US26D WTN NC ASA IC127283
 3670 REV 1 ADJ 2-3/8 - 2-3/4 US26D WTN SCC KD ASA127284
 3670 REV 1 ADJ 2-3/8" - 2-3/4" US3 ARC NC ASA IC127319
 3670 REV 1 ADJ 2-3/8" - 2-3/4" US3 ARC SCC KD ASA127320
 3670 REV 1 ADJ 2-3/8" - 2-3/4" US3 AUG NC ASA IC127321
 3670 REV 1 ADJ 2-3/8" - 2-3/4" US3 AUG SCC KD ASA127322
 3670 REV 1 ADJ 2-3/8" - 2-3/4" US3 WTN NC ASA IC127323
 3670 REV 1 ADJ 2-3/8" - 2-3/4" US3 WTN SCC KD ASA127324
 3670 REV 1 ADJ 2-3/8" - 2-3/4" US4 ARC NC ASA IC127325
 3670 REV 1 ADJ 2-3/8" - 2-3/4" US4 ARC SCC KD ASA127326
 3670 REV 1 ADJ 2-3/8" - 2-3/4" US4 AUG NC ASA IC127327
 3670 REV 1 ADJ 2-3/8" - 2-3/4" US4 AUG SCC KD ASA127328
 3670 REV 1 ADJ 2-3/8" - 2-3/4" US4 WTN NC ASA IC127329
 3670 REV 1 ADJ 2-3/8" - 2-3/4" US4 WTN SCC KD ASA127330

3680

3680 REV 1 ADJ 2-3/8" - 2-3/4" US10 ARC NC ASA IC127331
 3680 REV 1 ADJ 2-3/8" - 2-3/4" US10 ARC SCC KD ASA127332
 3680 REV 1 ADJ 2-3/8" - 2-3/4" US10 AUG NC ASA IC127333
 3680 REV 1 ADJ 2-3/8" - 2-3/4" US10 AUG SCC KD ASA127334
 3680 REV 1 ADJ 2-3/8" - 2-3/4" US10 WTN NC ASA IC127335
 3680 REV 1 ADJ 2-3/8" - 2-3/4" US10 WTN SCC KD ASA127336
 3680 REV 1 ADJ 2-3/8" - 2-3/4" US10B ARC NC ASA IC127297
 3680 REV1 ADJ 2-3/8" - 2-3/4" US10B ARC SCC KD ASA127298
 3680 REV 1 ADJ 2-3/8" - 2-3/4" US10B AUG NC ASA IC127299
 3680 REV1 ADJ 2-3/8" - 2-3/4" US10B AUG SCC KD ASA127300
 3680 REV 1 ADJ 2-3/8" - 2-3/4" US10B WTN NC ASA IC127301
 3680 REV1 ADJ 2-3/8" - 2/3/4" US10B WTN SCC KD ASA127302
 3680 REV 1 ADJ 2-3/8" - 2-3/4" US26 ARC NC ASA IC127337
 3680 REV 1 ADJ 2-3/8" - 2-3/4" US26 ARC SCC KD ASA127338
 3680 REV 1 ADJ 2-3/8" - 2-3/4" US26 AUG NC ASA IC127339
 3680 REV 1 ADJ 2-3/8" - 2-3/4" US26 AUG SCC KD ASA127340
 3680 REV 1 ADJ 2-3/8" - 2-3/4" US26 WTN NC ASA IC127341
 3680 REV 1 ADJ 2-3/8" - 2-3/4" US26 WTN SCC KD ASA127342
 3680 REV 1 ADJ 2-3/8" - 2-3/4" US26D ARC NC ASA IC127285
 3680 REV 1 ADJ 2-3/8 - 2-3/4 US26D ARC SCC KD ASA127286
 3680 REV 1 ADJ 2-3/8" - 2-3/4" US26D AUG NC ASA IC127287
 3680 REV1 ADJ 2-3/8" - 2-3/4" US26D AUG SCC KD ASA127288
 3680 REV 1 ADJ 2-3/8" - 2-3/4" US26D WTN NC ASA IC127289

Items with the price in **bold and red** are Quick Ship Items and ship in 24 hours.



3680

3680 REV 1 ADJ 2-3/8 - 2-3/4 US26D WTN SCC KD ASA . . 127290

3680 REV 1 ADJ 2-3/8" - 2-3/4" US3 ARC NC ASA IC	127343
3680 REV 1 ADJ 2-3/8" - 2-3/4" US3 ARC SCC KD ASA	127344
3680 REV 1 ADJ 2-3/8" TO 2-3/4" US3 AUG NC ASA IC	127345
3680 REV 1 ADJ 2-3/8" - 2-3/4" US3 AUG SCC KD ASA	127346
3680 REV 1 ADJ 2-3/8" - 2-3/4" US3 WTN NC ASA IC	127347
3680 REV 1 ADJ 2-3/8" - 2-3/4" US3 WTN SCC KD ASA	127348
3680 REV 1 ADJ 2-3/8" - 2-3/4" US4 ARC NC ASA IC	127349
3680 REV 1 ADJ 2-3/8" - 2-3/4" US4 ARC SCC KD ASA	127350
3680 REV 1 ADJ 2-3/8" - 2-3/4" US4 AUG NC ASA IC	127351
3680 REV 1 ADJ 2-3/8" - 2-3/4" US4 AUG SCC KD ASA	127352
3680 REV 1 ADJ 2-3/8" - 2-3/4" US4 WTN NC ASA IC	127353
3680 REV 1 ADJ 2-3/8" 1 2-3/4" US4 WTN SCC KD ASA	127354

3710

3710 2-3/4" US10 ARC NC TEE IC005277
3710 2-3/4" US10 ARC SCC KD TEE005365
3710 2-3/4" US10 AUG NC TEE IC005268
3710 2-3/4" US10 AUG SCC KD TEE005328
3710 2-3/4" US10 WTN NC TEE IC005287
3710 2-3/4" US10 WTN SCC KD TEE005663
3710 2-3/4" US10B ARC NC TEE IC005275
3710 2-3/4" US10B ARC SCC KD TEE005363
3710 2-3/4" US10B AUG NC TEE IC005267
3710 2-3/4" US10B AUG SCC KD TEE005316
3710 2-3/4" US10B WTN NC TEE IC005242
3710 2-3/4" US10B WTN SCC KD TEE005656
3710 2-3/4" US26 ARC NC TEE IC005274
3710 2-3/4" US26 ARC SCC KD TEE005355
3710 2-3/4" US26 AUG NC TEE IC005263
3710 2-3/4" US26 AUG SCC KD TEE005303
3710 2-3/4" US26 WTN NC TEE IC005284
3710 2-3/4" US26 WTN SCC KD TEE005651
3710 2-3/4" US26D ARC NC TEE IC005273
3710 2-3/4" US26D ARC SCC KD TEE005339
3710 2-3/4" US26D AUG NC TEE IC005262
3710 2-3/4" US26D AUG SCC KD TEE005302
3710 2-3/4" US26D WTN NC TEE IC005283
3710 2-3/4" US26D WTN SCC KD TEE005623
3710 2-3/4" US3 ARC NC TEE IC005282
3710 2-3/4" US3 ARC SCC KD TEE005369
3710 2-3/4" US3 AUG NC TEE IC005272
3710 2-3/4" US3 AUG SCC KD TEE005336
3710 2-3/4" US3 WTN NC TEE IC005290
3710 2-3/4" US3 WTN SCC KD TEE005684
3710 2-3/4" US4 ARC NC TEE IC005281
3710 2-3/4" US4 ARC SCC KD TEE005368
3710 2-3/4" US4 AUG NC TEE IC005271
3710 2-3/4" US4 AUG SCC KD TEE005335
3710 2-3/4" US4 WTN NC TEE IC005289
3710 2-3/4" US4 WTN SCC KD TEE005680

3753

3753 2-3/4" US10 ARC NC TEE IC005444
3753 2-3/4" US10 ARC SCC KD TEE005594
3753 2-3/4" US10 AUG NC TEE IC005424

Items with the price in **bold and red** are Quick Ship Items and ship in 24 hours.

3753

3753 2-3/4" US10 AUG SCC KD TEE005542
3753 2-3/4" US10 WTN NC TEE IC005474
3753 2-3/4" US10 WTN SCC KD TEE005708
3753 2-3/4" US10B ARC NC TEE IC005442
3753 2-3/4" US10B ARC SCC KD TEE005580
3753 2-3/4" US10B AUG NC TEE IC005423
3753 2-3/4" US10B AUG SCC KD TEE005541
3753 2-3/4" US10B WTN NC TEE IC005468
3753 2-3/4" US10B WTN SCC KD TEE005702
3753 2-3/4" US26 ARC NC TEE IC005441
3753 2-3/4" US26 ARC SCC KD TEE005578
3753 2-3/4" US26 AUG NC TEE IC005399
3753 2-3/4" US26 AUG SCC KD TEE005540
3753 2-3/4" US26 WTN NC TEE IC005458
3753 2-3/4" US26 WTN SCC KD TEE005701
3753 2-3/4" US26D ARC NC TEE IC005440
3753 2-3/4" US26D ARC SCC KD TEE005567
3753 2-3/4" US26D AUG NC TEE IC005390
3753 2-3/4" US26D AUG SCC KD TEE005525
3753 2-3/4" US26D WTN NC TEE IC005454
3753 2-3/4" US26D WTN SCC KD TEE	115187
3753 2-3/4" US3 ARC NC TEE IC005453
3753 2-3/4" US3 ARC SCC KD TEE005610
3753 2-3/4" US3 AUG NC TEE IC005431
3753 2-3/4" US3 AUG SCC KD TEE005547
3753 2-3/4" US3 WTN NC TEE IC005500
3753 2-3/4" US3 WTN SCC KD TEE005715
3753 2-3/4" US4 ARC NC TEE IC005446
3753 2-3/4" US4 ARC SCC KD TEE005598
3753 2-3/4" US4 AUG NC TEE IC005427
3753 2-3/4" US4 AUG SCC KD TEE005544
3753 2-3/4" US4 WTN NC TEE IC005499
3753 2-3/4" US4 WTN SCC KD TEE005712

3810

3810 ESC US26D ARC001029
3810 ESC US26D ARB001134
3810 ESC US26D WLM001118
3810 ESC US26D WLB001110
3810 ESC US26D AUG141107
3810 ESC US26D WTN001070
3810 ESC US26D WTB001039
3810 ESC US32D ARC101244
3810 ESC US32D ARS104200
3810 ESC US32D WLM101245
3810 ESC US32D WLS104202
3810 ESC US32D WTN101242
3810 ESC US32D WTS104198
3810 SECT US26D ARC001035
3810 SECT US26D ARB001094
3810 SECT US26D WLM001132
3810 SECT US26D WLB001113
3810 SECT US26D AUG121368
3810 SECT US26D AUB131854
3810 SECT US26D WTN001078
3810 SECT US26D WTB001050

3810

3810 SECT US32D ARC.....	101243
3810 SECT US32D ARS.....	104199
3810 SECT US32D WLM.....	100652
3810 SECT US32D WLS.....	104201
3810 SECT US32D AUG.....	142537
3810 SECT US32D WTN.....	101241
3810 SECT US32D WTS.....	104197

3817

3817 ESC 26D ARC.....	101383
3817 ESC 26D WLM.....	101384
3817 ESC 26D WTN.....	101380
3817 ESC 32D ARC.....	101392
3817 ESC US32D ARS.....	143086
3817 ESC 32D WLM.....	101394
3817 ESC 32D WTN.....	101387
3817 SECT US26 AUG.....	123073
3817 SECT 26D ARC.....	101382
3817 SECT 26D WLM.....	101385
3817 SECT US26D AUG.....	122764
3817 SECT 26D WTN.....	101379
3817 SECT 32D ARC.....	101388
3817 SECT 32D ARS.....	118466
3817 SECT 32D WLM.....	101393
3817 SECT 32D WTN.....	101386

3827

3827 ESC 26D ARC.....	101398
3827 ESC 26D WLM.....	101399
3827 ESC 26D AUG.....	124256
3827 ESC 26D WTN.....	101396
3827 ESC 32D ARC.....	101404
3827 ESC 32D WLM.....	101412
3827 ESC 32D WTN.....	101402
3827 SECT 26D ARC.....	101397
3827 SECT 26D WLM.....	101400
3827 SECT US26D AUG.....	122765
3827 SECT 26D WTN.....	101395
3827 SECT 32D ARC.....	101403
3827 SECT 32D ARS.....	118447
3827 SECT 32D WLM.....	101411
3827 SECT US32D WLS.....	110988
3827 SECT 32D WTN.....	101401
3827 SECT US32D WTS.....	141202

3840

3840 ESC US26D ARC.....	.000999
3840 ESC US26D ARB.....	.000997
3840 ESC US26D WLM.....	.000992
3840 ESC US26D WLB.....	.000987
3840 ESC US26D AUG.....	118525
3840 ESC US26D WTN.....	.001023
3840 ESC US26D WTB.....	.001022
3840 ESC US32D ARC.....	101339
3840 ESC US32D ARS.....	104206
3840 ESC US32D WLM.....	101340
3840 ESC US32D WLS.....	104208

3840

3840 ESC US32D WTN.....	101337
3840 ESC US32D WTS.....	104204
3840 SECT US26D ARC.....	.001000
3840 SECT US26D ARB.....	.000998
3840 SECT US26D WLM.....	.000994
3840 SECT US26D WLB.....	.000988
3840 SECT US26D AUG.....	122766
3840 SECT US26D WTN.....	001098
3840 SECT US26D WTB.....	.001011
3840 SECT US32D ARC.....	101338
3840 SECT US32D ARS.....	104205
3840 SECT US32D WLM.....	100653
3840 SECT US32D WLB.....	104116
3840 SECT US32D WLS.....	104207
3840 SECT US32D AUS.....	140374
3840 SECT US32D AUG.....	131036
3840 SECT US32D WTN.....	101336
3840 SECT US32D WTS.....	104203

3844

3844 ESC US26D WTN.....	135035
3844 ESC US32D WTN.....	135357
3844 SECT US26D ARC.....	142322
3844 SECT US26D WTN.....	134987
3844 SECT US26D WTS.....	142453
3844 SECT US32D WTN.....	135355

3850

3850 ESC US26D ARC.....	100433
3850 ESC US26D ARC FULL6 SCC KD.....	102922
3850 ESC US26D ARB.....	103654
3850 ESC US26D ARB FULL6 SCC KD.....	103631
3850 ESC US26D WLM.....	100434
3850 ESC US26D WLM FULL6 SCC KD.....	102924
3850 ESC US26D WLB.....	103655
3850 ESC US26D WLB FULL6 SCC KD.....	103632
3850 ESC US26D WTN.....	100432
3850 ESC US26D WTN FULL6 SCC KD.....	102920
3850 ESC US26D WTB.....	103656
3850 ESC US26D WTB FULL6 SCC KD.....	103633
3850 ESC US32D ARC.....	101236
3850 ESC US32D ARC FULL6 SCC KD.....	102969
3850 ESC US32D ARS.....	103657
3850 ESC US32D ARS FULL6 SCC KD.....	103658
3850 ESC US32D WLM.....	101239
3850 ESC US32D WLM FULL6 SCC KD.....	102971
3850 ESC US32D WLS.....	103659
3850 ESC US32D WLS FULL6 SCC KD.....	103660
3850 ESC US32D WTN.....	101232
3850 ESC US32D WTN FULL6 SCC KD.....	102967
3850 ESC US32D WTS.....	103746
3850 ESC US32D WTS FULL6 SCC KD.....	103661
3850 SECT US26D ARC.....	.000965
3850 SECT US26D ARC FULL6 SCC KD.....	102921
3850 SECT US26D ARB.....	103340
3850 SECT US26D ARB FULL6 SCC KD.....	103341
3850 SECT US26D WLM.....	.000959

Items with the price in **bold and red** are Quick Ship Items and ship in 24 hours.



3850

3850 SECT US26D WLM FULL6 SCC KD	102923
3850 SECT US26D WLB	103634
3850 SECT US26D WLB FULL6 SCC KD	103635
3850 SECT US26D AUG	136008
3850 SECT US26D AUG FULL6 SCC KD	122972
3850 SECT US26D WTN	000972
3850 SECT US26D WTN FULL6 SCC KD	102925
3850 SECT US26D WTB	103338
3850 SECT US26D WTB FULL6 SCC KD	103339
3850 SECT US32D ARC	101234
3850 SECT US32D ARC FULL6 SCC KD	102968
3850 SECT US32D ARS	103360
3850 SECT US32D ARS FULL6 SCC KD	103361
3850 SECT US32D WLM	101238
3850 SECT US32D WLM FULL6 SCC KD	102970
3850 SECT US32D WLS	103662
3850 SECT US32D WLS FULL6 SCC KD	103663
3850 SECT US32D AUG FULL6 SCC KD	121583
3850 SECT US32D WTN	101230
3850 SECT US32D WTN FULL6 SCC KD	102966
3850 SECT US32D WTS	103358
3850 SECT US32D WTS FULL6 SCC KD	103359

3853

3853 ESC US26D ARC REV 1	115862
3853 ESC US26D ARC FULL6 SCC KD REV 1	115630
3853 ESC US26D ARB REV 1	115866
3853 ESC US26D ARB FULL6 SCC KD REV 1	115867
3853 ESC US26D WLM REV 1	115868
3853 ESC US26D WLM FULL6 SCC KD REV 1	115631
3853 ESC US26D WLB REV 1	115871
3853 ESC US26D WLB FULL6 SCC KD REV 1	115872
3853 ESC US26D AUG FULL6 SCC KD REV 1	125154
3853 ESC US26D WTN REV 1	115873
3853 ESC US26D WTN FULL6 SCC KD	115632
3853 ESC US26D WTB REV 1	115875
3853 ESC US26D WTB FULL6 SCC KD REV 1	115876
3853 ESC US32D ARC REV 1	115878
3853 ESC US32D ARC FULL6 SCC KD REV 1	115880
3853 ESC US32D ARS REV 1	115881
3853 ESC US32D ARS FULL6 SCC KD REV 1	115882
3853 ESC US32D WLM REV 1	115883
3853 ESC US32D WLM FULL6 SCC KD REV 1	115885
3853 ESC US32D WLS REV 1	115890
3853 ESC US32D WLS FULL6 SCC KD REV 1	115891
3853 ESC US32D WTN REV 1	115892
3853 ESC US32D WTN FULL6 SCC KD REV 1	115894
3853 ESC US32D WTS REV 1	115895
3853 ESC US32D WTS FULL6 SCC KD REV 1	115896
3853 SECT US26D ARC REV 1	115900
3853 SECT US26D ARC FULL6 SCC KD	115902
3853 SECT US26D ARB REV 1	115903
3853 SECT US26D ARB FULL6 SCC KD REV 1	115904
3853 SECT US26D ARS FULL6 SCC KD (REV.1)	139693
3853 SECT US26D WLM REV 1	115905
3853 SECT US26D WLM FULL6 SCC KD REV 1	115633

Items with the price in **bold and red** are Quick Ship Items and ship in 24 hours.

3853

3853 SECT US26D WLB REV 1	115907
3853 SECT US26D WLB FULL6 SCC KD REV 1	115908
3853 SECT US26D AUG REV 1	131092
3853 SECT US26D AUG FULL6 SCC KD REV.1	120892
3853 SECT US26D WTN REV 1	115909
3853 SECT US26D WTN FULL6 SCC KD	115634
3853 SECT US26D WTB REV 1	115911
3853 SECT US26D WTB FULL6 SCC KD REV 1	115912
3853 SECT US32D ARC REV 1	115914
3853 SECT US32D ARC FULL6 SCC KD REV 1	115916
3853 SECT US32D ARS REV 1	115917
3853 SECT US32D ARS FULL6 SCC KD (REV.1)	115918
3853 SECT US32D WLM REV 1	115919
3853 SECT US32D WLM FULL6 SCC KD REV 1	115921
3853 SECT US32D WLS REV 1	115922
3853 SECT US32D WLS FULL6 SCC KD REV 1	115923
3853 SECT US32D AUG FULL6 SCC KD REV.1	121377
3853 SECT US32D AUS REV 1	144317
3853 SECT US32D AUS FULL6 SCC KD REV 1	144318
3853 SECT US32D WTN REV 1	115924
3853 SECT US32D WTN FULL6 SCC KD REV 1	115926
3853 SECT US32D WTS REV 1	115927
3853 SECT US32D WTS FULL6 SCC KD REV 1	115928

3857

3857 ESC US26D ARC REV 1	123411
3857 ESC US26D ARC FULL6 SCC KD REV 1	123830
3857 ESC US26D ARB REV 1	123832
3857 ESC US26D ARB FULL6 SCC KD REV 1	123833
3857 ESC US26D WLM REV 1	123840
3857 ESC US26D WLM FULL6 SCC KD REV 1	123868
3857 ESC US26D WLB REV 1	123869
3857 ESC US26D WLB FULL6 SCC KD REV 1	123870
3857 ESC US26D AUG	118526
3857 ESC US26D WTN REV 1	123871
3857 ESC US26D WTN FULL6 SCC KD REV 1	123872
3857 ESC US26D WTB REV 1	123873
3857 ESC US26D WTB FULL6 SCC KD REV 1	123874
3857 ESC US32D ARC REV 1	123875
3857 ESC US32D ARC FULL6 SCC KD REV 1	123876
3857 ESC US32D ARS REV 1	123879
3857 ESC US32D ARS FULL6 SCC KD REV 1	123880
3857 ESC US32D WLM REV 1	123881
3857 ESC US32D WLM FULL6 SCC KD REV 1	123882
3857 ESC US32D WLS REV 1	123932
3857 ESC US32D WLS FULL6 SCC KD REV 1	123933
3857 ESC US32D WTN REV 1	123935
3857 ESC US32D WTN FULL6 SCC KD REV 1	123936
3857 ESC US32D WTS REV 1	123937
3857 ESC US32D WTS FULL6 SCC KD REV 1	123938
3857 SECT US26D ARC REV 1	123939
3857 SECT US26D ARC FULL6 SCC KD REV 1	123940
3857 SECT US26D ARB REV 1	123941
3857 SECT US26D ARB FULL6 SCC KD REV 1	123942
3857 SECT US26D WLM REV 1	123980
3857 SECT US26D WLM FULL6 SCC KD REV 1	123981

3857

3857 SECT US26D WLB REV 1	123982
3857 SECT US26D WLB FULL6 SCC KD REV 1	123983
3857 SECT US26D AUG FULL6 SCC KD REV 1	139898
3857 SECT US26D WTN REV 1	123984
3857 SECT US26D WTN FULL6 SCC KD REV 1	123985
3857 SECT US26D WTB REV 1	123986
3857 SECT US26D WTB FULL6 SCC KD REV 1	123987
3857 SECT US32D ARC REV 1	123989
3857 SECT US32D ARC FULL6 SCC KD REV 1	123991
3857 SECT US32D ARS REV 1	123992
3857 SECT US32D ARS FULL6 SCC KD REV 1	123993
3857 SECT US32D ARS ICFULL7 NC REV1	145327
3857 SECT US32D WLM REV 1	123994
3857 SECT US32D WLM FULL6 SCC KD REV 1	123995
3857 SECT US32D WLS REV 1	124068
3857 SECT US32D WLS FULL6 SCC KD REV 1	124069
3857 SECT US32D AUG FULL6 SCC KD REV 1	131477
3857 SECT US32D WTN REV 1	124070
3857 SECT US32D WTN FULL6 SCC KD REV 1	124071
3857 SECT US32D WTS REV 1	124072
3857 SECT US32D WTS FULL6 SCC KD REV 1	124073

3870

3870 ESC US26D ARC	100370
3870 ESC US26D ARC FULL6 SCC KD	102930
3870 ESC US26D ARB	103700
3870 ESC US26D ARB FULL6 SCC KD	103642
3870 ESC US26D WLM	100374
3870 ESC US26D WLM FULL6 SCC KD	102932
3870 ESC US26D WLB	103701
3870 ESC US26D WLB FULL6 SCC KD	103644
3870 ESC US26D AUB	124409
3870 ESC US26D WTN	100365
3870 ESC US26D WTN FULL6 SCC KD	102928
3870 ESC US26D WTB	103702
3870 ESC US26D WTB FULL6 SCC KD	103645
3870 ESC US32D ARC	101187
3870 ESC US32D ARC FULL6 SCC KD	102937
3870 ESC US32D ARS	103703
3870 ESC US32D ARS FULL6 SCC KD	103704
3870 ESC US32D WLM	101191
3870 ESC US32D WLM FULL6 SCC KD	102939
3870 ESC US32D WLS	103705
3870 ESC US32D WLS FULL6 SCC KD	103706
3870 ESC US32D WTN	101182
3870 ESC US32D WTN FULL6 SCC KD	102934
3870 ESC US32D WTS	103707
3870 ESC US32D WTS FULL6 SCC KD	103708
3870 SECT US26D ARC	100368
3870 SECT US26D ARC FULL6 SCC KD	102929
3870 SECT US26D ARB	103332
3870 SECT US26D ARB FULL6 SCC KD	103333
3870 SECT US26D WLM	100372
3870 SECT US26D WLM FULL6 SCC KD	102931
3870 SECT US26D WLB	103646
3870 SECT US26D WLB FULL6 SCC KD	103647

3870

3870 SECT US26D AUG	143782
3870 SECT US26D AUG FULL6 SCC KD	121680
3870 SECT US26D WTN	100362
3870 SECT US26D WTN FULL6 SCC KD	102927
3870 SECT US26D WTB	103330
3870 SECT US26D WTB FULL6 SCC KD	103331
3870 SECT US32D ARC	101185
3870 SECT US32D ARC FULL6 SCC KD	102936
3870 SECT US32D ARS	103348
3870 SECT US32D ARS FULL6 SCC KD	103357
3870 SECT US32D WLM	101189
3870 SECT US32D WLM FULL6 SCC KD	102938
3870 SECT US32D WLS	103709
3870 SECT US32D WLS FULL6 SCC KD	103710
3870 SECT US32D WTN	101181
3870 SECT US32D WTN FULL6 SCC KD	102933
3870 SECT US32D WTS	103346
3870 SECT US32D WTS FULL6 SCC KD	103347

3880

3880 ESC US26D ARC	100447
3880 ESC US26D ARC FULL6 SCC KD	102981
3880 ESC US26D ARB	103711
3880 ESC US26D ARB FULL6 SCC KD	103648
3880 ESC US26D WLM	100444
3880 ESC US26D WLM FULL6 SCC KD	102983
3880 ESC US26D WLB	103712
3880 ESC US26D WLB FULL6 SCC KD	103649
3880 ESC US26D AUG	118527
3880 ESC US26D AUG FULL6 SCC KD	136173
3880 ESC US26D WTN	100446
3880 ESC US26D WTN FULL6 SCC KD	102979
3880 ESC US26D WTB	103713
3880 ESC US26D WTB FULL6 SCC KD	103650
3880 ESC US32D ARC	101347
3880 ESC US32D ARC FULL6 SCC KD	102987
3880 ESC US32D ARS	103714
3880 ESC US32D ARS FULL6 SCC KD	103715
3880 ESC US32D WLM	101350
3880 ESC US32D WLM FULL6 SCC KD	102989
3880 ESC US32D WLS	103716
3880 ESC US32D WLS FULL6 SCC KD	103717
3880 ESC US32D WTN	101343
3880 ESC US32D WTN FULL6 SCC KD	102985
3880 ESC US32D WTS	103718
3880 ESC US32D WTS FULL6 SCC KD	103719
3880 SECT US26D ARC	100438
3880 SECT US26D ARC FULL6 SCC KD	102980
3880 SECT US26D ARB	103344
3880 SECT US26D ARB FULL6 SCC KD	103345
3880 SECT US26D WLM	100441
3880 SECT US26D WLM FULL6 SCC KD	102982
3880 SECT US26D WLB	103651
3880 SECT US26D WLB FULL6 SCC KD	103652
3880 SECT US26D AUG	122767
3880 SECT US26D AUG FULL6 SCC KD	121692

Items with the price in **bold and red** are Quick Ship Items and ship in 24 hours.



3880

3880 SECT US26D WTN	100435
3880 SECT US26D WTN FULL6 AR1 KD	109917
3880 SECT US26D WTB	103342
3880 SECT US26D WTB FULL6 SCC KD	103343
3880 SECT US32D ARC	101345
3880 SECT US32D ARC FULL6 SCC KD	102986
3880 SECT US32D ARS	103355
3880 SECT US32D ARS FULL6 SCC KD	103356
3880 SECT US32D WLM	101349
3880 SECT US32D WLM FULL6 SCC KD	102988
3880 SECT US32D WLS	103720
3880 SECT US32D WLS FULL6 SCC KD	103721
3880 SECT US32D AUG FULL6 SCC KD	124258
3880 SECT US32D WTN	101341
3880 SECT US32D WTN FULL6 SCC KD	102984
3880 SECT US32D WTS	103353
3880 SECT US32D WTS FULL6 SCC KD	103354

3881

3881 ESC US26D ARC REV 1	115636
3881 ESC US26D ARC FULL6 SCC KD REV 1	115637
3881 ESC US26D ARB REV 1	115638
3881 ESC US26D ARB FULL6 SCC KD REV 1	115640
3881 ESC US26D WLM REV 1	115641
3881 ESC US26D WLM FULL6 SCC KD REV 1	115642
3881 ESC US26D WLB REV 1	115643
3881 ESC US26D WLB FULL6 SCC KD REV 1	115645
3881 ESC US26D AUB REV 1	146081
3881 ESC US26D WTN REV 1	115646
3881 ESC US26D WTN FULL6 SCC KD REV 1	115647
3881 ESC US26D WTB REV 1	115648
3881 ESC US26D WTB FULL6 SCC KD REV 1	115649
3881 ESC US32D ARC REV 1	115650
3881 ESC US32D ARC FULL6 SCC KD REV 1	115651
3881 ESC US32D ARS REV 1	115652
3881 ESC US32D ARS FULL6 SCC KD REV 1	115653
3881 ESC US32D WLM REV 1	115654
3881 ESC US32D WLM FULL6 SCC KD REV 1	115655
3881 ESC US32D WLS REV 1	115681
3881 ESC US32D WLS FULL6 SCC KD REV 1	115682
3881 ESC US32D WTN REV 1	115683
3881 ESC US32D WTN FULL6 SCC KD REV 1	115684
3881 ESC US32D WTS REV 1	115685
3881 ESC US32D WTS FULL6 SCC KD REV 1	115686
3881 SECT US26D ARC REV 1	115687
3881 SECT US26D ARC FULL6 SCC KD REV 1	115689
3881 SECT US26D ARB REV 1	115690
3881 SECT US26D ARB FULL6 SCC KD REV 1	115691
3881 SECT US26D WLM REV 1	115692
3881 SECT US26D WLM FULL6 SCC KD REV 1	115693
3881 SECT US26D WLB REV 1	115694
3881 SECT US26D WLB FULL6 SCC KD REV 1	115695
3881 SECT US26D AUG REV.1	123601
3881 SECT US26D AUG FULL6 SCC KD REV 1	130006
3881 SECT US26D WTN REV 1	115696
3881 SECT US26D WTN FULL6 SCC KD REV 1	115697

3881

3881 SECT US26D WTB REV 1	115763
3881 SECT US26D WTB FULL6 SCC KD REV 1	115764
3881 SECT US3 WTN REV. 1	128042
3881 SECT US3 WTN FULL6 SCC KD REV 1	136709
3881 SECT US32D ARC REV 1	115765
3881 SECT US32D ARC FULL6 SCC KD REV 1	115766
3881 SECT US32D ARS REV 1	115767
3881 SECT US32D ARS FULL6 SCC KD REV 1	115768
3881 SECT US32D WLM REV 1	115769
3881 SECT US32D WLM FULL6 SCC KD REV 1	115770
3881 SECT US32D WLS REV 1	115771
3881 SECT US32D WLS FULL6 SCC KD REV 1	115772
3881 SECT US32D AUG FULL6 SCC KD REV1	146044
3881 SECT US32D WTN REV 1	115773
3881 SECT US32D WTN FULL6 SCC KD REV 1	115774
3881 SECT US32D WTS REV 1	115775
3881 SECT US32D WTS FULL6 SCC KD REV 1	115776

Items with the price in **bold and red** are Quick Ship Items and ship in 24 hours.



One Family. One Brand. One Vision.™

www.hagerco.com

TABLE OF CONTENTS

A		Extra Clearance, 5300 Series.....	18
Arms, 5100 Series		Extra Heavy Duty Parallel Arm, 5100 Series.....	7
Main Arm Assembly.....	6	Hold Open Parallel Arm, 5200 Series.....	12
Extra Heavy Duty Parallel.....	6	Hold Open Parallel Arm, 5300 Series.....	17
Extra Heavy Duty Hold Open	7	Parallel Arm, 5100 Series.....	7
Extra Heavy Duty Stop	7	Parallel Arm, 5200 Series.....	11
Extra Heavy Duty Hold Open Stop.....	8	Parallel Arm, 5300 Series.....	16
Extra Heavy Duty Hold Open Cushion Stop	8	Parallel Arm, 5400 Series.....	20
Extra Heavy Duty Cushion Stop	8		
Standard Hold Open	6	C	
Arms, 5200 Series		Closers	
Main Arm Assembly.....	11	5100 Series, Grade 1	5
Extra Heavy Duty Hold Open Cushion Stop	13	5200 Series, Grade 1	10
Extra Heavy Duty Cushion Stop	13	5300 Series, Grade 1	15
Extra Heavy Duty.....	12	5400 Series, Grade 2	19
Extra Heavy Duty Hold Open	12	Covers	
Extra Heavy Duty Hold Open Stop.....	12	5100 Series, Full Plastic.....	6
Extra Heavy Duty Stop	12	5100 Series, Metal	8
Standard Hold Open	11	5200 Series, Full Plastic.....	11
Arms, 5300 Series		5200 Series, Slim Line Plastic.....	13
Main Arm Assembly.....	16	5200 Series, Metal	13
Extra Heavy Duty.....	17	5300 Series, Full Plastic.....	16
Extra Heavy Duty Hold Open	17		
Extra Heavy Duty Hold Open Stop.....	17	D	
Extra Heavy Duty Stop	17	Drop Plates	
Extra Heavy Duty Hold Open Cushion Stop	18	5100 Series, Regular Arm	7
Extra Heavy Duty Cushion Stop	18	5100 Series, Low Clearance.....	7
Standard Hold Open	16	5100 Series, Parallel Arm.....	7
Arms, 5400 Series		5100 Series, Top Jamb.....	7
Main Arm Assembly.....	20	5200 Series, Top Jamb, Narrow Top Rail.....	12
		5200 Series, Narrow Top Rail	13
		5200 Series, Top Jamb, Parallel Arm	13
		5200 Series, Parallel Arm.....	13
		5300 Series, Narrow Rail, Parallel Arm.....	17
		5300 Series, Low Clearance.....	17
		5300 Series, OH Holder, Narrow.....	17
		E	
		Electromagnetic Door Holders & Accessories	
		Accessories	22-23
		Floor Mount (Double Door)	21
		Floor Mount (Single Door).....	21
		Flush Mount	21
		Recessed Mount.....	21
		Surface Mount.....	21
		H	
		High Security Package, 5100 Series.....	6
		How To Order	3-4



Door Controls

	L	
Lead Times		2
Long Rod and Shoe, 5100 Series.....		7
Long Rod and Shoe, 5200 Series.....		12
Long Rod and Shoe, 5300 Series.....		17
	O	
Overhead Door Holders and Stops		24-28
	P	
Pinion Cap		
5200 Series		12
5300 Series		16
5400 Series		20
	Q	
Quick Ship.....		2

	S	
Screw Packs		
5100 Series		6-8
5200 Series		11-12
5300 Series		16-17
5400 Series		20
Spring Cushion Kit		8, 13, 18
	T	
Track Arms		
5100 Series		6, 8-9
5200 Series		11, 13-14
5300 Series		16, 18

INTRODUCTION

Hager door controls offer architects, contractors, and building owners a superior product with proven reliability. In fact, our 5100, 5200, and 5300 Series Grade 1 models are the only closers in the industry that are both BHMA certified and backed by a lifetime warranty. That makes them a no-risk choice for virtually any building type.

With Hager, you get door controls that are packaged with everything needed for quick installation, regardless of the application. Hager door closers are tri-packed for mounting three ways: parallel arm, regular arm, and top jamb. They are non-handed, packaged with a parallel arm bracket and thru-bolts at no extra charge, and adjustable for various door sizes.

Quick Ship

Products denoted with **red and bold** pricing are available to order through the Quick Ship program and ship within 24 hours. When ordering these products please visit www.hagerco.com and log in to MyHager to access the 'Quick Ship' portal. Due to the promptness of the fulfillment process, Quick Ship orders are non-cancellable.

Lead Times

Stock items will typically ship in five working days or less from the order entry date. Made-to-order items will typically ship in 15 working days depending on seasonal volume and order complexity. Special orders including industrials, special machining, and large quantities may need to be scheduled. The anticipated ship date will be included with each order acknowledgement. Please contact Customer Service if product availability is in question.

New Finish

Painted flat black finish (BHMA 693) is now available. Use BLK to designate finish. Extended lead time and MOQ may apply.

Cancellation Notification

Cancellation for made-to-order items must be communicated within 48 hours of order placement.

HOW TO ORDER

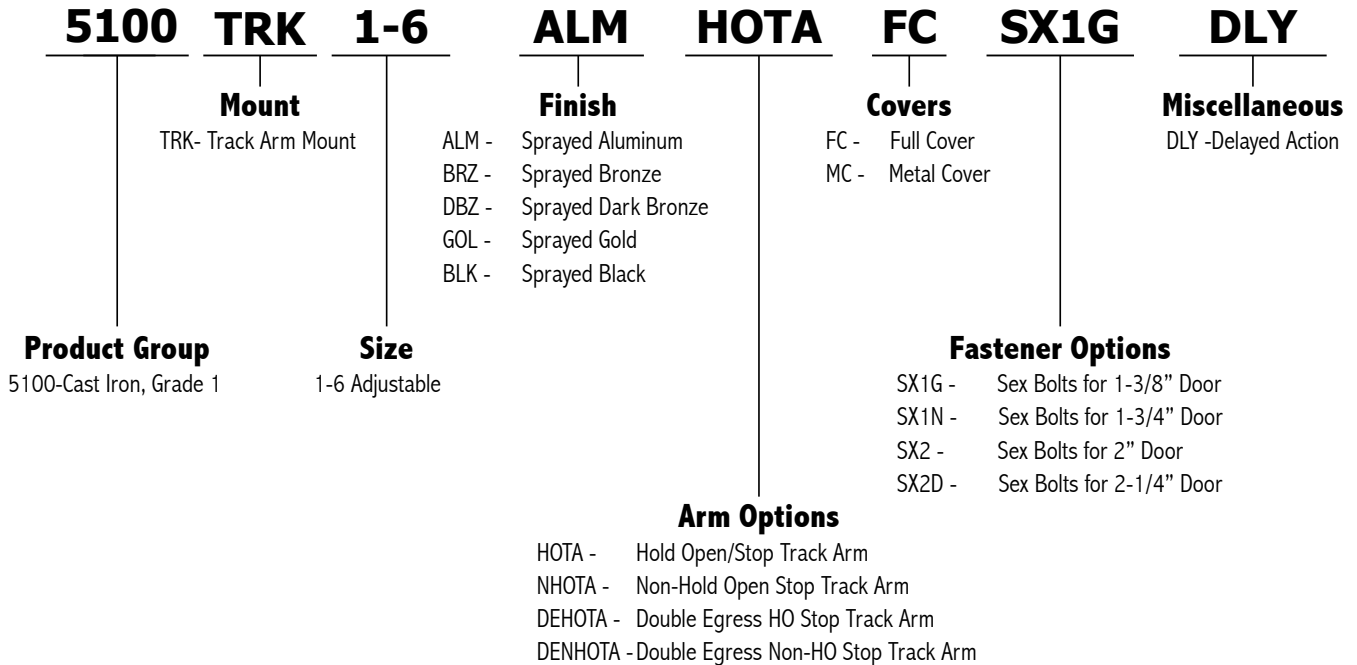

HOW TO ORDER

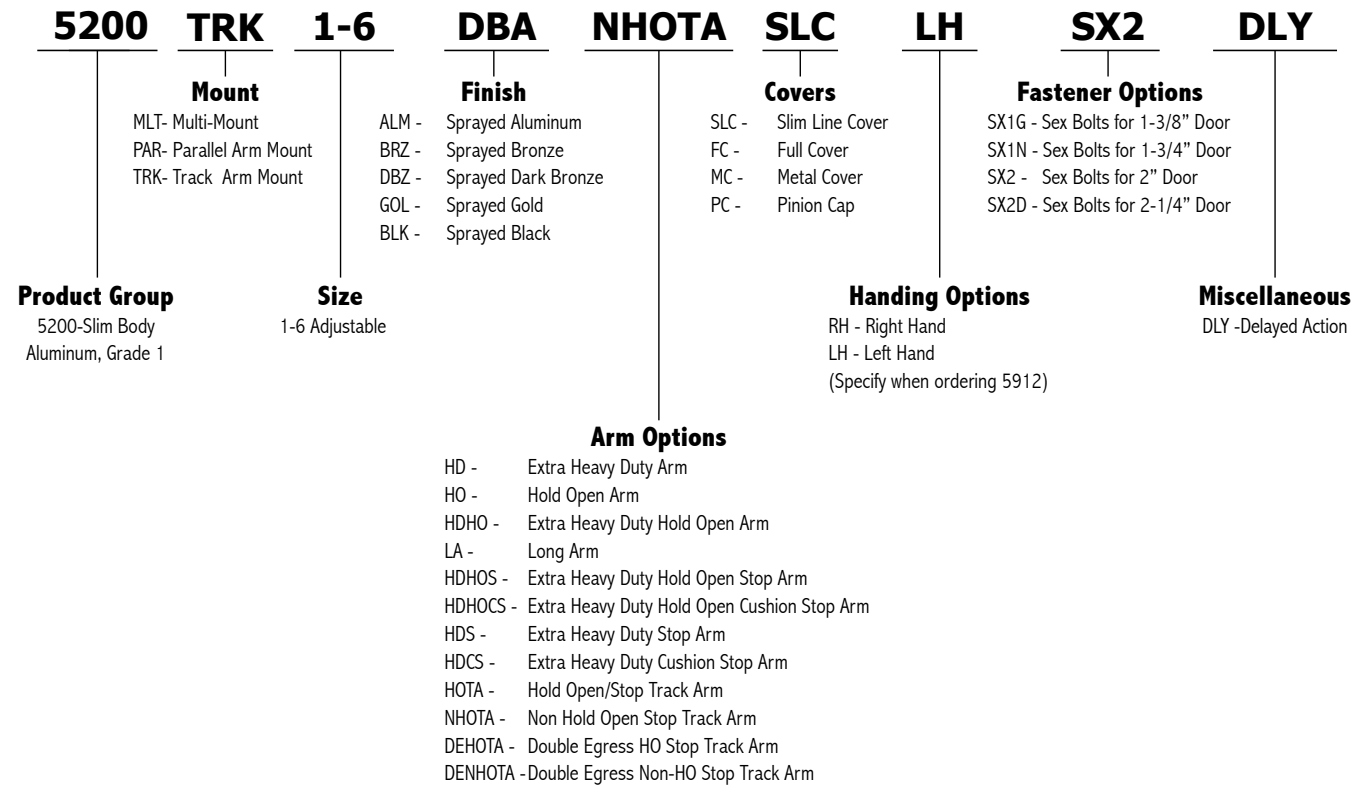

Door Controls

HOW TO ORDER

5300	TRK	1-6	DBZ	HOTA	FC	RH	SX1G	DLY
	Mount MLT- Multi-Mount PAR- Parallel Arm Mount TRK- Track Arm Mount		Finish ALM - Sprayed Aluminum BRZ - Sprayed Bronze DBZ - Sprayed Dark Bronze GOL - Sprayed Gold BLK - Sprayed Black		Covers FC - Full Cover PC - Pinion Cap		Fastener Options SX1G - Sex Bolts for 1-3/8" Door SX1N - Sex Bolts for 1-3/4" Door SX2 - Sex Bolts for 2" Door SX2D - Sex Bolts for 2-1/4" Door	
Product Group 5300 - Aluminum, Grade 1		Size 1-6 Adjustable				Handing Options RH - Right Hand LH - Left Hand (Specify when ordering 5912)		Miscellaneous DLY -Delayed Action
			Arm Options HD - Extra Heavy Duty Arm HO - Hold Open Arm HDHO - Extra Heavy Duty Hold Open Arm LA - Long Arm HDHOS - Extra Heavy Duty Hold Open Stop Arm HDHOCS - Extra Heavy Duty Hold Open Cushion Stop Arm HDS - Extra Heavy Duty Stop Arm HDCS - Extra Heavy Duty Cushion Stop Arm HOTA - Hold Open/Stop Track Arm NHOTA - Non Hold Open Stop Track Arm					





Description	Finish	2018 List	Stock No.	Case Qty.	Box Qty.
5100 Series	ALM	315.65	126470	4	1
Grade 1	BRZ	315.65	126473		
Adjustable sizes 1-6	DBZ	315.65	126472		
	GOL	315.65	126474		

ADA (Barrier Free) Door Closers:

Any certified BHMA/ANSI A156.4 door closer, regardless of manufacturer, that is installed and adjusted based on ADA or other reduced opening force requirements may not provide sufficient power to reliably close and latch a door.

If arms are ordered separately, there will be a significant difference in price than if purchased with a closer as a complete assembly. Adders are listed below. Add the list price of the option to the list price of the closer and take standard discounts.

Delayed Action Valve **17.20**

Lead Lined Cover **108.15**

Check with factory for pricing and availability of plated products. **POA**











Closers with non-standard arms

5100 Series 1-6 Closer, 5106 extra heavy duty arm, plastic cover	ALM	362.50	130952
	BRZ	362.50	130970
	DBZ	362.50	130973
	GOL	362.50	130976
5100 Series 1-6 Closer, 5107 standard hold open arm, plastic cover	ALM	353.65	126475
	BRZ	353.65	130899
	DBZ	353.65	130947
	GOL	353.65	130951
5100 Series 1-6 Closer, 5108 extra heavy duty hold open arm, plastic cover (left hand)	ALM	350.20	130956
	BRZ	350.20	149871
	DBZ	350.20	151034
	GOL	350.20	156482
5100 Series 1-6 Closer, 5108 extra heavy duty hold open arm, plastic cover (right hand)	ALM	350.20	130957
	BRZ	350.20	149872
	DBZ	350.20	151033
	GOL	350.20	156483
5100 Series 1-6 Closer, 5125 extra heavy duty stop arm, plastic cover	ALM	362.50	130961
	BRZ	362.50	130972
	DBZ	362.50	130975
	GOL	362.50	130978
5100 Series 1-6 Closer, 5954 extra heavy duty hold open cushion stop arm, plastic cover	ALM	498.75	130959
	BRZ	498.75	149499
	DBZ	498.75	148985
	GOL	498.75	154060
5100 Series 1-6 Closer, 5955 extra heavy cushion stop arm, plastic cover	ALM	453.20	130962
	BRZ	453.20	151220
	DBZ	453.20	150847
	GOL	453.20	155760
5100 Series 1-6 Closer, 5961 extra heavy hold open stop arm, plastic cover	ALM	409.15	130958
	BRZ	409.15	130971
	DBZ	409.15	130974
	GOL	409.15	130977

1. Items with the price in **bold and red** are Quick Ship items and ship in 24 hours.
Please use stock number when ordering. 2. U/M is each unless otherwise noted.



Door Controls - 5100 Series

Description	Finish	2018 List	Stock No.	Case Qty.	Box Qty.
5100M16ALMOMOX 5100 Series High Security Package Package Contains: Closer, main arm assembly, parallel arm bracket, standard screw pack, SNB screw pack, torx screw pack and painted metal cover.	ALM	367.10	1521143	4	1
 5100 Closer w/ Non Hold Open Stop Track Arm	ALM	359.35	166331	10	1
	BRZ	359.35	166352		
	DBZ	359.35	166332		
	GOL	359.35	166353		
 5100 Closer w/ Hold Open Stop Track Arm	ALM	372.60	166337	10	1
	BRZ	372.60	166219		
	DBZ	372.60	166338		
	GOL	372.60	167220		
 5100 Closer w/ Double Egress Non Hold Open Stop Track Arm	ALM	388.05	166344	10	1
	BRZ	388.05	167235		
	DBZ	388.05	166345		
	GOL	388.05	167236		
 5100 Closer w/ Double Egress Hold Open Stop Track Arm	ALM	401.30	166348	10	1
	BRZ	401.30	167239		
	DBZ	401.30	166349		
	GOL	401.30	167240		
Description	Finish	2018 List	Stock No.	Case Qty.	Box Qty.
5101 5100 Series Closer Body Only Adjustable sizes 1-6	ALM	238.55	148803	4	1
	BRZ	238.55	148805		
	DBZ	238.55	148804		
	GOL	238.55	148806		
	5102 Full Plastic Cover 5100 Series	ALM	16.65	89003	25
	BRZ	16.65	88988		
	DBZ	16.65	88928		
	GOL	16.65	88730		
	5103 Main Arm Assembly 5100 Series	ALM	33.00	72038	8
	BRZ	33.00	71384		
	DBZ	33.00	71378		
	GOL	33.00	71297		
	5104 Standard Screw Pack 5100 Series	ALM	9.30	87683	80
	BRZ	9.30	87619		
	DBZ	9.30	87607		
	GOL	9.30	87089		
	5106 Extra Heavy Duty Parallel Arm 5100 Series	ALM	90.50	71612	10
	BRZ	90.50	71144		
	DBZ	90.50	71129		
	GOL	90.50	71121		
	5107 Standard Hold Open Arm 5100 Series	ALM	70.40	65492	10
	BRZ	70.40	65430		
	DBZ	70.40	65429		
	GOL	70.40	65422		



Door Controls - 5100 Series













Description	Finish	2018 List	Stock No.	Case Qty.	Box Qty.
5108 Extra Heavy Duty Hold Open Arm 5100 Series Specify handing when ordering.	ALM	90.50	72742	10	1
	BRZ	90.50	71054		
	DBZ	90.50	71053		
	GOL	90.50	70883		
5109 Drop Plate - Regular Arm Mount w/ Screws 5100 Series	ALM	40.00	62245	10	1
	BRZ	40.00	62028		
	DBZ	40.00	61745		
5110 Drop Plate - Parallel Arm Mount w/ Screws 5100 Series	ALM	40.00	61739	10	1
	BRZ	40.00	61735		
	DBZ	40.00	61726		
5111 Extra Heavy Duty Parallel Arm Bracket 5100 Series	ALM	16.65	61676	10	1
	BRZ	16.65	61506		
	DBZ	16.65	61432		
5112 Long Rod and Shoe 5100 Series For door reveals between 3" - 5".	ALM	16.65	98370	10	1
	BRZ	16.65	97617		
	DBZ	16.65	95821		
5113 Blade Stop Spacer	ALM	24.80	95278	15	1
	BRZ	24.80	95276		
	DBZ	24.80	94728		
5114 Drop Plate Low Clearance Top Jamb Mount w/ Screws 5100 Series	ALM	40.00	36332	10	1
	BRZ	40.00	36326		
	DBZ	40.00	36325		
5115 Drop Plate Top Jamb Mount w/ Screws 5100 Series	ALM	40.00	23471	10	1
	BRZ	40.00	36431		
	DBZ	40.00	36430		
5125 Extra Heavy Duty Stop Arm 5100 Series Can be combined with 5950, spring cushion kit.	ALM	90.50	120769	10	1
	BRZ	90.50	120770		
	DBZ	90.50	120771		
5909 Parallel Arm Bracket 5100 Series	ALM	8.40	63220	20	1
	BRZ	8.40	63101		
	DBZ	8.40	63100		
5935 2" Extra Clearance Bracket 5100 Series	ALM	21.85	129572	36	6
	BRZ	21.85	129574		
	DBZ	21.85	129575		
5940 SNB Screw Pack, 1-3/4" Door 5100 Series	ALM	9.30	104380	200	1
	BRZ	9.30	104381		
	DBZ	9.30	104382		
	GOL	9.30	104383		

1. Items with the price in **bold and red** are Quick Ship items and ship in 24 hours.
Please use stock number when ordering. 2. U/M is each unless otherwise noted.



Door Controls - 5100 Series

Description	Finish	2018 List	Stock No.	Case Qty.	Box Qty.
 5941 SNB Screw Pack, 1-3/8" Door 5100 Series	ALM	9.30	104384	200	1
	BRZ	9.30	104385		
	DBZ	9.30	104386		
	GOL	9.30	104387		
 5942 SNB Screw Pack, 2" Door 5100 Series	ALM	9.30	104388	200	1
	BRZ	9.30	104389		
	DBZ	9.30	104390		
	GOL	9.30	104391		
 5943 SNB Screw Pack, 2-1/4" Door 5100 Series	ALM	9.30	104392	200	1
	BRZ	9.30	104393		
	DBZ	9.30	104394		
	GOL	9.30	104395		
 5946 Tamper Resistant Torx Screwpack Sex Nuts and Bolts for 1-3/4" (44mm) doors 5100 Series Only	ALM	28.65	148410	1000	1
 5950 Spring Cushion Kit 5100/5200/5300 Series	ALM	121.45	118353	10	1
	BRZ	121.45	120777		
	DBZ	121.45	120779		
	GOL	121.45	120780		
 5954 Extra Heavy Duty Hold Open Cushion Stop Arm 5100 Series Includes 5961 and 5950.	ALM	253.85	118337	10	1
	BRZ	253.85	118338		
	DBZ	253.85	118339		
	GOL	253.85	118340		
 5955 Extra Heavy Duty Cushion Stop Arm 5100 Series Includes 5125 and 5950.	ALM	218.45	118341	10	1
	BRZ	218.45	118342		
	DBZ	218.45	118343		
	GOL	218.45	118344		
 5961 Extra Heavy Duty Hold Open Stop Arm Can be combined with 5950, spring cushion kit.	ALM	180.70	192281	10	1
	BRZ	180.70	192282		
	DBZ	180.70	192283		
	GOL	180.70	192284		
 5962 5100 Series Plated Metal Cover (Check with factory for availability)	US3	201.65	69551	25	1
	US26	201.65	69550		
	US26D	201.65	69798		
	ALM / Painted	141.15	144034		
	DBZ / Painted	141.15	144035		
 2-659-0187 Non Hold Open Stop Track Arm 5100 Series	ALM	87.55	167833	10	1
2-659-0188 Non Hold Open Stop Track Arm 5100 Series	BRZ	87.55	162731		
2-659-0189 Non Hold Open Stop Track Arm 5100 Series	DBZ	87.55	162718		
2-659-0190 Non Hold Open Stop Track Arm 5100 Series	GOL	87.55	162719		



Door Controls - 5100 Series



Description	Finish	2018 List	Stock No.	Case Qty.	Box Qty.
2-659-0195 Hold Open Stop Track Arm 5100 Series	ALM	100.95	167857	10	1
2-659-0196 Hold Open Stop Track Arm 5100 Series	BRZ	100.95	167858		
2-659-0197 Hold Open Stop Track Arm 5100 Series	DBZ	100.95	167859		
2-659-0198 Hold Open Stop Track Arm 5100 Series	GOL	100.95	167860		
2-659-0203 Double Egress Non Hold Open Stop Track Arm 5100 Series	ALM	125.65	167865	10	1
2-659-0204 Double Egress Non Hold Open Stop Track Arm 5100 Series	BRZ	125.65	167866		
2-659-0205 Double Egress Non Hold Open Stop Track Arm 5100 Series	DBZ	125.65	167867		
2-659-0206 Double Egress Non Hold Open Stop Track Arm 5100 Series	GOL	125.65	167868		
2-659-0207 Double Egress Hold Open Stop Track Arm 5100 Series	ALM	144.20	167869	10	1
2-659-0208 Double Egress Hold Open Stop Track Arm 5100 Series	BRZ	144.20	167870		
2-659-0209 Double Egress Hold Open Stop Track Arm 5100 Series	DBZ	144.20	167871		
2-659-0210 Double Egress Hold Open Stop Track Arm 5100 Series	GOL	144.20	167873		

Track arms only available in painted finishes shown

1. Items with the price in **bold and red** are Quick Ship items and ship in 24 hours.
Please use stock number when ordering. 2. U/M is each unless otherwise noted.

4/1/2018
www.hagerco.com



Door Controls - 5200 Series



Description	Finish	2018 List	Stock No.	Case Qty.	Box Qty.
5200 Series	ALM	236.80	126476	6	1
Grade 1	BRZ	236.80	126478		
Adjustable sizes 1-6	DBZ	236.80	126477		
	GOL	236.80	126479		

ADA (Barrier Free) Door Closers:

Any certified BHMA/ANSI A156.4 door closer, regardless of manufacturer, that is installed and adjusted based on ADA or other reduced opening force requirements may not provide sufficient power to reliably close and latch a door.

If arms are ordered separately, there will be a significant difference in price than if purchased with a closer as a complete assembly.

Adders are listed below. Add the list price of the option to the list price of the closer and take standard discounts.

Delayed Action Valve	17.20
Lead Lined Cover	108.15
Check with factory for pricing and availability of plated products.	POA

Closers with non-standard arms

5200 Series 1-6 Closer, 5203 tri-pack arm, slim line plastic cover	ALM	236.80	145551
	BRZ	236.80	166442
	DBZ	236.80	149176
	GOL	236.80	151746
5200 Series 1-6 Closer, 5910 hold open arm, plastic cover	ALM	275.40	145539
	BRZ	275.40	145540
	DBZ	275.40	145541
	GOL	275.40	145542
5200 Series 1-6 Closer, 5906 extra heavy duty hold open stop arm, plastic cover	ALM	331.75	145552
	BRZ	331.75	145556
	DBZ	331.75	145557
	GOL	331.75	145558
5200 Series 1-6 Closer, 5907 extra heavy duty stop arm, plastic cover	ALM	284.40	145560
	BRZ	284.40	145561
	DBZ	284.40	145562
	GOL	284.40	145563
5200 Series 1-6 Closer, 5911 extra heavy duty arm, plastic cover	ALM	300.05	149447
	BRZ	300.05	154453
	DBZ	300.05	148832
	GOL	300.05	155891
5200 Series 1-6 Closer, 5912 extra heavy duty hold open arm, plastic cover (left hand)	ALM	271.90	148835
	BRZ	271.90	163413
	DBZ	271.90	153689
	GOL	271.90	156741
5200 Series 1-6 Closer, 5912 extra heavy duty hold open arm, plastic cover (right hand)	ALM	271.90	148839
	BRZ	271.90	163414
	DBZ	271.90	153858
	GOL	271.90	156742
5200 Series 1-6 Closer, 5956 extra heavy duty hold open cushion stop arm, plastic cover	ALM	422.30	149802
	BRZ	422.30	151691
	DBZ	422.30	149732
	GOL	422.30	162296



Door Controls - 5200 Series

Description	Finish	2018 List	Stock No.	Case Qty.	Box Qty.
5200 Series 1-6 Closer, 5957 extra heavy duty cushion stop arm, plastic cover	ALM	383.15	149011		
	BRZ	383.15	162252		
	DBZ	383.15	148977		
	GOL	383.15	162991		
5200 Closer w/ Non Hold Open Stop Track Arm	ALM	282.10	166333	10	1
	BRZ	282.10	166354		
	DBZ	282.10	166334		
	GOL	282.10	167045		
5200 Closer w/ Hold Open Stop Track Arm	ALM	295.55	166339	10	1
	BRZ	295.55	167223		
	DBZ	295.55	166341		
	GOL	295.55	137224		
5200 Closer w/ Double Egress Non Hold Open Stop Track Arm	ALM	324.60	166350	10	1
	BRZ	324.60	167241		
	DBZ	324.60	166351		
	GOL	324.60	167242		
5200 Closer w/ Double Egress Hold Open Stop Track Arm	ALM	311.15	166346	10	1
	BRZ	311.15	167237		
	DBZ	311.15	166347		
Description					
5201 5200 Series Closer Body Only Adjustable sizes 1-6	ALM	167.10	148807	6	1
	BRZ	167.10	148809		
	DBZ	167.10	148808		
	GOL	167.10	148810		
5202 Full Plastic Cover 5200 Series	ALM	16.65	88651	25	1
	BRZ	16.65	88532		
	DBZ	16.65	88355		
	GOL	16.65	88343		
5203 Main Arm Assembly 5200 Series	ALM	33.00	71694	8	1
	BRZ	33.00	71296		
	DBZ	33.00	70681		
	GOL	33.00	71271		
5204 Standard Screw Pack 5200 Series	ALM	9.60	72358	80	1
	BRZ	9.60	72236		
	DBZ	9.60	72228		
	GOL	9.60	70684		
5910 Standard Hold Open Arm 5200 Series If ordered separately, 5914, Rev 1 needed for parallel mount.	ALM	72.45	191400	10	1
	BRZ	72.45	191402		
	DBZ	72.45	191401		
	GOL	72.45	191403		
5900 Parallel Arm Bracket 5200/5300/5400 Series	ALM	8.40	99140	120	1
	BRZ	8.40	99138		
	DBZ	8.40	99135		
	GOL	8.40	99134		
5902 SNB Screw Pack, 1-3/4" Door 5200/5300/5400 Series	ALM	9.60	9129	200	1
	BRZ	9.60	9128		
	DBZ	9.60	9127		
	GOL	9.60	9126		

1. Items with the price in **bold and red** are Quick Ship items and ship in 24 hours.
Please use stock number when ordering. 2. U/M is each unless otherwise noted.



Door Controls - 5200 Series

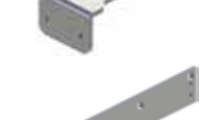

Description	Finish	2018 List	Stock No.	Case Qty.	Box Qty.
5903 SNB Screw Pack, 1-3/8" Door 5200/5300/5400 Series	ALM	9.60	99125	200	1
	BRZ	9.60	99124		
	DBZ	9.60	99123		
	GOL	9.60	99122		
5904 SNB Screw Pack, 2" Door 5200/5300/5400 Series	ALM	9.60	9921	200	1
	BRZ	9.60	99118		
	DBZ	9.60	99117		
	GOL	9.60	99116		
5905 SNB Screw Pack, 2-1/4" Door 5200/5300/5400 Series	ALM	9.60	99115	200	1
	BRZ	9.60	99114		
	DBZ	9.60	99113		
	GOL	9.60	99112		
5906 Extra Heavy Duty Hold Open Stop Arm 5200/5300 Series Can be combined with 5950, spring cushion kit.	ALM	180.70	14583	10	1
	BRZ	180.70	14582		
	DBZ	180.70	14578		
	GOL	180.70	14570		
5907 Extra Heavy Duty Stop Arm 5200/5300 Series Can be combined with 5950, spring cushion kit.	ALM	90.50	14595	10	1
	BRZ	90.50	14591		
	DBZ	90.50	14587		
	GOL	90.50	14586		
5908 Long Rod and Shoe 5200/5300 Series	ALM	16.65	35989	25	1
	BRZ	16.65	35988		
	DBZ	16.65	35941		
	GOL	16.65	35929		
5911 Extra Heavy Duty Arm 5200/5300 Series	ALM	90.50	73657	10	1
	BRZ	90.50	73656		
	DBZ	90.50	73607		
	GOL	90.50	73487		
5912 Extra Heavy Duty Hold Open Arm 5200/5300 Series Specify handing when ordering.	ALM	90.50	73446	10	1
	BRZ	90.50	73317		
	DBZ	90.50	73347		
	GOL	90.50	73283		
5913 Blade Stop Spacer 5200/5300/5400 Series	ALM	25.55	73268	15	1
	BRZ	25.55	73244		
	DBZ	25.55	73076		
	GOL	25.55	73074		
5914 Hold Open Parallel Arm Bracket 5200/5300 Series For standard hold-open arm.	ALM	16.65	72936	60	1
	BRZ	16.65	72905		
	DBZ	16.65	72907		
	GOL	16.65	72814		
5918 Drop Plate - Top Jamb Narrow Top Rail w/ Mounting Screws 5200 Series For use with slim line or no cover.	ALM	41.20	72262	10	1
	BRZ	41.20	72242		
	DBZ	41.20	72248		
	GOL	41.20	72241		
5919 Pinion Cap 5200 Series	ALM	1.85	72138	20	1
	BRZ	1.85	70989		
	DBZ	1.85	70987		
	GOL	1.85	70984		





Description	Finish	2018 List	Stock No.	Case Qty.	Box Qty.
5920 Slim Line Plastic Cover 5200 Series	ALM	16.65	70962	18	1
	BRZ	16.65	70859		
	DBZ	16.65	70987		
	GOL	16.65	70984		
5921 Drop Plate Narrow Top Rail w/ Mounting Screws 5200 Series For use with full cover.	ALM	40.00	33996	10	1
	BRZ	40.00	33994		
	DBZ	40.00	33980		
	GOL	40.00	33979		
5922 Drop Plate - Top Jamb Parallel Arm with Mounting Screws 5200 Series For use with slim line or no cover.	ALM	40.00	33957	10	1
	BRZ	40.00	33943		
	DBZ	40.00	33941		
	GOL	40.00	33940		
5923 Drop Plate Parallel Arm with Mounting Screws 5200 Series For use with full cover.	ALM	40.00	33947	10	1
	BRZ	40.00	33936		
	DBZ	40.00	33934		
	GOL	40.00	33929		
5932 Plated Metal Cover (Check with factory for availability) 5200 Series	US3	164.25	69533	25	1
	US26	164.25	69525		
	US26D	164.25	69524		
	ALM (painted)	164.25	191374		
5936 Extra Clearance Bracket 5200/5300 Series	ALM	21.85	129577	48	8
	BRZ	21.85	129578		
	DBZ	21.85	129579		
	GOL	21.85	129580		
5950 Spring Cushion Kit 5100/5200/5300 Series	ALM	121.45	118353	10	1
	BRZ	121.45	120777		
	DBZ	121.45	120779		
	GOL	121.45	120780		
5956 Extra Heavy Duty Hold Open Cushion Stop Arm 5200/5300 Series Includes 5906 and 5950.	ALM	253.85	118345	10	1
	BRZ	253.85	118346		
	DBZ	253.85	118347		
	GOL	253.85	118348		
5957 Extra Heavy Duty Cushion Stop Arm 5200/5300 Series Includes 5907 and 5950.	ALM	218.45	118349	10	1
	BRZ	218.45	118350		
	DBZ	218.45	118351		
	GOL	218.45	118352		
2-659-0191 Non Hold Open Stop Track Arm 5200 Series	ALM	87.55	167837	10	1
2-659-0192 Non Hold Open Stop Track Arm 5200 Series	BRZ	87.55	167854		
2-659-0193 Non Hold Open Stop Track Arm 5200 Series	DBZ	87.55	167855		
2-659-0194 Non Hold Open Stop Track Arm 5200 Series	GOL	87.55	167856		

1. Items with the price in **bold and red** are Quick Ship items and ship in 24 hours.
Please use stock number when ordering. 2. U/M is each unless otherwise noted.



Door Controls - 5200 Series



Description	Finish	2018 List	Stock No.	Case Qty.	Box Qty.
2-659-0199 Hold Open Stop Track Arm 5200 Series	ALM	100.95	167861	10	1
2-659-0200 Hold Open Stop Track Arm 5200 Series	BRZ	100.95	167862		
2-659-0201 Hold Open Stop Track Arm 5200 Series	DBZ	100.95	167863		
2-659-0202 Hold Open Stop Track Arm 5200 Series	GOL	100.95	167864		
2-659-0211 Double Egress Non Hold Open Stop Track Arm 5200 Series	ALM	125.65	167874	10	1
2-659-0212 Double Egress Non Hold Open Stop Track Arm 5200 Series	BRZ	125.65	167875		
2-659-0213 Double Egress Non Hold Open Stop Track Arm 5200 Series	DBZ	125.65	167876		
2-659-0214 Double Egress Non Hold Open Stop Track Arm 5200 Series	GOL	125.65	167877		
2-659-0215 Double Egress Hold Open Stop Track Arm 5200 Series	ALM	144.20	167878	10	1
2-659-0216 Double Egress Hold Open Stop Track Arm 5200 Series	BRZ	144.20	167879		
2-659-0217 Double Egress Hold Open Stop Track Arm 5200 Series	DBZ	144.20	167880		
2-659-0218 Double Egress Hold Open Stop Track Arm 5200 Series	GOL	144.20	167881		

Track arms only available in painted finishes shown





Description	Finish	2018 List	Stock No.	Case Qty.	Box Qty.
5300 Series	ALM	189.20	145672	6	1
Grade 1	BRZ	189.20	145673		
Adjustable sizes 1-6	DBZ	189.20	145674		
	GOL	189.20	145675		
ADA (Barrier Free) Door Closers:					
Any certified BHMA/ANSI A156.4 door closer, regardless of manufacturer, that is installed and adjusted based on ADA or other reduced opening force requirements may not provide sufficient power to reliably close and latch a door.					
If arms are ordered separately, there will be a significant difference in price than if purchased with a closer as a complete assembly. Adders are listed below. Add the list price of the option to the list price of the closer and take standard discounts.					
Delayed Action Valve		17.20			
Lead Lined Cover		108.15			
Check with factory for pricing and availability of plated products.		POA			
Closers with non-standard arms					
5300 Series 1-6 Closer, 5307 hold open arm, plastic cover	ALM	226.70	145676		
	BRZ	226.70	145677		
	DBZ	226.70	145678		
	GOL	226.70	145679		
5300 Series 1-6 Closer, 5906 extra heavy duty hold open stop arm, plastic cover	ALM	281.40	145681		
	BRZ	281.40	145682		
	DBZ	281.40	145683		
	GOL	281.40	145684		
5300 Series 1-6 Closer, 5907 extra heavy duty stop arm, plastic cover	ALM	235.40	145686		
	BRZ	235.40	174460		
	DBZ	235.40	145687		
	GOL	235.40	164629		
5300 Series 1-6 Closer, 5911 extra heavy duty arm, plastic cover	ALM	235.40	150366		
	BRZ	235.40	173792		
	DBZ	235.40	152815		
	GOL	235.40			
5300 Series 1-6 Closer, 5912 extra heavy duty hold open arm, plastic cover (left hand)	ALM	222.50	152972		
	BRZ	222.50			
	DBZ	222.50	154681		
	GOL	222.50			
5300 Series 1-6 Closer, 5912 extra heavy duty hold open arm, plastic cover (right hand)	ALM	222.50	152973		
	BRZ	222.50			
	DBZ	222.50	154682		
	GOL	222.50			
5300 Series 1-6 Closer, 5956 extra heavy duty hold open cushion stop arm, plastic cover	ALM	369.65	150916		
	BRZ	369.65	171199		
	DBZ	369.65	160007		
	GOL	369.65			
5300 Series 1-6 Closer, 5957 extra heavy duty cushion stop arm, plastic cover	ALM	329.60	149230		
	BRZ	329.60	149807		
	DBZ	329.60	149013		
	GOL	329.60	173080		

1. Items with the price in **bold and red** are Quick Ship items and ship in 24 hours.
Please use stock number when ordering. 2. U/M is each unless otherwise noted.



Door Controls - 5300 Series



5300 Closer w/ Non Hold Open Stop Track Arm	ALM	233.60	166335	10	1
	BRZ	233.60	167062		
	DBZ	233.60	166336		
	GOL	233.60	167217		
5300 Closer w/ Hold Open Stop Track Arm	ALM	245.55	166342	10	1
	BRZ	245.55	167225		
	DBZ	245.55	166343		
	GOL	245.55	167234		

Description	Finish	2018 List	Stock No.	Case Qty.	Box Qty.
5301 Closer Body Only Adjustable sizes 1-6	ALM	121.75	148811	6	1
	BRZ	121.75	148813		
	DBZ	121.75	148812		
	GOL	121.75	148814		
5302 Full Plastic Cover 5300 Series	ALM	16.65	88207	25	1
	BRZ	16.65	87873		
	DBZ	16.65	87843		
	GOL	16.65	87785		
5303 Main Arm Assembly 5300 Series	ALM	33.00	71270	8	1
	BRZ	33.00	71255		
	DBZ	33.00	71254		
	GOL	33.00	71234		
5304 Standard Screw Pack 5300 Series	ALM	9.60	72356	80	1
	BRZ	9.60	72210		
	DBZ	9.60	72180		
	GOL	9.60	72174		
5307 Standard Hold Open Arm 5300 Series If ordered separately, 5914 needed for parallel mount.	ALM	72.45	73681	10	1
	BRZ	72.45	73680		
	DBZ	72.45	73677		
	GOL	72.45	73660		
5900 Parallel Arm Bracket 5200/5300/5400 Series	ALM	8.40	99140	120	1
	BRZ	8.40	99138		
	DBZ	8.40	99135		
	GOL	8.40	99134		
5901 Pinion Cap 5300/5400 Series	ALM	1.90	99133	200	1
	BRZ	1.90	99132		
	DBZ	1.90	99131		
	GOL	1.90	99130		1
5902 SNB Screw Pack, 1-3/4" Door 5200/5300/5400 Series	ALM	9.60	99129	200	1
	BRZ	9.60	99128		
	DBZ	9.60	99127		
	GOL	9.60	99126		
5903 SNB Screw Pack, 1-3/8" Door 5200/5300/5400 Series	ALM	9.60	99125	200	1
	BRZ	9.60	99124		
	DBZ	9.60	99123		
	GOL	9.60	99122		







Description	Finish	2018 List	Stock No.	Case Qty.	Box Qty.
5904 SNB Screw Pack, 2" Door 5200/5300/5400 Series	ALM	9.60	99121	200	1
	BRZ	9.60	99118		
	DBZ	9.60	99117		
	GOL	9.60	99116		
5905 SNB Screw Pack, 2-1/4" Door 5200/5300/5400 Series	ALM	9.60	99115	200	1
	BRZ	9.60	99114		
	DBZ	9.60	99113		
	GOL	9.60	99112		
5906 Extra Heavy Duty Hold Open Stop Arm 5200/5300 Series Can be combined with 5950, spring cushion kit.	ALM	180.70	14583	10	1
	BRZ	180.70	14582		
	DBZ	180.70	14578		
	GOL	180.70	14570		
5907 Extra Heavy Duty Stop Arm 5200/5300 Series Can be combined with 5950, spring cushion kit.	ALM	90.50	14595	10	1
	BRZ	90.50	14591		
	DBZ	90.50	14587		
	GOL	90.50	14586		
5908 Long Rod and Shoe 5200/5300 Series	ALM	16.65	35989	25	1
	BRZ	16.65	35988		
	DBZ	16.65	35941		
	GOL	16.65	35929		
5911 Extra Heavy Duty Arm 5200/5300 Series	ALM	90.50	73657	10	1
	BRZ	90.50	73656		
	DBZ	90.50	73607		
	GOL	90.50	73487		
5912 Extra Heavy Duty Hold Open Arm 5200/5300 Series Specify handing when ordering.	ALM	90.50	73446	10	1
	BRZ	90.50	73317		
	DBZ	90.50	73347		
	GOL	90.50	73283		
5913 Blade Stop Spacer 5200/5300/5400 Series	ALM	25.55	73268	15	1
	BRZ	25.55	73244		
	DBZ	25.55	73076		
	GOL	25.55	73074		
5914 Hold Open Parallel Arm Bracket 5200/5300 Series For standard hold-open arm.	ALM	16.65	72936	60	1
	BRZ	16.65	72905		
	DBZ	16.65	72907		
	GOL	16.65	72814		
5915 Drop Plate - OH Holder Narrow Rail w/ Mounting Screws 5300 Series For use with full cover.	ALM	40.00	72754	10	1
	BRZ	40.00	72741		
	DBZ	40.00	72750		
	GOL	40.00	72673		
5916 Drop Plate - Narrow Rail Parallel Arm Cover w/ Mounting Screws 5300 Series For use with full cover.	ALM	40.00	72669	10	1
	BRZ	40.00	72500		
	DBZ	40.00	72509		
	GOL	40.00	72468		
5917 Drop Plate - Low Clearance Overhead Holder w/ Mounting Screws 5300 Series For use with no cover.	ALM	40.00	72410	10	1
	BRZ	40.00	72281		
	DBZ	40.00	72372		
	GOL	40.00	72264		

1. Items with the price in **bold and red** are Quick Ship items and ship in 24 hours.
Please use stock number when ordering. 2. U/M is each unless otherwise noted.



Door Controls - 5300 Series

	Description	Finish	2018 List	Stock No.	Case Qty.	Box Qty.
	5936	ALM	21.85	129577	48	1
	Extra Clearance Bracket	BRZ	21.85	129578		
	5200/5300 Series	DBZ	21.85	129579		
		GOL	21.85	129580		
	5950	ALM	121.45	118353	10	1
	Spring Cushion Kit (sold separately)	BRZ	121.45	120777		
	5100/5200/5300 Series	DBZ	121.45	120779		
		GOL	121.45	120780		
	5956	ALM	253.85	118345	10	1
	Extra Heavy Duty	BRZ	253.85	118346		
	Hold Open Cushion Stop Arm	DBZ	253.85	118347		
	5200/5300 Series	GOL	253.85	118348		
	Includes 5906 and 5950.					
	5957	ALM	218.45	118349	10	1
	Extra Heavy Duty Cushion Stop Arm	BRZ	218.45	118350		
	5200/5300 Series	DBZ	218.45	118351		
		GOL	218.45	118352		
	Includes 5907 and 5950.					
	2-659-0191	ALM	87.55	167861	10	1
	Non Hold Open Stop Track Arm					
	5300 Series					
	2-659-0192	BRZ	87.55	167862		
	Non Hold Open Stop Track Arm					
	5300 Series					
	2-659-0193	DBZ	87.55	167863		
	Non Hold Open Stop Track Arm					
	5300 Series					
	2-659-0194	GOL	87.55	167864		
	Non Hold Open Stop Track Arm					
	5300 Series					
	2-659-0199	ALM	100.95	167874	10	1
	Hold Open Stop Track Arm					
	5300 Series					
	2-659-0200	BRZ	100.95	167875		
	Hold Open Stop Track Arm					
	5300 Series					
	2-659-0201	DBZ	100.95	167876		
	Hold Open Stop Track Arm					
	5300 Series					
	2-659-0202	GOL	100.95	167877		
	Hold Open Stop Track Arm					
	5300 Series					

Track arms only available in painted finishes shown

Door Controls - 5400 Series



Description	Finish	2018 List	Stock No.	Case Qty.	Box Qty.
5400 Series	ALM	116.80	98103	6	1
Grade 2	BRZ	116.80	98107		
Size 2	DBZ	116.80	98108		
	GOL	116.80	98109		
5400 Series	ALM	116.80	13302	6	1
Grade 2	BRZ	116.80	13303		
Size 3	DBZ	116.80	13304		
	GOL	116.80	13305		
5400 Series	ALM	116.80	13309	6	1
Grade 2	BRZ	116.80	13308		
Size 4	DBZ	116.80	13307		
	GOL	116.80	13306		
5400 Series	ALM	116.80	13310	6	1
Grade 2	BRZ	116.80	13311		
Size 5	DBZ	116.80	13312		
	GOL	116.80	13313		
5400 Series Adders:		16.00			
Optional backcheck available (add to list price)					
5401	ALM	89.85	72172	6	1
5400 Series Closer Body Only	BRZ	89.85	71884		
Size 2	DBZ	89.85	71839		
	GOL	89.85	71798		
5401	ALM	89.85	71778	6	1
5400 Series Closer Body Only	BRZ	89.85	71702		
Size 3	DBZ	89.85	-		
	GOL	89.85	-		
5401	ALM	89.85	71555	6	1
5400 Series Closer Body Only	BRZ	89.85	71515		
Size 4	DBZ	89.85	71504		
	GOL	89.85	71495		
5401	ALM	89.85	71477	6	1
5400 Series Closer Body Only	BRZ	89.85	71446		
Size 5	DBZ	89.85	71444		
	GOL	89.85	71439		



1. Items with the price in **bold and red** are Quick Ship items and ship in 24 hours.
Please use stock number when ordering. 2. U/M is each unless otherwise noted.



Door Controls - 5400 Series



Description	Finish	2018 List	Stock No.	Case Qty.	Box Qty.
5403 Main Arm Assembly 5400 Series	ALM	29.45	71659	8	1
	BRZ	29.45	71227		
	DBZ	29.45	71218		
	GOL	29.45	71216		
5404 Standard Screw Pack 5400 Series	ALM	9.15	72336	80	1
	BRZ	9.15	72173		
	DBZ	9.15	72171		
	GOL	9.15	72166		
5900 Parallel Arm Bracket 5200/5300/5400 Series	ALM	8.65	99140	120	1
	BRZ	8.65	99138		
	DBZ	8.65	99135		
	GOL	8.65	99134		
5901 Pinion Cap 5300/5400 Series	ALM	1.90	99133	200	1
	BRZ	1.90	99132		
	DBZ	1.90	99131		
	GOL	1.90	99130		
5902 SNB Screw Pack, 1-3/4" Door 5200/5300/5400 Series	ALM	9.60	9129	200	1
	BRZ	9.60	9128		
	DBZ	9.60	9127		
	GOL	9.60	9126		
5903 SNB Screw Pack, 1-3/8" Door 5200/5300/5400 Series	ALM	9.60	99125	200	1
	BRZ	9.60	99124		
	DBZ	9.60	99123		
	GOL	9.60	99122		
5904 SNB Screw Pack, 2" Door 5200/5300/5400 Series	ALM	9.60	9921	200	1
	BRZ	9.60	99118		
	DBZ	9.60	99117		
	GOL	9.60	99116		
5905 SNB Screw Pack, 2-1/4" Door 5200/5300/5400 Series	ALM	9.60	99115	200	1
	BRZ	9.60	99114		
	DBZ	9.60	99113		
	GOL	9.60	99112		
5913 Blade Stop Spacer 5200/5300/5400 Series	ALM	25.55	73268	15	1
	BRZ	25.55	73244		
	DBZ	25.55	73076		
	GOL	25.55	73074		



Door Controls - Electromagnetic Holders

Description	Voltage	Finish	2018 List	Stock No.	Case Qty.	Box Qty.	
 380F Electromagnetic Door Holder Flush Mount	12 & 24	US3	252.75	122598	25	1	
		L2	252.75	113307			
		LS	252.75	107216			
	24 & 120	US3	252.75	-			
		L2	252.75	143678			
		LS	252.75	107443			
	24 & 220	US3	252.75	142090			
		L2	252.75	-			
		LS	252.75	124474			
 380G Electromagnetic Door Holder Floor Mount (Single Door)	12 & 24	US3	382.35	133360	18	1	
		L2	382.35	-			
		LS	382.35	133362			
	24 & 120	US3	382.35	-			
		L2	382.35	-			
		LS	382.35	111432			
	24 & 220	US3	382.35	-			
		L2	382.35	122342			
		LS	382.35	139500			
 380H Electromagnetic Door Holder Floor Mount (Double Door)	12 & 24	US3	447.15	-	6	1	
		L2	447.15	-			
		LS	447.15	-			
	24 & 120	US3	447.15	-			
		L2	447.15	-			
		LS	447.15	114881			
	24 & 220	US3	447.15	-			
		L2	447.15	-			
		LS	447.15	-			
 380R Electromagnetic Door Holder Recessed Mount	12 & 24	US3	252.75	129952	25	1	
		L2	252.75	130390			
		LS	252.75	107442			
	24 & 120	US3	252.75	-			
		L2	252.75	-			
		LS	252.75	107446			
	24 & 220	US3	252.75	-			
		L2	252.75	-			
		LS	252.75	141037			
 380S Electromagnetic Door Holder Surface Mount	12 & 24	US3	278.65	114503	25	1	
		L2	278.65	113961			
		LS	278.65	107441			
	24 & 120	US3	278.65	120377			
		L2	278.65	116868			
		LS	278.65	107444			
	24 & 220	US3	278.65	-			
		L2	278.65	139499			
		LS	278.65	-			

1. Items with the price in **bold and red** are Quick Ship items and ship in 24 hours.
 Please use stock number when ordering. 2. U/M is each unless otherwise noted.



Door Controls - Electromagnetic Holders



Description	Size	Finish	2018 List	Stock No.	Case Qty.	Box Qty.
381A Adjustable Extension Rods	1-1/2"	US3	20.85	107528	25	1
		L2	20.85	107529		
		LS	20.85	107527		
	2"	US3	22.10	107532		
		L2	22.10	107533		
		LS	22.10	107530		
	4"	US3	24.60	107535		
		L2	24.60	107536		
		LS	24.60	107534		
381B Surface Back Box	4"	US3	38.90	107547	50	1
		L2	38.90	107548		
		LS	38.90	107545		
381C Catch Disc	4"	US3	26.00	107550	25	1
		L2	26.00	107551		
		LS	26.00	107549		
381D Drilling Fixture	4"	-	50.00	16654	1	1
381E Extension Rods	1/2"	US3	16.95	107450	25	1
		L2	16.95	107451		
		LS	16.95	107449		
	1"	US3	18.25	107453		
		L2	18.25	107452		
		LS	18.25	107455		
	1-1/2"	US3	19.50	107458		
		L2	19.50	107460		
		LS	19.50	107457		
	2"	US3	20.85	107467		
		L2	20.85	107468		
		LS	20.85	107462		
	3"	US3	22.10	107489		
		L2	22.10	107490		
		LS	22.10	107488		
	4"	US3	23.35	107492		
		L2	23.35	107493		
		LS	23.35	107491		



Door Controls - Electromagnetic Holders



Description	Size	Finish	2018 List	Stock No.	Case Qty.	Box Qty.
381H Hardware Package	4"	-	22.10	-	25	1



381S Catch Plate Assembly	4"	US3	64.80	107543	50	1
		L2	64.80	107544		
		LS	64.80	107542		



381W Extension Wrenches (2 pcs.)	4"	-	5.20	107552	25	1
--	----	---	------	--------	----	---

1. Items with the price in **bold and red** are Quick Ship items and ship in 24 hours.
Please use stock number when ordering. 2. U/M is each unless otherwise noted.



Door Controls - Overhead Door Holders and Stops



Description	Material	Finish	2018 List	Stock No.	Case Qty.	Box Qty.
6015 Series						
Medium Duty Surface Mount						
Friction	Stainless steel	US32D/630	165.20	140725	6	1
Size 1	Steel	US10B/640	165.20	140826		
18" - 33" Frame Opening		US3/632	165.20	147008		
		ALM/powder coated	121.20	140886		
Friction	Stainless steel	US32D/630	165.20	140726	6	1
Size 2	Steel	US10B/640	165.20	140827		
33" - 51" Frame Opening		US3/632	165.20	147010		
		ALM/powder coated	121.20	140887		
6015 Series						
Medium Duty Concealed Mount						
Friction	Stainless steel	US32D/630	165.20	140731	6	1
Size 1	Steel	US10B/640	165.20	140832		
18" - 33" Frame Opening		US3/632	165.20	147009		
		ALM/powder coated	121.20	140892		
Friction	Stainless steel	US32D/630	165.20	140732	6	1
Size 2	Steel	US10B/640	165.20	140833		
33" - 51" Frame Opening		US3/632	165.20	147011		
		ALM/powder coated	121.20	140893		
6016 Series						
Medium Duty Surface Mount						
Stop ONLY	Stainless steel	US32D/630	165.20	140720	6	1
Size 1	Steel	US10B/640	165.20	140822		
18" - 33" Frame Opening		US3/632	165.20	147000		
		ALM/powder coated	121.20	140882		
Stop ONLY	Stainless steel	US32D/630	165.20	140721	6	1
Size 2	Steel	US10B/640	165.20	140823		
33" - 51" Frame Opening		US3/632	165.20	147002		
		ALM/powder coated	121.20	140883		
6016 Series						
Medium Duty Concealed Mount						
Stop ONLY	Stainless steel	US32D/630	165.20	140727	6	1
Size 1	Steel	US10B/640	165.20	140828		
18" - 33" Frame Opening		US3/632	165.20	147001		
		ALM/powder coated	121.20	140888		
Stop ONLY	Stainless steel	US32D/630	165.20	140728	6	1
Size 2	Steel	US10B/640	165.20	140829		
33" - 51" Frame Opening		US3/632	165.20	147003		
		ALM/powder coated	121.20	140889		



Door Controls - Overhead Door Holders and Stops



Description	Material	Finish	2018 List	Stock No.	Case Qty.	Box Qty.
6017 Series						
Medium Duty Surface Mount						
Hold Open	Stainless steel	US32D/630	165.20	140722	6	1
Size 1	Steel	US10B/640	165.20	140824		
18" - 33" Frame Opening		US3/632	165.20	147004		
		ALM/powder coated	121.20	140884		
Hold Open	Stainless steel	US32D/630	165.20	140723	6	1
Size 2	Steel	US10B/640	165.20	140825		
33" - 51" Frame Opening		US3/632	165.20	147006		
		ALM/powder coated	121.20	140885		
6017 Series						
Medium Duty Concealed Mount						
Hold Open	Stainless steel	US32D/630	165.20	140729	6	1
Size 1	Steel	US10B/640	165.20	140830		
18" - 33" Frame Opening		US3/632	165.20	147005		
		ALM/powder coated	121.20	140890		
Hold Open	Stainless steel	US32D/630	165.20	140730	6	1
Size 2	Steel	US10B/640	165.20	140831		
33" - 51" Frame Opening		US3/632	165.20	147007		
		ALM/powder coated	121.20	140891		
6000 Series Accessories						
Surface Mounted End Cap and Spring Replacement Kit	2-659-0101	US26D	13.30	141691		
	2-659-0102	US10B	13.30	141692		
	2-659-0103	US3	13.30	141697		
6000 Series Accessories						
Concealed Mounted End Cap and Spring Replacement Kit	2-659-0104	-	13.30	141695		
6000 Series Accessories						
Hold Open Replacement Kit	2-659-0105	-	19.90	141696		
6000 Series Accessories						
Friction Replacement Kit	2-659-0106	-	19.90	141697		
6000 Series Screwpacks						
Standard screwpack includes machine screws, wood screws, sex nuts & bolts for 1-3/4" doors, arm set screws, Allen wrench, for both concealed and surface mounted	2-659-0098	US26D	10.00	141688		
	2-659-0099	US10B	10.00	141689		
	2-659-0100	US3	10.00	141690		
6000 Series Screwpacks						
SNB screwpack includes sex nuts and bolts for 1-3/8" doors	2-659-0107	US26D	7.80	141698		
	2-659-0108	US10B	7.80	141699		
	2-659-0109	US3	7.80	141700		
6000 Series Screwpacks						
SNB screwpack includes sex nuts and bolts for 2" doors	2-659-0110	US26D	7.80	141701		
	2-659-0111	US10B	7.80	141702		
	2-659-0112	US3	7.80	141703		

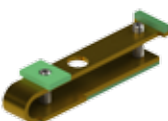

1. Items with the price in **bold and red** are Quick Ship items and ship in 24 hours.
Please use stock number when ordering. 2. U/M is each unless otherwise noted.

4/1/2018
www.hagerco.com



Door Controls - Overhead Door Holders and Stops



Description	Material	Finish	2018 List	Stock No.	Case Qty.	Box Qty.
6000 Series Screwpacks	2-659-0113	US26D	7.80	141704		
SNB screwpack includes sex nuts and bolts for 2-1/4" doors	2-659-0114	US10B	7.80	141705		
	2-659-0115	US3	7.80	141706		



Description	Material	Finish	2018 List	Stock No.	Case Qty.	Box Qty.
7015 Series Heavy Duty Surface Mount						
Friction	Stainless steel	US32D/630	313.90	140712	6	1
Size 1	Steel	US10B/640	313.90	140814		
23" - 39" Frame Opening		US3/632	313.90	147263		
		ALM/powder coated	253.35	140874		
Friction	Stainless steel	US32D/630	313.90	140713	6	1
Size 2	Steel	US10B/640	313.90	140815		
39" - 54" Frame Opening		US3/632	313.90	147265		
		ALM/powder coated	253.35	140875		

7015 Series Heavy Duty Concealed Mount

Friction	Stainless steel	US32D/630	313.90	140718	6	1
Size 1	Steel	US10B/640	313.90	140820		
23" - 39" Frame Opening		US3/632	313.90	147264		
		ALM/powder coated	253.35	140880		
Friction	Stainless steel	US32D/630	313.90	140719	6	1
Size 2	Steel	US10B/640	313.90	140821		
39" - 54" Frame Opening		US3/632	313.90	147266		
		ALM/powder coated	253.35	140881		



Description	Material	Finish	2018 List	Stock No.	Case Qty.	Box Qty.
7016 Series Heavy Duty Surface Mount						
Stop ONLY	Stainless steel	US32D/630	313.90	140680	6	1
Size 1	Steel	US10B/640	313.90	140805		
23" - 39" Frame Opening		US3/632	313.90	147252		
		ALM/powder coated	253.35	140870		
Stop ONLY	Stainless steel	US32D/630	313.90	140701	6	1
Size 2	Steel	US10B/640	313.90	140807		
39" - 54" Frame Opening		US3/632	313.90	147255		
		ALM/powder coated	253.35	140871		



7016 Series Heavy Duty Concealed Mount						
Stop ONLY	Stainless steel	US32D/630	313.90	140714	6	1
Size 1	Steel	US10B/640	313.90	140816		
23" - 39" Frame Opening		US3/632	313.90	147254		
		ALM/powder coated	253.35	140876		
Stop ONLY	Stainless steel	US32D/630	313.90	140715	6	1
Size 2	Steel	US10B/640	313.90	140817		
39" - 54" Frame Opening		US3/632	313.90	147256		
		ALM/powder coated	253.35	140877		



Door Controls - Overhead Door Holders and Stops



Description	Material	Finish	2018 List	Stock No.	Case Qty.	Box Qty.
7017 Series Heavy Duty Surface Mount						
Hold Open	Stainless steel	US32D/630	313.90	140710	6	1
Size 1	Steel	US10B/640	313.90	140810		
23" - 39" Frame Opening		US3/632	313.90	147257		
		ALM/powder coated	253.35	140872		
Hold Open	Stainless steel	US32D/630	313.90	140711	6	1
Size 2	Steel	US10B/640	313.90	140813		
39" - 54" Frame Opening		US3/632	313.90	147261		
		ALM/powder coated	253.35	140873		
7017 Series Heavy Duty Concealed Mount						
Hold Open	Stainless steel	US32D/630	313.90	140716	6	1
Size 1	Steel	US10B/640	313.90	140818		
23" - 39" Frame Opening		US3/632	313.90	147258		
		ALM/powder coated	253.35	140878		
Hold Open	Stainless steel	US32D/630	313.90	140717	6	1
Size 2	Steel	US10B/640	313.90	140819		
39" - 54" Frame Opening		US3/632	313.90	147264		
		ALM/powder coated	253.35	140879		
7000 Series Accessories						
Surface Mounted End Cap and Spring Replacement Kit	2-659-0119	US26D	18.20	141711		
	2-659-0120	US10B	18.20	141712		
	2-659-0121	US3	18.20	141713		
7000 Series Accessories						
Concealed Mounted End Cap and Spring Replacement Kit	2-659-0122	-	18.20	141714		
7000 Series Accessories						
Hold Open Replacement Kit	2-659-0123	-	22.05	141715		
7000 Series Accessories						
Friction Replacement Kit	2-659-0124	-	22.05	141716		
7000 Series Screwpacks						
Standard screwpack includes machine screws, wood screws, sex nuts & bolts for 1-3/4" doors, arm set screws, Allen wrench, for both concealed and surface mounted	2-659-0116	US26D	15.20	141707		
	2-659-0117	US10B	15.20	141708		
	2-659-0118	US3	15.20	141709		
7000 Series Screwpacks						
SNB screwpack includes sex nuts and bolts for 1-3/8" doors	2-659-0125	US26D	11.00	141717		
	2-659-0126	US10B	11.00	141718		
	2-659-0127	US3	11.00	141719		
7000 Series Screwpacks						
SNB screwpack includes sex nuts and bolts for 2" doors	2-659-0128	US26D	11.00	141720		
	2-659-0129	US10B	11.00	141721		
	2-659-0130	US3	11.00	141722		

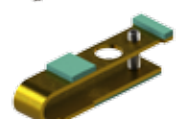
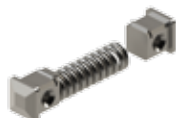
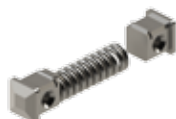

1. Items with the price in **bold and red** are Quick Ship items and ship in 24 hours.
Please use stock number when ordering. 2. U/M is each unless otherwise noted.

4/1/2018
www.hagerco.com



Door Controls - Overhead Door Holders and Stops



Description	Material	Finish	2018 List	Stock No.	Case Qty.	Box Qty.
7000 Series Screwpacks	2-659-0131	US26D	11.00	141723		
SNB screwpack includes sex nuts	2-659-0132	US10B	11.00	141724		
and bolts for 2-1/4" doors	2-659-0133	US3	11.00	141725		





One Family. One Brand. One Vision.™

www.hagerco.com

TABLE OF CONTENTS

A

Accessories, 4500 Series Grade 1

Alarm Kit..... 25
 Alarm Kit Latchbolt Monitor Switch 28
 Alarm Kit Tamper Switch 29
 Concealed Vertical Rod Bottom Latch Assembly..... 29
 Concealed Vertical Rod Top Latch Assembly..... 29
 Cylinder Cup Spacer 45PN/47PN 29, 44
 Cylinder Dogging Conversion Kit..... 23
 End Cap Replacement Packs (standard and flush) 26-27
 Extension Rod Kit - 24" 25
 Extension Rod Kit - 36" 25
 Hex Key for Dogging..... 29
 Less Bottom Rod Fire Bolt Kit 28
 Less Bottom Rod Replacement Head Cover Plug 28
 Photoluminescent Push Bar 29
 Replacement Head Covers..... 24-25
 Rod to Rod Connector 28
 Rod Guide Replacement Pack..... 26
 Spring Cage/Hanging Pin Replacement Pack 27
 Surface Vertical Rod Top Latch Assembly..... 24
 Surface Vertical Rod Bottom Latch Assembly 23
 Screwpacks 27-28
 Top or Bottom Latch Cover Replacement Pack..... 27
 Top or Bottom Rod Replacement Kits..... 24

Accessories, 4600 Series Grade 1 Narrow Stile

Alarm Kit..... 34
 Alarm Kit Latchbolt Monitor Switch 35
 Alarm Kit Tamper Switch 35
 Cylinder Dogging Conversion Kit..... 33
 End Cap Replacement Packs (standard and flush) 35
 Hex Key for Dogging..... 35
 Rim Replacement Head Cover 35

Accessories, 4700 Series Standard Duty

Bottom Latch Assembly..... 41
 Bottom Latch Cover 43
 Cylinder Cup Spacer 45PN/47PN 29, 44
 End Cap Replacement Pack..... 44
 Extension Rod Kit - 24" 42
 Extension Rod Kit - 36" 42
 Hex Key for Dogging..... 44
 Replacement Dogging Plates..... 42
 Replacement Head Covers..... 42
 Rod to Rod Connector 44
 Rod Guide Replacement..... 43
 Screwpacks 43-44
 Top Latch Assembly..... 41
 Top Latch Cover 43

Top or Bottom Rod Replacement Kit..... 42
 Trim Hanging Pin..... 43

C

Cylinders

Cylinder Collar, 4500 Trim 47-48
 Cylinder Collar, 4700 Trim 48
 Mortise..... 47
 Retaining Cup..... 47
 Rim..... 46

E

Exit Devices, Grade 1

How to Order 6
 4500 Rim Device 9
 4500 Mortise Lock Exit Device..... 12-13
 4500 Concealed Vertical Rod Device 11
 4500 Concealed Vertical Rod Device Less Bottom Rod 12
 4500 Dummy Push Pad Device..... 13
 4500 Surface Vertical Rod Device..... 10
 4500 Surface Vertical Rod Device Less Bottom Rod..... 9
 4500 Electric Modifications, Power Supplies, and Alarmed
 Devices 4-5

Exit Devices, Grade 1 Narrow Stile

How to Order 7
 4600 Narrow Stile Rim Device..... 30
 4600 Electric Modifications, Power Supplies, and Alarmed
 Devices 4-5
 4500 Dummy Push Pad Device..... 13

Exit Devices, Standard Duty

How to Order 8
 4700 Rim Device 36
 4700 Surface Vertical Rod Device..... 36

M

Mullions

Mullion Set - Keyed Removable 45
 Mullion Set - Non-Keyed Removable 45
 Mullion Tube - Keyed Removable 46
 Mullion Tube - Non-Keyed Removable 45
 Stabilizer - Keyed Removable 46
 Stabilizer - Non-Keyed Removable 45
 Top/Bottom Bracket Set - Keyed Removable..... 46
 Top/Bottom Bracket Set - Non-Keyed Removable 45



Exit Devices

S

Shim Kit, 4500 Series Grade 1

Shim Kit, Rim Device.....	24
Shim Kit, Surface Vertical Rod.....	24

Shim Kit, 4600 Series Grade 1 Narrow Stile

Shim Kit, Narrow Stile Rim Device.....	34
--	----

Shim Kit, 4700 Series Standard Duty

Shim Kit, Rim Device.....	42
Shim Kit, Surface Vertical Rod.....	42

Strikes, 4500 Series Grade 1

Concealed Vertical Rod, Top Strike, Fire Rated.....	26
Concealed Vertical Rod, Top Strike, Standard.....	26
Double Door Strike, Standard.....	22
Mortise Device, Fire Rated.....	29
Mortise Device, Standard.....	29
Mullion, Strikes.....	45, 46
Rim Device, Fire Rated.....	22
Rim Device, Standard.....	22
Surface Vertical Rod, Bottom Strike, Fire Rated.....	23
Surface Vertical Rod, Bottom Strike, Standard.....	23
Surface Vertical Rod, Top Strike, Fire Rated.....	23
Surface Vertical Rod, Top Strike, Standard.....	23
Threshold Strike, Standard.....	22

Strikes, 4600 Series Grade 1 Narrow Stile

Blade Stop.....	34
Rim, Fire Rated.....	33
Rim, Standard.....	33
Semi-Flush Mount.....	34
Single Rabbit.....	34

Strikes, 4700 Series Standard Duty

Double Door Strike, Standard.....	41
Mullion, Strikes.....	45, 46
Rim Device, Standard.....	41
Surface Vertical Rod, Bottom Strike, Standard.....	41
Surface Vertical Rod, Top Strike, Standard.....	41
Threshold Strike, Standard.....	41

T

Trim, 4500 Series Grade 1

Anti-Vandal Pull.....	22
Blank Escutcheon.....	13-14
Blank Escutcheon, Mortise.....	14-15
Cylinder Escutcheon.....	15-16
Cylinder Escutcheon, Mortise.....	16-17
Dummy Trim.....	17-18
Dummy Trim, Mortise.....	18-19
Night Latch.....	19-20
Night Latch, Mortise.....	20-21
Pull Plate Trim.....	21

Trim, 4600 Series Grade 1 Narrow Stile

Blank Escutcheon.....	30
Cylinder Escutcheon.....	31
Dummy Trim.....	31-32
Night Latch.....	32-33
Night Lever.....	32

Trim, 4700 Series Standard Duty

Blank Escutcheon.....	36
Cylinder Escutcheon.....	37
Dummy Trim.....	37
Key-In-Lever Trim.....	38-40
Night Latch.....	38
Pull Plate Trim.....	40
Raised Lip - Dummy.....	41
Raised Lip - Night Latch.....	41



INTRODUCTION

Every model in Hager's line of exit devices is designed and engineered to assure you and your customers years of superior performance. Hager exit devices use fewer moving parts and are constructed with high-quality features--like die cast caps on our lifetime warranty Grade 1 devices, and die cast head covers on all our models. All Hager exit devices meet UL specifications for panic devices and are fire rated for up to three hours.

Hager exit devices were designed with ease of installation in mind. We package our exit devices for convenience and versatility, with thru-bolts included for every model, slotted strikes, and non-handed designs. Hager offers escutcheon trim available in four functions, along with many other trim options.

Quick Ship

Products denoted with **red and bold** pricing are available to order through the Quick Ship program and ship within 24 hours. When ordering these products please visit www.hagerco.com and log in to MyHager to access the 'Quick Ship' portal. Due to the promptness of the fulfillment process, Quick Ship orders are non-cancellable.

Lead Times

Stock items will typically ship in five working days or less from the order entry date. Made-to-order items will typically ship in 15 working days depending on seasonal volume and order complexity. Special orders including industrials, special machining, and large quantities may need to be scheduled. The anticipated ship date will be included with each order acknowledgement. Please contact Customer Service if product availability is in question.

Cancellation Notification

Cancellation for made-to-order items must be communicated within 48 hours of order placement.

New Finish

Painted flat black finish (BHMA 693) is now available. Use BLK to designate finish. Extended lead time and MOQ may apply.

APPLICATIONS

Single Door with Rim Exit Device

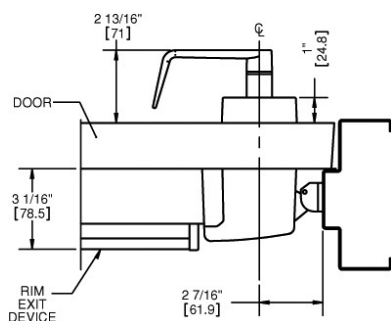

Double Door with Two Surface Vertical Rod Exit Devices

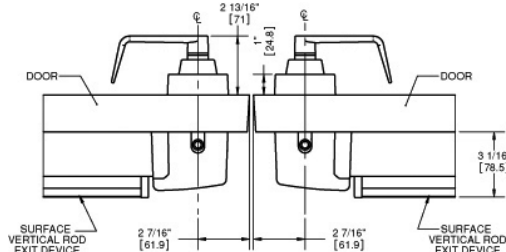

Double Door with Rim Exit Device and Surface Vertical Rod Exit Device

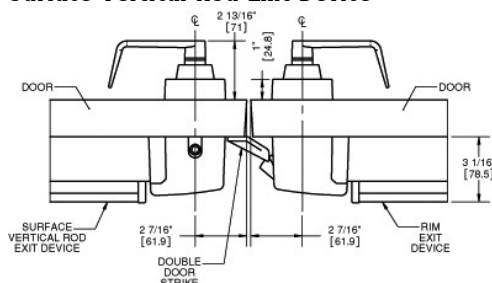

Double Door with Mullion

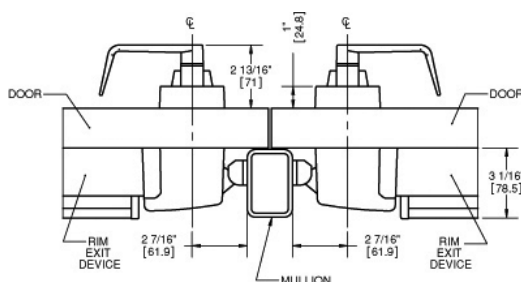

Exit Devices

ELECTRIC MODIFICATIONS - For use with 4500 Series and 4600 Series exit devices

FUNCTION	FUNCTION #	DESCRIPTION	ADD TO LIST PRICE
Electric Latch Retraction	ELR	Provides the means of locking or unlocking exit devices remotely. Requires the use of Hager 2901 or 2902 power supply or warranty voided. <i>Note: Mortise Exits will require Motor Driven Latch Retraction.</i>	\$908.45
Electric Dogging	ED	Provides continuous latch retraction and dogging simultaneously.	\$721.90
Request to Exit	RX	Used to shunt an alarm, activate an alarm, provide release of magnetic locks, or signal a console.	\$290.45
Electric Latch Retraction with Request to Exit	ELRX	Provides the means of locking or unlocking exit devices remotely, along with an SPDT switch. Requires the use of Hager 2901 or 2902 power supply or warranty voided. <i>Note: Mortise Exits will require Motor Driven Latch Retraction.</i>	\$1,036.70
Electric Dogging with Request to Exit	EDRX	Provides continuous latch retraction and dogging simultaneously along with an SPDT switch.	\$873.45
Dual Request to Exit	RX2	Features two SPDT switches	\$348.75
Latchbolt Monitoring	LM	An internal SPDT switch that monitors the latchbolt to signal both egress and access of an opening	\$290.45
Latchbolt Monitoring/ Request to Exit	RXLM	Two internal SPDT switches that monitor the latchbolt and the pushbar simultaneously	\$360.40
Electric Trim*	ET*	Provides the means of locking or unlocking outside lever trim controls remotely. Specify Fail Safe (EL) or Fail Secure (EU) and voltage (12V or 24V).	\$535.30
Authorized Ingress/Key Monitoring*	AI*	An internal SPDT switch that monitors the operation of the outside trim, available for use with either the 45BE, 45CE or 45NL trim or nightlatch by optional pull. Must be ordered with the device.	\$302.10
Request to Exit/Authorized Ingress*	RXAI*	Two internal SPDT switches that monitor the pushbar and the outside trim simultaneously, available for use with either the 45CE or 45NL trim. Must be ordered with the device.	\$360.40
Delayed Egress	DE	Delays egress for 15 or 30 seconds when unauthorized egress is initiated. Wall mount controller (2-679-0630) provides digital countdown display with verbal instructions or alarm tone only and must be ordered seperately, list price \$1,404.50.	\$1,272.00
Onboard Delayed Egress	OBDE	Delays egress for 15 seconds (30 seconds optional) when unauthorized egress is initiated. Modification can be made to 4501 or 4601 exit devices.	\$2,856.70

*Available on 4500 Series only.



ELECTRIC MODIFICATIONS (CONTINUED)

FUNCTION	FUNCTION #	DESCRIPTION	ADD TO LIST PRICE
Motor Driven Electric Latch Retraction	MLR	Provides the means of locking or unlocking exit devices remotely using an electric motor. Recommend Hager 2903 or 2904 Power Supply.	\$1,090.25
Motor Driven Electric Latch Retraction with Request to Exit	MLRX	Provides the means of locking or unlocking exit devices remotely using an electric motor, along with an SPDT switch. Recommend Hager 2903 or 2904 Power Supply.	\$1,234.40
Electrified Mortise Exit Device	EU/EL	Provides the means of locking or unlocking outside lever trim controls remotely. Specify Fail Safe (EL) or Fail Secure (EU) and voltage (12V or 24V).	\$535.30

POWER SUPPLIES

PRODUCT #	DESCRIPTION	LIST PRICE
2901	For use with 4500/4600 Series electric latch retraction (ELR)	Reference Electrified Products for Pricing
2902	For use with 4500/4600 Series electric latch retraction in a day/night mode of operation (ELR)	Reference Electrified Products for Pricing
2903	Provides 24 Volt DC power for Fail Safe or Fail Secure locking devices and interface with building alarm controls, card readers, keypads, and other door controls	Reference Electrified Products for Pricing
2904	Provides 24 Volt DC power and control for openings with an electrified locking device and automatic door operator	Reference Electrified Products for Pricing
2908	Provides up to 1 amp of 12 or 24 Volt DC power.	Reference Electrified Products for Pricing
2909	Provides up to 2 amps of 12 or 24 Volt DC power.	Reference Electrified Products for Pricing

QUICK CONNECT

Available for use with 4500 and 4600 Series AI (4500 only), ED, ELR, LM, MLR, and RX. Compatible with Hager Quick Connect Harness Cables which can plug into Hager hinges with quick connect for quick and accurate wiring of the door. No additional charge.

ALARMED DEVICES**4501/4601 ALK - Alarm Kit**

Add \$337.10 to the list price of the device

4501/4601 ALM - ALK with Latch Monitor Switch (recommended for use with SVR devices)

Add \$452.65 to the list price of the device

4501/4601 ALT - ALK with Tamper Switch

Add \$454.65 to the list price of the device

4501/4601 ALL - ALK with Latch Monitor and Tamper Switch

Add \$568.20 to the list price of the device

Note: Alarm kit components may be purchased separately.



Exit Devices

4500 SERIES HOW TO ORDER

4501	RIM	F	36"	US3	1-3/4"	ELR
Product Group	Type	Rating	Door Size**	Finish	Door Thickness	Electric Modifications
4500 Series, Grade 1	RIM - Rim Device SVR - Surface Vertical Rod LBR - Surface Vertical Rod Less Bottom Rod * CVR - Concealed Vertical Rod CLB - Concealed Vertical Rod Less Bottom Rod * DMY - Dummy Push Pad MRT - Mortise Device (MC, MB, MD) MRTN - Mortise Night Latch Device (MN)	FR - Fire-Rated 0 - Non-Fire Rated CD - Cylinder Dogging L - Less Dogging WR - Windstorm Rated W - Windstorm and Fire-Rated	36" 48" 36" x 84" 36" x 96" 48" x 84" 48" x 96"	US3 US4 US10 US10B US26 US26D US32D BLK (New)	1-5/8" 1-3/4" 2" 2-1/2" 3"	AI - Authorized Ingress *** ALK - Alarm Kit ALL - Alarm Kit w/ Tamper Switch and Latch Monitor ALM - Alarm Kit w/ Latch Monitor ALT - Alarm Kit w/ Tamper Switch ED - Electric Dogging EDRX - Electric Dogging w/ Request to Exit ELR - Electric Latch Retraction ELRX - Electric Latch Retraction w/ Request to Exit LM - Latchbolt Monitor *** RX - Request to Exit RX2 - Dual Request to Exit RXAI - Request to Exit w/ Authorized Ingress *** RXLM - Request to Exit w/ Latchbolt Monitor *** MLR - Motor Driven Electric Latch Retraction MLRX - Motor Driven Electric Latch Retraction w/ Request to Exit

*Fire rated LBR and CLB devices must be ordered in pairs for the vertical rod devices or can be used in conjunction with an approved automatic or constant latching flush bolt. When ordering pairs, specify one device LBR and second device LBR with fire bolt, for example: 4501 LBR Fire 36" x 84" plus 4501 LBR Fire 36" x 84" EO with bolt -OR- 4501 LBR Fire 36" x 84" plus an approved automatic or constant latching flush bolt. Add \$50.35 to list price for firebolt kit.

** Exits for doors available. For more details, please call Hager Customer Service. Add \$383.75 to 36" list price. (Requires extended lead-time).

*** Not available on Mortise devices

4500 SERIES TRIM HOW TO ORDER

45	CE	ARC	US3	1-3/4"	EL24
Product Group	Trim/Function	Lever Style	Finish	Door Thickness	Options
BE - Blank Escutcheon Function 14, always operable	CE - Cylinder Escutcheon Function 08, key locks/unlocks	ARC - Archer AUG - August WLM - William WTN - Withnell CHA - Charles JHN - Johnston** JOS - Joshua LOU - Louis WRN - Warren**	US3 US4 US10 US10B US26 US26D US32D (pull plate trim only) BLK (New)	1-5/8" 1-3/4" 2" 2-1/2" 3"	EL12 - Fail Safe, 12 Volt *** EL24 - Fail Safe, 24 Volt *** EU12 - Fail Secure, 12 Volt *** EU24 - Fail Secure, 24 Volt *** TW - Tactile Warning A - Antimicrobial Coating US26D & US32D only
DT - Dummy Trim Function 02, pull when dogged down	ET - Electric Escutcheon Trim				
NL - Night Latch (1-3/4" to 2-1/2" doors) Function 03, key retracts latchbolt	PD - Pull Plate Dummy Trim (Not available for CVR device) Function 02, pull when dogged down				
PN - Pull Plate Night Latch (Not available for CVR device) Function 03, key retracts latchbolt	PT - Thumbpiece Entrance (Not available for CVR device) Function 05, key locks or unlocks thumbpiece				
VR - Vandal Resistant	MB - Mortise Blank Escutcheon (14)* MC - Mortise Cylinder Escutcheon (08)* MD - Mortise Dummy Trim (02)* MN - Mortise Night Latch (03)*				

* Mortise trim does not match centerline of other 4500 series trim. Cannot be used with 4500 Series Rim or Vertical Rod devices.

** Johnston and Warren lever designs are handed - specify LHR/RH or RHR/LH when ordering.

*** Not available on Mortise Exit trim

Notes:

- Mortise cylinder 3902 is required for use with cylinder escutcheon trim and pull plate with thumb piece trim and is sold separately.
- Rim cylinder with long tailpiece 3901 is required for use with night latch trim and is sold separately.
- For more cylinder information, please refer to general information in the Locks section of the catalog.
- If using shim kit, specify total door thickness including shims.
- For ET trim, must specify Fail Safe (EL) or Fail Secure (EU) and 12 or 24 volt.
- NEW - Flat Black Finish (BHMA 693). Priced same as US10B. Extended lead times may apply.**

4600 SERIES HOW TO ORDER

4601

Product Group
4600 Series, Grade 1

RIM

Type
RIM - Rim Device

F

Rating
F - Fire Rated
O - Non-Fire Rated
C - Cylinder Dogging
L - Less Dogging

36"

Size
36"
48"

US3

Finish
US3
US4
US10
US10B
US26
US26D
US32D

BLK (New)

Door Thickness

1-5/8"
1-3/4"
2"

1-3/4"

ELR

Electric Modifications

ALK - Alarm Kit
ALL - Alarm Kit w/ Tamper Switch and Latch Monitor
ALM - Alarm Kit w/ Latch Monitor
ALT - Alarm Kit w/ Tamper Switch
ED - Electric Dogging
EDRX - Electric Dogging w/ Request to Exit
ELR - Electric Latch Retraction
ELRX - Electric Latch Retraction w/ Request to Exit
LM - Latchbolt Monitor
RX - Request to Exit
RX2 - Dual Request to Exit
RXLM - Request to Exit w/ Latchbolt Monitor
MLR - Motor Driven Electric Latch Retraction
MLRX - Motor Driven Electric Latch Retraction w/ Request to Exit

4600 SERIES TRIM HOW TO ORDER

4600 SERIES TRIM

46

Product Group
46 - 4600 Series, Grade 1

CE

Trim/Function

BE - Blank Escutcheon
Function 14, always operable
CE - Cylinder Escutcheon
Function 08, key locks/unlocks lever
DT - Dummy Trim
Function 02, pull when dogged down
NL - Night Latch (Not available for 3" door)
Function 03, key retracts latchbolt
(for use with 4600 Rim Device only)
NK - Night Lever, Function 09, key releases lever,
lever locked when key is removed

ARC

Lever Style

ARC - Archer
AUG - August
WLM - William
WTN - Withnell

US3

Finish
US3
US4
US10
US10B
US26
US26D

BLK (New)

1-3/4"

Door Thickness

1-5/8"
1-3/4"
2"
2-1/2"
3"

TW

Options

TW - Tactile Warning
A - Antimicrobial
Coating - US26D & US32D only

Notes:

1. Mortise cylinder 3902 with 3976 L cam is required for use with cylinder escutcheon trim and is sold separately.
2. Rim cylinder 3901 with long tailpiece is required for use with night latch trim and is sold separately.
3. For more cylinder information, please refer to general information in the Locks section of the catalog.
4. If using shim kit, specify total door thickness including shims.
5. **NEW - Flat Black Finish (BHMA 693). Priced same as US10B. Extended lead times may apply.**



Exit Devices

4700 SERIES HOW TO ORDER

4701	RIM	F	36"	US3	2"
Product Group	Type	Rating	Size	Finish	Door Thickness
4700 Series, Standard Duty	RIM - Rim Device SVR - Surface Vertical Rod	F - Fire Rated 0 - Non-Fire Rated	36" 48" 36" x 84" 36" x 96" 48" x 84" 48" x 96"	US3 US32D ALM DBZ	1-5/8" 1-3/4" 2" 2-1/4"

4700 SERIES TRIM HOW TO ORDER

47	CE	RH	ARC	US3	2"	TW
Product Group	Trim/Function	Handing	Lever Style	Finish	Door Thickness	Options
47 - 4700 Series, Standard Duty	CE - Cylinder Escutcheon BE - Blank Escutcheon NL - Night Latch DT - Dummy Trim KD - Key in Lever - Dummy Trim KE - Key in Lever - Entrance KN - Key in Lever - Night Latch KP - Key in Lever - Passage PD - Pull Plate Dummy Trim PN - Pull Plate Night Latch RD - Raised Lip Pull - Dummy Trim RN - Raised Lip Pull - Night Latch BT - Thumbpiece Pull Plate, Passage PT - Thumbpiece Pull Plate, Entrance	RH - Right Handed / LHR LH - Left Handed / RHR	ARC - Archer AUG - August WTN - Withnell APL - Apollo knob	US3 US32D ALM DBZ	1-5/8" 1-3/4" 2" 2-1/4"	TW - Tactile Warning

Notes:

1. Handing is required for the 4700 Series trim.
2. Mortise cylinder, 3902, is sold separately.
3. For more cylinder information, please refer to General Information in the lock section of the catalog.
4. Maximum door thickness compatibility for key-in-lever (Entrance, Night Latch, and Passage) trim is 1-3/4" (44 mm)





Description	Length	Finish	2018 List	Stock No.	List Fire Rated	Stock No.	Case Qty.
4501 RIM	36"	US3	996.40	158092	1137.95	158111	3
4501 RIM	Exit Only	US4	996.40	158094	1137.95	158107	
Grade 1		US10	996.40	158087	1137.95	115725	
Non-Handed		US10B	996.40	158088	1137.95	158103	
		US26	996.40	158089	1137.95	158109	
Cylinder Dogging (specify CD), add \$43.10 to list price. 3902 mortise cylinder with standard cam must be ordered separately.		US26D	961.95	158090	1101.90	158104	
		US32D	996.40	158093	1137.95	158105	
	48"	US3	1031.95	156140	1181.90	156145	3
Exit Only		US4	1031.95	156141	1181.90	156146	
		US10	1031.95	156138	1181.90	156142	
Severe Windstorm Rated device, add \$53.90 to list price and specify WR.		US10B	1031.95	156139	1181.90	156143	
		US26	1031.95	158180	1181.90	156144	
Refer to page 4 for electric modification pricing.		US26D	1007.00	156135	1144.80	154983	
		US32D	1031.95	156136	1181.90	156137	
Anti-microbial coating - add \$46.65 to list price.							



4501 SVR LBR	36" x 84"	US3	1468.10	129450	1591.10	126690	3
Grade 1	Exit Only	US4	1468.10	131538	1591.10	135130	
Non-Handed		US10	1468.10	130713	1591.10	144325	
		US10B	1468.10	127645	1591.10	126438	
Cylinder Dogging (specify CD), add \$43.10 to list price. 3902 mortise cylinder with standard cam must be ordered separately.		US26	1468.10	-	1591.10	146277	
		US26D	1355.75	124387	1487.75	124389	
		US32D	1468.10	124388	1591.10	170442	
	36" x 96"	US3	1522.70	-	1662.65	-	3
Exit Only		US4	1522.70	152521	1662.65	173396	
Fire rated LBR devices must be ordered in pairs of less bottom rod vertical rod devices and with a spring loaded fire latch (Part # 2-649-0166 - add \$50.35 to list price) to ensure the device's fire rating.		US10	1522.70	-	1662.65	153887	
		US10B	1522.70	143515	1662.65	126441	
		US26	1522.70	-	1662.65	155427	
		US26D	1443.20	127422	1573.60	133810	
		US32D	1522.70	133952	1662.65	124391	
	48" x 84"	US3	1573.60	-	1707.15	146813	3
Exit Only		US4	1573.60	131540	1707.15	147614	
Refer to page 4 for electric modification.		US10	1573.60	148071	1707.15	-	
Refer to page 25 for extension rod kits for doors over 8 feet in height. Note that these are not fire rated for the LBR.		US10B	1573.60	161824	1707.15	127646	
		US26	1573.60	-	1707.15	-	
		US26D	1487.75	129506	1608.55	127252	
		US32D	1573.60	138585	1707.15	156237	
Anti-microbial coating - add \$46.65 to list price.	48" x 96"	US3	1601.70	-	1733.10	-	3
Exit Only		US4	1601.70	-	1733.10	141078	
		US10	1601.70	-	1733.10	-	
		US10B	1601.70	173468	1733.10	137024	
		US26	1601.70	-	1733.10	-	
		US26D	1573.60	147312	1662.65	129948	
		US32D	1601.70	149138	1733.10	138708	

1. Items with the price in **bold and red** are Quick Ship items and ship in 24 hours. Please use stock number when ordering. 2. U/M is each unless otherwise noted.



Exit Devices - 4500



Description	Length	Finish	2018 List	Stock No.	List Fire Rated	Stock No.	Case Qty.	
4501 SVR Grade 1 Non-Handed Cylinder Dogging (specify CD), add \$43.10 to list price. 3902 mortise cylinder with standard cam must be ordered separately.	36" x 84"	US3	1468.10	157344	1591.10	157393	3	
	Exit Only	US4	1468.10	157346	1591.10	157395		
		US10	1468.10	157398	1591.10	169257		
	Severe Windstorm Rated device, add \$53.90 to list price and specify WR. Refer to page 4 for electric modification.	Exit Only	US10B	1468.10	157341	1591.10	157422	
			US26	1468.10	157342	1591.10	158058	
			US26D	1355.75	157343	1487.75	157392	
			US32D	1468.10	157345	1591.10	157394	
	Refer to page 25 for extension rod kits for doors over 8 feet in height.	36" x 96"	US3	1522.70	157400	1662.65	157426	3
		Exit Only	US4	1522.70	157401	1662.65	158068	
			US10	1522.70	157548	1662.65	158064	
Anti-microbial coating - add \$46.65 to list price.		Exit Only	US10B	1522.70	157399	1662.65	157424	
			US26	1522.70	157568	1662.65	157425	
			US26D	1443.20	157390	1573.60	157396	
48" x 84"	Exit Only	US32D	1522.70	157391	1662.65	157397		
		US3			1744.80	157419	3	
		US4			1744.80	157421		
		US10			1744.80	157402		
		US10B			1744.80	157887		
		US26			1744.80	157417		
		US26D			1625.00	157418		
US32D			1744.80	157420				
48" x 96"	Exit Only	US3	1573.60	157895	1707.15	156229	3	
		US4	1573.60	156152	1707.15	158070		
		US10	1573.60	157734	1707.15	158070		
		US10B	1573.60	156149	1707.15	154982		
		US26	1573.60	156150	1707.15	156227		
		US26D	1487.75	156147	1608.55	156148		
		US32D	1573.60	156151	1707.15	156230		
48" x 120"	Exit Only	US3	1601.70	157901	1733.10	158076	3	
		US4	1601.70	157906	1733.10	156235		
		US10	1601.70	157899	1733.10	158075		
		US10B	1601.70	157900	1733.10	156231		
		US26	1601.70	156153	1733.10	156232		
		US26D	1573.60	156154	1662.65	156233		
		US32D	1601.70	157905	1733.10	156234		
48" x 120"	Exit Only	US3			1818.45	156224	3	
		US4			1818.45	156226		
		US10			1818.45	156155		
		US10B			1818.45	156156		
		US26			1818.45	156157		
		US26D			1692.85	158069		
		US32D			1818.45	156225		



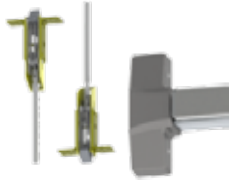

Description	Length	Finish	2018 List	Stock No.	List Fire Rated	Stock No.	Case Qty.	
4501 CVR Grade 1 - for wood or metal doors Non-Handed Cylinder Dogging (specify CD), add \$43.10 to list price. 3902 mortise cylinder with standard cam must be ordered separately.	36" x 84"	US3	1845.50	149481	2068.10	149489	3	
	Exit Only	US4	1845.50	149482	2068.10	149512		
		US10	1845.50	149484	2068.10	150548		
		US10B	1845.50	149310	2068.10	150549		
		US26	1845.50	149485	2068.10	150550		
		US26D	1845.50	149305	2068.10	173051		
		US32D	1845.50	149312	2068.10	149313		
	36" x 96"	US3	1884.70	150573	2107.30	150763	3	
		Exit Only	US4	1884.70	150574	2107.30	149314	
			US10	1884.70	150758	2107.30	150764	
		US10B	1884.70	151032	2107.30	149315		
		US26	1884.70	150760	2107.30	150765		
		US26D	1884.70	150761	2107.30	149316		
US32D		1884.70	150762	2107.30	149317			
48" x 84"	US3	1920.75	168177	2143.35	150783	3		
	Exit Only	US4	1920.75	168179	2143.35	150784		
		US10	1920.75	168173	2143.35	150785		
		US10B	1920.75	168174	2143.35	150786		
		US26	1920.75	168175	2143.35	150787		
		US26D	1920.75	168176	2143.35	150788		
		US32D	1920.75	168178	2143.35	156236		
	48" x 96"	US3	1959.95	168182	2182.55	150796	3	
Exit Only		US4	1959.95	168184	2182.55	150797		
		US10	1959.95	168180	2182.55	150798		
		US10B	1959.95	168172	2182.55	150799		
		US26	1959.95	168181	2182.55	150800		
		US26D	1959.95	168167	2182.55	150801		
US32D		1959.95	168183	2182.55	150802			

1. Items with the price in **bold and red** are Quick Ship items and ship in 24 hours. Please use stock number when ordering. 2. U/M is each unless otherwise noted.



Exit Devices - 4500



Description	Length	Finish	2018 List	Stock No.	List Fire Rated	Stock No.	Case Qty.	
4501 CLB Grade 1 - for wood or metal doors Non-Handed Cylinder Dogging (specify CD), add \$43.10 to list price. 3902 mortise cylinder with standard cam must be ordered separately.	36" x 84"	US3	1845.80	-	2068.10	-	3	
	Exit Only	US4	1845.80	-	2068.10	-		
		US10	1845.80	-	2068.10	-		
	Fire rated LBR devices must be ordered in pairs of less bottom rod vertical rod devices and with a spring loaded fire bolt (Part # 2-649-0166, add \$50.35 to list price) to ensure the device's fire rating.	Exit Only	US10B	1845.80	161859	2068.10	-	
			US26	1845.80	-	2068.10	-	
			US26D	1845.80	161858	2068.10	161863	
			US32D	1845.80	161854	2068.10	161871	
	Refer to page 4 for electric modification pricing.	Exit Only	US3	1884.70	-	2107.30	-	3
			US4	1884.70	-	2107.30	-	
			US10	1884.70	-	2107.30	-	
US10B			1884.70	-	2107.30	161874		
US26			1884.70	-	2107.30	-		
US26D			1884.70	161872	2107.30	161875		
Refer to page 25 for extension rod kits for doors over 8 feet in height	Exit Only	US32D	1884.70	161873	2107.30	161876		
		US3	1920.75	-	2143.35	-	3	
		US4	1920.75	-	2143.35	-		
		US10	1920.75	-	2143.35	-		
Anti-microbial coating - add \$46.65 to list price.	Exit Only	US10B	1920.75	169856	2143.35	-		
		US26	1920.75	-	2143.35	-		
		US26D	1920.75	161877	2143.35	173691		
		US32D	1920.75	-	2143.35	161879		
Mortise Lock Exit Devices Grade 1 Non-Handed Cylinder Dogging (specify CD), add \$43.10 to list price. 3902 mortise cylinder with standard cam must be ordered separately. Refer to page 4 for electric modification pricing. Anti-microbial coating - add \$46.65 to list price.	Exit Only	US3	1920.75	-	2143.35	-	3	
		US4	1920.75	-	2143.35	-		
		US10	1920.75	-	2143.35	-		
		US10B	1920.75	169856	2143.35	-		
		US26	1920.75	-	2143.35	-		
		US26D	1920.75	161877	2143.35	173691		
		US32D	1920.75	-	2143.35	161879		
4501 M (Pair with MB, MC, MD trim)	Exit Only	US3	1920.75	-	2143.35	-	3	
		US4	1920.75	-	2143.35	-		
		US10	1920.75	-	2143.35	-		
		US10B	1920.75	169856	2143.35	-		
		US26	1920.75	-	2143.35	-		
		US26D	1920.75	161877	2143.35	173691		
		US32D	1920.75	-	2143.35	161879		
4501 M (Pair with MB, MC, MD trim)	Exit Only	US3	1920.75	-	2143.35	-	3	
		US4	1920.75	-	2143.35	-		
		US10	1920.75	-	2143.35	-		
		US10B	1920.75	169856	2143.35	-		
		US26	1920.75	-	2143.35	-		
		US26D	1920.75	161877	2143.35	173691		
		US32D	1920.75	-	2143.35	161879		
		US3	1920.75	-	2143.35	-	3	
		US4	1920.75	-	2143.35	-		
		US10	1920.75	-	2143.35	-		
US10B	1920.75	169856	2143.35	-				
US26	1920.75	-	2143.35	-				
US26D	1920.75	161877	2143.35	173691				
US32D	1920.75	-	2143.35	161879				
4501 M (Pair with MB, MC, MD trim)	Exit Only	US3	1920.75	-	2143.35	-	3	
		US4	1920.75	-	2143.35	-		
		US10	1920.75	-	2143.35	-		
		US10B	1920.75	169856	2143.35	-		
		US26	1920.75	-	2143.35	-		
		US26D	1920.75	161877	2143.35	173691		
		US32D	1920.75	-	2143.35	161879		
		US3	1920.75	-	2143.35	-	3	
		US4	1920.75	-	2143.35	-		
		US10	1920.75	-	2143.35	-		
US10B	1920.75	169856	2143.35	-				
US26	1920.75	-	2143.35	-				
US26D	1920.75	161877	2143.35	173691				
US32D	1920.75	-	2143.35	161879				

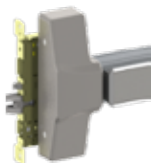

Mortise Lock Exit Devices

Grade 1
Non-Handed

Cylinder Dogging (specify CD), add \$43.10 to list price. 3902 mortise cylinder with standard cam must be ordered separately.

Refer to page 4 for electric modification pricing.
Anti-microbial coating - add \$46.65 to list price.

4501 M (Pair with MB, MC, MD trim)	Exit Only	US3	1851.85	162895	2035.75	162900	3		
		US4	1851.85	162897	2035.75	162901			
		US10	1851.85	162898	2035.75	162947			
		US10B	1851.85	162807	2035.75	162829			
		US26	1851.85	162899	2035.75	162948			
		US26D	1787.70	162827	1966.85	162830			
		US32D	1851.85	162828	2035.75	162831			
		48"	Exit Only	US3	1876.20	162949	2060.15	162953	3
				US4	1876.20	162950	2060.15	162954	
				US10	1876.20	162951	2060.15	163724	
US10B	1876.20			162832	2060.15	162836			
US26	1876.20			162952	2060.15	162956			
US26D	1812.10			162833	1989.10	162835			
US32D	1876.20			162834	2060.15	162837			



Description	Length	Finish	2018 List	Stock No.	List Fire Rated	Stock No.	Case Qty.
4501 N (Pair with MN trim)	36"	US3	1851.85	-	2035.75	-	3
		Exit Only	US4	1851.85	-	2035.75	-
		US10	1851.85	-	2035.75	-	
		US10B	1851.85	163023	2035.75	163735	
		US26	1851.85	-	2035.75	-	
		US26D	1787.70	163737	1966.85	163544	
		US32D	1851.85	163736	2035.75	163524	
48"	Exit Only	US3	1876.20	-	2060.15	-	3
		US4	1876.20	-	2060.15	-	
		US10	1876.20	-	2060.15	-	
		US10B	1876.20	163734	2060.15	163731	
		US26	1876.20	-	2060.15	-	
		US26D	1812.10	163733	1989.10	163730	
		US32D	1876.20	163732	2060.15	163729	
4501 D Dummy Push Pad Non-handed For use with 4500 and 4600 Series Exit Devices	36"	US3	628.05	149393			3
		US10B	628.05	149392			
		US26D	551.20	149391			
		US32D	628.05	149390			
		48"	US3	652.45	149397		
Anti-microbial coating - add \$46.65 to list price.	48"	US10B	652.45	149396			
		US26D	575.60	149395			
		US32D	652.45	149394			
45BE Blank Escutcheon Tactile Warning - add \$42.40 to list price. Anti-microbial coating - add \$46.65 to list price.							
Archer Lever	14"	Always	US3	508.80	122812		6
		Operable	US4	508.80	122814		
			US10	508.80	122804		
			US10B	508.80	122806		
			US26	508.80	122808		
			US26D	489.75	122810		
August Lever	14"	US3	508.80	122796			6
		US4	508.80	122797			
		US10	508.80	122792			
		US10B	508.80	122793			
		US26	508.80	122794			
		US26D	489.75	122795			
Charles Lever	14"	US3	508.80	-			6
		US4	508.80	-			
		US10	508.80	-			
		US10B	508.80	178079			
		US26	508.80	-			
		US26D	489.75	176196			
Johnston Lever (must specify handling)	14"	US3	508.80	-	508.80	-	6
		US4	508.80	178146	508.80	-	
		US10	508.80	178136	508.80	178142	
		US10B	508.80	177946	508.80	177951	
		US26	508.80	178130	508.80	178133	
		US26D	489.75	177384	489.75	177387	



1. Items with the price in **bold and red** are Quick Ship items and ship in 24 hours.
Please use stock number when ordering. 2. U/M is each unless otherwise noted.



Exit Devices - 4500

Description	Function	Finish	2018 List	Stock No. LHR	Stock No. RHR	Case Qty.	
Joshua Lever		US3	508.80	-		6	
		US4	508.80	-			
		US10	508.80	-			
		US10B	508.80	178087			
		US26	508.80	-			
		US26D	489.75	178084			
Louis Lever	14 Always Operable	US3	508.80	177349		6	
		US4	508.80	177356			
		US10	508.80	177291			
		US10B	508.80	177296			
		US26	508.80	177301			
		US26D	489.75	177305			
Warren Lever		US3	508.80	-	508.80	-	6
		US4	508.80	-	508.80	-	
		US10	508.80	-	508.80	-	
		US10B	508.80	178053	508.80	178057	
		US26	508.80	-	508.80	-	
		US26D	489.75	178031	489.75	178048	
William Lever		US3	508.80	165845		6	
		US4	508.80	165846			
		US10	508.80	165841			
		US10B	508.80	165842			
		US26	508.80	165843			
		US26D	489.75	165844			
Withnell Lever		US3	508.80	122813		6	
		US4	508.80	122815			
		US10	508.80	122805			
		US10B	508.80	122807			
		US26	508.80	122809			
		US26D	489.75	122811			

Description	Function	Finish	2018 List	Stock No.	Case Qty.	
45MB						
Blank Escutcheon for use with 4501M Mortise Lock Exit Device Mortise trim does not match centerline of other 4500 Series trim Tactile Warning - add \$42.40 to list price. Anti-microbial coating - add \$46.65 to list price.						
Archer Lever	14 Always Operable	US3	508.80	163557		6
		US4	508.80	163596		
		US10	508.80	163600		
		US10B	508.80	163696		
		US26	508.80	163699		
		US26D	489.75	163559		
August Lever		US3	508.80	163593		6
		US4	508.80	163597		
		US10	508.80	163601		
		US10B	508.80	163697		
		US26	508.80	163700		
		US26D	489.75	163560		



Description	Function	Finish	2018 List	Stock No.	Case Qty.
William Lever		US3	508.80	163594	6
		US4	508.80	163598	
		US10	508.80	163602	
		US10B	508.80	163698	
		US26	508.80	163701	
		US26D	489.75	163624	
Withnell Lever		US3	508.80	163595	6
		US4	508.80	163599	
		US10	508.80	163695	
		US10B	508.80	163558	
		US26	508.80	163702	
		US26D	489.75	163561	



Description	Function	Finish	2018 List	Stock No. LHR	Stock No. RHR	Case Qty.	
45CE							
Cylinder Escutcheon							
Requires a 3902 mortise cylinder (with standard cam) sold separately							
Tactile Warning - add \$42.40 to list price.							
Anti-microbial coating - add \$46.65 to list price.							
Refer to page 4 for electric modification pricing.							
Archer Lever	08 Key locks or unlocks lever	US3	508.80	122824		6	
		US4	508.80	122826			
		US10	508.80	122816			
		US10B	508.80	122818			
		US26	508.80	122820			
		US26D	489.75	122822			
August Lever		US3	508.80	122802		6	
		US4	508.80	122803			
		US10	508.80	122798			
		US10B	508.80	122799			
		US26	508.80	122800			
		US26D	489.75	122801			
Charles Lever		US3	508.80	-		6	
		US4	508.80	-			
		US10	508.80	-			
		US10B	508.80	178080			
		US26	508.80	-			
		US26D	489.75	176193			
Johnston Lever (must specify handling)		US3	508.80	-	508.80	-	6
		US4	508.80	178147	508.80	-	
		US10	508.80	178137	508.80	178143	
		US10B	508.80	177948	508.80	177952	
		US26	508.80	178131	508.80	178134	
		US26D	489.75	177385	489.75	177386	

1. Items with the price in **bold and red** are Quick Ship items and ship in 24 hours.
Please use stock number when ordering. 2. U/M is each unless otherwise noted.



Exit Devices - 4500

Description	Function	Finish	2018 List	Stock No. LHR	Stock No. RHR	Case Qty.	
Joshua Lever		US3	508.80	-		6	
		US4	508.80	-			
		US10	508.80	-			
		US10B	508.80	178088			
		US26	508.80	-			
		US26D	489.75	178085			
Louis Lever	08 Key locks or unlocks lever	US3	508.80	177350		6	
		US4	508.80	177357			
		US10	508.80	177292			
		US10B	508.80	177298			
		US26	508.80	177302			
		US26D	489.75	177306			
Warren Lever		US3	508.80	-	508.80	-	6
		US4	508.80	-	508.80	-	
		US10	508.80	-	508.80	-	
		US10B	508.80	178054	508.80	178058	
		US26	508.80	-	508.80	-	
		US26D	489.75	178032	489.75	178049	
William Lever		US3	508.80	159126		6	
		US4	508.80	159127			
		US10	508.80	159128			
		US10B	508.80	159121			
		US26	508.80	159129			
		US26D	489.75	159109			
Withnell Lever		US3	508.80	122825		6	
		US4	508.80	122827			
		US10	508.80	122817			
		US10B	508.80	122819			
		US26	508.80	122821			
		US26D	489.75	122823			

Description	Function	Finish	2018 List	Stock No.	Case Qty.
45MC					
Cylinder Escutcheon for use with 4501M Mortise Lock Exit Device					
Mortise trim does not match centerline of other 4500 Series trim					
Requires a 3902 mortise cylinder (1-5/8" with standard cam) sold separately.					
Tactile Warning - add \$42.40 to list price.					
Anti-microbial coating - add \$46.65 to list price.					
Archer Lever	08 Key locks or unlocks lever	US3	508.80	163703	6
		US4	508.80	163708	
		US10	508.80	163711	
		US10B	508.80	163562	
		US26	508.80	163717	
		US26D	489.75	163523	
August Lever		US3	508.80	163704	6
		US4	508.80	163709	
		US10	508.80	163712	
		US10B	508.80	163715	
		US26	508.80	163718	
		US26D	489.75	163564	



Description	Function	Finish	2018 List	Stock No.	Case Qty.
William Lever		US3	508.80	163705	6
		US4	508.80	163625	
		US10	508.80	163713	
		US10B	508.80	163716	
		US26	508.80	163719	
		US26D	489.75	163626	
Withnell Lever		US3	508.80	163707	6
		US4	508.80	163710	
		US10	508.80	163714	
		US10B	508.80	163563	
		US26	508.80	163720	
		US26D	489.75	163565	



Description	Function	Finish	2018 List	Stock No. LHR	Stock No. RHR	Case Qty.	
45DT Dummy Trim Tactile Warning - add \$42.40 to list price. Anti-microbial coating - add \$46.65 to list price.							
Archer Lever	02 Pull when device is dogged down	US3	508.80	14036		6	
		US4	508.80	14023			
		US10	508.80	14049			
		US10B	508.80	14038			
		US26	508.80	60033			
		US26D	489.75	60018			
August Lever		US3	508.80	107837		6	
		US4	508.80	107838			
		US10	508.80	107833			
		US10B	508.80	107834			
		US26	508.80	107835			
		US26D	489.75	107836			
Charles Lever		US3	508.80	-		6	
		US4	508.80	-			
		US10	508.80	-			
		US10B	508.80	178082			
		US26	508.80	-			
		US26D	489.75	178078			
Johnston Lever		US3	508.80	-	508.80	-	6
		US4	508.80	178148	508.80	-	
		US10	508.80	178138	508.80	178144	
		US10B	508.80	177949	508.80	177953	
		US26	508.80	178132	508.80	178135	
		US26D	489.75	177937	489.75	177940	
Joshua Lever		US3	508.80	-		6	
		US4	508.80	-			
		US10	508.80	-			
		US10B	508.80	178089			
		US26	508.80	-			
		US26D	489.75	178086			

1. Items with the price in **bold and red** are Quick Ship items and ship in 24 hours.
Please use stock number when ordering. 2. U/M is each unless otherwise noted.



Exit Devices - 4500

Description	Function	Finish	2018 List	Stock No. LHR	Stock No. RHR	Case Qty.
Louis Lever	02	US3	508.80	177354		6
	Pull when device is dogged down	US4	508.80	177358		
		US10	508.80	177295		
		US10B	508.80	177299		
		US26	508.80	177303		
		US26D	489.75	177307		
Warren Lever	US3	508.80	-	508.80	-	6
	US4	508.80	-	508.80	-	
	US10	508.80	-	508.80	-	
	US10B	508.80	178055	508.80	178059	
	US26	508.80	-	508.80	-	
	US26D	489.75	178046	489.75	178050	
William Lever	US3	508.80	159142			6
	US4	508.80	165851			
	US10	508.80	165847			
	US10B	508.80	165848			
	US26	508.80	165849			
	US26D	489.75	165850			
Withnell Lever	US3	508.80	14035			6
	US4	508.80	14020			
	US10	508.80	14045			
	US10B	508.80	14037			
	US26	508.80	60027			
	US26D	489.75	60017			

Description	Function	Finish	2018 List	Stock No.	Case Qty.
45MD					
Dummy Trim for use with 4501M Mortise Lock Exit Device					
Mortise trim does not match centerline of other 4500 Series trim					
Tactile Warning - add \$42.40 to list price.					
Anti-microbial coating - add \$46.65 to list price.					
Archer Lever	02	US3	508.80	-	6
	Pull when device is dogged down	US4	508.80	-	
		US10	508.80	-	
		US10B	508.80	-	
		US26	508.80	-	
		US26D	489.75	-	
August Lever	US3	508.80	-		6
	US4	508.80	-		
	US10	508.80	-		
	US10B	508.80	-		
	US26	508.80	-		
	US26D	489.75	-		



Description	Function	Finish	2018 List	Stock No.	Case Qty.
William Lever		US3	508.80	-	6
		US4	508.80	-	
		US10	508.80	-	
		US10B	508.80	-	
		US26	508.80	-	
		US26D	489.75	-	
Withnell Lever		US3	508.80	-	6
		US4	508.80	-	
		US10	508.80	-	
		US10B	508.80	163728	
		US26	508.80	-	
		US26D	489.75	163727	



Description	Function	Finish	2018 List	Stock No. LHR	Stock No. RHR	Case Qty.	
45NL							
Night Latch							
Requires a 3901 rim cylinder (with long tailpiece) sold separately.							
Tactile Warning - add \$42.40 to list price.							
Anti-microbial coating - add \$46.65 to list price.							
Maximum door thickness compatibility is 2-1/2" (38 mm)							
Archer Lever	03 Key retracts latchbolt	US3	508.80	14003		6	
		US4	508.80	13984			
		US10	508.80	14015			
		US10B	508.80	14011			
		US26	508.80	60009			
		US26D	489.75	60000			
August Lever		US3	508.80	107844		6	
		US4	508.80	107845			
		US10	508.80	107840			
		US10B	508.80	107841			
		US26	508.80	107842			
		US26D	489.75	107843			
Charles Lever		US3	508.80	-		6	
		US4	508.80	-			
		US10	508.80	-			
		US10B	508.80	178083			
		US26	508.80	-			
		US26D	489.75	178429			
Johnston Lever		US3	508.80	-	508.80	-	6
		US4	508.80	178149	508.80	-	
		US10	508.80	178139	508.80	178145	
		US10B	508.80	177950	508.80	177954	
		US26	508.80	177955	508.80	177956	
		US26D	489.75	177938	489.75	177941	

1. Items with the price in **bold and red** are Quick Ship items and ship in 24 hours.
Please use stock number when ordering. 2. U/M is each unless otherwise noted.



Exit Devices - 4500

Description	Function	Finish	2018 List	Stock No. LHR	Stock No. RHR	Case Qty.	
Joshua Lever		US3	508.80	-		6	
		US4	508.80	-			
		US10	508.80	-			
		US10B	508.80	178092			
		US26	508.80	-			
		US26D	489.75	178091			
Louis Lever	03 Key retracts latchbolt	US3	508.80	177355		6	
		US4	508.80	177359			
		US10	508.80	177294			
		US10B	508.80	177300			
		US26	508.80	177304			
		US26D	489.75	177308			
Warren Lever		US3	508.80	-	508.80	6	
		US4	508.80	-	508.80		
		US10	508.80	-	508.80		
		US10B	508.80	178056	508.80		178060
		US26	508.80	-	508.80		-
		US26D	489.75	178047	489.75		175051
William Lever		US3	508.80	159148		6	
		US4	508.80	159149			
		US10	508.80	159131			
		US10B	508.80	159132			
		US26	508.80	159133			
		US26D	489.75	159112			
Withnell Lever		US3	508.80	13999		6	
		US4	508.80	13980			
		US10	508.80	14012			
		US10B	508.80	14007			
		US26	508.80	60008			
		US26D	489.75	60001			



Description	Function	Finish	2018 List	Stock No.	Case Qty.
45MN					
Night Latch for use with 4501N Mortise Lock Exit Device					
Mortise trim does not match centerline of other 4500 Series trim					
Requires a 3902 mortise cylinder (1-5/8" with standard cam) sold separately.					
Tactile Warning - add \$42.40 to list price.					
Anti-microbial coating - add \$46.65 to list price.					
Maximum door thickness compatibility is 2-1/2" (38 mm)					
Archer Lever	03 Key retracts latchbolt	US3	508.80	-	6
		US4	508.80	-	
		US10	508.80	-	
		US10B	508.80	-	
		US26	508.80	-	
		US26D	489.75	163538	



Description	Function	Finish	2018 List	Stock No.	Case Qty.
August Lever		US3	508.80	-	6
		US4	508.80	-	
		US10	508.80	-	
		US10B	508.80	-	
		US26	508.80	-	
		US26D	489.75	163725	
William Lever		US3	508.80	-	6
		US4	508.80	-	
		US10	508.80	-	
		US10B	508.80	-	
		US26	508.80	-	
		US26D	489.75	169861	
Withnell Lever		US3	508.80	-	6
		US4	508.80	-	
		US10	508.80	-	
		US10B	508.80	-	
		US26	508.80	-	
		US26D	489.75	163726	
45PD Pull Plate - Dummy Trim For use with 4500 RIM, SVR, LBR, ad CLB devices. Not for CVR. Tactile Warning - add \$42.40 to list price. Anti-microbial coating - add \$46.65 to list price.	02	US3	138.35	109038	12
	Pull when device is dogged down	US4	138.35	109039	
		US10	138.35	109040	
		US10B	138.35	109041	
		US26	138.35	109042	
		US26D	138.35	109043	
	US32D	138.35	109044		
45PN Pull Plate - Night Latch For use with 4500 RIM, SVR, LBR, ad CLB devices. Not for CVR. Requires a 3901 rim cylinder (sold separately) Includes retaining cup for 161 door prep. Tactile Warning - add \$42.40 to list price. Anti-microbial coating - add \$46.65 to list price.	03	US3	154.80	109048	12
	Key retracts latchbolt	US4	154.80	109049	
		US10	154.80	109050	
		US10B	154.80	109051	
		US26	154.80	109052	
		US26D	154.80	109053	
	US32D	154.80	109054		
45PT Pull Plate - Thumbpiece For use with 4501 Rim device Requires a 3902 mortise cylinder (sold separately) Tactile Warning - add \$42.40 to list price. Anti-microbial coating - add \$46.65 to list price.	05	US32D	336.05	146142	6



1. Items with the price in **bold and red** are Quick Ship items and ship in 24 hours. Please use stock number when ordering. 2. U/M is each unless otherwise noted.



Exit Devices - 4500



Description	Finish	2018 List	Stock No.	Case Qty.	
313SE (313SF w/Plastisol) Anti-Vandal Pull for 4500 Rim device Material: 11 GA stainless steel Max Projection: 1-7/8" Size: 6-11/32 x 11" Door Thickness: 1-3/4" - 2" Fasteners: 1/4" FPHMS with finish washers Rim cylinder 3901 sold separately Retaining cup 2-649-0137 for 161 prep sold separately	Dummy	US32D	307.35	185346	
	NL cyl. cutout LHR	US32D	307.35	185350	
	NL cyl. cutout RHR	US32D	307.35	185352	
	DUMMY	US32D with Plastisol	348.40	185356	
	NL cyl. cutout LHR	US32D with Plastisol	348.40	185358	
	NL cyl. cutout RHR	US32D with Plastisol	348.40	185361	
	313LE (313LF w/Plastisol) Anti-Vandal Pull w/Latchguard for 4500 Rim Device Material: 11 GA stainless steel Max Projection: 1-7/8" Size: 6-11/32 x 11" Door Thickness: 1-3/4" - 2" Fasteners: 1/4" FPHMS with finish washers Rim cylinder 3901 sold separately Retaining cup 2-649-0137 for 161 prep sold separately	Dummy	US32D	307.35	185355
		NL cyl. cutout LHR	US32D	307.35	185354
NL cyl. cutout RHR		US32D	307.35	185353	
DUMMY		US32D with Plastisol	348.40	185357	
NL cyl. cutout LHR		US32D with Plastisol	348.40	185362	
NL cyl. cutout RHR		US32D with Plastisol	348.40	185363	
4915		US32D	24.95	67426	48
Threshold strike for use with 4500 or 4700 Series. Optional - order separately. Not for fire-rated doors.					
4920	US32D	70.00	16208	24	
Strike for use with 4500 Series or 4600 Series Rim exit device. Included with device. Not for fire-rated doors.					
4920F	US32D	97.00	16207	24	
Fire rated strike for use with 4500 Series or 4600 Series fire rated Rim exit device. Included with fire rated device.					
4921 Double door strike for 4500 Surface Vertical Rod and Rim exit device. Optional - order separately. Not for fire-rated doors.	US3	70.00	102255	24	
	US4	70.00	102256		
	US10	70.00	102257		
	US10B	70.00	102258		
	US26	70.00	102259		
	US32D	70.00	102271		





Description	Finish	2018 List	Stock No.	Case Qty.	
4923 Top strike for use with 4500 Series Surface Vertical Rod device. Included with device.	US32D	44.55	16206	24	
4923F Fire rated top strike for use with 4500 Series Surface Vertical Rod device. Included with fire rated device.	US32D	54.60	16205	24	
4924 Bottom strike for use with 4500 Series Vertical Rod devices. Included with panic rated device.	US32D	54.60	16203	12	
4924F Fire rated bottom strike for use with 4500 Series Vertical Rod device. Included with fire rated device.	US32D	58.30	16201	12	
4926 Cylinder Dogging Conversion Kit for panic rated 4500 device Requires a 3902 mortise cylinder (with standard cam) sold separately.	36"	US3	45.60	157135	48
		US4	45.60	157137	
		US10	45.60	157138	
		US10B	45.60	157139	
		US26	45.60	157140	
		US26D	45.60	157141	
		US32D	45.60	157142	
	48"	US3	48.80	157143	36
		US4	48.80	157144	
		US10	48.80	157145	
		US10B	48.80	157146	
		US26	48.80	157147	
		US26D	48.80	157148	
		US32D	48.80	157149	
4927 Bottom Latch Assembly for use with 4500 Series SVR Devices Includes latch, cover and screws. Included with device.		US3	97.00	2526	24
		US4	97.00	2525	
		US10	97.00	2524	
		US10B	97.00	2522	
		US26	97.00	2520	
		US26D	97.00	2518	
		US32D	97.00	2511	

1. Items with the price in **bold and red** are Quick Ship items and ship in 24 hours. Please use stock number when ordering. 2. U/M is each unless otherwise noted.



Exit Devices - 4500



Description	Function	Finish	2018 List	Stock No.	Case Qty.
4928 Top Latch Assembly for use with 4500 Series SVR and LBR Devices Includes latch, cover and screws. Included with device.		US3	97.00	112972	24
		US4	97.00	112974	
		US10	97.00	112968	
		US10B	97.00	112969	
		US26	97.00	112970	
		US26D	97.00	112971	
		US32D	97.00	112973	
4929 SVR/LBR Rod Replacement Kit (top or bottom) Includes: One (1) each 45-1/4" (1149 mm) rod, rod connector, and appropriate fasteners.		US3	45.60	2634	24
		US4	45.60	2633	
		US10	45.60	2587	
		US10B	45.60	2582	
		US26	45.60	2573	
		US26D	45.60	2571	
4929C CVR/CLB Rod Replacement Kit (top or bottom) Includes: One (1) each 46-5/8" (1184 mm) rod, rod connector, and appropriate fasteners.		US26D	45.60	165570	24
4930R Shim Kit for 4500 Rim Device Packaged 2 ea. 1/8" shims		US3	82.70	1440	24
		US4	82.70	1438	
		US10	82.70	1429	
		US10B	82.70	1428	
		US26	82.70	1426	
		US26D	82.70	1423	
		US32D	97.00	1421	
4930S Shim Kit for 4500 Surface Vertical Rod Device Packaged 2 ea. 1/8" shims		US3	82.70	1412	24
		US4	82.70	1411	
		US10	82.70	1406	
		US10B	82.70	1404	
		US26	82.70	1400	
		US26D	82.70	1391	
		US32D	97.00	1388	
4932C Replacement Head Cover for 4500 CVR Device		US3	82.70	166447	20
		US4	82.70	166449	
		US10	82.70	166443	
		US10B	82.70	166444	
		US26	82.70	166445	
		US26D	82.70	166446	
		US32D	97.00	166448	

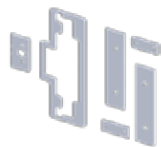
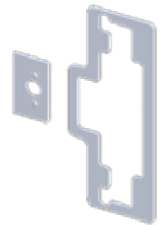



Description	Function	Finish	2018 List	Stock No.	Case Qty.
4932R Replacement Head Cover for 4500 Rim Device		US3	82.70	105036	20
		US4	82.70	105037	
		US10	82.70	105038	
		US10B	82.70	105039	
		US26	82.70	105040	
		US26D	82.70	105041	
		US32D	97.00	105042	
4932S Replacement Head Cover for 4500 SVR Device		US3	82.70	105043	20
		US4	82.70	105044	
		US10	82.70	105045	
		US10B	82.70	105046	
		US26	82.70	105047	
		US26D	82.70	105048	
		US32D	97.00	105049	
4936 24" Extension Rod Kit Includes 24" extension rod, rod connector, rod guide, and wood and machine screws.		US3	29.15	129372	24
		US4	29.15	129373	
		US10	29.15	129374	
		US10B	29.15	129375	
		US26	29.15	129376	
		US26D	29.15	129377	
		US32D	29.15	129378	
4937 36" Extension Rod Kit Includes 36" extension rod, rod connector, rod guide, and wood and machine screws.		US3	32.90	129381	24
		US4	32.90	129382	
		US10	32.90	129383	
		US10B	32.90	129384	
		US26	32.90	129385	
		US26D	32.90	129386	
		US32D	32.90	129387	
4940 Alarm Kit for 4500 Series Latchbolt monitor switch and tamper switch available. See page 29.	36"	US3	389.55	137621	24
		US4	389.55	137622	
		US10	389.55	137623	
		US10B	389.55	137595	
		US26	389.55	137624	
		US26D	389.55	137596	
		US32D	389.55	137597	
	48"	US3	389.55	164020	24
		US4	389.55	164029	
		US10	389.55	164004	
		US10B	389.55	164008	
		US26	389.55	164012	
		US26D	389.55	164016	
		US32D	389.55	164025	

1. Items with the price in **bold and red** are Quick Ship items and ship in 24 hours.
Please use stock number when ordering. 2. U/M is each unless otherwise noted.



Exit Devices - 4500



Description	Function	Finish	2018 List	Stock No.	Case Qty.
4945 Top Strike Standard for 4501 CVR		US32D	45.05	150417	
4945F Fire Rated Top Strike for 4501 CVR		US32D	55.65	150418	
2-649-0031 Rod Guide Replacement Pack		US3	9.05	3478	
2-649-0032 Rod Guide Replacement Pack		US4	9.05	3477	
2-649-0033 Rod Guide Replacement Pack		US10	9.05	3476	
2-649-0034 Rod Guide Replacement Pack		US10B	9.05	3473	
2-649-0035 Rod Guide Replacement Pack		US26	9.05	3467	
2-649-0036 Rod Guide Replacement Pack		US26D	9.05	3466	
2-649-0037 Rod Guide Replacement Pack		US32D	9.05	3464	
2-649-0038 End Cap Replacement		US3	29.15	3462	
2-649-0039 End Cap Replacement		US4	29.15	3454	
2-649-0040 End Cap Replacement		US10	29.15	3452	
2-649-0041 End Cap Replacement		US10B	29.15	3435	
2-649-0042 End Cap Replacement		US26	29.15	3433	
2-649-0043 End Cap Replacement		US26D	29.15	3424	
2-649-0044 End Cap Replacement		US32D	29.15	3414	
2-649-0218 Flush End Cap		US3	33.95	182923	
2-649-0220 Flush End Cap		US4	33.95	182925	
2-649-0214 Flush End Cap		US10	33.95	182919	
2-649-0215 Flush End Cap		US10B	33.95	182920	
2-649-0216 Flush End Cap		US26	33.95	182921	
2-649-0217 Flush End Cap		US26D	33.95	182922	





Description	Function	Finish	2018 List	Stock No.	Case Qty.
2-649-0219 Flush End Cap		US32D	33.95	182924	
Note: All end caps come with bracket and fasteners					
2-649-0049 Spring Cage and Hanging Pin for 4500 Series Escutcheon Trim		-	13.80	3405	
2-649-0060 Top or Bottom Latch Cover Replacement Pack		US3	51.95	3333	
2-649-0061 Top or Bottom Latch Cover Replacement Pack		US4	51.95	3306	
2-649-0062 Top or Bottom Latch Cover Replacement Pack		US10	51.95	3304	
2-649-0063 Top or Bottom Latch Cover Replacement Pack		US10B	51.95	3299	
2-649-0064 Top or Bottom Latch Cover Replacement Pack		US26	51.95	3297	
2-649-0065 Top or Bottom Latch Cover Replacement Pack		US26D	51.95	3296	
2-649-0066 Top or Bottom Latch Cover Replacement Pack		US32D	51.95	3295	
2-649-0074 SVR Screwpack - Latch, rod, rod connector, rod guide		US3	7.95	103548	
2-649-0075 SVR Screwpack - Latch, rod, rod connector, rod guide		US4	7.95	103550	
2-649-0076 SVR Screwpack - Latch, rod, rod connector, rod guide		US10	7.95	103551	
2-649-0077 SVR Screwpack - Latch, rod, rod connector, rod guide		US10B	7.95	103552	
2-649-0078 SVR Screwpack - Latch, rod, rod connector, rod guide		US26	7.95	103553	
2-649-0079 SVR Screwpack - Latch, rod, rod connector, rod guide		US26D	7.95	103554	
2-649-0080 SVR Screwpack - Latch, rod, rod connector, rod guide		US32D	7.95	103555	
2-649-0081 SVR Screwpack - Top and bottom strike		-	4.80	103556	

1. Items with the price in **bold and red** are Quick Ship items and ship in 24 hours.
Please use stock number when ordering. 2. U/M is each unless otherwise noted.



Exit Devices - 4500



Description	Length	Finish	2018 List	Stock No.	Case Qty.
2-649-0082 Screwpack - Chassis, end cap, head cover, rim strike (4500 & 4600 Series)		US3	14.35	103558	
2-649-0083 Screwpack - Chassis, end cap, head cover, rim strike (4500 & 4600 Series)		US4	14.35	103559	
2-649-0084 Screwpack - Chassis, end cap, head cover, rim strike (4500 & 4600 Series)		US10	14.35	103560	
2-649-0085 Screwpack - Chassis, end cap, head cover, rim strike (4500 & 4600 Series)		US10B	14.35	103561	
2-649-0086 Screwpack - Chassis, end cap, head cover, rim strike (4500 & 4600 Series)		US26	14.35	103562	
2-649-0087 Screwpack - Chassis, end cap, head cover, rim strike (4500 & 4600 Series)		US26D	14.35	103563	
2-649-0088 Screwpack - Chassis, end cap, head cover, rim strike (4500 & 4600 Series)		US32D	14.35	103582	
2-649-0166 Firebolt Kit for Fire Rated 4500 Series LBR and CLB devices. Includes fire bolt, plastic plug, head cover plug, screws, and instructions. Must use firebolt with fire rated pairs of less bottom rod vertical rod devices to ensure the device's fire rating.		-	53.55	124539	
2-649-0167 LBR Replacement Head Cover Plug Shipped standard if device ordered as LBR		-	7.95	124540	
2-649-0168 Latchbolt Monitor Switch for 4940 and 4941 Alarm Kits		-	133.60	124228	
2-649-0177 Rod to Rod Connector		US3	7.95	129398	
2-649-0178 Rod to Rod Connector		US4	7.95	129399	
2-649-0179 Rod to Rod Connector		US10	7.95	129400	
2-649-0180 Rod to Rod Connector		US10B	7.95	129401	
2-649-0181 Rod to Rod Connector		US26	7.95	129402	
2-649-0182 Rod to Rod Connector		US26D	7.95	129403	
2-649-0183 Rod to Rod Connector		US32D	7.95	129404	





Description	Finish	2018 List	Stock No.	Case Qty.
2-649-0406 45PN/47PN Cylinder Cup Spacer	-	8.50	182414	
2-649-1074 Hex Key for Dogging 5/32" 10 pack	-	5.85	122690	
2-649-1090 Tamper Switch for 4940 and 4941 alarm kits	-	133.60	137590	
2-649-1108 4501 CVR Top Latch Assembly Replacement Kit	-	80.60	150415	
2-649-1109 4501 CVR Bottom Latch Assembly Replacement Kit	-	80.60	150416	
2-649-0205 4500 Series Mortise Exit Strike	US10B	24.40	174903	
2-649-0204 4500 Series Mortise Exit Strike	US26D	24.40	174902	
2-649-0203 4500 Series Mortise Exit Strike	US32D	24.40	174901	
2-649-0208 4500 Series Fire Rated Mortise Exit Strike	US10B	24.40	174906	
2-649-0207 4500 Series Fire Rated Mortise Exit Strike	US26D	24.40	174905	
2-649-0206 4500 Series Fire Rated Mortise Exit Strike	US32D	24.40	174904	
2-649-0250 4500/4600 Series 36" Photoluminescent Push Bar		250.00	185696	
2-649-0257 4500/4600 Series 48" Photoluminescent Push Bar		300.00	185792	

1. Items with the price in **bold and red** are Quick Ship items and ship in 24 hours.
Please use stock number when ordering. 2. U/M is each unless otherwise noted.



Exit Devices - 4600



Description		Finish	2018 List	Stock No.	List Fire Rated	Stock No.	Case Qty.
4601 RIM	36"	US3	1386.50	158394	1550.25	139568	3
Narrow Stile Rim	Exit Only	US4	1386.50	158396	1550.25	139569	
Grade 1		US10	1386.50	158388	1550.25	139570	
Non-Handed		US10B	1386.50	158343	1550.25	139571	
		US26	1386.50	158390	1550.25	139572	
For cylinder dogging (specify CD), add \$43.10 to the list price. 3902 mortise cylinder with standard cam must be ordered separately.		US26D	1269.90	158324	1422.00	139573	
		US32D	1386.50	158344	1550.25	139574	
	48"	US3	1427.85	158401	1594.80	139592	3
	Exit Only	US4	1427.85	158402	1594.80	139593	
		US10	1427.85	158397	1594.80	139594	
Refer to page 4 for electric modification pricing.		US10B	1427.85	158398	1594.80	139595	
		US26	1427.85	158399	1594.80	139596	
Anti-microbial coating - add \$46.65 to list price.		US26D	1307.00	156239	1466.00	139597	
		US32D	1427.85	156240	1594.80	139599	



46BE							
Blank Escutcheon							
Tactile Warning - add \$42.40 to list price.							
Anti-microbial coating - add \$46.65 to list price.							
Archer Lever	14 Always Operable	US3	508.80	171112			6
		US4	508.80	171116			
		US10	508.80	170816			
		US10B	508.80	171033			
		US26	508.80	171089			
		US26D	489.75	171090			
August Lever		US3	508.80	171114			6
		US4	508.80	171118			
		US10	508.80	170825			
		US10B	508.80	171084			
		US26	508.80	171088			
		US26D	489.75	171096			
William Lever		US3	508.80	171113			6
		US4	508.80	171117			
		US10	508.80	170819			
		US10B	508.80	171083			
		US26	508.80	171087			
		US26D	489.75	171071			
Withnell Lever		US3	508.80	171115			6
		US4	508.80	171119			
		US10	508.80	171032			
		US10B	508.80	171085			
		US26	508.80	171089			
		US26D	489.75	171097			





Description	Finish	2018 List	Stock No.	Case Qty.	
46CE					
Cylinder Escutcheon					
Requires a 3902 mortise cylinder (with 3976 L cam) sold separately.					
Tactile Warning - add \$42.40 to list price.					
Anti-microbial coating - add \$46.65 to list price.					
Archer Lever	08	US3	508.80	171510	6
	Key locks or unlocks lever	US4	508.80	171514	
		US10	508.80	171479	
		US10B	508.80	171483	
		US26	508.80	171504	
		US26D	489.75	171508	
August Lever	US3	508.80	171512	6	
	US4	508.80	171516		
	US10	508.80	171481		
	US10B	508.80	171503		
	US26	508.80	171506		
	US26D	489.75	171212		
William Lever	US3	508.80	171511	6	
	US4	508.80	171515		
	US10	508.80	171480		
	US10B	508.80	171484		
	US26	508.80	171506		
	US26D	489.75	171211		
Withnell Lever	US3	508.80	171513	6	
	US4	508.80	171518		
	US10	508.80	171482		
	US10B	508.80	171129		
	US26	508.80	171507		
	US26D	489.75	171509		



46DT					
Dummy Trim					
Tactile Warning - add \$42.40 to list price.					
Anti-microbial coating - add \$46.65 to list price.					
Archer Lever	02	US3	508.80	171292	6
	Pull when device is dogged down	US4	508.80	171296	
		US10	508.80	171223	
		US10B	508.80	171228	
		US26	508.80	171234	
		US26D	489.75	171283	
August Lever	US3	508.80	171294	6	
	US4	508.80	171298		
	US10	508.80	171226		
	US10B	508.80	171232		
	US26	508.80	171281		
	US26D	489.75	171285		
William Lever	US3	508.80	171293	6	
	US4	508.80	171297		
	US10	508.80	171224		
	US10B	508.80	171375		
	US26	508.80	171280		
	US26D	489.75	171376		

1. Items with the price in **bold and red** are Quick Ship items and ship in 24 hours.
Please use stock number when ordering. 2. U/M is each unless otherwise noted.



Exit Devices - 4600

Description	Finish	2018 List	Stock No.	Case Qty.
Withnell Lever	US3	508.80	171295	6
	US4	508.80	171412	
	US10	508.80	171227	
	US10B	508.80	171233	
	US26	508.80	171282	
	US26D	489.75	171287	

46NK

Night Lever Escutcheon

Requires a 3902 mortise cylinder (with 3976 L cam) sold separately.

Tactile Warning - add \$42.40 to list price.

Anti-microbial coating - add \$46.65 to list price.



Archer Lever	09	US3	508.80	172076	6
	Key releases	US4	508.80	172079	
	lever, lever	US10	508.80	171546	
	locked when	US10B	508.80	171550	
	key removed	US26	508.80	171554	
		US26D	489.75	171558	
August Lever	US3	508.80	172077	6	
	US4	508.80	172080		
	US10	508.80	171548		
	US10B	508.80	171552		
	US26	508.80	171556		
	US26D	489.75	171560		
William Lever	US3	508.80	172083	6	
	US4	508.80	172082		
	US10	508.80	171547		
	US10B	508.80	17551		
	US26	508.80	171555		
	US26D	489.75	171559		
Withnell Lever	US3	508.80	172078	6	
	US4	508.80	172081		
	US10	508.80	171549		
	US10B	508.80	171553		
	US26	508.80	171557		
	US26D	489.75	171561		

46NL

Night Latch

Requires a 3901 rim cylinder (with long tailpiece) sold separately.

Maximum door thickness compatibility is 2-1/2" (38mm).

Tactile Warning - add \$42.40 to list price.

Anti-microbial coating - add \$46.65 to list price.



Archer Lever	03	US3	508.80	171538	6
	Key retracts	US4	508.80	171542	
	latchbolt	US10	508.80	171523	
		US10B	508.80	171527	
		US26	508.80	171531	
		US26D	489.75	171534	



Description	Finish	2018 List	Stock No.	Case Qty.	
August Lever	US3	508.80	171540	6	
	US4	508.80	171544		
	US10	508.80	171525		
	US10B	508.80	171529		
	US26	508.80	171533		
	US26D	489.75	171536		
William Lever	US3	508.80	171539	6	
	US4	508.80	171543		
	US10	508.80	171524		
	US10B	508.80	171528		
	US26	508.80	171532		
	US26D	489.75	171535		
Withnell Lever	US3	508.80	171541	6	
	US4	508.80	171545		
	US10	508.80	171526		
	US10B	508.80	171530		
	US26	508.80	171424		
	US26D	489.75	171537		
4920	US32D	70.00	16208	24	
Strike for use with 4500 or 4600 Series Rim Exit Device. Optional - order separately					
4920F	US32D	97.00	16207	24	
Fire rated strike for use with 4500 or 4600 Series Fire Rated Rim Exit Device. Included standard with fire rated device.					
4925R	36"	US3	42.40	157187	48
		US4	42.40	157191	
		US10	42.40	157192	
		US10B	42.40	157193	
		US26	42.40	157194	
		US26D	42.40	157195	
		US32D	42.40	157196	
48"	US3	44.55	157197	36	
	US4	44.55	157198		
	US10	44.55	157199		
	US10B	44.55	157200		
	US26	44.55	157201		
	US26D	44.55	157202		
	US32D	44.55	157203		



1. Items with the price in **bold and red** are Quick Ship items and ship in 24 hours.
Please use stock number when ordering. 2. U/M is each unless otherwise noted.



Exit Devices - 4600



Description	Finish	2018 List	Stock No.	Case Qty.
4941R Alarm Kit for 4600 Series Rim Device Latchbolt monitor switch and tamper switch available.	36"	US3	354.05	147106
		US4	354.05	147107
		US10	354.05	147108
		US10B	354.05	167348
		US26	354.05	147110
		US26D	354.05	167349
		US32D	354.05	167464
	48"	US3	354.05	147140
		US4	354.05	147146
		US10	354.05	147147
		US10B	354.05	167468
		US26	354.05	147149
	US26D	354.05	147150	
	US32D	354.05	167467	
4950 Blade stop strike for use with 4600 Series Rim Exit Device. Included standard with panic rated device.	US32D	70.00	139746	24
4951 Single rabbet strike for use with 4600 Series Rim Exit Device Optional - order separately	US32D	70.00	139748	24
4952 Semi-flush mount strike for use with 4600 Series Rim Exit Device Optional - order separately	US32D	70.00	139747	24
4960R Shim Kit for 4600 Series Rim Exit Device Packaged 2 each 1/8" shims	US3	75.30	139716	24
	US4	75.30	139717	
	US10	75.30	139718	
	US10B	75.30	139719	
	US26	75.30	139720	
	US26D	75.30	139721	
	US32D	88.55	139722	



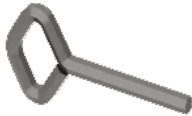

Description	Length	Finish	2018 List	Stock No.	Case Qty.
4965R		US3	75.30	139700	20
		US4	75.30	139707	
		US10	75.30	139708	
		US10B	75.30	139709	
		US26	75.30	139710	
		US26D	75.30	139711	
		US32D	88.55	139712	
2-649-0038 End Cap Replacement Pack		US3	29.15	3462	
2-649-0039 End Cap Replacement Pack		US4	29.15	3454	
2-649-0040 End Cap Replacement Pack		US10	29.15	3452	
2-649-0041 End Cap Replacement Pack		US10B	29.15	3435	
2-649-0042 End Cap Replacement Pack		US26	29.15	3433	
2-649-0043 End Cap Replacement Pack		US26D	29.15	3424	
2-649-0044 End Cap Replacement Pack		US32D	29.15	3414	
2-649-0218 Flush End Cap		US3	33.95	182923	
2-649-0220 Flush End Cap		US4	33.95	182925	
2-649-0214 Flush End Cap		US10	33.95	182919	
2-649-0215 Flush End Cap		US10B	33.95	182920	
2-649-0216 Flush End Cap		US26	33.95	182921	
2-649-0217 Flush End Cap		US26D	33.95	182922	
2-649-0219 Flush End Cap		US32D	33.95	182924	
Note: All end caps come with bracket and fasteners					
2-649-0168 Latchbolt Monitor Switch for 4940 and 4941 Alarm Kits		-	133.60	124228	
2-649-1074 Hex Key for Dogging 5/32" 10 pack		-	5.30	122690	
2-649-1090 Tamper Switch for 4940 and 4941 Alarm Kits		-	133.60	137590	

1. Items with the price in **bold and red** are Quick Ship items and ship in 24 hours.
Please use stock number when ordering. 2. U/M is each unless otherwise noted.



Exit Devices - 4700



Description	Function	Finish	2018 List	Stock No.	List Fire Rated	Stock No.	Case Qty.
4701 RIM Standard Duty Non-Handed	36" Exit Only	ALM	303.20	118164	416.60	115718	3
		DBZ	303.20	118165	416.60	115738	
		US3	510.95	118162	627.55	115737	
		US32D	510.95	118163	627.55	115717	
	48" Exit Only	ALM	341.35	118168	456.35	115720	3
		DBZ	341.35	118169	456.35	115740	
		US3	549.10	118166	664.10	115739	
		US32D	549.10	118167	664.10	115719	
4701 SVR Standard Duty Non-Handed SVR panic devices available on 10' openings. Order extension rod kits separately.	36" x 84" Exit Only	ALM	492.90	118204	681.05	118190	3
		DBZ	492.90	118205	681.05	118191	
		US3	701.75	118170	890.40	118188	
		US32D	701.75	118171	890.40	118189	
	36" x 96" Exit Only	ALM	532.15	118176	720.30	118194	3
		DBZ	532.15	118177	720.30	118195	
		US3	738.30	118174	928.60	118192	
		US32D	738.30	118175	928.60	118193	
	48" x 84" Exit Only	ALM	549.10	118181	738.30	118198	3
		DBZ	549.10	118182	738.30	118199	
		US3	743.10	118178	946.05	118196	
		US32D	743.10	118180	946.05	118197	
	48" x 96" Exit Only	ALM	568.20	118185	757.90	118202	3
		DBZ	568.20	118186	757.90	118203	
		US3	777.55	118183	967.25	118200	
		US32D	777.55	118184	967.25	118201	



Description	Function	Finish	2018 List	Stock No. LHR	Stock No. RHR	Case Qty.	
47BE Blank Escutcheon Must specify handing Steel body, zinc lever (US32D has stainless steel cover). For doors thicker than 1-3/4" or when used with a shim kit, specify total door thickness. Tactile Warning - add \$42.40 to list price of item.							
Archer Lever	14 Always Operable	ALM	241.15	92763	241.15	92825	6
		DBZ	241.15	92760	241.15	92774	
		US3	263.45	92764	263.45	92846	
		US32D	263.45	92772	263.45	92889	
August Lever		ALM	241.15	107647	241.15	107648	6
		DBZ	241.15	107650	241.15	107649	
		US3	263.45	107640	263.45	107643	
		US32D	263.45	107645	263.45	107646	
Withnell Lever		ALM	241.15	92917	241.15	93139	6
		DBZ	241.15	92906	241.15	93083	
		US3	263.45	92918	263.45	93173	
		US32D	263.45	92919	263.45	93199	





Description	Function	Finish	2018 List	Stock No. LHR	Stock No. RHR	Case Qty.	
47CE							
Cylinder Escutcheon							
Must specify handing							
Requires a 3902 mortise cylinder (with standard cam) sold separately.							
Steel body, zinc lever (US32D has stainless steel cover).							
For doors thicker than 1-3/4" or when used with a shim kit, specify total door thickness.							
Tactile Warning - add \$42.40 to list price of item.							
Archer Lever	08	ALM	241.15	93208	241.15	93829	6
	Key locks or unlocks lever	DBZ	241.15	93206	241.15	93819	
		US3	263.45	93219	263.45	93903	
		US32D	263.45	93220	263.45	93913	
August Lever	ALM	241.15	107658	241.15	107659	6	
	DBZ	241.15	107660	241.15	107661		
	US3	263.45	107652	263.45	107654		
	US32D	263.45	107655	263.45	107657		
Withnell Lever	ALM	241.15	93778	241.15	95104	6	
	DBZ	241.15	93765	241.15	95004		
	US3	263.45	93786	263.45	95118		
	US32D	263.45	93801	263.45	95143		



47DT							
Dummy Trim							
Must specify handing							
Steel body, zinc lever (US32D has stainless steel cover).							
For doors thicker than 1-3/4" or when used with a shim kit, specify total door thickness.							
Tactile Warning - add \$42.40 to list price of item.							
Archer Lever	02	ALM	241.15	92290	241.15	92306	6
	Pull when device is dogged down	DBZ	241.15	92257	241.15	92304	
		US3	263.45	92291	263.45	92320	
		US32D	263.45	92293	263.45	92322	
August Lever	ALM	241.15	107675	241.15	107674	6	
	DBZ	241.15	107676	241.15	107677		
	US3	263.45	107669	263.45	107670		
	US32D	263.45	107671	263.45	107673		
Withnell Lever	ALM	241.15	92325	241.15	92391	6	
	DBZ	241.15	92324	241.15	92386		
	US3	263.45	92367	263.45	92392		
	US32D	263.45	92189	263.45	92396		

1. Items with the price in **bold and red** are Quick Ship items and ship in 24 hours. Please use stock number when ordering. 2. U/M is each unless otherwise noted.



Exit Devices - 4700



Description	Function	Finish	2018 List	Stock No. LHR	2018 List	Stock No. RHR	Case Qty.
47NL							
Night Latch							
Must specify handing							
Requires a 3902 mortise cylinder (sold separately) with standard cam.							
Steel body, zinc lever (US32D has stainless steel cover).							
For doors thicker than 1-3/4" or when used with a shim kit, specify total door thickness.							
Tactile Warning - add \$42.40 to list price of item.							
Archer Lever	03	ALM	241.15	92451	241.15	92500	6
	Key retracts latchbolt	DBZ	241.15	92397	241.15	92499	
		US3	263.45	92485	263.45	92531	
		US32D	263.45	92492	263.45	92532	
August Lever	ALM		241.15	107803	241.15	107804	6
	DBZ		241.15	107805	241.15	107806	
	US3		263.45	107799	263.45	107800	
	US32D		263.45	107801	263.45	807802	
Withnell Lever	ALM		241.15	92575	241.15	92711	6
	DBZ		241.15	92566	241.15	92626	
	US3		263.45	92576	263.45	92714	
	US32D		263.45	92593	263.45	92723	



47KD							
Dummy Trim							
Steel body and zinc lever (US32D stainless steel rose).							
Tactile Warning - add \$42.40 to list price of item.							
Archer Lever	02	ALM	218.40	109800	218.40	-	12
	Entrance by trim when device is dogged down	DBZ	218.40	109801	218.40	-	
		US3	241.15	109802	241.15	-	
		US32D	241.15	109803	241.15	-	
August Lever	ALM		218.40	109804	218.40	-	12
	DBZ		218.40	109805	218.40	-	
	US3		241.15	109806	241.15	-	
	US32D		241.15	109807	241.15	-	
Withnell Lever	ALM		218.40	109808	218.40	-	12
	DBZ		218.40	109809	218.40	-	
	US3		241.15	109810	241.15	-	
	US32D		241.15	109811	241.15	-	





Description	Function	Finish	2018 List	Stock No. LHR	Stock No. RHR	Case Qty.	
47KE							
Entrance							
Fixed cylinder standard or SFIC housing option for levers (SFIC cores sold separately, refer to locks section).							
Steel body and zinc lever or knob (US32D stainless steel rose).							
Tactile Warning - add \$42.40 to list price of item.							
Archer Lever	08	ALM	241.15	169423	241.15	169422	12
	Entrance by	DBZ	241.15	169430	241.15	169429	
	trim	US3	263.45	169436	263.45	169435	
	key locks or	US32D	263.45	169442	263.45	169441	
	unlocks trim						
August Lever		ALM	241.15	169426	241.15	169424	12
		DBZ	241.15	169432	241.15	169431	
		US3	263.45	169438	263.45	169437	
		US32D	263.45	169444	263.45	169443	
Withnell Lever		ALM	241.15	169428	241.15	169427	12
		DBZ	241.15	169434	241.15	169433	
		US3	263.45	169440	263.45	169439	
		US32D	263.45	169446	263.45	169445	
Apollo Knob		US32D	263.45	149372	263.45	169447	12
(not ADA compliant)							



47KN							
Night Latch							
Fixed cylinder standard or SFIC housing option for levers (SFIC cores sold separately, refer to locks section).							
Steel body, zinc lever or knob (US32D stainless steel rose).							
Tactile Warning - add \$42.40 to list price of item.							
Archer Lever	03	ALM	241.15	127486	241.15	109767	12
	Key retracts	DBZ	241.15	127489	241.15	109768	
	latchbolt	US3	263.45	127480	263.45	109769	
		US32D	263.45	127483	263.45	109770	
August Lever		ALM	241.15	127487	241.15	109775	12
		DBZ	241.15	127490	241.15	109776	
		US3	263.45	127481	263.45	109777	
		US32D	263.45	127484	263.45	109778	
Withnell Lever		ALM	241.15	127488	241.15	109783	12
		DBZ	241.15	127491	241.15	109784	
		US3	263.45	127482	263.45	109785	
		US32D	263.45	127485	263.45	109786	
Apollo Knob		US32D	263.45	149373	263.45	-	12
(not ADA compliant)							

1. Items with the price in **bold and red** are Quick Ship items and ship in 24 hours.
Please use stock number when ordering. 2. U/M is each unless otherwise noted.



Exit Devices - 4700



Description	Function	Finish	2018 List	Stock No. LHR	Stock No. RHR	Case Qty.
47KP						
Passage						
Steel body, zinc lever (US32D stainless steel rose).						
Tactile Warning - add \$42.40 to list price of item.						
Archer Lever	14	ALM	218.40	109788	218.40	12
	Always operable	DBZ	218.40	109789	218.40	-
		US3	241.15	109790	241.15	-
		US32D	241.15	109791	241.15	-
August Lever	14	ALM	218.40	109792	218.40	12
	Always operable	DBZ	218.40	109793	218.40	-
		US3	241.15	109794	241.15	-
		US32D	241.15	109795	241.15	-
Withnell Lever	14	ALM	218.40	109796	218.40	12
	Always operable	DBZ	218.40	109797	218.40	-
		US3	241.15	109798	241.15	-
		US32D	241.15	109799	241.15	-



Description	Function	Finish	2018 List	Stock No.	Stock No.	Case Qty.
47BT						
Pull Plate						
Thumb Piece Passage						
Must specify handing						
Tactile Warning - add \$42.40 to list price of item.						
47PT	05	US32D	266.10	159296	159297	6
	Key locks or unlocks thumb piece	US32D	266.10	159296	159297	6
		US32D	266.10	159296	159297	6
		US32D	266.10	159296	159297	6
47PD						
Pull Plate - Dummy Trim						
Plated steel for ALM, DBZ, and US3.						
Stainless steel for US32D.						
Tactile Warning - add \$42.40 to list price of item.						
47PN	03	ALM	125.10	109023		12
	Key retracts latchbolt	DBZ	125.10	109026		
		US3	125.10	109027		
		US32D	125.10	109028		





Description		Finish	2018 List	Stock No.	Case Qty.
47RD Raised Lip Pull - Dummy Trim Plated steel for ALM, DBZ, and US3. Stainless steel for US32D. Tactile Warning - add \$42.40 to list price of item.	02	ALM	60.45	18956	12
	Pull when	DBZ	60.45	18949	
	device is	US3	60.45	18934	
	dogged	US32D	60.45	18933	
	down				
47RN Raised Lip Pull - Night Latch Requires a 3901 rim cylinder (sold separately). Tactile Warning - add \$42.40 to list price of item.	03	ALM	67.35	18914	12
	Key	DBZ	67.35	18902	
	retracts	US3	67.35	18885	
	latchbolt	US32D	67.35	18884	
4910 Strike for use with 4700 Rim Exit Device Included standard with device.		US32D	67.35	20040	24
4911 Double door strike for 4700 Surface Vertical Rod and Rim Exit Device. Not for fire-rated door. Optional - order separately.		DBZ	60.45	19301	24
		US3	60.45	19323	
		US32D	60.45	19322	
4913 Top strike for 4700 Surface Vertical Rod Exit Device Included standard with device.		US32D	42.95	16231	24
4914 Bottom strike for 4700 Surface Vertical Rod Exit Device Included standard with device.		US32D	42.95	16213	24
4915 Threshold strike for use with 4500 Series or 4700 Series. Not for fire-rated doors. Optional order separately.		US32D	24.95	67426	48
4917 Bottom Latch Assembly Includes latch, cover and screws. Included standard with device.		ALM	63.10	56412	50
		DBZ	63.10	56401	
		US3	63.10	56400	
		US32D	63.10	56398	
4918 Top Latch Assembly Includes latch, cover and screws. Included standard with device.		ALM	63.10	56418	50
		DBZ	63.10	56410	
		US3	63.10	56409	
		US32D	63.10	56407	
4919 Rod Replacement Kit (top or bottom) Includes rod (47-1/4"), rod guide, rod connector assembly and all appropriate screws.		ALM	31.80	73587	24
		DBZ	31.80	73574	
		US3	31.80	73568	
		US32D	31.80	73530	

1. Items with the price in **bold and red** are Quick Ship items and ship in 24 hours.
Please use stock number when ordering. 2. U/M is each unless otherwise noted.



Exit Devices - 4700



Description	Length	Finish	2018 List	Stock No.	Case Qty.
4931R Shim Kit for 4700 Series Rim Device Packaged 2 ea. 1/8" shims. If using with 47BE, 47CE, 47NL trim, please specify thickness (door plus shim).		ALM	55.15	101773	24
		DBZ	55.15	101774	
		US3	63.10	101775	
		US32D	63.10	101776	
4931S Shim Kit for 4700 Series Surface Vertical Rod Device Packaged 2 ea. 1/8" shims. If using with 47BE, 47CE, 47NL trim, please specify thickness (door plus shim).		ALM	55.15	101783	24
		DBZ	55.15	101784	
		US3	63.10	101786	
		US32D	63.10	101787	
4933R Replacement Head Cover for 4700 Series Rim Device		ALM	39.75	105050	20
		DBZ	39.75	105051	
		US3	46.15	105052	
		US32D	46.15	105053	
4933S Replacement Head Cover for 4700 Series SVR Device		ALM	39.75	105054	20
		DBZ	39.75	105055	
		US3	46.15	105056	
		US32D	46.15	105057	
4934 Replacement Dogging Plate for 4700 Series Panic Rated Device	36"	ALM	31.80	105058	20
		DBZ	31.80	105059	
		US3	31.80	105060	
		US32D	31.80	105061	
	48"	ALM	36.05	105062	20
		DBZ	36.05	105063	
		US3	36.05	105064	
		US32D	36.05	105065	
4934F Replacement Dogging Plate for 4700 Series Fire Rated Device	36"	ALM	31.80	105066	20
		DBZ	31.80	105076	
		US3	31.80	105068	
		US32D	31.80	105069	
	48"	ALM	36.05	105070	20
		DBZ	36.05	105071	
		US3	36.05	105072	
		US32D	36.05	105073	
4936 24" Extension Rod Kit Includes 24" extension rod, rod connector, rod guide, and wood and machine screws. Fire rated up to 8' on Surface Vertical Rod device.		ALM	28.10	129379	24
		DBZ	28.10	129380	
		US3	29.15	129372	
		US32D	29.15	129378	
4937 36" Extension Rod Kit Includes 36" extension rod, rod connector, rod guide, and wood and machine screws. Fire rated up to 8' on Surface Vertical Rod device.		ALM	31.80	129388	24
		DBZ	31.80	129389	
		US3	32.90	129381	
		US32D	32.90	129387	
2-649-0010 Rod Guide Replacement		US3	7.95	56131	



Description	Function	Finish	2018 List	Stock No.	Case Qty.
2-649-0011 Rod Guide Replacement		US32D	7.95	56026	
2-649-0012 Rod Guide Replacement		DBZ	7.95	56025	
2-649-0013 Rod Guide Replacement		ALM	7.95	56027	
2-649-0014 Trim Handing Pin - 5 pack		-	7.95	52275	
2-649-0021 Top Latch Cover		ALM	34.45	56389	
2-649-0022 Top Latch Cover		DBZ	34.45	56388	
2-649-0023 Top Latch Cover		US3	34.45	56376	
2-649-0024 Top Latch Cover		US32D	34.45	56375	
2-649-0025 Bottom Latch Cover		ALM	34.45	56331	
2-649-0026 Bottom Latch Cover		DBZ	34.45	56328	
2-649-0027 Bottom Latch Cover		US3	34.45	56319	
2-649-0028 Bottom Latch Cover		US32D	34.45	56296	
2-649-0095 SVR Screwpack - Latch, rod, rod connector, rod guide		ALM	7.95	103572	
2-649-0096 SVR Screwpack - Latch, rod, rod connector, rod guide		DBZ	7.95	103573	
2-649-0097 SVR Screwpack - Latch, rod, rod connector, rod guide		US3	7.95	103574	
2-649-0098 SVR Screwpack - Latch, rod, rod connector, rod guide		US32D	7.95	103575	
2-649-0099 SVR Screwpack - Top and bottom strike		-	4.80	103576	
2-649-0100 Screwpack - Chassis, end cap, head cover, rim strike		ALM	13.80	103577	
2-649-0101 Screwpack - Chassis, end cap, head cover, rim strike		DBZ	13.80	103578	
2-649-0102 Screwpack - Chassis, end cap, head cover, rim strike		US3	13.80	103579	



1. Items with the price in **bold and red** are Quick Ship items and ship in 24 hours.
Please use stock number when ordering. 2. U/M is each unless otherwise noted.



Exit Devices - 4700

Description	Function	Finish	2018 List	Stock No.	Case Qty.
2-649-0103 Screwpack - Chassis, end cap, head cover, rim strike		US32D	13.80	103580	
2-649-0141 Screwpack - 2" thick door, trim		-	2.65	103606	
2-649-0142 Screwpack - 2-1/4" thick door, trim		-	2.65	103607	
2-649-0144 End Cap Replacement Pack		ALM	17.00	104043	
2-649-0145 End Cap Replacement Pack		DBZ	17.00	104044	
2-649-0146 End Cap Replacement Pack		US3	17.00	104045	
2-649-0147 End Cap Replacement Pack		US32D	17.00	104046	
Note: All end caps come with bracket and fasteners					
2-649-0164 Pack of 8 Screws, trim (4700), 1/4 - 20 x 3/4" PHMS		-	7.95	112534	
2-649-0177 Rod to Rod Connector		US3	7.95	129398	
2-649-0183 Rod to Rod Connector		US32D	7.95	129404	
2-649-0184 Rod to Rod Connector		ALM	7.95	129405	
2-649-0185 Rod to Rod Connector		DBZ	7.95	129406	
2-649-0406 45PN/47PN Cylinder Cup Spacer		-	8.50	182414	
2-649-4703 Hex Key for Dogging 3/16" 10 pack		-	5.85	315	





Description	Function	Finish	2018 List	Stock No.	List Fire Rated	Stock No.	Case Qty.
4900U Non-Keyed Removable Mullion Set 11 Gauge Steel Tube, top bracket/ bottom bracket set Fire rated mullion requires a fire rated strike (sold separately).	7'	USP	501.40	133007	749.95	133010	1
	8'	USP	501.40	133008	749.95	133011	1
	10'	USP	625.40	133009		-	1
<hr/>							
4904 Top/Bottom Bracket Set Removable (Non-Keyed)		-	219.95	133029	270.30	133031	5
<hr/>							
4905 Mullion Tube (Non-Keyed) 11 Gauge Steel	7'	USP	321.75	133032		-	1
	8'	USP	321.75	133033		-	1
	10'	USP	398.60	133034		-	1
<hr/>							
4912 Fire rated strike for use with 4500 Series and 4600 Series Fire Rated Exit Device and Mullion		US32D		-	137.80	16232	24
<hr/>							
4916 Fire rated strike for use with 4700 Series Fire Rated Exit Device and Mullion		US32D		-	137.80	115780	24
<hr/>							
4953 Mullion Stabilizer for use with 4900 Series Non-Keyed and Keyed Removable Mullion		US32D		-	54.10	139749	12
<hr/>							
4900T Keyed Removable Mullion Set 11 gauge steel tube, top bracket/ bottom bracket set. Requires a 3901 rim cylinder (sold separately). Fire rated mullion requires a fire rated strike (sold separately).	7'	USP	1034.05	132391	1,223.80	132393	1
	8'	USP	1034.05	132392	1,223.80	132394	1
	10'	USP	1192.00	132390		-	1

1. Items with the price in **bold and red** are Quick Ship items and ship in 24 hours.
Please use stock number when ordering. 2. U/M is each unless otherwise noted.



Exit Devices - 4700



Description	Function	Finish	2018 List	Stock No.	List Fire Rated	Stock No.	Case Qty.
4902 Top/Bottom Bracket Set Key Removable		-	635.50	45351	787.05	31750	5
Requires a 3901 rim cylinder (sold separately).							
4907 Mullion Tube (Key Removable) 11 Gauge Steel	7'	USP	428.80	45349		-	1
	8'	USP	428.80	45334		-	1
	10'	USP	557.60	45323		-	1
4912 Fire rated strike for use with 4500 Series and 4600 Series Fire Rated Device and Mullion		US32D		-	137.80	16232	24
4916 Fire rated strike for use with 4700 Series Fire Rated Exit Device and Mullion		US32D		-	137.80	115780	24
4953 Mullion Stabilizer for use with 4900 Series Non-Keyed and Keyed Removable Mullion		US32D		-	54.10	139749	12
3901 Rim Cylinder Fixed cylinder and Small Format Interchangeable Core housing available (SFIC cores sold separately). Dummy rim cylinders also available.		US3	48.50				1
		US4	51.55				
		US10	51.55				
		US10B	48.50				
		US26	48.50				
		US26D	48.50				
Shipped standard with long break-off tailpiece.							
Specify 6-pin or 7-pin for SFIC housing.							
For additional cylinder information, please refer to the Locks section.							





Description	Function	Finish	2018 List	Stock No.	Case Qty.
3902 Mortise Cylinder Fixed cylinder and Small Format Interchangeable Core housing available (SFIC cores sold separately). Dummy mortise cylinders also available.		US3	48.50		1
		US4	51.55		
		US10	51.55		
		US10B	48.50		
		US26	48.50		
		US26D	48.50		
Shipped with Schlage C keyway, standard cam attached, and Adams Rite cam loose in box.					
Specify length 1-1/8" or 1-1/4" for fixed cylinder or 1-1/4" (6-pin) or 1-3/8" (7-pin) for SFIC housing and cam required.					
For mortise exit device trim specify 1-5/8" with standard cam for fixed cylinder (Schlage C Keyway) or SFIC housing.					
For mortise exit device x cylinder/optional pull, use 1-3/8" cylinder with 11/16" cylindrical collar.					
For additional cylinder information, please refer to the Locks section.					
2-649-0137 Retaining Cup For use with Rim cylinder and 161 prep		NF	9.55	103365	
2-649-0045 7/16" Cylinder Collar (4500 Pull Plate Trim)		US3	19.10	3404	
2-649-0046 7/16" Cylinder Collar (4500 Pull Plate Trim)		US4	19.10	3395	
2-649-0047 7/16" Cylinder Collar (4500 Pull Plate Trim)		US10	19.10	3394	
2-649-0048 7/16" Cylinder Collar (4500 Pull Plate Trim)		US10B	19.10	3393	
2-649-0050 7/16" Cylinder Collar (4500 Pull Plate Trim)		US26	19.10	3386	
2-649-0051 7/16" Cylinder Collar (4500 Pull Plate Trim)		US26D	19.10	3384	
2-649-0052 7/16" Cylinder Collar (4500 Pull Plate Trim)		US32D	19.10	3381	
Note: For use with 1-1/8" mortise cylinders Note: All cylinder collars come with wave washer and spacer					
2-649-0053 11/16" Cylinder Collar (4500 Escutcheon Trim)		US3	19.10	3380	
2-649-0054 11/16" Cylinder Collar (4500 Escutcheon Trim)		US4	19.10	3357	
2-649-0055 11/16" Cylinder Collar (4500 Escutcheon Trim)		US10	19.10	3346	
2-649-0056 11/16" Cylinder Collar (4500 Escutcheon Trim)		US10B	19.10	3340	
2-649-0057 11/16" Cylinder Collar (4500 Escutcheon Trim)		US26	19.10	3339	



1. Items with the price in **bold and red** are Quick Ship items and ship in 24 hours.
Please use stock number when ordering. 2. U/M is each unless otherwise noted.



Exit Devices - 4700



Description	Finish	2018 List	Stock No.	Case Qty.
2-649-0058 1 1/16" Cylinder Collar (4500 Escutcheon Trim)	US26D	19.10	3335	
2-649-0059 1 1/16" Cylinder Collar (4500 Escutcheon Trim)	US32D	19.10	3334	
Note: For use with 1-1/4" or 1-3/8" mortise cylinders Note: All cylinder collars come with wave washer and spacer				
2-647-0012 7/8" Cylinder Collar - 5, 6, 7 pin (4700 Escutcheon Trim)	US3	19.10	31809	
2-647-0013 7/8" Cylinder Collar - 5, 6, 7 pin (4700 Escutcheon Trim)	ALM	19.10	31804	
2-647-0014 7/8" Cylinder Collar - 5, 6, 7 pin (4700 Escutcheon Trim)	DBZ	19.10	31793	
2-647-0015 7/8" Cylinder Collar - 5, 6, 7 pin (4700 Escutcheon Trim)	US32D	19.10	31789	
Note: For use with 1-1/8" mortise cylinders Note: All cylinder collars come with wave washer and spacer				





One Family. One Brand. One Vision.™

www.hagerco.com

TABLE OF CONTENTS

A		P	
Adjustable Angle Bracket (2941/2942)	6	Power Supply.....	3-4
Angle Brackets (2950 Series)	9	Power Transfers	11
Armature Mounting Plates (2950 Series).....	7-8	Pressure Sense Bars.....	10
C		Proximity Cards & Keys... ..	4
Coordinator Mounting Bracket (2950 Series)	8	S	
Concealed Magnetic Contact	11	Spacer Brackets (2950 Series).....	7
D		T	
Delayed Egress Magnetic Lock.....	9-10	Top Jamb Kits (2941/2942)	6
Door Prop Alarms.....	3	Top Jamb Kits (2950 Series)	7
E		U	
Egress Sensors.....	11	Universal Brackets (2950 Series)	7
Electric Strikes	5-6	Underdesk Switch.....	11
Exit Switches	10		
Emergency Door Release.....	11		
F			
Filler Bars (2941/2942 Series)	6		
Filler Bars (2950 Series)	8		
G			
Gang Boxes	11		
Glass Door Kits (2941/2942)	6		
Glass Door Kits (2950 Series)	7		
K			
Key Switch.....	3		
Keypads.....	4		
L			
Low Energy Power Operator	12-20		
M			
Magnetic Locks (2941/2942 Series).....	6		
Magnetic Locks (2950 Series).....	6-7		
Magnetic Shear Locks (2961/2965)	9		
Magnetic Switches	11		
O			
Outdoor Shrouds	4,11		



Electrified Products

Low Energy Power Operators

8200 Series Low Energy Power Operators 15-16

8400 Series Low Energy Power Operators 12-14

A

Actuators 17-19

Arm Assemblies (8200 Series) 16

Arm Assemblies (8400 Series) 13

B

Battery Backup (8200 Series) 15

Bollard Posts 19

C

Covers (8400 Series) 13-14

D

Drop Plates (8400 Series) 13

H

Handheld Programmer (8200 Series) 15

M

Modules (8200 Series) 15

O

On-Board Power Supply (8400 Series) 14

S

Spindles (8400 Series) 13

R

Relay & Door Sequencer 20

Relay Board (8400 Series) 14

W

Wireless Receiver 19

Wireless Transmitters 20

LEAD TIMES

Stock items will typically ship in five working days or less from the order entry date. Made-to-order items will typically ship in 15 working days depending on seasonal volume and order complexity. Special orders including industrials, special machining, and large quantities may need to be scheduled. The anticipated ship date will be included with each order acknowledgement. Please contact Customer Service if product availability is in question.

QUICK SHIP

Products denoted with **red and bold** pricing are available to order through the Quick Ship program and ship within 24 hours. When ordering these products please visit www.hagerco.com and log in to MyHager to access the 'Quick Ship' portal. Due to the promptness of the fulfillment process, Quick Ship orders are non-cancellable.

CANCELLATION NOTIFICATION

Cancellation for made-to-order items must be communicated within 48 hours of order placement.



Description	Finish	2018 List	Stock No.	Case Qty.
29KS ASD Key switch - Alternate, SPDT	US32D	102.75	156361	12
29KS MSD Key switch - Momentary, SPDT	US32D	102.75	156367	12
29KS ADD Key switch - Alternate, DPDT	US32D	119.00	156366	12
29KS MDD Key switch - Momentary, DPDT	US32D	113.60	156367	12
Options: Red LED \$21.65 list price adder Green LED \$21.65 list price adder 2 LED's \$27.05 list price adder				
29EA NS Door Prop Alarm, Single Gang Mount, No Key Switch		294.65	199478	
29EA KS Door Prop Alarm, Double Gang Mount, Key Switch		415.20	199474	
29EA MKNC Door Prop Alarm, Double Gang Mount, Mortise Cylinder Switch		375.00	199473	
2901 For use with 4500 Series electric latch retraction battery back up option available		596.40	114909	
2902 For use with 4500 Series electric latch retraction in a day/night mode of operation, battery backup option available		658.20	114990	
2903 Provides 24 volt DC power for Fail Safe or Fail Secure locking devices and interface with building alarm controls, card readers, keypads, and other door controls.		514.00	114455	
2904 Provides 24 volt DC power and control for opening with an electrified locking device and automatic door operator		544.90	136899	
2908 Provides up to 1 amp of 12 or 24 volt DC power for all Hager Electrified Products except (ELR)		355.35	149931	1
2909 Provides up to 2 amps of 12 or 24 volt DC power for all Hager Electrified Products		541.80	177262	



Electrified Products



Description	Finish	2018 List	Stock No.	Case Qty.
2910 Provides up to 4 amps of 12 or 24 volt DC power for all Hager Electrified Products		831.70	198523	
2911 Provides up to 6 amps of 12 or 24 volt DC power for all Hager Electrified Products		971.00	198524	
2-679-0661 5 Amp hour battery backup for use with 2908 & 2909		47.60	153208	
2-679-0662 12 VDC output regulator module for use with 2908 & 2909		61.05	159033	
2-679-0664 Universal Relay Module for use with 2908 & 2909		117.25	156812	
2-679-0703 Electric Retraction Sequencer for use with 2908 & 2909		177.20	177267	
2-679-0704 Access Control Module for use with 2908 & 2909		193.65	177263	
2-679-0705 16 AMP Power Booster for use with 2909 only		177.25	177264	
2-679-0706 Power Supply Remote Monitoring Module for use with 2908 & 2909		257.50	177266	
2-679-0708 Underdesk Push Switch		111.65	176289	
2915 Heavy Duty Keypad - Indoor 500 users, 4-6 digit PIN codes 12/24V AC/DC	US3	232.55	150749	12
	US4	232.55	150750	
	US10B	232.55	150751	
	US26	232.55	150752	
	US32D	189.30	149619	
2916 Heavy Duty Keypad - Outdoor 500 users, 4-6 digit PIN Codes 12/24V AC/DC	32D	247.20	173204	8
2916P Heavy Duty Keypad / Prox-Outdoor 500 users, 4-6 digit PIN codes 12/24V AC/DC	32D	679.75	189700	8
2-679-0669 Shroud Cover	-	158.95	176541	
2-679-0700 Surface Mount Box	-	31.95	172698	
2-679-0021 HID ProxCard II, 25 Cards	-	189.30	149627	
2-679-0022 HID ProxCard II, 100 Cards	-	757.05	153893	





Description	Finish	2018 List	Stock No.	Case Qty.
2-679-0023 HID ProxKey, 10 Key fobs	-	151.45	150753	
2-679-0024 HID ProxKey, 100 Key fobs	-	1,514.10	153894	
2925 Electric Strike - 5/8" Latch Field Reversible Failsafe/Failsecure 12/24VDC 4-7/8" Sq Corner Stainless Steel Faceplate	US32D	129.80	149637	8
2928 SC Electric Strike - 1/2" to 3/4" latch Failsafe/Failsecure 12/24V AC/DC 4-7/8" Sq Corner Stainless Steel Faceplate	US32D	210.90	149638	8
2928 RC Electric Strike - 1/2" to 3/4" latch Failsafe/Failsecure 12/24V AC/DC 4-7/8" Radius Corner Faceplate	ALM	183.90	150333	8
2928 6R Electric Strike - 1/2" to 3/4" latch Failsafe/Failsecure 12/24V AC/DC 6-7/8" Radius Corner Faceplate	ALM	189.30	154920	8
2928 7R Electric Strike - 1/2" to 3/4" latch Failsafe/Failsecure 12/24V AC/DC 7-15/16" Radius Corner Faceplate	ALM	194.70	173212	8
Options: Keeper open/closed status \$48.70 list price adder Note: Additional finishes available for 2928. Inquire with Hager Customer Service for pricing.				
2930 CYL Electric Strike - Cylindrical lock Dual Voltage 12/24VDC ANSI/BHMA A156.31 Grade 1 UL Listed 3-hour fire rated Non-handed	US4 US10 US10B US26 US26D US32D	546.20 546.20 546.20 546.20 546.20 497.50	175715 156216 160255 175075 149642 149641	12
2930 MOR Electric Strike - Mortise lock Dual Voltage 12/24VDC ANSI/BHMA A156.31 Grade 1 UL Listed 3-hour fire rated Non-handed	US4 US10 US10B US26 US26D US32D	567.80 567.80 567.80 567.80 567.80 524.55	167282 160328 163253 149646 149645	12



Electrified Products

Description	Finish	2018 List	Stock No.	Case Qty.
2930 MDB	US4	594.85		12
Electric Strike - Mortise lock w/ Deadbolt	US10	594.85	175970	
Dual Voltage 12/24VDC	US10B	594.85	176007	
ANSI/BHMA A156.31 Grade 1	US26	594.85		
UL Listed 3-hour fire rated	US26D	594.85	149649	
Non-handed	US32D	540.75	149648	
Options:				
Latchbolt Monitor (LBM)		\$70.85 list price adder		
Door secure monitor (DSM)		\$146.05 list price adder		
Deadbolt monitor - (DBM) LH		\$75.75 list price adder		
Deadbolt monitor - (DBM) RH		\$75.75 list price adder		
2-679-0028	-	42.85	153474	12
Buzzer 12/24V AC/DC operation for 2925/2928/2930				
2-679-0029	-	23.80	155676	12
Rectifier for AC operation for 2925/2928/2930				
2941 Magnetic Lock	ALM	243.35	149650	4
600 lb. holding force				
12/24VDC, field selectable				
2942 Magnetic Lock	ALM	292.05	149652	4
1200 lb. holding force				
12/24VDC, field selectable				
2-679-0100	ALM	95.20	149653	8
Top Jamb Kit for 2942				
2-679-0101	ALM	95.20	149654	8
Top Jamb Kit for 2941				
2-679-0102	ALM	47.60	149655	8
Glass Door Kit for 2942				
2-679-0103	ALM	47.60	149656	8
Glass Door Kit for 2941				
2-679-0104	ALM	35.70	149657	8
Adjustable Angle Bracket for 2942				
10-1/2" x 1-3/4" x 3-1/8"				
2-679-0105	ALM	23.80	149658	8
Adjustable Angle Bracket for 2941				
9-7/8" x 1-1/4" x 2-1/4"				
2-679-0106	ALM	23.80	149659	8
Angle bracket for 2942 (Cut for use with 2941)				
10-1/2" x 1-1/2" x 3/4"				
2-679-0107	ALM	17.90	149660	6
Filler bar for 2942 (Cut for use with 2941)				
5/8" x 3/4" x 10-1/2"				



Description	Finish	2018 List	Stock No.	Case Qty.
2-679-0108 Filler bar for 2942 (Cut for use with 2941) 3/4" x 3/4" x 10-1/2"	ALM	17.90	149661	6
2951 Magnetic Lock 1,650 lb. holding force Surface mount - single 12/24VDC	ALM	497.50	149701	2
	DBZ	567.80	153513	2
2952 Magnetic Lock 1,650 lb. holding force Surface mount - double 12/24VDC	ALM	1,011.25	152042	2
	DBZ	1,146.40	153528	2
2953 Magnetic Lock 1,200 lb. holding force Surface mount - single 12/24VDC	ALM	470.50	149707	2
	DBZ	535.35	153533	2
2954 Magnetic Lock 1,200 lb. holding force Surface mount - double 12/24VDC	ALM	951.75	152043	2
	DBZ	1,092.35	153538	2
Options: Adjustable timer input (TIME) \$75.75 (2-679-0109) Door Position Sensor (DPS) \$47.60 (2-679-0110)* Magnetic Bond Sensor (MBS) \$71.40 (2-679-0111)*				
Note: Additional finishes available for 2951, 2952, 2953, 2954. Inquire with Hager Customer Service for pricing. * Must order two for use with the 2952 or 2954				
2-679-0120 Top jamb kit 2951/2953	ALM	115.75	149709	4
2-679-0130 Top jamb kit 2952/2954	ALM	232.55	153861	4
2-679-0160 Glass door kit 2951/2953 * Order 2 ea. for double door	ALM	214.15	168468	8
2-679-0180 Universal Bracket for 2951/2953	ALM	75.75	149710	12
2-679-0190 Universal Bracket for 2952/2954	ALM	151.45	161684	9
2-679-0191 Universal Bracket for 2952/2954	DBZ	222.80	167699	9



Electrified Products



Description	Finish	2018 List	Stock No.	Case Qty.
2-679-0200 Spacer Bracket for 2951/2953	ALM	107.10	153684	12

2-679-0201 Spacer Bracket for 2952/2954	ALM	133.05	161686	9
---	-----	--------	--------	---



2-679-0204 Armature mounting plate	-	71.40	167666	3
--	---	-------	--------	---

Note: Additional finishes available on many of the 2950 magnetic lock series accessories. Inquire with Hager Customer Service for pricing.



2-679-0210 Coordinator mounting bracket for 2951/2953	ALM	142.80	160581	12
---	-----	--------	--------	----

2-679-0220 Coordinator mounting bracket for 2952/2954	ALM	261.75	166426	6
---	-----	--------	--------	---



2-679-0281 Filler bar - 1/8" x 1-1/4" for 2951/2953	ALM	38.95	149711	12
---	-----	-------	--------	----

2-679-0283 Filler bar - 1/8" x 1-1/4" for 2951/2953	DBZ	74.65	149712	12
---	-----	-------	--------	----

2-679-0291 Filler bar - 1/4" x 1-1/4" for 2951/2953	ALM	40.05	149713	12
---	-----	-------	--------	----

2-679-0293 Filler bar - 1/4" x 1-1/4" for 2951/2953	DBZ	75.75	149715	12
---	-----	-------	--------	----

2-679-0311 Filler bar - 1/2" x 1-1/4" for 2951/2953	ALM	44.35	149716	12
---	-----	-------	--------	----

2-679-0313 Filler bar - 1/2" x 1-1/4" for 2951/2953	DBZ	80.05	149738	12
---	-----	-------	--------	----

2-679-0321 Filler bar - 5/8" x 1-1/4" for 2951/2953	ALM	47.60	149717	12
---	-----	-------	--------	----

2-679-0323 Filler bar - 5/8" x 1-1/4" for 2951/2953	DBZ	83.30	149739	12
---	-----	-------	--------	----

2-679-0381 Filler bar - 1/8" x 1-1/4" for 2952/2954	ALM	44.35	149718	12
---	-----	-------	--------	----

2-679-0383 Filler bar - 1/8" x 1-1/4" for 2952/2954	DBZ	80.05	149740	12
---	-----	-------	--------	----

2-679-0391 Filler bar - 1/4" x 1-1/4" for 2952/2954	ALM	47.60	149719	12
---	-----	-------	--------	----

2-679-0393 Filler bar - 1/4" x 1-1/4" for 2952/2954	DBZ	83.30	149741	12
---	-----	-------	--------	----

2-679-0411 Filler bar - 1/2" x 1-1/4" for 2952/2954	ALM	51.95	149720	12
---	-----	-------	--------	----







2-679-0413 Filler bar - 1/2" x 1-1/4" for 2952/2954	DBZ	87.65	149742	12
---	-----	-------	--------	----



Description	Finish	2018 List	Stock No.	Case Qty.
2-679-0421 Filler bar - 5/8" x 1-1/4" for 2952/2954	ALM	54.10	149721	12
2-679-0423 Filler bar - 5/8" x 1-1/4" for 2952/2954	DBZ	89.80	149743	12
2-679-0491 Angle Bracket - 1-1/2" x 1-1/2" for 2951/2953	ALM	51.95	149734	12
2-679-0493 Angle Bracket - 1-1/2" x 1-1/2" for 2951/2953	DBZ	87.65	149744	12
2-679-0501 Angle Bracket - 2" x 1-1/2" for 2951/2953	ALM	54.10	149735	12
2-679-0503 Angle Bracket - 2" x 1-1/2" for 2951/2953	DBZ	89.80	149745	12
2-679-0571 Angle Bracket - 1-1/2" x 1-1/2" for 2952/2954	ALM	69.25	149736	12
2-679-0573 Angle Bracket - 1-1/2" x 1-1/2" for 2952/2954	DBZ	104.95	149746	12
2-679-0581 Angle Bracket - 2" x 1-1/2" for 2952/2954	ALM	73.55	149737	12
2-679-0583 Angle Bracket - 2" x 1-1/2" for 2952/2954	DBZ	109.25	149747	12
Note: Additional finishes available on many of the 2950 magnetic lock series accessories. Inquire with Hager Customer Service for pricing				
2961 Magnetic Shear Lock 2,000 lb. holding force 1-5/8" depth, integrated electronics	US32D	854.40	151837	6
2965 Magnetic Shear Lock 2,700 lb. holding force 1-5/8" depth, integrated electronics ITC, FTC, HTC Same Price	US32D	924.70	151838	6
Options: ITC for standard mounting armature kit for aluminum and hollow metal doors with 7/8" to 1-1/8" deep top channels, wood doors, and factory prepared hollow metal flush edge doors. FTC for mounting for field prepared horizontal mounting in hollow metal doors with flush edge. HTC for mounting 1-15/16" deep Herculite channels. Herculite top rail armature adjustment bracket for leading edge adjustments (HTR) \$393.75 list price adder Magnetic bond sensor (MBS) \$127.05 list price adder Door Position sensor (DPS) \$57.75 list price adder				
2-679-0600 Wood Door reinforcement box for 2961	-	47.60	158750	6
2958 Delayed Egress Magnetic Lock 1,650 lb. holding force Surface mount - single 12/24 VDC	ALM DBZ	1,308.65 1,378.65	149748 176098	6
2958 T Tandem Delayed Egress Magnetic Lock 1,650 lb. holding force Surface mount - double 12/24 VDC	ALM DBZ	2,200.90 2,276.60		6



Electrified Products

Description	Finish	2018 List	Stock No.	Case Qty.
<p>Operation (Must Specify): NA - IBC, IFC, NFPA101, NFPA1-UFC, UBC, SBC Compliant ND - IBC, IFC, California Building Code OSHPD, NFPA 101, NFPA1-UFC, UBC, SBC Compliant BD - BOCA National Building Code CH - City of Chicago Building Code</p> <p>Reset Control: Built in key switch - 1-30 second timed bypass, sustained bypass and alarm reset (std) (Not available with BOCA and Chicago operation) Built in reset push switch. Available with NFPA (NA) only Less key or push switch (No price reduction)</p> <p>Options: Door Position Status (DPS) \$43.30 list price adder Magnetic Bond Sensor (MBS) \$70.85 list price adder Anti-Tamper Switch (ATS) \$59.50 list price adder</p>				
 <p>2972 Exit Switch</p> <p>MSD 2" Square button Momentary, SPDT 10 AMP contact</p>	US32D	75.75	149630	12
 <p>2972T Exit Switch with Integrated Adjustable Timer</p> <p>2" Square Button Adjustable 1-60 second timer Note: Not Code Compliant</p>	US32D	146.05	151710	6
<p>Options: Red LED \$21.65 list price adder Green LED \$21.65 list price adder 2 LED's \$27.05 list price adder</p>				
 <p>2973 Code Compliant Exit Switch</p> <p>2" Square Button Integrated fixed 30- second timer CSFM Listed, NFPA, IBC, IFC code compliance for Access Controlled Egress Doors LED illumination</p>	US32D	151.45	149631	6
<p>Options: Red LED \$21.65 list price adder Green LED \$21.65 list price adder 2 LED's \$27.05 list price adder</p>				
 <p>2977 Exit Switch</p> <p>Piezoelectric Button Green & Red Illumination Adj. 1-35 sec. 12/24VDC Timer</p>	US32D	151.45	149634	12
 <p>2978 Touchless Exit Switch</p> <p>Infrared sensor Illuminated status indication</p>	US32D	89.25	149636	12
 <p>4801 Pressure Sense Bar</p> <p>Pressure sense technology; Tri-failsafe 12/24 VDC voltage sense input includes 10 ft. cable and connector; armored power transfer loop 36" Standard, Optional 42" & 48" available</p>	ALM BLK	392.60 392.60	156360 167722	6



Description	Finish	2018 List	Stock No.	Case Qty.
2-679-0611 PIR Egress Sensor	White	259.60	149632	12
2-679-0612 PIR Egress Sensor	Black	259.60	149633	12
2-679-0708 Under Desk Push Switch	White	111.65	176289	1
2-679-0620 Concealed Mortise Power Transfer Loop	-	71.40	149750	12
2-679-0621 Heavy Duty Power Transfer 2-Wire	ALM	427.20	152079	6
2-679-0622 Heavy Duty Power Transfer 2-Wire	DBZ	427.20	160604	6
2-679-0623 Heavy Duty Power Transfer 10-Wire	ALM	427.20	149751	6
2-679-0624 Heavy Duty Power Transfer 10-Wire	DBZ	427.20	154018	6
2-679-0625 Concealed Magnetic Contact	ALM	118.15	152890	12
2-679-0626 Magnetic Switch	-	37.90	182672	1
2-679-0640 Single gang back box	-	14.35	149752	1
2-679-0641 3-gang interior mount box	-	107.10	166911	1
2-679-0642 Shroud for surface mount box outdoor use	-	68.00	166912	1
2-679-0650 Emergency Door Release Blue break glass station	-	218.50	149754	6



8400 Series - Low Energy Power Operator



Description	Mount	Finish	2018 List	Stock No.	Box Qty.
8418 Single Operator	Push	ALM	4,507.65	162136	1
1 unit, 1 controller, single cover, handed		DBZ	4,507.65	162141	
Standard Sizes - 36"	Pull	ALM	4,538.10	162138	
42", 44" and 48" - add \$85.40 to list price		DBZ	4,538.10	162143	
Specify Push or Pull side of door					
8419 Simultaneous Pair	Push	ALM	8,090.25	162145	1
2 units, 1 controller, double cover, non-handed		DBZ	8,090.25	162147	
Standard Sizes - 60" and 72"	Pull	ALM	8,190.00	162146	
84", 88", 92" and 96" - add \$85.40 to list price		DBZ	8,190.00	162148	
Specify Push or Pull side of door					
8420 Independent Pair	Push	ALM	8,842.05	162149	1
2 units, 2 controllers, double cover, non-handed		DBZ	8,842.05	162151	
Standard Sizes - 60" and 72"	Pull	ALM	8,944.95	162150	
84", 88", 92" and 96" - add \$85.40 to list price		DBZ	8,944.95	162152	
Specify Push or Pull side of door					
8421 Double Egress Simultaneous Pair	Push/Pull	ALM	8,594.00	162153	1
2 units, 1 controller, double cover, non-handed		DBZ	8,594.00	162154	
Standard Sizes - 60" and 72"					
84", 88", 92" and 96" - add \$85.40 to list price					
8422 Double Egress Independent Pair	Push/Pull	ALM	9,392.20	162155	1
2 units, 2 controllers, double cover, non-handed		DBZ	9,392.20	162156	
Standard Sizes - 60" and 72"					
84", 88", 92" and 96" - add \$85.40 to list price					
8423 Single Operator with Mechanical Closer	Push	ALM	6,090.00		1
1 unit, 1 controller, 1-5100 Series Door Closer,		DBZ	6,090.00		
double cover, handed	Pull	ALM	6,090.00		
Standard Sizes - 60" and 72"		DBZ	6,090.00		
84", 88", 92" and 96" - add \$85.40 to list price					
Specify Push or Pull side of door					
*Note: Non-standard door widths in quantities under 50 units: add \$208.40 per unit.					
*Note: Curtain wall operators are available. Please contact Technical Support					



8400 Series - Low Energy Power Operator



Description	Finish	Year List	Stock No.	Case Qty.	Box Qty.
2-659-0151 Pull Side Track Arm with 20mm Spindle	ALM	435.75	162512	-	1
2-659-0152 Pull Side Track Arm with 20mm Spindle	DBZ	530.25	162513	-	
2-659-0153 Push Side Standard Arm with 35mm Spindle	ALM	435.75	162515	-	1
2-659-0154 Push Side Standard Arm with 35mm Spindle	DBZ	530.25	162516	-	
2-659-0220 Push Side Standard Arm with 50mm Spindle For use with double egress assemblies	ALM	435.75	162561	-	1
2-659-0221 Push Side Standard Arm with 50mm Spindle For use with double egress assemblies	DBZ	530.25	162562	-	
2-659-0222 Double Egress Arm Assembly Track arm with 20mm Spindle	ALM	787.50	162563	-	1
2-659-0223 Double Egress Arm Assembly Track arm with 20mm Spindle	DBZ	892.50	162564	-	
2-659-0224 20mm Replacement Spindle For use with double egress and track arm assembly	ALM	150.70	162565	-	1
2-659-0225 20mm Replacement Spindle For use with double egress and track arm assembly	DBZ	183.75	162566	-	
2-659-0226 35mm Replacement Spindle For use with standard single and standard pair applications	ALM	150.70	162567	-	1
2-659-0227 35mm Replacement Spindle For use with standard single and standard pair applications	DBZ	183.75	162568	-	
2-659-0228 50mm Replacement Spindle	ALM	150.70	162570	-	1
2-659-0229 50mm Replacement Spindle For use with push side standard arm - double egress only	DBZ	183.75	162573	-	
2-659-0230 Narrow Top Rail Drop Plate	ALM	133.35	162693	-	1
2-659-0231 Narrow Top Rail Drop Plate	DBZ	133.35	162694	-	
2-659-0232 Cover for Single Operator - 36"	ALM	252.00	162574	-	1
2-659-0233 Cover for Single Operator - 36"	DBZ	252.00	162661	-	



8400 Series - Low Energy Power Operator



Description	Finish	2018 List	Stock No.	Case Qty.	Box Qty.
2-659-0234 Cover for Dual Operators - 72"	ALM	441.00	162663	-	1
2-659-0235 Cover for Dual Operators - 72"	DBZ	441.00	162692	-	-
Note: Additional sizes available. Inquire with Hager customer service for pricing.					
2-659-0236 Power Supply On-Board 115 VAC 60Hz 24 VDC 500mA		824.25	162696	-	1
2-659-0237 Relay Board 24VDC 40mA 5 amp/ 220 VAC or 28VDC DPDT contacts		32.05	162697	-	1



8200 Series - Low Energy Power Operator



Description	Size	Finish	2018 List	Stock No.	Box Qty.
8218 Single Operator	31.5"	ALM	2,500.00	184311	1
1 unit, standard arm, single 31.5" cover, non-handed		DBZ	2,553.60	184312	1
Standard Size Header - 31.5", Full Width Header - 51.5", custom sizes available from 31.5" to 51.5" - add \$225 to list	51.5"	ALM	2,800.00	184313	1
Standard Arm included (push side mount, 0 - 4.1875" reveal)		DBZ	2,864.30	184314	1
Deep Reveal Arm (4.125" - 9.875") - add \$225 to list price					
8219 Simultaneous Pair Operator		ALM	5,782.10	184317	1
1 unit, standard arm, single 75.5" cover, non-handed		DBZ	5,889.30	184318	1
Standard Size Header - 75.5", custom sizes available from 75.5" to 101.5" - add \$225 to list					
Standard Arm included (push side mount, 0 - 4.1875" reveal)					
Deep Reveal Arm (4.125" - 9.875") - add \$225 to list price					
Includes Multiple Door Module (2-659-0276)					
8221 Double Egress Simultaneous Pair Operator		ALM	5,782.10	185390	1
1 unit, standard arm, single 75.5" cover, non-handed		DBZ	5,889.30	185391	1
Standard Size Header - 75.5", custom sizes available from 75.5" to 101.5" - add \$225 to list					
Standard Arm included (push side mount, 0 - 4.1875" reveal)					
Deep Reveal Arm (4.125" - 9.875") - add \$225 to list price					
Includes Multiple Door Module (2-659-0276)					

Description	Finish	2018 List	Stock No.	Case Qty.	Box Qty.
2-659-0275		178.60	184232	-	1
Exterior Door Module (EDM) for 8200 Auto Operator					
Provides On-Board Output for 24VDC Electric Strike or Magnetic Lock as with (0.2 – 4.0s) delay, allows for day/night mode operation, and provides programming interface when used with promgrammer (2-659-0280)					
2-659-0276		250.00	184247	-	1
Multiple Door Module (MDM-B) for 8200 Auto Operator					
Allows for operation of double leaved doors					
2-659-0277		178.60	184269	-	1
Programming Interface Module (PIM) for 8200 Auto Operator					
2-659-0280		446.50	184279	-	1
iMotion Programmer w/ 6' Cord					
2-659-0278		778.60	184272	-	1
Battery Backup with Interface Cable for 8200 Auto Operator					
Single Openings: 33" minimum header					
Paired Openings: 36" minimum header					
2-659-0279		60.70	184278	-	1
Battery Backup Extension Harness for 8200 Auto Operator					



8200 Series - Low Energy Power Operator

Description	Finish	2018 List	Stock No.	Case Qty.	Box Qty.
2-659-0283 2.65" Drive Shaft Arm (double egress/deep reveal)		135.70	184282	-	1
2-659-0284 3.22" Drive Shaft Arm (standard in & out)		89.30	184283	-	1
2-659-0285 3.94" Drive Shaft Arm (special applications)		135.70	184286	-	1
2-659-0286 4.84" Drive Shaft Arm (double egress out)		242.85	184287	-	1
2-659-0319 Drive Arm Removal Tool		87.50	194678	-	1
2-659-0287 Push Side Arm (0 - 4.1875" reveal) CLR (standard arm)		342.45	184289	-	1
2-659-0288 Push Side Arm (0 - 4.1875" reveal) BLK (standard arm)		342.45	184290	-	1
2-659-0289 Push Side Arm (4.125 - 9.875" reveal) CLR		342.45	184292	-	1
2-659-0290 Push Side Arm (4.125 - 9.875" reveal) BLK		342.45	184297	-	1
2-659-0291 Double Egress Outswing Door Arm Assembly (0 - 4.1875" reveal) CLR (standard arm)		342.45	184298	-	1
2-659-0292 Double Egress Outswing Door Arm Assembly (0 - 4.1875" reveal) BLK (standard arm)		342.45	184300	-	1
2-659-0293 Double Egress Outswing Door Arm Assembly (4.125 - 9.875" reveal) CLR		342.45	184301	-	1
2-659-0294 Double Egress Outswing Door Arm Assembly (4.125 - 9.875" reveal) BLK		342.45	184302	-	1
2-659-0295 Pull Side Arm and Slide Track (0" reveal) CLR		342.45	184303	-	1
2-659-0296 Pull Side Arm and Slide Track (0" reveal) BLK		342.45	184304	-	1
2-659-0297 RH Pull Side Deep Reveal Arm and Track (0 - 6" reveal) CLR		570.80	184306	-	1
2-659-0298 RH Pull Side Deep Reveal Arm and Track (0 - 6" reveal) BLK		570.80	184307	-	1
2-659-0299 LH Pull Side Deep Reveal Arm and Track (0 - 6" reveal) CLR		570.80	184308	-	1
2-659-0300 LH Pull Side Deep Reveal Arm and Track (0 - 6" reveal) BLK		570.80	184309	-	1
2-659-0301 Communication Harness for Pairs		146.45	184310	-	1



Electrified Products - Low Energy Power Operator Controls



Description	Finish	2018 List	Stock No.	Case Qty.	Box Qty.
2-659-0303 6" Round with Text & Logo	US32D/Blue	206.00	185055	12	1
2-659-0304 6" Round with Logo Only	US32D/Blue	206.00	185058	12	1
2-659-0305 4-3/4" Square with Text & Logo	US32D/Blue	206.00	185056	12	1
2-659-0306 4-3/4" Square with Logo Only	US32D/Blue	206.00	185059	12	1
2-659-0307 4-3/4" Square with Logo Only	US32D/Blue	206.00	186793	12	1
2-659-0308 4-3/4" Square with Text Only	US32D/Blue	206.00	186794	12	1
2-659-0161 6" Round Actuator Push To Open and Handicap Symbol	US32D/Blue	123.60	162698	20	1
2-659-0162 6" Round Actuator Handicap Symbol	US32D/Blue	123.60	162699	20	1
2-659-0163 Surface Mount Box For 6" Round Actuator	Black	41.20		20	1
2-659-0164 Weather Ring For 6" Round Actuator	Black	8.25	162701	10	1



Electrified Products - Low Energy Power Operator Controls



Description	Finish	2018 List	Stock No.	Case Qty.	Box Qty.
2-659-0165 4.5" Round Actuator Push To Open and Handicap Symbol	US32D/Blue	107.15	162703	20	1
2-659-0166 4.5" Round Actuator Handicap Symbol	US32D/Blue	107.15	162704	20	1
2-659-0167 Surface Mount Box For 4.5" Round Actuator	Black	33.00	162705	20	1
2-659-0168 Weather Ring For 4.5" Round Actuator	Black	8.25	162706	10	1
2-659-0241 Universal Back Plate For use when mounting 4.5" round or 4.5" square actuator to bollard post	US32D	26.80	162743	10	1
2-659-0169 6" Square Actuator Push To Open and Handicap Symbol	US32D/Blue	123.60	162707	20	1
2-659-0170 6" Square Actuator Handicap Symbol	US32D/Blue	123.60	162708	20	1
2-659-0171 Surface Mount Box For 6" Square Actuator	Black	33.00	162709	20	1
2-659-0172 4.5" Square Actuator Push To Open and Handicap Symbol	US32D/Blue	100.95	162710	20	1
2-659-0173 4.5" Square Actuator Handicap Symbol	US32D/Blue	100.95	162711	20	1



Electrified Products - Low Energy Power Operator Controls



Description	Finish	2018 List	Stock No.	Case Qty.	Box Qty.
2-659-0174 Surface Mount Box For 4.5" Square Actuator	Black	33.00	162712	45	1
2-659-0175 1.5" x 4.75" Jamb Actuator Push To Open and Handicap Symbol	US32D/Blue	97.85	162713	20	1
2-659-0176 1.5" x 4.75" Jamb Actuator Handicap Symbol	US32D/Blue	97.85	162714	20	1
2-659-0177 Surface Mount Box For 1.5" x 4.75" Jamb Actuator	Black	20.60	162715	20	1
2-659-0178 36" Low Profile Actuator Push To Open and Handicap Symbol Wireless Includes 433 MHz wireless transmitter Exceeds California Building Code, Section 1117B.6	US32D/Blue	721.00	162716	2	1
2-659-0179 36" Low Profile Actuator Push To Open and Handicap Symbol Hard Wired Exceeds California Building Code, Section 1117B.6	US32D/Blue	664.35	162717	2	1
2-659-0242 4.75" Vestibule Actuator Push To Open and Handicap Symbol	US32D/Blue	247.20	162741	20	1
2-659-0243 Surface Mount Box For 4.75" Vestibule Actuator	Black	77.25	162742	42	1
2-659-0180 Bollard Post For use with 4.5" round and 4.5" square push plates	Black	515.00	162720	1	1
2-659-0181 Bollard Post For use with 4.5" round and 4.5" square push plates	Bronze	515.00	162724	1	1



Electrified Products - Low Energy Power Operator Controls



Description	Finish	2018 List	Stock No.	Case Qty.	Box Qty.
2-659-0182 Bollard Post For use with 4.5" round and 4.5" square push plates	Silver	515.00	162725	1	1
2-659-0183 433 MHz Receiver Digital, Radio Controlled	-	118.45	162726	20	1
2-659-0184 3-Volt Transmitter Wireless Hardwired to actuator	Black	113.30	162727	20	1
2-659-0185 9-Volt Transmitter Wireless	Black	113.30	162728	20	1
2-659-0186 Wireless Transmitter One Button	Black	113.30	162729	20	1
2-659-0240 Programmable Relay and Door Sequencer For door timing and advanced relay sequencing	-	164.80	162730	20	1

*Note: Actuators come standard hard-wired. Must order receiver and transmitter separately for wireless applications.





One Family. One Brand. One Vision.™

www.hagerco.com

TABLE OF CONTENTS

A	
Architectural Finish Symbols.....	3-4
B	
Back Plate	12
E	
ECCO	72-74
Emergency Stop Release.....	14
F	
Fasteners.....	9-10
D	
Detention Food Pass Through Hinge.....	31
Detention Hinge (IHT)	22, 28, 31
Detention Utility Hinge.....	31
H	
Hinge Additions/Modifications	5-11
Hinges - Air.....	5
Hinges - Electric	5-7
Hinge Pins	8
Hinge Tips.....	11
Hinges – Brass or Stainless Steel	
BALL BEARING FIVE KNUCKLE	
Anchor	33-34, 46
Full Mortise.....	39-51, 68
Full Surface.....	69-70
Half Mortise	32, 69
Half Surface	69-70
Swing Clear	67
Wide Throw	45-47, 50-51
CONCEALED BEARING THREE KNUCKLE	
Anchor	74-75
Full Mortise.....	24-28
Full Surface.....	26, 29
Half Mortise	26, 28
Half Surface	26, 29
Wide Throw	25-28
PLAIN BEARING FIVE KNUCKLE	
Full Mortise.....	39-40, 67
PLAIN BEARING THREE KNUCKLE	
Full Mortise.....	23, 29
CONCEALED BEARING FIVE KNUCKLE	
Full Mortise.....	43
CONCEALED BEARING TWO KNUCKLE	
Full Mortise.....	30

Hinges – Steel

BALL BEARING FIVE KNUCKLE	
Anchor	33-34
Full Mortise.....	35-38, 56-57, 60-62, 65-66
Full Surface.....	70-71
Half Mortise	32
Half Surface	33
Swing Clear	55-56
Wide Throw	37-38, 63-66
CONCEALED BEARING THREE KNUCKLE	
Anchor	72-73
Full Mortise.....	17-23
Full Surface.....	20, 22
Half Mortise	20, 22
Half Surface	20, 23
Swing Clear	71-74
Wide Throw	19-22
PLAIN BEARING FIVE KNUCKLE	
Full Mortise.....	56-59
Half Mortise	32
Half Surface	37
Swing Clear	54-56
Welding	69
PLAIN BEARING THREE KNUCKLE	
Full Mortise.....	15-16
CONCEALED BEARING TWO KNUCKLE	
Full Mortise.....	30
PLAIN BEARING TWO KNUCKLE	
Full Mortise.....	29, 31
Hinges – Spring	
Double Acting	67
Full Mortise.....	51-54
Full Mortise - Stainless Steel.....	32
Half Surface	52
Reverse Action.....	53-54
Spring Hinge Sets.....	53

L

Lead Times	2
------------------	---

M

Molly Jack Nut.....	12
Mortar Box.....	12



Commerical Hinges

P

Pivots.....	13-15
Pivots Rack & Pinion	14
Pivot Reinforcing	12

R

Reinforcement Plate	12
---------------------------	----

S

Set Screws (Set).....	12
Sleeve Bolt.....	13
Strike - Combination Rescue	13
Strike - Double Lip.....	12-13

T

Tip Kits.....	65-66
---------------	-------

LEAD TIMES

Stock items will typically ship in five working days or less from the order entry date. Made-to-order items will typically ship in 15 working days depending on seasonal volume and order complexity. Special orders including industrials, special machining, and large quantities may need to be scheduled. The anticipated ship date will be included with each order acknowledgement. Please contact Customer Service if product availability is in question.

QUICK SHIP

Products denoted with **red and bold** pricing are available to order through the Quick Ship program and ship within 24 hours. When ordering these products please visit www.hagerco.com and log in to MyHager to access the 'Quick Ship' portal. Due to the promptness of the fulfillment process, Quick Ship orders are non-cancellable.

CANCELLATION NOTIFICATION

Cancellation for made-to-order items must be communicated within 48 hours of order placement.

ARCHITECTURAL FINISH SYMBOLS

These additions apply to the BASE HINGE LIST PRICE as listed in the book. Not all products are available in all finishes. Contact Hager Companies Sales and Service (1-800-325-9995) for more specific information.

BHMA Symbol Base Material

*if not listed in pricing sections

US & HAGER	DESCRIPTION	PRICING INSTRUCTIONS	STEEL	BRASS & BRONZE	STAINLESS STEEL
2C	Plain Zinc Plate	20% above US10A or US10B price	603	N/A	N/A
H2H x BP	Mechanical Galvanized; Steel Only	25% above US10A price	N/A	N/A	N/A
3	Bright Brass	Use price of US10B	632	605	N/A
3A	Bright Brass - Unlacquered	Use price of US3	N/A	N/A	N/A
3SC	Brass SecureCoat® Lifetime Bright Brass Finish	Price on Application	N/A	N/A	N/A
4	Satin Brass	Use price of US10	633	606	N/A
5	Satin Brass, Oxidized	Use price of 10A/10B	638	609	N/A
9	Bright Bronze	20% above US10A or US10B price	637	611	N/A
10	Satin Bronze	As listed	639	612	N/A
10A (US11)	Antique Bronze, Lacquered	As listed (steel only)	641/643	N/A	N/A
10B	Antique Bronze, Oiled	Use price of US10A	640	613	N/A
10Z	Antiqued Bronze-SPL	Use price of US10A/US10B	N/A	N/A	N/A
10D	Black Nickel, Oiled	Use price of US10B	640	613	N/A
SS/10Z	Antique Bronze, Stainless Steel	30% above 32D	N/A	N/A	N/A
14	Bright Nickel	20% above US10A or US10B	645	618	N/A
14B	Black Nickel, Bright	20% above US10A or US10B	N/A	N/A	N/A
15	Satin Nickel	Use price of US10A or US10B	646	619	N/A
15A	Satin Nickel, Nickel Oxidized & Highlighted	20% above US10A or US10B	647	620	N/A
17A	Black Nickel, Dull	20% above US10A or US10B	648	621	N/A
26	Bright Chromium Plated	Use price of US10A or US10B	651	625	N/A
26D	Satin Chromium Plated	As listed	652	626	N/A
32	Stainless Steel Metal, Bright	Use price of US32D	N/A	N/A	629
32D	Stainless Steel Metal, Satin (304)	As listed	N/A	N/A	630
32D (316)	Stainless Steel Metal, Satin (316)	POA	N/A	N/A	630
32D (CLR)	Stainless Steel Metal, Satin (Clear Coat)	30% above US32D	N/A	N/A	630
P	Prime Coat	Use price of US10	600	600	N/A
PS	Plain Steel	Use price of US4 or USP	N/A	N/A	N/A
L1	Flat Black	Use price of US10	693	693	N/A
L2 (90P)	Dark Bronze	Use price of US10	695	695	N/A
L3	Medium Bronze	Use price of US10	694	694	N/A
LS	Luma Sheen®	Use price of US10	689	689	N/A



Commercial Hinges

Colors By Hager

US & HAGER	DESCRIPTION	PRICING INSTRUCTIONS	HEWI #
13P	White	20% above US10 price	1
14P	Off White	20% above US10 price	5A
15P	Grey	20% above US10 price	5
33P	Yellow	20% above US10 price	14
34P	Red	20% above US10 price	33
35P	Green	20% above US10 price	6
36P	Blue	20% above US10 price	52
83P	Black	20% above US10 price	8
84P	Olive	20% above US10 price	62
85P	Brown	20% above US10 price	9
86P	Burgundy	20% above US10 price	30
87P	Dark Green	20% above US10 price	60
88P	Dark Blue	20% above US10 price	50

Notes: -Colors by Hager are available only on architectural grade full mortise plain bearing hinges, full mortise ball bearing hinges, both standard and heavy weight, in both steel and brass material.
-For any finish not listed in this price book, or explained above, price and availability on request.

Whenever possible, Hager Companies employs the latest technologies in metal finishing to provide the best long-term performance for our customers. Some finishes may not comply completely with BHMA (Builders Hardware Manufacturing Association) Standard A156.18 specifications with regard to plating process. However, they match BHMA color standards and exceed all BHMA performance criteria with regard to such tests as salt spray corrosion resistance, ultraviolet light deterioration resistance, solvent resistance, perspiration resistance, and finish hardness. For the convenience of our customers, we refer to the most appropriate finish symbols to indicate similarity of appearance using BHMA standard nomenclature including the "US" and numerical designation. Dissimilar metals are plated to match or be compatible to the finishes indicated. Finish numbers indicated on each product are the most equivalent to the old "US" symbol numbers and carry the BHMA finish symbol in parenthesis adjacent to the finish: Example — US3 (605) - Bright Brass or US26D (626) - Satin Chrome.

Hager's finishes are durable, high quality finishes obtained by careful processing of steel, brass, and stainless steel materials. It is important to consider usage and climatic conditions when selecting finishes. This is especially true in areas subjected to strong corrosive chemical conditions, humid climate or salt air which may have a damaging effect on metal finishes in a very short period of time. The longevity and preservation of the finish appearance are determined by base metal and finish process.

Care and maintenance of clear protective coatings or other organic finishing applications may require different methods of cleaning and care. As an example, all hardware finishes should not be cleaned with solvents or abrasives; surfaces should periodically be cleaned with a mild, non-abrasive soap and dried lightly with a soft, clean cloth. The type of base material and finishing techniques must be considered when applying any cleaning or preservative method. Contact Hager's Sales and Service Department for further information on the care of hardware finishes.

Note: Hager only warrants US10B finish over brass or bronze base material. If steel base material is necessary, Hager recommends US10A lacquer finish.

HINGE ADDITIONS/MODIFICATIONS

These additions apply to the BASE HINGE LIST PRICE as listed in the book. They do not apply to the price of any hinges listed with additions in this book. If the hinge to be priced has additions, START WITH THE PRICE OF THE BASE HINGE, THEN ADD "FOR ADDITIONS WHERE NOT LISTED."

Antimicrobial powder coat protection - Symbol is 'MV5' (use as suffix). List price is \$22.70.

Bearings

Ball bearings (symbol 'BB') and anti-friction bearings (symbol 'AB') regularly furnished. Oilite bearings (symbol 'OB') and CB (concealed bearing) available at same price as ball bearings.

*To maximize hinge life and assist in achieving ADA compliance, Hager recommends the use of anti-friction or ball bearing hinges with door closer products.

Concealed Air Transfer Hinge Modification

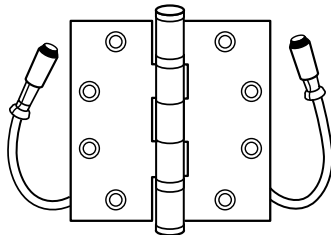
	CONCEALED AIR TRANSFER HINGE	
	Description Continuous air tubing with quick connect fittings capable of 80-100 PSI. Available in 4-1/2" x 4", 4-1/2" x 4-1/2", 5" x 4", 5" x 4-1/2", and 5" x 5" full mortise ball bearing, standard weight and heavy weight in steel, stainless steel and brass material. NRP not necessary. To order, use symbol 'AIR' as suffix.	List Extra charge \$349.65 per hinge for steel and brass. Extra charge \$357.80 per hinge for stainless steel.

Exposed Electric Hinge Modification

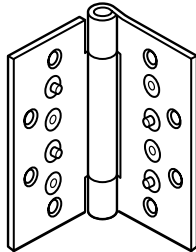
	EXPOSED ELECTRIC CONTACTS	
	Description 4" hinge - 2 or 3 contacts 4-1/2" and 5" hinge - 2, 3, or 4 contacts Only one hinge per door requires electric contact. To order, use symbol 'E' as suffix and the number of contacts desired.	List Extra charge \$126.65 per each contact.

Note: All exposed contact hinges must be ordered with NRP feature. Patent No. 3,650,063.

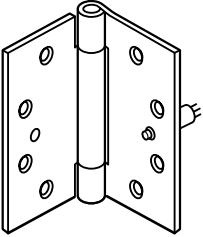

Commercial Hinges

	EXPOSED ELECTRIC SWITCH	
	Description	List
	<p>Miniature push button switch that is incorporated in the hinge leaves. Available on 4", 4-1/2", and 5" hinges.</p> <p>Only one hinge per door requires electric switch.</p> <p>To order, use symbol 'E1S' as suffix.</p>	<p>Extra charge \$126.65 per each contact.</p>
<p>Note: All exposed contact hinges are supplied standard with NRP feature. Patent No. 3,715,537.</p>		

Concealed Electric Hinge Modification

Swing clear, wide throw, raised barrel – add \$160. Available on Heavy weight only.

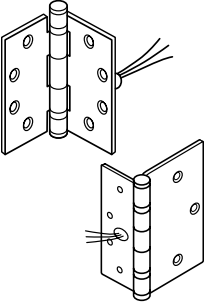
	CONCEALED ELECTRIC MONITOR		
	Description	Steel/Brass List	Stainless Steel List
	<p>Miniature snap action switch is incorporated into the frame leaf. Available in 4" through 8". Full mortise ball bearing hinges. Concealed electric monitor, per hinge.</p>	<p>\$352.35</p>	<p>\$460.15</p>
<p>NRP not necessary as hinges are cross pinned and are not field removable. To order, use symbol 'EMN' as suffix.</p>			

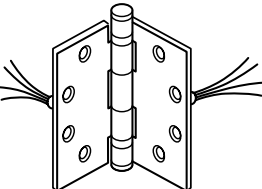
	CONCEALED ELECTRIC THROUGH-WIRE		
	Description	Steel/Brass List	Stainless Steel List
	<p>Four continuous electric conductors (28 gauge wire). Available in 4" through 8". Full mortise ball bearing, standard weight and heavy weight in steel and brass material. NRP not necessary as hinges are cross pinned and are not field removable. To order, use symbol 'ETW' as suffix.</p>		
	<p><u>Extra charges (each)</u></p> <p>ETW-4 (4 wire)</p> <p>ETW-8 (8 wire)</p> <p>ETW-12 (12 wire)</p>	<p>\$314.05</p> <p>\$348.25</p> <p>\$487.45</p>	<p>\$392.55</p> <p>\$435.30</p> <p>\$609.35</p>
	<p>ETW-2 (18 GA)**</p> <p>ETW-6-1828 (2-18 GA, 4-28 GA)*/**</p> <p>ETW-8-1828(2-18 GA, 6-28 GA)*/**</p>	<p>\$414.55</p> <p>\$459.65</p> <p>\$508.40</p>	<p>\$517.00</p> <p>\$574.60</p> <p>\$634.45</p>

* Not available on three knuckle hinges. ** Not available on swing clear.

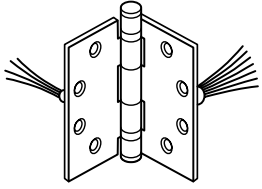

CONCEALED ELECTRIC THROUGH-WIRE & MONITOR			
Description		Steel/Brass List	Stainless Steel List
	This combines the 4, 8, or 10 continuous electrical conductors and the miniature snap action switch to provide continuous circuit and monitor capabilities. Available in 4" through 8". Full mortise ball bearing or anti-friction bearing, standard weight and heavy weight in steel and brass material. NRP not necessary as hinges are cross pinned and are not field removable. To order, use symbol 'ETM' as suffix.		
	<u>Extra charges (each)</u>		
	ETM-4 (4 wire)	\$666.40	\$833.00
	ETM-8 (8 wire)	\$697.75	\$872.20
	ETM-10 (10 wire)	\$764.65	\$955.75
The hospital tip feature is available on concealed electric hinges.			

STANDARD WIRE LEAD - 8" per side: 18 or 28 gauge wire	
Additional wire leads - must be bought in 4, 8, and 12 feet lengths. Price includes both sides.	
Description	List
4-wire hinge; per foot	\$7.45
6-wire hinge; per foot	\$7.45
8-, 10-, 12-wire hinge; per foot	\$7.45

Quick Connect

Extra charge \$43.40 per hinge (available on ETW 4, 8, and 12 wire. Not available with 18g wire.).

QUICK CONNECT HARNESS CABLES - connectors installed on one end, pigtails on the other for easy install in the field		
Part Number	Description	List Price
1-479-0007	3" Wire Harness Assembly	\$55.90
1-479-0008	6" Wire Harness Assembly	\$58.30
1-479-0012	12" Wire Harness Assembly	\$72.00
1-479-0026	26" Wire Harness Assembly	\$85.70
1-479-0032	32" Wire Harness Assembly	\$86.75
1-479-0038	38" Wire Harness Assembly	\$89.25
1-479-0044	44" Wire Harness Assembly	\$92.60
1-479-0400	50" Wire Harness Assembly	\$94.30
1-479-1500	15'2 Wire Harness Assembly	\$168.00

Five Knuckle Concealed Bearing Hinges (CB)

Available on standard weight, heavy weight full mortise 3-1/2", 4", 4-1/2", and 5". Price same as Ball Bearing (BB).



Commerical Hinges

Prices and Part Numbers for Hinge Pins (Boxes of 10 Each)

Contract Grade Pins Size 4-1/2"

STANDARD WEIGHT		
STEEL - FINISH	PART NUMBER	LIST (10/BOX)
US3	1-890-7550	\$63.45 per box
US4	1-890-7619	\$63.45 per box
US10	1-890-7695	\$63.45 per box
US10A/US10B	1-890-7733	\$63.45 per box
US26	1-890-7625	\$63.45 per box
US26D	1-890-7657	\$63.45 per box
USP	1-890-7771	\$63.45 per box
L1	1-890-7772	\$63.45 per box

HEAVY WEIGHT		
STEEL - FINISH	PART NUMBER	LIST (10/BOX)
US3	1-890-8269	\$77.60 per box
US10	1-890-8270	\$77.60 per box
US10A/US10B	1-890-8267	\$77.60 per box
US26D	1-890-8305	\$77.60 per box
USP	1-890-8268	\$77.60 per box

Non-Removable Pins (Medium Security)

Symbol	Description	List
NRP*	Set screw in barrel	\$5.00 ea.
FRP*	Pin spun or riveted at both ends	\$24.75 ea.

*This modification is intended as a deterrent only. It is not to be considered suitable for high-security applications or abusive environments.

Pins Not Regularly Furnished in Complete Hinge

Symbol	Description	List
BP	Brass Pin	\$7.90 - 3"
		\$11.40 - 3-1/2" to 4"
		\$15.35 - 4-1/2" to 5"
		\$21.20 - 6"
SP	Stainless Steel Pin	\$7.90 - 3"
		\$11.40 - 3-1/2" to 4"
		\$15.35 - 4-1/2" to 5"
		\$21.20 - 6"

Raised Barrel Hinges

- Specify handing and door thickness.
- Not available on 8" x 6" or 8" x 8" hinges.
- Prices apply to both standard and heavyweight hinges.
- **Prices listed for 1-3/8" and 1-3/4" doors only.**
- **For 2" or greater doors add 30%.**

Symbol	Description	List
RBB	Raised Barrel for Mortised Jamb Leaf, Beveled Edge Door Leaves Equal	\$44.75 ea.
RBS	Raised Barrel for Mortised Jamb Leaf, Square Edge Door Leaves Equal	\$44.75 ea.
JSM	Raised Barrel for Jamb Surface Mount, Leaves Equal	\$44.75 ea.



Clear Coat

Not available on all finishes.

<u>Symbol</u>	<u>List</u>
CLR	Add 30% to list price of hinge

Round Corners

Round corners (1/4" and 5/8" radius). Specify radius desired; standard radius 1/4".

<u>Symbol</u>	<u>List</u>
RC	\$8.00 ea.

Rust Resistant Undercoat with Painted Finishes

<u>Symbol</u>	<u>List</u>
CP/Plain bearing, all sizes	\$14.15 ea.
Ball bearing, all sizes	\$16.55 ea.

Safety Stud

Security offered to prevent slipping leaves past one another when hinge is closed. Stud attached to one leaf projects into hole in matching leaf.

<u>Symbol</u>	<u>List</u>
SH*	\$19.05 ea.

This feature not necessary on anchor hinges

* This modification is intended as a deterrent only. It is not to be considered suitable for high-security applications or abusive environments.

Reverse Safety Stud - Heavy Weight Only

Reverse safety studs extend into reinforcing plate of door & frame to help prevent screw shearing.

<u>Symbol</u>	<u>List</u>
RSS	\$29.40 ea.

Note: Available on steel, stainless steel detention or institutional tip hinges only. Not available on solid brass hinges.

Slip-In Hinges

1277/1278 & BB1277/BB1278 - Add to 1279/BB1279

List: \$105.35 ea.

1577/1578 & BB1577/BB1578 - Add to 1191/BB1191

List: \$105.35 ea.

Special Applications

In the event you do not find the particular hinge which will meet your requirements, we recommend that you contact Hager Companies Sales and Service and provide us with your specification.

Special Screws

All butt hinges are regularly packed with flat Phillips head wood or machine screws or bolts. All other types are special.

Extra for spanner head screws

<u>Description</u>	<u>List</u>
Steel	\$1.50 per screw 12.00 hinge
Brass	\$2.45 per screw 19.60 hinge
Stainless steel	\$5.25 per screw 42.00 hinge

Extra for tamper proof torx screws

<u>Description</u>	<u>List</u>
Steel	\$1.50 per screw 12.00 hinge
Stainless steel	\$1.95 per screw 15.60 hinge

Boxed Screws

Machine Torx (12-24 x1/2 - for 4", 4.5", 5" hinges)

<u>Description</u>	<u>List</u>
1-804-3212 (26D)	\$150.00 per box-torx (100/box)
1-803-3205 (32D)	\$175.00 per box-torx (100/box)

Wood Torx (1-1/4x12 - for 4", 4.5", 5" hinges)

<u>Description</u>	<u>List</u>
1-810-9920 (26D)	\$150.00 per box-torx (100/box)
1-813-9910 (32D)	\$175.00 per box-torx (100/box)



Commerical Hinges

Standard Screw Packs for Full Mortise Architectural Hinges

PART NUMBER	SIZE	FINISH	SCREWS
700, AB700, 1279, BB1279, EC1100, EC1105, 1250 (with or without NRP), ECBB1100	4-1/2" x 4-1/2" 4-1/2" x 4	US3, US4, US5, US10, US10A (US11), US10B, US15, US15A, US26, US26D, USP	AMS & AWS
Other than listed above	4-1/2"	Other than listed above	AMS & 1/2 WS
All	3-1/2"	All	AWS & 1/2 MS
All	4"	All	AWS & 1/2 MS
All	5"	All	AMS & 1/2 WS
All hinges with decorative tips	All	All	AWS

Note: Hinge additions listed on pages 5-9 will affect standard screw packaging.

Prices and Part Numbers for Bulk Packed Screws Contract grade hinges size 4", 4-1/2", and 5"

WOOD SCREWS 1-1/4" x 12 FPHW - STEEL			MACHINE SCREWS 12-24 x 1/2" FPHM - STEEL		
PART NUMBER	FINISH	LIST (100/BOX)	PART NUMBER	FINISH	LIST (100/BOX)
1-810-5824	US3	\$108.80 per box	1-800-7225	US3	\$54.20 per box
1-810-5952	US4	\$108.80 per box	1-800-7275	US4	\$54.20 per box
1-810-6208	US10	\$108.80 per box	1-800-7375	US10	\$54.20 per box
1-810-6336	US10A/US10B	\$108.80 per box	1-800-7425	US10A (US11)/US10B	\$54.20 per box
1-810-6848	US26	\$108.80 per box	1-800-7575	US26	\$54.20 per box
1-810-5696	US26D	\$108.80 per box	1-800-7175	US26D	\$54.20 per box
1-810-6976	USP	\$108.80 per box	1-800-7625	USP	\$54.20 per box
1-810-7232	L1	\$108.80 per box	1-800-7725	L1	\$54.20 per box

WOOD SCREWS 1-1/4" x 12 FPHW - BRASS			MACHINE SCREWS 12-24 x 1/2" FPHM - BRASS		
PART NUMBER	FINISH	LIST (100/BOX)	PART NUMBER	FINISH	LIST (100/BOX)
1-811-5824	US3	\$215.80 per box	1-801-7225	US3	\$108.05 per box
1-811-5952	US4	\$215.80 per box	1-801-7275	US4	\$108.05 per box
1-811-6208	US10	\$215.80 per box	1-801-7375	US10	\$108.05 per box
1-811-6336	US10A/US10B	\$215.80 per box	1-801-7425	US10A (US11)/US10B	\$108.05 per box
1-811-6848	US26	\$215.80 per box	1-801-7575	US26	\$108.05 per box
1-811-5696	US26D	\$215.80 per box	1-801-7175	US26D	\$108.05 per box
1-811-6976	USP	\$215.80 per box	1-801-7625	USP	\$108.05 per box
1-811-7232	L1	\$215.80 per box	1-801-7725	L1	\$108.05 per box

WOOD SCREWS 1-1/4" x 12 FPHW - STAINLESS STEEL			MACHINE SCREWS 12-24 x 1/2" FPHM - STAINLESS STEEL		
PART NUMBER	FINISH	LIST (100/BOX)	PART NUMBER	FINISH	LIST (100/BOX)
1-813-2500	US32	\$215.80 per box	1-803-2500	US32	\$108.05 per box
1-813-2499	US32D	\$215.80 per box	1-803-2499	US32D	\$108.05 per box

Stainless Steel Balls and Raceways

Furnished if desired on steel or brass ball bearing hinges.

<u>Description</u>	<u>List</u>
Standard weight two ball bearing hinge.....	\$23.35 ea.
Heavy weight four ball bearing hinge.....	\$28.25 ea.

Swaging

Swaging, no holes or flat surface, add 30% to list price of hinge.

Tips - Exposed

<u>Symbol</u>	<u>Description</u>	<u>List</u>
ET*	Button tip for three knuckle hinges only.....	N/C
*Exposed Tip	(ET standard on 5 knuckle)	





Tips - Hospital

<u>Symbol</u>	<u>Description</u>	<u>List</u>
HT*	Standard Weight and Heavy Weight Hinges	\$30.10
*Hospital Tip		

Tips - Decorator

Regular decorator tips are available on brass or steel hinges, three and five knuckle, for the type and size shown below. To order hinges with regular decorator tips, give the catalog number of the hinge, the size, the finish and the tip style.

Regular Decorator Tips:
 For example: BB1199 – 5" x 5" US3 Ball Tip
 BB1279 – 4-1/2" x 4-1/2" US10A Steeple Tip
 AB700 – 4-1/2" x 4-1/2" US3 Ball Tip

REGULAR DECORATOR TIPS (Supplied with all wood screws unless otherwise specified)			LIST
Acorn Tip		Standard Weight - 3-1/2", 4", 4-1/2", 5", and 6" Heavy Weight - 4-1/2", 5", 6", and 8"	\$46.95 \$46.95
Ball Tip		Standard Weight - 3", 3-1/2", 4", 4-1/2", 5", and 6" Heavy Weight - 4-1/2", 5", 6", and 8"	\$29.40 \$29.40
Steeple Tip		Standard Weight - 3", 3-1/2", 4", 4-1/2", 5", and 6" Heavy Weight - 4-1/2", 5", 6", and 8"	\$29.40 \$29.40
Urn Tip		Standard Weight - 3-1/2", 4", 4-1/2", 5", and 6" Heavy Weight - 4-1/2", 5", 6", and 8"	\$46.95 \$46.95

Note: Certain hinge additions/modifications may not be applicable. Please contact Hager Companies Customer Service before ordering.

Commercial Hinges



Description		Finish	2018 List	Stock No.	Box Qty.	Case Qty.
100 Set Screw Set		PS	360.05	001076		10
251 Full Surface Reinforcing Pivot for 3-1/2" (89 mm) wide hinges (specify handing).		LH US2C	188.30	001119		10
		RH US2C	188.30	001120		10
252 Full Surface Reinforcing Pivot for 4" (102 mm) wide hinges, non-handed.		LH US2C	188.30	001121		10
		RH US2C	188.30	001122		
253 Full Surface Reinforcing Pivot for 4-1/2" (114 mm) wide hinges, non-handed.		US2C	188.30	121571	1	
254 Full Surface Reinforcing Pivot for 5" (127 mm) wide hinges, non-handed.		US2C	188.30	121572	1	10
263 Thru Bolts for reinforcing 1-3/4" (45 mm) doors. Pack of 100		US2C	257.05	001141		1 pack
265 Molly Jack Nuts (8S JN) for Reinforcing Pivot Pack of 100		US2C	137.00	001143		1 pack of 100
305 Hinge Reinforcement Plate	4-1/2" (114 mm)	PS	8.55	001153		50
417 Back Plate for Wood Doors Half Surface Hinges or Full Surface Hinges	4-1/2" (114 mm)	USP	30.95	001195	10	100
		US10	30.95	001187		
		US26D	30.95	001190		
	5" (127 mm)	USP	32.85	001203	10	100
		US10	32.85	078619		
		US26D	32.85	001199		
430 Mortar Box		H2H	62.65	001206	1	
451 Double Lipped Strike Center Hung <i>*Other sizes available</i>	5-3/4" (146 mm)	US26D	198.10	001208	1	
452 Double Lipped Strike Center Hung <i>*Other sizes available</i>	6-3/4" (172 mm)	US26D	198.10	001209	1	
453 Double Lipped Strike 1/8" Inset <i>*Other sizes available</i>	5-3/4" (146 mm)	US26D	198.10	001210	1	

1. Items with the price in **bold and red** are Quick Ship items and ship in 24 hours. Please use stock number when ordering. 2. U/M is each unless otherwise noted.



Description	Finish	2018 List	Stock No.	Box Qty.	Case Qty.
454 Double Lipped Strike 1/8" Inset <i>*Other sizes available</i>	US26D	198.10	001211	1	
455 Center Hung Combination Rescue Door Stop and Two Way Strike Plates Specify Handing <i>*Other sizes available</i>	LH US26D RH US26D	566.15 566.15	001218 001219	1	
456 Center Hung Combination Rescue Door Stop and Two Way Strike Plates Specify Handing <i>*Other sizes available</i>	LH US26D RH US26D	570.85 570.85	001222 001223	1	
457 1/8" Inset Combination Rescue Door Stop and Two Way Strike Plates Specify Handing <i>*Other sizes available</i>	LH US26D RH US26D	566.15 566.15	001224 001225	1	
458 1/8" Inset Combination Rescue Door Stop and Two Way Strike Plates Specify Handing <i>*Other sizes available</i>	LH US26D RH US26D	594.40 594.40	001226 001227	1	
<i>*Other sizes available</i>	4 3/4" thru 8 3/4" greater than 8 3/4"	add \$80 to list of 6 3/4" size add \$125 to list of 6 3/4" size			
495 Forged Bronze - Full Mortise Ball Bearing Adjustable Top Pivot Hinge	US10 US10B US26D	246.65 246.65 246.65	001228 001231 001236	1	
496 Forged Bronze - Full Mortise Ball Bearing Adjustable Intermediate Pivot Hinge Specify Handing	LH US10 RH US10 LH US10B RH US10B LH US26D RH US26D	354.75 354.75 354.75 354.75 332.30 332.30	001242 001243 001244 001245 001250 001251	1	
497 Forged Bronze - Full Mortise Ball Bearing Adjustable Bottom Pivot Hinge Specify Handing	LH US10 RH US10 LH US10B RH US10B LH US26D RH US26D	569.35 569.35 569.35 569.35 559.35 559.35	001257 001258 001259 001260 001265 001266	1	

1. Items with the price in **bold and red** are Quick Ship items and ship in 24 hours.
Please use stock number when ordering. 2. U/M is each unless otherwise noted.



Commercial Hinges



Description	Finish	2018 List	Stock No.	Box Qty.	Case Qty.
500 Brass - Full Mortise Standard Weight Rack and Pinion Pivot	US4 US26D	504.45 519.00	001276 001274	1	16
510 Mortise Application - Hospital Set Wood Floor - Less Release	US26D	350.05	001278	1	10
511 Mortise Application - Hospital Set Masonry Floor - Less Release	US26D	417.45	001281	1	10
512 Surface Application - Hospital Set Masonry Floor - Less Release	US26D	417.45	001283	1	10
550 Brass - Full Mortise Heavy Weight Rack and Pinion Pivot	US4 US26D	603.75 622.75	001290 001288	1	10
551 Brass - Full Mortise Extra Heavy Weight Rack and Pinion Pivot	US4 US26D	664.20 683.75	113313 113311	1	10
600 Mortise Application - Hospital Set Wood Floor	US26D	624.75	001293	1	10
610 Emergency Stop Release	US26D	268.90	001296	1	10



Description	Finish	2018 List	Stock No.	Box Qty.	Case Qty.
611 Mortise Application - Hospital Set Masonry Floor	US26D	691.95	001298	1	10
612 Surface Application - Hospital Set Masonry Floor	US26D	691.95	001301	1	10
615 Steel - Heavy Weight Pivot Set for Frameless Opening	US26D	148.15	042688	1	10
700 Steel - Full Mortise Standard Weight Plain Bearing Three Knuckle	3-1/2" x 3-1/2" (89 mm x 89 mm)	LS 11.90 USP 8.85 US3 17.75 US4 11.90 US10 11.90 US10A (US11) 17.75 US10B 17.75 US26 17.75 US26D 14.85	- 000926 001311 001312 001303 001304 069448 001308 001309	2	100
	4" x 4" (102 mm x 102 mm)	LS 14.05 USP 10.90 US3 20.10 US4 14.05 US10 14.05 US10A (US11) 20.10 US10B 20.10 US26 20.10 US26D 18.15	14.05 10.90 20.10 14.05 14.05 20.10 20.10 20.10 18.15	3	48
	4-1/2" x 4" (114 mm x 102 mm)	LS 13.40 USP 11.50 US3 23.00 US4 13.40 US10 13.40 US10A (US11) 23.00 US10B 23.00 US26 23.00 US26D 14.60	085393 001350 001343 001344 001328 001329 001332 001336 001340	3	48

1. Items with the price in **bold and red** are Quick Ship items and ship in 24 hours.
Please use stock number when ordering. 2. U/M is each unless otherwise noted.



Commercial Hinges



Description	Finish	2018 List	Stock No.	Box Qty.	Case Qty.
700 - Cont.					
Continued					
4-1/2" x 4-1/2" (114 mm x 114 mm)	LS	13.40	-	3	48
	USP	11.50	001390		
	US3	23.00	001372		
	US4	13.40	001376		
	US10	13.40	001352		
	US10A (US11)	23.00	001355		
	US10B	23.00	001360		
	US26	23.00	001364		
	US26D	14.60	001367		
5" x 4" (127 mm x 102 mm)	LS	46.25	-	3	24
	USP	38.05	001399		
	US3	62.50	-		
	US4	46.25	-		
	US10	46.25	-		
	US10A (US11)	62.50	-		
	US10B	62.50	109332		
	US26	62.50	-		
	US26D	42.85	104223		
5" x 4-1/2" (127 mm x 114 mm)	LS	46.25	-	3	24
	USP	38.05	067157		
	US3	62.50	-		
	US4	46.25	123152		
	US10	46.25	038706		
	US10A (US11)	62.50	-		
	US10B	62.50	-		
	US26	62.50	065399		
	US26D	42.85	001403		
5" x 5" (127 mm x 127 mm)	LS	46.25	-	3	24
	USP	38.05	042507		
	US3	62.50	-		
	US4	46.25	-		
	US10	46.25	041251		
	US10A (US11)	62.50	115621		
	US10B	62.50	038084		
	US26	62.50	-		
	US26D	42.85	068632		





Description	Finish	2018 List	Stock No.	Box Qty.	Case Qty.
AB700					
Steel - Full Mortise	LS	35.55	124088	2	100
Standard Weight	USP	31.10	045449		
Concealed Anti-Friction Bearing	US3	43.00	044765		
Three Knuckle	US4	31.10	016859		
	US10	35.55	029909		
	US10A (US11)	43.00	012038		
	US10B	43.00	033999		
	US26	43.00	053130		
	US26D	36.90	091472		
4" x 4"	LS	35.55	-	3	48
(102 mm x 102 mm)	USP	31.10	001501		
	US3	43.00	001497		
	US4	31.10	001499		
	US10	35.55	098013		
	US10A (US11)	43.00	068298		
	US10B	43.00	034156		
	US26	43.00	022969		
	US26D	36.90	001495		

1. Items with the price in **bold and red** are Quick Ship items and ship in 24 hours.
 Please use stock number when ordering. 2. U/M is each unless otherwise noted.



Commercial Hinges



Description	Finish	2018 List	Stock No.	Box Qty.	Case Qty.	
AB700 - Cont. Continued	4-1/2" x 4" (114 mm x 102 mm)	LS	29.65	085392	3	48
		USP	20.90	001559		
		US3	35.80	001543		
		US4	29.65	095580		
		US10	29.65	001502		
		US10A (US11)	35.80	001507		
		US10B	35.80	001515		
		US26	35.80	001526		
		US26D	20.10	001533		
	4-1/2" x 4-1/2" (114 mm x 114 mm)	LS	29.65	122473	3	48
USP		20.90	001682			
US3		35.80	001645			
US4		29.65	001654			
US10		29.65	001574			
US10A (US11)		35.80	001585			
US10B		35.80	001597			
US26		35.80	001607			
US26D		20.10	001620			
5" x 4" (127 mm x 102 mm)		LS	57.90	-	3	24
	USP	57.90	069644			
	US3	73.30	046335			
	US4	57.90	017201			
	US10	57.90	047777			
	US10A (US11)	73.30	033653			
	US10B	73.30	047266			
	US26	73.30	001706			
	US26D	56.65	001709			
	5" x 4-1/2" (127 mm x 114 mm)	LS	57.90	-	3	24
USP		57.90	001748			
US3		73.30	001738			
US4		57.90	091318			
US10		57.90	098518			
US10A (US11)		73.30	097200			
US10B		73.30	028451			
US26		73.30	019133			
US26D		56.65	001727			
5" x 5" (127 mm x 127 mm)		LS	57.90	-	3	24
	USP	57.90	001773			
	US3	73.30	020279			
	US4	57.90	017173			
	US10	57.90	001758			
	US10A (US11)	73.30	008276			
	US10B	73.30	048588			
	US26	73.30	016080			
	US26D	56.65	025276			



Description	Finish	2018 List	Stock No.	Box Qty.	Case Qty.
WTAB700 Wide Throw Hinge Steel - Full Mortise Standard Weight Concealed Anti-Friction Bearing Three Knuckle	4-1/2" x 5" (114 mm x 127 mm)	LS	111.60	-	3 24
		USP	109.15	065577	
		US3	125.00	069940	
		US10	111.60	043251	
		US10A (US11)	125.00	030958	
		US10B	125.00	007941	
		US26	125.00	069304	
		US26D	116.95	001446	
	4-1/2" x 6" (114 mm x 152 mm)	LS	111.60	-	3 24
		USP	109.15	023667	
US3		125.00	026730		
US10		111.60	065978		
US10A (US11)		125.00	065835		
US10B		125.00	075797		
US26		125.00	062172		
US26D		116.95	001458		
4-1/2" x 7" (114 mm x 178 mm)	LS	120.35	-	3 24	
	USP	120.35	032001		
	US3	137.25	011172		
	US10	122.65	091490		
	US10A (US11)	137.25	047357		
	US10B	137.25	104122		
	US26	137.25	001467		
	US26D	128.55	039039		
4-1/2" x 8" (114 mm x 203 mm)	LS	120.35	-	3 24	
	USP	120.35	046359		
	US3	137.25	011806		
	US10	122.65	-		
	US10A (US11)	137.25	063050		
	US10B	137.25	104121		
	US26	137.25	081758		
	US26D	128.55	001469		
5" x 6" (127 mm x 152 mm)	LS	159.90	-	3 24	
	USP	152.20	110219		
	US3	190.25	054746		
	US10	159.90	077240		
	US10A (US11)	190.25	-		
	US10B	190.25	030049		
	US26	190.25	-		
	US26D	175.05	047936		
5" x 7" (127 mm x 178 mm)	LS	159.90	-	3 24	
	USP	152.20	134948		
	US3	190.25	-		
	US10	159.90	-		
	US10A (US11)	190.25	044063		
	US10B	190.25	045970		
	US26	190.25	-		
	US26D	175.05	088534		

1. Items with the price in **bold and red** are Quick Ship items and ship in 24 hours.
Please use stock number when ordering. 2. U/M is each unless otherwise noted.



Commercial Hinges



Description		Finish	2018 List	Stock No.	Box Qty.	Case Qty.	
WTAB700 - Cont. Continued	5" x 8"	LS	159.90	-	3	24	
	(127 mm x 203 mm)	USP	152.20	-			
		US3	190.25	-			
		US10	159.90	-			
		US10A (US11)	190.25	085769			
		US10B	190.25	104124			
		US26	190.25	-			
	US26D	175.05	040817				
AB701 Steel - Half Mortise Standard Weight Concealed Anti-Friction Bearing Three Knuckle	4-1/2" (114 mm)	USP	84.30	001851	3	48	
		US10	89.75	003060			
		US10A (US11)	125.55	060882			
		US10B	125.55	-			
		US26D	99.15	092567			
AB702 Steel - Full Surface Standard Weight Concealed Anti-Friction Bearing Three Knuckle	4-1/2" (114 mm)	USP	100.05	001859	3	48	
		US10	118.20	-			
		US10A (US11)	150.70	-			
		US10B	150.70	141799			
		US26D	132.60	016632			
AB703 Steel - Half Surface Standard Weight Concealed Anti-Friction Bearing Three Knuckle	4-1/2" (114 mm)	USP	98.60	097744	3	48	
		US10	107.80	072359			
		US10A (US11)	154.60	030194			
		US10B	154.60	074016			
		US26D	119.80	001866			
AB750 Steel - Full Mortise Heavy Weight Concealed Anti-Friction Bearing Three Knuckle	4-1/2" x 4" (114 mm x 102 mm)	LS	64.95	-	3	24	
		USP	64.95	096935			
		US3	77.05	073827			
		US4	64.95	071658			
		US10	64.95	001909			
		US10A (US11)	77.05	001911			
		US10B	77.05	065832			
		US26	77.05	001914			
		US26D	55.55	092641			
		4-1/2" x 4-1/2" (114 mm x 114 mm)	LS	64.95	114475	3	24
			USP	64.95	002006		
			US3	77.05	001982		
			US4	64.95	001987		
US10	64.95		001936				
US10A (US11)	77.05		001944				
US10B	77.05		001956				
US26	77.05		001965				
US26D	55.55	001970					





Description	Finish	2018 List	Stock No.	Box Qty.	Case Qty.
AB750 - Cont. Continued	5" x 4-1/2" (127 mm x 114 mm)	LS	83.50	-	3 24
		USP	83.50	002093	
		US3	86.95	002078	
		US4	83.50	002081	
		US10	83.50	092589	
		US10A (US11)	86.95	002044	
		US10B	86.95	002055	
		US26	86.95	016351	
		US26D	71.60	002064	
	5" x 5" (127 mm x 127 mm)	LS	83.50	-	3 24
USP		83.50	023577		
US3		86.95	030368		
US4		83.50	002131		
US10		83.50	002109		
US10A (US11)		86.95	002113		
US10B		86.95	017886		
US26		86.95	006052		
US26D		71.60	002125		
WTAB750 Wide Throw Steel - Full Mortise Heavy Weight Concealed Anti-Friction Bearing Three Knuckle		4-1/2" x 5" (114 x 127 mm)	LS	161.30	-
		USP	174.90	115754	
		US3	196.60	-	
		US10	161.30	065696	
		US10A (US11)	196.60	093406	
		US10B	196.60	076857	
		US26	196.60	092976	
		US26D	162.30	022959	
	4-1/2" x 6" (114 mm x 152 mm)	LS	162.05	-	3 24
		USP	175.65	063855	
US3		197.60	043920		
US10		162.05	045850		
US10A (US11)		197.60	090251		
US10B		197.60	086471		
US26		197.60	089046		
US26D		169.60	097881		
4-1/2" x 7" (114 mm x 178 mm)	LS	218.00	-	3 24	
	USP	236.50	-		
	US3	266.10	-		
	US10	218.00	071083		
	US10A (US11)	266.10	100602		
	US10B	266.10	008253		
	US26	266.10	-		
	US26D	228.30	067308		
4-1/2" x 8" (114 mm x 203 mm)	LS	223.30	-	3 24	
	USP	241.95	130101		
	US3	272.20	116852		
	US10	223.30	-		
	US10A (US11)	272.20	-		
	US10B	272.20	106119		
	US26	272.20	-		
	US26D	233.65	003472		



1. Items with the price in **bold and red** are Quick Ship items and ship in 24 hours.
Please use stock number when ordering. 2. U/M is each unless otherwise noted.



Commercial Hinges



Description	Finish	2018 List	Stock No.	Box Qty.	Case Qty.
WTAB750 - Cont. Continued	5" x 6" (127 mm x 152 mm)	LS	217.75	-	3 24
		USP	235.90	082907	
		US3	264.10	010751	
		US10	217.75	021555	
		US10A (US11)	264.10	010915	
		US10B	264.10	099390	
		US26	264.10	-	
		US26D	225.80	001905	
5" x 7" (127 mm x 178 mm)	LS	221.05	-	3 24	
	USP	239.40	082905		
	US3	267.90	055700		
	US10	221.05	107846		
	US10A (US11)	267.90	-		
	US10B	267.90	141294		
	US26	267.90	-		
	US26D	229.10	045843		
5" x 8" (127 mm x 203 mm)	LS	230.60	-	3 24	
	USP	249.75	069579		
	US3	279.75	-		
	US10	230.60	-		
	US10A (US11)	279.75	109588		
	US10B	279.75	000774		
	US26	279.75	-		
	US26D	238.90	020835		
IHTAB750 MADE IN USA Steel - Full Mortise Concealed Anti-Friction Bearing	4-1/2" x 4-1/2" (114 mm x 114 mm)	LS	115.25	082386	3 24
		USP	136.10	081222	
		US26D	120.70	081223	
Heavy Weight Institutional or Prison; Welded Hospital Tip Three Knuckle TORX Screws - add \$12 to list	5" x 4-1/2" (127 x 114 mm)	LS	126.10	-	3 24
		USP	144.65	005416	
		US26D	132.30	089127	
AB751 Steel - Half Mortise Concealed Anti-Friction Bearing Heavy Weight	4-1/2" (114 mm)	USP	203.70	093988	3 36
		US10	214.15	-	
		US10A (US11)	287.55	120634	
		US10B	287.55	120635	
		US26D	250.05	002195	
5" (127 mm)	USP	259.90	070348	3 24	
	US10	272.95	-		
	US10A (US11)	355.50	-		
	US10B	355.50	-		
	US26D	309.25	016683		
AB752 Steel - Full Surface Concealed Anti-Friction Bearing Heavy Weight Three Knuckle	4-1/2" (114 mm)	USP	333.70	020969	3 36
		US10	389.75	-	
		US10A (US11)	456.35	-	
		US10B	456.35	136055	
		US26D	408.85	018283	
5" (127 mm)	USP	403.10	110383	3 24	
	US10	423.30	-		
	US10A (US11)	564.80	-		
	US10B	564.80	-		
	US26D	491.15	073873		





Description	Finish	2018 List	Stock No.	Box Qty.	Case Qty.		
AB753 Steel Half Surface Concealed Anti-Friction Bearing Three Knuckle Heavy Weight	4-1/2" (114 mm)	USP	141.65	002220	3	36	
		US10	163.40	126783			
		US10A (US11)	189.30	-			
		US10B	189.30	119027			
		US26D	153.85	094539			
		5" (127 mm)	USP	160.95	020673	3	24
		US10	186.00	-			
		US10A (US11)	214.45	-			
		US10B	214.45	074015			
		US26D	174.15	006188			
800 Brass or Stainless Full Mortise Standard Weight Plain Bearing Three Knuckle	3-1/2" x 3-1/2" (89 mm x 89 mm)	US3	86.50	002239	2	100	
		US10	67.75	125628			
		US10B	86.50	002236			
		US26	86.50	018814			
		US26D	77.45	017876			
		US32D	81.70	002240			
		4" x 4" (102 mm x 102 mm)	US3	83.55	002247	3	48
			US10	64.75	131214		
			US10B	83.35	013109		
			US26	83.35	032743		
			US26D	76.85	002246		
			US32D	88.60	002249		
		4-1/2" x 4" (114 mm x 102 mm)	US3	74.80	024497	3	48
			US10	63.85	-		
			US10B	74.80	023835		
			US26	74.80	-		
			US26D	67.55	032689		
			US32D	76.45	071727		
		4-1/2" x 4-1/2" (114 mm x 114 mm)	US3	74.80	002279	3	48
			US10	63.85	005530		
			US10B	74.80	002268		
			US26	74.80	002271		
			US26D	67.55	002274		
			US32D	76.45	002284		
	5" x 4" (127 mm x 102 mm)	US3	118.05	-	3	24	
		US10	94.25	-			
		US10B	118.05	061899			
		US26	118.05	-			
		US26D	104.90	092717			
		US32D	119.45	097552			
	5" x 4-1/2" (127 x 114 mm)	US3	118.05	019910	3	24	
		US10	94.25	-			
		US10B	118.05	067358			
		US26	118.05	-			
		US26D	104.90	107933			
		US32D	119.45	006935			
	5" x 5" (127 mm x 127 mm)	US3	118.05	016629	3	24	
		US10	94.25	-			
		US10B	118.05	126436			
		US26	118.05	103826			
		US26D	104.90	085018			
		US32D	119.45	019417			

1. Items with the price in **bold and red** are Quick Ship items and ship in 24 hours.
Please use stock number when ordering. 2. U/M is each unless otherwise noted.



Commercial Hinges



Description	Finish	2018 List	Stock No.	Box Qty.	Case Qty.	
AB800 Brass or stainless Full Mortise Standard Weight Concealed Anti-Friction Bearing Three Knuckle	3-1/2" x 3-1/2" (89 mm x 89 mm)	US3SC	POA	-	2	100
		US3	114.25	053131		
		US10	99.15	-		
		US10B	114.25	026128		
		US26	114.25	062177		
		US26D	94.40	041155		
		US32D	128.45	038024		
4" x 4" (102 mm x 102 mm)	US3SC	POA	-	3	48	
	US3	114.25	033633			
	US10	99.15	002339			
	US10B	114.25	002340			
	US26	114.25	002345			
	US26D	94.40	002347			
	US32D	128.45	002349			
4-1/2" x 4" (114 mm x 102 mm)	US3SC	POA	-	3	48	
	US3	85.70	002371			
	US10	71.25	002353			
	US10B	85.70	002354			
	US26	85.70	031110			
	US26D	72.80	002366			
	US32D	73.90	002379			
4-1/2" x 4-1/2" (114 mm x 114 mm)	US3SC	POA	-	3	48	
	US3	85.70	002430			
	US10	71.25	002390			
	US10B	85.70	002397			
	US26	85.70	095263			
	US26D	72.80	002416			
	US32D	73.90	002441			
5" x 4" (127 mm x 102 mm)	US3SC	POA	-	3	24	
	US3	141.05	138239			
	US10	109.85	014350			
	US10B	141.05	053030			
	US26	141.05	-			
	US26D	112.40	041703			
	US32D	115.60	002477			
5" x 4-1/2" (127 mm x 114 mm)	US3SC	POA	-	3	24	
	US3	141.05	-			
	US10	109.85	129221			
	US10B	141.05	037911			
	US26	141.05	-			
	US26D	112.40	096274			
	US32D	115.60	002500			
5" x 5" (127 mm x 127 mm)	US3SC	POA	-	3	24	
	US3	141.05	032238			
	US10	109.85	129222			
	US10B	141.05	021424			
	US26	141.05	065762			
	US26D	112.40	009938			
	US32D	115.60	095163			





Description	Finish	2018 List	Stock No.	Box Qty.	Case Qty.
WTAB800					
Wide Throw	4-1/2" x 5" (114 mm x 127 mm)	LS	163.55	-	3 24
Brass or Stainless		US3	228.60	051926	
Full Mortise		US10	163.55	074633	
Standard Weight		US10B	216.00	002306	
Concealed Anti-Friction Bearing		US26	216.00	-	
Three Knuckle		US26D	185.50	081811	
		US32	228.60	-	
		US32D	228.60	022382	
<hr/>					
	4-1/2" x 6" (114 mm x 152 mm)	LS	179.20	-	3 24
		US3	233.40	016264	
		US10	179.20	144616	
		US10B	233.40	047131	
		US26	233.40	114753	
		US26D	185.05	015281	
		US32	245.70	065657	
		US32D	245.70	078170	
<hr/>					
	4-1/2" x 7" (114 mm x 178 mm)	LS	188.25	-	3 24
		US3	245.20	121348	
		US10	188.25	-	
		US10B	245.20	021385	
		US26	245.20	-	
		US26D	222.05	121347	
		US32	258.05	-	
		US32D	258.05	017222	
<hr/>					
	4-1/2" x 8" (114 mm x 203 mm)	LS	190.55	-	3 24
		US3	245.45	117869	
		US10	190.55	-	
		US10B	245.45	115804	
		US26	245.45	143234	
		US26D	214.20	037781	
		US32	257.80	143233	
		US32D	257.80	113887	
<hr/>					
	5" x 6" (127 mm x 152 mm)	LS	347.55	-	3 24
		US3	455.15	-	
		US10	347.55	-	
		US10B	455.15	043722	
		US26	455.15	-	
		US26D	402.20	122338	
		US32	483.10	-	
		US32D	483.10	045622	
<hr/>					
	5" x 7" (127 mm x 178 mm)	LS	364.90	-	3 24
		US3	478.05	-	
		US10	364.90	140083	
		US10B	478.05	-	
		US26	478.05	-	
		US26D	414.55	-	
		US32	506.55	140555	
		US32D	506.55	140540	

1. Items with the price in **bold and red** are Quick Ship items and ship in 24 hours.
Please use stock number when ordering. 2. U/M is each unless otherwise noted.



Commercial Hinges



Description	Finish	2018 List	Stock No.	Box Qty.	Case Qty.
WTAB800 - Cont. Continued	5" x 8" (127 mm x 203 mm)	LS	402.95	-	3 24
		US3	497.55	-	
		US10	402.95	-	
		US10B	497.55	-	
		US26	497.55	-	
		US26D	434.70	-	
		US32	519.40	-	
	US32D	519.40	088291		
AB801 Brass or Stainless Half Mortise Standard Weight Concealed Anti-Friction Bearing Three Knuckle	4-1/2" (114 mm)	US26D	268.30	002551	3 48
		US32D	321.90	002553	
	5" (127 mm)	US26D	361.70	-	3 24
		US32D	420.65	114328	
AB802 Brass or Stainless Full Surface Standard Weight Concealed Anti-Friction Bearing Three Knuckle	4-1/2" (114 mm)	US26D	268.30	005532	3 48
		US32D	321.90	002558	
	5" (127 mm)	US26D	361.70	141526	3 24
		US32D	420.65	046137	
AB803 Brass or Stainless Half Surface Standard Weight Concealed Anti-Friction Bearing Three Knuckle	4-1/2" (114 mm)	US26D	268.30	005101	3 48
		US32D	321.90	014229	
	5" (127 mm)	US26D	361.70	060966	3 24
		US32D	420.65	025450	
AB850 Brass or Stainless Full Mortise Heavy Weight Concealed Anti-Friction Bearing Three Knuckle	4-1/2" x 4" (114 mm x 102 mm)	US3SC	POA	-	3 24
		US3	132.30	046338	
		US10	122.05	045488	
		US10B	132.30	001714	
		US26	132.30	-	
		US26D	104.80	002599	
		US32D	106.90	093039	
	4-1/2" x 4-1/2" (114 mm x 114 mm)	US3SC	POA	-	3 24
		US3	132.30	098711	
		US10	122.05	002615	
		US10B	132.30	094812	
		US26	132.30	002631	
		US26D	104.80	002638	
		US32D	106.90	002654	
5" x 4" (127 mm x 102 mm)	US3SC	POA	-	3 24	
	US3	168.85	-		
	US10	142.15	014351		
	US10B	168.85	100720		
	US26	168.85	081818		
	US26D	142.20	057422		
	US32D	144.75	002683		





Description	Finish	2018 List	Stock No.	Box Qty.	Case Qty.
AB850 - Cont. Continued	5" x 4-1/2" (127 mm x 114 mm)	US3SC	POA	-	3 24
		US3	168.85	091548	
		US10	142.15	008334	
		US10B	168.85	002691	
		US26	168.85	002700	
		US26D	142.20	002704	
		US32D	144.75	002721	
5" x 5" (127 mm x 127 mm)	US3SC	POA	-	3	24
	US3	168.85	032239		
	US10	142.15	033916		
	US10B	168.85	095231		
	US26	168.85	112488		
	US26D	142.20	002743		
	US32D	144.75	024905		
6" x 4-1/2" (152 mm x 114 mm)	US3	393.00	124252	3	24
	US10	255.30	025004		
	US10B	393.00	043245		
	US26	393.00	-		
	US26D	277.10	074191		
	US32D	374.85	002758		
6" x 5" (152 mm x 127 mm)	US3	393.00	-	3	24
	US10	255.30	-		
	US10B	393.00	034166		
	US26	393.00	-		
	US26D	277.10	022892		
	US32D	374.85	001925		
6" x 6" (152 mm x 152 mm)	US26D	277.10	026100	3	24
	US32D	374.85	002771		
WTAB850 Wide Throw Brass or Stainless Full Mortise Heavy Weight Concealed Anti-Friction Bearing Three Knuckle	4-1/2" x 5" (114 mm x 127 mm)	LS	244.95	-	3 24
		US3	310.35	119032	
		US10	244.95	089830	
		US10B	310.35	041693	
		US26	310.35	-	
		US26D	269.10	014202	
		US32	332.85	-	
	US32D	332.85	073360		
4-1/2" x 6" (114 mm x 152 mm)	LS	253.40	-	3	24
	US3	319.45	119033		
	US10	253.40	-		
	US10B	319.45	030057		
	US26	319.45	-		
	US26D	287.15	004168		
	US32	341.80	-		
	US32D	341.80	024258		
4-1/2" x 7" (114 mm x 178 mm)	LS	280.70	-	3	24
	US3	337.35	146198		
	US10	280.70	-		
	US10B	337.35	062830		
	US26	337.35	-		
	US26D	323.90	147246		
	US32	364.35	-		
	US32D	364.35	017221		



1. Items with the price in **bold and red** are Quick Ship items and ship in 24 hours.
Please use stock number when ordering. 2. U/M is each unless otherwise noted.



Commercial Hinges



Description	Finish	2018 List	Stock No.	Box Qty.	Case Qty.
WTAB850 - Cont. Continued	4-1/2" x 8" (114 mm x 203 mm)	LS	310.40	-	3 24
		US3	364.35	-	
		US10	310.40	126847	
		US10B	364.35	113225	
		US26	364.35	-	
		US26D	337.35	025417	
		US32	394.05	-	
	US32D	394.05	035073		
5" x 6" (127 mm x 152 mm)	LS	323.90	-	3 24	
	US3	377.85	095930		
	US10	323.90	-		
	US10B	377.85	011469		
	US26	377.85	-		
	US26D	348.20	-		
	US32	421.05	099689		
	US32D	421.05	045352		
5" x 7" (127 mm x 178 mm)	LS	323.90	-	3 24	
	US3	391.40	-		
	US10	323.90	-		
	US10B	391.40	104539		
	US26	391.40	-		
	US26D	350.80	-		
	US32	426.45	-		
	US32D	426.45	081554		
5" x 8" (127 mm x 203 mm)	LS	348.20	-	3 24	
	US3	407.55	106302		
	US10	348.20	-		
	US10B	407.55	019906		
	US26	407.55	-		
	US26D	364.35	-		
	US32	445.30	-		
	US32D	445.30	015599		
IHTAB850 MADE IN USA Stainless - Full Mortise Heavy Weight Concealed Anti-Friction Bearing Institutional or Prison Welded Hospital Tip Three Knuckle TORX Screws - add \$16.50 to list	4-1/2" x 4-1/2" (114 x 114 mm)	US32D	129.10	079272	3 24
	5" x 4-1/2" (127 mm x 114 mm)	US32D	143.65	095240	3 24
AB851 Brass or Stainless Half Mortise Heavy Weight Concealed Anti-Friction Bearing	4-1/2" (114 mm)	US26D	322.75	085147	3 36
		US32D	461.00	002796	
	5" (127 mm)	US26D	377.80	054599	3 24
		US32D	539.30	031247	
	6" (152 mm)	US26D	520.15	-	3 12
	US32D	676.90	-		





Description	Finish	2018 List	Stock No.	Box Qty.	Case Qty.
AB852 Brass or Stainless Full Surface Heavy Weight Concealed Anti-Friction Bearing	4-1/2" (114 mm)	US26D 313.00	025134	3	36
		US32D 446.85	002809		
	5" (127 mm)	US26D 366.95	072313	3	24
		US32D 524.45	069984		
	6" (152 mm)	US26D 520.75	110834	3	12
		US32D 676.90	076455		
AB853 Brass or Stainless Half Surface Heavy Weight Concealed Anti-Friction Bearing	4-1/2" (114 mm)	US26D 351.95	054923	3	36
		US32D 460.95	098010		
	5" (127 mm)	US26D 411.80	072526	3	24
		US32D 539.80	014097		
	6" (152 mm)	US26D 520.45	022454	3	12
		US32D 676.45	074529		
920 Steel Full Mortise Standard Weight Plain Bearing Two Knuckle Specify Handing	4-1/2" x 4" (114 mm x 102 mm)	LH USP 11.75	002850	3	48
		RH USP 11.75	002851		
		LH US10 16.25	002828		
		RH US10 16.25	002830		
		LH US10A (US11) 31.50	074625		
		RH US10A (US11) 31.50	002833		
		LH US10B 31.50	073260		
		RH US10B 31.50	073258		
		LH US26D 22.55	002836		
		RH US26D 22.55	002837		
	4-1/2" x 4-1/2" (114 mm x 114 mm)	LH USP 13.00	002888	3	48
		RH USP 13.00	002889		
		LH US10 16.25	002852		
		RH US10 16.25	002853		
		LH US10A (US11) 31.50	002854		
		RH US10A (US11) 31.50	002856		
		LHUS10B 31.50	002858		
		RH US10B 31.50	002859		
		LH US26D 23.00	002867		
		RH US26D 23.00	002869		

1. Items with the price in **bold and red** are Quick Ship items and ship in 24 hours.
Please use stock number when ordering. 2. U/M is each unless otherwise noted.



Commercial Hinges



Description	Finish	2018 List	Stock No.	Box Qty.	Case Qty.	
AB920 Steel Full Mortise Standard Weight Concealed Anti-Friction Bearing Two Knuckle Specify Handing	4-1/2" x 4" (114 mm x 102 mm)	LH USP	32.45	002914	3 48	
		RH USP	32.45	002915		
		LH US10	28.20	002890		
		RH US10	28.20	002892		
		LH US10A (US11)	44.10	002894		
		RH US10A (US11)	44.10	002895		
		LHUS10B	44.10	017887		
		RH US10B	44.10	017888		
		LH US26D	36.85	002900		
		RH US26D	36.85	002901		
	Available with ETW	4-1/2" x 4-1/2" (114 mm x 114 mm)	LH USP	32.45		002958
		RH USP	32.45	002963		
		LH US10	28.20	002918		
		RH US10	28.20	002919		
		LH US10A (US11)	44.10	002921		
	RH US10A (US11)	44.10	002924			
	LHUS10B	44.10	002926			
	RH US10B	44.10	002927			
	LH US26D	36.85	002936			
	RH US26D	36.85	002937			
AB923 Brass or Stainless Full Mortise Standard Weight Concealed Anti-Friction Bearing Two Knuckle Specify Handing	4-1/2" x 4" (114 mm x 102 mm)	LH US3	92.15	037373	3 48	
		RH US3	92.15	037374		
		LH US4	72.20	017474		
		RH US4	72.20	-		
		LH US10	72.20	053643		
		RH US10	72.20	053640		
		LH US10B	92.15	064730		
		RH US10B	92.15	064731		
		LH US26	92.15	048404		
		RH US26	92.15	048405		
	Available with ETW	LH US26D	81.90	057100		
		RH US26D	81.90	057102		
		LH US32	107.35	039538		
		RH US32	107.35	085667		
		LH US32D	107.35	040225		
		RH US32D	107.35	031930		
		4-1/2" x 4-1/2" (114 mm x 114 mm)	LH US3	92.15		048410
		RH US3	92.15	048411		
		LH US4	72.20	063272		
		RH US4	72.20	050767		
		LH US10	72.20	041925		
	RH US10	72.20	041924			
	LH US10B	92.15	027478			
	RH US10B	92.15	027479			
	LH US26	92.15	020180			
	RH US26	92.15	035847			
	LH US26D	81.90	039586			
	RH US26D	81.90	027480			
	LH US32	107.35	030201			
	RH US32	107.35	030202			
	LH US32D	107.35	021425			
	RH US32D	107.35	021427			



Description	Finish	2018 List	Stock No.	Box Qty.	Case Qty.	
AB930	4-1/2" x 4-1/2"	LH USP	77.40	025731	3	24
Steel	(114 mm x 114 mm)	RH USP	77.40	025733		
Full Mortise		LH US10	88.65	077404		
Heavy Weight		RH US10	88.65	077403		
Two Knuckle		LH US10A (US11)	105.70	041175		
Concealed Anti-Friction Bearing		RH US10A (US11)	105.70	042218		
Specify Handing		LH US10B	105.70	014739		
Available with ETW		RH US10B	105.70	014740		
		LH US26D	84.35	026754		
		RH US26D	84.35	026705		



AB933	4-1/2" x 4-1/2"	LH US3	137.60	029686	3	24
Brass or Stainless	(114 mm x 114 mm)	RH US3	137.60	045591		
Full Mortise		LH US4	112.55	123743		
Heavy Weight		RH US4	112.55	106820		
Two Knuckle		LH US10	112.55	-		
Concealed Anti-Friction Bearing		RH US10	112.55	-		
Specify Handing		LH US10B	121.60	027506		
Available with ETW		RH US10B	121.60	067676		
		LH US26	137.60	036291		
		RH US26	137.60	079694		
		LH US26D	121.40	054219		
		RH US26D	121.40	054119		
		LH US32	160.60	-		
		RH US32	160.60	-		
		LH US32D	160.60	043454		
		RH US32D	160.60	043455		



IHTHB953	4-1/2" x 4-1/2"	US32D	128.45	051344	3	24
Stainless Steel	(114 mm x 114 mm)					
Full Mortise						
Heavy Weight						
Concealed Bearing						
Institutional or Prison						
Welded Hospital Tip						
Standard with RSS and Torx Screws						



990	3" x 4"	USP	171.45	079393	2	10
Steel	(76 mm x 102 mm)					
Detention						
Utility Hinge						
Full Surface						
Welded Tip						



992	3" x 4"	USP	367.00	079398	1	12
Steel	(76 mm x 102 mm)					
Detention						
Food Pass Through Hinge						
Full Surface With Stop						
Welded Tip						
Set of 2 hinges with 2 stops						

1. Items with the price in **bold and red** are Quick Ship items and ship in 24 hours.
Please use stock number when ordering. 2. U/M is each unless otherwise noted.



Commercial Hinges



Description	Finish	2018 List	Stock No.	Box Qty.	Case Qty.	
BB1109 Brass or Stainless Half Mortise Standard Weight Ball Bearing	4-1/2" (114 mm)	US10	145.85	004145	3	48
		US10B	179.65	085217		
		US26D	156.20	004149		
		US32D	207.90	004154		
	5" (127 mm)	US10	187.80	045318	3	24
	US10B	210.95	-			
	US26D	183.45	004165			
	US32D	248.85	004170			
1129 Steel Half Mortise Standard Weight Plain Bearing	4-1/2" (114 mm)	USP	27.20	004186	3	48
		US10	31.40	004175		
		US10A (US11)	46.65	007852		
		US10B	46.65	065372		
		US26D	35.60	004180		
BB1129 Steel Half Mortise Standard Weight Plain Bearing	4-1/2" (114 mm)	USP	70.25	004209	3	48
		US10	74.75	004188		
		US10A (US11)	104.65	004190		
		US10B	104.65	004193		
		US26D	82.65	004197		
	5" (127 mm)	USP	94.70	004223	3	24
		US10	110.00	004215		
		US10A (US11)	135.95	113352		
		US10B	135.95	015737		
		US26D	118.45	004218		
BB1138 Steel Half Mortise Heavy Weight Ball Bearing	4-1/2" (114 mm)	USP	129.45	004241	3	36
		US10	136.00	018079		
		US10A (US11)	193.80	-		
		US10B	193.80	022712		
		US26D	168.60	004235		
	5" (127 mm)	USP	165.70	004254	3	24
		US10	177.70	004245		
		US10A (US11)	213.80	007305		
		US10B	213.80	-		
		US26D	180.20	004250		
6" x 1-3/4" (152 mm x 45 mm)	USP	508.10	040951	3	12	
	US10	533.50	-			
	US10A (US11)	721.25	-			
	US10B	721.25	100343			
	US26D	627.20	016401			
1150 Stainless Steel Full Mortise Standard Weight Spring Hinge	4-1/2" x 4" (114 mm x 102 mm)	US32	150.05	047217	3	48
		US32D	129.00	023378		
		US10Z	169.05	177119	3	48
	4-1/2" x 4-1/2" (114 mm x 114 mm)	US32	150.05	028073	3	48
		US32D	129.00	023379		
	US10Z	169.05	177118	3	48	





Description	Finish	2018 List	Stock No.	Box Qty.	Case Qty.	
BB1160 Steel Full Mortise Heavy Weight Ball Bearing Anchor Hinge Specify Handing NRP Standard	5" x 4-1/2" (127 mm x 114 mm)	LH USP	221.40	004227	1	10
		RH USP	221.40	004228		
		LH US10	273.40	050338		
		RH US10	273.40	050326		
		LH US10A (US11)	335.15	006254		
		RH US10A (US11)	335.15	006654		
		LH US10B	335.15	-		
		RH US10B	335.15	-		
		LH US26D	268.45	075799		
		RH US26D	268.45	075798		
BB1162 Steel Full Mortise Heavy Weight Ball Bearing Anchor Hinge Specify Handing NRP Standard	5" x 4-1/2" (127 mm x 114 mm)	LH USP	221.40	064527	1	10
		RH USP	221.40	064368		
		LH US10	273.40	007231		
		RH US10	273.40	007230		
		LH US10A (US11)	335.15	052985		
		RH US10A (US11)	335.15	052978		
		LH US10B	335.15	091567		
		RH US10B	335.15	091568		
		LH US26D	201.35	062572		
		RH US26D	201.35	062573		
BB1163 Steel Half Surface Heavy Weight Ball Bearing	4-1/2" (114 mm)	LS	136.15	042617	3	36
		USP	118.05	004316		
		US3	157.75	023227		
		US10	136.15	004299		
		US10A (US11)	157.75	004301		
		US10B	157.75	018544		
		US26	157.75	017557		
		US26D	128.20	004306		
	5" (127 mm)	LS	155.00	-	3	24
		USP	134.15	004328		
		US3	178.70	035797		
		US10	155.00	034771		
		US10A (US11)	178.70	082389		
		US10B	178.70	043379		
		US26	178.70	113652		
	US26D	145.15	004321			
6" x 1-3/4" (152 mm x 45 mm)	USP	493.55	004335	3	12	
	US10	519.45	042171			
	US10A (US11)	624.15	-			
	US10B	624.15	139351			
	US26D	542.70	004332			
BB1165 Steel Full Mortise Heavy Weight Ball Bearing Anchor Hinge Specify Handing NRP Standard	5" x 4-1/2" (127 mm x 114 mm)	LH USP	221.40	023326	1	10
		RH USP	221.40	077148		
		LH US10	273.40	049205		
		RH US10	273.40	049206		
		LH US10A (US11)	335.15	000822		
		RH US10A (US11)	335.15	000823		
		LH US10B	335.15	024967		
		RH US10B	335.15	024968		
		LH US26D	268.45	065414		
		RH US26D	268.45	065415		

1. Items with the price in **bold and red** are Quick Ship items and ship in 24 hours.
Please use stock number when ordering. 2. U/M is each unless otherwise noted.



Commercial Hinges



Description		Finish	2018 List	Stock No.	Box Qty.	Case Qty.
BB1166	5" x 4-1/2"	LH USP	228.75	062019	1	10
Steel	(127 mm x 114 mm)	RH USP	228.75	062022		
Full Mortise		LH US10	282.60	105791		
Heavy Weight		RH US10	282.60	029041		
Ball Bearing		LH US10A (US11)	346.35	112720		
Anchor Hinge		RH US10A (US11)	346.35	112721		
Beveled Edge Doors		LH US10B	346.35	078375		
Specify Handing		RH US10B	346.35	090234		
NRP Standard		LH US26D	277.45	062321		
		RH US26D	277.45	062320		
BB1167	5" x 4-1/2"	LH USP	229.75	065571	1	10
Steel	(127 mm x 114 mm)	RH USP	229.75	065572		
Full Mortise		LH US10	283.85	001853		
Heavy Weight		RH US10	283.85	001854		
Ball Bearing		LH US10A (US11)	347.95	014464		
Anchor Hinge		RH US10A (US11)	347.95	014474		
Beveled Edge Doors		LH US10B	347.95	-		
Specify Handing		RH US10B	347.95	067685		
NRP Standard		LH US26D	278.70	070342		
		RH US26D	278.70	070341		





Description	Finish	2018 List	Stock No.	Box Qty.	Case Qty.
BB1168					
4-1/2" x 4"	LS	56.45	-	3	24
(114 mm x 102 mm)	USP	56.45	004540		
Steel	US3	67.00	004529		
Full Mortise	US10	56.45	004501		
Heavy Weight	US10A (US11)	67.00	004505		
Ball Bearing	US10B	67.00	004510		
	US15	67.00	084310		
	US26	67.00	004512		
	US26D	48.30	004517		
<hr/>					
4-1/2" x 4-1/2"	LS	56.45	004735	3	24
(114 mm x 114 mm)	USP	56.45	004744		
	US3	67.00	004671		
	US10	56.45	004547		
	US10A (US11)	67.00	004564		
	US10B	67.00	004585		
	US15	67.00	004592		
	US26	67.00	004601		
	US26D	48.30	004616		
<hr/>					
5" x 4"	LS	72.60	-	3	24
(127 mm x 102 mm)	USP	71.55	004794		
	US3	75.60	010504		
	US10	72.60	071777		
	US10A (US11)	75.60	004779		
	US10B	75.60	059153		
	US15	75.60	035760		
	US26	75.60	047535		
	US26D	62.25	004785		
<hr/>					
5" x 4-1/2"	LS	72.60	128700	3	24
(127 mm x 114 mm)	USP	71.55	004922		
	US3	75.60	004881		
	US10	72.60	004802		
	US10A (US11)	75.60	004813		
	US10B	75.60	004826		
	US15	75.60	004830		
	US26	75.60	004836		
	US26D	62.25	004850		

1. Items with the price in **bold and red** are Quick Ship items and ship in 24 hours.
 Please use stock number when ordering. 2. U/M is each unless otherwise noted.



Commercial Hinges



Description	Finish	2018 List	Stock No.	Box Qty.	Case Qty.	
BB1168 - Cont. Continued	5" x 5" (127 mm x 127 mm)	LS	72.60	-	3	24
		USP	71.55	005029		
		US3	75.60	004998		
		US10	72.60	004947		
		US10A (US11)	75.60	004956		
		US10B	75.60	004974		
		US15	75.60	022614		
		US26	75.60	004975		
		US26D	62.25	004981		
6" x 4-1/2" (152 mm x 114 mm)	LS	201.00	-	3	12	
	USP	194.50	005069			
	US3	247.85	005064			
	US10	201.00	035454			
	US10A (US11)	247.85	057799			
	US10B	247.95	068270			
	US15	247.85	033562			
	US26	247.95	005054			
	US26D	186.95	005057			
6" x 5" (152 mm x 127 mm)	USP	194.50	005102	3	12	
	US10	201.00	007229			
	US10A (US11)	247.85	020131			
	US10B	247.95	078457			
	US15	247.85	030967			
	US26D	186.95	005086			
6" x 6" (152 mm x 152 mm)	USP	194.50	005128	3	12	
	US10	201.00	030639			
	US10A (US11)	247.85	011627			
	US10B	247.95	065303			
	US15	247.85	016874			
	US26D	186.95	005113			
8" x 6" (203 mm x 152 mm)	USP	449.15	005145	3	12	
	US10	464.25	026481			
	US10A (US11)	572.45	047621			
	US10B	572.45	039286			
	US15	572.45	-			
	US26D	486.35	064840			
8" x 8" (203 mm x 203 mm)	USP	449.15	005158	3	12	
	US10	464.25	079431			
	US10A (US11)	572.45	005148			
	US10B	572.45	017141			
	US15	572.45	-			
	US26D	486.35	005151			





Description	Finish	2018 List	Stock No.	Box Qty.	Case Qty.
WTBB1168					
4-1/2" x 5" (114 mm x 127 mm)	LS	131.50	-	3	24
Wide Throw	USP	142.55	097956		
Steel	US3	160.35	004408		
Full Mortise	US10	131.50	012221		
Heavy Weight	US10A (US11)	160.35	004403		
Ball Bearing	US10B	160.35	007916		
	US26	160.35	015160		
	US26D	135.65	092594		
<hr/>					
4-1/2" x 6" (114 mm x 152 mm)	LS	132.10	-	3	24
	USP	143.30	004427		
	US3	161.20	004422		
	US10	132.10	099482		
	US10A (US11)	161.20	098167		
	US10B	161.20	004417		
	US26	161.20	004419		
	US26D	138.30	004420		
<hr/>					
4-1/2" x 7" (114 mm x 178 mm)	LS	174.45	-	3	24
	USP	189.25	040653		
	US3	212.80	015930		
	US10	174.45	003123		
	US10A (US11)	212.80	010920		
	US10B	212.80	058190		
	US26	212.80	050632		
	US26D	182.65	004435		
<hr/>					
4-1/2" x 8" (114 mm x 203 mm)	LS	182.05	-	3	24
	USP	197.45	004450		
	US3	222.10	078934		
	US10	182.05	045774		
	US10A (US11)	222.10	019132		
	US10B	222.10	062081		
	US26	222.10	066672		
	US26D	190.60	004446		
<hr/>					
5" x 6" (127 mm x 152 mm)	LS	177.70	-	3	24
	USP	192.50	008259		
	US3	215.55	004463		
	US10	177.70	020214		
	US10A (US11)	215.55	031197		
	US10B	215.55	019659		
	US26	215.55	004459		
	US26D	184.20	004461		

1. Items with the price in **bold and red** are Quick Ship items and ship in 24 hours.
Please use stock number when ordering. 2. U/M is each unless otherwise noted.



Commercial Hinges



Description	Finish	2018 List	Stock No.	Box Qty.	Case Qty.	
WTBB1168 - Cont. Continued	5" x 7" (127 mm x 203 mm)	LS	180.30	-	3 24	
		USP	195.40	066742		
		US3	218.55	067657		
		US10	180.30	023928		
		US10A (US11)	218.55	020805		
		US10B	218.55	073756		
		US26	218.55	143181		
		US26D	186.90	004475		
		5" x 8" (127 mm x 203 mm)	LS	188.05	-	3 24
		USP	203.80	004495		
	US3	228.15	008357			
	US10	188.05	034739			
	US10A (US11)	228.15	015855			
	US10B	228.15	026651			
	US26	228.15	057245			
	US26D	194.90	098271			
1173 Steel Half Surface Standard Weight Plain Bearing	3-1/2" (89 mm)	USP	38.90	005304	3 48	
		US10	43.35	005292		
		US10A (US11)	51.70	005293		
		US10B	51.70	024439		
		US26D	45.50	005295		
	4" (102 mm)	USP	59.55	005319	3 48	
		US10	62.65	005306		
		US10A (US11)	73.90	046712		
		US10B	73.90	044390		
		US26D	64.45	005309		
4-1/2" (114 mm)	USP	40.05	005337	3 48		
	US10	42.90	005321			
	US10A (US11)	58.90	005323			
	US10B	58.90	001848			
	US26D	45.25	005326			
	BB1173 Steel Half Surface Standard Weight Ball Bearing	4" (102 mm)	USP	75.95	005356	3 48
		US10	91.10	005349		
		US10A (US11)	114.35	001845		
		US10B	114.35	091863		
		US26D	99.85	005351		
4-1/2" (114 mm)		USP	61.20	005389	3 48	
	US10	68.40	005358			
	US10A (US11)	95.35	005360			
	US10B	95.35	005364			
	US26D	71.70	005367			
5" (127 mm)	USP	86.50	005410	3 36		
	US10	105.75	005395			
	US10A (US11)	130.65	005397			
	US10B	130.65	015735			
	US26D	97.35	005401			





Description	Finish	2018 List	Stock No.	Box Qty.	Case Qty.	
BB1190 5" x 4-1/2" (127 mm x 114 mm) Brass or Stainless Full Mortise Heavy Weight Ball Bearing Anchor Hinge Specify Handing	LH US10	369.30	004485	1	10	
	RH US10	369.30	004484			
	LH US10B	441.50	063136			
	RH US10B	441.50	073977			
	LH US26D	414.65	065999			
	RH US26D	414.65	066000			
	LH US32D	397.00	087614			
	RH US32D	397.00	087615			
1191 3" x 3" (76 mm x 76 mm) Brass or Stainless Full Mortise Standard Weight Plain Bearing Specify if all wood screws are required.	US3	174.65	005484	2	100	
	US4	137.00	005496			
	US10	137.00	065549			
	US10B	174.65	005475			
	US15	174.65	005478			
	US26	174.65	005479			
	US26D	154.75	005481			
	US32	194.25	005490			
	US32D	192.05	005491			
	3-1/2" x 3-1/2" (89 mm x 89 mm)	US3	72.10	006934	2	100
		US4	56.45	006952		
		US10	56.45	006911		
		US10B	72.10	006913		
US15		72.10	006920			
US26		72.10	006923			
US26D		64.55	006929			
US32		72.25	006943			
4" x 3-1/2" (102 mm x 89 mm)	US3	90.15	097274	3	48	
	US4	68.85	005502			
	US10	68.85	121560			
	US10B	90.15	069063			
	US15	90.15	035011			
	US26	90.15	011778			
	US26D	78.60	029852			
	US32	88.75	132157			
4" x 4" (102 mm x 102 mm)	US3	69.40	005535	3	48	
	US4	53.95	005562			
	US10	53.95	005503			
	US10B	69.40	005508			
	US15	69.40	052318			
	US26	69.40	005522			
	US26D	64.05	005528			
	US32	73.80	005549			
US32D	65.85	005552				

1. Items with the price in **bold and red** are Quick Ship items and ship in 24 hours.
Please use stock number when ordering. 2. U/M is each unless otherwise noted.



Commercial Hinges



Description	Finish	2018 List	Stock No.	Box Qty.	Case Qty.	
1191 - Cont. Continued	4-1/2" x 4" (114 mm x 102 mm)	US3	70.50	005597	3	48
		US4	55.50	005620		
		US10	55.50	052272		
		US10B	70.50	005582		
		US15	70.50	005586		
		US26	70.50	005590		
		US26D	58.90	005592		
		US32	71.00	005611		
		US32D	66.00	005614		
4-1/2" x 4-1/2" (114 mm x 114 mm)		US3	70.50	005690	3	48
		US4	55.50	005724		
		US10	55.50	005629		
		US10B	70.50	005640		
		US15	70.50	005652		
		US26	70.50	005664		
		US26D	58.90	005673		
		US32	71.00	005709		
		US32D	66.00	005713		
5" x 4" (127 mm x 102 mm)		US3	98.40	005752	3	24
		US4	78.55	110512		
		US10	78.55	-		
		US10B	98.40	012964		
		US15	98.40	047207		
		US26	98.40	043361		
		US26D	87.40	033877		
		US32	109.45	046989		
		US32D	99.60	005755		
5" x 4-1/2" (127 mm x 114 mm)		US3	98.40	005771	3	24
		US4	78.55	005783		
		US10	78.55	105329		
		US10B	98.40	005763		
		US15	98.40	032825		
		US26	98.40	128711		
		US26D	87.40	005768		
		US32	109.45	125488		
		US32D	99.60	005779		
5" x 5" (127 mm x 127 mm)		US3	98.40	005803	3	24
		US4	78.55	027281		
		US10	78.55	128170		
		US10B	98.40	005791		
		US15	98.40	030280		
		US26	98.40	005799		
		US26D	87.40	005800		
		US32	109.45	009578		
		US32D	99.60	005815		



Description	Finish	2018 List	Stock No.	Box Qty.	Case Qty.	
BB1191 Brass or Stainless Full Mortise Standard Weight Ball Bearing Specify if all wood screws are required.	3-1/2" x 3-1/2" (89 mm x 89 mm)	US3	85.55	007012	2	100
		US4	79.70	007026		
		US10	79.70	006997		
		US10B	85.55	007000		
		US15	85.55	039663		
		US26	85.55	007006		
		US26D	83.75	007008		
		US32	118.35	007020		
		US32D	104.60	007021		
	4" x 3-1/2" (102 mm x 89 mm)	US3	129.55	080659	3	48
US4		99.35	-			
US10		99.35	-			
US10B		129.55	091160			
US15		129.55	095215			
US26		129.55	-			
US26D		124.95	072201			
US32		156.65	085839			
4" x 4" (102 mm x 102 mm)	US3	98.80	006246	3	48	
	US4	86.70	006269			
	US10	86.70	006221			
	US10B	98.80	006225			
	US15	98.80	006232			
	US26	98.80	006235			
	US26D	92.75	006240			
	US32	116.95	006261			
4-1/2" x 4" (114 mm x 102 mm)	US3	84.20	006321	3	48	
	US4	64.80	006343			
	US10	64.80	006286			
	US10B	84.20	006289			
	US15	84.20	006302			
	US26	84.20	006306			
	US26D	65.65	006311			
	US32	78.65	006332			
US32D	66.65	006335				

1. Items with the price in **bold and red** are Quick Ship items and ship in 24 hours.
Please use stock number when ordering. 2. U/M is each unless otherwise noted.



Commercial Hinges



Description	Finish	2018 List	Stock No.	Box Qty.	Case Qty.	
BB1191 - Cont. Continued	4-1/2" x 4-1/2" (114 mm x 114 mm)	US3	84.20	006489	3	48
		US4	64.80	006562		
		US10	64.80	006373		
		US10B	84.20	006393		
		US15	84.20	006426		
		US26	84.20	006446		
		US26D	65.65	006462		
		US32	78.65	006528		
		US32D	66.65	006537		
5" x 4" (127 mm x 102 mm)		US3	115.15	006630	3	24
		US4	89.70	069057		
		US10	89.70	020761		
		US10B	115.15	006621		
		US15	115.15	043259		
		US26	115.15	006623		
		US26D	93.70	006627		
		US32	112.90	047877		
		US32D	95.80	006636		
5" x 4-1/2" (127 mm x 114 mm)		US3	115.15	006681	3	24
		US4	89.70	006707		
		US10	89.70	006644		
		US10B	115.15	006655		
		US15	115.15	006665		
		US26	115.15	065277		
		US26D	93.70	006672		
		US32	112.90	006693		
		US32D	95.80	006696		
5" x 5" (127 mm x 127 mm)		US3	115.15	006761	3	24
		US4	89.70	006791		
		US10	89.70	006727		
		US10B	115.15	006733		
		US15	115.15	068939		
		US26	115.15	006746		
		US26D	93.70	006752		
		US32	112.90	006779		
		US32D	95.80	006784		





Description	Finish	2018 List	Stock No.	Box Qty.	Case Qty.	
BB1191 - Cont. 2 Continued	6" x 4-1/2" (152 mm x 114 mm)	US3	360.45	006813	3	24
		US4	283.25	030956		
		US10	283.25	010566		
		US10B	360.45	007519		
		US15	360.45	-		
		US26	360.45	099318		
		US26D	324.15	006811		
		US32	394.00	084160		
		US32D	394.00	006817		
	6" x 5" (152 mm x 127 mm)	US3	360.45	006830	3	24
US4		283.25	081058			
US10		283.25	031360			
US10B		360.45	069067			
US15		360.45	117950			
US26		360.45	-			
US26D		324.15	019124			
US32		394.00	-			
US32D		394.00	006832			
6" x 6" (152 mm x 152 mm)		US3	360.45	006843	3	24
	US4	283.25	046772			
	US10	283.25	012558			
	US10B	360.45	006838			
	US15	360.45	070946			
	US26	360.45	147729			
	US26D	324.15	006842			
	US32	394.00	106911			
	US32D	394.00	006850			
	CB1191 Stainless Full Mortise Standard Weight Concealed Anti-Fiction Bearing	4" x 3-1/2" (102 mm x 89 mm)	US3SC	POA	-	3
4" x 4" (102 mm x 102 mm)		US3SC	POA	-		
4-1/2" x 4" (114 mm x 102 mm)		US3SC	POA	-		
4-1/2" x 4-1/2" (114 mm x 114 mm)		US3SC	POA	-		
5" x 4" (127 mm x 102 mm)		US3SC	POA	-		
5" x 4-1/2" (127 mm x 114 mm)		US3SC	POA	-		
5" x 5" (127 mm x 127 mm)		US3SC	POA	-		
		All other finishes	Price same as BB			



1. Items with the price in **bold and red** are Quick Ship items and ship in 24 hours.
Please use stock number when ordering. 2. U/M is each unless otherwise noted.



Commercial Hinges



Description	Finish	2018 List	Stock No.	Box Qty.	Case Qty.		
WTBB1191 Wide Throw Brass or Stainless Full Mortise Standard Weight Ball Bearing	3-1/2" x 5" (89 mm x 127 mm)	US3	154.10	067005	3	24	
		US4	119.80	026605			
		US10	119.80	121849			
		US10B	154.10	075305			
		US26	154.10	129251			
		US26D	135.20	118052			
		US32	185.20	000080			
		US32D	185.20	032663			
		3-1/2" x 6" (89 mm x 152 mm)	US3	154.75	040163	3	24
		US4	124.10	-			
	US10	124.10	-				
	US10B	154.75	113815				
	US26	154.75	-				
	US26D	139.45	130243				
	US32	192.20	138152				
	US32D	192.20	076662				
	4" x 5" (102 mm x 127 mm)	US3	193.45	010124	3	24	
		US4	152.30	037602			
		US10	152.30	086104			
		US10B	193.45	070966			
		US26	193.45	041818			
		US26D	170.20	038964			
		US32	207.85	-			
		US32D	207.85	075139			
	4" x 6" (102 mm x 152 mm)	US3	201.10	006119	3	24	
		US4	159.00	012392			
		US10	159.00	146501			
		US10B	201.10	006117			
		US26	201.10	096937			
		US26D	176.60	009831			
		US32	215.20	114550			
		US32D	215.20	006121			





Description	Finish	2018 List	Stock No.	Box Qty.	Case Qty.	
WTBB1191 - Cont. Continued	4" x 7" (102 mm x 178 mm)	US3	209.90	092349	3	24
		US4	167.30	089839		
		US10	167.30	-		
		US10B	209.90	039719		
		US26	209.90	069207		
		US26D	183.90	088865		
		US32	224.10	099920		
		US32D	224.10	048155		
4-1/2" x 5" (114 mm x 127 mm)	US3	172.80	094007	3	24	
	US4	130.80	101381			
	US10	130.80	046401			
	US10B	172.80	025650			
	US26	172.80	001393			
	US26D	148.35	092728			
	US32	182.70	121467			
	US32D	182.70	006144			
4-1/2" x 6" (114 mm x 152 mm)	US3	190.35	095253	3	24	
	US4	146.15	036949			
	US10	146.15	024066			
	US10B	190.35	006152			
	US26	190.35	020291			
	US26D	172.55	065373			
	US32	200.35	052335			
	US32D	200.35	092901			
4-1/2" x 7" (114 mm x 178 mm)	US3	185.20	080909	3	24	
	US4	149.85	041505			
	US10	149.85	-			
	US10B	185.20	024545			
	US26	185.20	049886			
	US26D	173.60	069011			
	US32	205.90	076444			
	US32D	205.90	099811			
4-1/2" x 8" (114 mm x 203 mm)	US3	200.30	072567	3	24	
	US4	155.30	116184			
	US10	155.30	137974			
	US10B	200.30	034770			
	US26	200.30	060370			
	US26D	174.75	008143			
	US32	210.40	-			
	US32D	210.40	098630			
5" x 6" (127 mm x 152 mm)	US3	371.15	006199	3	24	
	US4	283.50	067616			
	US10	283.50	028304			
	US10B	371.15	046882			
	US26	371.15	-			
	US26D	328.25	033730			
	US32	394.20	046097			
	US32D	394.20	040909			

1. Items with the price in **bold and red** are Quick Ship items and ship in 24 hours.
Please use stock number when ordering. 2. U/M is each unless otherwise noted.



Commercial Hinges



Description	Finish	2018 List	Stock No.	Box Qty.	Case Qty.
WTBB1191 - Cont. 2 Continued	5" x 7" (127 mm x 178 mm)	US3	390.05	067159	3 24
		US4	297.80	140565	
		US10	297.80	-	
		US10B	390.05	035145	
		US26	390.05	-	
		US26D	338.25	065278	
		US32	413.30	-	
	US32D	413.30	036859		
5" x 8" (127 mm x 203 mm)	US3	406.15	074194	3 24	
	US4	328.80	-		
	US10	328.80	038873		
	US10B	406.15	020027		
	US26	406.15	-		
	US26D	354.70	025454		
	US32	423.70	-		
	US32D	423.70	072530		
BB1192 Brass or Stainless Full Mortise Heavy Weight Ball Bearing Anchor Hinge Specify Handing	5" x 4-1/2" (127 mm x 114 mm)	LH US10	369.30	067133	1 10
		RH US10	369.30	067237	
		LH US10B	441.50	069389	
		RH US10B	441.50	069390	
		LH US26D	414.65	065079	
		RH US26D	414.65	065078	
		LH US32D	476.35	072244	
	RH US32D	476.35	072245		
BB1195 Brass or Stainless Full Mortise Heavy Weight Ball Bearing Anchor Hinge Specify Handing	5" x 4-1/2" (127 mm x 114 mm)	LH US10	369.30	037675	1 10
		RH US10	369.30	037676	
		LH US10B	441.50	079470	
		RH US10B	441.50	079471	
		LH US26D	414.65	065411	
		RH US26D	414.65	065412	
		LH US32D	476.35	062056	
	RH US32D	476.35	062057		
BB1196 Brass or Stainless Full Mortise Heavy Weight Ball Bearing Anchor Hinge for Beveled Edge Doors Specify Handing	5" x 4-1/2" (127 mm x 114 mm)	LH US10	369.30	085583	1 10
		RH US10	369.30	085582	
		LH US10B	441.50	065640	
		RH US10B	441.50	065641	
		LH US26D	414.65	073416	
		RH US26D	414.65	073415	
		LH US32D	476.35	063230	
	RH US32D	476.35	063231		
BB1197 Brass or Stainless Full Mortise Heavy Weight Ball Bearing Anchor Hinge Beveled Edge Doors Specify Handing	5" x 4-1/2" (127 mm x 114 mm)	LH US10	369.30	003650	1 10
		RH US10	369.30	088543	
		LH US10B	441.50	067686	
		RH US10B	441.50	067687	
		LH US26D	414.65	074907	
		RH US26D	414.65	074908	
		LH US32D	476.35	079648	
	RH US32D	476.35	079649		





Description	Finish	2018 List	Stock No.	Box Qty.	Case Qty.	
BB1199 Brass or Stainless Full Mortise Heavy Weight Ball Bearing	4-1/2" x 4" (114 mm x 102 mm)	US3	126.00	007369	3	24
		US4	116.25	007381		
		US10	116.25	019651		
		US10B	126.00	007354		
		US15	126.00	035768		
		US26	126.00	007362		
		US26D	99.80	007364		
		US32	101.85	007376		
		US32D	101.00	007378		
	4-1/2" x 4-1/2" (114 mm x 114 mm)	US3	126.00	007469	3	24
US4		116.25	007520			
US10		116.25	007390			
US10B		126.00	007406			
US15		126.00	007424			
US26		126.00	007437			
US26D		99.00	007445			
US32		101.85	007496			
5" x 4" (127 mm x 102 mm)	US3	160.85	007564	3	24	
	US4	135.35	069122			
	US10	135.35	064950			
	US10B	160.85	007557			
	US15	160.85	087838			
	US26	160.85	091928			
	US26D	135.45	007561			
	US32	137.85	138846			
5" x 4-1/2" (127 mm x 114 mm)	US3	160.85	007619	3	24	
	US4	135.35	007651			
	US10	135.35	007576			
	US10B	160.85	007585			
	US15	160.85	065583			
	US26	160.85	007601			
	US26D	135.45	007607			
	US32	137.85	007634			
5" x 5" (127 mm x 127 mm)	US3	160.85	007717	3	24	
	US4	135.35	007752			
	US10	135.35	007678			
	US10B	160.85	007689			
	US15	160.85	040362			
	US26	160.85	007703			
	US26D	135.45	007707			
	US32	137.85	007738			
	US32D	137.85	007742			

1. Items with the price in **bold and red** are Quick Ship items and ship in 24 hours.
Please use stock number when ordering. 2. U/M is each unless otherwise noted.



Commercial Hinges



Description	Finish	2018 List	Stock No.	Box Qty.	Case Qty.	
BB1199 - Cont. Continued	6" x 4-1/2" (152 mm x 114 mm)	US3	374.30	011566	3	12
		US4	243.15	018196		
		US10	243.15	099882		
		US10B	374.30	094854		
		US15	374.30	031525		
		US26	374.30	-		
		US26D	263.90	007775		
		US32	357.00	058406		
		US32D	357.00	007783		
6" x 5" (152 mm x 127 mm)	US3	374.30	007803	3	12	
	US4	243.15	013028			
	US10	243.15	019745			
	US10B	374.30	007792			
	US15	374.30	055244			
	US26	374.30	-			
	US26D	263.90	007800			
	US32	357.00	048380			
	US32D	357.00	007807			
6" x 6" (152 mm x 152 mm)	US3	374.30	007827	3	12	
	US4	243.15	007838			
	US10	243.15	007816			
	US10B	374.30	007820			
	US15	374.30	040565			
	US26	374.30	116381			
	US26D	263.90	007825			
	US32	357.00	073209			
	US32D	357.00	007832			
8" x 6" (203 mm x 152 mm)	USP	598.40	054124	3	12	
	US3	849.25	017553			
	US10	628.20	071278			
	US10B	849.25	072364			
	US15	849.25	095022			
	US26D	738.60	003819			
	US32D	984.60	007853			
8" x 8" (203 mm x 203 mm)	USP	598.40	046441	3	12	
	US3	849.25	073590			
	US10	628.20	025171			
	US10B	849.25	007857			
	US15	849.25	124169			
	US26D	738.60	032486			
	US32D	984.60	007863			





Description	Finish	2018 List	Stock No.	Box Qty.	Case Qty.		
WTBB1199 Wide Throw Brass or Stainless Full Mortise Heavy Weight Ball Bearing	4-1/2" x 5" (114 mm x 127 mm)	US3	295.55	007267	3	24	
		US4	233.35	065299			
		US10	233.35	031727			
		US10B	295.55	021314			
		US26	295.55	017632			
		US26D	256.30	007274			
		US32	317.05	089866			
		US32D	317.05	098011			
		4-1/2" x 6" (114 mm x 152 mm)	US3	304.25	023840	3	24
		US4	241.35	068984			
	US10	241.35	048525				
	US10B	304.25	055190				
	US26	304.25	033508				
	US26D	273.55	076837				
	US32	325.50	015353				
	US32D	325.50	007302				
	4-1/2" x 7" (114 mm x 178 mm)	US3	321.30	103595	3	24	
	US4	267.35	051679				
	US10	267.35	013416				
	US10B	321.30	007306				
	US26	321.30	-				
	US26D	308.45	018563				
	US32	347.05	-				
	US32D	347.05	099677				
	4-1/2" x 8" (114 mm x 203 mm)	US3	347.05	028182	3	24	
	US4	295.60	091502				
	US10	295.60	087891				
	US10B	347.05	039213				
	US26	347.05	069204				
	US26D	321.30	105127				
	US32	375.30	051771				
	US32D	375.30	020980				
	5" x 6" (127 mm x 152 mm)	US3	359.90	048922	3	24	
	US4	308.45	021718				
	US10	308.45	125775				
	US10B	359.90	032471				
	US26	359.90	-				
	US26D	331.60	030677				
	US32	401.00	095695				
	US32D	401.00	007332				
	5" x 7" (127 mm x 178 mm)	US3	372.75	046417	3	24	
	US4	308.45	109376				
	US10	308.45	102105				
	US10B	372.75	065989				
	US26	372.75	-				
	US26D	334.20	048069				
	US32	406.15	145249				
	US32D	406.15	030561				

1. Items with the price in **bold and red** are Quick Ship items and ship in 24 hours.
Please use stock number when ordering. 2. U/M is each unless otherwise noted.



Commercial Hinges



Description	Finish	2018 List	Stock No.	Box Qty.	Case Qty.	
WTBB1199 - Cont. Continued	5" x 8" (127 mm x 203 mm)	US3	388.15	084305	3	24
		US4	331.60	142606		
		US10	331.60	146648		
		US10B	388.15	005340		
		US26	388.15	-		
		US26D	347.05	034917		
		US32	424.15	-		
	US32D	424.15	019520			



1250 Steel Full Mortise Standard Weight Spring Hinge Available with Raised Barrel Available with hospital tip (voids UL)	3-1/2" x 3-1/2" (89 mm x 89 mm)	USP	30.25	007989	2	80
		US3	40.05	007984		
		US4	30.25	007986		
		US10	30.25	007974		
		US10A (US11)	40.05	007975		
		US10B	40.05	007977		
	US26D	40.90	007981			



4" x 4" (102 mm x 102 mm)	USP	38.55	008006	3	48
	US3	53.65	008001		
	US4	38.55	008003		
	US10	38.55	007991		
	US10A (US11)	53.65	007992		
	US10B	53.65	007994		
	US26D	47.40	007999		

4-1/2" x 4" (114 mm x 102 mm)	USP	68.90	008020	3	48
	US3	65.35	008014		
	US4	68.90	008015		
	US10	68.90	008008		
	US10A (US11)	65.35	008009		
	US10B	65.35	008010		
	US26D	62.25	008013		

4-1/2" x 4-1/2" (114 mm x 114 mm)	USP	68.90	008050	3	48
	US3	65.35	008039		
	US4	68.90	008041		
	US10	68.90	008021		
	US10A (US11)	65.35	008023		
	US10B	65.35	008025		
	US26	65.35	008034		
	US26D	62.25	008037		



1251 Steel 1/4" Round Corner Radius, Full Mortise Standard Weight Spring Hinge	3-1/2" x 3-1/2" (89 mm x 89 mm)	USP	30.25	008066	2	80
		US3	40.05	008059		
		US4	30.25	008060		
		US10	30.25	012954		
		US10A (US11)	40.05	008054		
		US10B	40.05	064255		
	US26D	40.90	008057			



4" x 4" (102 mm x 102 mm)	USP	38.55	008079	3	48
	US3	53.65	008073		
	US4	38.55	008074		
	US10	38.55	008067		
	US10A (US11)	53.65	008069		
	US10B	53.65	067122		
	US26D	47.40	008072		





Description	Finish	2018 List	Stock No.	Box Qty.	Case Qty.	
1251 - Cont. Continued	4-1/2" x 4" (114 mm x 102 mm)	USP	67.00	008086	3	48
		US3	92.90	003696		
		US4	82.60	008084		
		US10	82.60	012636		
		US10A (US11)	92.90	072921		
		US10B	92.90	038047		
		US26D	89.55	008082		
4-1/2" x 4-1/2" (114 mm x 114 mm)	USP	67.00	008093	3	48	
	US3	92.90	008091			
	US4	82.60	008092			
	US10	82.60	008087			
	US10A (US11)	92.90	008088			
	US10B	92.90	020899			
	US26D	89.55	008090			
1252 Steel 5/8" Round Corner Radius Full Mortise Standard Weight Spring Hinge	3-1/2" x 3-1/2" (89 mm x 89 mm)	USP	30.25	008101	2	80
		US3	40.05	008098		
		US4	30.25	008099		
		US10	30.25	008094		
		US10A (US11)	40.05	073193		
		US10B	40.05	034664		
		US26D	40.90	008097		
4" x 4" (102 mm x 102 mm)	USP	38.55	008111	3	48	
	US3	53.65	008106			
	US4	38.55	008107			
	US10	38.55	008102			
	US10A (US11)	53.65	008103			
	US10B	53.65	079680			
	US26D	47.40	008105			
4-1/2" x 4" (114 mm x 102 mm)	USP	67.00	094477	3	48	
	US3	92.90	131917			
	US4	82.60	128797			
	US10	82.60	-			
	US10A (US11)	92.90	-			
	US10B	92.90	066475			
	US26D	89.55	008112			
4-1/2" x 4-1/2" (114 mm x 114 mm)	USP	67.00	008116	3	48	
	US3	92.90	072949			
	US4	82.60	008115			
	US10	82.60	110806			
	US10A (US11)	92.90	004677			
	US10B	92.90	090888			
	US26D	89.55	008113			
1253 Steel Half Surface Standard Weight Spring Hinge	4-1/2" (114 mm)	USP	102.20	008126	3	48
		US3	141.45	008122		
		US4	122.95	008123		
		US10	122.95	068449		
		US10A (US11)	141.45	040132		
		US10B	141.45	029321		
		US26D	145.20	008121		



1. Items with the price in **bold and red** are Quick Ship items and ship in 24 hours.
Please use stock number when ordering. 2. U/M is each unless otherwise noted.



Commercial Hinges



Description	Finish	2018 List	Stock No.	Box Qty.	Case Qty.	
1255 Steel, Full Mortise Standard Weight Spring Hinge Set 2 ea. 1250 and 1 ea. AB700	4-1/2" x 4-1/2" (114 mm x 114 mm)	USP	174.50	059982	1	16
		US3	183.10	069391		
		US4	184.20	072216		
		US10B	183.10	015725		
		US26D	160.30	050862		
1256 Steel Full Mortise Standard Weight Spring Hinge Set 2 ea. 1250 and 1 ea. BB1279	4-1/2" x 4-1/2" (114 mm x 114 mm)	USP	170.75	066379	1	16
		US3	176.55	066381		
		US4	178.75	066382		
		US10B	176.55	078188		
		US26D	156.60	066380		
1257 Steel Reverse Action (opens door) Spring Hinge Full Mortise Standard Weight	3-1/2" x 3-1/2" (89 mm x 89 mm)	USP	31.30	092328	2	80
		US3	50.00	067841		
		US4	39.00	039089		
		US10	47.25	137319		
		US10A (US11)	50.00	-		
		US10B	50.00	060356		
	4" x 4" (102 mm x 102 mm)	US26D	51.15	040710		
		USP	39.35	073648	3	48
		US3	60.45	025750		
		US4	52.80	038768		
		US10	52.80	070295		
		US10A (US11)	60.50	043768		
	4-1/2" x 4" (114 mm x 102 mm)	US10B	60.50	002584		
		US26D	56.70	032167		
		USP	77.80	035215	3	48
		US3	109.90	068150		
		US4	95.65	007310		
		US10	95.65	101197		
	4-1/2" x 4-1/2" (114 mm x 114 mm)	US10A (US11)	109.90	068555		
US10B		109.90	054881			
US26D		105.55	028649			
USP		77.80	028435	3	48	
US3		109.90	043734			
US4		95.65	031889			
	US10	95.65	025898			
	US10A (US11)	109.90	053642			
	US10B	109.90	028288			
	US26D	105.55	023280			

1. Items with the price in **bold and red** are Quick Ship items and ship in 24 hours. Please use stock number when ordering. 2. U/M is each unless otherwise noted.



Description	Finish	2018 List	Stock No.	Box Qty.	Case Qty.
1258	4" x 4"	USP	39.35	089659	3 48
Steel	(102 mm x 102 mm)	US3	60.45	073758	
Reverse Action (opens door)		US4	52.80	024870	
Spring Hinge		US10	52.80	103534	
1/4" Round Corner Radius		US10A (US11)	60.50	014734	
Full Mortise		US10B	60.50	-	
Standard Weight		US26D	56.70	059064	
<hr/>					
	4-1/2" x 4"	USP	77.80	-	3 48
	(114 mm x 102 mm)	US3	109.90	-	
		US4	95.65	-	
		US10	95.65	-	
		US10A (US11)	109.90	090908	
		US10B	109.90	050348	
		US26D	105.55	018075	
<hr/>					
	4-1/2" x 4-1/2"	USP	77.80	070595	3 48
	(114 mm x 114 mm)	US3	109.90	047076	
		US4	95.65	146899	
		US10	95.65	-	
		US10A (US11)	109.90	064308	
		US10B	109.90	077955	
		US26D	105.55	004667	
<hr/>					
1259	4" x 4"	USP	39.35	057105	3 48
Steel	(102 mm x 102 mm)	US3	60.45	022378	
Reverse Action (opens door)		US4	52.80	003583	
Spring Hinge		US10	52.80	095173	
5/8" Round Corner Radius		US10A (US11)	60.50	045428	
Full Mortise		US10B	60.50	003805	
Standard Weight		US26D	56.70	066746	
<hr/>					
	4-1/2" x 4"	USP	77.80	095677	3 48
	(114 mm x 102 mm)	US3	109.90	-	
		US4	95.65	-	
		US10	95.65	-	
		US10A (US11)	109.90	-	
		US10B	109.90	-	
		US26D	105.55	117570	
<hr/>					
	4-1/2" x 4-1/2"	USP	77.80	119644	3 48
	(114 mm x 114 mm)	US3	109.90	034821	
		US4	95.65	136373	
		US10	95.65	-	
		US10A (US11)	109.90	-	
		US10B	109.90	028805	
		US26D	105.55	013126	
<hr/>					
1260	3-1/2" (89 mm)	USP	71.80	008132	3 48
Steel		US3	107.45	008130	
Full Mortise		US4	78.35	008131	
Standard Weight		US10	88.95	008127	
Swing Clear		US10A (US11)	107.45	057903	
		US10B	107.45	019620	
		US26	107.45	008128	
		US26D	85.15	008129	



1. Items with the price in **bold and red** are Quick Ship items and ship in 24 hours.
Please use stock number when ordering. 2. U/M is each unless otherwise noted.



Commercial Hinges



Description		Finish	2018 List	Stock No.	Box Qty.	Case Qty.
1260 - Cont. Continued	4" (102 mm)	USP	85.15	008134	3	36
		US3	109.85	051811		
		US4	81.00	051756		
		US10	91.90	052043		
		US10A (US11)	109.85	097783		
		US10B	109.85	018275		
		US26	109.85	008133		
		US26D	87.60	053701		



BB1260 Steel Full Mortise Standard Weight Ball Bearing Swing Clear	4-1/2" (114 mm)	USP	152.05	008150	3	36
		US10	158.30	008137		
		US10A (US11)	186.95	008140		
		US10B	186.95	062238		
		US26D	162.10	008142		
RH Standard (Reversible to LH)	5" (127 mm)	USP	152.05	008157	3	36
		US10	158.30	016025		
		US10A (US11)	186.95	008154		
		US10B	186.95	061702		
		US26D	162.10	008156		



BB1261 Steel Full Mortise Standard Weight Ball Bearing Swing Clear	4-1/2" (114 mm)	USP	152.05	008174	3	36
		US10	158.30	008161		
		US10A (US11)	186.95	008163		
		US10B	186.95	098270		
		US26D	162.10	008166		
Beveled Edge Doors RH Standard (Reversible to LH)	5" (127 mm)	USP	152.05	032933	3	36
		US10	158.30	083843		
		US10A (US11)	186.95	008175		
		US10B	186.95	073019		
		US26D	162.10	008177		



BB1262 Steel Full Mortise Heavy Weight Ball Bearing Swing Clear	4-1/2" (114 mm)	USP	188.10	008193	3	24
		US10	190.80	008181		
		US10A (US11)	229.15	008182		
		US10B	229.15	080232		
		US26D	177.45	008186		
RH Standard (Reversible to LH)	5" (127 mm)	USP	188.10	008205	3	24
		US10	190.80	008195		
		US10A (US11)	229.15	007128		
		US10B	229.15	022873		
		US26D	177.45	008199		



BB1263 Steel Full Mortise Heavy Weight Ball Bearing Swing Clear	4-1/2" (114 mm)	USP	188.10	008223	3	24
		US10	190.80	008212		
		US10A (US11)	229.15	008214		
		US10B	229.15	008216		
		US26D	177.45	008218		
Beveled Edge Doors RH Standard (Reversible to LH)	5" (127 mm)	USP	188.10	008236	3	24
		US10	190.80	008225		
		US10A (US11)	229.15	008227		
		US10B	229.15	018189		
		US26D	177.45	008229		



Description	Finish	2018 List	Stock No.	Box Qty.	Case Qty.
BB1264 5" (127 mm)	USP	418.35	008249	3	24
Steel	US10	439.25	025668		
Half Mortise	US10A (US11)	593.90	036300		
Heavy Weight	US10B	593.90	039396		
Ball Bearing	US26D	516.50	008246		
Swing Clear					
BB1265 5" (127 mm)	USP	418.35	008336	3	24
Steel	US10	439.25	088701		
Half Mortise	US10A (US11)	593.90	-		
Heavy Weight	US10B	593.90	-		
Ball Bearing	US26D	516.50	002311		
Swing Clear					
Beveled Edge Doors					
BB1266 5" (127 mm)	USP	368.35	008266	3	12
Steel	US10	386.60	071003		
Full Surface	US10A (US11)	580.70	026077		
Heavy Weight	US10B	580.70	060302		
Ball Bearing	US26D	460.30	008261		
Swing Clear					
1267 4-1/2" (114 mm)	USP	190.00	135773	3	36
Steel	US3	221.30	121383		
Full Mortise	US10	199.90	-		
Swing Clear Spring Hinge	US10A (US11)	221.30	-		
Square Edge Doors	US10B	221.30	-		
Use with BB1260/AB7001	US26	221.30	-		
	US26D	210.20	113387		
BB1270 5" (127 mm)	USP	368.35	008282	3	12
Steel	US10	386.60	062242		
Half Surface	US10A (US11)	580.70	108714		
Heavy Weight	US10B	580.70	034690		
Ball Bearing	US26D	460.30	008277		
Swing Clear					
1277		106.20*	-	3	48
Made to Order		*Add to price of			
Full Mortise		1279			
Standard Weight					
Both Leaves Tapped					
BB1277		106.20*	-	3	48
Made to Order		*Add to price of			
Steel		BB1279			
Full Mortise					
Standard Weight					
Ball Bearing					
Both Leaves Tapped					

1. Items with the price in **bold and red** are Quick Ship items and ship in 24 hours.
Please use stock number when ordering. 2. U/M is each unless otherwise noted.



Commercial Hinges



Description	Finish	2018 List	Stock No.	Box Qty.	Case Qty.
1278 Steel Full Mortise Standard Weight Plain Bearing One Leaf Tapped Specify Handing		106.20* *Add to price of 1279	-	3	48
BB1278 Steel Full Mortise Standard Weight Ball Bearing One Leaf Tapped Specify Handing		106.20* *Add to price of BB1279	-	3	48
1279 Steel Full Mortise Standard Weight Plain Bearing	3" x 3" (76 mm x 76 mm)	LS H2H USP US3 US4 US10 US10A (US11) US10B US15 US26 US26D	26.95 54.55 23.00 50.35 26.95 26.95 50.35 50.35 50.35 50.35 50.35 41.85	008460 008448 008461 008449 008454 008427 008429 064052 008435 008439 008442	2 100





Description	Finish	2018 List	Stock No.	Box Qty.	Case Qty.	
1279 - Cont. Continued	3-1/2" x 3-1/2" (89 mm x 89 mm)	LS	9.40	010919	2	100
		H2H	19.05	010881		
		USP	7.35	010923		
		US3	14.80	010886		
		US4	9.40	010897		
		US10	9.40	010819		
		US10A (US11)	14.80	010829		
		US10B	14.80	010839		
		US15	14.80	010850		
		US26	14.80	010859		
		US26D	12.35	010870		
	4" x 3-1/2" (102 x 89 mm)	LS	17.35	-	3	48
		H2H	28.20	-		
USP		13.35	000695			
US3		24.50	008469			
US4		15.70	096337			
US10		15.70	015158			
US10A (US11)		24.50	063165			
US10B		24.50	025812			
US15		24.50	041310			
US26		24.50	056835			
US26D		21.30	088103			
4" x 4" (102 mm x 102 mm)		LS	11.60	008583	3	48
		H2H	20.80	008532		
	USP	9.10	008585			
	US3	16.65	008540			
	US4	11.60	008555			
	US10	11.60	008470			
	US10A (US11)	16.65	008477			
	US10B	16.65	008488			
	US15	16.65	008496			
	US26	16.65	008507			
	US26D	15.15	008517			
	4-1/2" x 4" (114 mm x 102 mm)	LS	11.15	008648	3	48
		H2H	23.95	067471		
USP		9.60	008650			
US3		19.20	008629			
US4		11.15	008637			
US10		11.15	008599			
US10A (US11)		19.20	008602			
US10B		19.20	008608			
US15		19.20	008612			
US26		19.20	008617			
US26D		12.00	008622			

1. Items with the price in **bold and red** are Quick Ship items and ship in 24 hours.
Please use stock number when ordering. 2. U/M is each unless otherwise noted.



Commercial Hinges



Description	Finish	2018 List	Stock No.	Box Qty.	Case Qty.	
1279 - Cont. 2 Continued	4-1/2" x 4-1/2" (114 mm x 114 mm)	LS	11.15	008826	3	48
		H2H	23.95	008748		
		USP	9.60	008833		
		US3	19.20	008762		
		US4	11.15	008785		
		US10	11.15	008657		
		US10A (US11)	19.20	008671		
		US10B	19.20	008687		
		US15	19.20	008698		
		US26	19.20	008709		
		US26D	12.00	008720		
	<hr/>					
	5" x 4" (127 mm x 102 mm)		LS	38.55	-	3
		H2H	65.15	038234		
		USP	31.70	008871		
		US3	52.15	008863		
		US4	38.55	008865		
		US10	38.55	088473		
		US10A (US11)	52.15	009784		
		US10B	52.15	008536		
		US15	52.15	068578		
		US26	52.15	064843		
		US26D	35.70	008862		
<hr/>						
5" x 4-1/2" (127 mm x 114 mm)			LS	38.55	-	3
		H2H	65.15	031063		
		USP	31.70	008911		
		US3	52.15	008895		
		US4	38.55	008900		
		US10	38.55	008875		
		US10A (US11)	52.15	008879		
		US10B	52.15	008882		
		US15	52.15	083724		
		US26	52.15	008884		
		US26D	35.70	008887		
	<hr/>					
	5" x 5" (127 mm x 127 mm)		LS	38.55	081132	3
		H2H	65.15	019652		
		USP	31.70	008963		
		US3	52.15	008944		
		US4	38.55	008956		
		US10	38.55	008923		
		US10A (US11)	52.15	008925		
		US10B	52.15	008929		
		US15	52.15	067162		
		US26	52.15	008934		
		US26D	35.70	008938		





Description	Finish	2018 List	Stock No.	Box Qty.	Case Qty.	
BB1279 Steel Full Mortise Standard Weight Ball Bearing	3-1/2" x 3-1/2" (89 mm x 89 mm)	LS	35.55	019111	2	100
		H2H	57.60	-		
		USP	35.55	011038		
		US3	46.10	011013		
		US4	35.55	011021		
		US10	35.55	010983		
		US10A (US11)	46.10	010988		
		US10B	46.10	010995		
		US15	46.10	060839		
		US26	46.10	010998		
		US26D	35.90	011003		
	4" x 3-1/2" (102 mm x 89 mm)	LS	41.90	-	3	48
		H2H	62.35	-		
		USP	38.30	072989		
		US3	55.35	009726		
US4		38.30	028772			
US10		41.90	006898			
US10A (US11)		55.35	070929			
US10B		55.35	014742			
US15		55.35	029388			
US26		55.35	000728			
4" x 4" (102 mm x 102 mm)	LS	29.65	009805	3	48	
	H2H	44.80	020230			
	USP	25.95	009808			
	US3	35.85	009778			
	US4	25.95	009792			
	US10	29.65	009727			
	US10A (US11)	35.85	009731			
	US10B	35.85	009738			
	US15	35.85	009747			
	US26	35.85	009755			
4-1/2" x 4" (114 mm x 102 mm)	LS	24.70	009933	3	48	
	H2H	37.30	045582			
	USP	17.40	009937			
	US3	29.85	009888			
	US4	24.70	009900			
	US10	24.70	009817			
	US10A (US11)	29.85	009825			
	US10B	29.85	009841			
	US15	29.85	009849			
	US26	29.85	009857			
	US26D	16.75	009868			

1. Items with the price in **bold and red** are Quick Ship items and ship in 24 hours.
Please use stock number when ordering. 2. U/M is each unless otherwise noted.



Commercial Hinges



Description	Finish	2018 List	Stock No.	Box Qty.	Case Qty.	
BB1279 - Cont. Continued	4-1/2" x 4-1/2" (114 mm x 114 mm)	LS	24.70	010310	3	48
		H2H	37.30	010172		
		USP	17.40	010322		
		US3	29.85	010189		
		US4	24.70	010230		
		US10	24.70	009957		
		US10A (US11)	29.85	009990		
		US10B	29.85	010029		
		US15	29.85	010048		
		US26	29.85	010073		
		US26D	16.75	010108		
	<hr/>					
	5" x 4" (127 mm x 102 mm)		LS	48.25	-	3
		H2H	76.40	-		
		USP	48.25	010411		
		US3	61.10	010397		
		US4	48.25	010403		
		US10	48.25	010377		
		US10A (US11)	61.10	010380		
		US10B	61.10	071584		
		US15	61.10	035721		
		US26	61.10	010385		
		US26D	47.25	010390		
<hr/>						
5" x 4-1/2" (127 mm x 114 mm)			LS	48.25	055246	3
		H2H	76.40	-		
		USP	48.25	010515		
		US3	61.10	010479		
		US4	48.25	010493		
		US10	48.25	010416		
		US10A (US11)	61.10	010429		
		US10B	61.10	010438		
		US15	61.10	010444		
		US26	61.10	010447		
		US26D	47.25	010457		
	<hr/>					
	5" x 5" (127 mm x 127 mm)		LS	48.25	-	3
		H2H	76.40	105812		
		USP	48.25	010620		
		US3	61.10	010586		
		US4	48.25	010602		
		US10	48.25	010537		
		US10A (US11)	61.10	010546		
		US10B	61.10	010556		
		US15	61.10	010559		
		US26	61.10	010564		
		US26D	47.25	010570		



Description	Finish	2018 List	Stock No.	Box Qty.	Case Qty.
BB1279 - Cont. 2	6" x 4-1/2"	LS	114.70	-	3 24
Continued	(152 mm x 114 mm)	H2H	174.80	-	
		USP	114.70	010651	
		US3	154.25	010644	
		US4	114.70	010649	
		US10	114.70	010632	
		US10A (US11)	154.25	009996	
		US10B	154.25	010638	
		US15	154.25	093744	
		US26	154.25	113396	
		US26D	132.45	010641	
	<hr/>				
	6" x 5"	LS	114.70	-	3 24
	(152 mm x 127 mm)	H2H	174.80	-	
		USP	114.70	065930	
		US3	154.25	017680	
		US4	114.70	014005	
		US10	114.70	010656	
		US10A (US11)	154.25	010658	
		US10B	154.25	020934	
		US15	154.25	108871	
		US26	154.25	-	
		US26D	132.45	010660	
	<hr/>				
	6" x 6"	LS	114.70	-	3 24
	(152 mm x 152 mm)	H2H	174.80	-	
		USP	114.70	010696	
		US3	154.25	010685	
		US4	114.70	010689	
		US10	114.70	010674	
		US10A (US11)	154.25	010677	
		US10B	154.25	068156	
		US15	154.25	043949	
		US26	154.25	010679	
		US26D	132.45	010681	

1. Items with the price in **bold and red** are Quick Ship items and ship in 24 hours.
 Please use stock number when ordering. 2. U/M is each unless otherwise noted.



Commercial Hinges



Description	Finish	2018 List	Stock No.	Box Qty.	Case Qty.		
WTBB1279 Wide Throw Steel Full Mortise Standard Weight Ball Bearing	3-1/2" x 5" (89 mm x 127 mm)	LS	68.15	-	3	24	
		USP	65.40	010918			
		US3	83.40	009518			
		US10	68.15	101108			
		US10A (US11)	83.40	009516			
		US10B	83.40	023424			
		US26	83.40	065499			
		US26D	74.25	011178			
		3-1/2" x 6" (89 mm x 152 mm)	LS	68.15	-	3	24
		USP	65.40	066581			
	US3	83.40	047525				
	US10	68.15	121608				
	US10A (US11)	83.40	132395				
	US10B	83.40	098415				
	US26	83.40	117331				
	US26D	74.25	009523				
4" x 5" (102 mm x 127 mm)	LS	95.10	-	3	24		
	USP	91.85	009537				
	US3	110.85	009531				
	US10	95.10	011977				
	US10A (US11)	110.85	009527				
	US10B	110.85	031902				
	US26	110.85	009684				
	US26D	101.75	092731				
4" x 6" (102 mm x 152 mm)	LS	95.10	-	3	24		
	USP	91.85	009547				
	US3	110.85	009545				
	US10	95.10	014811				
	US10A (US11)	110.85	009540				
	US10B	110.85	006722				
	US26	110.85	022988				
	US26D	101.75	009543				
4" x 7" (102 mm x 178 mm)	LS	95.10	130408	3	24		
	USP	91.85	093245				
	US3	110.85	009552				
	US10	95.10	146515				
	US10A (US11)	110.85	049316				
	US10B	110.85	015456				
	US26	110.85	002586				
	US26D	101.75	009551				





Description	Finish	2018 List	Stock No.	Box Qty.	Case Qty.
WTBB1279 - Cont. Continued	4-1/2" x 5" (114 mm x 127 mm)	LS	91.05	-	3 24
		USP	89.10	009587	
		US3	101.90	009573	
		US10	91.05	009557	
		US10A (US11)	101.90	009559	
		US10B	101.90	009564	
		US26	101.90	009566	
		US26D	95.30	009567	
4-1/2" x 6" (114 mm x 152 mm)	LS	91.05	-	3	24
	USP	89.10	009629		
	US3	101.90	009613		
	US10	91.05	009591		
	US10A (US11)	101.90	009596		
	US10B	101.90	009600		
	US26	101.90	009601		
	US26D	95.30	009607		
4-1/2" x 7" (114 mm x 178 mm)	USP	95.90	009654	3	24
	US3	109.55	009644		
	US10	98.00	009636		
	US10A (US11)	109.55	097139		
	US10B	109.55	034974		
	US26D	102.60	009642		
4-1/2" x 8" (114 mm x 203 mm)	USP	95.90	009671	3	24
	US3	109.55	093992		
	US10	98.00	066950		
	US10A (US11)	109.55	028232		
	US10B	109.55	019076		
	US26D	102.60	009663		
5" x 6" (127 mm x 152 mm)	USP	121.75	049054	3	24
	US3	152.10	097745		
	US10	127.80	009676		
	US10A (US11)	152.10	019102		
	US10B	152.10	028233		
	US26D	140.00	009683		
5" x 7" (127 mm x 178 mm)	USP	121.75	033635	3	24
	US3	152.10	021386		
	US10	127.80	009694		
	US10A (US11)	152.10	050575		
	US10B	152.10	030684		
	US26D	140.00	036924		
5" x 8" (127 mm x 203 mm)	USP	121.75	027044	3	24
	US3	152.10	047665		
	US10	127.80	042602		
	US10A (US11)	152.10	034328		
	US10B	152.10	011281		
	US26D	140.00	094856		

1. Items with the price in **bold and red** are Quick Ship items and ship in 24 hours.
Please use stock number when ordering. 2. U/M is each unless otherwise noted.



Commercial Hinges



Description	Finish	2018 List	Stock No.	Box Qty.	Case Qty.	
1303 Double Acting Spring Hinge	3" (76 mm)	USP	43.95	126803	1	10
		US3	58.00	126804		
		US4	53.20	126805		
		US26D	71.80	126807		
	4" (102 mm)	USP	49.85	126808	1	10
		US3	65.55	126809		
		US4	64.55	126810		
		US26D	80.65	126811		
	5" (127 mm)	USP	71.35	126812	1	10
		US3	96.25	126813		
		US4	105.85	126814		
		US26D	117.95	126815		
6" (152 mm)	USP	71.35	126816	1	10	
	US3	96.25	126817			
	US4	105.85	126818			
	US26D	117.95	126819			
BB1360 Stainless Steel Full Mortise Standard Weight Ball Bearing Swing Clear RH Standard (reversible to LH)	4-1/2" (114 mm)	US32D	221.80	060909	3	36
	5" (127 mm)	US32D	221.80	097565	3	36
BB1361 Stainless Steel Full Mortise Standard Weight Ball Bearing Swing Clear Beveled Edge Doors RH Standard (reversible to LH)	4-1/2" (114 mm)	US32D	221.80	044728	3	36
	5" (127 mm)	US32D	221.80	094295	3	36
BB1362 Stainless Steel Full Mortise Heavy Weight Ball Bearing Swing Clear RH Standard (reversible to LH)	4-1/2" (114 mm)	US32D	248.60	045163	3	24
	5" (127 mm)	US32D	248.60	041420	3	24
BB1363 Stainless Steel Full Mortise Heavy Weight Ball Bearing Swing Clear Beveled Edge Doors RH Standard (reversible to LH)	4-1/2" (114 mm)	US32D	248.60	042414	3	24
	5" (127 mm)	US32D	248.60	042845	3	24
1577 Brass or stainless Full Mortise Standard Weight Plain Bearing Both Leaves Tapped			105.35*	-	3	48
			*Add to price of 1191			











Description	Finish	2018 List	Stock No.	Box Qty.	Case Qty.	
BB1577 Brass or stainless Full Mortise Standard Weight Ball Bearing Both Leaves Tapped		105.35* *Add to price of BB1191	-	3	48	
1578 Brass or stainless Full Mortise Standard Weight Plain Bearing One Leaf Tapped Specify Handing		105.35* *Add to price of 1191	-	3	48	
BB1578 Brass or stainless Full Mortise Standard Weight Ball Bearing One Leaf Tapped Specify Handing		105.35* *Add to price of BB1191	-	3	48	
1712 Ball Tip Hinge Kit Standard Weight	3-1/2" (89 mm) 4" (102 mm) 4-1/2" (114 mm) 5" (127 mm) 6" (152 mm)	ALL ALL ALL ALL ALL	57.95 57.95 58.35 58.35 58.35	066653 066654 066655 066656 079328	10 10 10 10 10	100 100 100 100 100
1713 Ball Tip Hinge Kit Heavy Weight	4-1/2" (114 mm) 5" (127 mm) 6" (152 mm)	ALL ALL ALL	63.75 63.75 63.75	066657 066658 072882	10 10 10	100 100 100
1716 Acorn Tip Hinge Kit Standard Weight	3-1/2" (89 mm) 4" (102 mm) 4-1/2" (114 mm) 5" (127 mm) 6" (152 mm)	ALL ALL ALL ALL ALL	58.35 58.35 58.35 58.35 58.35	066638 066639 066640 066641 -	10 10 10 10 10	100 100 100 100 100
1717 Acorn Tip Hinge Kit Heavy Weight	4-1/2" (114 mm) 5" (127 mm) 6" (152 mm)	ALL ALL ALL	63.75 63.75 63.75	015890 066643 -	10 10 10	100 100 100
1722 Steeple Tip Hinge Kit Standard Weight	3-1/2" (89 mm) 4" (102 mm) 4-1/2" (114 mm) 5" (127 mm) 6" (152 mm)	ALL ALL ALL ALL ALL	58.35 58.35 58.35 58.35 58.35	066644 066645 066689 066690 -	10 10 10 10 10	100 100 100 100 100
1723 Steeple Tip Hinge Kit Heavy Weight	4-1/2" (114 mm) 5" (127 mm) 6" (152 mm)	ALL ALL ALL	63.75 63.75 63.75	066691 066646 -	10 10 10	100 100 100

1. Items with the price in **bold and red** are Quick Ship items and ship in 24 hours.
Please use stock number when ordering. 2. U/M is each unless otherwise noted.

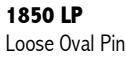

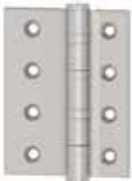
Commercial Hinges

	Description	Finish	2018 List	Stock No.	Box Qty.	Case Qty.	
	1728						
	Urn Tip Hinge Kit						
	Standard Weight						
		3-1/2" (89 mm)	ALL	58.35	066647	10	100
		4" (102 mm)	ALL	58.35	066648	10	100
	1729						
	Urn Tip Hinge Kit						
	Heavy Weight						
		4-1/2" (114 mm)	ALL	63.75	066651	10	100
	1850						
	Steel - Full Surface						
	Heavy Weight						
	Plain Bearing						
	No Holes						
	4" x 4" (102 mm x 102 mm)	PS	55.90	042562	10	40	
	4-1/2" x 4-1/2" (114 mm x 114 mm)	PS	73.25	042564	10	40	
	5" x 5" (127 mm x 127 mm)	PS	94.10	042596	1	10	
	6" x 6" (152 mm x 152 mm)	PS	140.50	042597	1	10	
	1850 LP						
	Loose Oval Pin						
	6" x 6" (152 mm x 152 mm)	PS	140.50	177161	1	10	
	BB2098						
	Brass or Stainless						
	Half Mortise						
	Heavy Weight						
	Ball Bearing						
		4-1/2" (114 mm)	US10	201.10	012708	3	36
			US10B	245.25	087963		
			US26D	188.55	012711		
			US32D	285.95	012716		
		5" (127 mm)	US10	243.15	-	3	24
		US10B	287.25	110727			
		US26D	257.10	012724			
		US32D	334.80	012728			
	6" x 1-3/4" (152 mm x 45 mm)	US26D	422.30	042103	3	12	
		US32D	603.20	012735			
	BB2108						
	Brass or Stainless						
	Full Surface						
	Heavy Weight						
	Ball Bearing						
		4-1/2" (114 mm)	US10	257.75	067805	3	36
			US10B	314.40	070520		
			US26D	276.20	004606		
			US32D	288.25	012747		
		5" (127 mm)	US10	296.40	-	3	24
		US10B	400.85	-			
		US26D	348.55	100138			
		US32D	452.90	036742			
	6" (152 mm)	US26D	406.00	022939	3	12	
		US32D	580.00	012757			
	BB2109						
	Brass or Stainless						
	Full Surface						
	Heavy Weight						
	Ball Bearing						
		4-1/2" (114 mm)	US10	296.40	012759	3	36
			US10B	400.85	115826		
			US26D	348.55	012762		
			US32D	452.90	012765		
		5" (127 mm)	US10	296.40	-	3	24
		US10B	400.85	131276			
		US26D	348.55	012768			
		US32D	452.90	012771			
	6" (152 mm)	US26D	406.00	086735	3	12	
		US32D	580.00	012778			



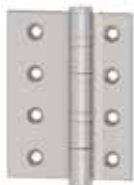

Description	Finish	2018 List	Stock No.	Box Qty.	Case Qty.		
BB2110 Brass or Stainless Full Surface Standard Weight Ball Bearing	4-1/2" (114 mm)	US10	193.35	012793	3	48	
		US10B	241.70	074876			
		US26D	208.10	012795			
		US32D	281.95	012796			
	5" (127 mm)	US10	213.25	-	3	24	
		US10B	288.25	-			
		US26D	250.70	049870			
		US32D	357.95	012803			
	BB2112 Brass or Stainless Half Surface Standard Weight Ball Bearing	4" (102 mm)	US10	401.25	056746	3	48
			US10B	505.25	028766		
		US26D	434.65	026917			
		US32D	589.35	006867			
4-1/2" (114 mm)		US10	193.35	012824	3	48	
		US10B	241.70	002499			
		US26D	208.10	012828			
		US32D	281.95	012833			
5" (127 mm)		US10	204.20	012838	3	36	
		US10B	265.45	133233			
	US26D	230.90	012839				
	US32D	300.15	004041				
BB2113 Brass or Stainless Half Surface Heavy Weight Ball Bearing	4-1/2" (114 mm)	US10	219.90	012847	3	36	
		US10B	268.15	002056			
		US26D	235.65	012852			
		US32D	296.75	012857			
	5" (127 mm)	US10	255.55	012863	3	24	
		US10B	332.10	012864			
		US26D	297.30	012865			
		US32D	387.15	012866			
	6" x 3-1/4" (152 mm x 45 mm)	US26D	458.20	068257	3	12	
		US32D	597.45	012873			
BB2168 Steel Full Surface Heavy Weight Ball Bearing	4-1/2" (114 mm)	USP	305.20	012899	3	36	
		US10	318.00	-			
		US10A (US11)	372.30	-			
		US10B	372.30	089570			
		US26D	333.65	012898			
	5" (127 mm)	USP	368.45	012902	3	24	
		US10	386.90	141575			
		US10A (US11)	504.20	-			
		US10B	504.20	-			
		US26D	438.45	011313			
	6" (152 mm)	USP	391.40	009661	3	12	
		US10	411.00	-			
		US10A (US11)	555.55	-			
		US10B	555.55	-			
		US26D	483.35	012903			

1. Items with the price in **bold and red** are Quick Ship items and ship in 24 hours.
Please use stock number when ordering. 2. U/M is each unless otherwise noted.



Commercial Hinges



Description		Finish	2018 List	Stock No.	Box Qty.	Case Qty.	
BB2169 Steel Full Surface Heavy Weight Ball Bearing	4-1/2" (114 mm)	USP	213.45	012914	3	36	
		US10	318.05	042983			
		US10A (US11)	372.30	061635			
		US10B	372.30	115013			
		US26D	333.65	012911			
	5" (127 mm)	USP	329.00	012923	3	24	
		US10	345.40	129997			
		US10A (US11)	460.90	-			
		US10B	460.90	080993			
		US26D	400.75	012920			
	6" (152 mm)	USP	439.30	012930	3	12	
		US10	461.35	082081			
		US10A (US11)	555.55	-			
US10B		555.55	-				
US26D		471.45	012929				
BB2171 Steel Full Surface Standard Weight Ball Bearing	4-1/2" (114 mm)	USP	83.40	012946	3	48	
		US10	98.50	012934			
		US10A (US11)	125.60	012936			
		US10B	125.60	143435			
		US26D	110.50	012940			
	5" (127 mm)	USP	99.95	012956	3	36	
		US10	131.50	026071			
		US10A (US11)	163.20	-			
		US10B	163.20	-			
		US26D	141.85	012952			
	AB7001 Steel Full Mortise Standard Weight Concealed Anti-Friction Bearing Swing Clear	4-1/2" (114 mm)	LS	186.40	-	3	36
			USP	186.40	122842		
			US3	229.10	028735		
US10			193.95	-			
US10A (US11)			229.10	077050			
US10B			229.10	008284			
US26			229.10	-			
US26D			181.65	024377			
5" (127 mm)		LS	186.40	-	3	36	
		USP	186.40	-			
		US3	229.10	102769			
		US10	193.95	-			
		US10A (US11)	229.10	-			
	US10B	229.10	-				
	US26	229.10	079631				
	US26D	181.65	087869				









Description	Finish	2018 List	Stock No.	Box Qty.	Case Qty.
AB7002	4-1/2" (114 mm)	LS	186.40	-	3 36
Steel	USP	186.40	065541		
Full Mortise	US3	229.10	024690		
Standard Weight	US10	193.95	-		
Concealed Anti-Friction Bearing	US10A (US11)	229.10	103793		
Swing Clear	US10B	229.10	008287		
Beveled Edge Doors	US26	229.10	068502		
	US26D	181.65	094245		
	5" (127 mm)	LS	186.40	-	3 36
	USP	186.40	-		
	US3	229.10	-		
	US10	193.95	-		
	US10A (US11)	229.10	-		
	US10B	229.10	-		
	US26	229.10	-		
	US26D	181.65	013655		
AB7501	4-1/2" (114 mm)	USP	230.65	073850	3 24
Steel	US10	233.85	017299		
Full Mortise	US10A (US11)	280.75	019030		
Heavy Weight	US10B	280.75	122627		
Concealed Anti-Friction Bearing	US26D	212.85	013622		
Swing Clear	5" (127 mm)	USP	230.65	-	3 24
	US10	233.85	027631		
	US10A (US11)	280.75	116946		
	US10B	280.75	-		
	US26D	212.85	013628		
AB7502	4-1/2" (114 mm)	USP	230.65	041605	3 24
Steel	US10	233.85	025196		
Full Mortise	US10A (US11)	280.75	081770		
Heavy Weight	US10B	280.75	085448		
Concealed Anti-Friction Bearing	US26D	212.85	094244		
Swing Clear	5" (127 mm)	USP	230.65	116906	3 24
Beveled Edge Doors	US10	233.85	025197		
	US10A (US11)	280.75	094319		
	US10B	280.75	109409		
	US26D	212.85	013645		
AB7505	5" x 4-1/2"	LH USP	328.10	013659	1 10
Steel	(127 mm x 114 mm)	RH USP	328.10	092796	
Full Mortise	LH US10	334.35	043893		
Heavy Weight	RH US10	334.35	054740		
Concealed Anti-Friction Bearing	LH US10A (US11)	404.75	013652		
Anchor Hinge	RH US10A (US11)	404.75	-		
Specify Handing	LH US10B	404.75	105739		
	RH US10B	404.75	105740		
	LH US26D	322.10	094710		
	RH US26D	322.10	094711		









1. Items with the price in **bold and red** are Quick Ship items and ship in 24 hours.
Please use stock number when ordering. 2. U/M is each unless otherwise noted.



Commercial Hinges

	Description	Finish	2018 List	Stock No.	Box Qty.	Case Qty.
	AB7506	5" x 4-1/2" (127 mm x 114 mm)	LH USP	328.10	013684	1 10
	Steel		RH USP	328.10	013687	
	Full Mortise		LH US10	334.35	094813	
	Heavy Weight		RH US10	334.35	093244	
	Concealed Anti-Friction Bearing		LH US10A (US11)	404.75	013664	
	Anchor Hinge		RH US10A (US11)	404.75	112521	
	Specify Handing		LH US10B	404.75	124567	
			RH US10B	404.75	124568	
			LH US26D	322.10	013674	
			RH US26D	322.10	013676	
	AB7507	5" x 4-1/2" (127 mm x 114 mm)	LH USP	328.10	018824	1 10
	Steel		RH USP	328.10	071660	
	Full Mortise		LH US10	334.35	076424	
	Heavy Weight		RH US10	334.35	-	
	Concealed Anti-Friction Bearing		LH US10A (US11)	404.75	-	
	Anchor Hinge		RH US10A (US11)	404.75	-	
	Specify Handing		LH US10B	404.75	100912	
			RH US10B	404.75	100911	
			LH US26D	322.10	013696	
			RH US26D	322.10	096847	
	AB7508	5" x 4-1/2" (127 mm x 114 mm)	LH USP	328.10	013735	1 10
	Steel		RH USP	328.10	013736	
	Full Mortise		LH US10	334.35	016914	
	Heavy Weight		RH US10	334.35	016885	
	Concealed Anti-Friction Bearing		LH US10A (US11)	404.75	013713	
	Anchor Hinge		RH US10A (US11)	404.75	039369	
	Beveled Edge Doors		LH US10B	404.75	096476	
	Specify Handing		RH US10B	404.75	096475	
			LH US26D	314.80	013721	
			RH US26D	314.80	013722	
	AB7509	5" x 4-1/2" (127 mm x 114 mm)	LH USP	328.10	013753	1 10
	Steel		RH USP	328.10	095106	
	Full Mortise		LH US10	334.35	036585	
	Heavy Weight		RH US10	334.35	036561	
	Concealed Anti-Friction Bearing		LH US10A (US11)	404.75	-	
	Anchor Hinge		RH US10A (US11)	404.75	-	
	Beveled Edge Doors		LH US10B	404.75	059951	
	Specify Handing		RH US10B	404.75	059965	
			LH US26D	322.10	013748	
			RH US26D	322.10	013749	
	AB7511	5" (127 mm)	USP	481.15	110076	3 24
	Steel		US10	447.55	-	
	Half Mortise		US10A (US11)	605.15	-	
	Heavy Weight		US10B	605.15	-	
	Concealed Anti-Friction Bearing		US26D	498.10	013760	
	Swing Clear					







1. Items with the price in **bold and red** are Quick Ship items and ship in 24 hours.
Please use stock number when ordering. 2. U/M is each unless otherwise noted.

	Description	Finish	2018 List	Stock No.	Box Qty.	Case Qty.
	AB7512	5" (127 mm)	USP	481.15	110077	3 24
	Steel		US10	447.55	-	
	Half Mortise		US10A (US11)	605.15	-	
	Heavy Weight		US10B	605.15	-	
	Concealed Anti-Friction Bearing		US26D	498.10	008559	
	Swing Clear Beveled Edge Doors					
	AB7523	5" (127 mm)	USP	388.00	028670	3 12
	Steel		US10	407.20	-	
	Full Surface		US10A (US11)	611.55	-	
	Heavy Weight		US10B	611.55	129552	
	Concealed Anti-Friction Bearing		US26D	485.05	005548	
	Swing Clear					
	AB7534	5" (127 mm)	USP	388.00	-	3 12
	Steel		US10	407.20	-	
	Half Surface		US10A (US11)	611.55	116947	
	Heavy Weight		US10B	611.55	043778	
	Concealed Anti-Friction Bearing		US26D	485.05	005551	
	Swing Clear					
	AB8505	5" x 4-1/2" (127 mm x 114 mm)	LH US10	343.00	120612	1 10
	Brass or Stainless		RH US10	343.00	120613	
	Full Mortise		LH US10B	410.70	005892	
	Heavy Weight		RH US10B	410.70	005891	
	Concealed Anti-Friction Bearing		LH US26D	325.55	088541	
	Anchor Hinge		RH US26D	325.55	088542	
	Specify Handing		LH US32D	536.20	013976	
			RH US32D	536.20	013977	
	AB8506	5" x 4-1/2" (127 mm x 114 mm)	LH US10	424.70	038811	1 10
	Brass or Stainless		RH US10	424.70	038812	
	Full Mortise		LH US10B	507.70	090057	
	Heavy Weight		RH US10B	507.70	090058	
	Concealed Anti-Friction Bearing		LH US26D	477.45	013988	
	Anchor Hinge		RH US26D	477.45	013990	
	Specify Handing		LH US32D	547.80	013996	
			RH US32D	547.80	013998	
	AB8507	5" x 4-1/2" (127 mm x 114 mm)	LH US10	424.70	-	1 10
	Brass or Stainless		RH US10	424.70	-	
	Full Mortise		LH US10B	507.70	046057	
	Heavy Weight		RH US10B	507.70	046058	
	Concealed Anti-Friction Bearing		LH US26D	476.85	092729	
	Anchor Hinge		RH US26D	476.85	092730	
	Beveled Edge Doors		LH US32D	547.80	093601	
	Specify Handing`		RH US32D	547.80	094538	

1. Items with the price in **bold and red** are Quick Ship items and ship in 24 hours.
Please use stock number when ordering. 2. U/M is each unless otherwise noted.



Commercial Hinges

	Description	Finish	2018 List	Stock No.	Box Qty.	Case Qty.
	AB8508	5" x 4-1/2" (127 mm x 114 mm)	LH US10	424.70	057002	1 10
	Brass or Stainless		RH US10	424.70	057004	
	Full Mortise		LH US10B	507.70	097781	
	Heavy Weight		RH US10B	507.70	014016	
	Concealed Anti-Friction Bearing		LH US26D	476.85	014019	
	Anchor Hinge		RH US26D	476.85	014021	
	Beveled Edge Doors		LH US32D	547.80	014028	
	Specify Handing		RH US32D	547.80	014030	
	AB8509	5" x 4-1/2" (127 mm x 114 mm)	LH US10	424.70	012173	1 10
	Brass or Stainless		RH US10	424.70	012174	
	Full Mortise		LH US10B	507.70	046059	
	Heavy Weight		RH US10B	507.70	046060	
	Concealed Anti-Friction Bearing		LH US26D	476.85	068077	
	Anchor Hinge		RH US26D	476.85	022626	
	Beveled Edge Doors		LH US32D	547.80	014048	
	Specify Handing		RH US32D	547.80	094613	
	EC1100*	4-1/2" x 4" (114 mm x 102 mm)	US26D	9.55	121894	3 48
	Steel					
	Full Mortise	4-1/2" x 4-1/2" (114 mm x 114 mm)	USP	6.55	079434	3 48
	Standard Weight		US3	12.00	079435	
	Plain Bearing		US4	8.70	079441	
			US10B	12.00	075953	
			US15	12.00	108111	
			US26	12.00	108113	
		US26D	9.55	075047		
	EC1100 NRP*	4-1/2" x 4" (114 mm x 102 mm)	US26D	11.60	123072	3 48
	Steel					
	Full Mortise	4-1/2" x 4-1/2" (114 mm x 114 mm)	USP	8.55	084179	3 48
	Standard Weight		US10B	14.00	075986	
	Plain Bearing		US15	14.00	109256	
			US26	14.00	135223	
			US26D	11.60	082934	
	ECBB1100*	4-1/2" x 4" (114 mm x 102 mm)	US26D	11.40	094657	3 48
	Steel					
	Full Mortise	4-1/2" x 4-1/2" (114 mm x 114 mm)	USP	11.05	079444	3 48
	Standard Weight		US3	21.05	079445	
	Ball Bearing		US4	15.30	079446	
			US10B	21.05	076317	
			US15	21.05	108114	
			US26	21.05	108117	
		US26D	11.40	075048		
	ECBB1100 NRP*	4-1/2" x 4" (114 mm x 102 mm)	US26D	13.40	094659	3 48
	Steel					
	Full Mortise	4-1/2" x 4-1/2" (114 mm x 114 mm)	USP	13.10	079448	3 48
	Standard Weight		US3	23.10	082125	
	Ball Bearing		US4	17.35	082129	
			US10B	23.10	076316	
			US26	23.10	109257	
			US26D	13.40	075049	

* ECCO hinges are sold in box quantities only

* Some ECCO hinges available in 316 Stainless Steel. Contact Hager Companies Sales and Service for information.



Description	Finish	2018 List	Stock No.	Box Qty.	Case Qty.
ECRC1100* Round Corner Steel Full Mortise Standard Weight Plain Bearing	4" x 4" (102 mm x 102 mm)	US15 11.55 US26 11.55 US26D 8.00	109258 - 075637	3	48
ECRBB1100* Round Corner Steel Full Mortise Standard Weight Ball Bearing	4" x 4" (102 mm x 102 mm)	US15 14.90 US26 14.90 US26D 10.90	109259 - 073800	3	48
EC1101* Brass or Stainless Steel Full Mortise Standard Weight Plain Bearing	4-1/2" x 4-1/2" (114 mm x 114 mm)	US15 41.50 US26 41.50 US32D 39.90	128121 125210 079552	3	48
ECBB1101* Brass or Stainless Steel Full Mortise Standard Weight Ball Bearing	4-1/2" x 4-1/2" (114 mm x 114 mm)	US15 42.00 US32D 35.85	109275 079555	3	48
* ECCO hinges are sold in box quantities only					
* Other ECCO hinges available in 316 Stainless Steel. Contact Hager Companies Sales and Service for information.					
ECBB1101 NRP* Brass or Stainless Steel Full Mortise Standard Weight Ball Bearing	4-1/2" x 4-1/2" (114 mm x 114 mm)	US15 44.00 US32D 37.85 US32D/316SS 60.30	109276 079557 -	3	48
ECBB1102* Steel Full Mortise Heavy Weight Ball Bearing	4-1/2" x 4-1/2" (114 mm x 114 mm)	USP 24.00 US15 49.95 US26 49.95 US26D 29.75	091900 109284 119967 091783	3	24
	5" x 4-1/2" (127 mm x 114 mm)	US15 51.80 US26 51.80 US26D 34.95	130049 140126 091638	3	24
ECBB1102 NRP* Steel Full Mortise Heavy Weight Ball Bearing	4-1/2" x 4-1/2" (114 mm x 114 mm)	USP 26.00 US15 52.00 US26 52.00 US26D 31.75	091866 109608 127835 091778	3	24
	5" x 4-1/2" (127 mm x 114 mm)	US15 53.80 US26 53.80 US26D 36.95	132673 125212 091618	3	24

1. Items with the price in **bold and red** are Quick Ship items and ship in 24 hours.
Please use stock number when ordering. 2. U/M is each unless otherwise noted.



Commercial Hinges



Description		Finish	2018 List	Stock No.	Box Qty.	Case Qty.
ECBB1103* Brass or Stainless Steel Full Mortise Heavy Weight Ball Bearing	4-1/2" x 4-1/2" (114 mm x 114 mm)	US10B	93.20	091741	3	24
		US15	93.20	129146		
		US26	93.20	138809		
		US32D	85.80	091731		
	5" x 4-1/2" (127 mm x 114 mm)	US15	113.50	-	3	24
		US26	113.50	-		
		US32D	109.85	091592		
ECBB1103 NRP* Brass or Stainless Steel Full Mortise Heavy Weight Ball Bearing	4-1/2" x 4-1/2" (114 mm x 114 mm)	US10B	95.20	091732	3	24
		US26	95.20	-		
		US32D	87.80	091693		
		US32D/316SS	125.90	169967		
	5" x 4-1/2" (127 mm x 114 mm)	US15	115.50	-	3	24
		US26	115.50	-		
		US32D	111.85	091593		
EC1105* Steel Full Mortise Standard Weight Spring Hinge	4-1/2" x 4-1/2" (114 mm x 114 mm)	USP	19.10	079571	3	48
		US3	38.90	079569		
		US4	33.95	079570		
		US10B	38.90	076318		
		US15	38.90	109281		
		US26	38.90	109282		
		US26D	28.60	079567		

* ECCO hinges are sold in box quantities only

* Other ECCO hinges available in 316 Stainless Steel. Contact Hager Companies Sales and Service for information.





Description	Finish	2018 List	Stock No.	Box Qty.	Case Qty.
BB1279 Drop Leaf Steel Full Mortise Standard Weight Ball Bearing NRP Standard Specify handing	4-1/2" x 4-1/2"	US26D		78.65	
BB1168 Drop Leaf Steel Full Mortise Heavy Weight Ball Bearing NRP Standard Specify handing	4-1/2" x 4-1/2"	US26D		126.05	
BB1191 Drop Leaf Steel Full Mortise Heavy Weight Ball Bearing NRP Standard Specify handing	4-1/2" x 4-1/2"	US32D		167.50	
BB1199 Drop Leaf Steel Full Mortise Heavy Weight Ball Bearing NRP Standard Specify handing	4-1/2" x 4-1/2"	US32D		250.55	
BB1279 Short Leaf Steel Full Mortise Standard Weight Ball Bearing Right Hand Standard Reversible to Left Hand	4-1/2" x 4-3/8"	US26D		78.65	
BB1168 Short Leaf Steel Full Mortise Heavy Weight Ball Bearing Right Hand Standard Reversible to Left Hand	4-1/2" x 4-3/8"	US26D		126.05	
BB1191 Short Leaf Brass or Stainless Full Mortise Standard Weight Ball Bearing Right Hand Standard Reversible to Left Hand	4-1/2" x 4-3/8"	US32D		167.50	



1. Items with the price in **bold and red** are Quick Ship items and ship in 24 hours.
 Please use stock number when ordering. 2. U/M is each unless otherwise noted.



Commercial Hinges



Description	Finish	2018 List	Stock No.	Box Qty.	Case Qty.
BB1199 Short Leaf Brass or Stainless Full Mortise Standard Weight Ball Bearing Right Hand Standard Reversible to Left Hand *NRP available upon request		4-1/2" x 4-3/8"	US32D	250.55	
BB1279 Unequal Leaf Centered Steel Full Mortise Standard Weight Ball Bearing NRP Standard Specify handing		5" x 4-1/2"	US26D	121.40	
BB1168 Unequal Leaf Centered Steel Full Mortise Heavy Weight Ball Bearing NRP Standard Specify handing		5" x 4-1/2"	US26D	171.90	
BB1191 Unequal Leaf Centered Steel Full Mortise Heavy Weight Ball Bearing NRP Standard Specify handing		5" x 4-1/2"	US32D	214.45	
BB1199 Unequal Leaf Centered Steel Full Mortise Heavy Weight Ball Bearing NRP Standard Specify handing		5" x 4-1/2"	US32D	313.80	

*Additional sizes, finishes, and hinges available. Contact Hager Customer Service for information.





One Family. One Brand. One Vision.™

www.hagerco.com

TABLE OF CONTENTS

D
Discount Groups 3

F
Fast Riveted Pin..... 16
Finish 2

M
Machine Screws 4

N
Non-Removable Pin (Set Screw in Barrel)..... 2

P
Pins - Residential and Decorative Tips 19

R
Residential Finish Symbols 2

S
Safety Stud..... 13, 15, 19
Solid Brass or Stainless Steel..... 4-6, 11-12
Spring 6, 9-12

T
Template Hinges..... 6, 9

W
Wood Screws..... 17

Residential Hinges

RESIDENTIAL FINISH SYMBOLS

Not all products are available in all finishes. Contact Hager Sales and Service at 1-800-325-9995 for more specific information.

Non-Removable Pins (Medium Security)

Symbol	Description	List
NRP	Set screw in barrel	\$2.65 each

BHMA Symbol Base Material

US & HAGER	DESCRIPTION	STEEL	BRASS	STAINLESS STEEL
1D	Black	N/A	N/A	N/A
2D	Brass Tone Dichromate	N/A	N/A	N/A
3	Bright Brass	632	605	N/A
3LB	Light Brass	N/A	N/A	N/A
4	Satin Brass	633	606	N/A
10A	Antique Bronze - Lacquered	641	614	N/A
10R	Dark Antique Bronze - Matte Lacquer	N/A	N/A	N/A
15	Satin Nickel	646	619	N/A
26	Bright Chromium Plated	651	625	N/A
26D	Satin Chromium Plated	652	626	N/A
32	Stainless Steel Metal, Bright	N/A	N/A	629
32D	Stainless Steel Metal, Satin	N/A	N/A	630
P	Prime Coat - Beige	600	600	N/A
ABA/US5	Antique Brass	638	609	N/A
AN/15A	Antique Nickel	647	620	N/A

Note: For any finish not listed in this Price Book, price and availability on request.

LEAD TIMES

Items with prices in **bold** within this section are stock items and usually ship within 24 hours. Non-stock items will typically ship within 90 business days depending on seasonal volume and order complexity. The anticipated ship date will be included with each order acknowledgment.



RESIDENTIAL DISCOUNT GROUPS

GROUP	DESCRIPTION	DISC %
BB1541 - RCBB1541 - RCBB1542 (3.5)		
80M	3.5 - SS BB (32-32D)	_____
1741 - RC1741 - RC1842 (3.0, 3.5)		
81A	3.0, 3.5 - PB BOX (10A-ABA-AN-1D-26-26D-3)	_____
81C	3.0, 3.5 - PB BOX (10R-15)	_____
81G	3.0, 3.5 - PB BOX (2D-4-P-3LB)	_____
BB1741 - RCBB1741 - RCBB1842 (3.5)		
82A	3.5 - BB BOX (10A-ABA-AN-10R-1D-15-26-26D-3)	_____
82G	3.5 - BB BOX (2D-4-3LB)	_____
RC1641 - RC1841 - 7741 - 8741 (3.5)		
83A	3.5 - BULK (10A-ABA-AN-1D-26-26D-3)	_____
83C	3.5 - BULK (10R-15)	_____
83G	3.5 - BULK (2D-4-P-3LB)	_____
1541 - RC1541 - RC1542 (3.0, 3.5)		
86A	3.0, 3.5 - BRASS (10A-ABA-AN-10R-15-26-26D-3)	_____
86G	3.0, 3.5 - BRASS (4)	_____
86M	3.0, 3.5 - SS (32-32D)	_____
1750 - 1751 - 1752 (3.5)		
87A	3.5 - SPRING (10A-ABA-AN-1D-10R-15-26-26D-3)	_____
87G	3.5 - SPRING (2D-4-P-3LB)	_____
RC1748 (3.5)		
88A	3.5 - RC1748 (10A-ABA-AN-15-26-26D-3)	_____
88G	3.5 - RC1748 (2D-4-P-3LB)	_____
RCBB1841 (3.5)		
8CA	3.5 - BB BULK (AN-15-3-10R-26-26D-5)	_____
8CG	3.5 - BB BULK (2D-4)	_____
BB1543 (4.0)		
90A	4.0 - BRASS BB (10R-3-ABA-AN)	_____
90G	4.0 - BRASS BB (4)	_____
90M	4.0 - SS BB (32-32D)	_____

RCBB1841 (4.0)		
9CA	4.0 - BB BULK (10R-15)	_____

GROUP	DESCRIPTION	DISC %
1741 - RC1741 - 1842 (4.0)		
91A	4.0 - PB BOX (10A-ABA-AN-10R-1D-15-26-26D-H2H)	_____
91C	4.0 - PB BOX (10R-15)	_____
91G	4.0 - PB BOX (2D-4-P-3LB)	_____
RCBB1741 - RCBB1842 (4.0)		
92A	4.0 - BB BOX (10A-ABA-AN-10R-1D-26-26D-3)	_____
92G	4.0 - BB BOX (2D-4-P-3LB)	_____
RC1641 - RC1841 - RC8641 - RC8741 - RC8744 (4.0)		
93A	4.0 - BULK (10A-ABA-AN-1D-26-26D-3)	_____
93C	4.0 - BULK (10R - 15)	_____
93G	4.0 - BULK (2D-4-P-3LB)	_____
RC1542 - 1541 - RC1541 - RC1543 (4.0)		
96A	4.0 - BRASS (ABA-AN-10R-15-26-26D-3)	_____
96M	4.0 - SS (32-32D)	_____
1744 - 1750 - 1751 - 1752 - 1754 - 1760 - 1761 - 1762 - 1764 (4.0)		
97A	4.0 SPRING (10A-ABA-AN-10R-1D-15-26-26D-3)	_____
97G	4.0 SPRING (2D-4-P-3LB)	_____
97M	4.0 SPRING (32-32D)	_____
RC1749 (4.0)		
99A	4.0 - RC1749 (10A-ABA-15-26-26D-3-4-L2)	_____
99G	4.0 - RC1749 (2D-4-P-3LB)	_____
RC1846 - RC1847 (4.0)		
9AA	4.0 - FRP BOX (3)	_____
9AG	4.0 - FRP BOX (2D-P)	_____
RC1846 - RC1847 (4.0)		
9BA	4.0 - FRP BULK (10A-10R-ABA-AN-1D-3-15-26D)	_____
9BG	4.0 - FRP BULK (2D-P)	_____
RC1843 (4.0)		
9DA	4.0 - SECURITY BOX (10A-ABA-AN-15-26D-3-10R-26)	_____
9DG	4.0 - SECURITY BOX (2D-4)	_____
RC1843 (4.0)		
9EA	4.0 - SECURITY BULK (10R-15-26-26D-3-ABA-AN)	_____
9EG	4.0 - SECURITY BULK (2D-P-3LB)	_____
OTHER GROUP CODES		
701	RESIDENTIAL BULK SCREWS	_____
780	RESIDENTIAL AUXILIARY	_____



Residential Hinges



Description	Finish	2018 List	Stock No.	Box Qty.	Case Qty.	Disc. Code	
1340 Machine Screws UM - Pack of 400	10-24 x 1/2" FPHM with #9 Head	USP	27.80	095782	1 pack	701	
		2D	27.80	095781			
		US3	27.80	095791			
		3LB	27.80	095792			
		US4	27.80	095795			
		ABA/US5	27.80	095796			
		US10A	27.80	095783			
		10R	27.80	095784			
		US15	27.80	095785			
		AN/US15A	27.80	095787			
	US26	27.80	095788				
	US26D	27.80	095789				
 1541 Solid Brass or Stainless Square Corner Full Mortise Residential Wt. Plain Bearing with Screws U/M - 1 each	3-1/2" x 3-1/2" (89 mm x 89 mm)	US3	12.60	030141	2 each	100 each	86A
		10R	12.60	032855			86A
		US15	12.60	031539			86A
		US32	12.85	030144			86M
		US32D	12.85	030146			86M
	4" x 4" (102 mm x 102 mm)	US3	14.65	030149	2 each	50 each	96A
		10R	14.65	033204			96A
		US15	14.65	035737			96A
		US32	14.90	030152			96M
		US32D	14.90	030153			96M
 BB1541 Stainless Square Corner Full Mortise Residential Wt. Ball Bearing with Screws U/M - 1 each	3-1/2" x 3-1/2" (89 mm x 89 mm)	US32D	16.75	034377	2 each	100 each	80M
	4" x 4" (102 mm x 102 mm)	US32D	18.50	034534	2 each	50 each	90M
 RC1541 Solid Brass or Stainless 1/4" Radius Round Corner Full Mortise Residential Weight Plain Bearing with Screws U/M - 1 each	3-1/2" x 3-1/2" (89 mm x 89 mm)	US3	12.60	030229	2 each	100 each	86A
		10R	12.60	034358			86A
		US15	12.60	033818			86A
		US26D	12.60	030227			86A
		US32D	12.85	030232			86M
	4" x 4" (102 mm x 102 mm)	US3	14.65	033004	2 each	50 each	96A
		10R	14.65	035343			96A
		US15	14.65	034837			96A
		US26D	14.65	033003			96A
		US32D	14.90	033008			96M
 RCBB1541 Stainless 1/4" Radius Full Mortise Residential Wt. Ball Bearing with Screws U/M - 1 each	3-1/2" x 3-1/2" (89 mm x 89 mm)	US32D	16.45	034378	2 each	100 each	80M
	4" x 4" (102 mm x 102 mm)	US32D	18.50	034587	2 each	50 each	90M





Description	Finish	2018 List	Stock No.	Box Qty.	Case Qty.	Disc. Code		
RC1542 Solid Brass or Stainless 5/8" Radius Round Corner Full Mortise Residential Wt. Plain Bearing with Screws U/M - 1 each	3-1/2" x 3-1/2" (89 mm x 89 mm)	US3	12.60	030276	2 each	100 each	86A	
		US4	12.60	030291			86G	
		10R	12.60	036081			86A	
		US15	12.60	035594			86A	
		US26D	12.60	030275			86A	
		US32	12.85	030288			86M	
		US32D	12.85	030289			86M	
		4" x 4" (102 mm x 102 mm)	US3	14.65	033051	2 each	50 each	96A
			10R	14.65	036761			96A
			US15	14.65	035743			96A
		US26D	14.65	033050			96A	
		US32	14.90	033053			96M	
		US32D	14.90	033056			96M	
RCBB1542 Stainless 5/8" Radius Round Corner Full Mortise Residential Wt. Ball Bearing with Screws U/M - 1 each	3-1/2" x 3-1/2" (89 mm x 89 mm)	US32D	16.45	034381	2 each	100 each	80M	
	4" x 4" (102 mm x 102 mm)	US32D	18.85	034589	2 each	50 each	90M	
1543 Solid Brass or Stainless Square by 5/8" Radius Full Mortise Residential Wt. Plain Bearing with Screws U/M - 1 each	4" x 4" (102 mm x 102 mm)	US3	14.65	071461	2 each	50 each	96A	
		10R	14.65	036911			96A	
		US15	14.65	071462			96A	
		US32D	14.90	071531			96M	
BB1543 Solid Brass or Stainless Square by 5/8" Radius Full Mortise Residential Wt. Ball Bearing with Screws U/M - 1 each	4" x 4" (102 mm x 102 mm)	US3	18.85	071637	2 each	50 each	90A	
		10R	18.85	036980			90A	
		US32D	18.50	071552			90M	
1734 Stainless Steel 1/4" Radius Round Corner Full Mortise Spring Hinge Template Timely Frame All MS 1/2 WS U/M - 1 each	4" x 4" (102 mm x 102 mm)	US32D	37.40	169906	2 each	80 each	97M	



1. Items with prices in **bold** are stock items and usually ship within 24 hours. Please use stock number when ordering.
 2. Minimum order quantity is one box unless otherwise noted.



Residential Hinges



Description	Finish	2018 List	Stock No.	Box Qty.	Case Qty.	Disc. Code				
1741 Steel Square Corner Full Mortise Residential Wt. Plain Bearing - with Screws U/M - 1 each	3" x 3" (76 mm x 76 mm)	USP	1.80	029648	2 each	100 each	81G			
		2D	1.80	029641			81G			
		US3	5.15	033133			81A			
		US10A	5.15	033129			81A			
		US26	5.15	033131			81A			
		US26D	5.15	033132			81A			
		3-1/2" x 3-1/2" (89 mm x 89 mm)	USP	1.80			029661	81G		
		1D	5.15	030556			81A			
		2D	1.80	029658			81G			
		US3	5.15	030533			81A			
		3LB	1.80	029660			81G			
		US4	1.80	029659			81G			
		ABA/US5	5.15	030552			81A			
		US10A	5.15	030548			81A			
		10R	5.15	037124			81C			
		US15	5.15	030555			81C			
		AN/US15A	5.15	030620			81A			
		US26	5.15	030547			81A			
		US26D	5.15	030551			81A			
4" x 4" (102 mm x 102 mm)	USP	2.65	029667	2 each	50 each	91G				
	1D	6.10	033144			91A				
	2D	2.65	029662			91G				
	US3	6.10	033148			91A				
	US4	2.65	029664			91G				
	ABA/US5	6.10	033197			91A				
	US10A	6.10	033141			91A				
	10R	6.10	038067			91C				
	US15	6.10	032829			91C				
	AN/US15A	6.10	033199			91A				
	US26	6.10	033145			91A				
	US26D	6.10	033146			91A				
	BB1741 Steel Square Corner Ball Bearing Hinges Full Mortise Residential Wt. with Screws U/M - 1 each	3-1/2" x 3-1/2" (89 mm x 89 mm)	US3			8.65	034274	2 each	100 each	82A
			US4			5.30	034337			82G
		ABA/US5	5.30	034332	82A					
		US10A	8.65	034330	82A					
		10R	8.65	040217	82A					
		US15	8.65	034333	82A					
		AN/US15A	8.65	034334	82A					
		US26	8.65	034275	82A					
		US26D	8.65	034329	82A					
		4" x 4" (102 mm x 102 mm)	2D	6.15	034500	2 each	50 each			92G
		US3	9.55	034474	92A					
		US4	6.15	034502	92G					
		ABA/US5	9.55	034497	92A					
	US10A	9.55	034483	92A						
	10R	9.55	040724	92A						
	US15	9.55	034498	92A						
	AN/US15A	9.55	034499	92A						
	US26	9.55	034477	92A						
	US26D	9.55	034482	92A						





Description	Finish	2018 List	Stock No.	Box Qty.	Case Qty.	Disc. Code
RC1741						
Steel	USP	1.80	029677	2 each	100 each	81G
	(76 mm x 76 mm)	2D	029673			81G
1/4" Radius	US3	5.15	033512			81A
Round Corner	US4	1.80	029675			81G
Full Mortise	ABA/US5	5.15	032869			81A
Residential Wt.	US26D	5.15	032859			81A
Plain Bearing with screws						
U/M - 1 each	3-1/2" x 3-1/2"	USP	1.80	029683	2 each	100 each
	(89 mm x 89 mm)	1D	030680			81A
		2D	029678			81G
		US3	5.15	030644		81A
		3LB	1.80	029475		81G
		US4	1.80	029681		81G
		ABA/US5	5.15	030648		81A
		US10A	5.15	030645		81A
		10R	5.15	041116		81C
		US15	5.15	030652		81C
		AN/US15A	5.15	030689		81A
		US26	5.15	030646		81A
		US26D	5.15	030647		81A
	4" x 4"	USP	2.65	029707	2 each	50 each
	(102 mm x 102 mm)	1D	6.10	032881		91A
		2D	2.65	029695		91G
		US3	6.10	033267		91A
		US4	2.65	029698		91G
		ABA/US5	6.10	033523		91A
		US10A	6.10	033514		91A
		10R	6.10	041269		91C
		US15	6.10	032876		91C
		AN/US15A	6.10	032882		91A
		US26	6.10	033262		91A
		US26D	6.10	033265		91A

1. Items with prices in **bold** are stock items and usually ship within 24 hours. Please use stock number when ordering.
 2. Minimum order quantity is one box unless otherwise noted.



Residential Hinges



Description	Finish	2018 List	Stock No.	Box Qty.	Case Qty.	Disc. Code	
RC1741 Steel 1/4" Radius Round Corner Full Mortise Residential Wt. Plain Bearing Bulk Assembled See style #2617 & #2817 for screws U/M - Each - Bulk	3-1/2" x 3-1/2" (89 mm x 89 mm)	USP	1.65	029477	-	100 each	83G
		1D	4.75	031633			83A
		2D	1.65	029472			83G
		US3	4.75	030706			83A
		3LB	1.65	029682			83G
		US4	1.65	029474			83G
		ABA/US5	4.75	030715			83A
		10R	4.75	041197			83C
		US15	4.75	030710			83C
		AN/US15A	4.75	030716			83A
		US26	4.75	030714			83A
		US26D	4.75	030708			83A
	4" x 4" (102 mm x 102 mm)	USP	2.35	029569	-	100 each	93G
		1D	5.60	032697			93A
		2D	2.35	029565			93G
		US3	5.60	033519			93A
		3LB	2.35	029568			93G
US4		2.35	029566			93G	
US10A		5.60	033600			93A	
10R		5.60	041270			93C	
US15		5.60	032877			93C	
AN/US15A		5.60	081352			93A	
US26		5.60	038957			93A	
US26D		5.60	033602			93A	
RCBB1741 Steel 1/4" Radius Round Corner Full Mortise Residential Wt. Ball Bearing with screws U/M - 1 each		3-1/2" x 3-1/2" (89 mm x 89 mm)	1D	8.65	079451	2 each	100 each
		US3	8.65	034346			82A
		US4	5.30	034361			82G
		ABA/US5	8.65	034352			82A
		10R	8.65	038241			82A
		US15	8.65	034353			82A
		AN/US15A	8.65	034355			82A
		US26	8.65	034348			82A
		US26D	8.65	034349			82A
	4" x 4" (102 mm x 102 mm)	1D	9.55	079453	2 each	50 each	92G
2D		6.15	034512			92G	
US3		9.55	034504			92A	
US4		6.15	034514			92G	
ABA/US5		9.55	034509			92A	
US10A		9.55	034508			92A	
10R		9.55	040073			92A	
US15		9.55	034510			92A	
AN/US15A		9.55	034511			92A	
US26		9.55	034506			92A	
US26D	9.55	034507			92A		



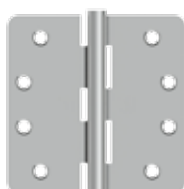

Description		Finish	2018 List	Stock No.	Box Qty.	Case Qty.	Disc. Code
1744	4" x 4"	USP	15.85	169928	2 each	80 each	97G
Steel	(102 mm x 102 mm)	2D	15.85	169912			97G
1/4" Radius		US3	25.95	169913			97A
Round Corner		US4	15.85	169915			97A
Full Mortise		ABA/US5	25.95	169917			97A
Residential Wt.		US10A	25.95	169907			97A
Spring Hinge		US26	25.95	169909			97A
Template		US26D	25.95	169911			97A
All MS - 1/2 WS							
U/M - 1 each							
RC1748	3-1/2" x 3-1/2"	2D	1.90	029724	2 each	100 each	88G
Steel	(89 mm x 89 mm)	US3	5.15	030693			88A
1/4" Radius		3LB	1.90	029726			88G
Round Corner		US4	1.90	029725			88G
Full Mortise		US10A	5.15	030698			88A
Residential Wt.		10R	5.15	016929			88A
Plain Bearing		US15	5.15	016936			88A
Template		US26D	5.15	030695			88A
All MS - 1/2 WS							
U/M - 1 each							
RC1749	4" x 4"	2D	3.90	029731	3 each	48 each	99G
Steel	(102 mm x 102 mm)	US3	6.10	033529			99A
1/4" Radius		3LB	3.90	029734			99G
Round Corner		US4	3.90	029732			99G
Full Mortise		ABA/US5	6.10	032889			99A
Residential Wt.		US10A	6.10	032887			99A
Plain Bearing		10R	6.10	016902			99A
Template		US15	6.10	016897			99A
AMS - 1/2 WS		US26	6.10	033524			99A
U/M - 1 each		US26D	6.10	033528			99A

1. Items with prices in **bold** are stock items and usually ship within 24 hours. Please use stock number when ordering.
 2. Minimum order quantity is one box unless otherwise noted.



Residential Hinges



Description	Finish	2018 List	Stock No.	Box Qty.	Case Qty.	Disc. Code			
1750 Steel Square Corner Full Mortise Residential Wt. Spring Hinge with Screws ALL WS U/M - 1 each	3-1/2" x 3-1/2" (89 mm x 89 mm)	USP	14.80	170018	2 each	80 each	87G		
	1D	19.70	169977	87G					
	2D	14.80	169982	87G					
	US3	19.70	169983	87A					
	3LB	14.80	169986	87G					
	US4	14.80	169985	87G					
	ABA/US5	19.70	169988	87A					
	US10A	19.70	169971	87A					
	10R	19.70	169973	87A					
	US15	19.70	169974	87A					
	AN/US15A	19.70	170017	87A					
	US26	19.70	169979	87A					
	US26D	19.70	169981	87A					
	4" x 4" (102 mm x 102 mm)	USP	15.85	170046			2 each	80 each	97G
	2D	15.85	170033	97G					
	US3	25.95	170035	97A					
	3LB	15.85	170037	97G					
US4	15.85	170040	97G						
ABA/US5	25.95	170043	97A						
US10A	25.95	170019	97A						
10R	25.95	170020	97A						
US15	25.95	170021	97A						
AN/US15A	25.95	170044	97A						
US26	25.95	170023	97A						
US26D	25.95	170031	97A						
1751 Steel 1/4" Radius Round Corner Full Mortise Residential Wt. Spring Hinge with Screws ALL WS U/M - 1 each	3-1/2" x 3-1/2" (89 mm x 89 mm)	USP	14.80	170220	2 each	80 each	87G		
	1D	19.70	170204	87A					
	2D	14.80	170206	87G					
	US3	19.70	170207	87A					
	US4	14.80	170215	87G					
	ABA/US5	19.70	170217	87A					
	US10A	19.70	170200	87A					
	10R	19.70	170202	87A					
	US15	19.70	170203	87A					
	AN/US15A	19.70	170218	87A					
	US26D	19.70	170205	87A					
	4" x 4" (102 mm x 102 mm)	USP	15.85	170239			2 each	80 each	97G
	1D	25.95	170226	97A					
	2D	15.85	170230	97G					
	US3	25.95	170233	97A					
	3LB	15.85	170234	97G					
	US4	15.85	170235	97G					
ABA/US5	25.95	170236	97A						
US10A	25.95	170223	97A						
10R	25.95	170224	97A						
US15	25.95	170225	97A						
AN/US15A	25.95	170237	97A						
US26	25.95	170228	97A						
US26D	25.95	170229	97A						





Description	Finish	2018 List	Stock No.	Box Qty.	Case Qty.	Disc. Code
1752						
Steel	USP	14.80	170428	2 each	80 each	87G
5/8" Radius	1D	19.70	170245			87A
Round Corner	2D	14.80	170418			87G
Full Mortise	US3	19.70	170419			87A
Residential Wt.	3LB	14.80	170420			87G
Spring Hinge with Screws	US4	14.80	170421			87G
ALL WS	ABA/US5	19.70	170423			87A
U/M - 1 each	US10A	19.70	170242			87A
	10R	19.70	170243			87A
	US15	19.70	170244			87A
	AN/US15A	19.70	170427			87A
	US26	19.70	170246			87A
	US26D	19.70	170417			87A
4" x 4"						
(102 mm x 102 mm)	USP	15.85	170480	2 each	80 each	97G
	1D	25.95	170453			97A
	2D	15.85	170457			97G
	US3	25.95	170458			97A
	3LB	15.85	170459			97G
	US4	15.85	170460			97G
	ABA/US5	25.95	170461			97A
	US10A	25.95	170430			97A
	10R	25.95	170451			97A
	US15	25.95	170452			97A
	AN/US15A	25.95	170479			97A
	US26	25.95	170454			97A
	US26D	25.95	170455			97A
1754						
Steel	USP	15.85	170494	2 each	80 each	97G
Square by 5/8" Radius	1D	25.95	170483			97G
Full Mortise	2D	15.85	170486			97G
Residential Wt.	US3	25.95	170487			97A
Spring Hinge with Screws	3LB	15.85	170488			97G
ALL WS	US4	15.85	170489			97A
U/M - 1 each	ABA/US5	25.95	170490			97G
	10R	25.95	170481			97A
	US15	25.95	170482			97A
	AN/US15A	25.95	170491			97A
	US26	25.95	170484			97A
	US26D	25.95	170485			97A
1760						
Stainless Steel	US32	37.40	170495	2 each	80 each	97M
Square Corner	US32D	37.40	170497			
Full Mortise						
Residential Wt.						
Spring Hinge with Screws						
ALL WS						
U/M - 1 each						



1. Items with prices in **bold** are stock items and usually ship within 24 hours. Please use stock number when ordering.
 2. Minimum order quantity is one box unless otherwise noted.



Residential Hinges



Description	Finish	2018 List	Stock No.	Box Qty.	Case Qty.	Disc. Code
1761 Stainless Steel 1/4" Radius Round Corner Full Mortise Residential Wt. Spring Hinge with Screws ALL WS U/M -1 each	4" x 4" (102 mm x 102 mm) US32 US32D	37.40 37.40	170513 170514	2 each	80 each	97M

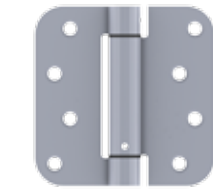

1762 Stainless Steel 5/8" Radius Round Corner Full Mortise Residential Wt. Spring Hinge with Screws ALL WS U/M - 1 each	4" x 4" (102 mm x 102 mm) US32 US32D	37.40 37.40	170515 170516	2 each	80 each	97M
--	---	----------------	------------------	--------	---------	-----



1764 Stainless Steel Square by 5/8" Radius Full Mortise Residential Wt. Spring Hinge with Screws ALL WS U/M - 1 each	4" x 4" (102 mm x 102 mm) US32 US32D	37.40 37.40	170517 170519	2 each	80 each	97M
--	---	----------------	------------------	--------	---------	-----



1816 Steel Square by 5/8" Radius Full Mortise Residential Wt. Plain Bearing Bulk Assembled Right Hand See style #2817 for Screws U/M - Each - Bulk	4" x 4" (102 mm x 102 mm)	USP	2.40	069042	-	100 each	93G
		1D	5.60	089461			93A
		2D	2.40	069009			93G
		US3	5.60	069142			93A
		3LB	2.40	069010			93G
		ABA/US5	5.60	069097			93A
		10R	5.60	041716			93C
		US15	5.60	069140			93C
		AN/US15A	5.60	069099			93A
		US26	5.60	069127			93A
	US26D	5.60	069134			93A	



BB1816 Steel Square by 5/8" Radius Full Mortise Residential Wt. Ball Bearing with screws Right Hand U/M - 1 each	4" x 4" (102 mm x 102 mm)	2D	6.15	069166	2 each	50 each	92G
		US3	9.55	070306			92A
		US4	6.15	070312			92G
		ABA/US5	9.55	070258			92A
		US10A	9.55	070188			92A
		10R	9.55	041717			92A
		US15	9.55	070289			92A
		AN/US15A	9.55	070273			92A
		US26D	9.55	070311			92A



Description	Finish	2018 List	Stock No.	Box Qty.	Case Qty.	Disc. Code	
1817	4" x 4"	USP	2.40	070416	-	100 each	93G
Steel	(102 mm x 102 mm)	1D	5.60	089462			93A
Square by 5/8" Radius		2D	2.40	070403			93G
Full Mortise		US3	5.60	070496			93A
Residential Wt.		3LB	2.40	070417			93G
Plain Bearing		ABA/US5	5.60	070445			93A
Bulk Assembled Left Hand		10R	5.60	041719			93C
See style #2817 for Screws		US15	5.60	070459			93C
U/M - Each - Bulk		AN/US15A	5.60	070453			93A
		US26D	5.60	070476			93A



BB1817	4" x 4"	2D	6.15	070498	2 each	50 each	92G
Steel	(102 mm x 102 mm)	US3	9.55	070604			92A
Square by 5/8" Radius		US4	6.15	070612			92G
Full Mortise		ABA/US5	9.55	070534			92A
Residential Wt.		10R	9.55	041720			92A
Ball Bearing with screws		US15	9.55	070562			92A
Left Hand		AN/US15A	9.55	070556			92A
U/M - 1 each		US26D	9.55	070580			92A



1818	4" x 4"	USP	3.45	070634	-	100 each	9EG
Steel	(102 mm x 102 mm)	2D	3.45	070619			9EG
Square by 5/8" Radius		3LB	3.45	070665			9EG
Full Mortise		10R	7.60	095609			9EG
Residential Wt.		US15	7.60	070745			9EA
Plain Bearing		AN/US15A	7.60	070738			9EA
Bulk Assembled Right Hand		US26D	7.60	070767			9EA
Safety Stud							
See style #2817 for screws							
U/M - Each - Bulk							



1819	4" x 4"	USP	3.45	070900	-	100 each	9EG
Steel	(102 mm x 102 mm)	2D	3.45	070835			9EG
Square by 5/8" Radius		3LB	3.45	070922			9EG
Full Mortise		10R	7.60	095611			9EA
Residential Wt.		US15	7.60	070942			9EA
Plain Bearing		US26D	7.60	070971			9EA
Bulk Assembled Left Hand							
Safety Stud							
See style #2817 for screws							
U/M - Each - Bulk							

1. Items with prices in **bold** are stock items and usually ship within 24 hours. Please use stock number when ordering.
 2. Minimum order quantity is one box unless otherwise noted.



Residential Hinges



Description	Finish	2018 List	Stock No.	Box Qty.	Case Qty.	Disc. Code	
RC1841 Steel 5/8" Radius Round Corner Full Mortise Residential Wt. Plain Bearing Bulk Assembled with Screws See style #2617 & #2817 for screws U/M - Each - Bulk	3-1/2" x 3-1/2" (89 mm x 89 mm)	USP	1.65	027745	-	100 each	83G
	1D	4.75	030728			83A	
	2D	1.65	027355			83G	
	US3	4.75	030718			83A	
	3LB	1.65	027360			83G	
	US4	1.65	027526			83G	
	ABA/US5	4.75	030724			83A	
	US10A	4.75	030721			83A	
	10R	4.75	042004			83C	
	US15	4.75	030727			83C	
	AN/US15A	4.75	030842			83A	
	US26	4.75	030719			83A	
	US26D	4.75	030720			83A	
	4" x 4" (102 mm x 102 mm)	USP	2.40	028287	-	100 each	93G
		1D	5.60	033643			93A
		2D	2.40	027771			93G
		US3	5.60	033308			93A
3LB		2.40	027995			93G	
US4		2.40	027996			93G	
ABA/US5		5.60	033537			93A	
US10A		5.60	033533			93A	
10R		5.60	042005			93C	
US15		5.60	032893			93C	
AN/US15A		5.60	033565			93A	
US26		5.60	033535			93A	
US26D		5.60	033307			93A	
RC1842 Steel 5/8" Radius Round Corner Full Mortise Residential Wt. Plain Bearing with screws U/M - 1 each		3-1/2" x 3-1/2" (89 mm x 89 mm)	USP	1.80	029759	2 each	100 each
	1D	5.15	030857			81A	
	2D	1.80	029756			81G	
	US3	5.15	030851			81A	
	3LB	1.80	029847			81G	
	US4	1.80	029757			81G	
	ABA/US5	5.15	030853			81A	
	US10A	5.15	030843			81A	
	10R	5.15	042009			81C	
	US15	5.15	030856			81C	
	AN/US15A	5.15	030859			81A	
	US26	5.15	030845			81A	
	US26D	5.15	030846			81A	
	4" x 4" (102 mm x 102 mm)	USP	2.65	029774	2 each	50 each	91G
		1D	6.10	032899			91A
		2D	2.65	029769			91G
		US3	6.10	033312			91A
3LB		2.65	029771			91G	
US4		2.65	029770			91G	
ABA/US5		6.10	033313			91A	
US10A		6.10	033309			91A	
10R		6.10	042010			91C	
US15		6.10	032898			91C	
AN/US15A		6.10	033314			91A	
US26		6.10	033310			91A	
US26D		6.10	033311			91A	









Description	Finish	2018 List	Stock No.	Box Qty.	Case Qty.	Disc. Code			
RCBB1842 Steel 5/8" Radius Round Corner Full Mortise Residential Wt. Ball Bearing with screws U/M - 1 each	3-1/2" x 3-1/2" (89 mm x 89 mm)	1D	8.65	084215	2 each	100 each	82A		
		US3	8.65	034363			82A		
		3LB	5.30	034375			82G		
		US4	5.30	034374			82G		
		ABA/US5	8.65	034367			82A		
		US10A	8.65	034366			82A		
		10R	8.65	042006			82A		
		US15	8.65	034370			82A		
		AN/US15A	8.65	034371			82A		
		US26	8.65	034364			82A		
		US26D	8.65	034365			82A		
	4" x 4" (102 mm x 102 mm)	1D	9.55	084231			2 each	50 each	92A
		2D	6.15	034526			92G		
		US3	9.55	034515			92A		
		3LB	6.15	034528			92G		
US4		6.15	034527	92G					
ABA/US5		9.55	034520	92A					
US10A		9.55	034519	92A					
10R		9.55	042007	92A					
US15		9.55	034523	92A					
AN/US15A		9.55	034524	92A					
US26		9.55	034516	92A					
US26D		9.55	034518	92A					
RC1843 Steel 5/8" Radius Round Corner Full Mortise Residential Wt. Plain bearing with screws Safety Stud U/M - 1 each	4" x 4" (102 mm x 102 mm)	2D	3.40	033648	2 each	50 each	9DG		
		US3	7.60	033649	9DA				
		3LB	3.40	081897	9DG				
		US4	3.40	081896	9DG				
		ABA/US5	7.60	036149	9DA				
		US10A	7.60	081890	9DA				
		10R	7.60	042014	9DA				
		US15	7.60	081894	9DA				
		AN/US15A	7.60	081898	9DA				
		US26	7.60	081895	9DA				
		US26D	7.60	037158	9DA				
RC1843 Steel 5/8" Radius Round Corner Full Mortise Residential Wt. Bulk Assembled with screws See style #2817 Safety Stud U/M - Each - Bulk	4" x 4" (102 mm x 102 mm)	USP	3.45	033589	-	100 each	9EG		
		2D	3.45	033588	9EG				
		US3	7.60	037028	9EA				
		ABA/US5	7.60	126538	9EA				
		10R	7.60	129302	9EA				
		US15	7.60	126539	9EA				
		AN/US15A	7.60	126540	9EA				
		US26	7.60	126536	9EA				
		US26D	7.60	126537	9EA				
	RC1846 Steel 5/8" Radius Round Corner Full Mortise Residential Wt. Plain Bearing with screws Riveted Pin U/M - 1 each	4" x 4" (102 mm x 102 mm)	2D	3.85	033651	2 each	50 each	9AG	
		US3	9.95	033844	9AA				
		US26D	9.95	033843	9AA				

1. Items with prices in **bold** are stock items and usually ship within 24 hours. Please use stock number when ordering.
2. Minimum order quantity is one box unless otherwise noted.



Residential Hinges

	Description	Finish	2018 List	Stock No.	Box Qty.	Case Qty.	Disc. Code	
	RC1846	4" x 4" (102 mm x 102 mm)	USP	3.85	029580	-	100 each	9BG
	Steel		2D	3.85	029576			9BG
	5/8" Radius		US3	7.10	037092			9BA
	Round Corner		3LB	3.85	029579			9BG
	Full Mortise		US4	3.85	029578			9BG
	Residential Wt.		10R	7.10	042015			9BA
	Plain Bearing		US15	7.10	081371			9BA
	Bulk assembled with screws		AN/US15A	7.10	081370			9BA
	See style #2817 for screws		US26	7.10	084250			9BA
	Riveted Pin		US26D	7.10	083473			9BA
	U/M - Each - Bulk		1D	7.10	082049			9BA
	RC1847	4" x 4" (102 mm x 102 mm)	USP	3.85	033658	2 each	50 each	9AG
	Steel		2D	3.85	033654			9AG
	Square by 5/8" Radius		US3	9.95	037777			9AA
	Full Mortise							
	Residential Wt.							
	Plain Bearing with screws							
	Riveted Pin							
	U/M - 1 each							
	RC1847	4" x 4" (102 mm x 102 mm)	USP	3.85	033590	-	100 each	9BG
	Steel		2D	3.85	033594			9BG
	Square by 5/8" Radius		US3	7.10	084253			9BA
	Full Mortise		ABA/US5	7.10	084254			9BA
	Residential Wt.		US10A	7.10	084255			9BA
	Bulk Assembled with screws		10R	7.10	042017			9BA
	See style #2817 for screws		US15	7.10	084258			9BA
	Riveted Pin		AN/US15A	7.10	084259			9BA
	U/M - Each - Bulk		US26D	7.10	084261			9BA
	1848	4" x 4" (102 mm x 102 mm)	US3	6.10	068746	2 each	50 each	91A
	Steel		ABA/US5	6.10	067438			91A
	Unassembled		US10A	6.10	068789			91A
	Square by 5/8" Radius		10R	6.10	042019			91C
	Full Mortise		US15	6.10	068735			91C
	Residential Wt.		AN/US15A	6.10	068713			91A
	Plain Bearing with screws		US26D	6.10	068734			91A
	U/M - 1 each							
	2617	#9 x 3/4" FPHS	USP	35.40	035459	1 pack	10 packs	701
	Screws for Residential Hinges		1D	35.40	034111			
	UM - Pack of 600		2D	35.40	034108			
			3LB	35.40	029794			
			US3	35.40	034109			
			US4	35.40	029793			
			ABA/US5	35.40	033323			
			US10A	35.40	033320			
			10R	35.40	042098			
			US15	35.40	033321			
			AN/US15A	35.40	033324			
			US26	35.40	033322			
		US26D	35.40	034110				



Description	Finish	2018 List	Stock No.	Box Qty.	Case Qty.	Disc. Code	
2817 Screws for Residential Hinges UM - Pack of 800	#9 x 3/4" FPHS	USP	47.20	033385	1 pack	10 packs	701
		1D	47.20	034124			
		2D	47.20	034129			
		3LB	47.20	039796			
		US3	47.20	033384			
		US4	47.20	029795			
		ABA/US5	47.20	034126			
		US10A	47.20	034303			
		10R	47.20	042099			
		US15	47.20	034302			
		AN/US15A	47.20	034123			
		US26	47.20	033327			
		US26D	47.20	033329			
	#9 X 1" FPHS	USP	51.05	033386	1 pack	10 packs	701
1D		51.05	037331				
2D		51.05	035480				
3LB		51.05	029798				
US3		51.05	033387				
US4		51.05	029797				
ABA/US5		51.05	035550				
US10A		51.05	035461				
10R		51.05	042100				
US15		51.05	036448				
AN/US15A		51.05	035556				
US26		51.05	035582				
US26D		51.05	033388				
#9 x 2-1/2" FPHS		USP	67.45	048598	1 pack	-	701
#10 x 2-1/2" FPHS	2D	67.45	048601	1 pack	-	701	
7741 Steel 1/4" Radius Round Corner Full Mortise Residential Wt. Plain Bearing See style #2617 & #2817 for screws Bulk Unassembled with pins U/M - Each - Bulk	3-1/2" x 3-1/2" (89 mm x 89 mm)	2D	1.65	029502	-	100 each	83G
		3LB	1.65	029508			83G
		US4	1.65	029504			83G
		10R	4.75	021624			83C
		US15	4.75	050813			83C
		AN/US15A	4.75	050817			83A
		US26	4.75	030864			83A
		US26D	4.75	030867			83A
	4" x 4" (102 x 102 mm)	2D	2.35	029585	-	100 each	93G
		US3	5.60	033751			93A
		3LB	2.35	029603			93G
		US4	2.35	029586			93G
		10R	5.60	015750			93C
		US15	5.60	050204			93C
	AN/US15A	5.60	051297			93A	
	US26	5.60	033750			93A	
	US26D	5.60	075057			93A	



1. Items with prices in **bold** are stock items and usually ship within 24 hours. Please use stock number when ordering.
 2. Minimum order quantity is one box unless otherwise noted.



Residential Hinges

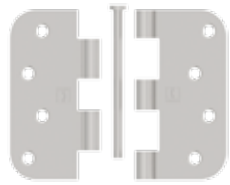

Description	Finish	2018 List	Stock No.	Box Qty.	Case Qty.	Disc. Code	
8741 Steel 5/8" Radius Round Corner Full Mortise Residential Wt. Plain Bearing Bulk Unassembled with pins See style #2617 & #2817 for screws U/M - Each - Bulk	3-1/2" x 3-1/2" (89 mm x 89 mm)	USP 1.65	029500	-	100 each	83G	
		2D 1.65	029486			83G	
		3LB 1.65	029497			83G	
		US4 4.75	029490			83G	
		ABA/US5 4.75	030964			83A	
		10R 4.75	175354			83A	
		US15 4.75	030953			83C	
		US26D 4.75	030962			83A	
		4" x 4" (102 mm x 102 mm)	2D 2.40	029621	-	100 each	93G
		US4 2.40	029622			93G	
	10R 5.60	066186			93C		
	US15 5.60	066183			93C		
	US26D 5.60	035794			93A		
8744 Steel Square by 5/8" Radius Full Mortise Residential Wt. Plain Bearing Bulk Unassembled with pins See style #2817 for screws U/M - Each - Bulk	4" x 4" (102 mm x 102 mm)	USP 2.40	029639	-	100 each	93G	
		2D 2.40	029630			93G	
		US3 5.60	036142			93A	
		3LB 2.40	039636			93G	
		US4 5.60	029631			93G	
		US10A 5.60	084235			93A	
		10R 5.60	042101			93C	
		US15 5.60	080130			93C	
		AN/US15A 5.60	084237			93A	
		US26D 5.60	036148			93A	
8746 Steel Square by 5/8" Radius Full Mortise Residential Wt. Plain Bearing Safety Stud Bulk Unassembled with pins See style #2817 for screws U/M - Each - Bulk	4" x 4" (102 mm x 102 mm)	USP 3.45	068828	-	100 each	9EG	
		2D 3.45	068819			9EG	
		US4 3.45	068989			9EG	
		ABA/US5 7.60	068910			9EA	
		US15 7.60	068929			9EA	
		US26D 7.60	038964			9EA	
		10R 7.60	195609			9EA	
		1D 7.60	195610			9EA	
		3-1/2" (89 mm)	2D 0.65	038152	100 each	1000 each	900
		US15 0.65	038173				
	US26D 0.65	038174					
1700 Pins for Residential Wt. Plain Bearing Hinges Sold full box qty U/M - 1 Each	4" (102 mm)	2D 0.65	038153	100 each	1000 each	900	
		US15 0.65	038166				
		US26D 0.65	038175				





Description		Finish	2018 List	Stock No.	Box Qty.	Case Qty.	Disc. Code
1710	3-1/2" (89 mm)	US3	10.80	042118	10 packs	100 packs	780
Hinge Tip Kit		US4	10.80	058503			
2 Ball Tips in Solid Brass with 1		ABA/US5	10.80	058500			
Stainless Steel Pin for One		US10A	10.80	058506			
Residential Wgt.		10R	10.80	097381			
HingeU/M - Pack of 1 each		US15	10.80	037713			
		AN/US15A	10.80	037940			
		US26	10.80	058559			
		US26D	10.80	058502			
	4" (102 mm)	US3	10.80	042129	10 packs	100 packs	780
		US4	10.80	058965			
		ABA/US5	10.80	058957			
		US10A	10.80	058973			
		10R	10.80	097383			
		US15	10.80	037848			
		AN/US15A	10.80	037905			
		US26	10.80	058974			
		US26D	10.80	058960			
1720	3-1/2" (89 mm)	US3	10.80	042134	10 packs	100 packs	780
Hinge Tip Kit		US4	10.80	058577			
2 Steeple Tips in Solid Brass		ABA/US5	10.80	058579			
with 1 Stainless Steel Pin for		10R	10.80	097693			
One Residential Wgt. Hinge		US15	10.80	038014			
U/M - Pack of 1 each		US26	10.80	058575			
	4" (102 mm)	US3	10.80	042132	10 packs	100 packs	780
		US4	10.80	059010			
		10R	10.80	097385			
		US15	10.80	038419			
		AN/US15A	10.80	037996			
		US26	10.80	058989			



1. Items with prices in **bold** are stock items and usually ship within 24 hours. Please use stock number when ordering.
 2. Minimum order quantity is one box unless otherwise noted.





One Family. One Brand. One Vision.™

www.hagerco.com

TABLE OF CONTENTS

	A			M
ANSI Standards.....		2	Mortar Box.....	11
	B			P
Bearing at Top.....		12	Painted Cover Channels.....	6
Bearing Replacement Kit.....		13	Polished Cover Channels.....	6
	C			Q
Cancellation Notification		2	Quick Connect.....	9
Center Punches		13	Quick Ship.....	2
Concealed Electric Hinges with Lead Wire.....		7-10		R
Concealed Electric Monitoring (EMN).....		7-10	Replacement Moldings	11
Concealed Electric Through-Wire (ETW).....		7-10		S
Concealed Electric Through-Wire - Removable (RETW)		7-10	Shim Stock.....	14
Concealed Electric Through-Wire and Monitoring (ETM)		7-10	Shipping Cartons	14
Custom Hole Pattern		12	Short Hinges.....	12
	D		Special Anodizing	6
Dutch Door Prep.....		13	Special Cover Channels.....	5
	E		Special Finished Hinges.....	6
Electric Power Transfer Preparation (EPT).....		9	Special Holes	6
Electrical Modifications		7-10	Special Lengths	3
Exposed Electric Contacts (E).....		7-10	Special Products.....	3
Exposed Electric Switches (EIS).....		7-10	Standard Finishes.....	3
Extra Long Hinges.....		12	Standard Lengths.....	3
Power Transfer Preparation		9		T
	F		Tamper Resistant Hinge.....	13
Fasteners.....		14	Template Hinges.....	3
Field Modifications.....		3		
Fire Ratings		4		
	H			
Hinges				
Concealed.....		15, 16, 18-22, 23, 25-26, 28		
Full Surface.....		15, 18, 22-24, 27		
Half Surface		15-18, 22, 24, 27		
Hospital Tip.....		12		
How To Order		2		
	L			
Lead Times		2		
Length Specifications.....		3		



Roton Continuous Hinges

HOW TO ORDER:

Example: 780-112HDFFUL 119" CLR 1 PK
Stock Number: 184038
Item Number: YS 1121190CLR000001 Rev. S



INTRODUCTION

Hager Roton hinges are unique, aluminum geared hinges developed to outperform most other entrance components because the weight of the door is distributed along the full length of the door frame.

Roton continuous hinges have been utilized in hospitals, schools, hotels, offices, airports, stadiums, storefronts, and commercial and industrial buildings in new construction and retrofit applications for over 30 years.

Hager Roton continuous geared hinges are designed for superior performance. Because of this, we offer our lifetime warranty with confidence.

ANSI Standards

- 780 Series Roton continuous geared hinges are approved per ANSI A156.26 Grade 1 for 150 lb. doors
- 780 Series Roton heavy duty hinges are approved per ANSI A156.26 Grade 1 for 300 lb. doors
- 780-111, 780-112, 780-124HD, 780-224, 780-226 standard duty and heavy duty Roton continuous geared hinges are Warnock-Hersey certified in accordance with ANSI A250.13 2003 Standard Severe Windstorm Resistant Components.



Lead Times

Stock items will typically ship in five working days or less from the order entry date. Made-to-order items will typically ship in 15 working days depending on seasonal volume and order complexity. Special orders including industrials, special machining, and large quantities may need to be scheduled. The anticipated ship date will be included with each order acknowledgement. Please contact Customer Service if product availability is in question.

Quick Ship

Products denoted with **red and bold** pricing are available to order through the Quick Ship program and ship within 24 hours. When ordering these products please visit www.hagerco.com and log in to MyHager to access the 'Quick Ship' portal. Due to the promptness of the fulfillment process, Quick Ship orders are non-cancellable.

Cancellation Notification

Cancellation for made to order items must be completed within 48 hours of order placement.



Standard Lengths

Roton hinges are listed and priced as actual lengths 79" (6'8" opening), 83" (7'0" opening), 85" (7'2" opening), 95" (8'0" opening), and 119" (10'0" opening) for convenience in application to nominal sized doors. Actual length provides for threshold clearance, head clearance and door height allowances for carpeting. Other lengths may be ordered as non-standard items.

Special Lengths

Should a non-standard length be required, please price as the next standard length. (For example, if 86" length is required, use 95" list price.)

Length Specifications

If special lengths to match the actual net door heights are required, please indicate this clearly on your order. A special length should be specified from the net door height, not the nominal height of the opening. To order specify: "Actual Length", or "Net Door Height". Use pricing for the next longer standard length from which the special length can be manufactured. For example, hinges 86-3/4" long will be invoiced at the 95" price.

Field Modifications

While Roton hinges can be cut in the field, any product modifications may void all warranties. Should in-the-field modifications be required, cut only from bottom of hinge. Do not cut through bearings or screw holes. When cutting electric hinges it is extremely important to clamp both hinge leaves securely to prevent hinge "chatter" which can damage the hinge's internal wiring. Consult the St. Louis sales office before proceeding.

Template Hinges

Hager has developed templated hole patterns for Roton hinge models in standard lengths. Drawings are available upon request by contacting Hager Customer Service or accessing the Hager website at www.hagerco.com.

Due to normal variances inherent in the manufacturing process, Roton custom length hinges are deemed by Hager to be non-templated.

Standard Finishes

Roton hinges are available in clear anodized satin aluminum (similar to US28), dark bronze and black exterior anodized coating.

Special Products

A special product is any product not listed in the price book in regard to length, finish, standard hole preparation or leaf combinations not illustrated. Orders for special products are encouraged, but any changes or cancellations on special orders may result in charges related to work performed and/or material loss. Under no circumstance will non-stock or make-to-order products be accepted for return unless due to Hager error.



Roton Continuous Hinges

FIRE RATINGS - UNDERWRITERS LABORATORY FIRE RATING FILE #A14627



780 Series Roton continuous geared hinges with stainless steel studs are approved for use on 4'x10' metal or wood swing type doors. 780 Series Roton continuous geared hinges without stainless steel studs are approved for use on 4'x8' single swing metal doors and 4'x10' single swing wood doors used without stainless steel studs limited to 20 minute fire rating without hose stream.

- Hollow metal, tin-clad, sheet-metal and steel covered composite type rated up to and including 3 hours
- Wood composite doors rated up to and including 1-1/2 hours
- Wood core doors rated up to 20 minutes without hose stream, non-studded
- 780 Series Roton Continuous Geared Hinges meet requirements for positive pressure UL10C, UL10B and UBC7-2 Part 1

UL10C Fire Rated Roton	Fully Concealed	Full Surface	Half Surface	NOTES: 1. All Roton hinges will be marked with UL stamp if they are fire-rated. 2. Several hinge models cannot be fire-rated. Check each profile. 3. Models that require studs have an extra charge. Four studs are required for UL stud hinges. Add to the hinge list price before applying buying group discount - add \$56.80.
20 Minute Fire Rated Wood Core Door x Fire Rated Hollow Metal Frame	UL — FF STANDARD			
20 Minute Fire Rated Metal Door x Fire Rated Hollow Metal Frame	UL — FF STANDARD			
30 Minute Fire Rated Wood Composite Door x Fire Rated Hollow Metal Frame	UL — FF STANDARD			
30 Minute Fire Rated Metal Door x Fire Rated Hollow Metal Frame	UL — FF STANDARD			
45 Minute Fire Rated Wood Composite Door x Fire Rated Hollow Metal Frame	UL — FF STANDARD			
45 Minute Fire Rated Metal Door x Fire Rated Hollow Metal Frame	UL — FF STANDARD			
60 Minute Fire Rated Wood Door x Hollow Metal Frame	UL — FF STANDARD			
60 Minute Fire Rated Metal Door x Hollow Metal Frame	UL — FF STANDARD			
90 Minute Fire Rated Metal Door x Fire Rated Hollow Metal Frame	UL — FF STANDARD			
90 Minute Fire Rated Wood Composite Door x Fire Rated Hollow Metal Frame	UL — STUD REQUIRED * Must Specify			
3 Hour Fire Rated Metal Door x Fire Rated Hollow Metal Frame	UL — STUD REQUIRED * Must Specify			

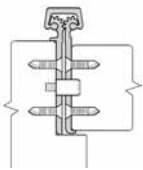

FULLY CONCEALED WITH STUD

Fully Concealed

These models are concealed between the frame and the hinge edge of the door. Models available include: 780-041HD, 780-041LL, 780-111, 780-111HD, 780-111LL, 780-112, 780-112HD, 780-112LL, 780-124HD, 780-124LL, 780-224, 780-224HD, 780-224LL, 780-226, 780-226HD, 780-226LL, and 780-235HD.

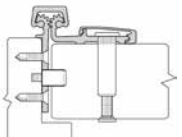

HALF SURFACE WITH STUD

Half Surface

These models have the frame leaf concealed between the frame and the edge of the door. The door leaf is mounted to the door with thru-bolts or screws. Models available include: 780-045HD, 780-046HD, 780-053, 780-053HD, 780-054HD, and 780-211HD.

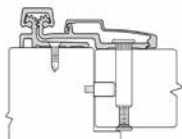

FULL SURFACE WITH STUD

Full Surface

These models have the frame leaf mounted to the face of the frame and the face of the door. The door leaf is mounted to the face of the door with thru-bolts. Models available include: 780-057HD, 780-157, 780-157HD, 780-210, 780-210HD, and 780-257HD.



MODIFICATIONS & ADDITIONS

Special Cover Channels

Rounded back cover channels may be ordered. Availability for hinges with electrical modifications vary.

Please consult the St. Louis sales office for confirmation. Add to the hinge list price before applying buying group discount:

Round Back Cover Channels

Clear Anodized

79", 83", 85" **\$25.40**

95" **\$31.50**

119" **\$40.55**

Bronze Anodized

79", 83", 85" **\$50.70**

95" **\$56.75**

119" **\$64.90**

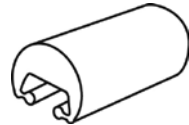

Round Back

Note: Special cover channels available in clear, dark bronze and black finish.

Roton Cover Channel Compatibility		
Hinge Model	Flat FBCC	Round RBCC
750-134	•	•
750-138	•	•
780-041	•	•
780-045	•	•
780-046	•	•
780-053	•	•
780-054	•	•
780-057	•	•
780-110	•	•
780-111	•	•
780-112	•	•
780-113	•	•
780-114	•	•
780-124	•	•
780-155	•	•
780-157	•	
780-208	•	
780-210	•	•
780-211	•	•
780-213	•	•
780-224	•	•
780-226	•	•
780-235	•	•
780-257	•	
780-259	•	•
780-300	•	



Roton Continuous Hinges

MODIFICATIONS & ADDITIONS

ADDITION TO LIST PRICE

Bone White Painted Cover Channels

For hinges 79", 83" and 85" in length

\$60.90

For hinges 95" in length

\$83.10

For hinges 119" in length

\$123.60

Roton cover channels are offered in bone white as a standard stock color option. This is only available on the standard Roton cover channel and should be ordered as bone white paint # UC43350.

Polished Cover Channels

CLEAR

GOLD

For hinges 79" in length

\$60.90

\$83.10

For hinges 83" in length

\$60.90

\$83.10

For hinges 85" in length

\$60.90

\$83.10

For hinges 95" in length

\$83.10

\$103.30

For hinges 119" in length

\$122.55

\$141.80

Any hinge may be ordered with a polished clear cover channel (similar to US26) to complement clear anodized hinge leaves or a polished gold cover channel (similar to US3) to complement satin gold hinge leaves.

Special Finished Hinges

Price on Application

Hager Companies can supply unfinished material to selected finishers for special projects that require unusual colors, but will require that final assembly be complete by Hager Companies. Because of special non-removable metal coatings applied to all hinges during assembly, users are cautioned against attempting to refinish any Roton product.

Cannot paint 500 or 1200 series hinges.

Special Anodizing

Add 15% to the DBA hinges for black and gold

Roton hinges are available in various special colors including Black, Gold, and other special anodized finishes with fasteners to match. Example, specify "Black Anodized" or "Gold Anodized." All hinges ordered in special colors should be ordered at the same time to guarantee finish uniformity.

Other anodized colors by quotation only. Supply color chip for best match.

Special Holes

Price on Application

Any hinge may be ordered with special hole locations for unusual frame or door locations. Please provide specification for each leaf.



ELECTRICAL MODIFICATIONS

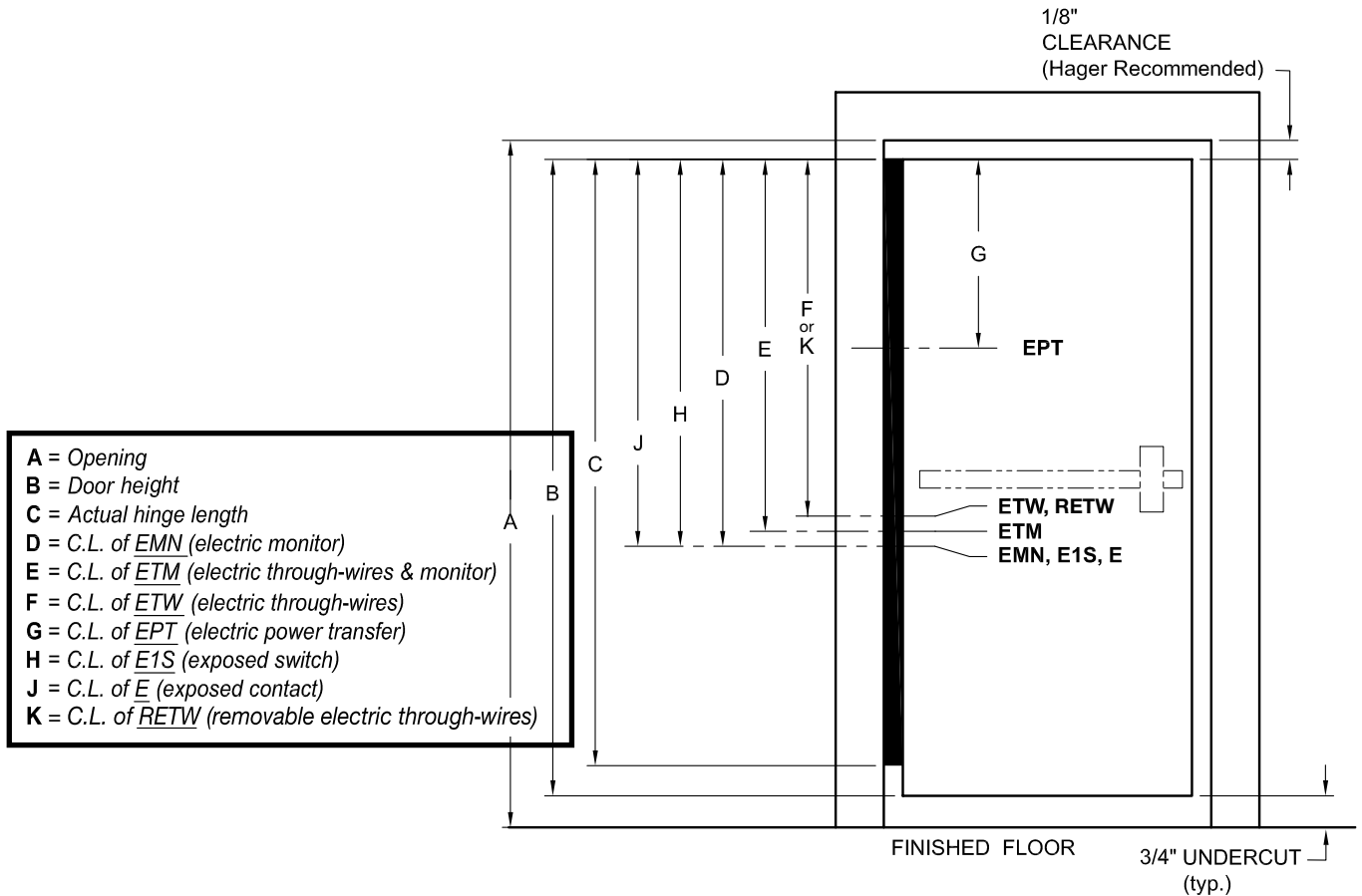

For ease of ordering, Hager Companies has established standard locations for power transfer cutouts. All standard location dimensions are referenced from the top edge of the door to the centerline of the power transfer cutout. Please specify handing.

NOTE: These locations are for concealed hinges only.

	Opening	Door Height	Actual Hinge Length	EMN	ETM	ETW	EPT	E1S	E	RETW
79 SD	80"	79-1/8"	79"	40-3/4"	42-3/4"	40-3/4"	34-3/8"	42-1/2"	42-1/2"	-
79 HD	80"	79-1/8"	79"	40-3/4"	43-3/8"	40-3/4"	34-3/8"	42-1/2"	42-1/2"	43-3/8"
83 SD	84"	83-1/8"	83"	45-5/16"	44-3/4"	45-5/16"	36-3/8"	46-1/2"	46-1/2"	-
83 HD	84"	83-1/8"	83"	45-5/16"	45-3/8"	45-5/16"	36-3/8"	46-1/2"	46-1/2"	45-3/8"
85 SD	86"	85-1/8"	N/A	N/A	N/A	N/A	N/A	N/A	N/A	N/A
85 HD	86"	85-1/8"	85"	46-5/16"	46-3/8"	46-5/16"	37-3/8"	48-1/2"	48-1/2"	46-3/8"
95 SD	96"	95-1/8"	95"	56-3/8"	55-13/16"	56-3/8"	47-1/2"	59-3/4"	59-3/4"	-
95 HD	96"	95-1/8"	95"	56-3/8"	56-1/2"	56-3/8"	47-1/2"	59-3/4"	59-3/4"	56-1/2"
119 SD	120"	119-1/8"	N/A	N/A	N/A	N/A	N/A	N/A	N/A	N/A
119 HD	120"	119-1/8"	119"	81-1/4"	81-5/16"	81-1/4"	72-5/16"	83-3/4"	83-3/4"	81-5/16"

SD = Standard Duty HD = Heavy Duty



Roton Continuous Hinges

ELECTRICAL MODIFICATIONS (CONTINUED)

	Electric Power Transfer Preparation (EPT)	Exposed Electric Contacts	Exposed Electric Switches	Concealed Electric Through-Wire	Concealed Electric Monitoring	Concealed Electric Through-Wire and Monitoring	Removable Electric Through-Wire
Part Number	EPT	E	E1S	ETW	EMN	ETM	RETW
780-045HD	•						
780-046HD	•						
780-053	•						
780-053HD	•						
780-054HD	•						
780-057HD				•			•
780-110HD			•				
780-111	•	•	•	•	•	•	
780-111HD	•	•	•	•	•	•	•
780-111LL	•	•	•	•	•	•	
780-112	•	•	•	•	•	•	
780-112HD	•	•	•	•	•	•	•
780-112LL	•	•	•	•	•	•	
780-124HD	•	•	•	•	•	•	•
780-124LL	•	•	•	•	•	•	
780-157				•			•
780-224	•	•	•	•	•	•	
780-224HD	•	•	•	•	•	•	•
780-224LL	•	•	•	•	•	•	
780-226HD	•	•	•	•	•	•	•
780-226LL	•	•	•	•	•	•	
780-235HD				•			
1200-600	•			•			
1200-650	•			•			



MODIFICATIONS & ADDITIONS

ADDITION TO LIST PRICE

Quick Connect

\$45.60

Available for ETM, ETW, and RETW options. Top and bottom knockouts for standard conduit fittings.

Concealed Electric Monitoring (EMN)

\$268.40

- Miniature switch is incorporated into the frame leaf.
- Specify handing and the dimension from the top edge of the door to the centerline of the electric monitoring location.
- Special Electric Modifications and EPT locations may require additional charges if screw holes have to be moved.
- Templates regarding location of monitoring switch available upon request.

Concealed Electric Through-Wire and Monitoring (ETM)

- Electric Preparation

ETM-4	\$535.70
ETM-6	\$584.40
ETM-8	\$621.80
ETM-10	\$662.25

- All ETM have 28-Gauge continuous conductors.
- This combines the continuous electric conductors and the miniature switch to provide both power transfer and monitoring.
- Miniature switch is incorporated into the frame leaf.
- Specify handing and the dimension from the top edge of the door to the centerline of each electric modification location.
- Templates regarding location of monitoring switch available upon request.

Concealed Electric Through-Wire (ETW)

- Electric Preparation

ETW-4	\$268.40
ETW-6	\$311.95
ETW-8	\$349.40
ETW-10	\$398.00
ETW-12	\$445.40

- All ETW have 28-Gauge continuous conductors.
- 12" per side required as a suffix.
- Cut out for prep - 1/2" drilled hole.
- Transfers power discreetly from building to door hardware.
- Specify handing and the dimension from the top edge of the door to the centerline of the electric through-wire location.
- Special electric modifications and EPT locations may require additional charges if screw holes have to be moved. Contact Hager Customer Service for charges.
- Templates regarding location of through-wires available upon request.

Available on the following Roton Concealed profiles:

- | | | | | |
|-------------|-------------|-------------|-------------|--------------|
| • 780-057HD | • 780-112HD | • 780-157HD | • 780-226HD | • 1200-600HD |
| • 780-111HD | • 780-124HD | • 780-224HD | • 780-235HD | • 1200-650HD |

Power Transfer or Electric Power Transfer Preparation (EPT)

Concealed Leaf	\$104.40
Half Surface	\$62.90

- Hinge leaf cutout to accommodate power transfer device.
- Specify handing and the dimension from the top edge of the door to the **centerline** of the power transfer location.
- Special Electric Modifications and EPT locations may require additional charges if screw holes have to be moved.



Roton Continuous Hinges

MODIFICATIONS & ADDITIONS

ADDITION TO LIST PRICE

Lead Wire for Concealed Electric Hinges

Electric Preparation

	Per Foot
4-wire hinge	\$9.25
6-wire hinge	\$13.50
8-wire hinge	\$16.80
10-wire hinge	\$19.05

- Standard wire leads are 12" per side
- Additional wire leads are available

Exposed Electric Switches (E1S)

\$93.80

- Miniature push button switch incorporated in hinge frame leaf to monitor position of the door.
- Three 12" wire leads.
- Each monitoring hinge only needs one E1S Switch.
- Specify handing and the dimension from the top edge of the door to the centerline of the electric switch location.
- Templates regarding location of contact switch available upon request.

Exposed Electric Contacts (E)

\$93.80

- Transfers power to door in closed position.
- Must have at least two (2) contacts to transfer power.
- Specify handing and the dimension from the top edge of the door to the centerline of the electric contact location.
- Templates regarding location of contacts available upon request.

Removable Electric Through-Wire (RETW) Twelve Wire

\$651.45

Removable 12 Wire Module Only

\$265.65

Component	Finish
7-102-1870	Clear
7-112-1872	Dark Bronze
7-112-1876	Gold
7-112-1881	Black

Removable Electric Through-Wire (RETW) Ten Wire

\$552.10

Removable 10 Wire Module Only

\$214.90

Component	Finish
7-102-1860	Clear
7-112-1870	Dark Bronze
7-112-1875	Gold
7-112-1880	Black



Available on heavy duty concealed profiles:

- 780-057HD • 780-112HD • 780-157HD • 780-226HD
- 780-111HD • 780-124HD • 780-224HD

- Transfers power discreetly from building to door hardware.
- Removable ETW module can be easily removed for adjustment for service.
- Templates regarding location of monitoring switch available upon request.
- Specify handing and the dimension from the top edge of the door to the centerline of the electric through-wire location.

MODIFICATIONS & ADDITIONS

Mortar Box - 430

\$45.55

- Serves as a mortar shield.
- Overall dimensions: 9" (229 mm) length with tabs, 7" (178 mm) inside, 1-3/4" x 1-3/4" (45 mm x 45 mm) inside dimension.
- Galvanized steel 0.040" (1 mm)

**Replacement Molding
780-052M**

Hinge Lengths

79", 83", 85"
95"
119"

Clear Anodized

\$38.60
\$44.60
\$53.25

Dark Bronze Anodized

\$44.60
\$53.25
\$61.80

Replacement door leaf molding for: 780-053, 780-053HD, 780-054HD, 780-155HD, 780-057HD, 780-157, 780-157HD, 780-257HD, and 780-259HD.

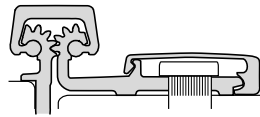

**Replacement Molding
780-210M**

Hinge Lengths

79", 83", 85"
95"
119"

Clear Anodized

\$40.60
\$50.20
\$58.80

Dark Bronze Anodized

\$50.20
\$58.80
\$66.45

Replacement door leaf molding for: 780-210, 780-210HD, 780-211, 780-211HD, 780-213HD, 780-045HD, and 780-046HD.

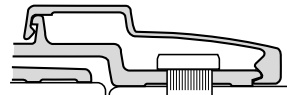

**Replacement Molding
780-247M**

Hinge Lengths

79", 83", 85"
95"
119"

Clear Anodized

\$34.50
\$40.60
\$50.20

Dark Bronze Anodized

\$40.60
\$50.20
\$58.80

Replacement frame leaf molding
780-157, 780-157HD, 780-257HD

Note: Replacement moldings for 780-052M and 780-210M are shipped in stock lengths for trimming in the field and furnished with Allen head set screw and wrench.

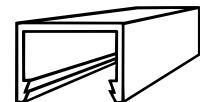
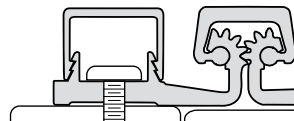

Roton Continuous Hinges

MODIFICATIONS & ADDITIONS

ADDITION TO LIST PRICE

Short Hinges

\$22.30

Hinges shorter than 79" will be invoiced at the 79" price. Where two or more short hinges can be obtained from a standard length, pricing is based on the number of standard lengths utilized plus an assembly charge for each hinge.

Extra Long Hinges

\$97.50

Hinges over 119" are manufactured as two separate lengths with a staggered joint for on-site connection. Hinge segments are taken from standard sizes for best economics in relation to the quantity required. Handing specifications are required to position the cuts inconspicuously and to finish symmetrical pairs in double door applications.

Custom Hole Pattern

Price on Application

Any hinge may be ordered with special hole locations for unusual frame or door conditions. Please provide specifications for each leaf.

Bearing At Top

\$41.50

This application allows for the bearing to be set at the very top of the cover channel. The cover channel is flush with the top of the geared hinge, preventing any obstructions or debris from being inserted in the top of the channel.

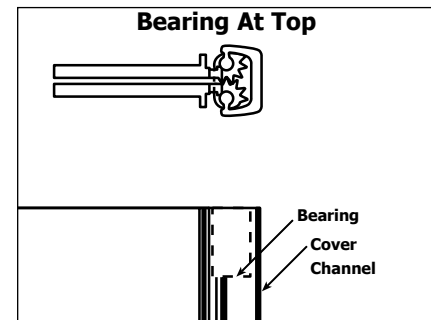

Hospital Tip

\$122.50

Concealed models only can be prepared with a cover channel tapered at 45° angle at the top of the hinge. These are ideal for use in hospitals and correctional facilities to help provide a clean and safe environment.

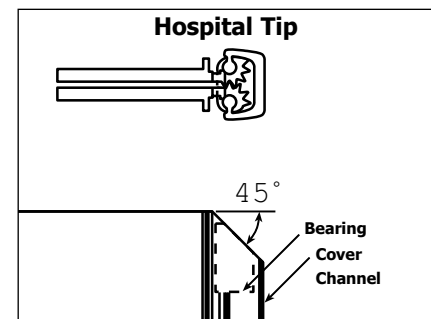

MODIFICATIONS & ADDITIONS

ADDITION TO LIST PRICE

Tamper Resistant Hinge

\$143.80

This application is intended for use in hospital psychiatric areas and places of high security. The hinge is **prepared with a hospital tip** (concealed models only) and every other bearing is supplied with a set screw to lock against the inside of the cover channel for additional security. Torx screws available at additional charge (see page 14).

Dutch Door Prep

\$85.15

Furnished as continuous frame leaf, whole door leaf is cut to fit dutch door specified length.

Bearing Replacement Kit

Part Numbers

Clear and Dark Bronze

Standard Duty for 780 Series

7-070-0121

\$43.65

Heavy Duty for 780 Series

7-070-0122

\$83.10

Extra Heavy Duty for 1200 Series

7-070-0123

\$165.15

Center Punches

Part Numbers

\$9.25

Self-Centering center punches are available for #12 countersunk screws supplied. To make sure screw heads seat properly, accurate center punching is required.

7-070-0031

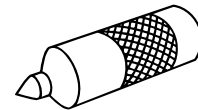

Roton Continuous Hinges

MODIFICATIONS & ADDITIONS

ADDITION TO LIST PRICE

Shim Stock

1/16" x 1-1/2" Wide x 7' Long

\$32.00 each

1/8" x 1-1/2" Wide x 7' Long

\$44.60 each

Larger sizes available

Price on application

For clearance between the door and frame which may be excessive, a continuous shim is helpful (applied behind the frame leaf only). Anodized aluminum extrusions are supplied with no holes.

Shipping Carton

\$22.30 each

Extra shipping cartons are available for reshipping hinges in quantities of 2 or less.

Fasteners

All hinges are shipped with appropriate fasteners for metal doors and frames except where noted. **If wood screws are required, please specify on order, and wood screws will be substituted at no extra charge.** Bulk screws are packed separately.

Description	Part Numbers		
	Clear	Dark Bronze	
#12 x 1-1/2" Flat Head Wood Screw	7-080-0050	7-080-0051	\$247.30/box of 500
#12-24 x 11/16" Self-Drilling Flat Head Screw	7-080-0070	7-080-0072	\$221.10/box of 500
#12-24 x 1/2" Spanner Head Machine Screw			\$2.00 each
#12-24 x 11/16" Drill Quick Torx Screw			\$2.00 each
#12-24 x 13/32" Self-Threading Screw (Clear or Bronze)			\$0.80 each
#12-24 x 11/16" Self-Drilling Flat Head Screw (Clear or Bronze)			\$1.10 each
#12-24 x 11/16" Self-Drilling Pan Head Screw (Clear)			\$1.10 each
#12 x 1-1/2" Flat Head Wood Screw (Clear or Bronze)			\$1.10 each
#12 - 14 x 1-1/2" Wood Torx Screw			\$1.95 each
Sexbolts			\$2.95 each

Note: Additional fasteners may be ordered as follows (add to the hinge list price before applying buying group discount).

Roton Continuous Geared Hinges

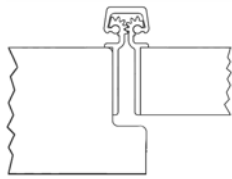

Description		Finish	2018 List	Stock No.	Case Qty.
500-048 Concealed Leaf With Sheet Metal Screws 1-1/6" Nominal Leaf Thickness	24" (610 mm)	Clear	71.70	068560	1
		Dark Bronze	95.50	068046	
	36" (914 mm)	Clear	81.20	068521	1
		Dark Bronze	107.50	067971	
	48" (1219 mm)	Clear	95.50	068520	1
		Dark Bronze	119.40	067970	
	72" (1829 mm)	Clear	119.40	068509	1
		Dark Bronze	143.30	067969	

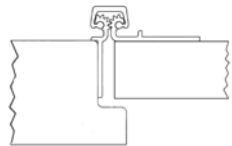

500-200 Half Surface With Sheet Metal Screws 1-1/6" Nominal Leaf Thickness	24" (610 mm)	Clear	71.70	067967	1
		Dark Bronze	95.50	067559	
	36" (914 mm)	Clear	83.60	067964	1
		Dark Bronze	107.50	067431	
	48" (1219 mm)	Clear	95.50	067961	1
		Dark Bronze	119.40	-	
	72" (1829 mm)	Clear	119.40	067959	1
		Dark Bronze	143.30	067266	

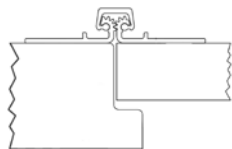

500-220 Full Surface With Sheet Metal Screws 1-1/6" Nominal Leaf Thickness	24" (610 mm)	Clear	71.70	067944	1
		Dark Bronze	95.50	-	
	36" (914 mm)	Clear	83.60	067940	1
		Dark Bronze	107.50	067009	
	48" (1219 mm)	Clear	95.50	067939	1
		Dark Bronze	119.40	067001	
	72" (1829 mm)	Clear	119.40	067938	1
		Dark Bronze	143.30	067000	

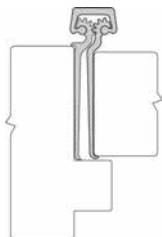

750-134 Concealed Leaf With Half Drill Quick and Half Wood Screws 1-3/4" Interior Wood Door	79" (2007 mm)	Clear	154.50	194853	8
	83" (2108 mm)	Clear	154.50	194855	8
	85" (2159 mm)	Clear	154.50	194859	8
	95" (2413 mm)	Clear	196.50	194861	8
	119" (3023 mm)	Clear	304.10	194863	6

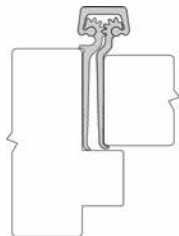

750-138 Concealed Leaf With Half Drill Quick and Half Wood Screws 1-3/8" Interior Wood Door	79" (2007 mm)	Clear	157.20	194890	8
	83" (2108 mm)	Clear	157.20	194897	8
	85" (2159 mm)	Clear	157.20	194909	8
	95" (2413 mm)	Clear	192.30	-	8
	119" (3023 mm)	Clear	296.60	-	8

1. Items with the price in **bold and red** are Quick Ship items and ship in 24 hours.
Please use stock number when ordering. 2. U/M is each unless otherwise noted.



Roton Continuous Geared Hinges

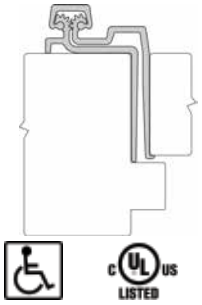

Description		Finish	2018 List	Stock No.	Case Qty.
780-041HD Concealed Leaf Heavy Duty 1-3/4" Door Swing Clear Action	79" (2007 mm)	Clear	362.40	194918	6
		Dark Bronze	481.00	194919	
		Black	533.20	-	
	83" (2108 mm)	Clear	362.40	194803	6
		Dark Bronze	481.00	194920	
		Black	533.20	-	
	85" (2159 mm)	Clear	362.40	194921	6
		Dark Bronze	481.00	194923	
		Black	533.20	-	
	95" (2413 mm)	Clear	449.20	194805	6
		Dark Bronze	591.70	194924	
		Black	680.40	-	
	119" (3023 mm)	Clear	670.50	194925	2
		Dark Bronze	881.90	194926	
		Black	1,014.20	024432	

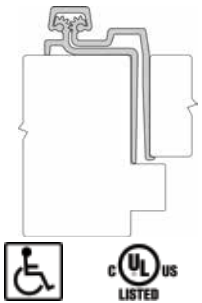

780-041LL Concealed Leaf With Half Drill Quick and Half Wood Screws 1-3/4" Door Lead Lined Heavy Duty Profile Only Swing Clear Action	79" (2007 mm)	Clear	376.90	187432	6
		Dark Bronze	493.00	-	
		Black	567.00	-	
	83" (2108 mm)	Clear	376.90	194928	6
		Dark Bronze	493.00	-	
		Black	567.00	-	
	85" (2159 mm)	Clear	376.90	-	6
		Dark Bronze	493.00	-	
		Black	567.00	-	
	95" (2413 mm)	Clear	461.30	194929	6
		Dark Bronze	603.70	-	
		Black	694.30	-	
	119" (3023 mm)	Clear	681.50	-	2
		Dark Bronze	894.00	-	
		Black	1,028.10	-	

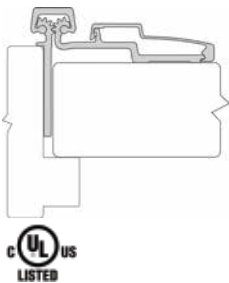

780-045HD Half Surface Heavy Duty	79" (2007 mm)	Clear	429.70	004046	4
		Dark Bronze	574.40	-	
		Black	660.60	-	
	83" (2108 mm)	Clear	429.70	065575	4
		Dark Bronze	574.40	152230	
		Black	660.60	-	
	85" (2159 mm)	Clear	429.70	161260	4
		Dark Bronze	574.40	165869	
		Black	660.60	-	
	95" (2413 mm)	Clear	528.20	104689	4
		Dark Bronze	706.50	168059	
		Black	812.40	-	
	119" (3023 mm)	Clear	786.90	163204	2
		Dark Bronze	1,051.00	161207	
		Black	1,028.70	-	



Roton Continuous Geared Hinges

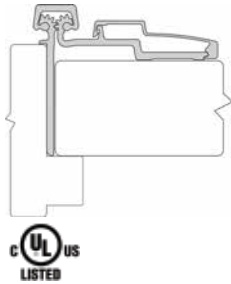

Description	Finish	2018 List	Stock No.	Case Qty.		
780-046HD Half Surface Heavy Duty	79" (2007 mm)	Clear	462.50	163916	4	
		Dark Bronze	606.70	-		
		Black	697.70	-		
	83" (2108 mm)	Clear	462.50	026032	4	
		Dark Bronze	606.70	149561		
		Black	697.70	-		
	85" (2159 mm)	Clear	462.50	158054	4	
		Dark Bronze	606.70	-		
		Black	697.70	-		
79" (2007 mm)	Clear	567.10	025211	4		
		754.10	162657			
		867.20	-			
	119" (3023 mm)	Clear	847.20	-	2	
			1,122.70	-		
			1,291.10	-		
	780-053 Half Surface	79" (2007 mm)	Clear	224.80	056995	5
			Dark Bronze	309.10	163993	
			Black	355.40	-	
83" (2108 mm)		Clear	224.80	001927	5	
			Dark Bronze	309.10	014876	
			Black	355.40	-	
95" (2413 mm)		Clear	278.50	010247	5	
			Dark Bronze	376.70	009044	
			Black	433.20	-	
780-053HD Half Surface Heavy Duty	79" (2007 mm)	Clear	282.00	013612	5	
		Dark Bronze	353.70	082818		
		Black	406.80	-		
	83" (2108 mm)	Clear	282.00	194998	5	
			Dark Bronze	353.70	194999	
			Black	406.80	-	
	85" (2159 mm)	Clear	282.00	050663	5	
			Dark Bronze	353.70	132585	
			Black	406.80	-	
	95" (2413 mm)	Clear	349.90	195004	5	
			Dark Bronze	423.90	018393	
			Black	487.50	-	
	119" (3023 mm)	Clear	535.60	052397	3	
			Dark Bronze	715.00	093628	
			Black	822.30	-	

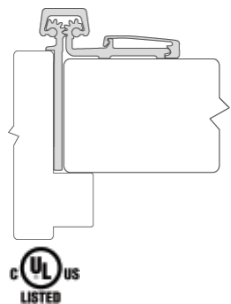
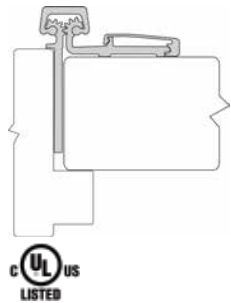

1. Items with the price in **bold and red** are Quick Ship items and ship in 24 hours.
Please use stock number when ordering. 2. U/M is each unless otherwise noted.



Roton Continuous Geared Hinges

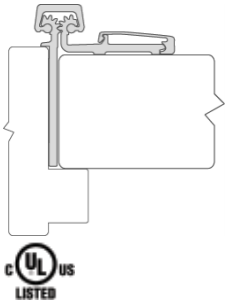

Description		Finish	2018 List	Stock No.	Case Qty.
780-054HD Half Surface Heavy Duty	79" (2007 mm)	Clear	308.00	021269	5
		Dark Bronze	378.80	131605	
		Black	435.60	-	
	83" (2108 mm)	Clear	308.00	195052	5
		Dark Bronze	378.80	027437	
		Black	435.60	-	
	85" (2159 mm)	Clear	308.00	078989	5
		Dark Bronze	378.80	071971	
		Black	435.60	-	
	95" (2413 mm)	Clear	380.80	078992	5
		Dark Bronze	450.50	071970	
		Black	518.00	-	
	119" (3023 mm)	Clear	585.80	026627	3
		Dark Bronze	756.10	159983	
		Black	869.50	-	



780-057HD Full Surface Heavy Duty Bi-Fold Applications	79" (2007 mm)	Clear	329.00	021238	5
		Dark Bronze	464.60	017850	
		Black	534.30	-	
	83" (2108 mm)	Clear	329.00	007856	5
		Dark Bronze	464.60	025973	
		Black	534.30	-	
	85" (2159 mm)	Clear	329.00	025846	5
		Dark Bronze	464.60	174835	
		Black	534.30	-	
	95" (2413 mm)	Clear	418.30	024478	5
		Dark Bronze	575.20	094331	
		Black	661.50	-	
	119" (3023 mm)	Clear	623.50	088469	4
		Dark Bronze	856.70	165568	
		Black	985.20	-	

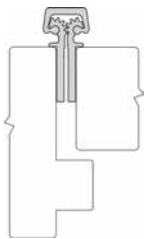

780-110HD Concealed Leaf Heavy Duty For 1" to 1-3/8" door	79" (2007 mm)	Clear	209.20	009945	8
		Dark Bronze	270.30	127036	
		Black	310.80	-	
	83" (2108 mm)	Clear	209.20	009549	8
		Dark Bronze	270.30	006241	
		Black	310.80	-	
	85" (2159 mm)	Clear	209.20	044312	8
		Dark Bronze	270.30	173953	
		Black	310.80	-	
	95" (2413 mm)	Clear	251.40	100893	8
		Dark Bronze	325.80	161122	
		Black	374.70	-	
	119" (3023 mm)	Clear	398.20	158984	7
		Dark Bronze	522.90	169966	
		Black	601.40	-	

Roton Continuous Geared Hinges

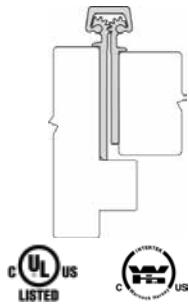

Description		Finish	2018 List	Stock No.	Case Qty.
780-111 Concealed Leaf	79" (2007 mm)	Clear	163.40	194809	8
		Dark Bronze	211.10	194810	
		Black	242.75	-	
	83" (2108 mm)	Clear	163.40	184007	8
		Dark Bronze	211.10	184008	
		Black	242.75	-	
	95" (2413 mm)	Clear	199.10	184031	8
		Dark Bronze	258.90	184048	
		Black	297.70	-	

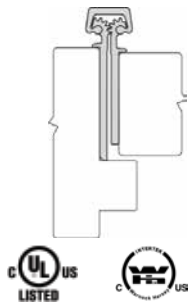

780-111HD Concealed Leaf Heavy Duty	79" (2007 mm)	Clear	203.30	183917	8
		Dark Bronze	265.50	194812	
		Black	305.40	-	
	83" (2108 mm)	Clear	203.30	183924	8
		Dark Bronze	265.50	183988	
		Black	305.40	116592	
	85" (2159 mm)	Clear	203.30	194814	8
		Dark Bronze	265.50	194815	
		Black	305.40	-	
	95" (2413 mm)	Clear	246.80	184025	8
		Dark Bronze	319.20	194816	
		Black	367.10	109310	
	119" (3023 mm)	Clear	394.40	194817	7
		Dark Bronze	513.60	194819	
		Black	590.60	113845	

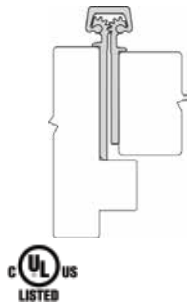

780-111LL Concealed Leaf With Half Drill Quick and Half Wood Screws Lead Lined Heavy Duty Profile Only	79" (2007 mm)	Clear	220.00	194848	8
		Dark Bronze	279.60	-	
		Black	321.60	-	
	83" (2108 mm)	Clear	220.00	195079	8
		Dark Bronze	279.60	195080	
		Black	321.60	-	
	85" (2159 mm)	Clear	220.00	-	8
		Dark Bronze	279.60	-	
		Black	321.60	-	
	95" (2413 mm)	Clear	261.50	195088	8
		Dark Bronze	333.20	195089	
		Black	383.20	-	
	119" (3023 mm)	Clear	405.00	-	7
		Dark Bronze	528.20	-	
		Black	607.50	-	

1. Items with the price in **bold and red** are Quick Ship items and ship in 24 hours.
Please use stock number when ordering. 2. U/M is each unless otherwise noted.



Roton Continuous Geared Hinges

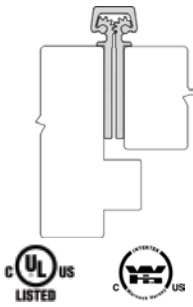

Description		Finish	2018 List	Stock No.	Case Qty.
780-112 Concealed Leaf Single Pack w/ Drill Quick Screws	79" (2007 mm)	Clear	137.60	183922	8
		Dark Bronze	177.70	194822	
		Black	204.40	-	
	83" (2108 mm)	Clear	137.60	184001	8
		Dark Bronze	177.70	184003	
		Black	204.40	-	
	95" (2413 mm)	Clear	168.50	184032	7
		Dark Bronze	221.90	184033	
		Black	255.20	-	

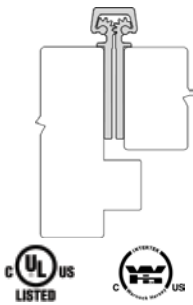

780-112 Concealed Leaf Case Pack w/ Drill Quick Screws Must Order Case Quantity	83" (2108 mm)	Clear	123.80	184009	8
		Dark Bronze	160.00	184010	
		Black	184.00	-	

780-112HD Concealed Leaf Single Pack w/ Drill Quick Screws	79" (2007 mm)	Clear	170.90	183881	8
		Dark Bronze	220.80	194826	
		Black	253.90	-	
	83" (2108 mm)	Clear	170.90	183926	8
		Dark Bronze	220.80	183932	
		Black	253.90	-	
	85" (2159 mm)	Clear	170.90	184011	8
		Dark Bronze	220.80	184013	
		Black	253.90	-	
95" (2413 mm)	Clear	205.90	184020	7	
	Dark Bronze	271.50	184021		
	Black	312.20	-		
119" (3023 mm)	Clear	331.20	184038	7	
	Dark Bronze	436.40	194827		
	Black	501.90	-		

780-112HD Concealed Leaf Case Pack w/ Drill Quick Screws Must Order Case Quantity	83" (2108 mm)	Clear	156.40	194828	8
		Dark Bronze	198.80	194829	
		Black	228.60	-	

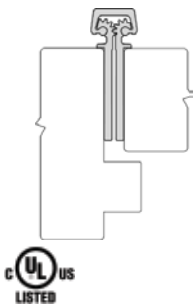

780-112LL Concealed Leaf With Half Drill Quick and Half Wood Screws Lead Lined Heavy Duty Profile Only	79" (2007 mm)	Clear	188.50	195090	8
		Dark Bronze	246.40	-	
		Black	283.40	-	
	83" (2108 mm)	Clear	188.50	195091	8
		Dark Bronze	246.40	195092	
		Black	283.40	-	
	85" (2159 mm)	Clear	188.50	195093	8
		Dark Bronze	246.40	-	
		Black	283.40	-	
95" (2413 mm)	Clear	229.30	195094	8	
	Dark Bronze	294.00	195095		
	Black	338.60	-		
119" (3023 mm)	Clear	365.80	195096	7	
	Dark Bronze	478.00	-		
	Black	549.70	-		

1. Items with the price in **bold and red** are Quick Ship items and ship in 24 hours.
Please use stock number when ordering. 2. U/M is each unless otherwise noted.

Roton Continuous Geared Hinges

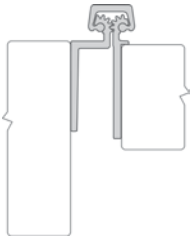

Description	Finish	2018 List	Stock No.	Case Qty.	
780-113HD Concealed Leaf Heavy Duty "Safety Hinge" When Used Without Frame Stop	79" (2007 mm)	Clear	346.00	195097	6
		Dark Bronze	465.20	195098	
		Black	535.00	-	
	83" (2108 mm)	Clear	346.00	195099	6
		Dark Bronze	465.20	195100	
		Black	535.00	-	
	85" (2159 mm)	Clear	346.00	195101	6
		Dark Bronze	465.20	195102	
		Black	535.00	-	
95" (2413 mm)	Clear	567.10	195103	6	
	Dark Bronze	636.80	195104		
	Black	732.30	-		
119" (3023 mm)	Clear	703.80	195105	4	
	Dark Bronze	831.90	-		
	Black	956.70	-		

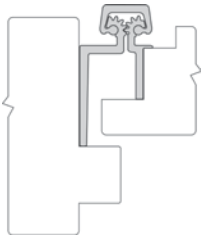

780-114HD Concealed Leaf Heavy Duty Center Hung Applications	79" (2007 mm)	Clear	343.20	195106	5
		Dark Bronze	454.60	195108	
		Black	522.80	-	
	83" (2108 mm)	Clear	343.20	195109	5
		Dark Bronze	454.60	195110	
		Black	522.80	-	
	85" (2159 mm)	Clear	343.20	195111	5
		Dark Bronze	454.60	-	
		Black	522.80	-	
95" (2413 mm)	Clear	422.30	195112	5	
	Dark Bronze	557.70	195113		
	Black	641.40	-		
119" (3023 mm)	Clear	628.80	-	3	
	Dark Bronze	831.20	-		
	Black	955.90	-		

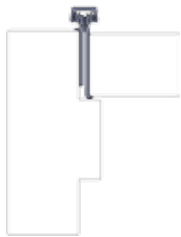

780-124HD Concealed Leaf Heavy Duty profile only Single Pack w/ Drill Quick Screws	79" (2007 mm)	Clear	173.70	194831	8
		Dark Bronze	226.20	194832	
		Black	260.20	-	
	83" (2108 mm)	Clear	173.70	183991	8
		Dark Bronze	226.20	194834	
		Black	260.20	140988	
	85" (2159 mm)	Clear	173.70	194835	8
		Dark Bronze	226.20	-	
		Black	260.20	-	
95" (2413 mm)	Clear	210.10	194836	7	
	Dark Bronze	252.50	194837		
	Black	290.40	-		
119" (3023 mm)	Clear	341.40	194838	7	
	Dark Bronze	447.40	-		
	Black	514.50	-		



1. Items with the price in **bold and red** are Quick Ship items and ship in 24 hours.
Please use stock number when ordering. 2. U/M is each unless otherwise noted.

4/1/2018
www.hagerco.com



Roton Continuous Geared Hinges

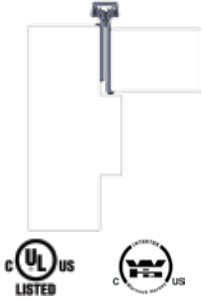

Description		Finish	2018 List	Stock No.	Case Qty.
780-124LL Concealed Leaf Heavy Duty profile only With half drill quick and Half Wood Screws Lead Lined	79" (2007 mm)	Clear	195.90	-	8
		Dark Bronze	252.50	-	
		Black	290.40	-	
	83" (2108 mm)	Clear	195.90	195114	8
		Dark Bronze	252.50	-	
		Black	290.40	-	
	85" (2159 mm)	Clear	195.90	-	8
		Dark Bronze	252.50	-	
		Black	290.40	-	
	95" (2413 mm)	Clear	235.30	-	7
		Dark Bronze	296.90	-	
		Black	341.50	-	
	119" (3023 mm)	Clear	373.70	-	7
		Dark Bronze	484.80	-	
		Black	557.50	-	
780-155HD Half Surface Heavy Duty Center Hung and Egress Conversions	79" (2007 mm)	Clear	363.40	016603	5
		Dark Bronze	489.30	128736	
		Black	562.80	-	
	83" (2108 mm)	Clear	363.40	068088	5
		Dark Bronze	489.30	068371	
		Black	562.80	-	
	85" (2159 mm)	Clear	363.40	018276	5
		Dark Bronze	489.30	046665	
		Black	562.80	-	
	95" (2413 mm)	Clear	445.90	063096	5
		Dark Bronze	603.30	056566	
		Black	693.80	-	
	119" (3023 mm)	Clear	663.60	078745	2
		Dark Bronze	896.90	062632	
		Black	1,031.40	-	
780-157 Full Surface Frame Face Dimension Limitations	79" (2007 mm)	Clear	211.60	022092	5
		Dark Bronze	285.80	049196	
		Black	328.70	-	
	83" (2108 mm)	Clear	211.60	048049	5
		Dark Bronze	285.80	063070	
		Black	328.80	-	
	95" (2413 mm)	Clear	258.70	021262	5
		Dark Bronze	349.10	009045	
		Black	401.40	-	

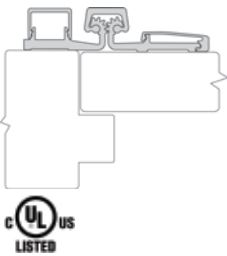
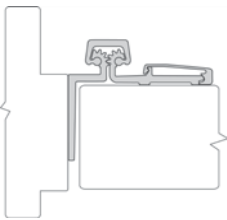

Roton Continuous Geared Hinges

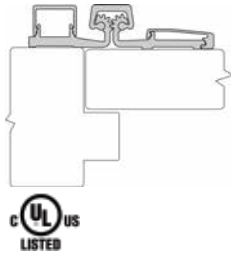

Description	Finish	2018 List	Stock No.	Case Qty.	
780-157HD Full Surface Heavy Duty Frame Face Dimension Limitations	79" (2007 mm)	Clear	262.20	022028	5
		Dark Bronze	319.70	084386	
		Black	367.70	-	
	83" (2108 mm)	Clear	262.20	048059	5
		Dark Bronze	319.70	062422	
		Black	367.70	-	
	85" (2159 mm)	Clear	262.20	019546	5
		Dark Bronze	319.70	035156	
		Black	367.70	-	
	95" (2413 mm)	Clear	314.60	048060	5
		Dark Bronze	384.10	010547	
		Black	441.70	-	
119" (3023 mm)	Clear	521.40	099644	2	
	Dark Bronze	678.80	037141		
	Black	780.60	-		

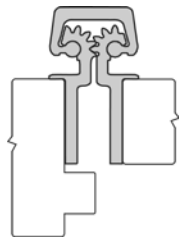

780-208HD Concealed Leaf Heavy Duty Bi-Fold Applications	79" (2007 mm)	Clear	249.50	195187	7
		Dark Bronze	319.80	195188	
		Black	367.70	-	
	83" (2108 mm)	Clear	249.50	195189	7
		Dark Bronze	319.80	-	
		Black	367.70	-	
	85" (2159 mm)	Clear	249.50	195190	7
		Dark Bronze	319.80	-	
		Black	367.70	-	
	95" (2413 mm)	Clear	273.50	195191	7
		Dark Bronze	392.90	-	
		Black	451.80	-	
119" (3023 mm)	Clear	408.20	195193	5	
	Dark Bronze	585.80	195196		
	Black	673.70	-		

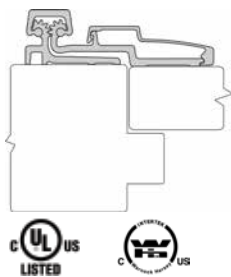

780-210 Full Surface	79" (2007 mm)	Clear	211.60	010064	6
		Dark Bronze	285.80	073030	
		Black	328.70	-	
	83" (2108 mm)	Clear	211.60	048050	6
		Dark Bronze	285.80	048051	
		Black	328.70	-	
	95" (2413 mm)	Clear	253.20	063037	6
		Dark Bronze	344.90	020588	
		Black	396.60	-	

1. Items with the price in **bold and red** are Quick Ship items and ship in 24 hours.
Please use stock number when ordering. 2. U/M is each unless otherwise noted.



Roton Continuous Geared Hinges

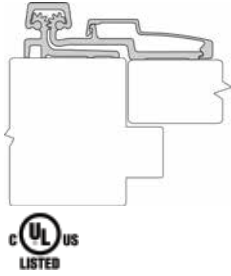

Description		Finish	2018 List	Stock No.	Case Qty.
780-210HD Full Surface Heavy Duty	79" (2007 mm)	Clear	258.20	017046	6
		Dark Bronze	313.90	017037	
		Black	361.00	-	
	83" (2108 mm)	Clear	258.20	048061	6
		Dark Bronze	313.90	048062	
		Black	361.00	-	
	85" (2159 mm)	Clear	258.20	024124	6
		Dark Bronze	313.90	071974	
		Black	361.00	-	
	95" (2413 mm)	Clear	304.80	048063	6
		Dark Bronze	375.00	046722	
		Black	431.20	-	
	119" (3023 mm)	Clear	509.80	025722	2
		Dark Bronze	571.40	000304	
		Black	657.10	-	

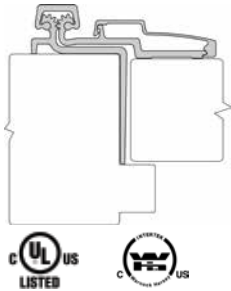

780-211HD Half Surface Heavy Duty Frame Leaf Wrap-Around Reinforcement for Damaged Frames	79" (2007 mm)	Clear	508.20	116360	4
		Dark Bronze	667.70	-	
		Black	767.90	-	
	83" (2108 mm)	Clear	508.20	010867	4
		Dark Bronze	667.70	120382	
		Black	767.90	-	
	85" (2159 mm)	Clear	508.20	162789	4
		Dark Bronze	667.70	160923	
		Black	767.90	-	
	95" (2413 mm)	Clear	625.40	115949	4
		Dark Bronze	821.80	-	
		Black	945.10	-	
	119" (3023 mm)	Clear	931.70	158595	2
		Dark Bronze	1,224.60	-	
		Black	1,408.30	-	

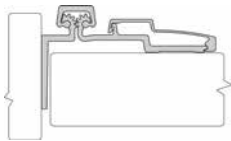

780-213HD Half Surface Heavy Duty Center Hung Doors	79" (2007 mm)	Clear	481.30	023958	4
		Dark Bronze	635.50	107818	
		Black	730.80	-	
	83" (2108 mm)	Clear	481.30	007660	4
		Dark Bronze	635.50	195212	
		Black	730.80	-	
	85" (2159 mm)	Clear	481.30	044343	4
		Dark Bronze	635.50	147623	
		Black	730.80	-	
	95" (2413 mm)	Clear	590.60	012731	4
		Dark Bronze	781.60	038555	
		Black	898.80	-	
	119" (3023 mm)	Clear	880.10	010262	2
		Dark Bronze	1,164.90	147624	
		Black	1,339.60	-	



Roton Continuous Geared Hinges

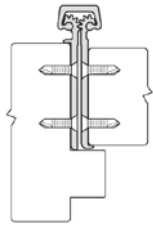

Description	Finish	2018 List	Stock No.	Case Qty.
780-224 Concealed Leaf 1-3/4" Doors Single Pack w/ Drill Quick Screws	79" (2007 mm) Clear	139.30	183923	7
	Dark Bronze	181.70	194839	
	Black	209.00	-	
	83" (2108 mm) Clear	139.30	184005	7
	Dark Bronze	181.70	184006	
	Black	209.00	-	
	95" (2413 mm) Clear	176.60	184036	7
	Dark Bronze	228.30	194840	
	Black	262.50	-	
780-224 Bulk Pack Concealed Leaf 1-3/4" Doors Case Pack w/ Drill Quick Screws Must Order Case Quantity	83" (2108 mm) Clear	125.30	194841	7
780-224HD Concealed Leaf 1-3/4" Doors Single Pack w/ Drill Quick Screws	79" (2007 mm) Clear	173.80	183882	7
	Dark Bronze	226.00	183921	
	Black	259.90	-	
	83" (2108 mm) Clear	173.80	184122	7
	Dark Bronze	226.00	183973	
	Black	259.90	183992	
	85" (2159 mm) Clear	173.80	184012	7
	Dark Bronze	226.00	184014	
	Black	259.90	-	
	95" (2413 mm) Clear	210.50	184022	7
	Dark Bronze	277.20	184023	
	Black	318.80	195809	
	119" (3023 mm) Clear	344.90	184039	5
	Dark Bronze	449.00	194842	
	Black	516.40	195810	
780-224HD Concealed Leaf 1-3/4" Doors Case Pack w/ Drill Quick Screws Must Order Case Quantity	83" (2108 mm) Clear	156.40	194828	7
	Dark Bronze	203.50	194829	
	Black	234.00	-	
780-224LL Concealed Leaf 1-3/4" Doors Lead Lined With Half Drill Quick and Half Wood Screws Heavy Duty Profile Only	79" (2007 mm) Clear	200.70	195181	7
	Dark Bronze	256.10	195221	
	Black	294.60	-	
	83" (2108 mm) Clear	200.70	195184	7
	Dark Bronze	256.10	195222	
	Black	294.60	-	
	85" (2159 mm) Clear	200.70	195223	7
	Dark Bronze	256.10	-	
	Black	294.60	-	
	95" (2413 mm) Clear	242.70	195224	7
	Dark Bronze	298.80	195225	
	Black	343.60	-	
	119" (3023 mm) Clear	381.70	195226	5
	Dark Bronze	492.00	-	
	Black	565.80	-	

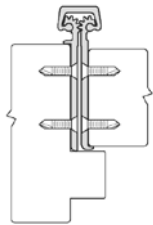
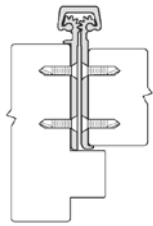

1. Items with the price in **bold and red** are Quick Ship items and ship in 24 hours.
 Please use stock number when ordering. 2. U/M is each unless otherwise noted.

4/1/2018
 www.hagerco.com



Roton Continuous Geared Hinges

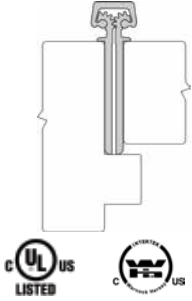

Description	Size	Finish	Year List	Stock No.	Case Qty.
780-226HD Concealed Leaf Heavy Duty For Doors 2" or Thicker Concealed Leaf Heavy Duty For Doors 2" or Thicker	79" (2007 mm)	Clear	207.90	194843	7
		Dark Bronze	274.20	194844	
		Black	315.40	-	
	83" (2108 mm)	Clear	207.90	183974	7
		Dark Bronze	274.20	194845	
		Black	315.40	195812	
	85" (2159 mm)	Clear	207.90	194846	7
		Dark Bronze	274.20	194849	
		Black	315.40	-	
	95" (2413 mm)	Clear	253.00	184024	7
		Dark Bronze	325.30	194850	
		Black	374.10	195813	
119" (3023 mm)	Clear	410.90	193587	5	
	Dark Bronze	533.70	194851		
	Black	613.70	195815		

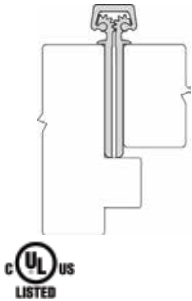

780-226LL Concealed Leaf For Lead Lined Doors 2" or Thicker With Half Drill Quick and Half Wood Screws Heavy Duty Profile Only	79" (2007 mm)	Clear	225.30	195229	7
		Dark Bronze	287.00	-	
		Black	330.00	-	
	83" (2108 mm)	Clear	225.30	195235	7
		Dark Bronze	287.00	-	
		Black	330.00	-	
	85" (2159 mm)	Clear	225.30	-	7
		Dark Bronze	287.00	-	
		Black	330.00	-	
	95" (2413 mm)	Clear	272.30	195236	7
		Dark Bronze	327.20	195237	
		Black	376.30	-	
119" (3023 mm)	Clear	427.70	195238	5	
	Dark Bronze	551.00	195239		
	Black	633.70	-		

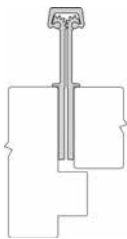

780-235HD Concealed Leaf Heavy Duty Wide Throw	83" (2108 mm)	Clear	483.40	195241	1
		Dark Bronze	632.80	195242	
		Black	727.70	-	
	95" (2413 mm)	Clear	596.60	195243	1
		Dark Bronze	760.10	195244	
		Black	874.10	-	



Roton Continuous Geared Hinges

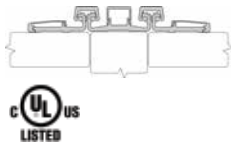

Description	Size	Finish	Year List	Stock No.	Case Qty.
780-257HD Full Surface Heavy Duty Double hinge for hanging two doors from a fixed mullion.	79" (2007 mm)	Clear	505.50	-	2
		Dark Bronze	694.50	-	
		Black	798.60	-	
	83" (2108 mm)	Clear	505.50	081899	2
		Dark Bronze	694.50	159250	
		Black	798.60	-	
	85" (2159 mm)	Clear	505.50	112767	2
		Dark Bronze	694.50	158749	
		Black	798.60	-	
	95" (2413 mm)	Clear	622.10	028146	2
		Dark Bronze	854.00	161153	
		Black	982.10	-	
	119" (3023 mm)	Clear	927.60	162543	2
		Dark Bronze	1,272.90	-	
		Black	1,463.80	-	
780-259HD Half Surface Heavy Duty For 3/4" or 1" door	79" (2007 mm)	Clear	312.50	026034	5
		Dark Bronze	434.50	103994	
		Black	499.60	-	
	83" (2108 mm)	Clear	312.50	026035	5
		Dark Bronze	434.50	147628	
		Black	499.60	-	
	85" (2159 mm)	Clear	312.50	147629	5
		Dark Bronze	434.50	-	
		Black	499.60	-	
	95" (2413 mm)	Clear	374.20	045733	5
		Dark Bronze	534.20	147631	
		Black	614.40	-	
	119" (3023 mm)	Clear	574.40	147632	3
		Dark Bronze	795.60	027583	
		Black	915.00	-	
780-300HD Half Surface Heavy Duty Center Hung Applications	79" (2007 mm)	Clear	360.80	010212	4
		Dark Bronze	490.10	019206	
		Black	563.10	-	
	83" (2108 mm)	Clear	360.80	047819	4
		Dark Bronze	490.10	057968	
		Black	563.10	-	
	85" (2159 mm)	Clear	360.80	061937	4
		Dark Bronze	490.10	038063	
		Black	563.10	-	
	95" (2413 mm)	Clear	443.80	047821	4
		Dark Bronze	602.10	047822	
		Black	692.40	-	
	119" (3023 mm)	Clear	661.00	015052	2
		Dark Bronze	898.20	011244	
		Black	1,033.00	-	

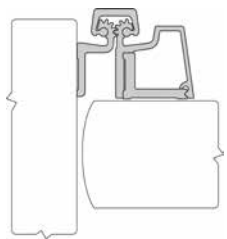
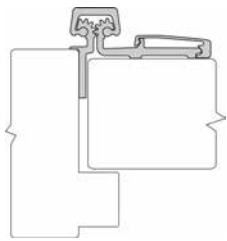

1. Items with the price in **bold and red** are Quick Ship items and ship in 24 hours.
Please use stock number when ordering. 2. U/M is each unless otherwise noted.

4/1/2018
www.hagerco.com



Roton Continuous Geared Hinges

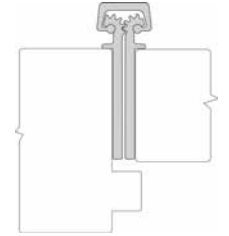
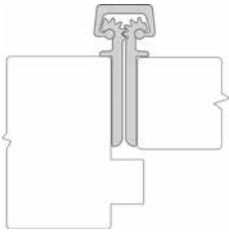

Description	Size	Finish	Year List	Stock No.	Case Qty.
1200-600XHD Concealed Leaf Extra Heavy Duty For doors from 1-3/4" to 2-3/8" thick.	83" (2108 mm)	Clear	1,016.40	000590	1
		Dark Bronze	1,422.50	028601	
	95" (2413 mm)	Clear	1,151.70	004040	1
		Dark Bronze	1,557.80	065709	
	119" (3023 mm)	Clear	1,287.20	090770	1
		Dark Bronze	1,693.20	107206	
1200-650XHD Concealed Leaf Extra Heavy Duty For doors 2-3/8" thick or thicker.	83" (2108 mm)	Clear	1,354.80	090353	1
		Dark Bronze	1,760.90	135473	
	95" (2413 mm)	Clear	1,490.20	090439	1
		Dark Bronze	1,896.20	108903	
	119" (3023 mm)	Clear	1,625.60	090440	1
		Dark Bronze	2,031.70	044852	





One Family. One Brand. One Vision.™

www.hagerco.com

TABLE OF CONTENTS

A		M	
ANSI Standards.....	2	Mortar Box.....	5
C		N	
Cancellation Notification	2	No Hole (Blank) Hinges	2
Concealed Electric Through-Wire.....	4-5	P	
Custom Hole Pattern	2	Powder Coat	3
Custom Length Hinges	2	Q	
D		Quick Connect.....	5
Dutch Door Hinges	3	Quick Ship.....	2
E		R	
Electrical Modifications Standard Locations.....	4	Raised Barrel.....	3
Electric Power Transfer Preparations (EPT)	5	Replacement Moldings	3
Exposed Electric Switches	5	S	
Extra Long Hinges.....	2	Security Fasteners.....	3
F		Security Studs.....	3
Fasteners.....	4	Sheared Leaf	3
Fire Rating	2	Standard Lengths.....	2
H		T	
Hinges		Tamper Resistant Hospital Tips.....	3
Concealed Leaf	6-7	W	
Full Surface	7	Wide Throw	3
Half Surface	6		
Half Mortise.....	6		
How To Order.....	1		
L			
Lead Times	2		
Lead Lined.....	2		

HOW TO ORDER:

Example: 790-900 83 1/8" US32D 1 PK

Stock Number: 023043

Item Number: PS90083B32D000001

790

STAINLESS
STEEL
CONTINUOUS
HINGE

900

ITEM#

83

LENGTH

1/8"

FRACTION

US32D

FINISH

1 PK

STANDARD
SINGLE
PACK



Stainless Steel Continuous Hinges

ANSI Standards

790 Series stainless steel continuous hinges are approved for ANSI A156.26 Grade 1 for 150-pound doors.

Fire Rating

Hager 790 Series hinges are approved by Underwriters Laboratories, Inc. Fire Rated label for up to 3 hours for metal doors and 90 minutes for wood composite doors.



Lead Times

Stock items will typically ship in five working days or less from the order entry date. Made-to-order items will typically ship in 15 working days depending on seasonal volume and order complexity. Special orders including industrials, special machining, and large quantities may need to be scheduled. The anticipated ship date will be included with each order acknowledgement. Please contact Customer Service if product availability is in question.

Quick Ship

Products denoted with **red and bold** pricing are available to order through the Quick Ship program and ship within 24 hours. When ordering these products please visit www.hagerco.com and log in to MyHager to access the 'Quick Ship' portal. Due to the promptness of the fulfillment process, Quick Ship orders are non-cancellable.

Cancellation Notification

Cancellation for made-to-order items must be communicated within 48 hours of order placement.

Standard Lengths

Stainless steel hinges are listed and priced as actual lengths 83-1/8" (7'0" opening), 85" (7'2" opening), 95" (8'0" opening), and 119" (10'0" opening) for convenience in application to nominal sized doors. Other lengths may be ordered as non-standard items.

Extra Long Hinges

Hinges over 119" are manufactured as two separate lengths with staggered joints for on-site connection.

MODIFICATIONS & ADDITIONS

ADDITION TO LIST PRICE

Custom Length Hinges

Actual door height may be specified at an additional charge outlined:

- For hinges 40" to 83" in length **\$68.15** to 7' list price.
- For hinges 83" to 95" in length **\$68.15** to 8' list price.
- For hinges 95" to 119" in length **\$68.15** to 10' list price.
- For hinges 119" to 192" in length **\$156.00** to the list price

Custom Hole Pattern

- Any hole pattern or shape other than Hager's standard hole pattern.

Price on Application

No Hole (Blank) Hinges

- Holes omitted for special applications (i.e. welded installation).

Price on Application

Lead Lined Hole Pattern

- Only available on Models 790-900, 790-911 and 790-915.

Price on Application



MODIFICATIONS & ADDITIONS

ADDITION TO LIST PRICE

Powder Coat

Price on Application

- Available in aluminum, dark bronze, satin bronze, satin brass, black, or white.

Tamper Resistant Hospital Tips (HT)

\$113.65

Price on Application

- Custom lengths
- Available on concealed leaf models 790-900, 790-905, 790-907, 790-915, for standard lengths.

Dutch Door Prep (DUTCH)

\$113.65

- Furnished as a continuous frame leaf while door leaf is cut to fit dutch door specified height.

Wide Throw

Price on Application

- Specify distance from pin centerline to heel edge of hinge.

Raised Barrel (SWAGED)

Price on Application

- Available on concealed and half surface models.

Sheared Leaf

Price on Application

- Available on all models except 790-904 and 790-906.
- Specify distance from pin centerline to extreme edge of hinge when ordering.

Security Studs

\$80.00

- Stainless steel security studs mounted through frame leaf into door frame.
- Door and frame must be specifically prepped to accommodate security studs.
- Door leaf is drilled to accommodate studs.

Replacement Moldings (M)

Hinge lengths:

79", 83", 85"

\$168.10

95"

\$181.70

119"

\$198.95

- Shipped in stock lengths for trimming in the field.



- Brush aluminum & furnished with 5 each molding clips, 5 each 1/4"-14 x 1" panhead 2C screws.
- Available on models 790-903, 790-904, 790-906 and 790-909.

Security Fasteners

\$79.55

- Torx and Spanner Head available in place of standard fasteners.



Stainless Steel Continuous Hinges

MODIFICATIONS & ADDITIONS

Additional Fasteners

#10-24 x 5/8" Torx Head Machine Screw	\$2.80 /ea
#10-16 x 1-1/4" Thread Forming Flat Head Screw	\$1.20 /ea
1/4"-14 x 1" Thread Forming Pan Head Screw	\$1.75 /ea
#10-24 x 5/8" Self-Drilling Flat Head Screw	\$1.75 /ea
1/4"-20 x 3/4" Self-Drilling Pan Head Screw	\$1.50 /ea
Adjustment Stud With Flat Head Screw	\$8.40 /ea
Sexbolt and Nut	\$5.20 /ea

STANDARD LOCATIONS FOR ELECTRICAL MODIFICATIONS

	79"	83"	85"	95"	119"
Opening	80"	84"	86"	96"	120"
Door Height	79-1/8"	83-1/8"	85-1/8"	95-1/8"	119-1/8"
Hinge Length	79-3/16"	83-1/8"	85-1/8"	95"	118-3/4"
ETW	41-1/2"	43-1/2"	45-1/2"	55-3/8"	79-1/8"
EPT	24-1/2"	28-7/16"	30-7/16"	40-1/2"	64-7/16"
E1S	41-1/2"	43-1/2"	45-1/2"	55-3/8"	79-1/8"

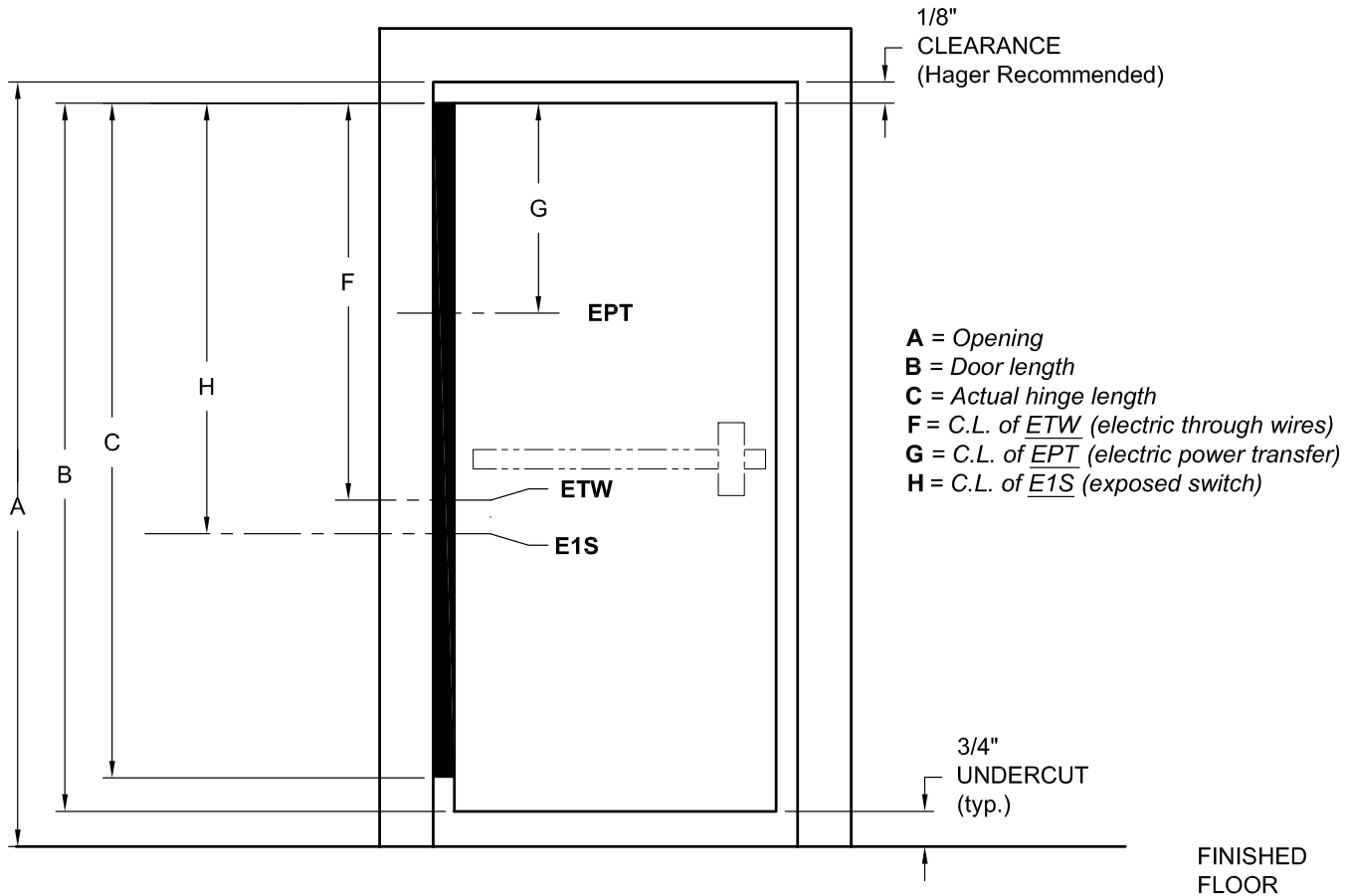

MODIFICATIONS & ADDITIONS

ADDITION TO LIST PRICE

Quick Connect

Available for ETW.

\$45.60

Electric Power Transfer Preparations (EPT)

\$130.25

- Hinge leaf cutout to accommodate power transfer device.
- Specify handing and dimension from top of hinge to centerline of power transfer cutout location. Please note the clearance from top of hinge to underside of header, typically 1/16" to 1/8" (1.6 mm to 3.2 mm).
- Available on models 790-900, 790-903, 790-904, and 790-915.

Exposed Electric Switches (E1S)

\$200.55

- Each monitoring hinge only needs one E1S switch.
- Specify handing and dimension from top of hinge to centerline of electric switch.
- Miniature push button switch is incorporated in the hinge frame leaf to monitor position of the door.

Concealed Electric Through-Wire (ETW)

Electric Through Wire	ETW - 4	\$579.55
Electric Through Wire	ETW - 8	\$866.95
Electric Through Wire	ETW - 10	\$1,169.05

- 24-gauge 12" wire leads available on 790-900 and 790-915.
- Transfers power discretely from building to door hardware.
- Specify handing and dimension from top of hinge to centerline of electric through-wire location. Please note the clearance from top of hinge to underside of header, typically 1/16" to 1/8" (1.6 mm to 3.2 mm).

Mortar Box - 430

\$45.55

- Serves as mortar shield.
- Top and bottom knockouts for standard conduit fittings.
- Overall dimensions are 9" (229 mm) length with tabs 7" (178 mm). Inside is 1-3/4" x 1-3/4" (45 mm x 45 mm).
- Galvanized steel .040" (1 mm).



Stainless Steel Continuous Hinges

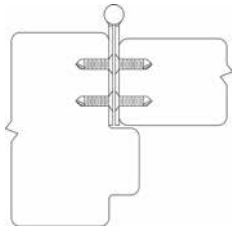

Description		Finish	2018 List	Stock No.	Case Qty.
790-900 Concealed Leaf, 1/8" Inset Door of Any Material	79" (2007 mm)	US32D	435.00	27336	1
	83" (2108 mm)	US32D	435.00	23243	1
	85" (2159 mm)	US32D	495.00	27921	1
	95" (2413 mm)	US32D	500.00	23250	1
	119" (3023 mm)	US32D	725.00	23251	1

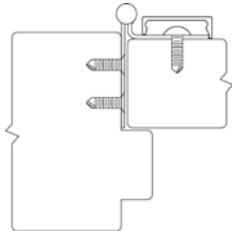

790-903 Half Surface, 1/8" Inset Door of Any Material Optional sex bolts available (specify when ordering).	79" (2007 mm)	US32D	500.00	42721	1
	83" (2108 mm)	US32D	500.00	23254	1
	85" (2159 mm)	US32D	580.00	53025	1
	95" (2413 mm)	US32D	580.00	23256	1
	119" (3023 mm)	US32D	740.00	23260	1

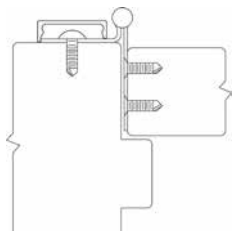

790-904 Half Mortise, 1/8" Inset Door of Any Material	79" (2007 mm)	US32D	505.00	71952	1
	83" (2108 mm)	US32D	505.00	52990	1
	85" (2159 mm)	US32D	605.00	92025	1
	95" (2413 mm)	US32D	605.00	52993	1
	119" (3023 mm)	US32D	785.00	52994	1

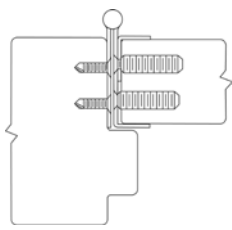

790-905 Concealed Leaf, 1/8" Inset Door of Any Material	79" (2007 mm)	US32D	560.00	65223	1
	83" (2108 mm)	US32D	560.00	23266	1
	85" (2159 mm)	US32D	640.00	36876	1
	95" (2413 mm)	US32D	640.00	23265	1
	119" (3023 mm)	US32D	955.00	23267	1

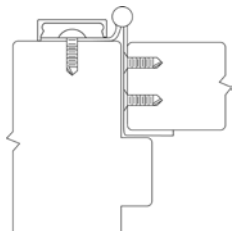

790-906 Half Mortise, Edge Guard Door of Any Material	79" (2007 mm)	US32D	505.00	92102	1
	83" (2108 mm)	US32D	505.00	92103	1
	85" (2159 mm)	US32D	605.00	92105	1
	95" (2413 mm)	US32D	605.00	92107	1
	119" (3023 mm)	US32D	785.00	92110	1



Stainless Steel Continuous Hinges

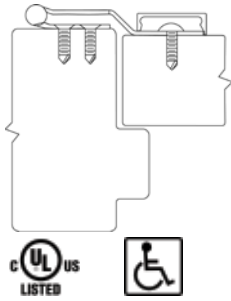

Description		Finish	2018 List	Stock No.	Case Qty.
790-909 Full Surface, 1/8" Inset Swing Clear Door of Any Material Optional sex bolts available (specify when ordering).	79" (2007 mm)	US32D	605.00	38978	1
	83" (2108 mm)	US32D	605.00	23270	1
	85" (2159 mm)	US32D	695.00	47643	1
	95" (2413 mm)	US32D	695.00	23271	1
	119" (3023 mm)	US32D	890.00	23279	1

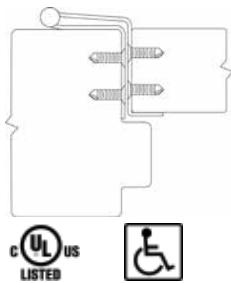

790-911 Concealed Leaf Swing Clear Door of Any Material	79" (2007 mm)	US32D	630.00	9412	1
	83" (2108 mm)	US32D	630.00	23284	1
	85" (2159 mm)	US32D	645.00	89831	1
	95" (2413 mm)	US32D	645.00	23285	1
	119" (3023 mm)	US32D	985.00	23286	1

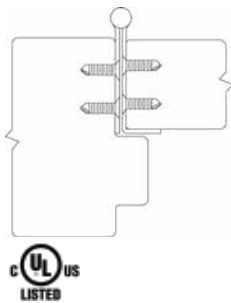

790-915 Concealed Leaf, 1/16" Inset Door of Any Material	79" (2007 mm)	US32D	525.00	33963	1
	83" (2108 mm)	US32D	525.00	23287	1
	85" (2159 mm)	US32D	595.00	40111	1
	95" (2413 mm)	US32D	595.00	23288	1
	119" (3023 mm)	US32D	885.00	23289	1

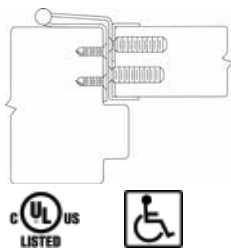

790-926 Concealed Leaf Swing Clear Door of Any Material	79" (2007 mm)	US32D	780.00	45597	1
	83" (2108 mm)	US32D	780.00	26760	1
	85" (2159 mm)	US32D	880.00	50336	1
	95" (2413 mm)	US32D	880.00	26761	1
	119" (3023 mm)	US32D	1,065.00	26762	1

1. Items with the price in **bold and red** are Quick Ship items and ship in 24 hours.
Please use stock number when ordering. 2. U/M is each unless otherwise noted.





One Family. One Brand. One Vision.™

www.hagerco.com

Trim & Auxiliary

M	
Miscellaneous Hardware	
Closet Knobs.....	118
Closet Rod, Sockets.....	123, 125
Closet Pull Sockets.....	117-119
Concealed Edge Pull.....	21
Finger Pulls.....	117-119
Magnetic Catch.....	122
Pocket Door Edge Pulls.....	119
Shelf Brackets.....	124
Mounting Options.....	5

P	
Pulls	
Anti Vandal Trim.....	79
Back-to-Back Offset Pulls.....	20-22
Back-to-Back Straight Pulls.....	16-17
Cast Pulls.....	12-13, 19
Flush Cup Pulls.....	18-19, 22-23
Half Round.....	9
Offset Pulls.....	15-16, 22
Oval.....	13-14
Rectangular.....	9-10
Round.....	10-12, 14-16
Straight Pulls.....	9-14
Wire Drawer Pulls.....	78

Pull Plates	
Cylinder Pull.....	43
Pull Plate w/ Lip.....	43
Square Corner.....	26-34

Push Bars	
Back-to-Back.....	46
Bent.....	44-46
Flat.....	44
Round.....	45-46

Push Plates	
Beveled - Square Corner.....	38-40
Half Circle.....	43
Plastic Laminate.....	38-39
Radius Corner.....	35-36, 41
Round Bevel Top and Bottom.....	42
Rounded Corner.....	37-38
Square Corner.....	24-25

Push/Pull Sets	
Flat Bar.....	56
Round Bar.....	16-17, 19-21, 22, 46-56
Security Push/Pull Plate.....	43

R	
Recommended Application.....	3
Recommended Maintenance.....	3
Residential Trim.....	78, 81, 117-121
Roller Latch/Catches	
Adjustable Ball Catch.....	80
Drive-In Ball Catch.....	122
Roller Latch.....	80
Roller Latch with Stop.....	80
Roller Latch w/ ASA Strike.....	117
Roller Latch w/ Full Lip Strike.....	117
Roller Latch w/ Tee Strike.....	80
Three-Way Ball Catch.....	80

S	
Signage	
ADA Tactile, Plastic.....	89-91
International Symbols, Plastic.....	89
Men/Women, Metal.....	88
Men/Women, Plastic.....	86-87
Numbers, Plastic.....	86
Push/Pull, Metal.....	88
Push/Pull, Plastic.....	86-87
Restroom/Restrooms, Plastic.....	87-88

Stops and Holders	
Roller Bumper.....	71-72
Door Holder, Kickdown.....	71, 119
Floor Stops.....	66-72, 81-82, 119, 124
Heavy Duty Floor Stop.....	71
Stops With Holder.....	68-70, 81-82
Wall Stops.....	65-66, 68-70, 81-82, 120, 124
Hinge Pin Door Bumper.....	78, 120, 124
Surface Bolts.....	72-73

CRATING CHARGES

When ordered separately, orders of less than 5 armor plates (plates over 16 inches high) are subject to a \$15.60 net crating charge.

ARCHITECTURAL FINISH SYMBOLS

Unless specifically noted, finishes are priced as listed by each item on the following pages.

US & HAGER	DESCRIPTION	BASE MATERIAL	PRICING INSTRUCTIONS	BHMA SYMBOL
2C	Zinc Plated Steel	Steel	As Listed	603
3	Bright Brass	Brass	As Listed	605
4	Satin Brass	Brass	As Listed	606
5	Satin Brass, Oxidized	Brass Brass/Bronze	25% Above US10B	609
9	Bright Bronze	Brass Brass/Bronze	25% Above US10	611
10	Satin Bronze	Brass Brass/Bronze	As Listed	612
10B	Antique Bronze, Oiled	Brass Brass/Bronze	As Listed	613
10R	Matte Lacquer Antique Bronze	Brass Brass/Bronze	As Listed	-
15	Satin Nickel	Brass Brass/Bronze	Price Same as US26D	619
15A	Satin Nickel Oxidized	Brass Brass/Bronze	As Listed	620
19	Flat Black Coated	Brass	25% Above US10B	622
26	Bright Chromium Plated	Brass Brass/Bronze	As Listed	625
26D	Satin Chromium Plated	Brass Brass/Bronze	As Listed	626
28	Satin Anodized Aluminum	Aluminum	As Listed	628
32	Stainless Steel Metal, Bright	300 Series	As Listed	629
32D	Stainless Steel Metal, Satin	300 Series	As Listed	630
L2	Dark Bronze Painted	-	25% Above US10B	695
PC	Clear Plastic	-	As Listed	-
PK	Plastic Laminate - Black	-	As Listed	-
CO	Plastic Laminate - Chocolate	-	As Listed	-
PG	Plastic Laminate - Grey	-	As Listed	-
S1	Sprayed Aluminum	Cast Iron	As Listed	-
S2	Sprayed Brass	Cast Iron	As Listed	-
S3	Sprayed Bronze	Cast Iron	As Listed	-

NOTE: For any finish not listed in this Price Book, or explained above, price and availability on request.

RECOMMENDED SPECIAL INSTRUCTIONS:

Application: All accessory item installation should be made following the application of paint or other finishes. Under no circumstances should accessory items be installed prior to painting. Paint or other finish material must be dry before applying accessory items to door. Hager recommends that a 72 hour drying time be allowed prior to application of accessory items under normal atmospheric conditions.

Maintenance: For cleaning, use only a soft damp cloth. Do not use any chemicals, abrasive cleaners, waxes, or brass cleaners on items with a lacquer coating or on plastic plates.



Trim & Auxiliary

ADDITIONS WHERE NOT LISTED

Door Edgings

For quantities less than 20 of one type of door edging, add 30% to list price.

Pull, Push Plate, Pull Plate, or Kick Plate Options

Add to the list price of each unit:

Antimicrobial Powder Coat Protection (32D only)

To order use MV3 as suffix - \$14.50 list price each

Flush Back Mounting on Pull Plates

\$10.95 list each plate.

Cutouts - Standard Locations (Not available on Kick Plates)

Wrought (.050) thickness -

-Cut for 1-1/4" (CFC) Standard Cylinder, add \$14.95 each.

-Cut for 2-1/8" (CFC) Cylinder or Turn Piece, add \$14.95 each.

Other thickness plates -

-Cut for 1-1/4" (CFC) Standard Cylinder, add \$17.85 each.

-Cut for 2-1/8" (CFC) Cylinder or Turn Piece, add \$17.85 each.

FASTENERS

Illustrated below are various types of fasteners that can be furnished by Hager Companies. Please specify type of fastening desired. All types of fastening cannot be used with all items of hardware. If specified method is not possible, we reserve the right to furnish whatever type we feel is best suited for the installation. When used with tempered glass doors, specify thickness of glass and hole diameter.



Hex bolt and machine screws
(various sizes)



Lead anchor
(used with floor stops in masonry applications)



Plastic anchor and full threaded screw
(used in drywall or masonry applications)



Lag screw and shield

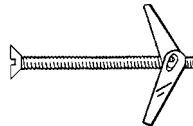

Toggle bolt
(ideal for drywall applications)

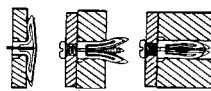

Plastic toggle anchor
(used with wall stops in drywall applications)



Thru-bolt and finish washer
(flat or oval head; size as required)



Spanner head machine screws
(various sizes furnished at extra charge)



Security torx head machine screws
(various sizes furnished at extra charge)

Note: Torx and Spanner screws are available for select items. Please call Customer Service for availability and price.

Cutouts - Non-Standard Locations

Priced on application.

Engraving

For engraving standard "PUSH" or "PULL", "Men" or "Women" for stainless steel, add \$44.25 each, \$88.50 set.

For engraving standard "PUSH" or "PULL", "Men" or "Women" for all other materials, add \$30.05 each, \$60.15 set.

Tactile Warning

Available on limited items. Add \$41.05 to list.

Pull Plates - Non-Standard

To price pull plates not listed in price book, add list price of pull desired to the list price of the plate desired, plus \$4.80 list for assembly charge (and any other options required).

Accessibility Option

For Hager Special Accessibility Clearance - (2-1/2"), prefix "H". Add \$6.35 List for single pull and \$12.65 List for double pull.



MOUNTINGS

Illustrated below are various types of mountings that can be furnished by Hager Companies. Please specify type of mounting desired. All types of mountings cannot be used with all items of hardware. If specified method is not possible, we reserve the right to furnish whatever type we feel is best suited for the installation. When used with tempered glass doors specify thickness of glass and hole diameter.

Mounting Accessory Charges:

For Concealed Cone mountings, add \$10.95 list for each required fitting (Type 3).
 For Concealed Cone mountings, add \$10.95 list for each required fitting (Type 5).
 For Spanner Collar mountings, add \$18.80 list for each required fitting (Type 7).
 For Concealed Cone and Lug mountings, add \$27.75 list for each required fitting.

Temper Glass Door Installation:

Spanner Cap Mountings (Type 8) for tempered glass doors, add \$18.80 list for each spanner cap.
 Note: Mounting back-to-back or spanner cap installation requires at least two fittings.
 Stile Plates, add \$15.70 list each.

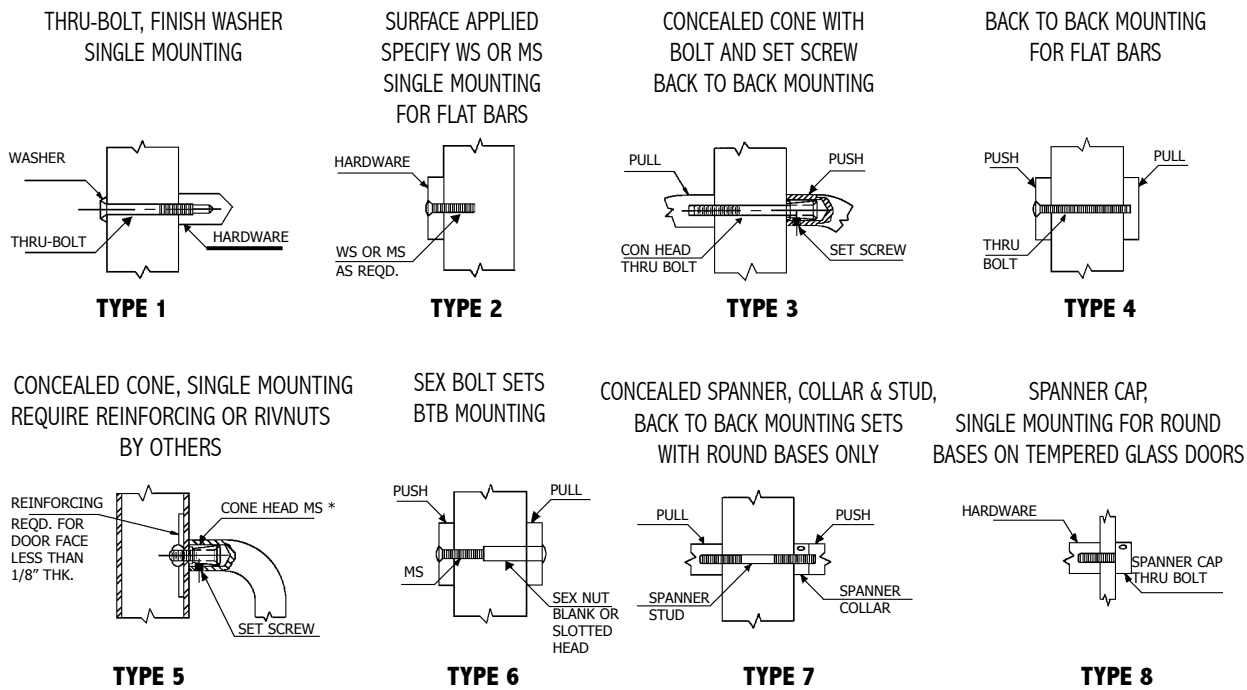

Lead Times

Stock items will typically ship in five working days or less from the order entry date. Made-to-order items will typically ship in 15 working days depending on seasonal volume and order complexity. Special orders including industrials, special machining, and large quantities may need to be scheduled. The anticipated ship date will be included with each order acknowledgement. Please contact Customer Service if product availability is in question.

Quick Ship

Products denoted with **red and bold** pricing are available to order through the Quick Ship program and ship within 24 hours. When ordering these products please visit www.hagerco.com and log in to MyHager to access the 'Quick Ship' portal. Due to the promptness of the fulfillment process, Quick Ship orders are non-cancellable.

Cancellation Notification

Cancellation for made-to-order items must be communicated within 48 hours of order placement.



Trim & Auxiliary

DOOR PLATE HUNDRED SQUARE INCH SIZE CHART													
H/W	24"	26"	28"	30"	32"	34"	36"	38"	40"	42"	44"	46"	48" MAX
4"	0.96	1.04	1.12	1.20	1.28	1.36	1.44	1.52	1.60	1.68	1.76	1.84	1.92
6"	1.44	1.56	1.68	1.80	1.92	2.04	2.16	2.28	2.40	2.52	2.64	2.76	2.88
8"	1.92	2.08	2.24	2.40	2.56	2.72	2.88	3.04	3.20	3.36	3.52	3.68	3.84
10"	2.40	2.60	2.80	3.00	3.20	3.40	3.60	3.80	4.00	4.20	4.40	4.60	4.80
12"	2.88	3.12	3.36	3.60	3.84	4.08	4.32	4.56	4.80	5.04	5.28	5.52	5.76
14"	3.36	3.64	3.92	4.20	4.48	4.76	5.04	5.32	5.60	5.88	6.16	6.44	6.72
16"	3.84	4.16	4.48	4.80	5.12	5.44	5.76	6.08	6.40	6.72	7.04	7.36	7.68
18"	4.32	4.68	5.04	5.40	5.76	6.12	6.48	6.84	7.20	7.56	7.92	8.28	8.64
20"	4.80	5.20	5.60	6.00	6.40	6.80	7.20	7.60	8.00	8.40	8.80	9.20	9.60
22"	5.28	5.72	6.16	6.60	7.04	7.48	7.92	8.36	8.80	9.24	9.68	10.12	10.56
24"	5.76	6.24	6.72	7.20	7.68	8.16	8.64	9.12	9.60	10.08	10.56	11.04	11.52
26"	6.24	6.76	7.28	7.80	8.32	8.84	9.36	9.88	10.40	10.92	11.44	11.96	12.48
28"	6.72	7.28	7.84	8.40	8.96	9.52	10.08	10.64	11.20	11.76	12.32	12.88	13.44
30"	7.20	7.80	8.40	9.00	9.60	10.20	10.80	11.40	12.00	12.60	13.20	13.80	14.40
32"	7.68	8.32	8.96	9.60	10.24	10.88	11.52	12.16	12.80	13.44	14.08	14.72	15.36
34"	8.16	8.84	9.52	10.20	10.88	11.56	12.24	12.92	13.60	14.28	14.96	15.64	16.32
36"	8.64	9.36	10.08	10.80	11.52	12.24	12.96	13.68	14.40	15.12	15.84	16.56	17.28
38"	9.12	9.88	10.64	11.40	12.16	12.92	13.68	14.44	15.20	15.96	16.72	17.48	18.24
40"	9.60	10.40	11.20	12.00	12.80	13.60	14.40	15.20	16.00	16.80	17.60	18.40	19.20
42"	10.08	10.92	11.76	12.60	13.44	14.28	15.12	15.96	16.80	17.64	18.48	19.32	20.16
44"	10.56	11.44	12.32	13.20	14.08	14.96	15.84	16.72	17.60	18.48	19.36	20.24	21.12
46"	11.04	11.96	12.88	13.80	14.72	15.64	16.56	17.48	18.40	19.32	20.24	21.16	22.08
48" MAX	11.52	12.48	13.44	14.40	15.36	16.32	17.28	18.24	19.20	20.16	21.12	22.08	23.04

To figure the list price of a door protection plate, find the hundred square inch size on the chart above. For odd or fractional sizes use the next higher price (i.e. 8" x 31-1/2" - price as 8" x 32" = 2.56 sq. inches). Multiply the square inch size by the list price (for example, 2.56 sq. inches x US\$31.10 = \$79.62 list).

- #6 x 5/8" Phillips Oval Head undercut, Stainless Steel Sheet Metal Screws for counter sunk plates and Truss Head Stainless Steel Screws for non-counter sunk plates, to match plated finish.
- When ordered separately, orders of less than 5 armor plates are subject to a \$15.60 net crating charge (plates over 16 inches high).
- Kickplates specified with adhesive tape will be supplied without holes.
- Armor plates available with UL listing. See page 7.
- Cutouts for kick and armor plates priced on application.

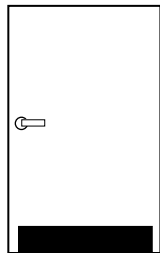

Mop Plate
Up to 8"h x 48"w

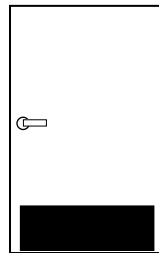

Kick Plate
6"-12"h x 48"w



Stretcher Plate
6"-12"h x 48"w

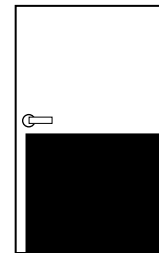

Armor Plate
Up to 48"h x 48"w

NFPA 80 STANDARD 6.4.5.3

- Factory installed protection plates shall be installed in accordance with the listing of the door.
- Field installed protection plate shall be labeled and installed in accordance with their listing.

Exception: Labeling is not required where the top of the protection plate is not more than 16" (406 mm) above the bottom of the door.





Description	Height	US28	US3, US4, US10	US10B, US19, US9	US32	US32D
190S	Under 8" high	11.25	31.80	37.10	22.15	9.95
Four beveled edges	8" to 24" high	9.50	31.10	36.45	21.55	8.90
.050 Gauge	Over 24" to 36" high	10.10	39.75	45.20	21.80	9.15
Metal Door Protection Plate	Over 36" to 48" high	10.10	47.95	54.80	21.80	9.15
Note: UL Listed for US32 and US32D only	8" x 34" (List Pricing)	-	-	-	-	24.21
	10" x 34" (List Pricing)	-	-	-	-	30.26



198S	Under 8" high	-	-	-	-	15.70
.038 Gauge	8" to 24" high	-	-	-	-	14.40
Metal Door Protection Plate	Over 24" to 36" high	-	-	-	-	14.40
	Over 36" to 48" high	-	-	-	-	14.40

Note: UL labeling not required when top of plate is less than 16" above the bottom of the door, per NFPA 80 - 2007.



Description	Height	BGA
199B	Under 8" high	11.05
Bright Gold Anodized	8" to 24" high	9.30
100 square inches	Over 24" to 36" high	9.35
.038 Gauge	Over 36" to 48" high	10.20
Metal Door Protection Plate		



Description	Height	Clear Plastic	Black	Brown	Grey
204S	Up to 48" high	9.10	-	-	-
Clear Plastic					
.125 Gauge					



214S	Up to 48" high	-	11.00	15.05	15.05
Plastic Laminate					
.125 Gauge					



Description	Height	US28	US3, US4, US10	US10B, US19, US9	US32	US32D
220S	Under 8" high	14.00	32.75	44.85	-	22.85
Four beveled edges	8" to 24" high	14.00	32.75	44.85	-	22.85
.062 Gauge	Over 24" to 36" high	15.00	35.40	48.95	-	22.85
Metal Door Protection Plate	Over 36" to 48" high	16.40	38.10	51.60	-	22.85

Note: Diamond plate is available in US26. Please contact Hager for pricing.



Trim & Auxiliary



Description	Height	Black (Calcutta)	Brown (Chocolate)	Tan (Beige)
225S	Under 8" high	12.50	12.50	12.50
.060 Gauge	8" to 24" high	10.65	10.65	10.65
Kydex Door Protection Plate	Over 24" to 36" high	11.30	11.30	11.30
	Over 36" to 48" high	11.30	11.30	11.30

Note: UL labeling not required when top of plate is less than 16" above the bottom of the door, per NFPA 80 - 2007.

Option	Description	Price
CSK	Countersunk Holes	0.50 per 100 square inch price
SA	Self Adhesive Tape	0.50 per 100 square inch price
	Spanner Head Screws	0.50 each
	Torx Head Screws	0.50 each
	.125 Material	Price on Application
	Wrap Around Side & Bottom Return	Price on Application
	UL Label Stamp (No tape -voids UL Listing)	12.80





Description	Finish	2018 List	Stock No.	Box Qty.	Case Qty.
1E					
Pull- Half Round	US3	49.65	052830	1	12
Material: Brass, bronze, aluminum, stainless steel	US4	53.45	063599		
Base: 1/2" x 1"	US10	53.45	052831		
Projection: 2"	US10B	53.45	052832		
Clearance: 1-1/2"	US26	53.45	022786		
CTC: 6"	US26D	53.45	052834		
Door Thickness: 1-3/4" standard	US28	28.50	052835		
Fasteners: 1/4"-20 x 2-1/4" FPHMS with washers	US32	51.95	074723		
Not suitable for BTB Mounting.	US32D	50.55	052836		
1G					
Pull- Half Round	US3	58.95	081562	1	12
Material: Brass, bronze, aluminum, stainless steel	US4	63.50	028588		
Base: 1/2" x 1"	US10	63.50	060015		
Projection: 2"	US10B	63.50	078323		
Clearance: 1-1/2"	US26	63.50	030588		
CTC: 8"	US26D	63.50	066243		
Door Thickness: 1-3/4" standard	US28	30.05	056587		
Fasteners: 1/4"-20 x 2-1/4" FPHS with washers	US32	63.50	032021		
Not suitable for BTB Mounting.	US32D	63.30	058307		
1J					
Pull- Half Round	US3	69.10	073346	1	12
Material: Brass, bronze, aluminum, stainless steel	US4	75.25	026724		
Base: 1/2" x 1"	US10	75.25	067206		
Projection: 2"	US10B	75.25	062739		
Clearance: 1-1/2"	US26	75.25	013936		
CTC: 10"	US26D	75.25	062738		
Door Thickness: 1-3/4" standard	US28	33.90	010948		
Fasteners: 1/4"-20 x 2-1/4" FPHMS with washers	US32	73.20	092494		
Not suitable for BTB Mounting.	US32D	70.10	072255		
1L					
Pull- Half Round	US3	79.20	022469	1	12
Material: Brass, bronze, aluminum, stainless steel	US4	87.20	059759		
Base: 1/2" x 1"	US10	87.20	019781		
Projection: 2"	US10B	87.20	048642		
Clearance: 1-1/2"	US26	87.20	-		
CTC: 12"	US26D	87.20	085377		
Door Thickness: 1-3/4" standard	US28	41.90	067536		
Fasteners: 1/4"-20 x 2-1/4" FPHMS with washers	US32	85.40	060054		
Not suitable for BTB Mounting.	US32D	81.15	060014		
2E					
Pull - Rectangular	US3	45.85	052812	1	12
Material: Brass, bronze, aluminum, stainless steel	US4	47.35	002326		
Base: 3/8" x 1-1/4"	US10	47.35	091536		
Projection: 2"	US10B	47.35	015641		
Clearance: 1-5/8"	US26	47.35	052815		
CTC: 6"	US26D	47.35	052816		
Door Thickness: 1-3/4" standard	US28	24.15	052817		
Fasteners: 1/4"-20 x 2-1/4" FPHMS with washers	US32	51.70	-		
Not suitable for BTB Mounting.	US32D	46.40	052818		

1. Items with the price in **bold and red** are Quick Ship items and ship in 24 hours.
Please use stock number when ordering. 2. U/M is each unless otherwise noted.



Trim & Auxiliary

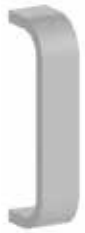
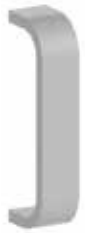

Description	Finish	2018 List	Stock No.	Box Qty.	Case Qty.
2G					
Pull - Rectangular	US3	55.05	052819	1	12
Material: Brass, bronze, aluminum, stainless steel	US4	58.40	-		
Base: 3/8" x 1-1/4"	US10	58.40	052820		
Projection: 2"	US10B	58.40	052821		
Clearance: 1-5/8"	US26	58.40	120486		
CTC: 8"	US26D	58.40	008573		
Door Thickness: 1-3/4" standard	US28	25.95	082824		
Fasteners: 1/4"-20 x 2-1/4" FPHMS with washers	US32	60.00	-		
Not suitable for BTB Mounting.	US32D	56.65	052825		
2J					
Pull - Rectangular	US3	65.05	099284	1	12
Material: Brass, bronze, aluminum, stainless steel	US4	70.55	111300		
Base: 3/8" x 1-1/4"	US10	70.55	137339		
Projection: 2"	US10B	72.05	083743		
Clearance: 1-5/8"	US26	72.05	-		
CTC: 10"	US26D	72.05	067318		
Door Thickness: 1-3/4" standard	US28	29.10	072355		
Fasteners: 1/4"-20 x 2-1/4" FPHMS with washers	US32	40.20	-		
Not suitable for BTB Mounting.	US32D	69.30	063689		
2L					
Pull - Rectangular	US3	68.30	137565	1	12
Material: Brass, bronze, aluminum, stainless steel	US4	72.90	078244		
Base: 3/8" x 1-1/4"	US10	76.00	036307		
Projection: 2"	US10B	76.00	001482		
Clearance: 1-5/8"	US26	76.00	-		
CTC: 12"	US26D	76.00	101506		
Door Thickness: 1-3/4" standard	US28	37.80	016671		
Fasteners: 1/4"-20 x 2-1/4" FPHMS with washers	US32	76.85	036632		
Note suitable for BTB Mounting.	US32D	73.85	068545		
3E					
Pull - Round	US3	52.00	052507	1	12
Material: Brass, bronze, aluminum, stainless steel	US4	52.00	082808		
Base: 3/4" diameter	US10	55.00	052508		
Projection: 2-1/4"	US10B	55.00	052510		
Clearance: 1-1/2"	US26	55.00	052826		
CTC: 6"	US26D	55.00	052705		
Door Thickness: 1-3/4" standard	US28	22.00	052511		
Fasteners: 1/4"-20 x 2-1/4" FPHMS with washers	US32	54.00	003987		
	US32D	28.25	052512		
3G					
Pull - Round	US3	53.40	052706	1	12
Material: Brass, bronze, aluminum, stainless steel	US4	53.40	054828		
Base: 3/4" diameter	US10	56.50	052707		
Projection: 2-1/4"	US10B	56.50	052513		
Clearance: 1-1/2"	US26	56.50	052827		
CTC: 8"	US26D	56.50	052708		
Door Thickness: 1-3/4" standard	US28	28.50	052709		
Fasteners: 1/4"-20 x 2-1/4" FPHMS with washers	US32	54.00	003987		
	US32D	30.00	052514		





Description	Finish	2018 List	Stock No.	Box Qty.	Case Qty.
3J					
Pull - Round	US3	54.75	058846	1	12
Material: Brass, bronze, aluminum, stainless steel	US4	54.75	017703		
Base: 3/4" diameter	US10	63.95	059315		
Projection: 2-1/4"	US10B	63.95	058929		
Clearance: 1-1/2"	US26	63.95	067231		
CTC: 10"	US26D	63.95	060904		
Door Thickness: 1-3/4" standard	US28	37.00	064414		
Fasteners: 1/4"-20 x 2-1/4" FPHMS with washers	US32	55.75	009135		
	US32D	34.40	053788		



3L					
Pull - Round	US3	65.95	062658	1	12
Material: Brass, bronze, aluminum, stainless steel	US4	72.35	044307		
Base: 3/4" diameter	US10	77.85	084100		
Projection: 2-1/4"	US10B	77.85	067606		
Clearance: 1-1/2"	US26	77.85	088253		
CTC: 12"	US26D	77.85	070804		
Door Thickness: 1-3/4" standard	US28	40.10	068010		
Fasteners: 1/4"-20 x 2-1/4" FPHMS with washers	US32	83.25	071641		
	US32D	59.20	056122		



P4E					
Security Pull - Round	US32D	68.95	085014	1	12
Material: Stainless steel					
Base: 1" diameter					
Projection: 2-1/4"					
Clearance: 1-1/4"					
CTC: 6"					
Fasteners: 3/8" - 16 x 1-1/4"					
Nyloc hex head cap screws					
Concealed mounting in door, use on hollow metal doors only.					



T4E					
Security Pull - Round	US32D	72.00	085015	1	12
Material: Stainless steel					
Base: 1" diameter					
Projection: 2-1/4"					
Clearance: 1-1/4"					
CTC: 6"					
Door Thickness: 1-3/4" standard					
Fasteners: 1/4" - 20 x 2-1/4" FTXMS with washers					
Security Torx, Thru Bolt Mounting					



4G					
Pull - Round	US3	75.15	052710	1	12
Material: Brass, bronze, aluminum, stainless steel	US4	81.15	071068		
Base: 1" diameter	US10	91.40	052711		
Projection: 2-3/4"	US10B	94.10	052712		
Clearance: 1-3/4"	US26	83.70	052828		
CTC: 8"	US26D	83.70	052713		
Door Thickness: 1-3/4" standard	US28	37.75	051945		
Fasteners: 1/4"-20 x 2-1/4" FPHMS with washers	US32	72.50	056698		
	US32D	53.15	051946		

1. Items with the price in **bold and red** are Quick Ship items and ship in 24 hours.
Please use stock number when ordering. 2. U/M is each unless otherwise noted.



Trim & Auxiliary



Description	Finish	2018 List	Stock No.	Box Qty.	Case Qty.
4H					
Pull - Round	US3	74.20	116804	1	12
Material: Brass, bronze, aluminum, stainless steel	US4	74.20	-		
Base: 1" diameter	US10	81.65	-		
Projection: 2-3/4"	US10B	81.65	068290		
Clearance: 1-3/4"	US26	81.65	139764		
CTC: 9"	US26D	81.65	016412		
Door Thickness: 1-3/4" standard	US28	42.85	099188		
Fasteners: 1/4"-20 x 2-1/4" FPHMS with washers	US32	93.80	075526		
	US32D	68.90	037214		



4J					
Pull - Round	US3	90.15	052714	1	12
Material: Brass, bronze, aluminum, stainless steel	US4	90.15	054807		
Base: 1" diameter	US10	91.40	052715		
Projection: 2-3/4"	US10B	94.10	052716		
Clearance: 1-3/4"	US26	92.10	052829		
CTC: 10"	US26D	92.10	052515		
Door Thickness: 1-3/4" standard	US28	34.00	052717		
Fasteners: 1/4"-20 x 2-1/4" FPHMS with washers	US32	74.85	060648		
	US32D	59.10	052516		



4L					
Pull - Round	US3	84.40	056307	1	12
Material: Brass, bronze, aluminum, stainless steel	US4	84.40	062858		
Base: 1" diameter	US10	99.40	068316		
Projection: 2-3/4"	US10B	99.40	062875		
Clearance: 1-3/4"	US26	99.40	054951		
CTC: 12"	US26D	99.40	072906		
Door Thickness: 1-3/4" standard	US28	50.25	059808		
Fasteners: 1/4"-20 x 2-1/4" FPHMS with washers	US32	109.45	069478		
	US32D	84.30	054672		



5D					
Pull - Round	US3	33.45	048492	1	12
Material: Brass, bronze, aluminum, stainless steel	US4	33.45	048493		
Base: 5/8" diameter	US10	36.15	048489		
Projection: 2-1/8"	US10B	36.15	048495		
Clearance: 1-1/2"	US26	36.15	007765		
CTC: 5-1/2"	US26D	36.15	048496		
Door Thickness: 1-3/4" standard	US28	22.80	048491		
Fasteners: 1/4"-20 x 2-1/4" FPHMS with washers	US32	42.30	-		
Not suitable for BTB Mounting.	US32D	31.45	048497		



5N					
Cast Pull	US3	50.25	052289	1	12
Material: Brass, bronze, aluminum, stainless steel	US4	54.00	052290		
Base: 5/8" x 1-3/16"	US10	57.70	052291		
Projection: 2"	US10B	57.70	052292		
Clearance: 1-1/2"	US26	57.70	052808		
Length: 6-1/8"	US26D	57.70	052701		
CTC: 5-1/2"	US28	35.30	138885		
Door Thickness: 1-3/4" standard	US32D	63.30	052294		
Fasteners: 1/4"-20 x 2-1/4" FPHMS with washers					
Not suitable for BTB Mounting.					





Description	Finish	2018 List	Stock No.	Box Qty.	Case Qty.
6N					
Cast Pull	US3	38.80	052295	1	12
Material: Brass, bronze, aluminum, stainless steel	US4	43.40	052296		
Base: 1" diameter	US10	53.70	052297		
Projection: 1-7/8"	US10B	53.70	052298		
Clearance: 1-3/8"	US26	53.70	028570		
O/A Length: 6-1/2"	US26D	53.70	052811		
CTC: 5-1/2"	US28	28.00	052299		
Door Thickness: 1-3/4" standard	US32D	55.40	052300		
Fasteners: 1/4"-20 x 2-1/4" FPHMS with washers					
Not suitable for BTB Mounting.					



7N					
Cast Pull	US3	49.00	052301	1	12
Material: Brass, bronze, aluminum	US4	49.00	053309		
Base: 2" diameter	US10	57.00	052302		
Projection: 1-7/8"	US10B	57.00	052806		
Clearance: 1-3/8"	US26	57.00	052807		
CTC: 5-1/2"	US26D	57.00	052304		
Door Thickness: 1-3/4" standard	US28	25.00	052303		
Fasteners: 1/4"-20 x 2-1/4" FPHMS with washers					
Not suitable for BTB Mounting.					



8N					
Material: Brass, bronze, aluminum	US3	49.00	052305	1	12
Base: 2" diameter	US4	49.00	053310		
Projection: 1-7/8"	US10	52.00	052306		
CTC: 5-1/2"	US10B	59.00	052700		
Clearance: 1-3/8"	US26	52.00	052805		
Fasteners: #8 x 1 OPHWS	US26D	45.00	052308		
Not suitable for BTB Mounting.	US28	25.00	052307		



P8N					
Cast Pull	US4	68.95	081356	1	12
Material: Brass	US26D	68.95	084188		
Base: 1-1/2" x 1-5/8"					
Projection: 2-1/4"					
CTC: 7-3/4"					
Clearance: 1-9/16"					
O/A Length: 8-3/4"					
Fasteners: 3/8 - 16 x 3/4" FPHMS					
Not suitable for BTB Mounting.					



9E					
Pull - Oval	US3	39.30	078724	1	12
Material: Brass, bronze, stainless steel	US4	39.30	031734		
Base: 1/2" x 3/4"	US10	44.25	017647		
Projection: 2"	US10B	44.25	083301		
Clearance: 1-1/2"	US26	44.25	083270		
CTC: 6"	US26D	44.25	082917		
Door Thickness: 1-3/4" standard	US32	45.85	109645		
Fasteners: 1/4"-20 x 2-1/4" FPHMS with washers	US32D	45.35	066230		
Not suitable for BTB Mounting.					

1. Items with the price in **bold and red** are Quick Ship items and ship in 24 hours.
Please use stock number when ordering. 2. U/M is each unless otherwise noted.



Trim & Auxiliary



Description	Finish	2018 List	Stock No.	Box Qty.	Case Qty.
9G					
Pull - Oval	US3	44.00	073348	1	12
Material: Brass, bronze, stainless steel	US4	44.00	129264		
Base: 1/2" x 3/4"	US10	48.80	071399		
Projection: 2"	US10B	48.80	076145		
Clearance: 1-1/2"	US26	48.80	-		
CTC: 8"	US26D	48.80	073350		
Door Thickness: 1-3/4" standard	US32	32.85	089854		
Fasteners: 1/4"-20 x 2-1/4" FPHMS with washers	US32D	39.25	073862		
Not suitable for BTB Mounting.					
9J					
Pull - Oval	US3	48.85	032128	1	12
Material: Brass, bronze, stainless steel	US4	48.85	021300		
Base: 1/2" x 3/4"	US10	53.45	026721		
Projection: 2"	US10B	53.45	020045		
Clearance: 1-1/2"	US26	53.45	-		
CTC: 10"	US26D	53.45	068291		
Door Thickness: 1-3/4" standard	US32	54.50	112592		
Fasteners: 1/4"-20 x 2-1/4" FPHMS with washers	US32D	47.65	089049		
Not suitable for BTB Mounting.					
9L					
Pull - Oval	US3	53.45	001447	1	12
Material: Brass, bronze, stainless steel	US4	53.45	090944		
Base: 1/2" x 3/4"	US10	58.20	018507		
Projection: 2"	US10B	58.20	095056		
Clearance: 1-1/2"	US26	58.20	-		
CTC: 12"	US26D	58.20	017368		
Door Thickness: 1-3/4" standard	US32	60.70	064516		
Fasteners: 1/4" x 2-1/4" FPHMS with washers	US32D	51.95	075733		
Not suitable for BTB Mounting.					
10L					
Pull - Round	US3	266.00	079250	1	8
Material: Brass, bronze, stainless steel	US4	266.00	094670		
Base: 1-1/4" diameter	US10	295.30	002193		
Projection: 3"	US10B	295.30	084947		
Clearance: 1-3/4"	US26	295.30	030731		
CTC: 12"	US26D	295.30	023472		
Door Thickness: 1-3/4" standard	US32	263.90	097312		
Fasteners: 5/16" - 18 x 2-1/4" FPHMS with washers	US32D	224.05	067649		
10Q					
Pull - Round	US3	291.85	090612	2	8
Material: Brass, bronze, stainless steel	US4	291.85	010843		
Base: 1-1/4" diameter	US10	312.35	034458		
Projection: 3"	US10B	312.35	087786		
Clearance: 1-3/4"	US26	312.35	-		
CTC: 18"	US26D	312.35	039520		
Door Thickness: 1-3/4" standard	US32	273.70	027254		
Fasteners: 5/16" - 18 x 2-1/4" FPHMS with washers	US32D	253.90	072664		





Description	Finish	2018 List	Stock No.	Box Qty.	Case Qty.
11E					
90° Offset Pull - Round	US3	80.65	059597	-	2
Material: Brass, bronze, aluminum, stainless steel	US4	80.65	018312		
Base: 3/4" diameter	US10	84.30	060336		
Projection: 2-1/2"	US10B	84.30	060315		
Clearance: 1-3/4"	US26	84.30	040696		
CTC: 6"	US26D	84.30	075266		
Offset: 2-1/2"	US28	52.90	043401		
Door Thickness: 1-3/4" standard	US32	86.15	-		
Fasteners: 5/16" - 18 x 2-1/4" FPHMS with washers	US32D	67.25	057380		
Available with 45° offset					
11G					
90° Offset Pull - Round	US3	84.95	063681	-	2
Material: Brass, bronze, aluminum, stainless steel	US4	84.95	047133		
Base: 3/4" diameter	US10	90.00	097774		
Projection: 2-1/2"	US10B	90.00	068662		
Clearance: 1-3/4"	US26	90.00	013867		
CTC: 8"	US26D	90.00	093586		
Offset: 2-1/2"	US28	59.90	067803		
Door Thickness: 1-3/4" standard	US32	91.40	109006		
Fasteners: 5/16" - 18 x 2-1/4" FPHMS with washers	US32D	73.85	066983		
Available with 45° offset					
11J					
90° Offset Pull - Round	US3	89.90	073589	-	2
Material: Brass, bronze, aluminum, stainless steel	US4	89.90	087629		
Base: 3/4" diameter	US10	97.60	074842		
Projection: 2-1/2"	US10B	97.60	056958		
Clearance: 1-3/4"	US26	97.60	064743		
CTC: 10"	US26D	97.60	091336		
Offset: 2-1/2"	US28	63.30	075928		
Door Thickness: 1-3/4" standard	US32	94.95	091535		
Fasteners: 5/16" - 18 x 2-1/4" FPHMS with washers	US32D	77.30	066497		
Available with 45° offset					
11L					
90° Offset Pull - Round	US3	97.60	096446	-	2
Material: Brass, bronze, aluminum, stainless steel	US4	97.60	-		
Base: 3/4" diameter	US10	109.40	023215		
Projection: 2-1/2"	US10B	109.40	070692		
Clearance: 1-3/4"	US26	109.40	062866		
CTC: 12"	US26D	109.40	086064		
Offset: 2-1/2"	US28	67.90	073571		
Door Thickness: 1-3/4" standard	US32	101.95	078494		
Fasteners: 5/16" - 18 x 2-1/4" FPHMS with washers	US32D	82.55	065800		
Available with 45° offset					
12G					
90° Offset Pull - Round	US3	164.00	060314	-	2
Material: Brass, bronze, aluminum, stainless steel	US4	164.00	081233		
Base: 1" diameter	US10	140.00	043913		
Projection: 2-3/4"	US10B	158.00	076432		
Clearance: 1-3/4"	US26	166.00	078220		
CTC: 8"	US26D	166.00	062954		
Offset: 3"	US28	75.00	070404		
Door Thickness: 1-3/4" standard	US32	180.00	099416		
Fasteners: 5/16" - 18 x 2-1/4" FPHMS with washers	US32D	100.00	060905		
Available with 45° offset					

1. Items with the price in **bold and red** are Quick Ship items and ship in 24 hours.
Please use stock number when ordering. 2. U/M is each unless otherwise noted.



Trim & Auxiliary



Description	Finish	2018 List	Stock No.	Box Qty.	Case Qty.
12J					
90° Offset Pull - Round	US3	165.00	060159	-	2
Material: Brass, bronze, aluminum, stainless steel	US4	126.00	082214		
Base: 1" diameter	US10	163.00	069370		
Projection: 2-3/4"	US10B	162.55	059163		
Clearance: 1-3/4"	US26	165.00	059778		
CTC: 10"	US26D	165.00	068450		
Offset: 3"	US28	90.00	070967		
Door Thickness: 1-3/4" standard	US32	170.00	059561		
Fasteners: 5/16" - 18 x 2-1/4" FPHMS with washers	US32D	102.00	055174		
Available with 45° offset					



12L					
90° Offset Pull - Round	US3	120.75	056782	-	2
Material: Brass, bronze, aluminum, stainless steel	US4	120.75	063686		
Base: 1" diameter	US10	134.85	059327		
Projection: 2-3/4"	US10B	134.85	061587		
Clearance: 1-3/4"	US26	134.85	076229		
CTC: 12"	US26D	134.85	077083		
Offset: 3"	US28	66.70	062011		
Door Thickness: 1-3/4" standard	US32	131.30	067052		
Fasteners: 5/16" - 18 x 2-1/4" FPHMS with washers	US32D	98.15	059815		
Available with 45° offset					



13E					
Push/Pull Set - Round	US3	128.10	061785	1	12
Type 7 mounting	US4	128.10	095631		
Material: Brass, bronze, aluminum, stainless steel	US10	130.55	002512		
Base: 3/4" diameter	US10B	130.55	028794		
Projection: 2-1/4"	US26	130.55	063688		
Clearance: 1-1/2"	US26D	130.55	060821		
Door Thickness: 1-3/4" - 2-1/8"	US28	89.00	076294		
CTC: 6"	US32	143.05	020838		
BTB Mounting type 7 concealed spanner (Required 3/8" min. holes in door)	US32D	117.20	055892		



13G					
Push/Pull Set - Round	US3	147.10	002452	1	12
Type 7 mounting	US4	147.10	018605		
Material: Brass, bronze, aluminum, stainless steel	US10	152.55	056543		
Base: 3/4" diameter	US10B	152.55	057132		
Projection: 2-1/4"	US26	152.55	058650		
Clearance: 1-1/2"	US26D	152.55	096884		
Door Thickness: 1-3/4" - 2-1/8"	US28	97.30	057936		
CTC: 8"	US32	163.25	016398		
BTB Mounting type 7 concealed spanner (Required 3/8" min. holes in door)	US32D	127.00	059203		



13J					
Push/Pull Set - Round	US3	162.40	067010	1	12
Type 7 mounting	US4	162.40	058379		
Material: Brass, bronze, aluminum, stainless steel	US10	169.75	013815		
Base: 3/4" diameter	US10B	169.75	006667		
Projection: 2-1/4"	US26	169.75	043759		
Clearance: 1-1/2"	US26D	169.75	068292		
Door Thickness: 1-3/4" - 2-1/8"	US28	109.05	014475		
CTC: 10"	US32	180.25	032231		
BTB Mounting type 7 concealed spanner (Required 3/8" min. holes in door)	US32D	139.00	063863		





Description	Finish	2018 List	Stock No.	Box Qty.	Case Qty.
13L					
Push/Pull Set - Round	US3	174.90	095055	1	12
Type 7 mounting	US4	174.90	110600		
Material: Brass, bronze, aluminum, stainless steel	US10	198.55	060284		
Base: 3/4" diameter	US10B	198.55	039979		
Projection: 2-1/4"	US26	198.55	070322		
Clearance: 1-1/2"	US26D	198.55	070163		
Door Thickness: 1-3/4" - 2-1/8"	US28	121.65	037236		
CTC: 12"	US32	193.10	034594		
BTB Mounting type 7 concealed spanner (Required 3/8" min. holes in door)	US32D	159.95	084896		



14G					
Push/Pull Set - Round	US3	183.85	056325	1	12
Type 7 mounting	US4	183.85	123899		
Material: Brass, bronze, aluminum, stainless steel	US10	197.70	027836		
Base: 1" diameter	US10B	197.70	019363		
Projection: 2-3/4"	US26	197.70	029353		
Clearance: 1-3/4"	US26D	197.70	077790		
Door Thickness: 1-3/4" - 2-1/8"	US28	126.20	091532		
CTC: 8"	US32	213.70	088849		
BTB Mounting type 7 concealed spanner (Required 3/8" min. holes in door)	US32D	172.00	070068		



14H					
Push/Pull Set - Round	US3	202.45	125548	1	12
Type 7 mounting	US4	212.75	143956		
Material: Brass, bronze, aluminum, stainless steel	US10	214.75	-		
Base: 1" diameter	US10B	214.75	018727		
Projection: 2-3/4"	US26	214.75	-		
Clearance: 1-3/4"	US26D	214.75	034117		
Door Thickness: 1-3/4" - 2-1/8"	US28	126.45	147101		
CTC: 9"	US32	237.80	-		
BTB Mounting type 7 concealed spanner (Required 3/8" min. holes in door)	US32D	184.50	024734		



14J					
Push/Pull Set - Round	US3	204.10	056432	1	8
Type 7 mounting	US4	204.10	028831		
Material: Brass, bronze, aluminum, stainless steel	US10	216.40	066033		
Base: 1" diameter	US10B	216.40	060441		
Projection: 2-3/4"	US26	216.40	059309		
Clearance: 1-3/4"	US26D	216.40	061594		
Door Thickness: 1-3/4" - 2-1/8"	US28	127.90	014601		
CTC: 10"	US32	239.40	084135		
BTB Mounting type 7 concealed spanner (Required 3/8" min. holes in door)	US32D	186.00	067342		



14L					
Push/Pull Set - Round	US3	212.00	086803	1	8
Type 7 mounting	US4	212.00	-		
Material: Brass, bronze, aluminum, stainless steel	US10	241.90	071917		
Base: 1" diameter	US10B	241.90	071108		
Projection: 2-3/4"	US26	241.90	010126		
Clearance: 1-3/4"	US26D	241.90	023138		
Door Thickness: 1-3/4" - 2-1/8"	US28	141.75	100725		
CTC: 12"	US32	259.60	063460		
BTB Mounting type 7 concealed spanner (Required 3/8" min. holes in door)	US32D	210.55	057010		

1. Items with the price in **bold and red** are Quick Ship items and ship in 24 hours. Please use stock number when ordering. 2. U/M is each unless otherwise noted.



Trim & Auxiliary



Description	Finish	2018 List	Stock No.	Box Qty.	Case Qty.
15C Heavy Duty Flush Cup Pull Material: Stainless steel Face: 3-1/2" x 5" Opening: 1-3/4" x 3-1/16" Projection: 1/8" Cup Depth: 3/4" (Cup welded to face plate) Fasteners: #6 x 5/8" OPHWS	US32D	64.65	026410	1	10
15N Flush Cup Pull Material: Brass, bronze, aluminum, stainless steel Face: 3-1/2" x 5" Opening: 1-3/4" x 3-1/16" Projection: 1/8" Cup Depth: 3/4" Fasteners: #6 x 5/8" OPHWS	US3 US4 US10 US10B US26 US26D US28 US32D	58.00 67.60 66.70 66.70 66.70 62.50 25.15 32.50	053114 053115 053116 053117 053118 053119 053120 053121	2	20
15P Heavy Duty Security Flush Cup Pull Material: Stainless steel Face: 3-1/2" x 5" Opening: 1-3/4" x 3-1/16" Projection: 3/16" Cup Depth: 3/4" (Cup welded to face plate) Welded studs for security (2) 6 -32 x 1-1/2" FPHMS (security torx)	US32D	68.45	085266	2	20
15S Light Duty Flush Cup Pull Material: Brass, bronze, aluminum, stainless steel Face: 3-1/2" x 5" Opening: 1-3/4" x 3-1/16" Projection: 1/8" Cup Depth: 3/4" Fasteners: #6 x 5/8" PPHWS Fasteners inside recessed cup	US3 US4 US10 US10B US26 US26D US28 US32D	52.05 58.95 66.70 66.70 66.70 66.70 42.30 43.90	014360 039342 025946 042147 089124 020841 091301 017661	2	20
16N Light Duty Flush Cup Pull Material: Brass, bronze Face: 1-15/16" x 3" Opening: 27/32" x 2-3/8" Projection: 1/16" Cup Depth: 5/8" Fasteners: #8 x 3/4" OPHWS Fasteners inside recessed cup	US3 US4 US10 US10B US26 US26D	24.40 31.50 25.30 25.30 31.50 25.30	073983 010007 074227 068253 068254 067702	2	20





Description	Finish	2018 List	Stock No.	Box Qty.	Case Qty.
16R					
Finger Pull Plate	US3	74.70	018081	2	20
Material: Brass, bronze, aluminum, stainless steel	US4	81.85	141082		
Size: 4" x 16"	US10	81.85	-		
Opening: 1-3/4" x 3-1/16"	US10B	81.85	060151		
Cup Depth: 13/16"	US26	81.85	085308		
Fasteners: #6 x 5/8" OPHWS	US26D	81.85	009524		
	US28	57.30	092065		
	US32	92.25	-		
	US32D	63.75	057855		



17N					
Light Duty Flush Cup Pull	US3	21.45	068535	2	20
Material: Brass, bronze	US4	27.65	077871		
Face: 2-1/2" x 3-31/32"	US10	22.80	068096		
Opening: 1-11/32" x 3-13/32"	US10B	22.80	068255		
Projection: 3/32"	US26	27.65	068256		
Cup Depth: 5/8"	US26D	22.00	067507		
Fasteners: #8 x 13/16" OPHWS					
Fasteners inside recessed cup					



19N					
Cast Pull	US3	67.80	068194	1	20
Material: Brass, bronze	US10	70.55	072477		
Base Diameter: 1-1/2"	US10B	72.75	076217		
Projection: 3-1/8"	US26	72.75	063714		
Clearance: 1-11/16"	US26D	72.75	064247		
CTC: 6-3/16"					
Length O/A: 9"					
Fasteners: #8 x 1" OPHWS					
Suitable for BTB Mounting with sex nuts by special quotation					



20N					
Cast Pull	US3	67.80	058572	1	1
Material: Brass, bronze	US10	72.75	058573		
Base Diameter: 1-1/2"	US10B	72.75	095243		
Projection: 3-1/8"	US26	72.75	017678		
Clearance: 1-11/16"	US26D	72.75	058574		
CTC: 5-7/32"					
Length O/A: 9"					
Fasteners: 1/4" - 20 thru bolts with washers					
Door Thickness: 1-3/4" standard					
Not suitable for BTB Mounting					



20L					
Push/Pull Set - Round	US3	577.25	140460	1	4
Type 7 mounting	US4	610.10	090986		
Material: Brass, bronze, aluminum, stainless steel	US10	610.10	146334		
Base: 1-1/4" diameter	US10B	610.10	019165		
Projection: 3"	US26	610.10	052420		
Clearance: 1-3/4"	US26D	610.10	022949		
CTC: 12"	US28	610.10	-		
Door Thickness: 1-3/4" - 2-1/8" standard	US32	539.60	030891		
BTB Mounting type 7 concealed spanner (Required 7/16" min. holes in door)	US32D	503.75	099136		

1. Items with the price in **bold and red** are Quick Ship items and ship in 24 hours. Please use stock number when ordering. 2. U/M is each unless otherwise noted.



Trim & Auxiliary



Description	Finish	2018 List	Stock No.	Box Qty.	Case Qty.
20Q					
Push/Pull Set - Round	US3	641.45	-	1	4
Type 7 mounting	US4	677.95	-		
Material: Brass, bronze, aluminum, stainless steel	US10	677.95	-		
Base: 1-1/4" diameter	US10B	677.95	105155		
Projection: 3"	US26	677.95	-		
Clearance: 1-3/4"	US26D	677.95	046330		
CTC: 18"	US28	677.95	-		
Door Thickness: 1-3/4" - 2-1/8" standard	US32	417.50	066386		
BTB Mounting type 7 concealed spanner (Required 7/16" min. holes in door)	US32D	559.75	067607		



21E					
90° Offset Push/Pull Set - Round	US3	202.05	138354	-	1
Material: Brass, bronze, aluminum, stainless steel	US4	202.05	-		
Base: 3/4" diameter	US10	211.65	-		
Projection: 2-1/2"	US10B	211.65	012325		
Clearance: 1-3/4"	US26	211.65	071225		
CTC: 6"	US26D	211.65	028763		
Offset: 2-1/2"	US28	147.45	019295		
Door Thickness: 1-3/4" - 2-1/8" standard	US32	214.05	161045		
BTB Mounting Type 7 concealed spanner (Required 3/8" minimum holes in door)	US32D	176.30	089757		
Available with 45° offset					



21G					
90° Offset Push/Pull Set - Round	US3	213.00	058679	-	1
Material: Brass, bronze, aluminum, stainless steel	US4	213.00	043225		
Base: 3/4" diameter	US10	222.90	-		
Projection: 2-1/2"	US10B	222.90	063310		
Clearance: 1-3/4"	US26	222.90	018016		
CTC: 8"	US26D	222.90	066826		
Offset: 2-1/2"	US28	161.50	-		
Door Thickness: 1-3/4" - 2-1/8" standard	US32	224.65	025013		
BTB Mounting Type 7 concealed spanner (Required 3/8" minimum holes in door)	US32D	189.45	058003		
Available with 45° offset					



21J					
90° Offset Push/Pull Set - Round	US3	220.20	078909	-	1
Material: Brass, bronze, aluminum, stainless steel	US4	220.20	-		
Base: 3/4" diameter	US10	237.95	005255		
Projection: 2-1/2"	US10B	237.95	057372		
Clearance: 1-3/4"	US26	237.95	005678		
CTC: 10"	US26D	237.95	067008		
Offset: 2-1/2"	US28	165.65	112219		
Door Thickness: 1-3/4" - 2-1/8" standard	US32	231.50	019770		
BTB Mounting Type 7 concealed spanner (Required 3/8" minimum holes in door)	US32D	196.50	080009		
Available with 45° offset					





Description	Finish	2018 List	Stock No.	Box Qty.	Case Qty.
21L					
90° Offset Push/Pull Set - Round					
Material: Brass, bronze, aluminum, stainless steel	US3	234.65	097140	-	1
Base: 3/4" diameter	US4	234.65	002578		
Projection: 2-1/2"	US10	261.70	-		
Clearance: 1-3/4"	US10B	261.70	042312		
CTC: 12"	US26	261.70	007396		
Offset: 2-1/2"	US26D	261.70	032790		
Door Thickness: 1-3/4" - 2-1/8" standard	US28	177.35	047803		
BTB Mounting Type 7 concealed spanner (Required 3/8" minimum holes in door)	US32	245.60	027578		
Available with 45° offset	US32D	207.05	069905		



22G					
90° Offset Push/Pull Set - Round	US3	255.15	079012	-	1
Material: Brass, bronze, aluminum, stainless steel	US4	255.15	-		
Base: 1" diameter	US10	286.00	075421		
Projection: 2-3/4"	US10B	286.00	096184		
Clearance: 1-3/4"	US26	286.00	048693		
CTC: 8"	US26D	286.00	007328		
Offset: 3"	US28	155.45	024277		
Door Thickness: 1-3/4" - 2-1/8" standard	US32	256.85	098201		
BTB Mounting Type 7 concealed spanner (Required 3/8" minimum holes in door)	US32D	253.30	067908		
Available with 45° offset					



22J					
90° Offset Push/Pull Set - Round	US3	269.10	075192	-	1
Material: Brass, bronze, aluminum, stainless steel	US4	269.10	-		
Base: 1" diameter	US10	301.40	050773		
Projection: 2-3/4"	US10B	301.40	058192		
Clearance: 1-3/4"	US26	301.40	005787		
CTC: 10"	US26D	301.40	085517		
Offset: 3"	US28	167.10	002376		
Door Thickness: 1-3/4" - 2-1/8" standard	US32	280.35	073277		
BTB Mounting Type 7 concealed spanner (Required 3/8" minimum holes in door)	US32D	272.90	076699		
Available with 45° offset					



22L					
90° Offset Push/Pull Set - Round	US3	283.00	073970	-	1
Material: Brass, bronze, aluminum, stainless steel	US4	283.00	078417		
Base: 1" diameter	US10	320.05	000477		
Projection: 2-3/4"	US10B	320.05	080383		
Clearance: 1-3/4"	US26	320.05	015975		
CTC: 12"	US26D	320.05	038687		
Offset: 3"	US28	178.55	000794		
Door Thickness: 1-3/4" - 2-1/8" standard	US32	303.50	059202		
BTB Mounting Type 7 concealed spanner (Required 3/8" minimum holes in door)	US32D	292.90	064503		
Available with 45° offset					



22N					
Concealed Edge Pull	US3	71.95	086819	1	10
Material: Solid brass	US26D	78.20	086820		
Size: 3 1/32" x 4-1/4" x 3/8"					
Finger piece extends: 2-3/4"					
Fasteners: #6 x 3/4" FPHWS					

1. Items with the price in **bold and red** are Quick Ship items and ship in 24 hours.
Please use stock number when ordering. 2. U/M is each unless otherwise noted.



Trim & Auxiliary



Description	Finish	2018 List	Stock No.	Box Qty.	Case Qty.
23Q					
90° Offset Pull - Round	US3	361.00	006390	-	2
Material: Brass, bronze, aluminum, stainless steel	US4	361.00	029999		
Base Diameter: 1-1/4"	US10	380.50	021472		
Projection: 3"	US10B	380.50	017369		
Clearance: 1-3/4"	US26	380.50	019785		
CTC: 18"	US26D	380.50	023673		
Offset: 3-3/4" standard	US28	135.45	049363		
Fasteners: 5/16" - 18 thru bolt w/ washer	US32	332.05	002751		
Door Thickness: 1-3/4" - 2-1/8" standard	US32D	284.60	080011		
Available with 45° offset					



24Q					
90° Offset Push/Pull Set - Round	US3	768.35	003843	-	1
Material: Brass, bronze, aluminum, stainless steel	US4	768.35	134285		
Base Diameter: 1-1/4"	US10	807.20	043201		
Projection: 3"	US10B	807.20	024989		
Clearance: 1-3/4"	US26	807.20	-		
CTC: 18"	US26D	807.20	-		
Offset: 3-3/4"	US28	289.40	095347		
Door Thickness: 1-3/4" - 2-1/8" standard	US32	710.95	-		
BTB Mounting Type 7 concealed spanner (Required 3/8" minimum holes in door)	US32D	614.35	067055		
Available with 45° offset					



25B					
Security Flush Pull Set	US32D	131.70	025035	1	10
Material: Stainless steel					
Face: 3-1/2" x 5"					
Opening: 1-3/4" x 3-1/16"					
Projection: 3/16"					
Cup Depth: 3/4"					
Fasteners: (2) 6 - 32 x 1-1/2" FPHMS (security torx)					



25C					
Heavy Duty Flush Pull Set	US32D	127.75	008405	1	10
Material: Stainless steel					
Face: 3-1/2" x 5"					
Opening: 1-3/4" x 3-1/16"					
Projection: 1/8"					
Cup Depth: 3/4"					
Fasteners: (4) 6 -32 OPHMS with sex nuts and bolts					
Consists of 2 ea. 15C pulls BTB					



25N					
Flush Pull Set	US3	127.80	057171	1	10
Material: Brass, bronze, aluminum, stainless steel	US4	127.80	069686		
Face: 3-1/2" x 5"	US10	131.50	064913		
Opening: 1-3/4" x 3-1/16"	US10B	131.50	075384		
Projection: 1/8"	US26	131.50	087487		
Cup Depth: 3/4"	US26D	131.50	055307		
Fasteners: (4) 6 -32 OPHMS with sex nuts and bolts	US28	97.95	074843		
Consists of 2 ea. 15N pulls BTB	US32D	55.00	066502		





Description	Finish	2018 List	Stock No.	Box Qty.	Case Qty.
25P Security Finger Pull/Push Plate Set Material: Stainless steel Base: 4" x 16" Opening: 1-3/4" x 3-1/16" Projection: 1/8" Fasteners: 8 - 32 x 3/4" FPHMS (security torx) sex nuts and bolts	US32D	267.85	089518	1	10
26N Security Finger Pull Material: Brass, stainless steel Face: 4" x 5" Opening: 1-5/8" x 3" Projection: 1/8" Cup Depth: 13/16" Fasteners: 1/4" - 20 x 3/4" security torx FPHMS	US4 US26 US32D	71.30 97.60 102.55	024671 036321 017790	2	20
27N Security Flush Cup Pull Material: Stainless steel Face: 5" x 5" Opening: 3" x 3-1/2" Projection: 3/8" Cup Depth: 7/8" Fasteners: 10 - 24 FPHMS (security torx) sex nuts and thru bolts Not available for BTB Mounting	US32D	133.35	006749	2	20
27P Security Flush Cup Pull Material: Stainless steel Face: 5" x 5" Opening: 3" x 3-1/2" Projection: 3/8" Cup Depth: 7/8" Fasteners: 1/4 - 20 x 3/4" FPHMS (security torx) Not available for BTB Mounting	US32D	133.35	013714	2	20

1. Items with the price in **bold and red** are Quick Ship items and ship in 24 hours. Please use stock number when ordering. 2. U/M is each unless otherwise noted.



Trim & Auxiliary



Description	Finish	2018 List	Stock No.	Box Qty.	Case Qty.
305					
Push Plate - Square Corner					
Material: Brass, bronze, aluminum, stainless steel					
Gauge: 0.050					
Fasteners: #6 x 5/8" OPH tapping screws					
3" x 12"	US3	17.10	052473	5	50
	US4	17.10	053057		
	US10	20.40	052603		
	US10B	20.40	052604		
	US26	20.40	052788		
	US26D	20.40	052605		
	US28	10.75	052606		
	US32	15.40	060400		
	US32D	12.50	052607		
3-1/2" x 15"	US3	23.05	051947	5	50
	US4	24.50	053058		
	US10	28.00	052474		
	US10B	28.00	052475		
	US26	28.00	051948		
	US26D	27.00	052608		
	US28	10.20	051949		
	US32	14.00	067703		
	US32D	10.50	052476		
4" x 16"	US3	27.00	052477	5	50
	US4	26.50	053059		
	US10	29.50	052478		
	US10B	29.50	052479		
	US26	29.50	052789		
	US26D	28.50	052480		
	US28	11.40	052481		
	US32	15.50	056570		
	US32D	11.05	052482		
6" x 16"	US3	38.50	052609	-	5
	US4	38.50	016001		
	US10	43.50	052610		
	US10B	43.50	052611		
	US26	43.50	052612		
	US26D	42.50	052613		
	US28	15.75	052614		
	US32	23.40	059757		
	US32D	15.75	052615		
8" x 16"	US3	47.35	052616	-	5
	US4	47.35	053054		
	US10	54.30	052617		
	US10B	54.30	052618		
	US26	54.30	052619		
	US26D	53.30	052620		
	US28	17.55	052621		
	US32	29.25	056697		
	US32D	21.40	052483		





Description	Finish	2018 List	Stock No.	Box Qty.	Case Qty.
A30S					
Push Plate - Square Corner					
Material: Brass, bronze, aluminum, stainless steel					
Gauge: 0.062					
Fasteners: #6 x 5/8" OPH tapping screws					
3" x 12"	US3	28.10	088064	5	50
	US4	28.10	040610		
	US10	32.60	089728		
	US10B	32.60	057228		
	US26	32.60	083774		
	US26D	32.60	002164		
	US28	13.75	-		
	US32	26.10	-		
	US32D	16.75	018593		
3-1/2" x 15"	US3	30.30	086010	5	50
	US4	30.30	125264		
	US10	36.65	060451		
	US10B	36.65	095370		
	US26	36.65	041812		
	US26D	36.65	050973		
	US28	15.30	095372		
	US32	31.80	014761		
	US32D	21.25	095371		
4" x 16"	US3	34.25	088141	5	50
	US4	34.25	096314		
	US10	40.35	018240		
	US10B	40.35	026224		
	US26	40.35	068218		
	US26D	40.35	088369		
	US28	16.50	098928		
	US32	33.45	071242		
	US32D	23.25	084940		
6" x 16"	US3	49.65	146109	-	5
	US4	49.65	147465		
	US10	55.80	008731		
	US10B	55.80	094683		
	US26	55.80	098852		
	US26D	55.80	001249		
	US28	21.65	098000		
	US32	56.80	-		
	US32D	38.70	052271		
8" x 16"	US3	53.70	046204	-	5
	US4	53.70	065722		
	US10	59.75	089364		
	US10B	59.75	025549		
	US26	59.75	053802		
	US26D	59.75	092477		
	US28	28.80	-		
	US32	70.00	104412		
	US32D	43.30	081011		

1. Items with the price in **bold and red** are Quick Ship items and ship in 24 hours.
 Please use stock number when ordering. 2. U/M is each unless otherwise noted.



Trim & Auxiliary



Description	Finish	2018 List	Stock No.	Box Qty.	Case Qty.
31E					
Pull Plate - Square Corner - Half Round Pull					
Material: Brass, bronze, aluminum, stainless steel					
Gauge: 0.050; CTC: 6"					
30S x 1E Pull					
Fasteners: #6 x 5/8" OPH tapping screws					
3-1/2" x 15"					
	US3	79.50	056433	1	10
	US4	79.50	060011		
	US10	84.50	055633		
	US10B	84.50	058712		
	US26	84.50	078715		
	US26D	79.50	054517		
	US28	38.50	054428		
	US32	79.80	071221		
	US32D	57.00	054029		
4" x 16"	US3	80.50	052652	1	10
	US4	80.50	053049		
	US10	85.50	052653		
	US10B	85.50	052493		
	US26	85.50	052800		
	US26D	80.75	054341		
	US28	39.50	052654		
	US32	90.00	062509		
	US32D	68.20	052494		



31G					
Pull Plate - Square Corner - Half Round Pull					
Material: Brass, bronze, aluminum, stainless steel					
Gauge: 0.050; CTC: 8"					
30S x 1G Pull					
Fasteners: #6 x 5/8" OPH tapping screws					
3-1/2" x 15"					
	US3	80.95	058350	1	10
	US4	80.95	085438		
	US10	88.90	057757		
	US10B	88.90	058681		
	US26	88.90	064372		
	US26D	88.90	058351		
	US28	42.50	055483		
	US32	99.90	041049		
	US32D	65.00	055482		
4" x 16"	US3	86.00	056514	1	10
	US4	86.00	064373		
	US10	90.45	058057		
	US10B	90.45	059416		
	US26	90.45	059035		
	US26D	90.45	056759		
	US28	45.00	056350		
	US32	105.80	095219		
	US32D	66.00	055297		





Description	Finish	2018 List	Stock No.	Box Qty.	Case Qty.
31J					
Pull Plate - Square Corner - Half Round Pull					
Material: Brass, bronze, aluminum, stainless steel					
Gauge: 0.050; CTC: 10"					
30S x 1J Pull					
Fasteners: #6 x 5/8" OPH tapping screws					
3-1/2" x 15"					
	US3	92.10	011268	1	10
	US4	95.90	065208		
	US10	99.35	700006		
	US10B	99.35	067881		
	US26	99.35	-		
	US26D	99.35	081194		
	US28	49.30	116104		
	US32	111.15	077157		
	US32D	86.15	056322		
4" x 16"	US3	93.85	125465	1	10
	US4	97.10	049246		
	US10	103.00	063316		
	US10B	103.00	062373		
	US26	103.00	-		
	US26D	103.00	021574		
	US28	51.55	050497		
	US32	104.75	068294		
	US32D	89.55	062377		
32E					
Pull Plate - Square Corner - Rectangular Pull					
Material: Brass, bronze, aluminum, stainless steel					
Gauge: 0.050; CTC: 6"					
Fasteners: #6 x 5/8" OPH tapping screws					
30S x 2E Pull					
3-1/2" x 15"					
	US3	63.70	052642	1	10
	US4	60.95	053047		
	US10	79.50	052643		
	US10B	79.50	052644		
	US26	79.50	052797		
	US26D	79.50	052645		
	US28	33.50	052646		
	US32	66.95	067882		
	US32D	47.00	052647		
4" x 16"	US3	71.00	052648	1	10
	US4	71.00	053048		
	US10	81.50	052798		
	US10B	81.50	052492		
	US26	81.50	052799		
	US26D	81.50	052649		
	US28	35.50	052650		
	US32	77.35	060399		
	US32D	49.00	052651		



1. Items with the price in **bold and red** are Quick Ship items and ship in 24 hours.
 Please use stock number when ordering. 2. U/M is each unless otherwise noted.



Trim & Auxiliary



Description	Finish	2018 List	Stock No.	Box Qty.	Case Qty.
32G					
Pull Plate - Square Corner - Rectangular Pull					
Material: Brass, bronze, aluminum, stainless steel					
Gauge: 0.050; CTC: 8"					
Fasteners: #6 x 5/8" OPH tapping screws					
30S x 2G Pull					
3-1/2" x 15"	US3	73.70	059981	1	10
	US4	73.70	085113		
	US10	86.05	-		
	US10B	85.50	066040		
	US26	86.05	-		
	US26D	84.50	060646		
	US28	44.50	063926		
	US32	86.15	-		
	US32D	60.00	055010		
4" x 16"	US3	84.50	054727	1	10
	US4	84.50	003510		
	US10	89.50	056784		
	US10B	89.50	056756		
	US26	89.00	065122		
	US26D	89.50	069514		
	US28	48.50	069513		
	US32	93.25	017637		
	US32D	64.00	055389		
32J					
Pull Plate - Square Corner - Rectangular Pull					
Material: Brass, bronze, aluminum, stainless steel					
Gauge: 0.050; CTC: 10"					
Fasteners: #6 x 5/8" OPH tapping screws					
30S x 2J Pull					
3-1/2" x 15"	US3	86.05	043039	1	10
	US4	88.55	-		
	US10	94.70	118724		
	US10B	94.70	022532		
	US26	94.70	-		
	US26D	94.70	-		
	US28	40.65	-		
	US32	102.35	-		
	US32D	86.15	019279		
4" x 16"	US3	89.40	032063	1	10
	US4	94.25	139843		
	US10	97.60	117572		
	US10B	97.60	005155		
	US26	97.60	029867		
	US26D	97.60	044540		
	US28	44.10	-		
	US32	106.65	040153		
	US32D	91.40	069243		





Description	Finish	2018 List	Stock No.	Box Qty.	Case Qty.
33E					
Pull Plate - Square Corner					
3/4" Round Pull					
Material: Brass, bronze, aluminum, stainless steel					
Gauge: 0.050; CTC: 6"					
Fasteners: #6 x 5/8" OPH tapping screws					
30S x 3E Pull					
3-1/2" x 15"					
	US3	67.00	052655	1	10
	US4	67.00	053044		
	US10	75.50	052656		
	US10B	75.50	052657		
	US26	75.50	052801		
	US26D	75.50	052658		
	US28	32.50	052659		
	US32	55.00	074228		
	US32D	37.40	052660		
<hr/>					
4" x 16"	US3	73.00	052661	1	10
	US4	73.00	016002		
	US10	79.25	053045		
	US10B	79.25	052662		
	US26	79.25	052802		
	US26D	79.25	052663		
	US28	36.50	052664		
	US32	62.00	056516		
	US32D	38.50	052665		



33G					
Pull Plate - Square Corner - 3/4" Round Pull					
Material: Brass, bronze, aluminum, stainless steel					
Gauge: 0.050; CTC: 8"					
Fasteners: #6 x 5/8" OPH tapping screws					
30S x 3G Pull					
3-1/2" x 15"					
	US3	75.00	052667	1	10
	US4	75.00	053046		
	US10	82.50	052495		
	US10B	82.50	052668		
	US26	82.50	052803		
	US26D	76.00	052669		
	US28	35.50	052670		
	US32	60.00	002398		
	US32D	37.60	052666		
<hr/>					
4" x 16"	US3	80.10	052671	1	10
	US4	80.10	053060		
	US10	87.50	052672		
	US10B	87.50	052673		
	US26	87.50	052804		
	US26D	82.10	005274		
	US28	37.50	052675		
	US32	64.30	063728		
	US32D	39.60	052676		

1. Items with the price in **bold and red** are Quick Ship items and ship in 24 hours.
Please use stock number when ordering. 2. U/M is each unless otherwise noted.



Trim & Auxiliary



Description	Finish	2018 List	Stock No.	Box Qty.	Case Qty.
33J					
Pull Plate - Square Corner - 3/4" Round Pull					
Material: Brass, bronze, aluminum, stainless steel					
Gauge: 0.050; CTC: 10"					
Fasteners: #6 x 5/8" OPH tapping screws					
30S x 3J Pull					
3-1/2" x 15"	US3	76.95	076230	1	10
	US4	79.20	048521		
	US10	82.50	071881		
	US10B	82.50	006002		
	US26	82.50	113458		
	US26D	82.50	112480		
	US28	45.35	054673		
	US32	91.25	067662		
	US32D	74.75	065235		
4" x 16"	US3	82.80	087358	1	10
	US4	86.55	080814		
	US10	90.30	059652		
	US10B	90.30	077870		
	US26	90.30	135368		
	US26D	90.30	092249		
	US28	47.90	060024		
	US32	94.95	068874		
	US32D	77.25	057608		



34G					
Pull Plate - Square Corner - 1" Round Pull					
Material: Brass, bronze, aluminum, stainless steel					
Gauge: 0.050; CTC: 8"					
Fasteners: #6 x 5/8" OPH tapping screws					
30S x 4G Pull					
3-1/2" x 15"	US3	90.45	052888	1	10
	US4	97.60	022822		
	US10	101.75	052890		
	US10B	101.75	052891		
	US26	101.75	068374		
	US26D	101.75	052893		
	US28	50.55	143095		
	US32	103.60	-		
	US32D	88.00	051944		
4" x 16"	US3	93.25	052894	1	10
	US4	99.35	052895		
	US10	104.70	052896		
	US10B	104.70	052897		
	US26	104.70	052898		
	US26D	104.70	052899		
	US28	51.55	052900		
	US32	105.65	062950		
	US32D	91.25	052901		





Description	Finish	2018 List	Stock No.	Box Qty.	Case Qty.
34J					
Pull Plate - Square Corner - 1" Round Pull					
Material: Brass, bronze, aluminum, stainless steel					
Gauge: 0.050; CTC: 10"					
Fasteners: #6 x 5/8" OPH tapping screws					
30S x 4J Pull					
3-1/2" x 15"	US3	113.75	088937	1	10
	US4	113.75	023595		
	US10	123.45	065332		
	US10B	125.60	057755		
	US26	119.00	040243		
	US26D	119.00	068488		
	US28	40.25	095443		
	US32	88.00	069479		
	US32D	68.50	059558		
4" x 16"	US3	114.50	058218	1	10
	US4	114.50	076042		
	US10	124.50	054937		
	US10B	129.00	056339		
	US26	122.50	067490		
	US26D	122.50	063209		
	US28	41.00	065718		
	US32	91.10	074891		
	US32D	69.60	056278		



35D					
Pull Plate - Square Corner - 5/8" Round Pull					
Material: Brass, bronze, aluminum, stainless steel					
Gauge: 0.050; CTC: 5-1/2"					
Fasteners: #6 x 5/8" OPH tapping screws					
30S x 5D Pull					
3-1/2" x 15"	US3	58.50	048502	1	10
	US4	58.50	029931		
	US10	62.15	048500		
	US10B	62.15	048503		
	US26	62.15	057278		
	US26D	62.15	024259		
	US28	29.10	048501		
	US32	59.90	163371		
	US32D	30.90	048505		
4" x 16"	US3	62.15	048508	1	10
	US4	62.15	028846		
	US10	64.15	048506		
	US10B	64.15	048509		
	US26	64.15	012741		
	US26D	64.15	048510		
	US28	30.25	048507		
	US32	52.45	071154		
	US32D	33.75	048511		

1. Items with the price in **bold and red** are Quick Ship items and ship in 24 hours.
 Please use stock number when ordering. 2. U/M is each unless otherwise noted.



Trim & Auxiliary



Description	Finish	2018 List	Stock No.	Box Qty.	Case Qty.
35N					
Pull Plate - Square Corner - Cast Pull					
Material: Brass, bronze, aluminum, stainless steel					
Gauge: 0.050; CTC: 5-1/2"					
Fasteners: #6 x 5/8" OPH tapping screws					
30S x 5N Pull					
3-1/2" x 15"	US3	61.65	052487	1	10
	US4	62.65	053051		
	US10	66.25	052637		
	US10B	66.25	052488		
	US26	66.25	052794		
	US26D	66.25	053052		
	US28	39.25	052489		
	US32	90.35	057091		
	US32D	56.70	052490		
4" x 16"	US3	63.00	052639	1	10
	US4	64.65	007485		
	US10	69.75	052795		
	US10B	69.75	052640		
	US26	69.75	028998		
	US26D	69.75	052641		
	US28	40.10	016004		
	US32	98.90	030733		
	US32D	58.70	052491		



36N					
Pull Plate - Square Corner					
Material: Brass, bronze, aluminum, stainless steel					
Gauge: 0.050; CTC: 5-1/2"					
Fasteners: #6 x 5/8" OPH tapping screws					
30S x 6N Pull					
3-1/2" x 15"	US3	57.85	052484	1	10
	US4	57.85	053056		
	US10	60.25	052628		
	US10B	60.25	052629		
	US26	60.25	052792		
	US26D	60.25	052630		
	US28	31.75	052485		
	US32	79.80	098946		
	US32D	46.00	052631		
4" x 16"	US3	59.85	052632	1	10
	US4	59.85	053050		
	US10	62.25	052633		
	US10B	62.25	052634		
	US26	62.25	052793		
	US26D	62.25	052635		
	US28	33.75	052636		
	US32	87.45	064685		
	US32D	46.75	052486		





Description	Finish	2018 List	Stock No.	Box Qty.	Case Qty.
39E					
Pull Plate - Square Corner - 3/4" Oval Pull					
Material: Brass, bronze, aluminum, stainless steel					
Gauge: 0.050; CTC: 6"					
Fasteners: #6 x 5/8" OPH tapping screws					
30S x 9E Pull					
3-1/2" x 15"	US3	57.50	066457	1	10
	US4	57.50	068631		
	US10	59.50	066451		
	US10B	59.50	066452		
	US26	78.90	066453		
	US26D	65.90	064908		
	US32	70.00	092653		
	US32D	54.00	066454		
4" x 16"	US3	59.50	066242	1	10
	US4	59.50	094002		
	US10	63.50	066459		
	US10B	63.50	066460		
	US26	82.80	-		
	US26D	67.90	066286		
	US32	74.00	083352		
	US32D	55.00	066241		



39G					
Pull Plate - Square Corner - 3/4" Oval Pull					
Material: Brass, bronze, aluminum, stainless steel					
Gauge: 0.050; CTC: 8"					
Fasteners: #6 x 5/8" OPH tapping screws					
30S x 9G Pull					
3-1/2" x 15"	US3	59.75	066446	1	10
	US4	59.75	022286		
	US10	64.30	066439		
	US10B	64.30	066440		
	US26	82.45	125056		
	US26D	68.90	021978		
	US32	74.85	113343		
	US32D	55.00	066442		
4" x 16"	US3	63.75	066448	1	10
	US4	63.75	074705		
	US10	68.65	066449		
	US10B	68.65	066450		
	US26	86.45	066443		
	US26D	72.85	070325		
	US32	78.85	019174		
	US32D	57.00	066444		

1. Items with the price in **bold and red** are Quick Ship items and ship in 24 hours.
Please use stock number when ordering. 2. U/M is each unless otherwise noted.



Trim & Auxiliary



Description	Finish	2018 List	Stock No.	Box Qty.	Case Qty.
391					
Pull Plate - Square Corner - 3/4" Oval Pull					
Material: Brass, bronze, aluminum, stainless steel					
Gauge: 0.050; CTC: 10"					
Fasteners: #6 x 5/8" OPH tapping screws					
30S x 9J Pull					
3-1/2" x 15"	US3	76.35	086925	1	10
	US4	92.50	-		
	US10	92.50	124357		
	US10B	92.50	039926		
	US26	103.20	-		
	US26D	98.40	-		
	US32	95.60	-		
	US32D	82.25	005157		
4" x 16"	US3	75.25	086628	1	10
	US4	93.05	-		
	US10	93.05	112185		
	US10B	93.05	033458		
	US26	106.25	106111		
	US26D	103.00	076007		
	US32	96.35	-		
	US32D	83.75	074073		





Description	Finish	2018 List	Stock No.	Box Qty.	Case Qty.
40R					
Push Plate - Radius Corner - Not Beveled					
Material: Brass, bronze, aluminum, stainless steel					
Gauge: 0.050					
Fasteners: #6 x 5/8" OPH tapping screws					
3" x 12"	US3	22.70	073770	10	50
	US4	23.55	076051		
	US10	27.30	066942		
	US10B	27.30	003979		
	US26	27.30	066131		
	US26D	27.30	074534		
	US28	14.20	043755		
	US32	21.25	066229		
	US32D	18.25	-		
3-1/2" x 15"	US3	26.20	058476	10	50
	US4	29.10	080655		
	US10	31.45	057093		
	US10B	31.45	025774		
	US26	31.45	086949		
	US26D	31.45	059230		
	US28	15.30	066906		
	US32	24.60	059562		
	US32D	21.25	-		
4" x 16"	US3	28.90	058347	10	50
	US4	31.90	081497		
	US10	34.35	016005		
	US10B	34.35	060152		
	US26	34.35	059245		
	US26D	34.35	085378		
	US28	16.05	016006		
	US32	26.50	088231		
	US32D	22.80	052790		
6" x 16"	US3	40.35	057640	-	5
	US4	43.40	047040		
	US10	47.15	006018		
	US10B	47.15	072734		
	US26	47.15	-		
	US26D	47.15	114027		
	US28	20.85	010887		
	US32	49.75	088229		
	US32D	34.75	057637		
8" x 16"	US3	47.35	025145	-	5
	US4	52.65	022787		
	US10	56.80	015792		
	US10B	56.80	061212		
	US26	56.80	126198		
	US26D	56.80	024628		
	US28	23.75	122600		
	US32	50.55	-		
	US32D	51.80	061211		

1. Items with the price in **bold and red** are Quick Ship items and ship in 24 hours.
 Please use stock number when ordering. 2. U/M is each unless otherwise noted.



Trim & Auxiliary



Description	Finish	2018 List	Stock No.	Box Qty.	Case Qty.
A40R					
Push Plate - Radius Corner - Not Beveled					
Material: Brass, bronze, aluminum, stainless steel					
Gauge: 0.062					
Fasteners: #6 x 5/8" OPH tapping screws					
3" x 12"	US3	33.45	032130	10	50
	US4	33.45	131011		
	US10	38.05	-		
	US10B	38.05	114771		
	US26	38.05	039363		
	US26D	38.05	114030		
	US28	22.80	-		
	US32	33.25	-		
	US32D	23.25	048868		
3-1/2" x 15"	US3	35.70	-	10	50
	US4	35.70	049913		
	US10	42.00	-		
	US10B	42.00	074760		
	US26	42.00	044606		
	US26D	42.00	038686		
	US28	20.50	-		
	US32	39.25	-		
	US32D	27.45	059304		
4" x 16"	US3	39.60	029232	10	50
	US4	39.60	014136		
	US10	45.85	140485		
	US10B	45.85	077017		
	US26	45.85	-		
	US26D	45.85	015454		
	US28	21.70	047411		
	US32	41.30	135831		
	US32D	29.90	099623		
6" x 16"	US3	52.50	029232	-	5
	US4	57.10	-		
	US10	57.10	-		
	US10B	57.10	-		
	US26	57.10	-		
	US26D	57.10	055405		
	US28	26.80	-		
	US32	64.65	-		
	US32D	46.95	070607		
8" x 16"	US3	58.40	076399	-	5
	US4	64.10	-		
	US10	65.05	-		
	US10B	65.05	077019		
	US26	65.05	-		
	US26D	65.05	142995		
	US28	30.15	-		
	US32	81.90	-		
	US32D	49.75	001398		





Description	Finish	2018 List	Stock No.	Box Qty.	Case Qty.
50T					
Push Plate - Round - Not Beveled					
Material: Brass, bronze, aluminum, stainless steel					
Gauge: 0.050					
Fasteners: #6 x 5/8" OPH tapping screws					
3" x 12"	US3	27.45	078618	5	50
	US4	27.45	007196		
	US10	29.90	006322		
	US10B	29.90	071333		
	US26	29.90	-		
	US26D	29.90	102851		
	US28	20.25	102662		
	US32	23.85	-		
	US32D	22.80	059934		
3-1/2" x 15"	US3	28.90	057418	5	50
	US4	28.90	077529		
	US10	34.25	088168		
	US10B	34.25	000846		
	US26	34.25	075140		
	US26D	34.25	062792		
	US28	22.40	041167		
	US32	27.30	015650		
	US32D	25.05	072371		
4" x 16"	US3	31.90	056970	5	50
	US4	31.90	068950		
	US10	36.65	058204		
	US10B	36.65	075002		
	US26	36.65	059593		
	US26D	36.65	092668		
	US28	23.85	018465		
	US32	26.50	000492		
	US32D	29.50	016007		

1. Items with the price in **bold and red** are Quick Ship items and ship in 24 hours.
 Please use stock number when ordering. 2. U/M is each unless otherwise noted.



Trim & Auxiliary



Description	Finish	2018 List	Stock No.	Box Qty.	Case Qty.
A50T					
Push Plate - Round - Not Beveled					
Material: Brass, bronze, aluminum, stainless steel					
Gauge: 0.062					
Fasteners: #6 x 5/8" OPH tapping screws					
3" x 12"	US3	43.40	094264	5	50
	US4	43.40	107968		
	US10	48.10	-		
	US10B	48.10	095264		
	US26	48.10	075708		
	US26D	48.10	079997		
	US28	27.30	097574		
	US32	37.80	-		
	US32D	32.25	034543		
3-1/2" x 15"	US3	45.10	099962	5	50
	US4	45.10	094532		
	US10	52.90	-		
	US10B	52.90	054241		
	US26	52.90	014282		
	US26D	52.90	069277		
	US28	31.70	-		
	US32	39.25	-		
	US32D	33.25	084951		
4" x 16"	US3	48.90	084171	5	50
	US4	48.90	075929		
	US10	56.65	130057		
	US10B	56.65	111705		
	US26	56.65	134570		
	US26D	56.65	032134		
	US28	33.25	039648		
	US32	41.30	053431		
	US32D	36.35	031281		
60S					
Push Plate - Square Corner - Beveled					
Material: Plastic Laminate					
Gauge: 0.125					
Fasteners: #6 x 5/8" OPH tapping screws					
3" x 12"	PG - Gray	10.75	-	5	50
	PK - Black	10.75	067121		
	CO - Brown	10.75	035206		
3-1/2" x 15"	PG - Gray	11.55	-	5	50
	PK - Black	11.55	055792		
	CO - Brown	11.55	085523		
4" x 16"	PG - Gray	12.20	072811	5	50
	PK - Black	12.20	056442		
	CO - Brown	12.20	076032		
6" x 16"	PG - Gray	15.30	094770	5	50
	PK - Black	15.30	056581		
	CO - Brown	15.30	076033		
8" x 16"	PG - Gray	18.25	029886	5	50
	PK - Black	18.25	-		
	CO - Brown	18.25	061399		





Description	Finish	2018 List	Stock No.	Box Qty.	Case Qty.
70S					
Push Plate - Square Corner - Beveled					
Material: Clear Plastic Laminate					
Gauge: 0.125					
Fasteners: #6 x 5/8" OPH tapping screws					
3" x 12"	PC - Clear	10.75	057033	5	50
3-1/2" x 15"	PC - Clear	12.15	056757	5	50
6" x 16"	PC - Clear	17.35	058687	5	50
8" x 16"	PC - Clear	20.00	062760	5	50

1. Items with the price in **bold and red** are Quick Ship items and ship in 24 hours.
 Please use stock number when ordering. 2. U/M is each unless otherwise noted.



Trim & Auxiliary



Description	Finish	2018 List	Stock No.	Box Qty.	Case Qty.
80S					
Push Plate - Square Corner - Beveled					
Material: Brass, bronze, aluminum, stainless steel					
Gauge: 0.125					
Fasteners: #6 x 5/8" OPH tapping screws					
3" x 12"	US3	48.80	018566	5	50
	US4	51.55	-		
	US10	57.10	110525		
	US10B	57.10	053549		
	US26	57.10	113461		
	US26D	57.10	064583		
	US28	24.15	147832		
	US32	52.05	142047		
	US32D	40.50	021042		
3-1/2" x 15"	US3	54.05	099583	5	50
	US4	59.20	000935		
	US10	62.85	080441		
	US10B	62.85	064035		
	US26	62.85	023445		
	US26D	62.85	098464		
	US28	27.85	085960		
	US32	56.90	123564		
	US32D	29.50	066719		
4" x 16"	US3	67.50	069050	5	50
	US4	67.50	053351		
	US10	70.00	070736		
	US10B	70.00	080514		
	US26	67.80	003451		
	US26D	67.80	099998		
	US28	29.40	000740		
	US32	59.15	081409		
	US32D	37.50	064974		
6" x 16"	US3	79.60	125266	-	5
	US4	81.85	138751		
	US10	84.40	134181		
	US10B	84.40	057343		
	US26	84.40	-		
	US26D	84.40	024257		
	US28	43.40	111496		
	US32	75.55	033372		
	US32D	58.10	062560		
8" x 16"	US3	101.05	024903	-	5
	US4	103.00	122088		
	US10	103.00	042324		
	US10B	106.10	041316		
	US26	106.10	078222		
	US26D	106.10	-		
	US28	52.90	-		
	US32	93.65	021592		
	US32D	72.15	073791		





Description	Finish	2018 List	Stock No.	Box Qty.	Case Qty.
90R					
Push Plate - Radius Corner - Not Beveled					
Material: Brass, bronze, aluminum, stainless steel					
Gauge: 0.125					
Fasteners: #6 x 5/8" OPH tapping screws					
3" x 12"	US3	65.00	-	5	50
	US4	68.80	013671		
	US10	73.30	-		
	US10B	73.30	056839		
	US26	73.30	043374		
	US26D	73.30	097121		
	US28	39.25	026780		
	US32	68.10	-		
	US32D	53.15	099013		
3-1/2" x 15"	US3	70.15	116990	5	50
	US4	72.75	-		
	US10	78.95	140484		
	US10B	78.95	010106		
	US26	78.95	068575		
	US26D	78.95	032458		
	US28	43.60	078511		
	US32	73.55	-		
	US32D	57.00	068865		
4" x 16"	US3	74.30	086539	5	50
	US4	79.60	002134		
	US10	84.05	077793		
	US10B	84.05	035806		
	US26	84.05	013904		
	US26D	84.05	084672		
	US28	45.10	-		
	US32	78.90	-		
	US32D	58.10	075458		
6" x 16"	US3	95.90	092195	-	5
	US4	98.05	-		
	US10	100.60	-		
	US10B	100.60	087169		
	US26	100.60	-		
	US26D	100.60	018872		
	US28	59.30	-		
	US32	91.25	-		
	US32D	69.60	080425		
8" x 16"	US3	117.35	-	-	5
	US4	119.25	-		
	US10	122.10	-		
	US10B	122.10	046733		
	US26	122.10	-		
	US26D	122.10	-		
	US28	68.60	-		
	US32	109.40	-		
	US32D	82.50	018249		

1. Items with the price in **bold and red** are Quick Ship items and ship in 24 hours.
 Please use stock number when ordering. 2. U/M is each unless otherwise noted.



Trim & Auxiliary



Description	Finish	2018 List	Stock No.	Box Qty.	Case Qty.
100T					
Push Plate - Square Corner - Rounded Bevel - Top and Bottom					
Material: Brass, bronze, aluminum, stainless steel					
Gauge: 0.125					
Fasteners: #6 x 5/8" OPH tapping screws					
3" x 12"	US3	63.50	080351	5	50
	US4	65.60	093144		
	US10	71.40	-		
	US10B	71.40	016836		
	US26	71.40	051749		
	US26D	71.40	025230		
	US28	37.95	-		
	US32	66.30	094651		
	US32D	51.65	094863		
3-1/2" x 15"	US3	68.40	069291	5	50
	US4	71.00	040912		
	US10	77.15	068702		
	US10B	77.15	069149		
	US26	77.15	-		
	US26D	77.15	007779		
	US28	42.30	121532		
	US32	71.80	071048		
	US32D	55.70	078531		
4" x 16"	US3	72.65	079375	5	50
	US4	82.25	120436		
	US10	82.25	036191		
	US10B	82.25	069394		
	US26	82.25	131710		
	US26D	82.25	068881		
	US28	50.10	-		
	US32	75.60	080612		
	US32D	59.15	071810		
6" x 16"	US3	82.25	-	-	5
	US4	88.55	-		
	US10	92.10	-		
	US10B	92.10	032106		
	US26	92.10	028999		
	US26D	92.10	146901		
	US28	57.40	138277		
	US32	75.55	-		
	US32D	67.90	001305		
8" x 16"	US3	109.60	-	-	5
	US4	119.50	-		
	US10	124.10	-		
	US10B	124.10	016853		
	US26	124.10	-		
	US26D	124.10	146776		
	US28	98.55	-		
	US32	96.80	134422		
	US32D	92.15	012977		





Description	Finish	2018 List	Stock No.	Box Qty.	Case Qty.
110S					
Half Circle Push Plate					
8" x 16"	US3	58.05	018809	1	10
Material: Brass, bronze, aluminum, stainless steel	US4	58.05	023148		
Gauge: 0.050	US10B	64.90	017836		
Fasteners: #6 x 5/8" OPH tapping screws	US26	64.90	018083		
	US26D	64.90	004595		
	US28	37.05	043858		
	US32	55.80	032334		
	US32D	45.35	001030		



120L					
Pull Plate - w/ Lip (Not beveled)	US3	85.00	052718	2	20
3-1/2"x16"	US4	85.00	054479		
Material: Brass, bronze, aluminum, stainless steel	US10	76.50	052719		
Lip Projection: 1-1/8"	US10B	76.50	052720		
Gauge: 0.125	US26	76.50	052837		
Fasteners: #6 x 5/8" OPH tapping screws	US26D	76.50	052721		
	US28	38.05	052517		
	US32	95.40	016965		
	US32D	41.55	052518		



121L					
Cylinder Pull	US3	49.50	082020	1	10
2" x 3-3/4"	US4	38.05	080813		
Material: Brass, bronze, aluminum, stainless steel	US10	52.50	074977		
Beveled Lip Projection: 1-1/8"	US10B	52.50	073385		
Gauge: 0.125	US26	38.80	020459		
Cylinder Cutout: 1-1/4" diameter	US26D	52.50	069510		
Cylinder sold separately. Stud installed on reverse to prevent twisting.	US28	34.00	063605		
	US32	45.35	095790		
	US32D	43.00	068962		









122L					
Security Push/Pull Set	US32D	217.60	088047	1	10
Push Plate: 4" x 16"					
Pull Plate: 4" x 9-1/4"					
Fasteners: BTB by Type 6					
Lip Projection: 2-1/8"					
Gauge: 0.125					
Mounting with security torx screws and blank head sex nuts.					





1. Items with the price in **bold and red** are Quick Ship items and ship in 24 hours.
Please use stock number when ordering. 2. U/M is each unless otherwise noted.



Trim & Auxiliary

	Description	Finish	2018 List	Case Qty.	CTC Over 36"*
	125S				
	Bent Push Bar	US3	186.90	4	4.00
	Material: Brass, bronze, aluminum, stainless steel	US4	186.90		4.00
	Bar Size: 3/8" x 1-1/4"	US10	193.35		4.00
	Base Plate: 1" x 3"	US10B	193.35		4.00
	Projection: 2-1/8"	US28	115.90		2.75
	*Add per linear inch or fraction thereof	US32	209.30		6.70
	Standard fasteners are 1/4"-20 FPHMS and #8 x 3/4" FPH Tapping Screws.	US32D	168.40		5.65
	126S				
	Push Bar	US3	193.35	4	4.00
	Material: Brass, bronze, aluminum, stainless steel	US4	242.00		4.00
	Bar Size: 3/8" x 1-1/4"	US10	286.90		4.00
	Base Plate: 1" x 3"	US10B	286.90		4.00
	Projection: 2-1/8"	US28	140.45		2.75
	*Add per linear inch or fraction thereof	US32	246.75		6.70
	Standard fasteners are #8 x 3/4" FPH Tapping Screws. Optional thru bolts available.	US32D	218.15		5.65
	127S				
	Push Bar	US3	141.65	1	8.00
	Material: Brass, bronze, aluminum, stainless steel	US4	157.30		8.00
	Bar Size: 3/8" x 1-1/4"	US10	157.30		8.00
	Base: 1-1/4" Square	US10B	157.30		8.00
	Projection: 3/4"	US28	90.35		5.45
	*Add per linear inch or fraction thereof	US32	165.50		12.90
	Standard fasteners are 1/4"-20 FPHMS. Optional wood screws available no charge.	US32D	127.90		13.40
	128P				
	Wide Push Bar	US3	337.30	1	8.00
	Material: Brass, bronze, aluminum, stainless steel	US4	360.85		8.00
	Bar Size: 3/8" x 3"	US10	371.75		8.00
	Base Plate: 1-1/2" x 4-1/2"	US10B	371.75		8.00
	Projection: 2-1/8"	US28	313.45		5.45
	*Add per linear inch or fraction thereof	US32	392.85		12.90
	Standard fasteners are #8 x 3/4" FPH Tapping Screws. Optional thru bolts available.	US32D	330.75		13.40
	128S				
	Wide Push Bar	US3	317.55	1	8.00
	Material: Brass, bronze, aluminum, stainless steel	US4	331.95		8.00
	Bar Size: 3/8" x 3"	US10	347.90		8.00
	Base: 3/8" x 3"	US10B	347.90		8.00
	Projection: 2"	US28	173.75		5.45
	Door Thickness: 1-3/4" Standard	US32	368.25		12.90
	*Add per linear inch or fraction thereof	US32D	306.90		13.40
Standard fasteners are 1/4"-20 x 2-1/4" FPHMS with finish washers.					
	129P				
	Wide Push Bar	US3	268.90	1	8.00
	Bar Size: 3/8" x 3"	US4	285.00		8.00
	Base: 1" x 3"	US10	301.40		8.00
	Projection: 3/4"	US10B	301.40		8.00
	*Add per linear inch or fraction thereof	US28	124.85		5.45
	Standard fasteners are 1/4"-20 x 1-1/4" FPHMS. Optional thru bolts available. #14 FPH wood screws available.	US32	332.05		12.90
		US32D	263.00		13.40







Description	Finish	2018 List	Case Qty.	CTC Over 36"*
 130S				
Push Bar	US3	184.10	4	4.00
Material: Brass, bronze, aluminum, stainless steel	US4	198.55		4.00
Bar Stock: 1" Round	US10	236.65		4.00
Projection: 2-1/2"	US10B	236.65		4.00
Door Thickness: 1-3/4"	US28	87.10		2.75
*Add per linear inch or fraction thereof	US32	219.40		6.70
Standard fasteners are 1/4"-20 x 2-1/4" FPHMS with finish washers. May be ordered with Type 5 mounting at an extra charge.	US32D	173.75		5.65
 131S				
Push Bar	US3	189.60	4	4.00
Material: Brass, bronze, aluminum, stainless steel	US4	207.55		4.00
Bar Stock: 1" Round	US10	227.40		4.00
Base Plate: 2" Diameter	US10B	227.40		4.00
Projection: 2-5/8"	US28	94.95		2.75
Door Thickness: 1-3/4" Standard	US32	229.60		6.70
*Add per linear inch or fraction thereof	US32D	187.95		5.65
Standard fasteners are 1/4"-20 x 2-1/4" FPHMS with finish washers. May be ordered with Type 5 mounting at an extra charge.				
 133S				
Push Bar	US3	156.00	4	4.00
Material: Brass, bronze, aluminum, stainless steel	US4	169.75		4.00
Bar Stock: 3/4" Round	US10	184.10		4.00
Projection: 2-1/4"	US10B	184.10		4.00
Door Thickness: 1-3/4" Standard	US28	73.85		2.75
*Add per linear inch or fraction thereof	US32	188.15		6.70
Standard fasteners are 1/4"-20 x 2-1/4" FPHMS with finish washers.	US32D	147.70		5.65
 134S				
Push Bar	US3	162.30	4	4.00
Material: Brass, bronze, aluminum, stainless steel	US4	182.35		4.00
Bar Stock: 3/4" Round	US10	194.85		4.00
Base Plate: 1-1/4" Diameter	US10B	194.85		4.00
Projection: 2-3/8"	US28	84.30		2.75
Door Thickness: 1-3/4" Standard	US32	206.60		6.70
*Add per linear inch or fraction thereof	US32D	157.95		5.65
Standard fasteners are 1/4"-20 x 2-1/4" FPHMS with finish washers. May be ordered with Type 5 mounting at an extra charge.				
 136S				
Push Bar	US3	388.00	4	8.00
Material: Brass, bronze, aluminum, stainless steel	US4	396.85		8.00
Bar Stock: 1-1/4" Round	US10	405.80		8.00
Projection: 3"	US10B	405.80		8.00
Fasteners: 5/16" - 18 x 2-1/4" with finish washers	US28	280.65		5.45
Door Thickness: 1-3/4" Standard	US32	368.25		12.90
*Add per linear inch or fraction thereof	US32D	333.20		13.40
May be ordered with Type 5 mounting at an extra charge.				





1. Items with the price in **bold and red** are Quick Ship items and ship in 24 hours.
Please use stock number when ordering. 2. U/M is each unless otherwise noted.



Trim & Auxiliary

	Description	Finish	2018 List	Case Qty.	CTC Over 36"*
	137S Push Bar	US3	397.20	4	8.00
	Material: Brass, bronze, aluminum, stainless steel	US4	405.80		8.00
	Bar Stock: 1-1/4" Round	US10	415.00		8.00
	Base Plate: 2" Diameter	US10B	415.00		8.00
	Projection: 3-1/8"	US28	289.40		5.45
	Door Thickness: 1-3/4" Standard	US32	419.15		12.90
	Fasteners: 5/16" - 18 x 2-1/4" with finish washers	US32D	341.95		13.40
	Additional bars by quotation				
	*Add per linear inch or fraction thereof				
	May be ordered with Type 5 mounting at an extra charge.				
	138P Push/Pull Set	US3	411.10	2	16.10
	Material: Brass, bronze, aluminum, stainless steel	US4	447.30		16.10
	Bar Stock: 1" Round	US10	475.95		16.10
	Projection: 2-1/2"	US10B	475.95		16.10
	Fasteners: 1/4" - 20 type 3 concealed cone	US28	215.80		10.70
	*Add per linear inch or fraction thereof	US32	480.50		23.65
		US32D	389.25		26.80
	139P Push/Pull Set	US3	354.90	2	16.10
	Material: Brass, bronze, aluminum, stainless steel	US4	382.45		16.10
	Bar Stock: 3/4" Round	US10	411.10		16.10
	Projection: 2-1/4"	US10B	411.10		16.10
	Fasteners: 1/4" - 20 type 3 concealed cone	US28	189.45		10.70
	*Add per linear inch or fraction thereof	US32	417.20		23.65
		US32D	337.30		26.80
	140P Push/Pull Set	US3	820.60	2	16.10
	Material: Brass, bronze, aluminum, stainless steel	US4	836.55		16.10
	Bar Stock: 1-1/4" Round	US10	854.55		16.10
	Projection: 3"	US10B	854.55		16.10
	Fasteners: 5-16" - 18 Type 3 concealed cone	US28	620.50		10.70
	*Add per linear inch or fraction thereof	US32	813.40		23.65
		US32D	708.25		26.80
	150B Push/Pull Set	US3	283.25	2	4.00
	Material: Brass, bronze, aluminum, stainless steel	US4	296.00		4.00
	Bar Stock: 3/4" Round	US10	304.85		4.00
	Projection: 2-1/4"	US10B	304.85		4.00
	CTC: 8"	US28	160.05		2.75
	Fasteners: Type 7 & (2) Type 8	US32	348.95		6.70
	Additional bars by quotation	US32D	278.85		5.65
	*Add per linear inch or fraction thereof				
	For tempered glass only				







	Description	Finish	2018 List	Case Qty.	CTC Over 36"*
	150D				
	Push/Pull Set	US3	238.65	2	4.00
	Material: Brass, bronze, aluminum, stainless steel	US4	250.85		4.00
	Bar Stock: 3/4" Round	US10	259.75		4.00
	Projection: 2-1/4"	US10B	259.75		4.00
	CTC: 8"	US28	124.70		2.75
	Fasteners: Type 7 & (2) Type 1	US32	305.20		6.70
	Additional bars by quotation	US32D	235.05		5.65
	*Add per linear inch or fraction thereof				
	Standard fastening method				
	150V				
	Push/Pull Set	US3	267.50	2	4.00
	Material: Brass, bronze, aluminum, stainless steel	US4	279.75		4.00
	Bar Stock: 3/4" Round	US10	288.60		4.00
	Projection: 2-1/4"	US10B	288.60		4.00
	CTC: 8"	US28	152.75		2.75
	Fasteners: Type 7 & (2) Type 5	US32	333.20		6.70
	Additional bars by quotation	US32D	263.00		5.65
	*Add per linear inch or fraction thereof				
	Fully concealed fastening method				
	151B				
	Push/Pull Set	US3	296.00	2	4.00
	Material: Brass, bronze, aluminum, stainless steel	US4	308.45		4.00
	Bar Stock: 3/4" Round	US10	319.90		4.00
	Projection: 2-1/4"	US10B	319.90		4.00
	CTC: 10"	US28	177.55		2.75
	Fasteners: Type 7 & (2) Type 8	US32	317.40		6.70
	Additional bars by quotation	US32D	289.40		5.65
	*Add per linear inch or fraction thereof				
	For tempered glass only				
	151D				
	Push/Pull Set	US3	250.85	2	4.00
	Material: Brass, bronze, aluminum, stainless steel	US4	263.60		4.00
	Bar Stock: 3/4" Round	US10	274.85		4.00
	Projection: 2-1/4"	US10B	274.85		4.00
	CTC: 10"	US28	135.35		2.75
	Fasteners: Type 7 & (2) Type 1	US32	315.65		6.70
	Additional bars by quotation	US32D	245.60		5.65
	*Add per linear inch or fraction thereof				
	Standard fastening method				
	151V				
	Push/Pull Set	US3	279.75	2	4.00
	Material: Brass, bronze, aluminum, stainless steel	US4	292.20		4.00
	Bar Stock: 3/4" Round	US10	303.70		4.00
	Projection: 2-1/4"	US10B	303.70		4.00
	CTC: 10"	US28	166.15		2.75
	Fasteners: Type 7 & (2) Type 5	US32	343.70		6.70
	Additional bars by quotation	US32D	273.55		5.65
	*Add per linear inch or fraction thereof				
	Fully concealed fastening method				

1. Items with the price in **bold and red** are Quick Ship items and ship in 24 hours.
Please use stock number when ordering. 2. U/M is each unless otherwise noted.



Trim & Auxiliary

	Description	Finish	2018 List	Case Qty.	CTC Over 36"*
	152B				
	Push/Pull Set	US3	309.10	2	4.00
	Material: Brass, bronze, aluminum, stainless steel	US4	330.10		4.00
	Bar Stock: 3/4" Round	US10	333.75		4.00
	Projection: 2-1/4"	US10B	333.75		4.00
	CTC: 12"	US28	187.85		2.75
	Fasteners: Type 7 & (2) Type 8	US32	365.10		6.70
	Additional bars by quotation	US32D	299.95		5.65
	*Add per linear inch or fraction thereof				
	For tempered glass only				
	152D				
	Push/Pull Set	US3	263.85	2	4.00
	Material: Brass, bronze, aluminum, stainless steel	US4	285.00		4.00
	Bar Stock: 3/4" Round	US10	288.60		4.00
	Projection: 2-1/4"	US10B	288.60		4.00
	CTC: 12"	US28	148.75		2.75
	Fasteners: Type 7 & (2) Type 1	US32	321.35		6.70
	Additional bars by quotation	US32D	256.25		5.65
	*Add per linear inch or fraction thereof				
	Standard fastening method				
	152V				
	Push/Pull Set	US3	292.60	2	4.00
	Material: Brass, bronze, aluminum, stainless steel	US4	313.85		4.00
	Bar Stock: 3/4" Round	US10	317.55		4.00
	Projection: 2-1/4"	US10B	317.55		4.00
	CTC: 12"	US28	179.55		2.75
	Fasteners: Type 7 & (2) Type 5	US32	349.50		6.70
	Additional bars by quotation	US32D	284.15		5.65
	*Add per linear inch or fraction thereof				
	Fully concealed fastening method				
	153B				
	Push/Pull Set	US3	317.05	2	4.00
	Material: Brass, bronze, aluminum, stainless steel	US4	355.25		4.00
	Bar Stock: 1" Round	US10	355.25		4.00
	Projection: 2-1/2"	US10B	355.25		4.00
	CTC: 10"	US28	180.60		2.75
	Fasteners: Type 7 & (2) Type 8	US32	369.00		6.70
	Additional bars by quotation	US32D	299.60		5.65
	*Add per linear inch or fraction thereof				
	For tempered glass only				
	153D				
	Push/Pull Set	US3	272.10	2	4.00
	Material: Brass, bronze, aluminum, stainless steel	US4	310.20		4.00
	Bar Stock: 1" Round	US10	323.35		4.00
	Projection: 2-1/2"	US10B	325.90		4.00
	CTC: 10"	US28	136.85		2.75
	Fasteners: Type 7 & (2) Type 1	US32	325.20		6.70
	Additional bars by quotation	US32D	255.75		5.65
	*Add per linear inch or fraction thereof				
	Standard fastening method				





Description	Finish	2018 List	Case Qty.	CTC Over 36"*
153V				
Push/Pull Set	US3	301.40	2	4.00
Material: Brass, bronze, aluminum, stainless steel	US4	339.10		4.00
Bar Stock: 1" Round	US10	339.10		4.00
Projection: 2-1/2"	US10B	339.10		4.00
CTC: 10"	US28	166.85		2.75
Fasteners: Type 7 & (2) Type 5	US32	353.25		6.70
Additional bars by quotation	US32D	283.75		5.65
*Add per linear inch or fraction thereof				
Fully concealed fastening method				



154B				
Push/Pull Set	US3	327.80	2	4.00
Material: Brass, bronze, aluminum, stainless steel	US4	371.85		4.00
Bar Stock: 1" Round	US10	380.15		4.00
Projection: 2-1/2"	US10B	380.15		4.00
CTC: 12"	US28	207.00		2.75
Fasteners: Type 7 & (2) Type 8	US32	381.70		6.70
Additional bars by quotation	US32D	308.80		5.65
*Add per linear inch or fraction thereof				
For tempered glass only				



154D				
Push/Pull Set	US3	281.25	2	4.00
Material: Brass, bronze, aluminum, stainless steel	US4	320.55		4.00
Bar Stock: 1" Round	US10	336.60		4.00
Projection: 2-1/2"	US10B	336.60		4.00
CTC: 12"	US28	152.75		2.75
Fasteners: Type 7 & (2) Type 1	US32	337.90		6.70
Additional bars by quotation	US32D	264.90		5.65
*Add per linear inch or fraction thereof				
Standard fastening method				



154V				
Push/Pull Set	US3	310.10	2	4.00
Material: Brass, bronze, aluminum, stainless steel	US4	349.35		4.00
Bar Stock: 1" Round	US10	364.80		4.00
Projection: 2-1/2"	US10B	364.80		4.00
CTC: 12"	US28	189.00		2.75
Fasteners: Type 7 & (2) Type 5	US32	366.05		6.70
Additional bars by quotation	US32D	292.90		5.65
*Add per linear inch or fraction thereof				
Fully concealed fastening method				







155B				
Push/Pull Set	US3	365.10	2	4.00
Material: Brass, bronze, aluminum, stainless steel	US4	387.85		4.00
Bar Stock: 1" Round	US10	410.60		4.00
Projection: 2-1/2"	US10B	410.60		4.00
CTC: 18"	US28	236.20		2.75
Fasteners: Type 7 & (2) Type 8	US32	414.85		6.70
Additional bars by quotation	US32D	334.95		5.65
*Add per linear inch or fraction thereof				
For tempered glass only				

1. Items with the price in **bold and red** are Quick Ship items and ship in 24 hours.
Please use stock number when ordering. 2. U/M is each unless otherwise noted.



Trim & Auxiliary

	Description	Finish	2018 List	Case Qty.	CTC Over 36"*
	155D				
	Push/Pull Set	US3	320.05	2	4.00
	Material: Brass, bronze, aluminum, stainless steel	US4	361.30		4.00
	Bar Stock: 1" Round	US10	365.65		4.00
	Projection: 2-1/2"	US10B	365.65		4.00
	CTC: 18"	US28	162.40		2.75
	Fasteners: Type 7 & (2) Type 1	US32	371.00		6.70
	Additional bars by quotation	US32D	291.15		5.65
	*Add per linear inch or fraction thereof Standard fastening method				
	155V				
	Push/Pull Set	US3	348.85	2	4.00
	Material: Brass, bronze, aluminum, stainless steel	US4	371.75		4.00
	Bar Stock: 1" Round	US10	394.30		4.00
	Projection: 2-1/2"	US10B	394.30		4.00
	CTC: 18"	US28	199.30		2.75
	Fasteners: Type 7 & (2) Type 5	US32	399.00		6.70
	Additional bars by quotation	US32D	319.30		5.65
	*Add per linear inch or fraction thereof Fully concealed fastening method				
	156B				
	Offset Push/Pull Set	US3	326.50	1	4.00
	Material: Brass, bronze, aluminum, stainless steel	US4	326.50		4.00
	Bar Stock: 3/4" Round	US10	341.35		4.00
	Projection: 2-1/2"	US10B	341.35		4.00
	Offset: 2-1/2"	US28	208.90		2.75
	CTC: 8"	US32	388.10		6.70
	Fasteners: Type 7 & (2) Type 8	US32D	308.90		5.65
	Handing Required Additional bars by quotation *Add per linear inch or fraction thereof For tempered glass only				
	156D				
	Offset Push/Pull Set	US3	270.65	1	4.00
	Material: Brass, bronze, aluminum, stainless steel	US4	281.35		4.00
	Bar Stock: 3/4" Round	US10	296.20		4.00
	Projection: 2-1/2"	US10B	296.20		4.00
	Offset: 2-1/2"	US28	165.05		2.75
	CTC: 8"	US32	344.40		6.70
	Fasteners: Type 7 & (2) Type 1	US32D	265.05		5.65
	Handing Required Additional bars by quotation *Add per linear inch or fraction thereof Standard fastening method				



Description	Finish	2018 List	Case Qty.	CTC Over 36"*
156V				
Offset Push/Pull Set	US3	300.00	1	4.00
Material: Brass, bronze, aluminum, stainless steel	US4	310.20		4.00
Bar Stock: 3/4" Round	US10	325.10		4.00
Projection: 2-1/2"	US10B	325.10		4.00
Offset: 2-1/2"	US28	193.10		2.75
CTC: 8"	US32	372.30		6.70
Fasteners: Type 7 & (2) Type 5	US32D	293.10		5.65
Handing Required				
Additional bars by quotation				
*Add per linear inch or fraction thereof				
Fully concealed fastening method				



157B				
Offset Push/Pull Set	US3	332.70	1	4.00
Material: Brass, bronze, aluminum, stainless steel	US4	341.65		4.00
Bar Stock: 3/4" Round	US10	357.10		4.00
Projection: 2-1/2"	US10B	357.10		4.00
Offset: 2-1/2"	US28	212.95		2.75
CTC: 10"	US32	398.40		6.70
Fasteners: Type 7 & (2) Type 8	US32D	316.10		5.65
Handing Required				
Additional bars by quotation				
*Add per linear inch or fraction thereof				
For tempered glass only				



157D				
Offset Push/Pull Set	US3	278.30	1	4.00
Material: Brass, bronze, aluminum, stainless steel	US4	288.60		4.00
Bar Stock: 3/4" Round	US10	304.05		4.00
Projection: 2-1/2"	US10B	304.05		4.00
Offset: 2-1/2"	US28	169.25		2.75
CTC: 10"	US32	354.70		6.70
Fasteners: Type 7 & (2) Type 1	US32D	272.35		5.65
Handing Required				
Additional bars by quotation				
*Add per linear inch or fraction thereof				
Standard fastening method				







157V				
Offset Push/Pull Set	US3	307.70	1	4.00
Material: Brass, bronze, aluminum, stainless steel	US4	317.55		4.00
Bar Stock: 3/4" Round	US10	333.05		4.00
Projection: 2-1/2"	US10B	333.05		4.00
Offset: 2-1/2"	US28	197.40		2.75
CTC: 10"	US32	382.85		6.70
Fasteners: Type 7 & (2) Type 5	US32D	300.25		5.65
Handing Required				
Additional bars by quotation				
*Add per linear inch or fraction thereof				
Fully concealed fastening method				

1. Items with the price in **bold and red** are Quick Ship items and ship in 24 hours.
Please use stock number when ordering. 2. U/M is each unless otherwise noted.



Trim & Auxiliary

	Description	Finish	2018 List	Case Qty.	CTC Over 36"*
	158B				
	Offset Push/Pull Set	US3	337.00	1	4.00
	Material: Brass, bronze, aluminum, stainless steel	US4	361.75		4.00
	Bar Stock: 3/4" Round	US10	377.25		4.00
	Projection: 2-1/2"	US10B	377.25		4.00
	Offset: 2-1/2"	US28	231.50		2.75
	CTC: 12"	US32	417.40		6.70
	Fasteners: Type 7 & (2) Type 8	US32D	329.75		5.65
	Handing Required				
	Additional bars by quotation				
*Add per linear inch or fraction thereof					
For tempered glass only					
	158D				
	Offset Push/Pull Set	US3	308.65	1	4.00
	Material: Brass, bronze, aluminum, stainless steel	US4	308.45		4.00
	Bar Stock: 3/4" Round	US10	319.70		4.00
	Projection: 2-1/2"	US10B	319.70		4.00
	Offset: 2-1/2"	US28	187.85		2.75
	CTC: 12"	US32	373.45		6.70
	Fasteners: Type 7 & (2) Type 1	US32D	285.90		5.65
	Handing Required				
	Additional bars by quotation				
*Add per linear inch or fraction thereof					
Standard fastening method					
	158V				
	Offset Push/Pull Set	US3	320.90	1	4.00
	Material: Brass, bronze, aluminum, stainless steel	US4	337.30		4.00
	Bar Stock: 3/4" Round	US10	348.60		4.00
	Projection: 2-1/2"	US10B	348.60		4.00
	Offset: 2-1/2"	US28	215.80		2.75
	CTC: 12"	US32	401.55		6.70
	Fasteners: Type 7 & (2) Type 5	US32D	313.95		5.65
	Handing Required				
	Additional bars by quotation				
*Add per linear inch or fraction thereof					
Fully concealed fastening method					
	159B				
	Offset Push/Pull Set	US3	358.95	1	4.00
	Material: Brass, bronze, aluminum, stainless steel	US4	387.85		4.00
	Bar Stock: 1" Round	US10	402.20		4.00
	Projection: 2-1/2"	US10B	402.20		4.00
	Offset: 3"	US28	217.60		2.75
	CTC: 10"	US32	394.45		6.70
	Fasteners: Type 7 & (2) Type 8	US32D	336.25		5.65
	Handing Required				
	Additional bars by quotation				
*Add per linear inch or fraction thereof					
For tempered glass only					





Description	Finish	2018 List	Case Qty.	CTC Over 36"*
159D				
Offset Push/Pull Set	US3	313.85	1	4.00
Material: Brass, bronze, aluminum, stainless steel	US4	342.75		4.00
Bar Stock: 1" Round	US10	381.05		4.00
Projection: 2-1/2"	US10B	381.05		4.00
Offset: 3"	US28	166.95		2.75
CTC: 10"	US32	350.85		6.70
Fasteners: Type 7 & (2) Type 1	US32D	292.40		5.65
Handing Required				
Additional bars by quotation				
*Add per linear inch or fraction thereof				
Standard fastening method				



159V				
Offset Push/Pull Set	US3	342.75	1	4.00
Material: Brass, bronze, aluminum, stainless steel	US4	371.75		4.00
Bar Stock: 1" Round	US10	386.10		4.00
Projection: 2-1/2"	US10B	386.10		4.00
Offset: 3"	US28	200.05		2.75
CTC: 10"	US32	378.80		6.70
Fasteners: Type 7 & (2) Type 5	US32D	320.45		5.65
Handing Required				
Additional bars by quotation				
*Add per linear inch or fraction thereof				
Fully concealed fastening method				



160B				
Offset Push/Pull Set	US3	367.60	1	4.00
Material: Brass, bronze, aluminum, stainless steel	US4	395.05		4.00
Bar Stock: 1" Round	US10	409.50		4.00
Projection: 2-1/2"	US10B	409.50		4.00
Offset: 3"	US28	235.05		2.75
CTC: 12"	US32	412.05		6.70
Fasteners: Type 7 & (2) Type 8	US32D	341.95		5.65
Handing Required				
Additional bars by quotation				
*Add per linear inch or fraction thereof				
For tempered glass only				







160D				
Offset Push/Pull Set	US3	322.60	1	4.00
Material: Brass, bronze, aluminum, stainless steel	US4	350.05		4.00
Bar Stock: 1" Round	US10	384.20		4.00
Projection: 2-1/2"	US10B	387.60		4.00
Offset: 3"	US28	173.75		2.75
CTC: 12"	US32	368.25		6.70
Fasteners: Type 7 & (2) Type 1	US32D	298.25		5.65
Handing Required				
Additional bars by quotation				
*Add per linear inch or fraction thereof				
Standard fastening method				

1. Items with the price in **bold and red** are Quick Ship items and ship in 24 hours.
Please use stock number when ordering. 2. U/M is each unless otherwise noted.



Trim & Auxiliary

	Description	Finish	2018 List	Case Qty.	CTC Over 36"*
	160V				
	Offset Push/Pull Set	US3	351.30	1	4.00
	Material: Brass, bronze, aluminum, stainless steel	US4	378.80		4.00
	Bar Stock: 1" Round	US10	392.60		4.00
	Projection: 2-1/2"	US10B	393.25		4.00
	Offset: 3"	US28	210.65		2.75
	CTC: 12"	US32	396.35		6.70
	Fasteners: Type 7 & (2) Type 5	US32D	326.20		5.65
	Handing Required				
	Additional bars by quotation				
	*Add per linear inch or fraction thereof				
Fully concealed fastening method					
	161B				
	Offset Push/Pull Set	US3	364.25	1	4.00
	Material: Brass, bronze, aluminum, stainless steel	US4	395.20		4.00
	Bar Stock: 1" Round	US10	420.80		4.00
	Projection: 2-1/2"	US10B	420.80		4.00
	Offset: 3"	US28	233.95		2.75
	CTC: 18"	US32	425.85		6.70
	Fasteners: Type 7 & (2) Type 8	US32D	342.40		5.65
	Handing Required				
	Additional bars by quotation				
	*Add per linear inch or fraction thereof				
For tempered glass only					
	161D				
	Offset Push/Pull Set	US3	340.85	1	4.00
	Material: Brass, bronze, aluminum, stainless steel	US4	369.80		4.00
	Bar Stock: 1" Round	US10	396.85		4.00
	Projection: 2-1/2"	US10B	396.85		4.00
	Offset: 3"	US28	189.85		2.75
	CTC: 18"	US32	403.40		6.70
	Fasteners: Type 7 & (2) Type 1	US32D	323.15		5.65
	Handing Required				
	Additional bars by quotation				
	*Add per linear inch or fraction thereof				
Standard fastening method					
	161V				
	Offset Push/Pull Set	US3	366.20	1	4.00
	Material: Brass, bronze, aluminum, stainless steel	US4	398.65		4.00
	Bar Stock: 1" Round	US10	425.75		4.00
	Projection: 2-1/2"	US10B	425.75		4.00
	Offset: 3"	US28	305.20		2.75
	CTC: 18"	US32	431.35		6.70
	Fasteners: Type 7 & (2) Type 5	US32D	343.70		5.65
	Handing Required				
	Additional bars by quotation				
	*Add per linear inch or fraction thereof				
Fully concealed fastening method					



Description	Finish	2018 List	Case Qty.	CTC Over 36"*
164B				
Push/Pull Set	US3	647.55	1	8.00
Material: Brass, bronze, aluminum, stainless steel	US4	673.85		8.00
Bar Stock: 1-1/4" Round	US10	686.55		8.00
Projection: 3"	US10B	686.55		8.00
CTC: 12"	US28	510.15		5.45
Fasteners: Type 7 & (2) Type 8	US32	682.55		12.90
Additional bars by quotation	US32D	563.20		13.40
*Add per linear inch or fraction thereof For tempered glass only				



164D				
Push/Pull Set	US3	589.05	1	8.00
Material: Brass, bronze, aluminum, stainless steel	US4	627.95		8.00
Bar Stock: 1-1/4" Round	US10	627.95		8.00
Projection: 3"	US10B	627.95		8.00
CTC: 12"	US28	453.20		5.45
Fasteners: Type 7 & (2) Type 1	US32	563.20		12.90
Additional bars by quotation	US32D	506.25		13.40
*Add per linear inch or fraction thereof Standard fastening method				



164V				
Push/Pull Set	US3	666.90	1	8.00
Material: Brass, bronze, aluminum, stainless steel	US4	666.90		8.00
Bar Stock: 1-1/4" Round	US10	680.65		8.00
Projection: 3"	US10B	680.65		8.00
CTC: 12"	US28	491.10		5.45
Fasteners: Type 7 & (2) Type 5	US32	614.35		12.90
Additional bars by quotation	US32D	549.95		13.40
*Add per linear inch or fraction thereof Fully concealed fastening method				



165B				
Push/Pull Set	US3	686.55	1	8.00
Material: Brass, bronze, aluminum, stainless steel	US4	725.40		8.00
Bar Stock: 1-1/4" Round	US10	725.40		8.00
Projection: 3"	US10B	725.40		8.00
CTC: 18"	US28	530.95		5.45
Fasteners: Type 7 & (2) Type 8	US32	648.45		12.90
Additional bars by quotation	US32D	597.30		13.40
*Add per linear inch or fraction thereof For tempered glass only				



165D				
Push/Pull Set	US3	627.95	1	8.00
Material: Brass, bronze, aluminum, stainless steel	US4	666.90		8.00
Bar Stock: 1-1/4" Round	US10	666.90		8.00
Projection: 3"	US10B	666.90		8.00
CTC: 18"	US28	474.10		5.45
Fasteners: Type 7 & (2) Type 1	US32	591.60		12.90
Additional bars by quotation	US32D	534.65		13.40
*Add per linear inch or fraction thereof Standard fastening method				

1. Items with the price in **bold and red** are Quick Ship items and ship in 24 hours.
Please use stock number when ordering. 2. U/M is each unless otherwise noted.



Trim & Auxiliary



Description	Finish	2018 List	Case Qty.	CTC Over 36"*
165V				
Push/Pull Set	US3	697.90	1	8.00
Material: Brass, bronze, aluminum, stainless steel	US4	705.95		8.00
Bar Stock: 1-1/4" Round	US10	705.95		8.00
Projection: 3"	US10B	705.95		8.00
CTC: 18"	US28	511.95		5.45
Fasteners: Type 7 & (2) Type 5	US32	642.70		12.90
Additional bars by quotation	US32D	587.80		13.40
*Add per linear inch or fraction thereof				
Fully concealed fastening method				



167B				
Offset Push/Pull Set	US3	760.50	1	8.00
Material: Brass, bronze, aluminum, stainless steel	US4	778.00		8.00
Bar Stock: 1-1/4" Round	US10	799.55		8.00
Projection: 3"	US10B	799.55		8.00
Offset: 3-3/4"	US28	568.95		5.45
CTC: 18"	US32	718.65		12.90
Fasteners: Type 7 & (2) Type 8	US32D	635.05		13.40
Handing Required				
Additional bars by quotation				
*Add per linear inch or fraction thereof				
For tempered glass only				



167D				
Offset Push/Pull Set	US3	726.20	1	8.00
Material: Brass, bronze, aluminum, stainless steel	US4	726.20		8.00
Bar Stock: 1-1/4" Round	US10	764.50		8.00
Projection: 3"	US10B	764.50		8.00
Offset: 3-3/4"	US28	511.95		5.45
CTC: 18"	US32	661.70		12.90
Fasteners: Type 7 & (2) Type 1	US32D	572.65		13.40
Handing Required				
Additional bars by quotation				
*Add per linear inch or fraction thereof				
Standard fastening method				



167V				
Offset Push/Pull Set	US3	729.45	1	8.00
Material: Brass, bronze, aluminum, stainless steel	US4	743.40		8.00
Bar Stock: 1-1/4" Round	US10	743.40		8.00
Projection: 3"	US10B	743.40		8.00
Offset: 3-3/4"	US28	534.55		5.45
CTC: 18"	US32	681.10		12.90
Fasteners: Type 7 & (2) Type 5	US32D	610.40		13.40
Handing Required				
Additional bars by quotation				
*Add per linear inch or fraction thereof				
Fully concealed fastening method				



170D				
Push/Pull Set	US3	997.40	1	32.10
Material: Brass, bronze, aluminum, stainless steel	US4	997.40		32.10
Bar Stock: 3/8" x 1-1/4"	US10	997.40		32.10
Base: 1-1/4" Square	US10B	997.40		32.10
Projection: Push Bar 3/4"	US28	530.95		21.50
Projection: Pull Bar 2-1/2"	US32	969.75		51.50
Fasteners: 1/4" 20 thru bolts Type 4	US32D	884.40		53.60
*Add per linear inch or fraction thereof				



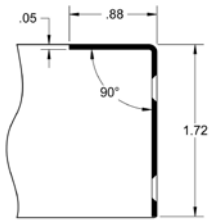

Description	Finish	2018 List	Case Qty.
180H			
Door Edgings - Mortise Type	US28	40.10	10
Material: Aluminum, stainless steel	US32D	56.80	
Length: Up to 42"			
Thickness: .045 - .050"			
Fasteners: #6 x 5/8" FPHSMS (Self drilling) #6 x 1" screws available on request.			
Standard edge guards made for 1-3/4" +0/-1/32" door thickness. Please provide actual door thickness.			
Cutouts will hand product, specify handling. Other lengths by quotation.			
Hinge Cutout (Add to list price)	US28	27.40	
	US32D	27.40	
Bolt Cutout (Add to list price)	US28	27.45	
	US32D	27.45	
Latch Cutout (Add to list price)	US28	27.40	
	US32D	27.40	
UL Rated (Add to list price)	US32D	16.55	

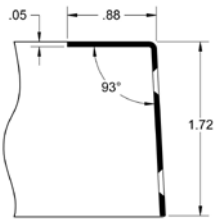

180K			
Door Edgings - Mortise Type	US28	41.20	10
Material: Aluminum, stainless steel	US32D	64.25	
Length: Up to 42"			
Thickness: .045 - .050"			
Fasteners: #6 x 5/8" FPHSMS (Self drilling) #6 x 1" screws available on request.			
Standard edge guards made for 1-3/4" +0/-1/32" door thickness. Please provide actual door thickness.			
Cutouts will hand product, specify handling. Other lengths by quotation.			
Hinge Cutout (Add to list price)	US28	27.40	
	US32D	27.40	
Bolt Cutout (Add to list price)	US28	27.45	
	US32D	27.45	
Latch Cutout (Add to list price)	US28	27.40	
	US32D	27.40	
UL Rated (Add to list price)	US32D	16.55	

1. Items with the price in **bold and red** are Quick Ship items and ship in 24 hours. Please use stock number when ordering. 2. U/M is each unless otherwise noted.



Trim & Auxiliary

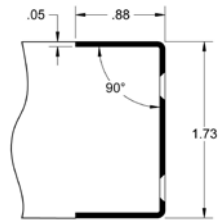

Description	Finish	2018 List	Case Qty.
-------------	--------	-----------	-----------

180M

Door Edgings - Mortise Type
 Material: Aluminum, stainless steel
 Length: Up to 42"
 Thickness: .045 - .050"
 Fasteners: #6 x 5/8" FPHSMS (Self drilling) #6 x 1" screws available on request.
 Standard edge guards made for 1-3/4" +0/-1/32" door thickness. Please provide actual door thickness.
 Cutouts will hand product, specify handling. Other lengths by quotation.

US28	64.25	10
US32D	84.60	

Hinge Cutout (Add to list price)	US28	27.40	
	US32D	27.40	
Bolt Cutout (Add to list price)	US28	27.45	
	US32D	27.45	
Latch Cutout (Add to list price)	US28	27.40	
	US32D	27.40	
UL Rated (Add to list price)	US32D	16.55	

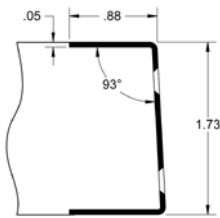

180P

Door Edgings - Mortise Type
 Material: Aluminum, stainless steel
 Length: Up to 42"
 Thickness: .045 - .050"
 Fasteners: #6 x 5/8" FPHSMS (Self drilling) #6 x 1" screws available on request.
 Standard edge guards made for 1-3/4" +0/-1/32" door thickness. Please provide actual door thickness.
 Cutouts will hand product, specify handling. Other lengths by quotation.

US28	68.60	10
US32D	89.45	

Hinge Cutout (Add to list price)	US28	27.40	
	US32D	27.40	
Bolt Cutout (Add to list price)	US28	27.45	
	US32D	27.45	
Latch Cutout (Add to list price)	US28	27.40	
	US32D	27.40	
UL Rated (Add to list price)	US32D	16.55	



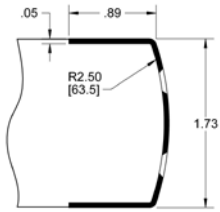

Description	Finish	2018 List	Case Qty.
180Q			
Door Edgings - Mortise Type	US28	86.95	5
Material: Aluminum, stainless steel	US32D	110.05	
Length: Up to 42"			
Thickness: .045 - .050"			
Fasteners: #6 x 5/8" FPHSMS (Self drilling) #6 x 1" screws available on request.			
Standard edge guards made for 1-3/4" +0/-1/32" door thickness. Please provide actual door thickness.			
Cutouts will hand product, specify handling. Other lengths by quotation.			
Hinge Cutout (Add to list price)	US28	27.40	
	US32D	27.40	
Bolt Cutout (Add to list price)	US28	27.45	
	US32D	27.45	
Latch Cutout (Add to list price)	US28	27.40	
	US32D	27.40	
UL Rated (Add to list price)	US32D	16.55	

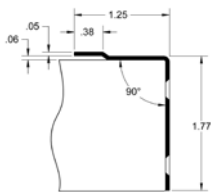

181H			
Door Edgings - Overlap Type	US28	64.25	5
Material: Aluminum, stainless steel	US32D	89.70	
Length: Up to 42"			
Thickness: .045 - .050"			
Fasteners: #6 x 5/8" FPHSMS (Self drilling) #6 x 1" screws available on request.			
Standard edge guards made for 1-3/4" +0/-1/32" door thickness. Please provide actual door thickness.			
Cutouts will hand product, specify handling. Other lengths by quotation.			
Hinge Cutout (Add to list price)	US28	27.40	
	US32D	27.40	
Bolt Cutout (Add to list price)	US28	27.45	
	US32D	27.45	
Latch Cutout (Add to list price)	US28	27.40	
	US32D	27.40	
UL Rated (Add to list price)	US32D	16.55	

1. Items with the price in **bold and red** are Quick Ship items and ship in 24 hours. Please use stock number when ordering. 2. U/M is each unless otherwise noted.



Trim & Auxiliary

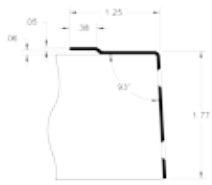

Description	Finish	2018 List	Case Qty.
181K			
Door Edgings - Overlap Type	US28	60.05	5
Material: Aluminum, stainless steel	US32D	84.00	
Length: Up to 42"			
Thickness: .045 - .050"			
Fasteners: #6 x 5/8" FPHSMS (Self drilling) #6 x 1" screws available on request.			
Standard edge guards made for 1-3/4" +0/-1/32" door thickness. Please provide actual door thickness.			
Cutouts will hand product, specify handling. Other lengths by quotation.			
Hinge Cutout (Add to list price)	US28	27.40	
	US32D	27.40	
Bolt Cutout (Add to list price)	US28	27.45	
	US32D	27.45	
Latch Cutout (Add to list price)	US28	27.40	
	US32D	27.40	
UL Rated (Add to list price)	US32D	16.55	

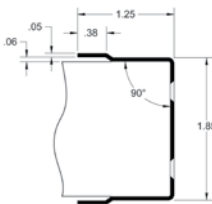

181M			
Door Edgings - Overlap Type	US28	81.20	5
Material: Aluminum, stainless steel	US32D	102.85	
Length: Up to 42"			
Thickness: .045 - .050"			
Fasteners: #6 x 5/8" FPHSMS (Self drilling) #6 x 1" screws available on request.			
Standard edge guards made for 1-3/4" +0/-1/32" door thickness. Please provide actual door thickness.			
Cutouts will hand product, specify handling. Other lengths by quotation.			
Hinge Cutout (Add to list price)	US28	27.40	
	US32D	27.40	
Bolt Cutout (Add to list price)	US28	27.45	
	US32D	27.45	
Latch Cutout (Add to list price)	US28	27.40	
	US32D	27.40	
UL Rated (Add to list price)	US32D	16.55	



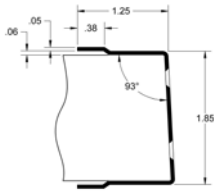

Description	Finish	2018 List	Case Qty.
181P			
Door Edgings - Overlap Type	US28	85.30	10
U/M - each	US32D	106.60	
Material: Aluminum, stainless steel			
Length: Up to 42"			
Thickness: .045 - .050"			
Fasteners: #6 x 5/8" FPHSMS (Self drilling) #6 x 1" screws available on request.			
Standard edge guards made for 1-3/4" +0/-1/32" door thickness. Please provide actual door thickness.			
Cutouts will hand product, specify handling. Other lengths by quotation.			
Hinge Cutout (Add to list price)	US28	27.40	
	US32D	27.40	
Bolt Cutout (Add to list price)	US28	27.45	
	US32D	27.45	
Latch Cutout (Add to list price)	US28	27.40	
	US32D	27.40	
UL Rated (Add to list price)	US32D	16.55	

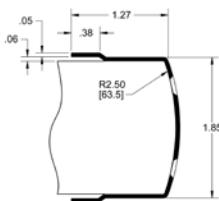

181Q			
Door Edgings - Overlap Type	US28	90.95	5
U/M - each	US32D	102.70	
Material: Aluminum, stainless steel			
Length: Up to 42"			
Thickness: .045 - .050"			
Fasteners: #6 x 5/8" FPHSMS (Self drilling) #6 x 1" screws available on request.			
Standard edge guards made for 1-3/4" +0/-1/32" door thickness. Please provide actual door thickness.			
Cutouts will hand product, specify handling. Other lengths by quotation.			
Hinge Cutout (Add to list price)	US28	27.40	
	US32D	27.40	
Bolt Cutout (Add to list price)	US28	27.45	
	US32D	27.45	
Latch Cutout (Add to list price)	US28	27.40	
	US32D	27.40	
UL Rated (Add to list price)	US32D	16.55	

1. Items with the price in **bold and red** are Quick Ship items and ship in 24 hours. Please use stock number when ordering. 2. U/M is each unless otherwise noted.



Trim & Auxiliary

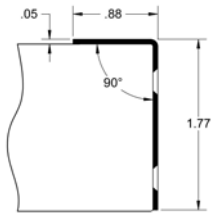

Description	Finish	2018 List	Case Qty.
182H			
Door Edgings - Surface	US28	38.60	10
Non-Mortise Type	US32D	60.05	
Material: Aluminum, stainless steel			
Length: Up to 42"			
Thickness: .045 - .050"			
Fasteners: #6 x 5/8" FPHSMS (Self drilling) #6 x 1" screws available on request.			
Standard edge guards made for 1-3/4" +0/-1/32" door thickness. Please provide actual door thickness.			
Cutouts will hand product, specify handling. Other lengths by quotation.			
Hinge Cutout (Add to list price)	US28	27.40	
	US32D	27.40	
Bolt Cutout (Add to list price)	US28	27.45	
	US32D	27.45	
Latch Cutout (Add to list price)	US28	27.40	
	US32D	27.40	
UL Rated (Add to list price)	US32D	16.55	

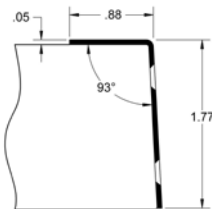

182K			
Door Edgings - Surface	US28	41.20	10
Non-Mortise Type	US32D	49.05	
Material: Aluminum, stainless steel			
Length: Up to 42"			
Thickness: .045 - .050"			
Fasteners: #6 x 5/8" FPHSMS (Self drilling) #6 x 1" screws available on request.			
Standard edge guards made for 1-3/4" +0/-1/32" door thickness. Please provide actual door thickness.			
Cutouts will hand product, specify handling. Other lengths by quotation.			
Hinge Cutout (Add to list price)	US28	27.40	
	US32D	27.40	
Bolt Cutout (Add to list price)	US28	27.45	
	US32D	27.45	
Latch Cutout (Add to list price)	US28	27.40	
	US32D	27.40	
UL Rated (Add to list price)	US32D	16.55	



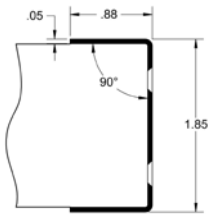

Description	Finish	2018 List	Case Qty.
182M			
Door Edgings - Surface	US28	64.65	10
Non-Mortise Type	US32D	84.60	
Material: Aluminum, stainless steel			
Length: Up to 42"			
Thickness: .045 - .050"			
Fasteners: #6 x 5/8" FPHSMS (Self drilling) #6 x 1" screws available on request.			
Standard edge guards made for 1-3/4" +0/-1/32" door thickness. Please provide actual door thickness.			
Cutouts will hand product, specify handling. Other lengths by quotation.			
Hinge Cutout (Add to list price)	US28	27.40	
	US32D	27.40	
Bolt Cutout (Add to list price)	US28	27.45	
	US32D	27.45	
Latch Cutout (Add to list price)	US28	27.40	
	US32D	27.40	
UL Rated (Add to list price)	US32D	16.55	

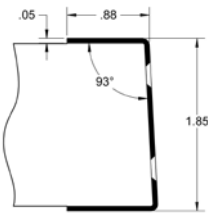

182P			
Door Edgings - Surface	US28	68.60	10
Non-Mortise Type	US32D	89.45	
Material: Aluminum, stainless steel			
Length: Up to 42"			
Thickness: .045 - .050"			
Fasteners: #6 x 5/8" FPHSMS (Self drilling) #6 x 1" screws available on request.			
Standard edge guards made for 1-3/4" +0/-1/32" door thickness. Please provide actual door thickness.			
Cutouts will hand product, specify handling. Other lengths by quotation.			
Hinge Cutout (Add to list price)	US28	27.40	
	US32D	27.40	
Bolt Cutout (Add to list price)	US28	27.45	
	US32D	27.45	
Latch Cutout (Add to list price)	US28	27.40	
	US32D	27.40	
UL Rated (Add to list price)	US32D	16.55	

1. Items with the price in **bold and red** are Quick Ship items and ship in 24 hours.
Please use stock number when ordering. 2. U/M is each unless otherwise noted.



Trim & Auxiliary

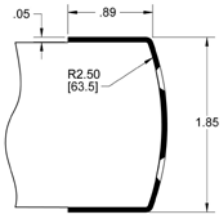

Description	Finish	2018 List	Case Qty.
182Q			
Door Edgings - Surface	US28	87.25	10
Non-Mortise Type	US32D	110.05	
Material: Aluminum, stainless steel			
Length: Up to 42"			
Thickness: .045 - .050"			
Fasteners: #6 x 5/8" FPHSMS (Self drilling) #6 x 1" screws available on request.			
Standard edge guards made for 1-3/4" +0/-1/32" door thickness. Please provide actual door thickness.			
Cutouts will hand product, specify handling. Other lengths by quotation.			
Hinge Cutout (Add to list price)	US28	27.40	
	US32D	27.40	
Bolt Cutout (Add to list price)	US28	27.45	
	US32D	27.45	
Latch Cutout (Add to list price)	US28	27.40	
	US32D	27.40	
UL Rated (Add to list price)	US32D	16.55	





Description	Finish	2018 List	Stock No.	Box Qty.	Case Qty.
185G					
Corner Guard	US28	89.30	-	-	-
Material: Aluminum, stainless steel	w/tape				
Size: 3" x 3" x 40"	US32D w/tape	109.15	062999		
Thickness: .050"	US28	59.15	044109		
Fasteners: #6 x 5/8" FPHSMS self drilling	US32D	79.80	087970		
#6 x 1" screws available upon request.					
Other lengths by quotation.					
230W					
Convex Wall Stop	US3	9.00	053679	10	100
Concealed Mounting	US4	11.55	053680		
Material: Cast brass or bronze	US10	11.60	053681		
Stop: Rubber	US10B	11.60	053683		
Diameter: 2-15/32"	US15	16.15	094602		
Projection: 1-3/32"	US15A	16.15	054038		
Fastener: #10 x 1-1/2" PPHWS with plastic and toggle anchor	US19	16.15	073621		
Add optional 230T machine screw with metal toggle nut screwpack - 0.70 each list.	US26	14.45	053682		
	US26D	7.55	053684		
232W					
Convex Wall Stop	US3	3.90	051972	10	100
Concealed Mounting	US4	3.90	053231		
Material: Wrought brass, bronze or stainless steel	US5	9.95	072846		
Stop: Rubber	US9	9.85	017030		
Diameter: 2-7/16"	US10	3.90	051973		
Projection: 1"	US10B	3.90	051974		
Fastener: #10 x 1-1/2" PPHWS with plastic and toggle anchor	US15	10.00	046072		
Add optional 230T machine screw with metal toggle nut screwpack - 0.70 each list.	US15A	10.00	062556		
	US19	10.00	071703		
	US26	4.05	051975		
	US26D	3.80	051976		
	US32	10.00	053691		
	US32D	2.75	053678		
234W					
Concave Wall Stop	US3	9.00	053227	10	100
Material: Cast brass or bronze	US4	11.55	053228		
Stop: Rubber	US10	11.60	053229		
Diameter: 2-15/32"	US10B	11.60	053230		
Projection: 1-3/32"	US15	16.15	094603		
Fastener: #10 x 1-1/2" PPHWS with plastic and toggle anchor	US15A	16.15	054039		
Add optional 230T machine screw with metal toggle nut screwpack - 0.70 each list.	US19	16.15	067951		
	US26	14.45	053235		
	US26D	7.55	053236		

1. Items with the price in **bold and red** are Quick Ship items and ship in 24 hours. Please use stock number when ordering. 2. U/M is each unless otherwise noted.



Trim & Auxiliary



Description	Finish	2018 List	Stock No.	Box Qty.	Case Qty.
236W					
Concave Wall Stop	US3	3.90	051977	10	100
Material: Wrought brass, bronze or stainless steel	US4	3.90	053237		
Stop: Rubber	US5	9.95	072849		
Diameter: 2-7/16"	US9	9.85	018702		
Projection: 1"	US10	3.90	051978		
Fastener: #10 x 1-1/2" PPHWS with plastic and toggle anchor	US10B	3.90	051979		
Add optional 230T machine screw with metal toggle nut screwpack - 0.70 each list.	US15	9.95	014846		
	US15A	9.95	054522		
	US19	9.95	018437		
	US26	4.05	051980		
	US26D	3.80	051981		
	US32	9.85	053238		
	US32D	2.75	053239		



241F					
Dome Stop - Low	US3	6.75	051982	10	100
Material: Die cast brass	US4	6.65	053259		
Base Diameter: 1-11/16"	US5	10.85	072845		
Base: 1/8" Thick	US9	10.85	056749		
Height: 1"	US10	7.60	051983		
Fastener: #14 x 1-1/2" with plastic anchor and 1/4-20 x 3/4" FPHMS with lead anchor	US10B	6.70	051984		
	US15	8.30	034785		
	US15A	10.85	054041		
	US19	10.85	073625		
	US26	6.65	051985		
	US26D	6.25	052148		



242F					
Dome Stop - Universal	US3	10.45	075489	10	100
Material: Forged brass	US4	10.45	099613		
Base Diameter: 1-11/16"	US10B	11.00	075488		
Base: 7/32" Thick	US15	12.20	094363		
Height: 1-5/8"	US26	10.75	081314		
Fastener: #14 x 1-1/2" FPHWS with plastic anchor and 1/4 - 20 x 3/4" FPHMS with lead anchor	US26D	9.20	075487		



243F					
Dome Stop - High	US3	7.60	051986	10	100
Material: Die cast brass	US4	7.60	053268		
Base Diameter: 1-11/16"	US5	12.40	077629		
Base: 7/16" Thick	US9	12.40	056750		
Height: 1-9/32"	US10	8.60	052149		
Fastener: #14 x 1-1/2" FPHWS with plastic anchor and 1/4 - 20 x 1-1/4" FPHMS with lead anchor	US10B	7.75	052328		
	US15	9.15	035110		
	US15A	12.40	054043		
	US19	12.40	068921		
	US26	7.75	052329		
	US26D	6.45	052150		





Description	Finish	2018 List	Stock No.	Box Qty.	Case Qty.
244F					
Cast Floor Stop	US3	22.20	097343	5	50
Material: Cast brass	US4	22.20	058458		
Base: 1-3/4" x 4"	US10	21.75	097344		
Base Thickness: 5/32"	US10B	21.75	097345		
O/A Height: 1"	US26	22.45	097346		
Fasteners: #14 x 1-1/2" FPHWS with plastic anchor;	US26D	13.90	097347		
1/4 - 20 x 3/4" FPHMS with lead anchor					



245F					
Cast Floor Stop	US3	31.70	097348	5	50
Material: Cast brass	US4	31.70	036320		
Base: 1-3/4" x 2"	US10	29.90	097349		
Base Thickness: 1/2"	US10B	31.05	097350		
O/A Height: 1-5/16"	US26	31.05	097351		
Fasteners: #14 x 1-1/2" FPHWS with plastic anchor;	US26D	20.75	097352		
1/4 - 20 x 1-1/4" FPHMS with lead anchor					



246B					
Dome Stop Riser Plate	Mil	6.05	052934	10	100
Material: Brass	US3	3.45	054344		
Diameter: 1-3/4"	US4	3.45	066234		
Base: 3/8" thick	US10	3.70	059349		
For use with 241F	US10B	3.70	054443		
	US15	8.00	061758		
	US15A	8.00	054044		
	US19	8.00	054523		
	US26	3.45	066412		
	US26D	2.95	055308		



248G					
Modern Style Universal Stop	US26	25.65	148878	10	100
Material: Brass w/ gray rubber bumper	US26D	25.65	159656		
Diameter: 1-7/16"					
Height: 1-1/2"					
Fasteners: 1/4 - 20 x 1" FPHMS with lead anchor;					
#12 x 1-1/4" FPHWS with plastic anchor					



248F					
Modern Style Universal Stop	US26	19.90	193603	10	100
Material: Brass w/ black rubber bumper	US26D	19.90	023442	10	100
Diameter: 1-7/16"					
Height: 1-1/2"					
Fasteners: 1/4 - 20 x 1" FPHMS with lead anchor;					
#12 x 1-1/4" FPHWS with plastic anchor					









249F					
L-Shaped Floor Stop	US2C	8.55	011616	5	50
Material: Steel with rubber bumper					
Height: 2-5/8"					
Base: 1" x 2-1/2" x 7/32" thick					
Fastener: #14 x 1-1/2" FPHWS with plastic anchor					

1. Items with the price in **bold and red** are Quick Ship items and ship in 24 hours.
Please use stock number when ordering. 2. U/M is each unless otherwise noted.



Trim & Auxiliary

	Description	Finish	2018 List	Stock No.	Box Qty.	Case Qty.
	250W					
	Convex Wall Stop	US3	9.15	052784	20	200
	Material: Cast brass with rubber bumper	US4	9.15	056083		
	Diameter: 1"	US10	9.75	052785		
	Projection: 9/16"	US10B	9.75	052786		
	Fastener: #6 x 3/4" screw w/ anchor and .052" diameter nail	US15	12.50	061694		
		US15A	12.50	054045		
		US19	12.50	054526		
		US26	9.75	052787		
	US26D	9.75	053275			
	251W					
	Concave Wall Bumper	Grey	2.30	052935	20	200
	Material: Adhesive backed rubber					
	Diameter: 1-7/8"					
	Projection: 25/32"					
	252F					
	Floor Stop	US3	24.30	058522	5	50
	Material: Cast brass with rubber bumper	US10	26.25	058523		
	Diameter: 1-9/16" x 2-1/2"	US10B	24.20	058517		
	Height: 2-11/16"	US15	42.30	061610		
	Fastener: 1 ea. 1/4 - 20 x 3/4" FPHMS with lead anchor;	US15A	42.30	054046		
	5/16 - 18 x 2-1/2" stud with lead anchor;	US19	42.30	054531		
	#14 x 1-1/2 FPHWS with plastic anchor	US26	30.35	058518		
	2" max door to floor clearance	US26D	21.75	058519		
	254S					
	Wall Stop and Holder	US3	47.65	097810	5	50
	Material: Cast brass with rubber bumper	US4	47.65	030895		
	Base Diameter: 2-11/32"	US10	55.70	097811		
	Base Projection: 3-1/2"	US10B	55.70	097813		
	Engaged Projection: 5-19/32"	US15	55.70	061598		
	Keeper: 1" x 2"	US26	55.70	097812		
	Fastener: #10 x 1" FPHWS with plastic anchor	US26D	55.70	097814		
	254W					
	Wall Stop and Holder	US3	47.65	097805	5	50
	Material: Cast brass with rubber bumper	US4	47.65	071803		
	Base Diameter: 2-11/32"	US10	55.70	097806		
	Base Projection: 3-1/2"	US10B	55.70	097807		
	Engaged Projection: 5-19/32"	US15	55.70	061570		
	Keeper: 1" x 2"	US26	55.70	097808		
	Fastener: #10 x 1" FPHWS with plastic anchor;	US26D	55.70	097809		
	5/16 - 18 x 2-1/2" stud with lead anchor					
	255S					
	Wall Stop	US3	29.00	017532	5	50
	Material: Cast brass with rubber bumper	US4	29.00	017533		
	Base Diameter: 2-11/32"	US10	29.35	094583		
	Projection: 3-11/16"	US10B	29.35	017534		
	Fastener: #10 x 1" OPHWS with plastic anchor	US15	36.35	061568		
		US26	32.45	017531		
		US26D	21.20	000917		





Description	Finish	2018 List	Stock No.	Box Qty.	Case Qty.
255W					
Wall Stop	US3	29.00	058532	5	50
Material: Cast brass with rubber bumper	US4	29.00	075493		
Base Diameter: 2-11/32"	US10	29.35	058533		
Projection: 3-11/16"	US10B	29.35	058534		
Fastener: #10 x 1" OPHWS with plastic anchor;	US15	36.35	061567		
5/16" - 18 x 2-1/2" threaded stud, 5/16" lead anchor	US26	32.45	058675		
	US26D	21.20	058535		



256S					
Wall Stop & Holder	US3	52.20	068146	5	50
Material: Cast brass with rubber bumper	US10	41.60	070578		
Base Diameter: 2-1/4"	US10B	43.60	099449		
Engaged Projection: 5-11/16"	US15	51.20	060858		
Projection: 3-25/32"	US26	52.20	088625		
Keeper: 25/32" x 1-1/2"	US26D	28.50	067225		
Fastener: #10 x 1" OPHWS with plastic anchor					



256W					
Wall Stop & Holder	US3	52.20	058585	5	50
Material: Cast brass with rubber bumper	US10	41.60	058586		
Base Diameter: 2-1/4"	US10B	43.60	058587		
Engaged Projection: 5-11/16"	US15	51.20	060860		
Projection: 3-25/32"	US26	52.20	058520		
Keeper: 25/32" x 1-1/2"	US26D	28.50	058521		
Fastener: #10 x 1" OPHWS with plastic anchor;					
5/16" - 18 x 2-1/2" stud with lead anchor					



257F					
Floor Stop	US3	22.10	058546	5	50
Material: Cast brass with rubber bumper	US10	25.65	058547		
Base: 1-9/16" x 2-15/32"	US10B	22.70	058548		
Height: 2"	US15	42.30	060857		
Fastener: #14 x 1-1/2" FPHWS with plastic anchor;	US15A	42.30	054048		
1/4 - 20 x 3/4" FPHMS with lead anchor;	US19	42.30	054532		
5/16" - 18 x 2-1/2" stud with lead anchor	US26	28.75	058549		
	US26D	20.10	058550		



258F					
Floor Stop & Holder	US3	40.10	058551	5	50
Material: Cast brass with rubber bumper	US10	36.50	058552		
Base: 1-9/16" x 2-15/32"	US10B	36.50	058553		
Height: 3"	US15	63.30	060855		
Keeper: 1" x 2"	US26	41.35	058554		
Fasteners: #10 x 1" FPHWS with plastic anchor;	US26D	29.20	058555		
1/4 - 20 x 3/4" FPHMS with lead anchor;					
5/16 - 18 x 2-1/2" stud with lead anchor					



259F					
Tri Base Floor Stop	US3	25.95	086836	5	50
Material: Cast brass with rubber bumper	US4	25.95	090238		
Base: 2-1/2" wide x 1-9/16" deep	US10	25.50	086566		
Height: 1-11/16"	US10B	25.50	086567		
Fasteners: #10 x 1-1/4" FPHWS with plastic anchor;	US26	31.95	086568		
10 - 32 x 3/4" FPHMS with lead anchor	US26D	21.45	084984		

1. Items with the price in **bold and red** are Quick Ship items and ship in 24 hours.
Please use stock number when ordering. 2. U/M is each unless otherwise noted.



Trim & Auxiliary



Description	Finish	2018 List	Stock No.	Box Qty.	Case Qty.
259H					
Tri Base Floor Stop - Tall	US3	30.35	013387	5	50
Material: Cast brass with rubber bumper	US4	30.35	012068		
Base: 2-1/2" wide x 1-9/16" deep	US10	29.00	033155		
Height: 2-1/4"	US10B	29.00	006004		
Fasteners: #10 x 1-1/4" FPHWS with plastic anchor;	US26	36.20	031052		
10 - 32 x 3/4" FPHMS with lead anchor	US26D	24.10	005661		



260W					
Angled Wall Stop	US26D	70.30	059730	5	50
Material: Cast brass with rubber bumper					
Base: 2-3/16" wide x 2-15/16" tall					
Projection: 3-21/32"					
Fasteners: #14 x 1-1/2" FPHWS with plastic anchor and					
1/4 - 20 x 3/4" FPHMS with lead anchor					



267F					
Floor Stop	US3	28.00	058536	5	50
Material: Cast brass with rubber bumper	US10	29.00	058537		
Base: 2-1/4"	US10B	29.00	058538		
Height: 3-1/8"	US15	36.35	060853		
Fasteners: #10 x 1" OPHWS with plastic anchor;	US15A	36.35	031421		
5/16" - 18 x 2-1/2" stud with lead anchor	US19	36.35	033541		
	US26	32.45	058539		
	US26D	21.75	058540		



267S					
Cast Floor Stop	US3	23.10	097803	5	50
Material: Cast brass with rubber bumper	US10	28.00	097804		
Base: 2-1/4"	US10B	29.20	097800		
Height: 3-1/8"	US15	36.35	060851		
Fasteners: #10 x 1" OPHWS with plastic anchor	US26	32.45	097801		
	US26D	21.75	097802		



268F					
Floor Stop & Holder	US3	52.95	058541	5	50
Material: Cast brass with rubber bumper	US10	47.65	058542		
Base: 2-1/4"	US10B	49.80	058543		
Height: 3-19/32"	US15	47.65	075320		
Keeper: 25/32" x 1-1/2"	US15A	47.65	054050		
Fasteners: #10 x 1" OPHWS with plastic anchor;	US19	47.65	054533		
5/16" - 18 x 2-1/2" stud with lead anchor	US26	52.95	058544		
	US26D	29.70	058545		



268S					
Cast Floor Stop & Holder	US3	52.95	070926	5	50
Material: Cast brass with rubber bumper	US10	47.65	088879		
Base: 2-1/4"	US10B	49.80	072110		
Height: 3-19/32"	US15	47.65	060840		
Keeper: 25/32" x 1-1/2"	US26	52.95	095114		
Fasteners: #10 x 1" OPHW with plastic anchors	US26D	29.70	068934		





Description	Finish	2018 List	Stock No.	Box Qty.	Case Qty.
269F Heavy Duty Floor Stop Material: 5/8" Steel pin with rubber bumper Bumper: 1-1/2" high Diameter: 2" Steel Bolt: 5/8" - 11 x 2-1/2" thread Special Grout by others	-	22.55	085062	5	50



269T Heavy Duty Floor Stop - Tall Material: 5/8" Steel pin with rubber bumper Bumper: 3-1/2" high Diameter: 2" Steel Bolt: 5/8" - 11 x 2-1/2" thread Special Grout by others	-	28.95	083131	3	30
---	---	--------------	--------	---	----



270C Kick Down Door Holder Material: Cast iron with rubber tip Base: 1-7/16" x 2-1/8" Arm: 3-13/16" Fasteners: #6 x 3/4" OPHTS S1 - Sprayed Alum., S2 - Sprayed Brass, S3 - Sprayed Bronze 270CR replacement rubber tips available, 6 per bag	S1	13.55	058588	5	50
	S2	13.55	058589		
	S3	13.55	058590		



270D Kick Down Door Holder Material: Cast brass with rubber tip Base: 1-19/32" x 1-25/32" Arm: 3-1/2" Fasteners: #6 x 3/4" OPHWS	US3	27.15	058525	5	50
	US10	30.25	058526		
	US10B	26.70	058527		
	US15	42.30	060822		
	US15A	42.30	054051		
	US19	42.30	054542		
	US26	39.50	058568		
	US26D	24.35	058569		



270R Replacement Rubber Tips Material: Black rubber For use with 270D or 271D door holders Sold in packs of 10	Rubber	27.70	073663	10	100
---	--------	-------	--------	----	-----



271D Kick Down Door Holder Material: Cast brass with rubber bumper Base: 1-19/32" x 1-25/32" Arm: 4-7/16" Fasteners: #6 x 3/4" OPHWS	US3	47.65	058570	5	50
	US10	47.65	058571		
	US10B	47.65	058564		
	US26	47.65	058565		
	US26D	47.65	058566		



271W Roller Bumper Material: Cast brass or bronze with rubber roller Base: 2" Projection: 4-1/2" Fasteners: #10 x 1" FPHWS with plastic anchor	US3	28.95	123928	10	50
	US10	31.00	123929		
	US10B	31.60	123930		
	US26	30.30	123931		
	US26D	23.50	123927		

1. Items with the price in **bold and red** are Quick Ship items and ship in 24 hours.
Please use stock number when ordering. 2. U/M is each unless otherwise noted.



Trim & Auxiliary



Description	Finish	2018 List	Stock No.	Box Qty.	Case Qty.
272W					
Material: Cast brass or bronze with rubber roller	US3	32.10	052779	10	100
Base: 2"	US10	33.05	052780		
Projection: 6-1/4"	US10B	33.00	052781		
Fasteners: #10 x 1" FPHWS with plastic anchor	US26	39.20	052782		
	US26D	29.40	052783		



273W					
Curved Roller Bumper	US3	28.40	043325	5	50
Material: Cast brass or bronze with rubber roller	US4	31.00	043326		
Projection: 2-21/32"	US10	28.40	043323		
Fasteners: #10 x 1" FPHWS with plastic anchor	US10B	31.00	043327		
	US26	34.00	043324		
	US26D	25.95	043328		



274B					
Door Guard Protective Plate	US3	5.75	048087	-	10
Material: Brass	US4	5.75	046942		
Fasteners: Double sided pressure sensitive tape	US10	5.75	048363		
To be used with the 274D	US10B	5.75	048365		
	US15	5.75	060811		
	US26	5.75	048364		
	US26D	5.75	048366		



274C					
Shim for Door Guard	Black	2.05	158025	-	50
Material: Resilient black rubber, 3/32" thick					
To be used with the 274D					



274D					
Material: Cast brass	US3	27.15	158021	5	50
Arm Length: 4-1/2"	US4	25.65	158022		
Fasteners; #6 x 3/4" OPHWS; #6 x 1-1/2" OPHWS;	US10	28.20	158016		
6 - 32 x 1/2" OPHMS	US10B	27.40	158017		
	US15	28.20	158018		
	US26	26.05	158019		
	US26D	23.10	158020		



275D					
Surface Bolt - 8"	US3	28.20	058752	1	12
Material: Steel	US10	25.95	074243		
Bolt Size: 1/4" x 3/4"	US10B	28.95	056786		
Bolt Throw: 1"	US26D	23.10	052287		
Fasteners: #10 x 1-1/4" FPHWS; 10 - 24 x 1" FPHMS					
Universal and angle strikes included					



276D					
Surface Bolt - 12"	US3	21.00	083603	1	12
Material: Steel	US10	28.00	025645		
Bolt Size: 1/4" x 3/4"	US10B	73.60	073888		
Bolt Throw: 1"	US26D	26.85	053325		
Fasteners: #10 x 1-1/4" FPHWS; 10 - 24 x 1" FPHMS					
Universal and angle strikes included					





Description	Finish	2018 List	Stock No.	Box Qty.	Case Qty.
277D Privacy Door Latch	US3	37.30	161173	1	10
Material: Cast Zinc	US4	37.30	161174		
Base: 2-5/8" x 1-9/16"	US10B	53.30	161149		
Projection: 2-3/16"	US15	50.65			
Fasteners: #12 x 1-3/4" FPHSMS	US26	36.35	161171		
	US26D	34.30	161172		



278D Surface Bolt - 6"	US3	20.15	086661	10	100
Material: Brass	US10B	21.90	020392		
Bolt Size: 7/16"	US26D	20.85	086662		
Bolt Throw: 31/32"					
Projection: 3/4"					
Fasteners: #5 x 5/8" FPHWS					
Mortise and universal strikes included					



279D Dutch Door Bolt	US3	45.80	097353	10	100
Material: Brass	US10	38.20	097183		
O/A Size: 1-11/16" x 4"	US10B	45.80	023685		
Bolt Size: 5/8" half round	US26D	45.80	097354		
Bolt Throw: 3/8"					
Projection: 1-1/4"					
Knob Diameter: 29/32"					
Fasteners: #6 x 3/4" FPHWS					
Universal and angle strikes included					



280X Dust Proof Strike w/ Removable Plate	US3	19.65	052522	10	100
Material: Brass	US4	18.55	053326		
Face Plate: 1-7/16" x 2-29/32"	US9	26.05	021465		
Barrel Diameter: 1"	US10	20.80	052559		
Depth: 2-3/16"	US10B	20.20	052523		
Plunger Diameter: 3/4"	US15	24.50	040347		
Fasteners: #8 x 1" FPHWS with plastic anchors;	US15A	26.05	054052		
spanner wrench	US19	26.05	067955		
	US26	20.10	052839		
	US26D	17.30	052524		



281D Slide Flush Bolt	US3	13.45	056621	10	100
Material: Brass or bronze w/ steel components	US4	14.05	056789		
Face Plate: 3/4" x 6"	US5	19.10	035600		
Bolt Diameter: 1/2"	US10	14.05	052723		
Bolt Throw: 1"	US10B	14.05	056790		
Strike: 7/8" x 1-3/4"	US15	19.10	036438		
Rod Backset: 7/16"	US15A	19.10	054055		
Fasteners: #6 x 3/4" FPHWS	US19	19.10	054545		
	US26	16.25	052525		
	US26D	13.45	056791		

1. Items with the price in **bold and red** are Quick Ship items and ship in 24 hours.
Please use stock number when ordering. 2. U/M is each unless otherwise noted.



Trim & Auxiliary



Description	Finish	2018 List	Stock No.	Box Qty.	Case Qty.
282D					
Manual Flush Bolt	US3	20.35	052281	2	80
Metal Doors	US4	20.35	052282		
Material: Brass w/ steel components	US5	33.55	062354		
Face Plate: 1" x 6-3/4"	US9	33.55	083207		
Bolt Throw: 3/4"	US10	20.75	052283		
Bolt Backset: 3/4"	US10B	20.75	052284		
Rod Length: 12"	US15	25.95	040346		
Strike: 15/16" x 2-1/4"	US15A	37.05	054056		
Fasteners: #8 x 3/4" combination screws	US19	37.05	067956		
#8 x 1-1/2" combination screws	US26	22.45	052285		
For use with A115 Frame Preparation	US26D	18.95	052286		
282S Strike plate bag and 282P bolt head available					
282R Optional rod length available: 18", 25" and 30" (bolt head not included) - No Charge					
3-hour fire rating on metal doors up to 4 feet wide x 10 feet tall Sold in increments of 2					
283D					
Manual Flush Bolt	US3	30.95	052929	2	40
Wood Composite Door	US4	30.95	053328		
Material: Brass w/ steel components	US5	62.20	018995		
Face Plate: 1" x 6-25/32"	US9	62.20	032026		
Bolt Head: 1/2" Square	US10	30.95	052930		
Bolt Throw: 3/4"	US10B	30.00	052931		
Bolt Backset: 3/4"	US15	62.20	060810		
Strike: 15/16" x 2-1/4"	US15A	62.20	054057		
Fasteners: #8 x 3/4" combination screws;	US19	62.20	054567		
1-1/2 hour fire rating on wood doors up to 4 feet wide x 10 feet tall	US26	32.35	052932		
	US26D	30.00	052933		
291D					
Automatic Flush Bolts	US3	185.90	053297	1	10
Wood Door	US4	186.10	074059		
Material: Stainless steel/brass w/ steel components	US10	186.10	053298		
Face Plate: 1" x 8-1/2"	US10B	180.40	053299		
Bolt Heads: 1/2" square	US15	254.60	046049		
Bolt Throw: 3/4"	US32	254.60	117105		
Bolt Backset: 3/4"	US32D	175.05	117104		
Fasteners: #10 x 1" SMS; #8 x 1" combination screws					
Mortise Strike: 15/16" x 2-1/4"					
280X Dust Proof Strike recommended					
1-1/2 hour fire rating on wood doors up to 4 feet wide x 9 feet tall					

1. Items with the price in **bold and red** are Quick Ship items and ship in 24 hours.
Please use stock number when ordering. 2. U/M is each unless otherwise noted.



Description	Finish	2018 List	Stock No.	Box Qty.	Case Qty.
292D					
Automatic Flush Bolts	US3	172.50	053301	1	10
Metal Doors	US4	172.50	084898		
Material: Stainless steel/brass w/ steel components	US10	172.50	053302		
Face Plate: 1" x 6-3/4"	US10B	167.40	053303		
Bolt Head: 1/2" square	US15	237.40	046052		
Bolt Throw: 3/4"	US32	237.40	117106		
Bolt Backset: 3/4"	US32D	162.40	117107		
Fasteners: #8 x 1" combination screws					
Mortise Strike: 15/16" x 2-1/4"					
280X Dust Proof Strike recommended					
1-1/2 hour fire rating on wood doors up to 4 feet wide x 9 feet tall					



293D					
Constant Latching Flush Bolts	US3	172.50	058567	1	10
Metal Doors	US4	172.50	087519		
Material: Stainless steel/brass w/ steel components	US10	172.50	058560		
Face Plate: 1" x 6-3/4"	US10B	167.40	058561		
Bolt Head: 1/2" square	US15	237.40	093481		
Bolt Throw: 3/4"	US32	237.40	117108		
Bolt Backset: 3/4"	US32D	162.40	117109		
Fasteners: #8 x 1" combination screws					
T-Strike: 1-1/8" x 2-3/4"					
280X Dust Proof Strike recommended					
1-1/2 hour fire rating on wood doors up to 4 feet wide x 9 feet tall					



294D					
Constant Latching Flush Bolts	US3	185.90	058563	1	10
Wood Door	US4	185.90	082014		
Material: Stainless steel/brass w/ steel components	US10	185.90	058556		
Face Plate: 1" x 8-1/2"	US10B	180.40	058557		
Bolt Head: 1/2" square	US15	254.60	095081		
Bolt Throw: 3/4"	US32	254.60	117111		
Bolt Backset: 3/4"	US32D	175.05	117110		
Fasteners: #10 x 1" SMS; #8 x 1" combination screws					
T-Strike: 1-1/8" x 2-3/4"					
280X Dust Proof Strike recommended					
1-1/2 hour fire rating on wood doors up to 4 feet wide x 9 feet tall					

1. Items with the price in **bold and red** are Quick Ship items and ship in 24 hours. Please use stock number when ordering. 2. U/M is each unless otherwise noted.



Trim & Auxiliary



Description	Finish	2018 List	Stock No.	Box Qty.	Case Qty.
295M					
Automatic Flush Bolt w/Fire Bolt	US3	137.15	080579	1	10
Metal Doors	US4	137.15	080582		
Material: Stainless steel/brass with steel components	US10	137.15	080583		
Face Plate: 1" x 6-3/4"	US10B	137.15	080584		
Bolt Head: 1/2" square	US15	189.90	060808		
Bolt Throw: 3/4"	US32	137.15	080585		
Bolt Backset: 3/4"	US32D	137.15	080586		
Fasteners: #8 x 1" combination screws					
T-strike: 15/16" x 2-1/4"					
3-hour fire rating for metal doors up to 4 feet wide x 9 feet tall					
295W					
Automatic Flush Bolt w/Fire Bolt	US3	147.70	080593	1	10
Wood Doors	US4	147.70	080594		
Material: Stainless steel/brass with steel components	US10	147.70	080592		
Face Plate: 1" x 8-1/2"	US10B	147.70	080591		
Bolt Head: Flattened 1/2" square	US15	163.55	060807		
Bolt Throw: 3/4"	US32	147.70	080590		
Backset: 3/4"	US32D	147.70	080589		
Fasteners: #10 x 1" SMS; #8 x 1" combination screws					
Mortise Strike: 15/16" x 2-1/4"					
20 minute fire rating for wood doors up to 4 feet wide x 9 feet tall					
296W					
Automatic Flush Bolt Set for Wood Doors	US3	330.30	083221	1	10
Backset: 1-1/2"	US4	330.30	083222		
Fasteners: Sixteen (16) #8 x 1" APS; four (4) plastic anchors	US10	330.30	083223		
Strike: 1-1/8" x 2-1/4"	US10B	330.30	083224		
1-1/2 hour fire rating for wood doors up to 4 feet wide x 9 feet tall	US15	330.30	060784		
	US32	330.30	083225		
	US32D	330.30	083226		
297C					
Carry Bar	USP	33.55	058524	2	20
Material: Stainless steel/brass	US3	59.70	058528		
Base: 1-3/4" x 2-1/4"	US10	59.70	058529		
Projection: 25/32"	US10B	59.70	058530		
Fasteners: 12 - 24 x 3/4" PPHMS with sex nuts	US15	59.70	060778		
For use on pairs of doors with astragal and 297D-298D coordinator.	US32	59.70	117361		
	US32D	59.70	117226		





Description	Finish	2018 List	Stock No.	Box Qty.	Case Qty.
297D Coordinator with Filler Bar Material: Steel Base: 1-5/8" x 5/8" Fasteners: 12-24 x 1-1/4" TPHMS; #8 x 1" combo screws If overall frame width is different than widths shown, consult Hager Customer Service. If active and inactive doors are unequal in length, consult Hager Customer Service for proper sizing. 60"	Black	118.95	069727	1	4
Coordinator with Filler Bar Material: Steel Fasteners: 12-24 x 1-1/4" TPHMS; #8 x 1" combo screws If overall frame width is different than widths shown, consult Hager Customer Service. If active and inactive doors are unequal in length, consult Hager Customer Service for proper sizing. 72"	Black	125.30	052312	1	4
96"	Black	139.45	052313	1	4
297F 297F Filler Bars Material: Steel Thickness: 5/8" standard 18-5/8"	Black FB1	24.80	098884	-	-
42-5/8"	Black FB1	34.50	073866	-	-
297M Mounting Bracket Material: Aluminum Stop Height: 5/8" Soffit Width: 1-3/8" to 2-3/8" Fasteners: 12-24 x 2" FPHMS; 1/4 - 20 x 1/2" FPHMS	Black	20.50	053257	-	-
297N Mounting Bracket Material: Aluminum Soffit Width: 3" or greater Fasteners: 12-24 x 2" FPHMS; 1/4 - 20 x 1/2" FPHMS	Black	20.50	053258	2	20
298D Gravity Coordinator Material: Cast brass w/rubber roller Base: 1-1/8" x 5-1/2" Projection: 7" Fasteners: #12 x 1" OPHWS; #6 x 3/4" FPHWS; #8 x 3/4" FPHWS; #8 x 3/4" TPHWS	US3	79.65	055123	1	10
	US10	79.45	060271		
	US10B	77.10	055124		
	US26D	65.70	055125		

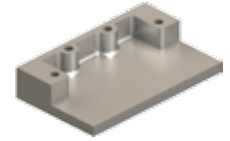
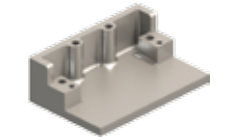

1. Items with the price in **bold and red** are Quick Ship items and ship in 24 hours. Please use stock number when ordering. 2. U/M is each unless otherwise noted.



Trim & Auxiliary



Description	Finish	2018 List	Stock No.	Box Qty.	Case Qty.
300D Chain Door Check Material: Steel chain Base Plate: Cast zinc base, galvanized steel chain, EPDM rubber cover 1-1/2" x 1-1/2" Cover: EDPM Rubber Fasteners: #8 x 1" FPHSMS Optional grommet nut set available (part #1-320-9801)					
25-1/2"	US26D	58.10	063667	1	10
30-1/2"	US26D	58.10	063668	1	10



301D Residential Hinge Pin Stop Material: Wrought steel with rubber bumpers Features: Works with both 1/4" and 5/16" hinge pins Must purchase an NRP hinge for use with this pin stop	US3	4.60	023366	5	50
	US26D	4.60	023363		



303W Handrail Bracket	US3	77.35	053306	5	50
Material: Cast brass	US4	77.35	067806		
Base Diameter: 3-5/32"	US10	82.65	052151		
Base to Center of Rail: 2-3/4"	US10B	82.65	053307		
Fasteners: #10 x 1-1/4" FPHWS with plastic anchor;	US26	82.65	052327		
10 - 24 x 13/16" FPHMS with lead anchors	US26D	82.65	052152		



305D Wire Pull Material: 5/16" brass rod Projection: 1-9/32" Fasteners: 8 - 32 x 1" TPHMS CTC: 3"	US3	10.25	086821	10	100
	US4	10.60	-		
	US10	10.60	020779		
	US10B	10.60	095891		
	US26	10.60	086823		
	US26D	10.60	086822		
CTC: 3-1/2"	US3	10.25	086824	10	100
	US4	10.60	007767		
	US10	10.60	089114		
	US10B	10.60	018946		
	US26	10.60	086826		
	US26D	10.60	086825		
CTC: 4"	US3	10.25	086827	10	100
	US4	10.60	019788		
	US10	10.60	090240		
	US10B	10.60	018468		
	US26	10.60	086829		
	US26D	10.60	086828		



307D Metal Door Silencer Material: Rubber Diameter: 1/2" Projection: 1/8" U/M Bag of 100	Grey	11.05	052527	-	100
--	------	--------------	--------	---	-----





Description	Finish	2018 List	Stock No.	Box Qty.	Case Qty.
308D Wood Door Silencer Base: 3/8" x 3/4" Projection: 9/64" U/M Bag of 100	Grey	16.60	052526	-	100
310C Conversion Kit Strike: 1-11/16" x 2-1/4" Filler Plate: 1-1/8" x 3-3/8" Fasteners: #10 x 1-1/2" FPHWS; #10 x 1" FPHWS; 8 - 32 x 1/4" FPHMS; 10 - 24 x 1/2" FPHMS Converts Roller Latch to Push Pull Latch	US26D	53.40	711114	5	50
311H Push/Pull Latch Material: Zinc, stainless steel; Door Thickness: 1-3/4"; Bolt Throw: 1/2" Standard Backset: 2-3/4" Standard; 5" Optional; Projection: 2-5/8"; Strike: ASA 1-1/4" x 4-7/8" Standard T-Strike 1-1/8" x 2-3/4" Standard; Horizontal Mounting w/ 5" Backset Options: Engraving Handed: A - "PUSH" down; "PULL" up B - "PUSH" up; "PULL" down C - "PUSH" up; "PULL" up D - "PUSH" down; "PULL" down					
2-3/4"	US26	240.60	161063	1	10
	US26D	195.45	161064		
	US32	296.40	161067		
	US32D	232.35	161068		
5"	US26	240.60	161069	1	10
	US26D	195.45	161070		
	US32	296.40	161071		
	US32D	232.35	161072		
Lead Lined 2-3/4"	US26	286.35		1	10
	US26D	232.55	161066		
	US32	335.95			
	US32D	319.95	161073		
Lead Lined 5"	US26	286.35		1	10
	US26D	232.55	161076		
	US32	335.95			
	US32D	319.95	161080		
313S Anti-Vandal Trim Material: 11 GA stainless steel Max Projection: 1-7/8" Size: 6-11/32" x 11" Door Thickness: 1-3/4" - 2" Fasteners: 1/4 - 20" FPHMS with finish washers Available with latchguard (313L). Cylinder cutout available. Can be used with exit devices and mortise locks.	US32D	305.90	-	-	-
	US32D with Plastisol	346.75	-		

1. Items with the price in **bold and red** are Quick Ship items and ship in 24 hours.
Please use stock number when ordering. 2. U/M is each unless otherwise noted.



Trim & Auxiliary



Description	Finish	2018 List	Stock No.	Box Qty.	Case Qty.
318D					
Roller Latch	US3	32.35	055119	1	50
Material: Brass	US4	45.70	055120		
Latch Faceplate: 1" x 3-3/8"	US10	45.70	055121		
Strike: 1-1/4" x 2-3/4"	US10B	33.15	055122		
Strike Thickness: .171"	US15	61.65	078198		
Max Roller Projection: 3/8"	US15A	61.65	054058		
Fasteners: #8 x 1" FPHWS; 8 - 32 x 3/4" FPHMS;	US19	61.65	054569		
#10 x 1-1/2" FPHWS	US26	33.90	055127		
	US26D	27.40	055126		



318S					
Roller Latch with Stop	US3	67.55	087304	1	50
Material: Brass	US4	67.65	087305		
Latch Face: 1-7/16" x 4-7/16"	US10	67.65	075533		
Angle Stop: 9/16" x 4-7/16"	US10B	65.70	055304		
Strike: 1-1/4" x 2-1/4"	US26	73.45	087306		
Strike Thickness: .171"	US26D	48.50	055305		
Max Roller Projection: 3/8"					
Fasteners: 8 - 32 x 3/4" FPHMS; #10 x 1-1/2" FPHWS					



320R					
Roller Latch	US3	41.95	049988	1	50
Material: Brass with nylon roller	US4	41.95	049989		
Latch Face: 2-1/4" x 1-1/8"	US9	84.30	049990		
Strike: 1-1/8" x 2-3/4"	US10	41.95	049987		
Strike Thickness: .058 wrought	US10B	44.75	049994		
Max Roller Projection: 7/16"	US15	46.10	060809		
Fasteners: #8 x 1" FPHWS	US26	41.95	049993		
	US26D	27.65	049995		



321R					
Adjustable Ball Catch	US3	17.85	055947	1	50
Material: Brass with steel ball roller	US4	17.85	055953		
Latch Face: 1" x 2-1/8"	US10	21.25	055944		
Strike: 1-1/2" x 2-1/8"	US10B	21.25	055960		
Strike Thickness: .050"	US15	21.25	075224		
Fasteners: #6 FPHWS	US15A	21.25	055961		
	US19	21.25	055945		
	US26D	17.85	055963		



322V					
Door Knocker w/ 115° Viewer	US3	29.45	056479	1	50
Material: Wrought brass	US4	29.45	064778		
Knocker Size: 2-7/32" x 3-1/4"	US10	33.00	056593		
Projection: 19/32"	US26D	29.45	056478		
Fasteners: #6 x 3/4" TPHSMS					

Lettering available - up to four characters, Arial, 1/2" tall, black - \$6.00 total added to net price



323S					
Three-Way Ball Catch	US26D	18.30	158659	30	300
Material: Brass with Stainless Steel Balls					
Body: 1/2" x 2-3/16" x 1/2"					
Strike: 3/8" x 1-3/8" x 5/8"					





Description	Finish	2018 List	Stock No.	Box Qty.	Case Qty.
324W					
Light Duty Wall Bumper	US3	9.00	013810	1	50
Material: Brass or bronze	US4	9.60	013811		
Base: 1-1/4" diameter	US5	10.75	013814		
Projection: 3-1/4"	US10	10.75	013809		
Tip Diameter: 5/8"	US10B	10.75	013812		
Fasteners: #10 x 7/8" wood thread	US15	10.75	040348		
Replacement rubber tip available (Part # 1-269-3073)	US15A	10.75	013813		
	US19	10.75	030873		
	US26	9.30	013808		
	US26D	9.30	013807		



326F					
Automatic Floor Stop and Holder	US3	72.85	058510	5	30
Material: Cast brass	US10	76.85	058511		
Holder Base: 3-1/16" x 3-1/2"	US10B	76.85	058512		
Projection: 1-15/16"	US26	76.85	058507		
Floor Strike: 2" x 4-3/32"	US26D	76.85	058508		
Strike Height: 1-1/4"					
Max Door to Floor Clearance: 1/2" or less					
Fasteners: 4 ea. 12-24 x 1" TPHMS and #12 x 1" TPHWS;					
3 ea. #14 x 1-1/2" FPHWS and anchors;					
1/4 - 20 x 3/4" FPHMS with lead anchor					



326W					
Automatic Wall Stop and Holder	US3	80.90	058513	5	30
Material: Cast brass	US10	84.95	058514		
Holder Base: 2-13/32" x 2-25/32"	US10B	84.95	058515		
Holder Projection: 2-5/16"	US26	84.95	058516		
Engaged Projection: 3-5/8"	US26D	84.95	058509		
Strike Base: 1" x 2-1/16"					
Strike Projection: 2"					
Fasteners: #10 x 1" OPHWS and anchors;					
10 - 24 x 1-1/4" FPHMS					



327F					
Automatic Floor Stop and Holder	US3	72.85	034684	5	30
Material: Cast brass	US10	76.85	085315		
Holder Base: 3-1/16" x 3-1/2"	US10B	76.85	076374		
Projection: 1-15/16"	US26	76.85	037584		
Floor Strike: 2" x 4-3/32"	US26D	76.85	029249		
Strike Height: 1-3/4"					
Max Door to Floor Clearance: 9/16" to 1-1/16"					
Fasteners: 4 ea. x 12-24 x 1" TPHMS and #12 x 1" TPHWS;					
3 ea. #14 x 1-1/2" FPHWS and anchors;					
1/4 - 20 x 3/4" FPHMS with lead anchor					

1. Items with the price in **bold and red** are Quick Ship items and ship in 24 hours.
Please use stock number when ordering. 2. U/M is each unless otherwise noted.



Trim & Auxiliary



Description	Finish	2018 List	Stock No.	Box Qty.	Case Qty.
327W					
Automatic Wall Stop and Holder	US3	122.25	098618	5	20
Material: Cast brass	US4	122.25	098619		
Holder Base: 3-1/16" x 3-1/2"	US10	122.25	098617		
Holder Projection: 1-15/16"	US10B	122.25	098615		
Engaged Projection: 3-1/2"	US26	122.25	098614		
Strike Diameter: 2-3/8"	US26D	115.25	098612		
Strike Projection: 3-1/16"					
Fasteners: #12 x 1 TPHWS; 12-24 x 1" TPHMS; 1/4" - 20 x 3/4" FPHMS with lead anchor; #14 x 1-1/2" FPHWS					
Strike is adjustable 45° left or right					



328F					
Automatic Floor Stop and Holder	US3	72.85	043083	5	30
Material: Cast brass	US10	76.85	036197		
Holder Base: 3-1/16" x 3-1/2"	US10B	76.85	045516		
Projection: 1-15/16"	US26	76.85	-		
Floor Strike: 2" x 4-3/32"	US26D	76.85	032493		
Strike Height: 2-1/4"					
Max Door to Floor Clearance: 1-1/8" to 1-9/16"					
Fasteners: 4 ea. 12-24 x 1" TPHMS and #12 x 1" TPHWS; 3 ea. #14 x 1-1/2" FPHWS and anchors; 1/4 - 20 x 3/4" FPHMS with lead anchor					



329F					
Automatic Floor Stop and Holder	US3	72.85	078700	5	30
Material: Cast brass	US10	76.85	040616		
Holder Base: 3-1/16" x 3-1/2"	US10B	76.85	044158		
Projection: 1-15/16"	US26	76.85	116003		
Strike Height: 2-3/4"	US26D	76.85	029252		
Floor Strike: 2" x 4-3/32"					
Max Door to Floor Clearance: 1-5/8" to 2-1/16"					
Fasteners: 4 ea. 12-24 x 1" TPHMS and #12 x 1" TPHWS; 3 ea. #14 x 1-1/2" FPHWS and anchors; 1/4 - 20 x 3/4" FPHMS with lead anchor					



330D					
Pocket Door Latch	US3		086840	1	20
Material: Brass	US5		086841		
Fits: 1-3/8" - 1-3/4" door	US10	See Sliding Door Hardware Section for Pricing	066707		
Size: 2-3/4" x 2-1/2"	US10B		056768		
Finger Pull Extends: 1-3/8"	US15		078972		
Fasteners: #6 x 5/8" OPHWS	US15A		054061		
	US19		054570		
	US26		086837		
	US26D		086838		



330L					
Privacy Pocket Door Latch	US3		143162	1	20
Material: Brass	US5		143164		
Size: 2-3/4" x 2-1/2"	US10	See Sliding Door Hardware Section for Pricing	143165		
Finger Pull Extends: 1-3/8"	US10B		143158		
Strike: 1" x 2-1/4"	US15		143159		
1-3/8" doors	US15A		143160		
Fasteners: #6 x 5/8" OPHWS; #6 x 3/4" FPHWS	US19		143166		
	US26		143167		
	US26D		143161		





Description	Finish	2018 List	Stock No.	Box Qty.	Case Qty.
330M					
Privacy Pocket Door Latch	US3		143172	1	20
Material: Brass	US5		143178		
Size: 2-3/4" x 2-1/2"	US10	See Sliding	143168		
Finger Pull Extends: 1-3/8"	US10B	Door	143169		
Strike: 1" x 2-1/4"	US15	Hardware	143173		
1-3/4" doors	US15A	Section for	143174		
Fasteners: #6 x 5/8" OPHWS; #6 x 3/4" FPHWS	US19	Pricing	143175		
	US26		143170		
	US26D		143171		



334V					
Door Knocker w/ 115° Viewer	US3	39.05		1	50
Material: Solid cast brass	US4	38.10			
Knocker Size: 3-9/16" x 6-3/4"	US10	41.45			
Fasteners:	US10B	41.45			
Two (2) 8-32 x 2 FHMS for standard 1-3/4" doors	US26	39.05			
Two (2) #8 finish washers	US26D	38.10			
Two (2) 8-32 x 1-5/8" FHMS for 1-3/8" doors					

Lettering available - up to four characters, Arial, 1/2" tall, black - \$6.00 total added to net price. Not available on US10B finish.



336A					
161 Prep - Door Edge Filler Plate	Primed steel	2.50	023352	25	250
Gauge: .134"					
Size: 1-1/8" x 2-1/4"					



336B					
86 Prep - Door Edge Filler Plate	Primed steel	4.00	023329	25	250
Gauge: .180					
Size: 1-1/4" x 8"					



336C					
Door Face Filler Plate	Primed steel	3.35	023346	25	250
Gauge: .055"					
Size: 1-3/4" Diameter					



336D					
Door Face Filler Plate	Primed steel	3.80	023343	25	250
Gauge: .055					
Size: 2-5/8" Diameter					



336E					
Square - Door Edge Filler Plate	Primed steel	3.20	023334	25	250
Gauge: .134					
Size: 1-3/4" x 4-1/2"					



336F					
Bevel - Door Edge Filler Plate	Primed steel	3.05	023332	25	250
Gauge: .134					
Size: 1-1/2" x 4-1/2"					



336G					
Square - Door Edge Filler Plate	Primed steel	3.35	023340	25	250
Gauge: .134					
Size: 1-3/4" x 5"					

1. Items with the price in **bold and red** are Quick Ship items and ship in 24 hours. Please use stock number when ordering. 2. U/M is each unless otherwise noted.



Trim & Auxiliary

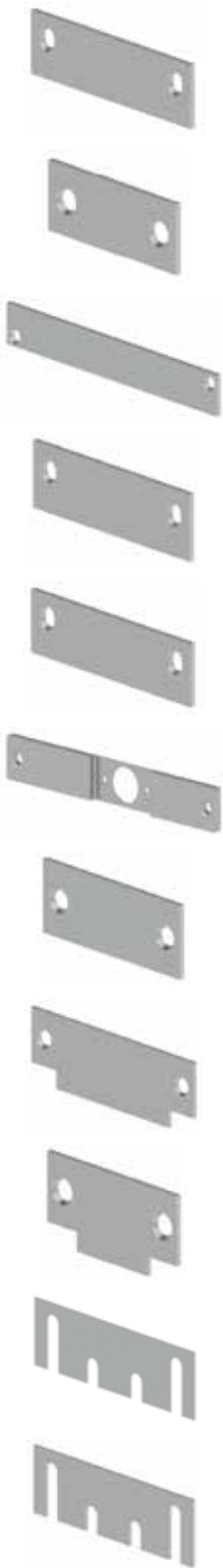

Description	Finish	2018 List	Stock No.	Box Qty.	Case Qty.
336H Bevel - Door Edge Shim Filler Plate Gauge: .134 Size: 1-1/2" x 5"	Primed steel	2.95	023336	25	250
336J Frame - Flush Bolt Strike Filler Plate Gauge: .083 Size: 15/16" x 2-1/4"	Primed steel	2.10	023342	25	250
336K Door - Flush Bolt Filler Plate Gauge: .134 Size: 1" x 6-3/4"	Primed steel	3.55	023341	25	250
336L Frame - Hinge Filler Plate Gauge: .134 Size: 1-5/8" x 4-1/2"	Primed steel	2.95	023330	25	250
336M Frame - Hinge Filler Plate Gauge: .134 Size: 1-5/8" x 5"	Primed steel	3.35	023331	25	250
336N 86 to 161 Edge Prep Latch Adapter Filler Plate Gauge: .238 Size: 1-1/4" x 8"	Primed steel	7.10	023351	25	100
336P Frame - Deadlock Strike Filler Plate Gauge: .083 Size: 1-1/8" x 2-3/4"	Primed steel	2.35	082122	25	250
336Q Frame - ASA Strike Filler Plate Gauge: .093 Size: 1-1/4" x 4-7/8"	Primed steel	2.65	023356	25	250
336R Frame - Cylindrical Lock Strike Filler Plate Gauge: .083 Size: 1-1/8" x 2-3/4"	Primed steel	2.25	023354	25	250
337A Template Hinge Shim Gauge: .028 Size: 1-7/16" x 4-1/2"	Primed steel	1.25	023347	50	500
337B Template Hinge Shim Gauge: .065 Size: 1-7/16" x 4-1/2"	Primed steel	1.60	023348	50	500





Description	Finish	2018 List	Stock No.	Box Qty.	Case Qty.
337C Template Hinge Shim Gauge: .028 Size: 1-7/16" x 5"	Primed steel	1.60	023349	50	500
337D Template Hinge Shim Gauge: .065 Size: 1-7/16" x 5"	Primed steel	1.70	023350	50	500
340D Latch Protector Plate with Frame Pin Material: 12 GA steel, stainless steel Size: 3" x 11" For 1-3/4" door thickness Fasteners: 5/16 - 20 x 1-1/2" carriage bolts with sex nuts For use w/ most mortise locks For use w/ cylindrical locksets with 3-3/4" backset or greater.	US2C US32D	14.00 27.65	041188 002179	1	10
341C Latch Protector Plate w/ Lock Cut Out Without Safety Studs Material: 12 GA steel, stainless steel Size: 3" x 11" For 1-3/4" door thickness Fasteners: 5/16 - 20 x 1-1/2" carriage bolts with sex nuts For use with cylindrical locksets with a 2-3/4" backset.	US32D	45.15	150739	1	10
341D Latch Protector Plate w/ Lock Cut Out with Frame Pin Material: 12 GA steel, stainless steel Size: 3" x 11" For 1-3/4" door thickness Fasteners: 5/16 - 20 x 1-1/2" carriage bolts with sex nuts For use with cylindrical locksets with a 2-3/4" backset.	US2C US32D	14.00 27.65	041191 002180	1	10
342D Latch Protector Plate w/ Escutcheon Cut Out Material: 12 GA steel, stainless steel Size: 3" x 11" For 1-3/4" door thickness Fasteners: 5/16 - 20 x 1-1/2" carriage bolts with sex nuts For use with cylindrical and mortise locksets	US32D	34.90	150740	1	10
345D Latch Protector Plate Material: 12 GA steel, stainless steel Size: 1-5/8" x 10" For 1-3/4" door thickness Fasteners: 5/16-20 x 1-1/2" carriage bolts with sex nuts For use with cylindrical and mortise locksets	US2C US32D	10.80 20.55	041194 002181	1	10

1. Items with the price in **bold and red** are Quick Ship items and ship in 24 hours.
Please use stock number when ordering. 2. U/M is each unless otherwise noted.



Trim & Auxiliary

	Description	Color	2018 List	Stock No.	Box Qty.	Case Qty.
MEN	350M					
	Engraved Plastic Sign - MEN	Brown (W1) w/ white lettering	15.85	089107	-	5
	Material: .125" thick plastic					
	Lettering: 3/4" Helvetica	Black (W2) w/ white lettering	15.85	092413		
	Size: 2" x 5"	Blue (W3) w/ white lettering	15.85	090948		
	Signs are individually packed in a polybag	Silver (B1) w/ black lettering	15.85	089108		
		Gold (B2) w/ black lettering	15.85	030383		
WOMEN	350W					
	Engraved Plastic Sign - WOMEN	Brown (W1) w/ white lettering	17.80	089103	-	5
	Material: .125" thick plastic					
	Lettering: 3/4" Helvetica	Black (W2) w/ white lettering	17.80	092414		
	Size: 2" x 5"	Blue (W3) w/ white lettering	17.80	091068		
	Fasteners: Double sided pressure sensitive tape, or screws (specify)	Silver (B1) w/ black lettering	17.80	089104		
Signs are individually packed in a polybag	Gold (B2) w/ black lettering	17.80	030384			
PUSH	350H					
	Engraved Plastic Sign - PUSH	Brown (W1) w/ white lettering	17.80	089109	-	5
	Material: .125" thick plastic					
	Lettering: 3/4" Helvetica	Black (W2) w/ white lettering	17.80	097215		
	Size: 2" x 4"	Blue (W3) w/ white lettering	17.80	032116		
	Fasteners: Double sided pressure sensitive tape, or screws (specify)	Silver (B1) w/ black lettering	17.80	089110		
Signs are individually packed in a polybag	Gold (B2) w/ black lettering	17.80	066158			
PULL	350L					
	Engraved Plastic Sign - PULL	Brown (W1) w/ white lettering	17.80	089111	-	5
	Material: .125" thick plastic					
	Lettering: 3/4" Helvetica	Black (W2) w/ white lettering	17.80	097216		
	Size: 2" x 4"	Blue (W3) w/ white lettering	17.80	032117		
	Fasteners: Double sided pressure sensitive tape, or screws (specify)	Silver (B1) w/ black lettering	17.80	089106		
Signs are individually packed in a polybag	Gold (B2) w/ black lettering	17.80	024447			
635	350R					
	Engraved Plastic Sign - Number	Brown (W1) w/ white lettering	15.85	000848	-	5
	Material: .125" thick plastic					
	Lettering: 3/4" Helvetica	Black (W2) w/ white lettering	15.85	010640		
	Size: 2" x 4"	Blue (W3) w/ white lettering	15.85	119668		
	Fasteners: Double sided pressure sensitive tape, or screws (specify)	Silver (B1) w/ black lettering	15.85	067081		
Signs are individually packed in a polybag						
Up to 3 characters (4 additional characters \$6.30)						

PUSH

351H Engraved Plastic Sign - PUSH Material: .125" thick plastic Lettering: 3/4" Helvetica Size: 1" x 4-1/2" Fasteners: Double sided pressure sensitive tape, or screws (specify) Signs are individually packed in a polybag	Brown (W1) w/ white lettering	15.85	011628	-	5
	Black (W2) w/ white lettering	15.85	016508		
	Blue (W3) w/ white lettering	15.85	017432		
	Silver (B1) w/ black lettering	15.85	097655		
	Gold (B2) w/ black lettering	15.85	009462		

PULL

351L Engraved Plastic Sign - PULL Material: .125" thick plastic Lettering: 3/4" Helvetica Size: 1" x 4-1/2" Fasteners: Double sided pressure sensitive tape, or screws (specify) Signs are individually packed in a polybag	Brown (W1) w/ white lettering	15.85	011623	-	5
	Black (W2) w/ white lettering	15.85	016509		
	Blue (W3) w/ white lettering	15.85	017433		
	Silver (B1) w/ black lettering	15.85	097656		
	Gold (B2) w/ black lettering	15.85	009464		

 **MEN**

352M Engraved Plastic Sign - MEN Material: .125" thick plastic Lettering: 3/4" Helvetica Size: 2-1/2" x 6" Fasteners: Double sided pressure sensitive tape, or screws (specify) Signs are individually packed in a polybag	Brown (W1) w/ white lettering	20.70	092362	-	5
	Black (W2) w/ white lettering	20.70	089552		
	Blue (W3) w/ white lettering	20.70	089105		
	Silver (B1) w/ black lettering	20.70	092753		
	Gold (B2) w/ black lettering	20.70	098437		

 **WOMEN**

352W Engraved Plastic Sign - WOMEN Material: .125" thick plastic Lettering: 3/4" Helvetica Size: 2-1/2" x 7" Fasteners: Double sided pressure sensitive tape, or screws (specify) Signs are individually packed in a polybag	Brown (W1) w/ white lettering	21.70	092363	-	5
	Black (W2) w/ white lettering	21.70	089553		
	Blue (W3) w/ white lettering	21.70	089100		
	Silver (B1) w/ black lettering	21.70	092754		
	Gold (B2) w/ black lettering	21.70	098438		

Restroom

354A Engraved Plastic Sign - Restroom Material: .125" thick plastic Lettering: 3/4" Helvetica Size: 2" x 6" Fasteners: Double sided pressure sensitive tape Signs are individually packed in a polybag	Brown (W1) w/ white lettering	26.65	-	-	5
	Black (W2) w/ white lettering	26.65	024414		
	Blue (W3) w/ white lettering	26.65	035530		

1. Items with the price in **bold and red** are Quick Ship items and ship in 24 hours. Please use stock number when ordering. 2. U/M is each unless otherwise noted.



Trim & Auxiliary

Restrooms

354B

Engraved Plastic Sign - Restrooms	Brown (W1) w/ white lettering	26.65	-	-	5
Material: .125" thick plastic					
Lettering: 3/4" Helvetica	Black (W2) w/ white lettering	26.65	049899		
Size: 2" x 6"					
Fasteners: Double sided pressure sensitive tape	Blue (W3) w/ white lettering	26.65	025589		
Signs are individually packed in a polybag					

Description	Finish	2018 List	Stock No.	Box Qty.	Case Qty.
-------------	--------	-----------	-----------	----------	-----------

360M

Engraved Metal Sign - MEN	US3	44.30	090400	-	5
Material: .050" thick metal	US28	60.95	095542		
Lettering: 3/4" Helvetica black filled	US32D	60.95	090407		
Size: 2" x 6"					
Fasteners: Double sided pressure sensitive tape					
Signs are individually packed in a polybag					

MEN

360W

Engraved Metal Sign - WOMEN	US3	44.30	020058	-	5
Material: .050" thick metal	US28	60.95	095988		
Lettering: 3/4" Helvetica black filled	US32D	60.95	090409		
Size: 2" x 6"					
Fasteners: Double sided pressure sensitive tape					
Signs are individually packed in a polybag					

WOMEN

361H

Engraved Metal Sign - PUSH	US3	35.55	090412	-	5
Material: .050" thick metal	US10B	40.90	001026		
Lettering: 3/4" Helvetica black filled	US28	35.55	092478		
Size: 2" x 4"	US32D	49.00	090414		
Fasteners: Double sided pressure sensitive tape					
Signs are individually packed in a polybag					

PUSH

361L

Engraved Metal Sign - PULL	US3	35.55	090410	-	5
Material: .050" thick metal	US10B	40.90	001027		
Lettering: 3/4" Helvetica black filled	US28	35.55	092474		
Size: 2" x 4"	US32D	49.00	090411		
Fasteners: Double sided pressure sensitive tape					
Signs are individually packed in a polybag					

PULL

P
U
S
H

362H

Engraved Metal Sign - PUSH	US3	35.55	096199	-	5
Material: .050" thick metal	US10B	40.90	-		
Lettering: 3/4" Helvetica black filled	US28	35.55	022877		
Size: 1" x 4-1/2"	US32D	49.00	018669		
Fasteners: Double sided pressure sensitive tape					
Signs are individually packed in a polybag					

P
U
L
L

362L

Engraved Metal Sign - PULL	US3	35.55	097728	-	5
Material: .050" thick metal	US10B	40.90	-		
Lettering: 3/4" Helvetica black filled	US28	35.55	022878		
Size: 1" x 4-1/2"	US32D	49.00	016954		
Fasteners: Double sided pressure sensitive tape					
Signs are individually packed in a polybag					





Description	Color	2018 List	Stock No.	Box Qty.	Case Qty.
364N Engraved International Symbol No Smoking Material: .125" thick plastic Size: 6" x 6" Fasteners: Pressure sensitive tape standard, or screws (specify) Signs are individually packed in a polybag	Red (W4) w/ raised white symbol	31.95	089099	-	5



364S International Handicap Symbol Material: .0625" thick plastic Raised HANDICAP symbol Size: 3" x 3" Fasteners: Pressure sensitive tape standard, or screws (specify) Signs are individually packed in a polybag	Blue (W3) w/ raised white symbol	19.10	099952	-	5
--	--	-------	--------	---	---



364M International Handicap Symbol Material: .0625" thick plastic Raised HANDICAP symbol Size: 4" x 4" Fasteners: Double sided pressure sensitive tape standard, or screws (specify) Signs are individually packed in a polybag	Blue (W3) w/ raised white symbol	23.85	092522	-	5
---	--	-------	--------	---	---



364L International Handicap Symbol Material: .125" thick plastic 1/32" raised HANDICAP symbol Size: 6" x 6" Fasteners: Double sided pressure sensitive tape standard, or screws (specify) Signs are individually packed in a polybag	Brown (W1) w/ raised white symbol	32.85	017405	-	5
	Black (W2) w/ raised white symbol	32.85	098102		
	Blue (W3) w/ raised white symbol	32.85	089101		



365M ADA Tactile Signage - MEN Material: .125" thick plastic Grade 2 Braille Translation Size: 6" x 8" Fasteners: Double sided pressure sensitive tape Signs are individually packed in a polybag	Brown (W1) w/ raised white symbol	53.65	089102	-	5
	Black (W2) w/ raised white symbol	53.65	089097		
	Blue (W3) w/ raised white symbol	53.65	089098		



365W ADA Tactile Signage - WOMEN Material: .125" thick plastic Grade 2 Braille Translation Size: 6" x 8" Fasteners: Double sided pressure sensitive tape Signs are individually packed in a polybag	Brown (W1) w/ raised white symbol	56.40	089116	-	5
	Black (W2) w/ raised white symbol	56.40	089117		
	Blue (W3) w/ raised white symbol	56.40	089118		

1. Items with the price in **bold and red** are Quick Ship items and ship in 24 hours.
Please use stock number when ordering. 2. U/M is each unless otherwise noted.



Trim & Auxiliary

325



Description	Color	2018 List	Stock No.	Box Qty.	Case Qty.
366R ADA Tactile Signage Room Number Material: .125" thick plastic Grade 2 Braille Translation Size: 2-1/2" x 5" Fasteners: Double sided pressure sensitive tape Up to 3 characters included Add \$6.30 for a fourth character Signs are individually packed in a polybag	Brown (W1) w/ raised white symbol	26.90	113411	-	5
	Black (W2) w/ raised white symbol	26.90	008919		
	Blue (W3) w/ raised white symbol	26.90	008910		
366S ADA Tactile Signage - STAIRS Material: .125" thick plastic Grade 2 Braille Translation Size: 6" x 8" Fasteners: Double sided pressure sensitive tape Signs are individually packed in a polybag	Brown (W1) w/ raised white symbol	47.80	089112	-	5
	Black (W2) w/ raised white symbol	47.80	089113		
	Blue (W3) w/ raised white symbol	47.80	089115		
368E ADA Tactile Signage - EXIT Material: .125" thick plastic Grade 2 Braille Translation Size: 6" x 8" Fasteners: Double sided pressure sensitive tape Signs are individually packed in a polybag	Brown (W1) w/ raised white symbol	47.80	089119	-	5
	Black (W2) w/ raised white symbol	47.80	090296		
	Blue (W3) w/ raised white symbol	47.80	089088		
368M ADA Tactile Signage - MEN Material: .125" thick plastic Grade 2 Braille Translation Size: 6" x 8" Fasteners: Double sided pressure sensitive tape Signs are individually packed in a polybag	Brown (W1) w/ raised white symbol	56.65	089089	-	5
	Black (W2) w/ raised white symbol	56.65	089456		
	Blue (W3) w/ raised white symbol	56.65	089090		
368W ADA Tactile Signage - WOMEN Material: .125" thick plastic Grade 2 Braille Translation Size: 6" x 8" Fasteners: Double sided pressure sensitive tape Signs are individually packed in a polybag	Brown (W1) w/ raised white symbol	59.45	089092	-	5
	Black (W2) w/ raised white symbol	59.45	090033		
	Blue (W3) w/ raised white symbol	59.45	089093		





Description	Color	2018 List	Stock No.	Box Qty.	Case Qty.
368U ADA Tactile Signage - UNISEX Material: .125" thick plastic Grade 2 Braille Translation Size: 8" x 8" Fasteners: Double sided pressure sensitive tape Signs are individually packed in a polybag	Brown (W1) w/ raised white symbol	65.55	089719	-	5
	Black (W2) w/ raised white symbol	65.55	090224		
	Blue (W3) w/ raised white symbol	65.55	089091		



369L ADA Tactile Signage - ACCESS LEFT Material: .125" thick plastic Grade 2 Braille translation Size: 6" x 8" Fasteners: Double sided pressure sensitive tape Signs are individually packed in a polybag	Brown (W1) w/ raised white symbol	53.65	089094	-	5
	Black (W2) w/ raised white symbol	53.65	094727		
	Blue (W3) w/ raised white symbol	53.65	089095		



369R ADA Tactile Signage - ACCESS RIGHT Material: .125" thick plastic Grade 2 Braille translation Size: 6" x 8" Fasteners: Double sided pressure sensitive tape Signs are individually packed in a polybag	Brown (W1) w/ raised white symbol	53.65	089096	-	5
	Black (W2) w/ raised white symbol	53.65	094726		
	Blue (W3) w/ raised white symbol	53.65	089120		



370M ADA Tactile Signage - RESTROOM MEN Material: 9/16" thick plastic Grade 2 Braille Translation Size: 10-1/2" side Fasteners: Double sided pressure sensitive tape Signs are individually packed in a polybag	Blue (W3) w/ raised white symbol and lettering	32.85	089558	-	5
--	---	-------	--------	---	---



370U ADA Tactile Signage - RESTROOM UNISEX Material: 9/16" thick plastic Grade 2 Braille Translation Size: 12" diameter Fasteners: Double sided pressure sensitive tape Signs are individually packed in a polybag	Blue (W3) w/ raised white symbol and lettering	32.85	091565	-	5
---	---	-------	--------	---	---



370W ADA Tactile Signage - RESTROOM WOMEN Material: 9/16" thick plastic Grade 2 Braille Translation Size: 12" diameter Fasteners: Double sided pressure sensitive tape Signs are individually packed in a polybag	Blue (W3) w/ raised white symbol and lettering	32.85	089557	-	5
--	---	-------	--------	---	---

1. Items with the price in **bold and red** are Quick Ship items and ship in 24 hours.
Please use stock number when ordering. 2. U/M is each unless otherwise noted.



Trim & Auxiliary



Description	Finish	2018 List	Stock No.	Box Qty.	Case Qty.
901P					
Coat Hook - Short single	US3	18.30	004095	1	-
Material: Brass	US26D	18.30	006028		
Diameter: 1"					
Projection: 1-1/4"					
Fasteners: #14 x 1-1/4" wood thread					
902P					
Coat Hook - Long Single	US3	25.70	004098	1	12
Material: Brass	US26D	25.70	011657		
Diameter: 1"					
Projection: 2-1/2"					
Fasteners: #14 x 1-1/4" wood thread					
903P					
Coat Hook - Long Double	US3	35.30	022247	1	12
Material: Brass	US26D	35.30	006364		
Diameter: 1"					
Projection: 2-1/2"					
Fasteners: #14 x 1-1/4" wood thread					
910P					
Offset Mounting Vertical Pull					
Pull Diameter: 1-1/4"					
Fasteners: 3/8 - 16 FPHMS with finish washers					
Clearance: 1-1/2"					
Projection: 2-3/4"					
Length: 36"	US3	329.90	-	1	12
CTC: 20"	US4	329.90	117797		
	US10	341.05	045611		
	US10B	341.05	075958		
	US15A	341.05	-		
	US26	341.05	013794		
	US26D	341.05	034212		
	US28	311.80	097652		
	US32D	249.50	034762		
Length: 72"	US3	396.80	-	1	12
CTC: 56"	US4	396.80	-		
	US10	420.95	-		
	US10B	420.95	001763		
	US15A	420.95	-		
	US26	420.95	013765		
	US26D	420.95	001766		
	US28	346.55	-		
	US32D	351.25	001767		





Description	Finish	2018 List	Stock No.	Box Qty.	Case Qty.
910B					
Offset Mounting Vertical Pull					
BTB Mounting					
Pull Diameter: 1-1/4"					
Clearance: 1-1/2"					
Projection: 2-3/4"					
Offset: 1-5/8"					
Length: 36"					
CTC: 20"					
	US3	679.55	141396	1	12
	US4	679.55	133716		
	US10	701.85	048451		
	US10B	701.85	043270		
	US15A	701.85	-		
	US26	701.85	-		
	US26D	701.85	048202		
	US28	643.40	-		
	US32D	518.75	022333		
Length: 72"	US3	813.35	-	1	12
CTC: 56"	US4	813.35	-		
	US10	861.60	-		
	US10B	861.60	045049		
	US15A	861.60	-		
	US26	861.60	145909		
	US26D	861.60	095610		
	US28	712.90	043452		
	US32D	722.25	034310		



915P					
Straight Mounting Vertical Pull					
Pull Diameter: 1-1/4"					
Fasteners: 3/8 - 16 FPHMS with finish washers					
Length: 36"					
CTC: 20"					
Clearance: 1-1/2"					
Projection: 2-3/4"					
	US3	311.80	-	1	12
	US4	311.80	030973		
	US10	328.95	-		
	US10B	328.95	024013		
	US15A	328.95	-		
	US26	328.95	011437		
	US26D	328.95	095117		
	US28	238.85	046879		
	US32D	272.35	022924		
Length: 72"	US3	363.35	026509	1	12
CTC: 56"	US4	363.35	093132		
Clearance: 1-1/2"	US10	386.15	-		
Projection: 2-3/4"	US10B	386.15	047686		
	US15A	386.15	-		
	US26	386.15	107976		
	US26D	386.15	076713		
	US28	311.80	147145		
	US32D	328.95	033534		

1. Items with the price in **bold and red** are Quick Ship items and ship in 24 hours.
 Please use stock number when ordering. 2. U/M is each unless otherwise noted.



Trim & Auxiliary



Description	Finish	2018 List	Stock No.	Box Qty.	Case Qty.
915B					
915B					
Straight Mounting Vertical Pull					
BTB Mounting					
Pull Diameter: 1-1/4"					
Length: 36"	US3	643.40	083233	1	12
CTC: 20"	US4	643.40	095145		
Clearance: 1-1/2"	US10	677.65	127056		
Projection: 2-3/4"	US10B	677.65	045158		
	US15A	677.65	-		
	US26	677.65	042157		
	US26D	677.65	099445		
	US28	497.50	086258		
	US32D	564.45	036192		
Length: 72"	US3	746.45	079229	1	12
CTC: 56"	US4	746.45	030970		
Projection: 2-3/4"	US10	792.00	-		
	US10B	792.00	039857		
	US15A	792.00	-		
	US26	792.00	-		
	US26D	792.00	075209		
	US28	643.40	091752		
	US32D	677.65	038310		



920P					
C-Shaped Pull	US3	396.80	175665	1	12
Projection: 2-1/4"	US4	396.80	023694		
Base Diameter: 1"	US10	453.45	068045		
Clearance: 1-3/4"	US10B	453.45	067513		
CTC: 8-1/2"	US15A	453.45	007029		
Fasteners: 3/8 - 16 FPHMS with finish washers	US26	453.45	-		
	US26D	453.45	127861		
	US28	254.60	-		
	US32D	386.15	006521		



920B					
C-Shaped Pull	US3	813.35	075752	1	12
BTB Mounting	US4	813.35	023825		
Projection: 2-1/4"	US10	926.65	-		
Base Diameter: 1"	US10B	926.65	-		
Clearance: 1-3/4"	US15A	926.65	-		
CTC: 8-1/2"	US26	926.65	-		
	US26D	813.35	-		
	US28	529.05	-		
	US32D	792.00	028143		





Description	Finish	2018 List	Stock No.	Box Qty.	Case Qty.
921P					
C-Shaped Pull	US3	793.45	108557	1	12
Projection: 2-1/8"	US4	793.45	-		
Clearance: 1-1/2"	US10B	793.45	025579		
Offset: 8-1/2"	US15A	793.45	-		
CTC: 17-1/2"	US26	793.45	-		
Fasteners: 3/8 - 16 FPHMS with finish washers	US26D	793.45	063488		
	US32D	747.90	039887		
921B					
C-Shaped Pull	US3	1,606.65	-	1	12
BTB Mounting	US4	1,606.65	-		
Projection: 2-1/8"	US10B	1,606.65	-		
Clearance: 1-1/2"	US15A	1,606.65	-		
Offset: 8-1/2"	US26	1,606.65	-		
CTC: 17-1/2"	US26D	1,606.65	092126		
	US32D	1,515.55	021628		
922P					
C-Shaped Pull Continuous					
Pull Diameter: 1"					
Projection: 2-1/2"					
Fasteners: 3/8 - 16 FPHMS with finish washers					
Clearance: 1-1/2"					
CTC: 10"	US3	247.65	052183	1	12
	US4	247.65	-		
	US10	301.10	001074		
	US10B	301.10	076741		
	US15A	301.10	-		
	US26	301.10	080488		
	US26D	301.10	033046		
	US28	159.45	-		
	US32D	238.85	040459		
CTC: 12"	US3	284.40	007927	1	12
	US4	284.40	018417		
	US10	317.80	029399		
	US10B	317.80	029237		
	US15A	317.80	-		
	US26	317.80	031122		
	US26D	317.80	033048		
	US28	181.70	-		
	US32D	261.20	017908		

1. Items with the price in **bold and red** are Quick Ship items and ship in 24 hours.
 Please use stock number when ordering. 2. U/M is each unless otherwise noted.



Trim & Auxiliary



Description	Finish	2018 List	Stock No.	Box Qty.	Case Qty.
922B					
C-Shaped Pull Continuous					
BTB Mounting					
Pull Diameter: 1"					
Projection: 2-1/2"					
Clearance: 1-1/2"					
CTC: 10"					
	US3	515.10	043544	1	12
	US4	515.10	054798		
	US10	621.90	-		
	US10B	621.90	076740		
	US15A	621.90	-		
	US26	621.90	038676		
	US26D	621.90	028387		
	US28	338.65	047322		
	US32D	497.50	031463		
CTC: 12"					
	US3	588.55	025373	1	12
	US4	588.55	049391		
	US10	655.40			
	US10B	655.40	031604		
	US15A	655.40	-		
	US26	655.40	039882		
	US26D	655.40	054764		
	US28	383.25	-		
	US32D	542.15	032177		



923P					
C-Shaped Pull Flanged					
Pull Diameter: 1"					
Projection: 2-3/4"					
Clearance: 1-3/4"					
Base Diameter: 3/4"					
Fasteners: 3/8 - 16 FPHMS with finish washers					
CTC: 10"					
	US3	283.45	-	1	12
	US4	283.45	-		
	US10	300.15	-		
	US10B	300.15	042387		
	US15A	300.15	-		
	US26	300.15	-		
	US26D	300.15	-		
	US28	158.95	042579		
	US32D	237.95	107215		
CTC: 12"					
	US3	305.75	028028	1	12
	US4	305.75	041657		
	US10	317.80	-		
	US10B	317.80	086167		
	US15A	317.80	-		
	US26	317.80	007281		
	US26D	317.80	059492		
	US28	183.10	-		
	US32D	261.20	043111		





Description	Finish	2018 List	Stock No.	Box Qty.	Case Qty.
923B					
C-Shaped Pull Flanged					
BTB Mounting					
Pull Diameter: 1"					
Projection: 2-3/4"					
Clearance: 1-3/4"					
Base Diameter: 3/4"					
CTC: 10"	US3	586.65	-	1	12
	US4	586.65	-		
	US10	620.00	-		
	US10B	620.00	-		
	US15A	620.00	-		
	US26	620.00	056938		
	US26D	620.00	027475		
	US28	337.65	087162		
	US32D	495.65	097112		
CTC: 12"	US3	631.25	033306	1	12
	US4	631.25	-		
	US10	655.40	-		
	US10B	655.40	109525		
	US15A	655.40	-		
	US26	655.40	036898		
	US26D	655.40	100390		
	US28	385.95	-		
	US32D	542.15	032950		
924P					
C-Shaped Pull	US3	351.25	047324	1	12
O/A Height: 15"	US4	351.25	081526		
Projection: 2-1/2"	US10B	386.15	039224		
Clearance: 1-1/2"	US15A	386.15	112695		
Offset: 6-1/2"	US26	386.15	-		
Fasteners: 3/8 -16 FPHMS with finish washers	US26D	351.25	033435		
	US32D	511.00	091516		
924B					
C-Shaped Pull	US3	722.25	-	1	12
BTB Mounting	US4	722.25	094302		
O/A Height: 15"	US10B	792.00	027198		
Projection: 2-1/2"	US15A	792.00	113505		
Clearance: 1-1/2"	US26	792.00	-		
Offset: 6-1/2"	US26D	722.25	034830		
	US32D	1,041.75	044848		



1. Items with the price in **bold and red** are Quick Ship items and ship in 24 hours.
Please use stock number when ordering. 2. U/M is each unless otherwise noted.



Trim & Auxiliary



Description	Finish	2018 List	Stock No.	Box Qty.	Case Qty.
925P					
C-Shaped Pull					
Pull Diameter: 1-1/4"					
Fasteners: 3/8 - 16 FPHMS with finish washers					
6-1/2"	US3	311.80	-	1	12
	US4	311.80	-		
	US10	328.95	-		
	US10B	328.95	-		
	US15A	328.95	-		
	US26	328.95	-		
	US26D	328.95	-		
	US28	225.80	-		
	US32D	254.60	082874		
8-1/2"	US3	317.80	105030	1	12
	US4	317.80	-		
	US10	340.10	-		
	US10B	340.10	009660		
	US15A	340.10	-		
	US26	340.10	-		
	US26D	340.10	020046		
	US28	237.95	-		
	US32D	272.35	093311		
12-1/2"	US3	374.45	063609	1	12
	US4	374.45	022243		
	US10	396.80	-		
	US10B	396.80	095383		
	US15A	396.80	-		
	US26	396.80	-		
	US26D	396.80	015911		
	US28	272.35	-		
	US32D	363.35	019494		



Description	Finish	2018 List	Stock No.	Box Qty.	Case Qty.
925B					
C-Shaped Pull					
BTB Mounting					
Pull Diameter: 1-1/4"					
6-1/2"	US3	643.40	-	1	12
	US4	643.40	-		
	US10	677.65	-		
	US10B	677.65	-		
	US15A	677.65	-		
	US26	677.65	-		
	US26D	631.25	-		
	US28	677.65	-		
	US32D	529.05	032601		
8-1/2"	US3	655.40	-	1	12
	US4	655.40	-		
	US10	699.95	-		
	US10B	699.95	126789		
	US15A	699.95	-		
	US26	699.95	-		
	US26D	699.95	-		
	US28	495.65	-		
	US32D	564.45	091632		
12-1/2"	US3	768.75	084531	1	12
	US4	768.75	-		
	US10	813.35	-		
	US10B	813.35	-		
	US15A	813.35	-		
	US26	813.35	-		
	US26D	813.35	-		
	US28	564.45	-		
	US32D	746.45	-		
926P					
Curved Shaped Pull	US3	363.35	087555	1	12
Base Diameter: 1-1/4"	US4	363.35	-		
Projection: 3"	US10B	407.95	000085		
Clearance: 1-13/16"					
Offset: 5-9/32"					
CTC: 12"					
Pull Diameter: 1-3/16"					
Fasteners: 3/8 - 16 FPHMS with finish washers					
926B					
Curved Shaped Pull	US3	746.45	-	1	12
BTB Mounting	US4	746.45	-		
Base Diameter: 1-1/4"	US10B	835.65	-		
Projection: 3"					
Clearance: 1-13/16"					
Offset: 5-9/32"					
CTC: 12"					
Pull Diameter: 1-3/16"					



1. Items with the price in **bold and red** are Quick Ship items and ship in 24 hours.
Please use stock number when ordering. 2. U/M is each unless otherwise noted.



Trim & Auxiliary



Description	Finish	2018 List	Stock No.	Box Qty.	Case Qty.
930P					
90° Pull					
Fasteners: 3/8 - 16 FPHMS with finish washers					
Projection: 3"					
Clearance: 1-3/4"					
10" x 10", 14-5/32 CTC	US3	238.85	-	1	12
	US4	238.85	-		
	US10B	272.35	104490		
	US15A	272.35	-		
	US26	272.35	-		
	US26D	272.35	038630		
	US28	146.85	-		
	US32D	226.75	041518		
<hr/>					
12" x 12" 16-31/32" CTC	US3	255.55	-	1	12
	US4	255.55	-		
	US10B	295.10	-		
	US15A	295.10	-		
	US26	249.50	063600		
	US26D	249.50	-		
	US28	159.45	-		
	US32D	238.85	063295		



930B					
90° Pull					
BTB Mounting					
Projection: 3"; Clearance: 1-3/4"					
10" x 10", 14-5/32 CTC	US3	497.50	078218	1	12
	US4	497.50	-		
	US10B	564.45	104485		
	US15A	564.45	-		
	US26	564.45	-		
	US26D	564.45	-		
	US28	313.50	-		
	US32D	473.25	102505		
<hr/>					
12" x 12" 16-31/32" CTC	US3	530.90	-	1	12
	US4	530.90	-		
	US10B	609.90	-		
	US15A	609.90	-		
	US26	518.75	-		
	US26D	518.75	-		
	US28	338.65	-		
	US32D	497.50	048305		



932P					
S-Shaped Pull					
Projection: 3"					
Clearance: 2"					
Pull Diameter: 1"					
Fasteners: 3/8 - 16 FPHMS with finish washers					
	US3	476.15	017835	1	12
	US4	476.15	019496		
	US10B	521.75	039480		
	US15A	521.75	020472		
	US26	521.75	-		
	US26D	476.15	019495		
	US28	386.15	-		
	US32D	465.55	021879		



Description	Finish	2018 List	Stock No.	Box Qty.	Case Qty.
933P					
Colonial Style Door Pull	US3	91.15	021632	1	12
Projection: 2-3/16"	US4	80.05	025560		
Pull Diameter: 1"	US10B	107.85	041459		
Base Diameter: 15/16"	US26	107.85	140775		
Fasteners: 3/8 - 16 FPHMS with finish washers					
Clearance: 1-3/16"					
CTC: 6"					
933B					
Colonial Style Door Pull	US3	202.10	-	1	12
BTB Mounting	US4	179.90	-		
Projection: 2-3/16"	US10B	235.50	020879		
Pull Diameter: 1"	US26	235.50	-		
Base Diameter: 15/16"					
Clearance: 1-3/16"					
CTC: 6"					
934P					
Offset Pull					
Projection: 3-1/8"					
Pull Diameter: 1-1/4"					
Base Diameter: 1"					
Clearance: 1-7/8"					
Fasteners: 3/8 - 16 FPHMS with finish washers					
CTC: 12"	US3	328.95	015408	1	12
	US4	328.95	055245		
	US10B	328.95	018229		
	US15A	328.95	022244		
	US26	328.95	024963		
	US26D	328.95	009614		
	US28	325.20	-		
	US32D	396.80	087258		
CTC: 16"	US3	340.55	015588	1	12
	US4	340.55	-		
	US10B	340.55	018887		
	US15A	340.55	014454		
	US26	340.55	-		
	US26D	340.55	081586		
	US28	334.55	-		
	US32D	410.65	055788		
CTC: 18"	US3	373.05	012816	1	12
	US4	373.05	-		
	US10B	373.05	018219		
	US15A	373.05	-		
	US26	373.05	024883		
	US26D	373.05	-		
	US28	367.00	-		
	US32D	449.70	089638		

1. Items with the price in **bold and red** are Quick Ship items and ship in 24 hours.
Please use stock number when ordering. 2. U/M is each unless otherwise noted.



Trim & Auxiliary



Description	Finish	2018 List	Stock No.	Box Qty.	Case Qty.
934B					
Offset Pull					
BTB Mounting					
Base Diameter: 1"					
Projection: 3-1/8"					
Clearance: 1-7/8"					
Pull Diameter: 1-1/4"					
CTC: 12"	US3	677.65	-	1	12
	US4	677.65	048154		
	US10B	677.65	042701		
	US15A	677.65	-		
	US26	677.65	-		
	US26D	677.65	-		
	US28	670.20	-		
	US32D	813.35	120341		
CTC: 16"	US3	700.90	083864	1	12
	US4	700.90	-		
	US10B	700.90	-		
	US15A	700.90	-		
	US26	700.90	-		
	US26D	700.90	-		
	US28	688.85	-		
	US32D	841.10	-		
CTC: 18"	US3	765.90	-	1	12
	US4	765.90	048152		
	US10B	765.90	-		
	US15A	765.90	-		
	US26	765.90	-		
	US26D	765.90	-		
	US28	753.75	-		
	US32D	919.10	098230		
936P					
Coat Hook Single/Angled	US3	48.40	021976	1	12
Material: Brass	US26D	48.40	009820		
Base Diameter: 1-15/16"					
Hook Diameter: 11/16"					
Projection: 3-5/16"					
937P					
Coat Hook	US3	49.60	028259	1	12
Material: Brass	US26D	49.60	009821		
Projection: 3-3/4" top hook; 2-1/2" bottom hook					
940P					
Double Coat Hook	US3	18.10	028110	1	12
Material: Brass	US26D	18.10	022327		
Top Projection: 3-15/16"					
Bottom Projection: 2-1/8"					
Thickness: 1/4"					
Fasteners: #10 x 1" FPHWS					





Description	Finish	2018 List	Stock No.	Box Qty.	Case Qty.
941P Single Coat Hook Material: Brass Projection: 2-1/8" Thickness: 1/4" Fasteners: #10 x 1" FPHWS	US3 US26D	16.85 16.85	043274 017192	1	12
945P Double Coat Hook - Surface mounting Material: Brass O/A Height: 5-1/2" Projection: 3-5/16" Fasteners: #10 x 1" FPHWS w/ anchors	US3 US26D	45.95 45.95	041591 000986	1	12
946P Double Coat Hook w/ Concealed Mounting Material: Brass O/A Height: 5-1/2" Projection: 3-11/16" Fasteners: #10 x 1" FPHWS w/ anchors	US3 US26D	87.60 87.60	035563 016502	1	12
951P Double Coat Hook/Straight Material: Brass O/A Height: 5-3/4" Projection: 2-3/4"	US3 US26D	87.60 87.60	009815 007030	1	12
952P Single Coat Hook/Straight Material: Brass O/A Height: 2-13/16" Projection: 2-7/32"	US3 US26D	70.30 70.30	009818 009816	1	12
956P Double Coat Hook/Angled Material: Brass O/A Height: 5-11/16" Projection: 3-23/32"	US3 US4 US26D	85.30 85.30 85.30	022248 190569 009823	1	12
957P Coat Hook Materials: Brass Projection: 1-3/4" Base Diameter: 3/4" Fasteners: #10 x 1" wood thread	US3 US26D	21.55 21.55	038315 010738	1	12
960P Square Tip Pull O/A Height: 16" Base Diameter: 1-1/4" Pull Diameter: 1" Projection: 3-1/4" Clearance: 1-3/4" Fasteners: 3/8 - 16 FPHMS with finish washers CTC: 12"	US3 US4 US10B US15A US26 US26D	430.65 430.65 430.65 430.65 430.65 430.65	009259 038157 011621 013611 020471 015493	1	12

1. Items with the price in **bold and red** are Quick Ship items and ship in 24 hours.
Please use stock number when ordering. 2. U/M is each unless otherwise noted.



Trim & Auxiliary



Description	Finish	2018 List	Stock No.	Box Qty.	Case Qty.
960B					
Square Tip Pull	US3	881.10	-	1	12
BTB Mounting	US4	881.10	044725		
O/A Height: 16"	US10B	881.10	075667		
Base Diameter: 1-1/4"	US15A	881.10	-		
Pull Diameter: 1"	US26	881.10	-		
Projection: 3-1/4"	US26D	881.10	069324		
Clearance: 1-3/4"					
CTC: 12"					
961P					
Steeple Tip Pull	US3	407.95	000571	1	12
O/A Height: 16-5/16"	US4	407.95	-		
Base Diameter: 2"	US10B	407.95	015679		
Pull Diameter: 1"	US15A	407.95	009262		
Projection: 3"	US26	407.95	-		
Clearance: 1-3/4"	US26D	407.95	015011		
Fasteners: 3/8 - 16 FPHMS with finish washers					
CTC: 12"					
961B					
Steeple Tip Pull	US3	835.65	026830	1	12
BTB Mounting	US4	835.65	074979		
O/A Height: 16-5/16"	US10B	835.65	078830		
Base Diameter: 2"	US15A	835.65	-		
Pull Diameter: 1"	US26	835.65	-		
Projection: 3"	US26D	835.65	092283		
Clearance: 1-3/4"					
CTC: 12"					
962P					
Acorn Tip Pull	US3	407.95	007923	1	12
O/A Height: 16-5/16"	US4	407.95	011372		
Base Diameter: 2"	US10B	407.95	011629		
Pull Diameter: 1"	US15A	407.95	000573		
Projection: 3"	US26	407.95	009264		
Clearance: 1-7/8"	US26D	407.95	-		
Fasteners: 3/8 - 16 FPHMS with finish washers					
CTC: 12"					



Description	Finish	2018 List	Stock No.	Box Qty.	Case Qty.
963P					
Acorn Tip Pull - Offset					
Pull Diameter: 1"					
Fasteners: 3/8 - 16 FPHMS with finish washers					
CTC: 12"	US3	442.30	090673	1	12
	US4	425.60	-		
	US10B	442.30	093281		
	US15A	442.30	-		
	US26	442.30	-		
	US26D	442.30	-		
CTC: 16"	US3	544.55	-	1	12
	US4	515.75	-		
	US10B	544.55	125026		
	US15A	544.55	-		
	US26	544.55	-		
	US26D	544.55	089733		
CTC: 18"	US3	549.15	068942	1	12
	US4	441.35	080532		
	US10B	553.40	099640		
	US15A	553.40	-		
	US26	553.40	-		
	US26D	553.40	015561		
CTC: 24"	US3	575.10	-	1	12
	US4	545.75	-		
	US10B	575.10	049909		
	US15A	575.10	-		
	US26	575.10	-		
	US26D	575.10	073269		
CTC: 30"	US3	597.90	-	1	12
	US4	570.95	-		
	US10B	597.90	049907		
	US15A	597.90	-		
	US26	597.90	-		
	US26D	597.90	-		
967P					
Curved Pull					
	US3	1,076.75	024430	1	12
O/A Height: 20-1/2"	US4	1,076.75	009305		
Clearance: 3-9/16"	US10B	1,245.90	016556		
Projection: 5-9/16"	US15A	1,245.90	006769		
Specify handing	US26	1,245.90	011769		
Fasteners: 3/8 - 16 FPHMS with finish washers	US26D	1,245.90	008614		



1. Items with the price in **bold and red** are Quick Ship items and ship in 24 hours.
Please use stock number when ordering. 2. U/M is each unless otherwise noted.



Trim & Auxiliary



Description	Finish	2018 List	Case Qty.	Over 36"
970P				
970P	US3	493.25	12	8.00
Push/Pull Set	US4	493.25		8.00
Base Diameter: 1"	US10	493.25		8.00
Pull Projection: 3"	US10B	493.25		8.00
Pull Clearance: 2"	US15A	493.25		8.00
CTC Length: 16-3/4"	US26	493.25		8.00
Push clearance: 1-3/4"	US26D	493.25		8.00
Push projection: 2-3/4"	US32D	476.00		13.40
Fasteners: Type 3 Mounting				
Handing Required				
Additional Bars by Quotation				
*Add per linear inch or fraction thereof				



Description	Finish	2018 List	Stock No.	Box Qty.	Case Qty.
974P					
Door Pull					
Pull Diameter: 1" (25 mm)					
Base Diameter: 2" (51 mm)					
Projection: 2-1/2"					
Fasteners: 3/8 - 16 FPHMS with finish washers					
CTC: 12"	US3	489.70	096812	1	12
	US4	489.70	-		
	US10B	489.70	077525		
	US26	489.70	-		
	US26D	489.70	067183		
	US32D	489.70	090347		
CTC: 18"	US3	509.65	-	1	12
	US4	509.65	-		
	US10B	509.65	-		
	US26	509.65	-		
	US26D	509.65	077942		
	US32D	509.65	008568		
CTC: 24"	US3	532.40	-	1	12
	US4	532.40	-		
	US10B	532.40	-		
	US26	532.40	-		
	US26D	532.40	118329		
	US32D	532.40	065323		
CTC: 30"	US3	555.15	-	1	12
	US4	555.15	-		
	US10B	555.15	-		
	US26	555.15	-		
	US26D	555.15	-		
	US32D	555.15	-		
CTC: 36"	US3	555.15	-	1	12
	US4	555.15	-		
	US10B	555.15	-		
	US26	555.15	-		
	US26D	555.15	117957		
	US32D	555.15	138337		



Description	Finish	2018 List	Stock No.	Box Qty.	Case Qty.
974B					
Door Pull					
BTB Mounting					
Pull Diameter: 1" (25 mm)					
Base Diameter: 2" (51 mm)					
Projection: 2-1/2"					
Fasteners: 3/8 - 16 FPHMS with finish washers					
CTC: 12"	US3	999.15	-	1	12
	US4	999.15	-		
	US10B	999.15	094407		
	US26	999.15	-		
	US26D	999.15	-		
	US32D	999.15	094083		
CTC: 18"	US3	1,039.05	-	1	12
	US4	1,039.05	-		
	US10B	1,039.05	-		
	US26	1,039.05	-		
	US26D	1,039.05	091914		
	US32D	1,039.05	080540		
CTC: 24"	US3	1,084.60	-	1	12
	US4	1,084.60	-		
	US10B	1,084.60	031371		
	US26	1,084.60	111278		
	US26D	1,084.60	094396		
	US32D	1,084.60	080541		
CTC: 30"	US3	1,130.05	-	1	12
	US4	1,130.05	-		
	US10B	1,130.05	-		
	US26	1,130.05	-		
	US26D	1,130.05	107473		
	US32D	1,130.05	124943		
CTC: 36"	US3	1,130.05	-	1	12
	US4	1,130.05	-		
	US10B	1,130.05	-		
	US26	1,130.05	-		
	US26D	1,130.05	-		
	US32D	1,130.05	091943		

1. Items with the price in **bold and red** are Quick Ship items and ship in 24 hours.
 Please use stock number when ordering. 2. U/M is each unless otherwise noted.



Trim & Auxiliary

Description	Finish	2018 List	Stock No.	Box Qty.	Case Qty.
975P					
Vertical Pull					
Pull Diameter: 1"					
Projection: 2-3/4"					
Fasteners: 3/8 - 16 FPHMS with finish washers					
Length: 36"	US3	268.60	119311	1	12
CTC: 20"	US4	268.60	-		
	US10	268.60	068796		
	US10B	268.60	042466		
	US15A	268.60	012591		
	US26	268.60	050339		
	US26D	268.60	012278		
	US32D	268.60	010891		
Length: 72"	US3	386.15	119290	1	12
CTC: 56"	US4	386.15	074642		
	US10	386.15	070431		
	US10B	386.15	022804		
	US15A	386.15	012601		
	US26	386.15	030738		
	US26D	386.15	029768		
	US32D	386.15	028382		
975B					
Vertical Pull					
BTB Mounting					
Pull Diameter: 1"					
Projection: 2-3/4"					
Length: 36"	US3	557.00	-	1	12
CTC: 20"	US4	557.00	-		
	US10	557.00	-		
	US10B	557.00	025610		
	US15A	557.00	-		
	US26	557.00	030737		
	US26D	557.00	021401		
	US32D	557.00	028442		
Length: 72"	US3	792.00	-	1	12
CTC: 56"	US4	792.00	-		
	US10	792.00	070432		
	US10B	792.00	021488		
	US15A	792.00	-		
	US26	792.00	030738		
	US26D	792.00	021402		
	US32D	792.00	021547		
976P					
Door Pull Offset	US32D	593.75	088820	1	12
Overall: 29-1/2"; CTC: 19-13/16"					
Base Diameter: 1-1/4"					
Pull Diameter: 1-1/4"					
Projection: 5-3/8"					
Clearance: 4-1/8"					
Offset: 1-3/4"					
Fasteners: 3/8 - 16 FPHMS with finish washers					



Description	Finish	2018 List	Stock No.	Box Qty.	Case Qty.
976B					
Door Pull Offset	US32D	1,207.25	062051	1	12
Overall: 29-1/2"; CTC: 19-13/16"					
BTB Mounting					
Base Diameter: 1-1/4"					
Pull Diameter: 1-1/4"					
Projection: 5-3/8"					
Clearance: 4-1/8"					
Offset: 1-3/4"					
980P					
Segment Shape - Straight					
Fasteners: 3/8 - 16 FPHMS with finish washers					
CTC: 9"	US3	179.40	-	1	12
	US4	179.40	-		
	US10B	179.40	012840		
	US15A	179.40	076601		
	US26	179.40	-		
	US26D	179.40	-		
	US32D	179.40	027302		
CTC: 12"	US3	179.40	-	1	12
	US4	179.40	095352		
	US10B	179.40	083262		
	US15A	179.40	-		
	US26	179.40	014517		
	US26D	179.40	049530		
	US32D	179.40	031717		
CTC: 18"	US3	198.85	-	1	12
	US4	198.85	-		
	US10B	198.85	012799		
	US15A	198.85	014455		
	US26	198.85	064564		
	US26D	198.85	057861		
	US32D	198.85	016625		
CTC: 24"	US3	198.85	041663	1	12
	US4	198.85	085204		
	US10B	198.85	065896		
	US15A	198.85	-		
	US26	198.85	011979		
	US26D	198.85	036275		
	US32D	198.85	024698		

1. Items with the price in **bold and red** are Quick Ship items and ship in 24 hours.
 Please use stock number when ordering. 2. U/M is each unless otherwise noted.



Trim & Auxiliary



Description	Finish	2018 List	Stock No.	Box Qty.	Case Qty.
980B					
Segment Shape - Straight					
BTB Mounting					
CTC: 9"					
	US3	378.55	-	1	12
	US4	378.55	-		
	US10B	378.55	116185		
	US15A	378.55	114829		
	US26	378.55	-		
	US26D	378.55	-		
	US32D	378.55	083497		
CTC: 12"					
	US3	378.55	-	1	12
	US4	378.55	-		
	US10B	378.55	101513		
	US15A	378.55	-		
	US26	378.55	-		
	US26D	378.55	039876		
	US32D	378.55	032307		
CTC: 18"					
	US3	417.45	-	1	12
	US4	417.45	-		
	US10B	417.45	077056		
	US15A	417.45	077533		
	US26	417.45	088558		
	US26D	417.45	044015		
	US32D	417.45	022336		
CTC: 24"					
	US3	417.45	-	1	12
	US4	417.45	-		
	US10B	417.45	017774		
	US15A	417.45	-		
	US26	417.45	-		
	US26D	417.45	027476		
	US32D	417.45	032023		

Description	Finish	2018 List	Stock No.	Box Qty.	Case Qty.
981P					
Segment Shape - Offset Pull					
Projection: 2-3/8"					
Fasteners: 3/8 - 16 FPHMS with finish washers					
CTC: 9"	US3	204.00	-	1	12
	US4	204.00	-		
	US10B	204.00	047545		
	US15A	204.00	087991		
	US26	204.00	-		
	US26D	204.00	047907		
	US32D	204.00	046757		
CTC: 12"	US3	211.90	026794	1	12
	US4	211.90	111689		
	US10B	211.90	027812		
	US15A	211.90	026777		
	US26	211.90	011836		
	US26D	211.90	035056		
	US32D	211.90	004578		
CTC: 18"	US3	238.85	053460	1	12
	US4	238.85	-		
	US10B	238.85	075906		
	US15A	238.85	019090		
	US26	238.85	042120		
	US26D	238.85	010525		
	US32D	238.85	015319		
CTC: 24"	US3	295.10	011702	1	12
	US4	295.10	006783		
	US10B	295.10	039910		
	US15A	295.10	020401		
	US26	295.10	092955		
	US26D	295.10	010526		
	US32D	295.10	033975		

1. Items with the price in **bold and red** are Quick Ship items and ship in 24 hours.
Please use stock number when ordering. 2. U/M is each unless otherwise noted.



Trim & Auxiliary



Description	Finish	2018 List	Stock No.	Box Qty.	Case Qty.
981B					
Segment Shape - Offset Pull					
BTB Mounting					
Projection: 2-3/8"					
CTC: 9"	US3	427.75	-	1	12
	US4	427.75	-		
	US10B	427.75	089663		
	US15A	427.75	-		
	US26	427.75	-		
	US26D	427.75	-		
	US32D	427.75	076275		
CTC: 12"	US3	443.50	027231	1	12
	US4	443.50	-		
	US10B	443.50	078949		
	US15A	443.50	-		
	US26	443.50	-		
	US26D	443.50	023547		
	US32D	443.50	037048		
CTC: 18"	US3	497.50	-	1	12
	US4	497.50	050164		
	US10B	497.50	001599		
	US15A	497.50	-		
	US26	497.50	022355		
	US26D	497.50	022637		
	US32D	497.50	028505		
CTC: 24"	US3	609.90	-	1	12
	US4	609.90	-		
	US10B	609.90	085243		
	US15A	609.90	-		
	US26	609.90	049864		
	US26D	609.90	027598		
	US32D	609.90	031349		
982P					
Straight Pull	US3	442.30	087996	1	12
Base Diameter: 1-5/16"	US4	442.30	-		
Projection: 3-1/8"	US10B	476.15	084256		
Clearance: 1-13/16"	US15A	476.15	-		
CTC: 20"	US26	476.15	-		
Fasteners: 3/8 - 16 FPHMS with finish washers	US26D	476.15	058080		
	US32D	544.55	080284		
982B					
Straight Pull	US3	904.35	-	1	12
BTB Mounting	US4	904.35	-		
Base Diameter: 1-5/16"	US10B	972.15	-		
Projection: 3-1/8"	US15A	972.15	-		
Clearance: 1-13/16"	US26	972.15	-		
CTC: 20"	US26D	972.15	009491		
	US32D	1,108.85	091255		





Description	Finish	2018 List	Stock No.	Box Qty.	Case Qty.
983P					
Curved Pull					
Base Diameter: 14-1/4"					
Projection: 3-1/8"					
Clearance: 1-7/8"					
Fasteners: 3/8 - 16 FPHMS with finish washers					
Specify handing					
Left Hand	US3	442.30	-	1	12
	US4	442.30	072498		
	US10B	476.15	099179		
	US15A	476.15	-		
	US26	476.15	072454		
	US26D	476.15	-		
	US32D	544.55	-		
Right Hand	US3	442.30	-	1	12
	US4	442.30	072483		
	US10B	476.15	099018		
	US15A	476.15	-		
	US26	476.15	072461		
	US26D	476.15	105909		
	US32D	544.55	-		



983B					
Curved Pull					
BTB Mounting					
Base Diameter: 14-1/4"					
Projection: 3-1/8"					
Clearance: 1-7/8"					
Specify handing					
Left Hand	US3	904.35	099638	1	12
	US4	904.35	-		
	US10B	972.15	044345		
	US15A	972.15	-		
	US26	972.15	072463		
	US26D	972.15	065560		
	US32D	1,108.85	085556		
Right Hand	US3	904.35	098156	1	12
	US4	904.35	-		
	US10B	972.15	044347		
	US15A	972.15	-		
	US26	972.15	-		
	US26D	972.15	065559		
	US32D	1,108.85	085557		

1. Items with the price in **bold and red** are Quick Ship items and ship in 24 hours.
 Please use stock number when ordering. 2. U/M is each unless otherwise noted.



Trim & Auxiliary



Description	Finish	2018 List	Stock No.	Box Qty.	Case Qty.
984P					
Curved Pull					
Projection: 3"					
Fasteners: 3/8 - 16 FPHMS with finish washers					
CTC: 12"	US3	295.10	-	1	12
	US4	295.10	021651		
	US10B	295.10	067449		
	US15A	295.10	-		
	US26	295.10	-		
	US26D	295.10	013764		
	US32D	368.00	078894		
CTC: 20"	US3	440.45	077926	1	12
	US4	440.45	-		
	US10B	440.45	092541		
	US15A	440.45	-		
	US26	440.45	-		
	US26D	440.45	014652		
	US32D	569.10	082549		



984B					
Curved Pull					
BTB Mounting					
Projection: 3"					
CTC: 12"	US3	609.90	-	1	12
	US4	609.90	-		
	US10B	609.90	033349		
	US15A	609.90	-		
	US26	609.90	-		
	US26D	609.90	-		
	US32D	755.75	057306		
CTC: 20"	US3	900.70	-	1	12
	US4	900.70	039804		
	US10B	900.70	033348		
	US15A	900.70	-		
	US26	900.70	-		
	US26D	900.70	032543		
	US32D	1,158.00	114348		



985P					
Curved Pull	US3	249.50	006990	1	12
O/A Height: 14"	US4	249.50	020375		
Base Diameter: 2"	US10B	284.40	009303		
Projection: 3"	US15A	284.40	014456		
Clearance: 1-9/16"	US26	284.40	055276		
Offset: 1-5/8"	US26D	249.50	007482		
CTC: 12"	US32D	363.35	010406		
Fasteners: 3/8 - 16 FPHMS with finish washers					



Description	Finish	2018 List	Stock No.	Box Qty.	Case Qty.
985B					
Curved Pull	US3	518.75	025851	1	12
BTB Mounting	US4	518.75	029159		
O/A Height: 14"	US10B	588.55	024891		
Base Diameter: 2"	US15A	588.55	027680		
Projection: 3"	US26	588.55	-		
Offset: 1-5/8"	US26D	518.75	025866		
Clearance: 1-9/16"	US32D	746.45	023384		
CTC: 12"					
986P					
Curved Pull	US3	623.45	081279	1	12
O/A Height: 22"	US4	623.45	033174		
Pull Diameter: 1-1/4"	US10B	623.45	014868		
Base Diameter: 2"	US15A	623.45	021822		
Projection: 3-7/8"	US26	623.45	016593		
Offset: 3"	US26D	623.45	010418		
Clearance: 2-5/8"	US32D	566.75	011392		
CTC: 20"					
Fasteners: 3/8 - 16 FPHMS with finish washers					
986B					
Curved Pull	US3	1,266.65	-	1	12
BTB Mounting	US4	1,266.65	032338		
O/A Height: 22"	US10B	1,266.65	013369		
Pull Diameter: 1-1/4"	US15A	1,266.65	042684		
Base Diameter: 2"	US26	1,266.65	-		
Projection: 3-7/8"	US26D	1,266.65	022069		
Offset: 3"	US32D	1,153.25	040173		
Clearance: 2-5/8"					
CTC: 20"					
987P					
Double Curved Pull	US3	544.55	-	1	12
Base Diameter: 1-1/4"	US4	544.55	-		
Projection: 3"	US10B	544.55	038422		
Clearance: 2"	US15A	544.55	014457		
CTC: 20"	US26	544.55	080621		
Fasteners: 3/8 - 16 FPHMS with finish washers	US26D	544.55	017011		
	US32D	532.40	018215		
987B					
Double Curved Pull	US3	1,108.85	-	1	12
BTB Mounting	US4	1,108.85	-		
Base Diameter: 1-1/4"	US10B	1,108.85	062018		
Projection: 3"	US15A	1,108.85	080604		
Clearance: 2"	US26	1,108.85	083130		
CTC: 20"	US26D	1,108.85	025865		
	US32D	1,084.60	022332		
988P					
Offset Pull	US3	295.10	-	1	12
Projection: 3"	US26	295.10	-		
CTC: 24"	US32D	295.10	032028		
Fasteners: 3/8 - 16 FPHMS with finish washers					

1. Items with the price in **bold and red** are Quick Ship items and ship in 24 hours.
Please use stock number when ordering. 2. U/M is each unless otherwise noted.



Trim & Auxiliary



Description	Finish	2018 List	Stock No.	Box Qty.	Case Qty.
988B					
Offset Pull	US3	609.90	-	1	12
BTB Mounting	US26	609.90	-		
Projection: 3"	US32D	609.90	032030		
CTC: 24"					
990P					
18° Pull Bar - Handed					
Pull Diameter: 1"					
O/A Height: 25"					
Projection: 2-3/4"					
Clearance: 1-3/4"					
CTC: 24"					
Specify handing					
Fasteners: 3/8 - 16 FPHMS with finish washers					
Left Hand	US3	680.10	-	1	12
	US4	680.10	-		
	US10B	680.10	-		
	US15A	680.10	-		
	US26	680.10	-		
	US26D	680.10	097531		
	US32D	611.35	078681		
Right Hand	US3	680.10	-	1	12
	US4	680.10	-		
	US10B	680.10	098837		
	US15A	680.10	-		
	US26	680.10	-		
	US26D	680.10	097700		
	US32D	611.35	078682		



Description	Finish	2018 List	Stock No.	Box Qty.	Case Qty.
990B					
18° Pull Bar - Handed					
BTB Mounting					
Pull Diameter: 1"					
O/A Height: 25"					
Projection: 2-3/4"					
Clearance: 1-3/4"					
CTC: 24"					
Specify handing					
Left Hand	US3	1,379.95	-	1	12
	US4	1,379.95	-		
	US10B	1,379.95	055038		
	US15A	1,379.95	-		
	US26	1,379.95	-		
	US26D	1,379.95	105210		
	US32D	1,242.55	124116		
Right Hand	US3	1,379.95	-	1	12
	US4	1,379.95	-		
	US10B	1,379.95	054966		
	US15A	1,379.95	-		
	US26	1,379.95	-		
	US26D	1,379.95	105211		
	US32D	1,242.55	124120		
1442					
Roller Latch with Full Lip Strike	US3	32.35	070478	1	12
Material: Forged brass	US4	45.70	011444		
Latch Face: 1" x 3-3/8"	US10	45.70	011442		
Strike: 1-11/16" x 2-1/4" x 5/32" thick	US10B	34.45	070462		
Max Roller Projection: 3/8"	US15	38.35	060770		
Fasteners: #8 x 1" FPHWS; 8 - 32 x 3/4" FPHMS; #10 x 1-1/2" FPHWS	US15A	61.65	054026		
Non-Ferrous Version available on US3, US10B, US15, and US26D with extended lead time - 13.85 adder	US19	61.65	054513		
(NF) comp	US26	33.95	064292		
	US26D	27.45	011443		
1443					
Roller Latch w/ ASA Strike	US3	35.50	061158	1	12
Material: Forged brass	US4	47.75	-		
Latch Face: 1" x 3-3/8"	US10	48.60	011445		
Strike: 1-1/4" x 4-7/8" w/ 5/8" Lip	US10B	40.45	061159		
Strike Thickness: .093"	US15	53.60	060765		
Max Roller Projection: 3/8"	US15A	61.65	054032		
Fasteners: 12 - 24 x 1/2" FPHMS; #12 x 3/4" FPHWS; #10 x 1-1/2" FPHWS	US19	61.65	054515		
	US26	45.70	088079		
	US26D	30.20	011446		
2610					
Finger Pull	US3		013049	-	500
Material: Brass	US4		071953		
Overall Diameter: 31/32"	US5		067282		
Finger Pull Diameter: 3/4"	US10A		068711		
Pull Clearance: 5/16"	US15		040589		
Projection: 1/32"	US15A		040590		
	US26		013047		
	US26D		071169		



1. Items with the price in **bold and red** are Quick Ship items and ship in 24 hours. Please use stock number when ordering. 2. U/M is each unless otherwise noted.



Trim & Auxiliary



Description	Finish	2018 List	Stock No.	Box Qty.	Case Qty.
2620					
Round Flush Pull	US3		013081	-	50
Material: Brass	US4	See Sliding	072997		
Overall Diameter: 2-1/16"	US5	Door	072148		
Finger Pull Diameter: 1-11/16"	US10A	Hardware	072534		
Pull Clearance: 11/32"	US15	Section for	072624		
Projection: 5/64"	US15A	Pricing	072158		
	US26		072554		
	US26D		075322		



2630					
Round Flush Pull	US3		051919	-	50
Material: Brass	US4	See Sliding	073783		
Overall Diameter: 2-7/16"	US5	Door	053163		
Finger Pull Diameter: 2-1/16"	US10A	Hardware	073053		
Pull Clearance: 11/32"	US15	Section for	073056		
Projection: 3/32"	US15A	Pricing	054307		
	US26		023430		
	US26D		023431		



2640					
Oblong Flush Pull	US3		096760	-	50
Material: Brass	US4	See Sliding	075056		
Size: 1-5/16" x 2-3/4"	US5	Door	074270		
Cup Clearance: 5/16"	US10A	Hardware	074533		
Fasteners: #6 x 5/8" OPHWS	US15	Section for	074711		
	US15A	Pricing	074350		
	US26		026751		
	US26D		074664		



9558					
Wood Knob	Wood	See Sliding Door	096567	-	100
Knob Diameter: 1-1/2"		Hardware Section			
Base Diameter: 15/16"		for Pricing			
Fasteners: #8 x 1-3/4" PPHWS					



9566					
Knob	US3		099824	-	100
Material: Zinc	US4	See Sliding	098635		
Knob Diameter: 1-1/4"	US5	Door	028859		
Projection: 1"	US10A	Hardware	098634		
Fasteners: #8 - 32 x 2" PPHMS;	US10B	Section for	098633		
#8 - 32 x 1-3/4" PPHMS	US15	Pricing	098632		
	US15A		098629		
	US26		098628		
	US26D		098627		



9567					
Rose - For use with 9566 knob	US3		099825	-	100
Material: Zinc	US4	See Sliding	098626		
Base Diameter: 1-3/4"	US5	Door	018102		
Projection: 15/32"	US10A	Hardware	098625		
Fasteners: #8 - 32 x 2" PPHMS;	US10B	Section for	098624		
#8 - 32 x 1-3/4" PPHMS	US15	Pricing	098623		
	US15A		098622		
	US26		098621		
	US26D		098620		





Description	Finish	2018 List	Stock No.	Box Qty.	Case Qty.
9865 Plastic Pull Overall Diameter: 1-31/32" Finger Pull Diameter: 1-19/32" Pull Clearance: 11/32" Projection: 5/64"	Plastic	1.00	098993	-	100



9882 Pocket Door Edge Pull Material: Brass Finger Pull Extends: 3/4" Faceplate: 3/4" x 3-7/8" Fasteners: #6 x 5/8" FPHWS Note: See Sliding Door section for pricing and multiplier.	US3	14.60	049582	-	100
	US4	17.65	049583		
	US10	14.60	049578		
	US10B	17.65	049580		
	US26	17.65	049579		
	US26D	17.65	049581		



9884 Pocket Door Edge Pull Material: Zinc Finger Pull Extends: 1-1/16" Faceplate: 21/32" x 3-1/2" Fasteners: #6 x 5/8" FPHWS Note: See Sliding Door section for pricing and multiplier.	US3	See Sliding Door Hardware Section for Pricing	099056	-	20
--	-----	--	--------	---	----



Description	Finish	2018 List	Stock No.	Box Qty.	Case Qty.	Disc Code
199B Door Protection Plate U/M - 1 each Material: Aluminum (.038") Fasteners: #6 x 5/8" TPH Tapping Screws						
6" x 30"	BGA	19.89	099256	1	-	390
6" x 34"	BGA	22.54	097105			390
8" x 30"	BGA	22.32	099257			391
8" x 34"	BGA	25.30	097106			391



208 Kick Down Door Holder Material: Aluminum alloy Base: 1-5/8" x 1-7/8" Arm: 3-7/8" Fasteners: #6 x 3/4" FPHWS	US15A/AN	6.80	039115	5	50	780
	US26	6.80	001104			
	US26D	6.80	075679			



209 Floor Door Stop Material: Zinc Height: 1-1/4" Base Diameter: 1-3/32" Tip Diameter: 19/32" Fasteners: #8 x 2" FPHWS U/M - 1 each	US26	1.15	76165	5	50	780
	US3	1.15	76168			

1. Items with the price in **bold and red** are Quick Ship items and ship in 24 hours.
Please use stock number when ordering. 2. U/M is each unless otherwise noted.



Trim & Auxiliary



Description	Finish	2018 List	Stock No.	Box Qty.	Case Qty.	Disc Code
210						
Door Stop - Rigid	US3	1.90	076443	5	50	780
Material: Zinc	US4	1.65	078852			
Projection: 3"	US5/ABA	1.75	078854			
Base Diameter: 1"	US10A	1.75	075736			
Tip Diameter: 11/16"	US10R	1.75	097367			
Fasteners: #8 x 5/8" wood thread	US15A/AN	1.75	039117			
U/M - 1 each	US15	1.75	039118			
	US26	1.70	076171			
	US26D	1.90	076170			



211						
Door Stop - Flexible	US3	1.50	076206	10	100	780
Material: Zinc	US4	1.25	001109			
Projection: 3-1/8"	US5/ABA	1.65	053162			
Base Diameter: 1"	US10A	1.65	076199			
Tip Diameter: 9/16"	US10R	1.65	097368			
Fasteners: #8 x 3/4" PPHWS	US15A/AN	1.65	039126			
U/M - 1 each	US15	1.65	039121			
	US26	1.35	076205			
	US26D	1.50	076203			



212						
Hinge Pin Door Bumper	US3	2.00	056477	10	100	780
Material: Zinc	US4	1.90	023084			
U/M - 1 each	US5/ABA	2.00	023083			
Adjustable from 180° to 120°	US10A	1.65	076219			
For use with residential hinges	US10R	1.65	097369			
Works with 1/4" hinge pins	US15A/AN	2.00	034530			
	US15	1.95	034492			
	US26	1.50	076221			
	US26D	1.50	076220			



1412						
Door Guard	US3	8.55	056475	5	50	780
Arm Length: 4"	US5/ABA	6.60	011433			
Material: Zinc	US10A	6.60	076222			
Fasteners: #6 x 3/4" FPHWS	US15A/AN	6.60	035285			
U/M - 1 each with screws	US15	6.60	035279			
	US26	6.60	011431			
	US26D	8.55	076223			



1413						
Flush Bolt - Square Corners	US3	8.65	051915	10	100	780
Material: Brass w/ steel components	US4	8.65	055562			
Bolt Diameter: 1/2"	US5/ABA	10.60	051916			
Bolt Throw: 15/16"	US10A	10.60	055563			
Faceplate: 3/4" x 6"	US10R	10.60	072931			
Backset: 7/16"	US15A/AN	10.60	035457			
Strike: 7/8" x 1-3/4"	US15	8.65	035457			
Fasteners: #6 x 3/4" FPHWS	US26	8.65	055568			
U/M - 1 each with screws	US26D	8.65	055561			







Description	Finish	2018 List	Stock No.	Box Qty.	Case Qty.	Disc Code
1414						
Flush Bolt	US3	8.65	0519177	10	100	780
Material: Brass w/ steel components	US5/ABA	10.60	051918			
Bolt Diameter: 1/2"	US10A	10.60	055586			
Bolt Throw: 15/16"	US10R	10.60	097374			
Faceplate: 3/4" x 6"	US15A/AN	10.60	040832			
Backset: 7/16"	US15	8.65	040830			
Strike: 7/8" x 1-3/4"	US26	8.65	055570			
Fasteners: #6 x 3/4" FPHWS	US26D	8.65	055589			
Strikeplate and screws, U/M - 1 each						
1415						
Strike Plate	US3	2.00	081300	100	500	780
Material: Brass	US10A	2.00	081308			
Size: 7/8" x 1-3/4"	US15A/AN	2.00	081311			
Fasteners: #6 x 3/4" FPHWS	US15	2.00	081305			
U/M - 1 each with screws	US26D	2.00	081307			
1416						
Flush Bolt - Single Route	US3	10.25	078952	10	100	780
Material: Brass w/ steel components	US4	10.25	076239			
Bolt Diameter: 5/16"	US5/ABA	12.15	076225			
Backset: 3/8"	US10A	12.15	076236			
Faceplate: 3/4" x 7-1/8"	US10R	12.15	097375			
Strike: 21/32" x 1-1/2"	US15A/AN	12.15	035990			
Bolt Throw: 7/8"	US15	12.15	036004			
Fasteners: #8 x 1-1/2" FPHWS; #6 x 3/4" FPHWS	US26	10.25	076238			
U/M - 1 each with strikeplate and screws	US26D	10.25	076237			
1417						
Flush Bolt	US3	8.65	089156	10	100	780
Material: Brass w/ steel components	US10R	10.60	183077			
Bolt Diameter: 1/2", Bolt Throw: 1",	US15	8.65	183076			
Faceplate: 3/4" x 6", Backset: 7/16",	US26	8.65	089157			
Strike: 7/8" x 1-3/4", Fasteners: #6 x 3/4" FPHWS,						
Strikeplate and screws, U/M - 1 each						
1418						
Flush Bolt with Extension Rod	US3	12.05	068407	10	100	780
Material: Brass w/ steel components	US4	12.05	068337			
Bolt Diameter: 5/16"	US5/ABA	12.05	068263			
Backset: 3/8"	US10A	13.85	068467			
Faceplate: 23/32" x 7-3/8"	US10R	13.25	072930			
Strike: 5/8" x 1-1/2"	US15A/AN	13.85	068249			
Bolt Throw: 3/4"	US15	12.05	068448			
Extended Rod Length: 16"	US26	12.05	068447			
Fasteners: #8 x 1-1/2" FPHWS; #6 x 3/4" FPHWS	US26D	12.05	068436			
U/M - 1 each wit						
1419						
Flip/Foot Bolt Flush Bolt	US3	9.60	019228	10	100	485
Material: Brass with steel components	US4	9.60	019227			
Faceplate: 3/4" x 7-1/8"	US5/ABA	12.05	019224			
Strike: 5/8" x 1-1/2"	US10A	12.05	019627			
Bolt Diameter: 5/16"	US10R	12.05	019212			
Bolt Throw: 3/4"	US15A/AN	9.60	019216			
Backset: 5/16"	US15	9.60	019231			
Fasteners: #8 x 1-1/2" FPHWS; #6 x 3/4" FPHWS	US26	9.60	019230			
U/M - 1 each	US26D	9.60	019229			

1. Items with the price in **bold and red** are Quick Ship items and ship in 24 hours.
Please use stock number when ordering. 2. U/M is each unless otherwise noted.



Trim & Auxiliary

	Description	Finish	2018 List	Stock No.	Box Qty.	Case Qty.	Disc Code
	1439 Magnetic Catch Material: Plastic Catch: 1-1/16" x 2" Strike: 7/8" x 1" Fasteners: #6 x 1/2" TPHWS; #4 x 1/2" FPHWS U/M - 1 each with screws	-	2.00	011439	25	100	780
	1446 Ball Catch Material: Zinc Faceplate: 1" x 2-1/4" Strike: 1-3/8" x 2-1/4" Fasteners: #6 FPHWS U/M - 1 each with two strikeplates and screws	US3 US4 US5/ABA US10A US10R US15A/AN US15 US26 US26D	3.85 3.85 4.35 4.35 4.35 4.35 4.35 4.35 3.85 3.85	051902 055624 051903 055634 097376 036870 036878 055635 055608	10	50	780
	1447 Drive in Ball Catch Material: Zinc Faceplate: 1" diameter Strike: 1-3/8" x 2-1/4" Fasteners: #6 FPHWS U/M - 1 each with 2 strikeplates and screws	US3 US4 US5/ABA US10A US10R US15A/AN US15 US26 US26D	3.50 3.85 4.35 4.35 4.35 4.35 4.35 3.50 3.85	043896 055638 055636 055639 097377 037445 036882 055640 055637	10	50	780
	1448 Strike Plate for 1446 or 1447 Size: 1-3/8" x 2-1/4" Fasteners: #6 FPHWS U/M - 1 each with screws	US3 US4 US5/ABA US10A US10R US15A/AN US15 US26 US26D	2.00 2.00 2.00 2.00 2.00 2.00 2.00 2.00 2.00	079333 079334 079351 079339 097378 079340 079335 079337 079338	100	500	780
	1449 Drive In Ball Catch for 1448 Material: Zinc Faceplate: 1" diameter U/M - 1 each	US4	1.75	101876	100	300	780



Description	Finish	2018 List	Stock No.	Box Qty.	Case Qty.	Disc Code
1755						
115° One Way Door Viewer	US3	6.10	056866	10	100	490
UL Listed	US4	6.10	011919			490
U/M - 1 each	US5/ABA	6.00	076270			780
90 min. fire rated	US10A	6.00	076272			780
Door Thickness: 1-3/8" - 2-1/8"	US10R	6.00	097475			780
	US15A/AN	6.00	076271			780
	US15	6.00	076276			780
	US26	5.85	076274			780
	US26D	5.90	055225			490



1756						
185° One Way Door Viewer	US3	9.20	011920	-	50	490
UL Listed	US4	9.20	066884			490
U/M - 1 each	US5/ABA	13.75	072679			780
90 Minute Fire-Rated	US10A	13.75	076442			780
Door Thickness: 1-3/8" - 2-1/8"	US10R	13.75	097476			780
	US15A/AN	13.75	076441			780
	US15	13.75	067422			780
	US26	13.60	044337			780
	US26D	9.55	086149			490



1758						
115° One Way Door Viewer with Privacy Flap	US3	9.70	146215	10	100	490
Door Thickness: 1-3/8" - 2-1/8"	US10A	9.45	146216			780
UL Listed	US26	9.45	146217			780
U/M - 1 each	US26D	9.40	146218			490
90 Minute Fire-Rated						



1759						
185° One Way Door Viewer with Privacy Flap	US3	12.60	146219	-	50	490
Door Thickness: 1-3/8" - 2-1/8"	US10A	17.95	146220			780
UL Listed	US26	17.95	146221			780
U/M - 1 each	US26D	12.25	146222			490
90 Minute Fire-Rated						



1765						
Privacy Flap for 115° One Way Viewer 1755	US3	4.70	146207	1	200	490
	US10A	4.20	146208			780
	US26	4.20	146209			780
	US26D	4.70	146210			490



1766						
Privacy Flap for 185° One Way Viewer 1756	US3	5.40	146211	1	200	490
	US10A	5.00	146212			780
	US26	5.00	146213			780
	US26D	5.25	146214			490

1. Items with the price in **bold and red** are Quick Ship items and ship in 24 hours.
Please use stock number when ordering. 2. U/M is each unless otherwise noted.



Trim & Auxiliary



Description	Finish	2018 List	Stock No.	Box Qty.	Case Qty.	Disc Code
1795 Adjustable Closet Rod 1" Pole Diameter U/M - 1 each with screws 0.36 gauge steel with bright zinc finish						
18-30" (457-762 mm)		4.40	011928	-	10	780
30-48" (762-1219 mm)		5.90	011929			
48-72" (1219-1829 mm)		8.30	011930			
72-96" (1829-2438 mm)		10.70	011931			
96-150" (2438-3810 mm)		15.30	011932			



1797 Shelf and Rod Support U/M - 1 each with screws	BY	4.70	000326	-	20	780
--	----	------	--------	---	----	-----



1798 Shelf and Rod Support U/M - 1 each with screws	BY	5.00	000327	-	20	780
--	----	------	--------	---	----	-----



1799 Adjustable Shelf and Rod Support U/M - 1 each with screws	BY	4.35	000328	-	20	780
---	----	------	--------	---	----	-----



1801 Shelf Bracket U/M - 1 each with screws	BY	4.40	054634	-	20	780
--	----	------	--------	---	----	-----



BL6209 Floor Door Stop Height: 1-3/8" Base Diameter: 13/16" Tip Diameter: 1/2" Fastener: #8 x 11/32" thread U/M - 1 each	US26D/ABA	1.05	056231	-	150	780
---	-----------	------	--------	---	-----	-----



Description	Finish	2018 List	Stock No.	Box Qty.	Case Qty.	Disc Code
BL6211						
Door Stop Flexible	US3	0.90	056256	-	150	780
Projection: 3"	US4	0.80	058289			
Tip Diameter: 7/16"	US5/ABA	0.85	058295			
Base Diameter: 3/4"	US10A	0.85	056269			
Fastener: #8 x 1 1/32" thread	US10R	0.85	097482			
U/M - 1 each	US15	0.85	040032			
	US26D	0.85	040031			







BL6212						
Hinge Pin Door Bumper	US3	1.10	056320	-	100	780
U/M - 1 each	US4	1.05	058298			
Adjustable from 180° to 120°	US5/ABA	1.05	058296			
For use with residential hinges	US10A	1.05	056321			
Works with 1/4" hinge pins	US10R	1.05	097483			
	US15A/AN	1.05	056315			
	US15	1.05	040033			
	US26	1.10	056323			
	US26D	1.05	040035			

1. Items with the price in **bold and red** are Quick Ship items and ship in 24 hours.
Please use stock number when ordering. 2. U/M is each unless otherwise noted.



Series

	Description	Finish	2018 List	Stock No.	Box Qty.	Case Qty.	Disc Code
	6601						
	Handrail Bracket	US3	2.15	011385	-	300	780
	Material: Cast Aluminum	US4	2.15	011380			
	Base to Center of Rail: 2-3/4"	US5/ABA	2.75	011328			
	Projection: 3-1/4"	US10A	2.90	011374			
	Fasteners: #8 x 1-1/2" OPHWS; #8 x 3/4" OPHWS	US10R	2.90	011371			
	U/M - 1 each with screws	US15A/AN	2.75	011327			
		US15	2.75	011335			
		US26	2.15	011332			
		US26D	2.75	011331			
	BL6610						
	Coat & Hat Hook	US3	1.05	056300	-	100	780
	Max. Projection: 2-13/16"	US4	1.00	058317			
	Min. Projection: 1-5/16"	US5/ABA	1.05	058329			
	Fastener: #6 x 3/4" FPHWS	US10A	1.05	056299			
	U/M - 1 each with screws	US15	1.05	040045			
	US26	1.05	056298				
	US26D	1.05	040046				
	BL6793						
	Pole Sockets	2D	1.50	013512	-	100	780
	Material: Steel						
	U/M - 2 each with screws						
	BL6794						
	Pole Sockets		0.90	013514	-	100	780
	Material: Plastic						
	U/M - 2 each with screws						



One Family. One Brand. One Vision.™

www.hagerco.com

TABLE OF CONTENTS

A		I	
Astragal	21, 23-27	Interlocking Thresholds	12
B		Interlocking Weatherstripping.....	15
Barrier Free Ramps	9	Intumescent Weatherstripping.....	15-17
Bumper Thresholds	9-10	J	
Bumper/Stop Strips	10	Jamb Weatherstripping	
C		Jamb Weatherstripping.....	22-23, 25-27
Carpet Thresholds	10-11	Adjustable.....	25
Cast Abrasive Aluminum Thresholds		Magnetic.....	25
Saddle Thresholds	13-14	L	
Cover Plate	14-15	Lead Times	5
D		M	
Door Bottoms		Materials and Finishes.....	2
Automatic Door Bottoms.....	19	P	
Door Shoes	21-22	Panic Thresholds	11-12
Door Sweeps	20-21, 23, 26-27	Press-On Weatherstripping.....	15-18
Rain Drip	21-23	Product Information.....	2
E		R	
Edge Sealing Systems	15-18	Rain Drips	
Elevator.....	10	DoorBottom Rain Drip.....	21-22
F		Overhead Rain Drip.....	23
Fabrication Options	5	Replacement Inserts.....	4
Fasteners.....	2	Residential Thresholds	6-7
Fastener Options	3	S	
Finish Options.....	2,5	Smoke Seals	15-18
Fire Labeling.....	2	Saddle Thresholds.....	6-10, 13-14
Floor Closer Thresholds	13-14	Spring Bronze.....	23
Floor Plates and Supports	9-10	Stock Numbers	29-43
G		Sure-Step.....	5
Garage Weatherstripping	22	T	
H		Thermal Barrier Thresholds	
Half Saddle Thresholds.....	6, 8-9, 12	Saddle Thresholds	7-9
How to Order	3	Panic Thresholds.....	11-12
		W	
		Water Return - Interlocking	12



Thresholds & Weatherstripping

PRODUCT INFORMATION

Drawings or illustrations used in the Price Book are subject to change without notice. Questions regarding any dimensions should be directed to Hager Companies Customer Service.

MATERIALS AND FINISHES

Metals

All aluminum extrusions are of alloy 6063-T5. All bronze extrusions are of alloy CDA385 brass specified as Architectural Bronze in the industry. For stock finishes, refer to the code listed below each individual item throughout the price book. Please inquire for the availability on non-stock finishes.

MIL-	Mill Finish Aluminum	LBA -	Light Bronze Anodized Aluminum
300-	Polished Bronze (CDA385)	MIB-	Mill Finish Bronze (CDA385)
CAL-	Cast Aluminum	GYP-	Primed Steel (Grey)
DBA-	Dark Bronze Anodized Aluminum	BLA-	Black Anodized Aluminum
SCA-	Hager Carb-Coat on Aluminum	32D-	Matte Stainless Steel (Non-Extruded)
SCB-	Hager Carb-Coat on Bronze	WH-	White Paint on Aluminum
GLD-	Gold Anodized Aluminum	CLR-	Clear Anodized Aluminum
10B-	Antique Bronze, Oiled	BCA-	Bright Clear Anodized Aluminum

Gaskets

Gasketing is available in a wide variety of materials. Vinyl is an economical choice and remains flexible down to -40°F. Neoprene gasketing is supplied both as a solid (dense) and as a closed cell sponge with a tough outer skin, remaining flexible down to -50°F. Silicone gasketing provides the best resistance to cold by remaining flexible down to -70°F. To order gasket only, see how to order example on page 3.

B-	Nylon Brush (Black)	V-	Vinyl
N-	Neoprene, Solid EPDM	W-	Pile (Thread May Be Removed To Allow Expansion) (Grey)
	Closed Cell Sponge EPDM, TPE (Black)	F-	Vinyl with Fins (Grey)
S-	Silicone		

Colors for Press-On Gasketing

- B - Brown
- S - Charcoal or Black
- T - Tan
- W - White
- G - Grey

FASTENERS

All products are furnished with appropriate fasteners as listed, except where noted. Most thresholds are furnished with mounting holes and #10 x 1-1/2" flat head sheet metal screws. Most weatherstripping products are furnished with slotted holes and #6 x 5/8" pan head sheet metal screws. Brass screws are furnished with bronze products.

FIRE LABELING

All products containing non-metallic seals have been listed and labeled resulting from a determination by a certified fire laboratory that these products do not adversely affect the fire resistance of the door or frame. All products are regularly checked under a labeling and listing inspection service.



HOW TO ORDER

When placing your order, please specify item number, gasket code, size and finish code. Also be sure to state any special fabrication needs or optional fasteners desired. Thresholds are fabricated in standard sizes with 1/2" extra on thresholds 50" and under. Thresholds over 50" are supplied with 1" extra length for fitting.

Example: 891S V 36 x 84 MIL

Item #	Gasketing	Size	Finish
515S	S-Silicone	36"	GLD
575S	W-Pile	48"	MIB
750S	N-Neoprene	36" x 84"	32D
802S	B-Nylon Brush	48" x 96"	MIL
885S	V-Vinyl	36" x 84"	DBA
881S*	N-Neoprene	48" x 84"	000

*Use Finish 000 to receive gasket only

Thresholds must be purchased and billed at 4" increments, except for Abrasive Cast Aluminum Thresholds and Automatic Door Bottoms. Weatherstripping must be purchased and billed at 4" increments. Threshold and weatherstripping products supplied in lengths up to 12'.

FASTENER OPTIONS

Thresholds

Add to List Price

#10 Wood Screws and Plastic Anchors.....	\$ 0.60 /ft
#10 Wood Screws and Lead Anchors	0.80 /ft
#10 Machine Screws and Lead Anchors.....	0.90 /ft
#10 S.S. Machine Screws and Lead Anchors	1.50 /ft
#10 S.S. Wood Screws	1.00 /ft
#10 S.S. Wood Screws and Plastic Anchors	1.40 /ft
#10 S.S. Wood Screws and Lead Anchors.....	1.60 /ft
#10 Torx Wood Screws	1.90 /ft
#10 S.S. Torx Wood Screws	2.90 /ft
#10 Torx Machine Screws.....	1.80 /ft
#10 S.S. Torx Machine Screws.....	2.80 /ft
#10 S.S Torx Machine Screws and Lead Anchors	2.40 /ft
1/4-20 Machine Screws and Lead Anchors.....	1.30 /ft
1/4-20 S.S. Machine Screws and Lead Anchors.....	1.90 /ft
1/4-20 Flat Head Sleeve Anchor	2.40 /ft
1/4 Tap-Con Type (Self-Tapping Concrete).....	1.30 /ft
Cast-On Anchors (Cast Products Only)	8.00/ea
Thru-bolts 1/4 - 20 x 1-1/4" FPHM with 1-1/4" post	2.90 /ft

Note: Standard fasteners included: #10 x 1-1/2" Phillips flat-head sheet metal screws.

Weatherstripping

Add to List Price

#6 x 5/8" Phillips Pan-head Stainless Steel Screws.....	\$ 0.50 /ft
#6 x 5/8" Phillips Self-drilling (TEK) Screws	0.30 /ft
#6 x 5/8" S.S. Phillips Self-drilling (TEK) Screws	0.40 /ft
#6 x 5/8" Phillips Pan-head Torx Sheet Metal Screws.....	1.50 /ft
Two-way Self-adhesive Tape	1.40 /ft

Note: Standard fasteners included: #6 x 5/8" Phillips pan-head sheet metal screws.



Thresholds & Weatherstripping

REPLACEMENT INSERTS

Vinyl - Grey

List Price (Per Foot)

400S.....	\$ 1.30
434S, 435S, 477S, 478S, 481S, 515S, 516S, 517S, 518S, 520S, 532S, 541S, 552S, 560S, 565S, 570S, 575S, 580S, 599S, 771S, 837S, 860S.....	0.80
756S, 770S, 884S.....	1.10
774S, 777S, 778S, 779S, 780S, 782S, 783S.....	1.30
881S, 885S, 890S, 891S, 896S.....	0.80

Vinyl - Black

Black inserts are supplied standard with DBA aluminum extrusions. Must specify on order for black replacement gaskets.

434S, 435S, 477S, 478S, 481S, 515S, 516S, 517S, 518S, 520S, 532S, 541S, 552S, 560S, 565S, 570S, 575S, 580S, 599S, 771S, 837S, 860S.....	0.80
881S, 885S, 890S, 891S, 896S.....	0.70

Silicone - Grey

434S, 435S, 477S, 478S, 481S, 515S, 516S, 517S, 518S, 520S, 532S, 541S, 552S, 560S, 565S, 570S, 575S, 580S, 599S, 771S, 837S, 860S.....	2.30
730S, 740S.....	4.70
750S.....	1.30
875S.....	1.50
881S, 885S, 890S, 891S, 896S.....	1.60

Silicone - Black

Black inserts are supplied standard with DBA aluminum extrusions. Must specify on order for black replacement gaskets.

434S, 435S, 477S, 478S, 481S, 515S, 516S, 517S, 518S, 520S, 532S, 541S, 552S, 560S, 565S, 570S, 575S, 580S, 599S, 771S, 837S, 860S.....	2.30
881S, 885S, 890S, 891S, 896S.....	1.60

Neoprene - Black

434S, 435S, 477S, 478S, 481S, 515S, 516S, 517S, 518S, 520S, 532S, 541S, 552S, 560S, 565S, 570S, 575S, 580S, 599S, 771S, 837S, 860S.....	2.10
730S, 740S, 864S, 870S, 872S*, 873S, 877S, 878S, 880S, 892S.....	1.30
743S, 747S, 861S.....	2.50
754S, 774S, 777S, 778S, 779S, 780S, 782S.....	1.30
750S, 753S, 785S, 862S, 863S.....	1.40
858S, 865S, 866S.....	3.60
871S, 874S, 875S.....	1.40
881S, 885S, 890S, 891S, 896S.....	1.00

Neoprene - Grey

872S(US32D finishes only).....	4.90
--------------------------------	------

Pile - Grey

434S, 435S, 477S, 478S, 515S, 516S, 517S, 518S, 520S, 532S, 541S, 552S, 560S, 565S, 570S, 575S, 580S, 599S, 728S, 771S, 789S, 806S, 808S, 837S, 845S, 847S, 881S, 885S, 893S.....	0.90
--	------

Nylon Brush - Black

770S, 800S, 802S, 882S, 883S.....	2.80
801S, 803S, 806S, 808S.....	5.60



FABRICATION OPTIONS

	Add to List Price
Bevel One Edge of Threshold.....	\$ 5.50 /ft
Rip One Edge (Width) of Threshold.....	5.50 /ft
L-Notch Both Ends of Threshold.....	10.50 /ea
U-Notch Both Ends of Threshold.....	20.90 /ea
Cast Abrasive Notching.....	POA
Miter Return on One Edge, One End of Threshold.....	35.60 /ea
Miter Return on One Edge, Both Ends of Threshold.....	71.20 /ea
Miter Return on Both Edges, One End of Threshold.....	71.20 /ea
Miter Return on Both Edges, Both Ends of Threshold.....	142.40 /ea
Tack Weld One Line of Threshold.....	POA
Pan for Water Return Threshold.....	1.00 /ft
End Caps for Automatic Door Bottoms (Mortised Models).....	DBA 7.20 /2 Caps
	GLD 7.20 /2 Caps
Lead Lining (Automatic Door Bottoms) - Up to 48".....	121.70

FINISH OPTIONS

	Add to List Price
Clear Anodized (CLR).....	Price on Application
Black Anodized (BLA).....	Price on Application
White Paint (WHP).....	Price on Application

SURE-STEP

	Add to List Price
Up to 4" Width.....	21.10 /ft
Up to 5" Width.....	26.40 /ft
Up to 6" Width.....	31.60 /ft
Up to 7" Width.....	37.00 /ft
Up to 8" Width.....	42.20 /ft

QUICK SHIP

Products denoted with **bold and red** in the stock number listing in the back of the pricing section are available to order through the QuickShip program and ship within 24 hours. When ordering these products please visit www.hagerco.com and log in to MyHager to access the 'Quick Ship' portal. Due to the promptness of the fulfillment process, Quick Ship orders are non-cancellable.

LEAD TIMES

Stock items will typically ship in five working days or less from the order entry date. Made-to-order items will typically ship in 15 working days depending on seasonal volume and order complexity. Special orders including industrials, special machining, and large quantities may need to be scheduled. The anticipated ship date will be included with each order acknowledgement. Please contact Customer Service if product availability is in question.

CANCELLATION NOTIFICATION

Cancellation for made-to-order items must be communicated within 48 hours of order placement.



Thresholds and Weatherstripping

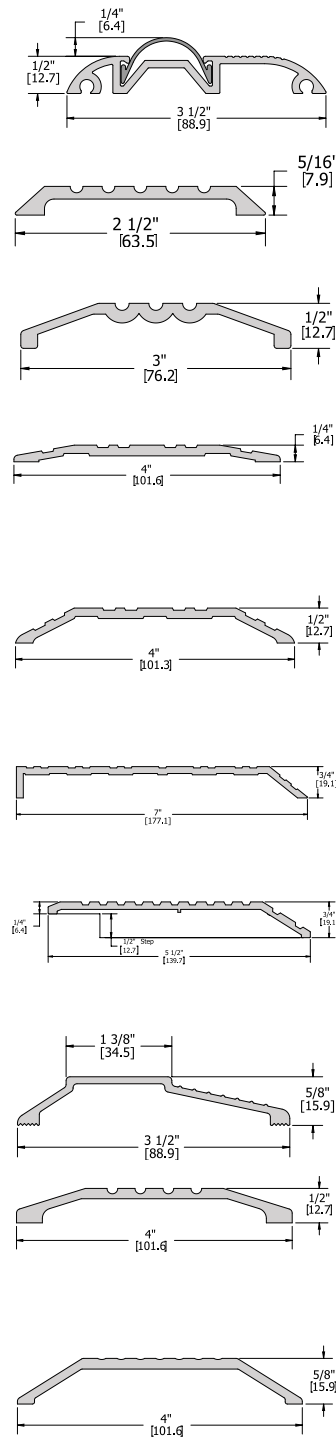

Description	Finish	Without Insert		With Insert		Comparison Numbers
		N	S	V	W	
400S Threshold - Saddle w/ Vinyl 3-1/2" x 3/4"	MIL			9.80		Pemko: 206V ANSI: J31130
	DBA			13.00		
	GLD			14.70		
401S Threshold - Saddle 2-1/2" x 5/16"	MIL	6.90				NGP: 211 Pemko: 166 ANSI: J32130
	DBA	9.50				
	GLD	11.00				
402S Threshold - Saddle 3" x 1/2"	MIL	7.10				Pemko: 169 ANSI: J32100
	DBA	9.70				
	GLD	11.30				
403S Threshold - Saddle 4" x 1/4"	MIL	7.00				NGP: 413 Pemko: 270 ANSI: J32130
	DBA	11.80				
	GLD	13.30				
	32D	122.40				
404S Threshold - Saddle 4" x 1/2"	MIL	8.00				NGP: 424E NGP: 412SS Pemko: 170 ANSI: J32130
	DBA	11.70				
	GLD	12.90				
	32D	132.60				
406S Threshold - Half Saddle 7" x 3/4"	MIL	23.10				NGP: 458 Pemko: 1877 ANSI: J33100
	DBA	24.90				
	GLD	27.20				
407S Threshold - Half Saddle 1/2" Step 5-1/2" x 3/4"	MIL	13.40				NGP: 655 Pemko: 157 ANSI: J33180
	DBA	20.70				
	GLD	23.00				
408S Threshold - Saddle 3-1/2" x 5/8"	MIL	6.30				Pemko: 212 ANSI: J30100
	DBA	8.90				
	GLD	10.10				
410S Threshold - Saddle 4" x 1/2"	MIL	8.10				NGP: 424 Pemko: 170 ANSI: J32130
	DBA	11.70				
	GLD	12.90				
	MIB	127.00				
411S Threshold - Saddle 4" x 5/8"	MIL	11.00				Pemko: 198 ANSI: J32100
	DBA	16.90				
	GLD	19.90				

1. U/M is feet unless otherwise noted.

Thresholds and Weatherstripping

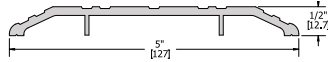

Description	Finish	Without Insert			With Insert			Comparison Numbers
		Insert	N	S	V	W		
412S Threshold - Saddle 5" x 1/2"	MIL						NGP: 425E	
	DBA						NGP: 512SS	
	GLD						Pemko: 171	
	MIB						ANSI: J32130	
	32D							

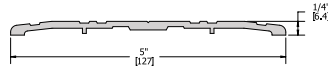

413S Threshold - Saddle 5" x 1/4"	MIL						NGP: 513
	DBA						Pemko: 271
	GLD						ANSI: J32130
	32D						

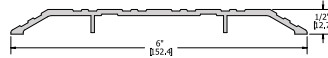

415S Threshold - Saddle 6" x 1/2"	MIL						NGP: 426
	DBA						Pemko: 172
	GLD						ANSI: J32130

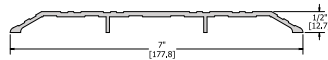

416S Threshold - Saddle 7" x 1/2"	MIL						NGP: 427
	DBA						Pemko: 176
	GLD						ANSI: J32130

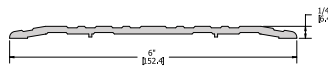

417S Threshold - Saddle 6" x 1/4"	MIL						NGP: 613
	DBA						Pemko: 272
	GLD						ANSI: J32130

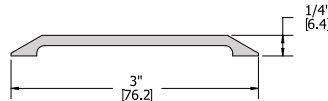

418S Threshold - Saddle 3" x 1/4"	MIL						NGP: 411
	DBA						Pemko: 151
	GLD						ANSI: J32330

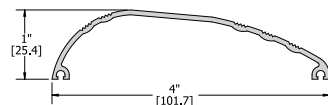

419S Threshold - Saddle 4" x 1"	MIL						Pemko: 219
	DBA						ANSI: J30100
	GLD						

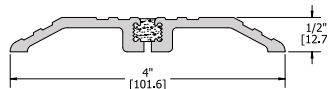

420S Threshold - Saddle Thermal Barrier 4" x 1/2"	MIL						NGP: 8424
	DBA						Pemko: 252X2FG
	GLD						ANSI: J32193

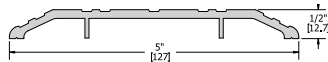

421S Threshold - Saddle Thermal Barrier 5" x 1/2"	MIL						NGP: 8425
	DBA						Pemko: 252X3FG
	GLD						ANSI: J32193

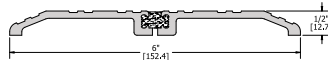

422S Threshold - Saddle Thermal Barrier 6" x 1/2"	MIL						NGP: 8426
	DBA						Pemko: 253X3FG
	GLD						ANSI: J32193

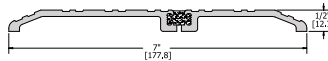

423S Threshold - Saddle Thermal Barrier 7" x 1/2"	MIL						NGP: 8427
	DBA						Pemko: 253X4FG
	GLD						ANSI: J32193

Price Code: POA - Price on Application
 Insert Codes: V - Vinyl; N - Neoprene, EDPM, or TPE; S - Silicone; W - Pile; B - Nylon Brush; F - Vinyl Fin
 Finish Codes: MIL - Mill Finished Aluminum; DBA - Dark Bronze Anodized; GLD - Gold Anodized; MIB - Mill Finished Bronze; 32D - Matte Stainless Steel; GYP - Primed for Painting; CLR - Clear Anodized; CAL - Cast Aluminum



Thresholds and Weatherstripping

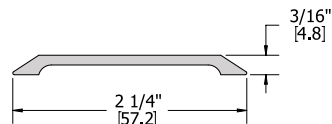
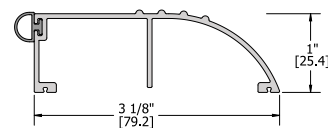
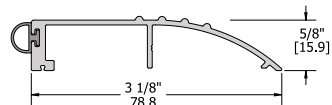
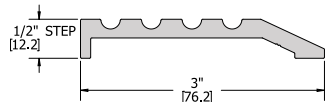
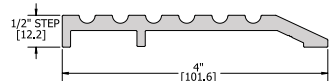
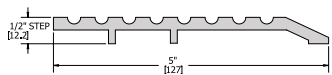
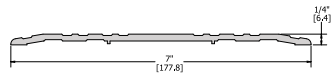
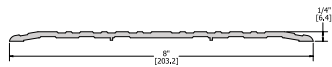
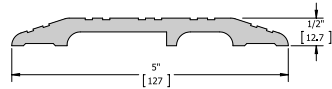
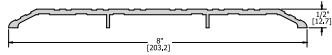
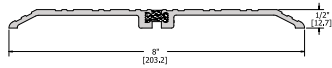

Description	Finish	Without Insert		With Insert			Comparison Numbers
		Insert	N	S	V	W	
424S Threshold - Saddle Thermal Barrier 8" x 1/2"	MIL	21.60					NGP: 8428 Pemko: 254X4FG ANSI: J32193
	DBA	29.00					
	GLD	31.70					
426S Threshold - Saddle 8" x 1/2"	MIL	21.50					NGP: 428E Pemko: 2548 ANSI: J32130
	DBA	28.70					
	GLD	33.00					
427S Threshold - Saddle Heavy Duty 5" x 1/2"	MIL	28.50					NGP: 425HD Pemko: 1715 ANSI: J32130
	DBA	37.50					
428S Threshold - Saddle 8" x 1/4"	MIL	20.20					NGP: 813 Pemko: 2748 ANSI: J32130
	DBA	26.70					
	GLD	31.20					
430S Threshold - Saddle 7" x 1/4"	MIL	17.30					NGP: 713 Pemko: 276 ANSI: J32130
	DBA	22.40					
	GLD	26.70					
431S Threshold - Half Saddle 5" x 1/2"	MIL	20.30					NGP: 325 Pemko: 229 ANSI: J33130
	DBA	27.80					
	GLD	31.30					
	MIB	224.30					
432S Threshold - Half Saddle 4" x 1/2"	MIL	17.90					NGP: 324 Pemko: 227 ANSI: J33130
	DBA	25.20					
	GLD	27.80					
433S Threshold - Half Saddle 3" x 1/2"	MIL	8.00					NGP: 322 Pemko: 168 ANSI: J33130
	DBA	10.40					
	GLD	12.70					
434S Threshold - Bumper Vinyl insert supplied unless other material specified 3-1/8" x 5/8"	MIL		8.00	8.00	6.10	6.10	Pemko: 205 ANSI: J30100
	DBA		10.20	10.20	7.60	7.60	
	GLD		11.60	11.60	8.80	8.80	
435S Threshold - Bumper Vinyl insert supplied unless other material specified 3-1/8" x 1"	MIL		9.60	9.60	7.20	7.20	Pemko: 2051 ANSI: J30100
	DBA		12.20	12.20	9.10	9.10	
	GLD		14.00	14.00	10.60	10.60	
436S Threshold - Saddle 2-1/4" x 3/16"	MIL	5.20					NGP: 410 Pemko: 173 ANSI: J32330
	DBA	7.70					
	GLD	8.60					



Thresholds and Weatherstripping

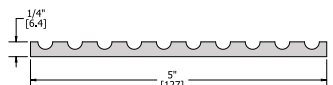
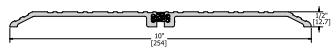
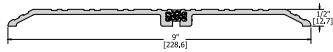
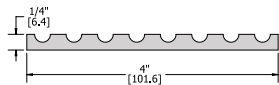
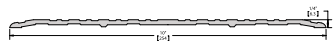
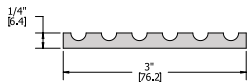
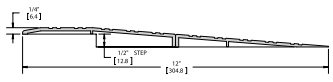
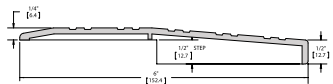
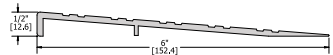
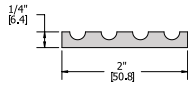
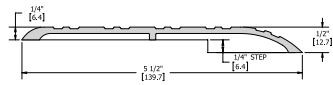

Description	Finish	Without Insert		With Insert			Comparison Numbers
		N	S	V	W		
438S Threshold - Half Saddle 1/4" Step 5-1/2" x 1/2"	MIL DBA	13.10 19.40				NGP: 653 Pemko: 158 ANSI: J32330	
440S Threshold - Floor Plate 2" x 1/4"	MIL DBA GLD	8.00 10.20 11.70				NGP: 8142 Pemko: 190 ANSI: J37100	
442S Threshold Barrier Free Ramp 1/2" Rise 6" x 1/2"	MIL DBA GLD	12.40 16.60 19.20				NGP: 657 Pemko: 259 ANSI: J38130	
443S Threshold Barrier Free Ramp 1/4" Rise 6" x 3/4"	MIL DBA GLD	14.10 18.70 21.30				Pemko: 257 ANSI: J30180	
444S Threshold Barrier Free Ramp 3/4" Rise 12" x 3/4"	MIL DBA GLD	29.50 36.20 42.40				NGP: R050 Pemko: 257X259 ANSI: J38183	
445S Threshold - Floor Plate 3" x 1/4"	MIL DBA GLD	10.80 14.70 17.00				NGP: 8143 Pemko: 191 ANSI: J37100	
448S Threshold - Saddle 10" x 1/4"	MIL DBA	26.90 34.80				NGP: 1013 ANSI: J37100 Pemko: 2750	
450S Threshold - Floor Plate 4" x 1/4"	MIL DBA GLD	14.60 19.20 20.20				NGP: 8144 Pemko: 192 ANSI: J37100	
451S Threshold - Saddle Thermal Barrier 9" x 1/2"	MIL DBA GLD	26.50 33.90 36.80				NGP: 8429 Pemko: 254X5FG ANSI: J32193	
452S Threshold - Saddle Thermal Barrier 10" x 1/2"	MIL DBA GLD	29.30 37.10 41.40				NGP: 8430 Pemko: 255X5FG ANSI: J32193	
455S Threshold - Floor Plate 5" x 1/4"	MIL DBA GLD	17.80 23.80 27.50				NGP: 8145 ANSI: J37100	

Price Code: POA - Price on Application
 Insert Codes: V - Vinyl; N - Neoprene, EDPM, or TPE; S - Silicone; W - Pile; B - Nylon Brush; F - Vinyl Fin
 Finish Codes: MIL - Mill Finished Aluminum; DBA - Dark Bronze Anodized; GLD - Gold Anodized; MIB - Mill Finished Bronze; 32D - Matte Stainless Steel; GYP - Primed for Painting; CLR - Clear Anodized; CAL - Cast Aluminum

Thresholds and Weatherstripping

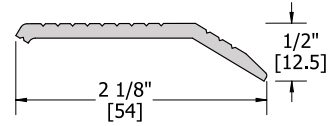
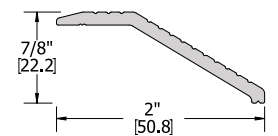
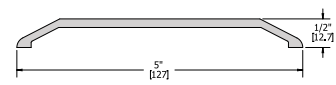
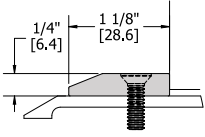
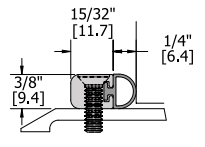
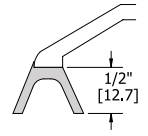
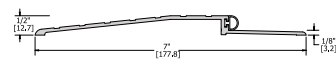
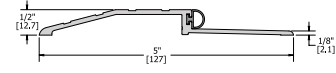
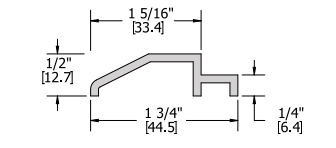
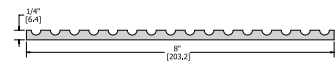
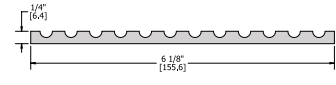

Description	Finish	Without Insert		With Insert			Comparison Numbers
		Insert	N	S	V	W	
460S Threshold - Floor Plate 6-1/8" x 1/4"	MIL	20.80					NGP: 8146
	DBA	27.70					Pemko: 193
	GLD	31.20					ANSI: J37100
465S Threshold - Floor Plate 8" x 1/4"	MIL	27.10					NGP: 8148
	DBA	37.70					Pemko: 228
	GLD	41.60					ANSI: J37100
470S Threshold Plate Support 1-3/4" x 1/2"	MIL	5.10					NGP: 8140
	DBA	7.30					Pemko: 195
	GLD	8.10					
477S Threshold - Bumper 5" x 1/2"	MIL		12.30	12.90	11.60	11.60	NGP: 950
	DBA		16.10	17.20	15.40	15.40	Pemko: 2001
	GLD		17.60	18.20	16.90	16.90	ANSI: J36100
478S Threshold - Bumper 7" x 1/2"	MIL		18.20	19.00	17.30	17.30	ANSI: J30100
	DBA		23.90	24.60	22.90	22.90	
	GLD		25.10	26.20	24.20	24.20	
480S Threshold Elevator 1/2"	MIL	4.00					NGP: 58
	DBA	5.10					Pemko: 188
481S Threshold Bumper Strip 23/32" x 3/8"	MIL		6.00	6.30	5.40	5.40	NGP: 2
	DBA		7.80	8.20	7.00	7.00	Pemko: 184
	GLD		9.00	8.70	8.50	8.50	
484S Threshold Bumper Strip 1-1/8" x 1/4"	MIL	5.20					NGP: 8136
	DBA	7.80					Pemko: 196
	GLD	8.20					
492S Threshold - Saddle 5" x 1/2"	MIL	12.80					Pemko: 154
	DBA	16.00					ANSI: J32330
	GLD	18.50					Pemko: 2132
503S Threshold - Carpet Edge 2" x 7/8"	MIL	6.10					NGP: 416
	DBA	9.70					ANSI: J32180
	GLD	11.00					Pemko: 2134
504S Threshold - Carpet Edge 2-1/8" x 1/2"	MIL	8.30					NGP: 417
	DBA	10.80					Pemko: 174
	GLD	12.30					ANSI: J32183

Thresholds and Weatherstripping

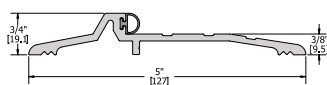
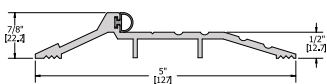
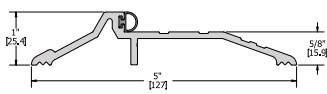
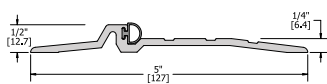
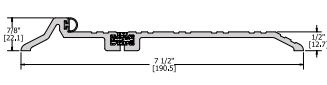
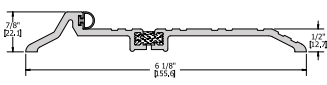
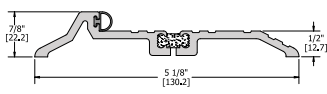
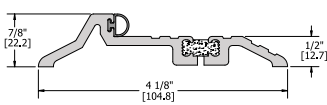
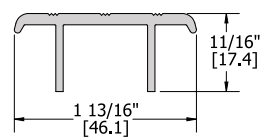
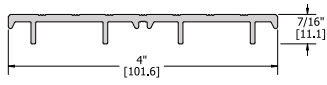
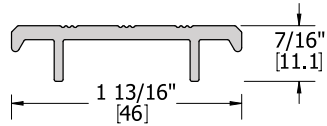

Description	Finish	Without Insert		With Insert			Comparison Numbers
		Insert	N	S	V	W	
505S Threshold - Carpet Divider 1-13/16" x 7/16"	MIL		5.60				NGP: 414 Pemko: 236 ANSI: J32113
	DBA		7.50				
	GLD		8.50				
506S Threshold - Carpet Divider 4" x 7/16"	MIL		9.80				NGP: 404 Pemko: 2364 ANSI: J32113
	DBA		13.30				
	GLD		15.30				
508S Threshold - Carpet Divider 1-13/16" x 11/16"	MIL		5.90				NGP: 414 Pemko: 236 ANSI: J32140
	DBA		7.70				
	GLD		8.30				
515S Threshold - Panic Thermal Barrier 4-1/8" x 7/8"	MIL		17.60	17.60	16.10	16.10	Pemko: 252X226FG ANSI: J36190
	DBA		23.00	23.00	20.90	20.90	
	GLD		24.70	24.70	22.50	22.50	
516S Threshold - Panic Thermal Barrier 5-1/8" x 7/8"	MIL		18.80	18.80	17.90	17.90	NGP: 8435 Pemko: 253X226FG ANSI: J36190
	DBA		25.00	25.00	23.30	23.30	
	GLD		26.30	26.30	25.10	25.10	
517S Threshold - Panic Thermal Barrier 6-1/8" x 7/8"	MIL		21.00	21.00	19.90	19.90	NGP: 8436 Pemko: 254X226FG ANSI: J36190
	DBA		27.80	27.80	26.50	26.50	
	GLD		29.30	29.30	27.90	27.90	
518S Threshold - Panic Thermal Barrier 7-1/2" x 7/8"	MIL		23.80	23.80	22.50	22.50	NGP: 8437 Pemko: 255X226FG ANSI: J36190
	DBA		31.70	31.70	29.90	29.90	
	GLD		34.90	34.90	34.10	34.10	
520S Threshold - Panic 5" x 1/2"	MIL		11.90	11.90	11.00	11.00	NGP: 896 Pemko: 2005 ANSI: J36130
	DBA		15.40	15.40	14.20	14.20	
	GLD		17.10	17.10	15.80	15.80	
532S Threshold - Panic 5" x 1"	MIL		14.60	14.60	13.50	13.50	NGP: 803 Pemko: 181 ANSI: J36100
	DBA		19.40	19.40	18.00	18.00	
	GLD		21.20	21.20	19.60	19.60	
541S Threshold - Panic 5" x 7/8"	MIL		14.30	14.30	13.30	13.30	NGP: 804 Pemko: 177 ANSI: J36100
	DBA		19.30	19.30	18.90	18.90	
	GLD		21.40	21.40	21.40	21.40	
552S Threshold - Panic 5" x 3/4"	MIL		14.10	14.10	13.40	13.40	NGP: 890 Pemko: 179 ANSI: J36100
	DBA		18.70	18.70	18.00	18.00	
	GLD		21.40	21.40	20.30	20.30	

Price Code: POA - Price on Application
 Insert Codes: V - Vinyl; N - Neoprene, EDPM, or TPE; S - Silicone; W - Pile; B - Nylon Brush; F - Vinyl Fin
 Finish Codes: MIL - Mill Finished Aluminum; DBA - Dark Bronze Anodized; GLD - Gold Anodized; MIB - Mill Finished Bronze; 32D - Matte Stainless Steel; GYP - Primed for Painting; CLR - Clear Anodized; CAL - Cast Aluminum

Thresholds and Weatherstripping

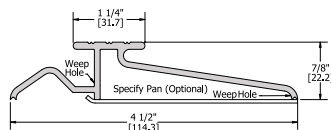
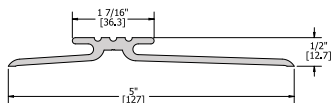
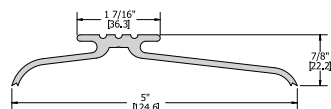
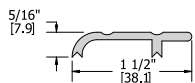
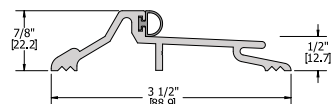
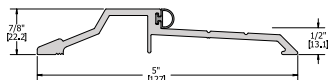
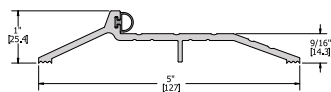
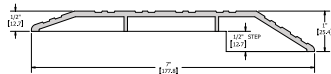
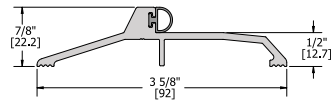
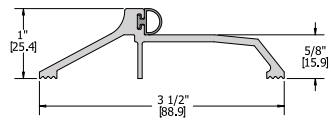

Description	Finish	Without Insert		With Insert			Comparison Numbers
		Insert	N	S	V	W	
560S Threshold - Panic 3-1/2" x 1"	MIL		12.30	12.30	11.50	11.50	NGP: 891 Pemko: 185 ANSI: J36300
	DBA		17.20	17.20	16.10	16.10	
	GLD		19.10	19.10	17.90	17.90	
565S Threshold - Panic 3-5/8" x 7/8"	MIL		12.60	12.60	11.70	11.70	Pemko: 1855 ANSI: J36300
	DBA		17.10	17.10	16.50	16.50	
	GLD		18.90	18.90	17.20	17.20	
572S Threshold - Half Saddle 1/2" Offset 7" x 1"	MIL	17.70					Pemko: 182 ANSI: J33180 NGP: 656
	DBA	24.00					
	GLD	28.40					
575S Threshold - Panic 5" x 1"	MIL		14.40	14.40	13.60	13.60	Pemko: 181 ANSI: J36100
	DBA		19.50	19.50	18.30	18.30	
	GLD		21.20	21.20	19.90	19.90	
580S Threshold - Panic 5" x 7/8"	MIL		16.80	16.80	16.10	16.10	NGP: 897 Pemko: 277 ANSI: J36100
	DBA		21.90	21.90	20.90	20.90	
	GLD		23.60	23.60	22.50	22.50	
599S Threshold - Panic 3-1/2" x 7/8"	MIL		13.90	13.90	13.30	13.30	Pemko: 159 ANSI: J36300
	DBA		19.70	19.70	18.50	18.50	
	GLD		19.20	19.20	20.20	20.20	
600S Threshold - Interlock Cap 1-1/2" x 5/16"	MIL	5.60					Pemko: 101 ANSI: J34170
	DBA	6.20					
	GLD	8.10					
603S Threshold - Interlock 5" x 7/8" * 701S Interlocking Hook provided	MIL	13.50					Pemko: 120 ANSI: J34170
	DBA	19.60					
604S Threshold - Interlock 5" x 1/2" *701S Interlocking Hook provided	MIL	13.80					Pemko: 114 ANSI: J34170
	DBA	17.20					
608S Threshold - Interlock Water Return *Pan Extra - See options, must specify on order 4-1/2" x 7/8"	MIL	14.80					Pemko: 145 ANSI: J34170
	DBA	17.00					

Thresholds and Weatherstripping

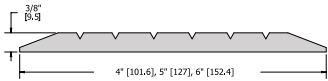

Description	Finish	Without Insert		With Insert			Comparison Numbers
		Insert	N	S	V	W	
626S Threshold - Saddle Cast Abrasive Aluminum 8' Max Length							ANSI: J37230
4" x 3/8"	CAL					96.40	
5" x 3/8"	CAL					115.70	
6" x 3/8"	CAL					134.90	

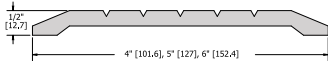

627S Threshold - Saddle Cast Abrasive Aluminum 8' Max Length							ANSI: J32230 NGP: 4425
4" x 1/2"	CAL					96.40	
5" x 1/2"	CAL					115.90	
6" x 1/2"	CAL					134.90	

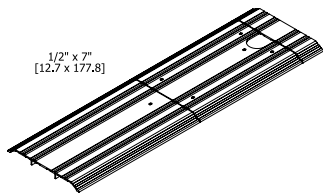

651S Threshold - Saddle for floor closers center hung without mitered end 7" x 1/2"							NGP: Type 1 Pemko: Type 11 ANSI: J39130
Up to 36"							
	MIL					137.90	
	DBA					153.90	
Up to 72"							
	MIL					274.90	
	DBA					307.60	
Lengths over 72" add the following per inch							
	MIL					1.70	
	DBA					2.00	

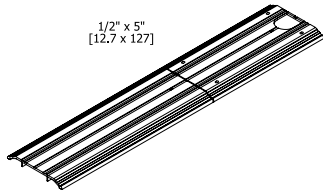

652S Threshold - Saddle for floor closers center hung without mitered end 5" x 1/2"							NGP: Type 1 Pemko: Type 11 ANSI: J39130
Up to 36"							
	MIL					110.50	
	DBA					123.30	
Up to 72"							
	MIL					225.00	
	DBA					251.10	
Lengths over 72" add the following per inch							
	MIL					1.70	
	DBA					2.00	

Price Code: POA - Price on Application
 Insert Codes: V - Vinyl; N - Neoprene, EDPM, or TPE; S - Silicone; W - Pile; B - Nylon Brush; F - Vinyl Fin
 Finish Codes: MIL - Mill Finished Aluminum; DBA - Dark Bronze Anodized; GLD - Gold Anodized; MIB - Mill Finished Bronze; 32D - Matte Stainless Steel; GYP - Primed for Painting; CLR - Clear Anodized; CAL - Cast Aluminum

Thresholds and Weatherstripping

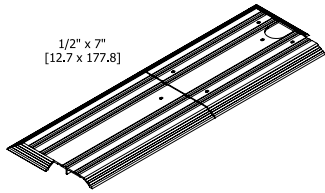

Description	Finish	Without Insert		With Insert			Comparison Numbers
		N	S	V	W		
653S Threshold - Saddle For Floor Closers Offset hung with Mitered Ends 7" x 1/2" Up to 36"	MIL		192.20				NGP: Type 3 Pemko: Type 13 ANSI: J39153
	DBA		214.50				
Up to 72"	MIL		374.20				
	DBA		399.60				
Lengths over 72" add the following per inch	MIL		1.70				
	DBA		2.00				

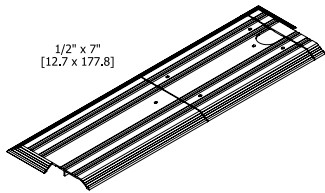

654S Threshold - Saddle For Floor Closers Offset hung with Mitered Ends 7" x 1/2" Up to 36"	MIL		192.20				NGP: Type 4 Pemko: Type 14 ANSI: J39153
	DBA		214.50				
Up to 72"	MIL		384.30				
	DBA		428.90				
Lengths over 72" add the following per inch	MIL		1.70				
	DBA		2.00				

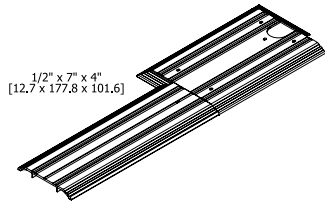

655S Threshold - Saddle For Floor Closers Offset hung with Mitered Ends 7" x 1/2" Up to 36"	MIL		232.20				NGP: Type 5 Pemko: Type 15 ANSI: J39153
	DBA		259.20				
Up to 72"	MIL		464.50				
	DBA		518.40				
Lengths over 72" add the following per inch	MIL		0.80				
	DBA		1.10				



676S Cover Plate 8' Max. Length 1/8" Height Charges: length X per foot charge X width in inches (3" min.) Example: 6 (ft. length) x \$7.10 (ft. list) x 6 (in. width)	MIL		7.10				NGP: 818 Pemko: 18/1A ANSI: J17300
---	-----	--	------	--	--	--	--

Thresholds and Weatherstripping

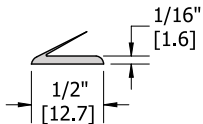
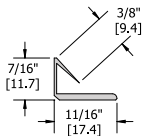
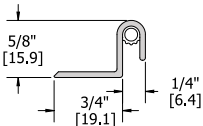
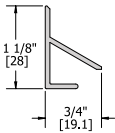
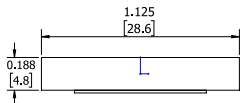
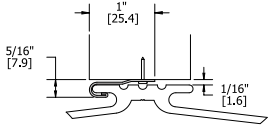

Description	Finish	Without Insert		With Insert			Comparison Numbers
		Insert	N	S	V	W	
677S Cover Plate 8' Max. Length 1/4" Height Charges: length X per foot charge X width in inches (3" min.) Example: 6 (ft. length) x \$1 1.40 (ft. list) x 6 (in. width)	MIL	11.40					NGP: 814 Pemko: 14/1A ANSI: J17300
701S Weatherstrip Interlock "J" Hook	MIL	3.50					NGP: 80 Pemko: 61 ANSI: ROY016
710S Press-On Mullion Smoke Seal Sponge Neoprene Note: Available in 120" only	Black	23.30/roll					NGP: 5100 Pemko: 5110 ANSI: ROC004
717S Weatherstrip Interlock Overhead Rain Drip	MIL DBA	4.00 6.40					NGP: 124 Pemko: 347 ANSI: R3Y106
718S Weatherstrip Interlock Overhead w/ Vinyl	MIL DBA				3.90 5.90		NGP: 123 Pemko: 68 ANSI: R3D036
719 Press-on Weatherstrip Edge Sealing System & Smoke Seal Intumescent material							NGP: 9450 ANSI: ROW154
7'	Brown	32.27					
8'	Gray	36.88					
9'	Charcoal	41.49					
3' x 7'	Tan	78.37					
4' x 7'	White	82.98					
4' x 8'		92.20					
6' x 7'		92.20					
7' x 7'		96.81					
720 Press-on Weatherstrip Edge Sealing System & Smoke Seal Intumescent material							NGP: 9850 Pemko: HSS2000XS44 ANSI: ROW154
3' x 7'	Brown	65.28					
4' x 7'	Gray	69.12					
4' x 8'	Charcoal	76.80					
6' x 7'	Tan	76.80					
7' x 7'	White	80.64					
6' x 8'		84.48					
8' x 8'		92.16					

Price Code: POA - Price on Application
 Insert Codes: V - Vinyl; N - Neoprene, EDPM, or TPE; S - Silicone; W - Pile; B - Nylon Brush; F - Vinyl Fin
 Finish Codes: MIL - Mill Finished Aluminum; DBA - Dark Bronze Anodized; GLD - Gold Anodized; MIB - Mill Finished Bronze; 32D - Matte Stainless Steel; GYP - Primed for Painting; CLR - Clear Anodized; CAL - Cast Aluminum

Thresholds and Weatherstripping

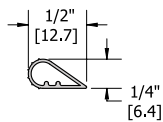
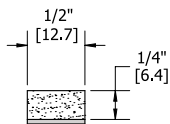
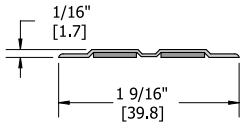
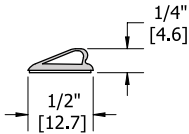
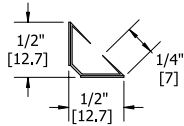

Description	Finish	Without Insert		With Insert		Comparison Numbers
		Insert	N	S	V	
721 Press-on Weatherstrip Smoke Seal TPE						NGP: 5020 ANSI: ROW154
7'	Brown	14.20				
8'	Gray	16.30				
9'	Charcoal	18.30				
3' x 7'	Tan	34.60				
4' x 7'	White	36.60				
4' x 8'		40.70				
6' x 7'		40.70				
7' x 7'		42.70				
722 Press-on Weatherstrip Edge Sealing System & Smoke Seal Intumescent material						Pemko: HSS2000xs88 ANSI: ROW154 NGP: 9750
3' x 7'	Charcoal	65.80				
4' x 7'	Brown	69.70				
4' x 8'	Tan	77.50				
6' x 7'	White	77.50				
7' x 7'		81.30				
6' x 8'		85.20				
8' x 8'		93.00				
724 Press-on Weatherstrip Edge Sealing System Intumescent material						NGP: 9500 ANSI: ROW156
7'	Brown	38.90				
8'	Gray	44.40				
9'	Charcoal	50.00				
3' x 7'	Tan	94.40				
4' x 8'	White	111.10				
725 Press-on Weatherstrip Sponge Neoprene	Charcoal		0.95			Pemko: P493 ANSI: ROC156
726 Press-on Weatherstrip Smoke Seal						NGP: 5050 Pemko: S88 ANSI: ROE154
17'	Brown			24.30		
18'	Charcoal			26.50		
19'	Tan			27.50		
20'	White			28.60		
21'				30.90		
22'				32.40		
25'				36.80		
260'				363.30		
520'				726.60		



Thresholds and Weatherstripping

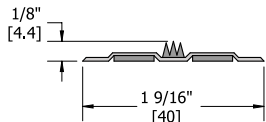
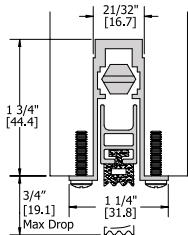
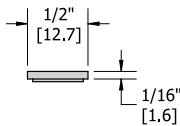
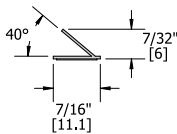
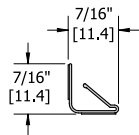

Description	Finish	Without Insert		With Insert			Comparison Numbers
		N	S	V	W		
727 Press-on Weatherstrip TPE material							NGP: PF180 ANSI: ROY156
7'	Charcoal		11.10				
8'			12.60				
3' x 7'			26.90				
4' x 8'			31.60				
728 Press-on Weatherstrip TPE							NGP: 5040 Pemko: S44 ANSI: R00154
17'	Charcoal			23.80			
20'	White			27.90			
21'				29.10			
25'				34.70			
260'				328.70			
520'				656.80			
729 Press-on Weatherstrip Edge Sealing System Intumescent material							NGP: 9800 Pemko: HSS2000 ANSI: ROW156
17'	Brown	32.50					
19'	Charcoal	36.20					
21'	Tan	40.10					
25'	White	47.70					
150'		280.40					
730S Automatic Door Bottom Mortise Application End Caps Furnished (max. drop 3/4")							NGP: 225 Pemko: 411 ANSI: R3Y326
24" to 36"	MIL		55.60	66.00			
37" to 48"	MIL		68.60	82.80			
734 Press-on Weatherstrip Edge Sealing System & Smoke Seal Intumescent material							NGP: 9550 ANSI: ROW154
7'	Brown	39.40					
8'	Charcoal	45.00					
9'	Tan	50.60					
3' x 7'	White	95.60					
6' x 7'		112.40					
8' x 8'		135.00					

Price Code: POA - Price on Application
 Insert Codes: V - Vinyl; N - Neoprene, EDPM, or TPE; S - Silicone; W - Pile; B - Nylon Brush; F - Vinyl Fin
 Finish Codes: MIL - Mill Finished Aluminum; DBA - Dark Bronze Anodized; GLD - Gold Anodized; MIB - Mill Finished Bronze; 32D - Matte Stainless Steel; GYP - Primed for Painting; CLR - Clear Anodized; CAL - Cast Aluminum

Thresholds and Weatherstripping

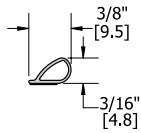

Description	Finish	Without Insert		With Insert		Comparison Numbers
		Insert	N	S	V	
736 Press-on Weatherstrip Smoke Seal						NGP: 2525 Pemko: PK33 ANSI: ROE154
17'	Charcoal			24.40		
18'	White			26.40		
19'	Tan			27.60		
20'				28.80		
21'				30.80		
22'				32.20		
25'				36.60		
260'				361.20		
520'				722.50		

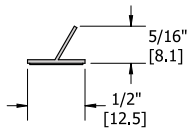

737 Press-on Weatherstrip Smoke Seal						NGP: 5060 Pemko: S77 ANSI: ROE154
17'	Charcoal			27.30		
18'	White			28.90		
19'				30.50		
20'				32.10		
21'				33.50		
22'				35.10		
25'				39.80		
260'				339.60		
520'				627.70		

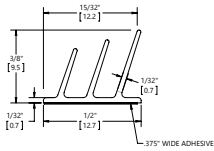

738 Press-on Weatherstrip Smoke Seal						NGP: 5075 Pemko: S773 ANSI: ROE154
17'	Charcoal			31.80		
18'				34.50		
20'				37.70		
21'				40.30		
22'				42.20		

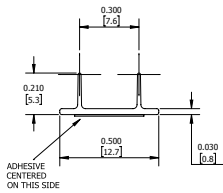

739 Press-on Weatherstrip Smoke Seal						NGP: 5070 Pemko: S772 ANSI: ROE154
17'	Brown			41.65		
18'	Clear			44.10		
19'				46.55		
20'				49.00		
21'				51.45		
22'				53.90		

Thresholds and Weatherstripping

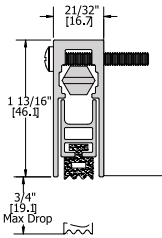

Description	Finish	Without Insert		With Insert		Comparison Numbers
		N	S	V	W	
740S Automatic Door Bottom - Surface Applied End Caps Furnished (max. drop 3/4") 24" to 36"	CLR	62.50	73.90			NGP: 222 Pemko: 4131 ANSI: R3Y336
	DBA	71.30	83.30			
	GLD	80.00	92.40			
37" to 48"	CLR	77.90	89.90			
	DBA	89.90	100.90			
	GLD	100.90	116.50			

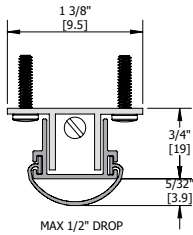

742S Automatic Door Bottom - Hollow Metal Door Application (max. drop 1/2") 24" to 36"	MIL	48.50	48.50			NGP: 320 Pemko: 420 ANSI: R3D326
37" to 48"	MIL	63.20	63.20			

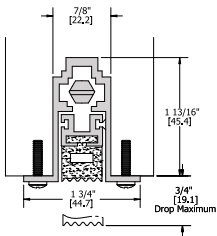

743S Automatic Door Bottom Mortise Application End Caps Furnished (max drop 3/4") 24" to 36"	MIL	90.00				NGP: 422 Pemko: 434 ANSI: R3C326
37" to 48"	MIL	111.20				

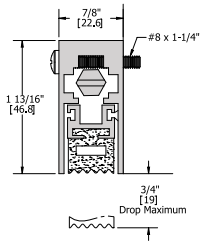

747S Automatic Heavy Duty Door Bottom - Surface Applied End Caps Furnished in Listed Furnishes (max. drop 3/4") 24" to 36"	CLR	97.00				NGP: 420 Pemko: 4301 ANSI: R3C336
	DBA	107.60				
	GLD	119.70				
37" to 48"	CLR	121.00				
	DBA	134.20				
	GLD	149.30				

Price Code: POA - Price on Application
 Insert Codes: V - Vinyl; N - Neoprene, EDPM, or TPE; S - Silicone; W - Pile; B - Nylon Brush; F - Vinyl Fin
 Finish Codes: MIL - Mill Finished Aluminum; DBA - Dark Bronze Anodized; GLD - Gold Anodized; MIB - Mill Finished Bronze; 32D - Matte Stainless Steel; GYP - Primed for Painting; CLR - Clear Anodized; CAL - Cast Aluminum



Thresholds and Weatherstripping

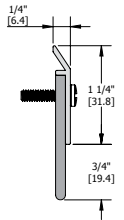
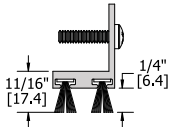
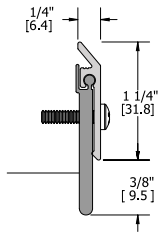

#6 x 5/8" PAN HEAD SHEET METAL SCREWS (FACTORY PROVIDED)

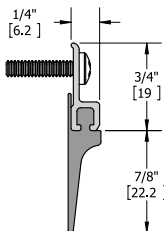
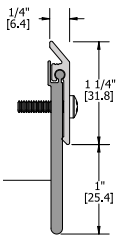
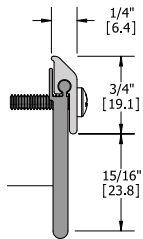

Description	Finish	Without Insert		With Insert		Comparison Numbers	
		Insert	N	S	V		W
750S Door Bottom - Sweep	CLR		4.50	6.70		NGP: 200 Pemko: 315 ANSI: R0Y436	
	DBA		5.90	8.20			
	GLD		6.50	8.80			
	32D		27.30	30.30			
751S Door Bottom - Shoe	MIL		7.10	8.40	7.30	7.60	Pemko: 317 ANSI: R0Y436
	DBA		8.60	10.30	9.00	9.30	
	GLD		9.60	10.70	9.40	9.50	
752S Door Bottom - Sweep	MIL				5.70		NGP: 102V ANSI: R3D436
	DBA				6.90		
	GLD				6.80		
753S Door Bottom - Sweep	MIL		6.70				NGP: 114 Pemko: 3151 ANSI: R3B436
	DBA		7.70				
	GLD		8.30				
754S Door Bottom - Sweep	CLR		6.80				NGP: 197 Pemko: 3151 ANSI: R3B436
	DBA		8.90				
	GLD		9.60				
756S Door Bottom - Sweep or Astragal*	MIL				3.00		NGP: 97 Pemko: 307 ANSI: R3D434
	DBA				4.10		
	GLD				4.40		

*Order 2 for a set



Thresholds and Weatherstripping

Description	Finish	Without Insert		With Insert			Comparison Numbers
		Insert	N	S	V	W	

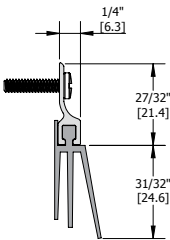

759S Door Bottom - Sweep	MIL				4.40		NGP: 96
	DBA				5.20		Pemko: 57
	GLD				5.70		ANSI: R3D436

Description	Finish	Without Insert		With Insert			Comparison Numbers
		Insert	B	S	V	W	

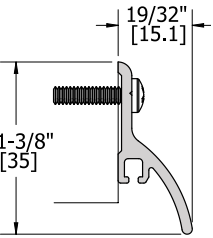

770S Door Bottom - Sweep w/ Rain Drip	MIL	2.70	6.50		4.30		NGP: 17
	DBA	4.80	8.00		5.70		NGP: 101
	GLD	5.30	8.20		6.30		NGP: C627 Pemko: 345 ANSI: R3Y534

Description	Finish	Without Insert		With Insert			Comparison Numbers
		Insert	N	S	V	W	

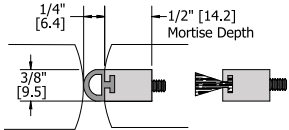

771S Astragal	MIL		10.30	10.70	9.90	9.50	NGP: 143
	DBA		11.30	11.70	10.80	12.10	Pemko: 300 ANSI: R3Y725

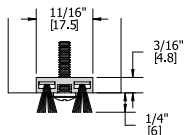

772S Door Bottom - Shoe or Astragal	MIL		6.40	6.80	6.60	6.30	NGP: 116
	DBA		7.90	8.60	8.10	7.70	Pemko: 313
	GLD		8.40	8.90	8.40	8.00	ANSI: R3Y726

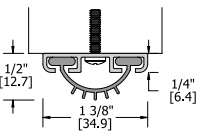

774S Door Bottom - Shoe or Astragal	MIL		4.20		3.50		NGP: 112
	DBA		5.50		4.50		Pemko: 234 ANSI: R3Y725

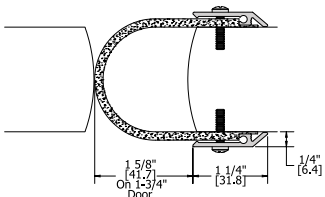

776S Door Bottom - Shoe or Astragal 1-3/4" Door	CLR		11.90				NGP: 14RA
	DBA		14.10				ANSI: R3C735

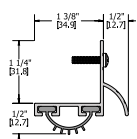

777S Door Bottom - Shoe w/ Rain Drip	MIL		6.10		5.10		NGP: 318
	DBA		7.90		6.60		Pemko: 210
	GLD		8.80		7.30		ANSI: R3D536

Price Code: POA - Price on Application
 Insert Codes: V - Vinyl; N - Neoprene, EDPM, or TPE; S - Silicone; W - Pile; B - Nylon Brush; F - Vinyl Fin
 Finish Codes: MIL - Mill Finished Aluminum; DBA - Dark Bronze Anodized; GLD - Gold Anodized; MIB - Mill Finished Bronze; 32D - Matte Stainless Steel; GYP - Primed for Painting; CLR - Clear Anodized; CAL - Cast Aluminum

Thresholds and Weatherstripping

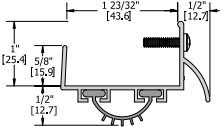
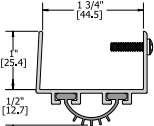
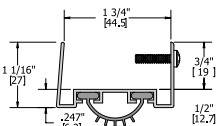
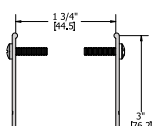
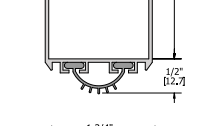
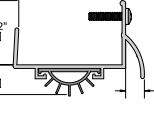
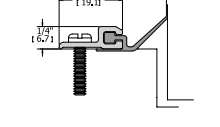
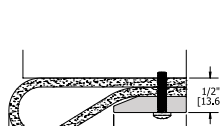
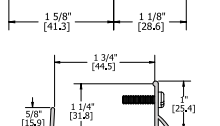
Description	Finish	Without Insert		With Insert		Comparison Numbers
		Insert	N	S	V	
 778S Door Bottom - Shoe w/ Rain Drip	MIL		6.10		5.10	NGP: 319E
	DBA		7.90		6.60	Pemko: 215
	GLD		8.80		7.30	ANSI: R3D536
 779S Door Bottom - Shoe	MIL		6.10		5.10	NGP: 36
	DBA		7.90		6.60	Pemko: 217
	GLD		8.80		7.30	ANSI: R3D436
 780S Door Bottom - Shoe	MIL		7.40		6.20	NGP: 35
	DBA		9.60		8.00	Pemko: 222
	GLD		10.80		9.00	ANSI: R3D436
 782S Door Bottom - Shoe	MIL		16.40		13.50	NGP: 99
	DBA		21.10		17.60	Pemko: 221
	GLD		22.60		20.30	ANSI: R3D436
 783S Door Bottom - Shoe w/ Rain Drip Low Profile	MIL				5.10	NGP: 319E
	DBA				7.20	ANSI: R3D536
	GLD				7.70	
 785S Jamb Weatherstrip up to 96"	MIL		4.30			NGP: 188
	DBA		6.20			ANSI: R3D164
	GLD		6.60			
 787S Garage Weatherstrip	MIL		37.60			NGP: 81369
						Pemko: E199
 789S Door Bottom Rain Drip	MIL					ANSI: R3F536
	DBA					9.20
	GLD					13.30
 800S Jamb Weatherstrip	MIL		5.50			NGP: A626A
	DBA		7.90			Pemko: 45041
	GLD		8.50			ANSI: R3F164

Thresholds and Weatherstripping

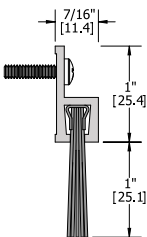

Description	Finish	B	N	With Insert			Comparison Numbers
				S	V	W	
801S Door Sweep or Jamb Weatherstrip or Astragal*	MIL	6.40					NGP: D608 Pemko: 18100 ANSI: R3D434
	DBA	8.30					
	GLD	8.40					

802S Door Sweep or Jamb Weatherstrip or Astragal*	MIL	4.10					NGP: B606 Pemko: 18061 ANSI: R3F164
	DBA	5.40					
	GLD	5.80					

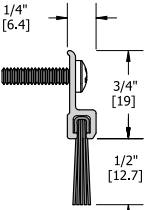

803S Jamb Weatherstrip	MIL	6.90					NGP: D620 Pemko: 45100 ANSI: R3F164
	DBA	8.20					
	GLD	8.80					

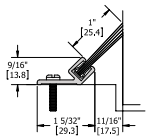

806S Door Sweep	MIL	9.10					Pemko: 18137 ANSI: R3F436
	DBA	13.10					
	GLD	13.60					

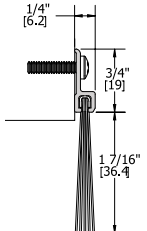

808S Jamb Weatherstrip	MIL	12.10					NGP: G622 Pemko: 45175 ANSI: R3F164
	DBA	16.90					
	GLD	17.30					

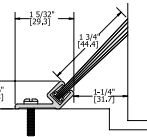

Description	Finish	Without Insert	N	With Insert			Comparison Numbers
				S	V	W	
810S Overhead Rain Drip	MIL	4.80					NGP: 16 Pemko: 346 ANSI: R3Y036
	DBA	6.50					
	GLD	7.50					

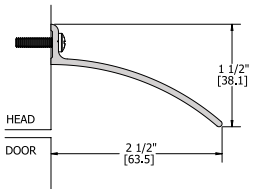

822S Jamb Weatherstrip Spring Bronze 8' Lengths only	MIB	4.30					NGP: 43CB Pemko: B75 ANSI: R1Y156
---	-----	------	--	--	--	--	---

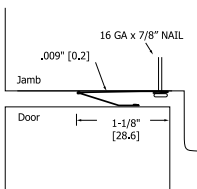

Price Code: POA - Price on Application
 Insert Codes: V - Vinyl; N - Neoprene, EDPM, or TPE; S - Silicone; W - Pile; B - Nylon Brush; F - Vinyl Fin
 Finish Codes: MIL - Mill Finished Aluminum; DBA - Dark Bronze Anodized; GLD - Gold Anodized; MIB - Mill Finished Bronze; 32D - Matte Stainless Steel; GYP - Primed for Painting; CLR - Clear Anodized; CAL - Cast Aluminum

Thresholds and Weatherstripping

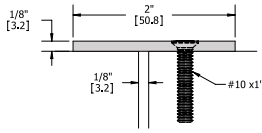

Description	Finish	Without Insert		With Insert			Comparison Numbers
		Insert	N	S	V	W	
835S Astragal - Bar Type 10' Max length	MIL	6.20					NGP: 139 Pemko: 357 ANSI: ROY636
	DBA	7.90					
	GLD	8.90					
	GYP	6.40					
	32D	28.30					

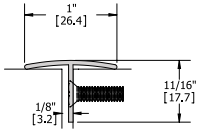

836S Astragal T-Type	MIL	5.30					NGP: 176 Pemko: 359 ANSI: R3Y616
	DBA	7.10					
	GLD	7.60					

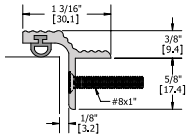

837S Astragal T-Type	MIL		7.00	7.30	6.00	6.00	NGP: 158 Pemko: 355 ANSI: R3Y714
	DBA		9.40	9.50	8.20	8.20	
	GLD		9.80	9.80	8.70	8.70	

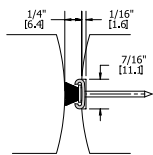

838S Meeting Stile *insert not replaceable	MIL					4.10	NGP: 136P Pemko: A372P ANSI: R3F725
---	-----	--	--	--	--	------	---

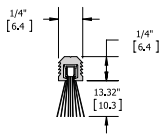

Description	Finish	B	N	With Insert			Comparison Numbers
				S	V	W	
839S Kerf-in Mortise Astragal Sweep *Brush insert	MIL	4.50					Pemko: 5041AP ANSI: R3A425

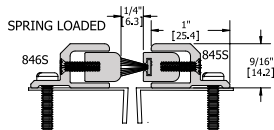

Description	Finish	Without Insert		With Insert			Comparison Numbers
		Insert	N	S	V	W	
845S Astragal - Surface Applied Adjustable Spring Loaded w/ Pile Must also order 846 for a set.	MIL						NGP: 140P Pemko: 351P ANSI: R3F834
	DBA					16.20	
	GLD					19.40	
						21.00	

846S Astragal - Surface Applied Adjustable Spring Loaded Must also order 845 for a set	MIL	15.80					NGP: 140P Pemko: 351P ANSI: R3F834
	DBA	18.90					
	GLD	20.80					

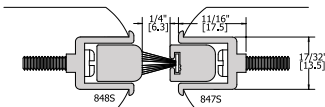

847S Astragal - Mortise Type Adjustable Spring Loaded w/ Pile Must also order 848 for a set	MIL						NGP: 144P Pemko: 354P ANSI: R3F824
	DBA					15.30	
	GLD					19.10	
						21.20	

848S Astragal - Mortise Type Adjustable Spring Loaded Must also order 847 for a set	MIL	15.40					NGP: 144P Pemko: 354P ANSI: R3F824
	DBA	19.30					
	GLD	21.50					

Thresholds and Weatherstripping

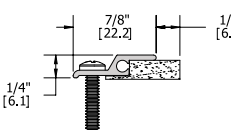
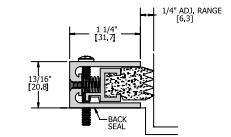
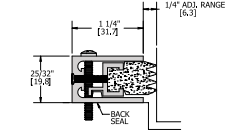
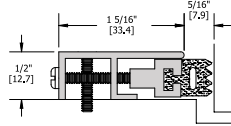
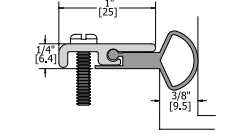
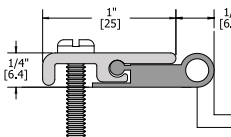
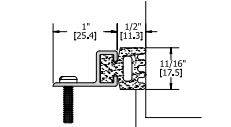
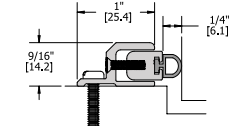
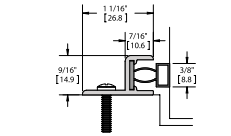
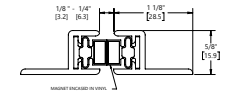

Description	Finish	Without Insert		With Insert			Comparison Numbers
		Insert	N	S	V	W	
849S Adjustable Astragals Magnetic 80" to 96" Doors only (sold as set ONLY)	MIL DBA GLD	40.80 49.00 53.00					NGP: 149MA ANSI: R3L835
859S Magnetic Weatherstrip	MIL DBA GLD	8.70 10.80 11.20					NGP: 159M Pemko: 2815 ANSI: R3L264
860S Jamb Weatherstrip Adjustable	MIL DBA GLD	15.70 18.80 19.90	16.20 19.40 20.50	15.20 18.20 19.30	15.20 18.20 19.30		NGP: 106 Pemko: 351 ANSI: R3B264
861S Jamb Weatherstrip	MIL DBA GLD	7.90 9.10 9.90					NGP: 108 Pemko: 285 ANSI: R3C164
862S Jamb Weatherstrip	CLR DBA GLD	6.10 7.00 7.70					NGP: 137 Pemko: 319 ANSI: R3B164
863S Jamb Weatherstrip	CLR DBA GLD	6.80 8.00 8.30					ANSI: R3B164
864S Jamb Weatherstrip Adjustable	CLR DBA GLD	11.30 14.10 14.60					NGP: 107 Pemko: 379 ANSI: R3C164
865S Jamb Weatherstrip Adjustable	MIL DBA GLD	15.50 18.20 19.20					NGP: 103N Pemko: 350 ANSI: R3C264
866S Jamb Weatherstrip Adjustable Spring Loaded	MIL DBA GLD	16.20 19.20 20.40					NGP: 303N ANSI: R3C264
870S Jamb Weatherstrip	CLR DBA GLD 32D	3.80 4.90 5.80 24.20					NGP: 127 NPG: 120SS Pemko: 305 ANSI: ROC164

Price Code: POA - Price on Application
 Insert Codes: V - Vinyl; N - Neoprene, EDPM, or TPE; S - Silicone; W - Pile; B - Nylon Brush; F - Vinyl Fin
 Finish Codes: MIL - Mill Finished Aluminum; DBA - Dark Bronze Anodized; GLD - Gold Anodized; MIB - Mill Finished Bronze; 32D - Matte Stainless Steel; GYP - Primed for Painting; CLR - Clear Anodized; CAL - Cast Aluminum

Thresholds and Weatherstripping

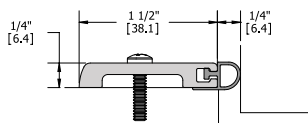
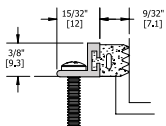
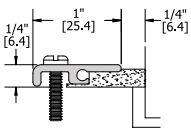
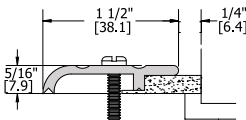
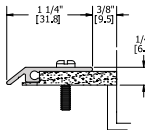
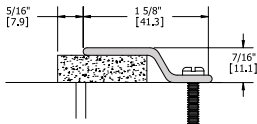
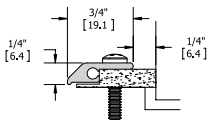
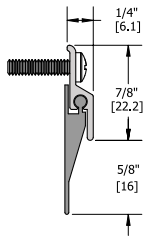
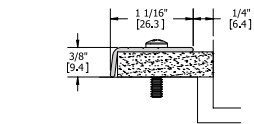

Description	Finish	Without Insert		With Insert			Comparison Numbers
		Insert	N	S	V	W	
871S Jamb Weatherstrip	MIL		5.40				NGP: 132N
	DBA		6.90				Pemko: 368
	GLD		7.10				ANSI: R3C164
872S Door Bottom Sweep or Astragal Order 2 for set *32D is supplied with gray insert and differ from black gasket supplied with other finishes	CLR		5.40				NGP: 115
	DBA		6.30				Pemko: 305
	GLD		7.30				ANSI: ROB634
	32D*		25.50				
873S Jamb Weatherstrip	MIL		4.10				NGP: 110
	DBA		5.30				Pemko: 332
	GLD		6.10				ANSI: R3C164
874S Astragal/Jamb Weatherstrip	MIL		6.20				NGP: 109
	DBA		8.40				Pemko: 375
	GLD		9.10				ANSI: R3C164
	32D		32.30				
875S Jamb Weatherstrip	CLR		4.90	6.60			NGP: 130
	DBA		6.10	8.20			Pemko: 315
	GLD		6.80	8.90			ANSI: ROY134
877S Jamb Weatherstrip	MIL		5.80				ANSI: R3C164
	DBA		7.20				NGP: 133
	GLD		8.10				
878S Jamb Weatherstrip	CLR		4.60				NGP: 134
	DBA		5.30				Pemko: 312
	GLD		5.50				ANSI: R3C164
880S Jamb Weatherstrip	MIL		4.30				NGP: 165
	DBA		5.80				Pemko: 296
	GLD		6.20				ANSI: R3C164
881S Jamb Weatherstrip Hardware Compatible	MIL		6.60	7.10	5.90	7.60	NGP: 700E
	DBA		8.30	8.90	7.30	9.40	Pemko: 290
	GLD		9.20	9.90	8.20	10.60	ANSI: R3Y164

Thresholds and Weatherstripping

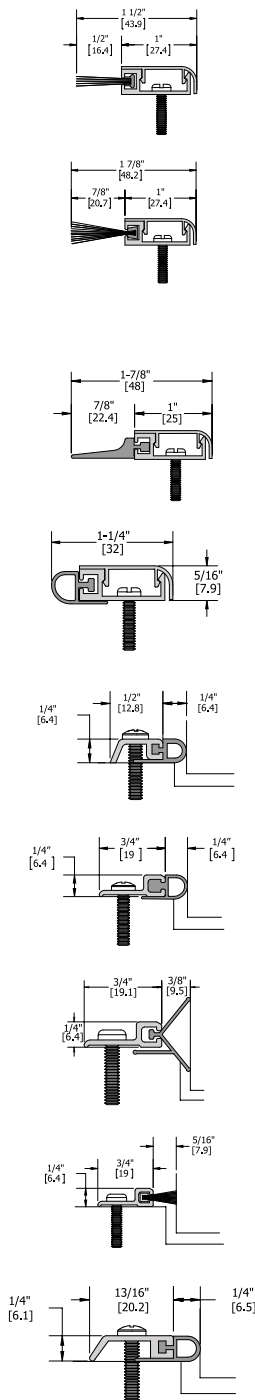

Description	Finish	B	N	With Insert			Comparison Numbers
				S	V	W	
882S Door Sweep, Astragal or Jamb Weatherstrip with Snap Cover	CLR	6.40					NGP: 675
	DBA	8.90					Pemko: 29326
	GLD	9.50					ANSI: R3Y164
883S Door Sweep with Snap Cover	CLR	7.60					NGP: 678
	DBA	9.80					Pemko: 293100
	GLD	10.60					ANSI: R3Y164
884S Astragal, Door Sweep with Snap Cover	CLR				6.10		ANSI: R3Y164
	DBA				7.60		
	GLD				8.10		
885S Jamb Weatherstrip with Snap Cover	CLR	5.70	6.40	6.90	5.70	6.30	NGP: 170
	DBA	8.30	8.90	9.60	8.30	8.80	Pemko: 29310
	GLD	8.80	9.50	10.00	8.80	9.30	ANSI: R3Y164
890S Jamb Weatherstrip	MIL		2.30	2.90	1.60		NGP: 152
	DBA		3.50	4.50	2.70		Pemko: 316
	GLD		3.60	4.60	2.80		ANSI: R3Y164
891S Jamb Weatherstrip	MIL	1.60	2.30	2.90	1.60		NGP: 160
	DBA	2.70	3.50	4.50	2.70		Pemko: 303
	GLD	2.80	3.60	4.60	2.80		ANSI: R3Y164
892S Jamb Weatherstrip Insert: Gray Neoprene	MIL		2.50				Pemko: 294
	DBA		3.90				ANSI: R3B164
	GLD		4.00				
893S Jamb Weatherstrip	MIL					2.70	NGP: A605
	DBA					4.10	Pemko: 309
	GLD					4.20	ANSI: R3F164
896S Jamb Weatherstrip	MIL		2.30	2.90	1.60		NGP: 156
	DBA		3.50	4.50	2.70		Pemko: 297
	GLD		3.60	4.60	2.80		ANSI: R3Y164

Price Code: POA - Price on Application
 Insert Codes: V - Vinyl; N - Neoprene, EDPM, or TPE; S - Silicone; W - Pile; B - Nylon Brush; F - Vinyl Fin
 Finish Codes: MIL - Mill Finished Aluminum; DBA - Dark Bronze Anodized; GLD - Gold Anodized; MIB - Mill Finished Bronze; 32D - Matte Stainless Steel; GYP - Primed for Painting; CLR - Clear Anodized; CAL - Cast Aluminum

Thresholds and Weatherstripping

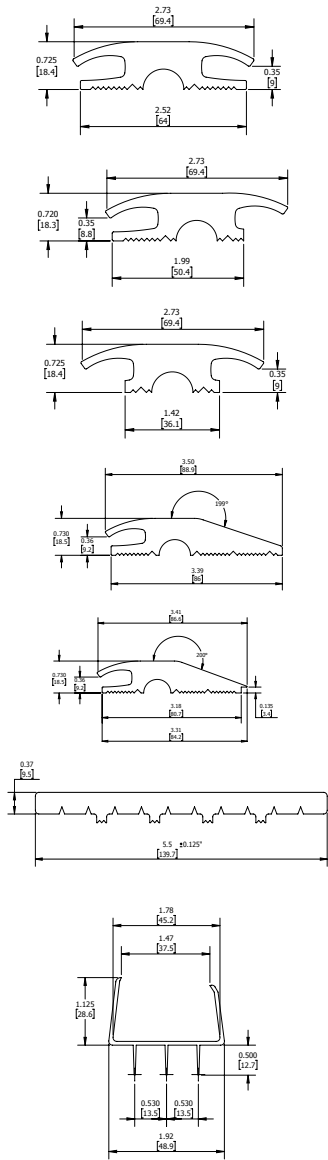

Description	Size	Finish	Without Insert	Comparison Numbers
900S Vinyl Threshold Carpet to Carpet	36" 48"	Black Black	36.45 48.60	NGP: 401 Pemko: EV232BL
901S Vinyl Threshold Carpet to Tile	36" 48"	Black Black	38.45 51.25	NGP: 402 Pemko: EV2325BL
902S Vinyl Threshold Tile to Tile	36" 48"	Black Black	36.45 48.60	NGP: 407 Pemko: EV2326BL
903S Vinyl Threshold Carpet	36" 48"	Black Black	38.45 51.25	NGP: 398 Pemko: EV2320BL
904S Vinyl Threshold Carpet to Tile	36" 48"	Black Black	39.09 52.12	NGP: 399 Pemko: EV2322BL
905S Vinyl Threshold Transition	36" 48"	Black Black	49.80 66.40	NGP: 400
906S Door Bottom - Shoe Triple Fin	36" 48"	Brown Brown	23.10 30.80	NGP: 344 Pemko: 2170

Thresholds

Thresholds

400S 36" DBA VINYL	.057047
401S 36" DBA	.069704
401S 36" MIL	.051003
401S 72" SCA	.134225
402S 36" MIL	.051415
403S 36" US3	.055207
403S 36" US32D	.031227
403S 36" US9	.073874
403S 36" DBA	.054097
403S 36" LBA	.002372
403S 36" MIL	051829
403S 36" SCA	.007258
403S 48" US10B	.046127
403S 48" US3	.055216
403S 48" US32D	.004453
403S 48" MIL	.051420
403S 72" MIL	.051422
403S 72" US32D	.037064
403S 72" DBA	.054098
404S 36" US3	.066258
404S 36" US32D	.029919
404S 36" DBA	.053510
404S 36" MIL	051423
404S 48" US32D	.029920
404S 48" DBA	.058788
404S 48" MIL	051424
404S 72" US3	.066324
404S 72" US32D	.031159
404S 72" MIL	051426
404S 96" US32D	.079828
404S 96" MIL	.053016
406S 36" MIL	.051431
406S 72" GLD	.025728
406S 72" MIL	.051434
407S 36" DBA	.069696
407S 36" GLD	.022070
407S 36" MIL	.051435
407S 48" MIL	.051436
407S 72" GLD	.082336
407S 96" MIL	.077245
410S 36" DBA	.058997
410S 36" MIB	.063300
410S 36" MIL	051009
410S 48" DBA	.061578
410S 48" MIL	.051011
410S 72" DBA	.061579

Thresholds and Weatherstripping - Stock Numbers

Thresholds

410S 72" GLD	.038946
410S 72" MIB	.059484
410S 72" MIL	051013
410S 96" MIL	.056399
411S 36" BLA	.081343
411S 36" MIL	.051015
412S 36" US32D	.030454
412S 36" US32D NH	.001776
412S 36" DBA	053693
412S 36" GLD	.053738
412S 36" MIL	051021
412S 36" MIL WSPA	.091344
412S 36" SCA	.055441
412S 36" SCB	.017067
412S 48" US10B	.040516
412S 48" US32D	.033440
412S 48" DBA	.054063
412S 48" MIL	051023
412S 48" SCA	.074258
412S 72" US32D	.030457
412S 72" DBA	.053067
412S 72" GLD	.063301
412S 72" MIL	051025
412S 72" SCA	.060167
412S 72" SCB	.129267
412S 96" US32D	.090042
412S 96" GLD	.055211
412S 96" MIL	.052764
413S 36" US3	.052029
413S 36" US32D	.025717
413S 36" DBA	.015900
413S 36" MIL	051027
413S 48" US32D	.039101
413S 48" DBA	.065227
413S 48" MIL	051029
413S 72" US3	.052031
413S 72" US32D	.023441
413S 72" DBA	.054295
413S 72" MIL	051031
413S 96" US3	.052032
413S 96" MIL	.054157
414S 36" DBA	.000955
414S 36" MIL	.051451
414S 72" DBA	.117097
415S 36" US3	.047179
415S 36" DBA	.057305



Thresholds

415S 36" MIL	051033
415S 36" SCA.071687
415S 48" DBA023733
415S 48" MIL	051035
415S 48" SCA.066494
415S 72" US9074543
415S 72" MIL	051037
416S 36" DBA060723
416S 36" GLD081665
416S 36" MIL051051
416S 36" SCA.090216
416S 48" DBA063049
416S 48" MIL051053
416S 72" EBRP061273
416S 72" DBA016047
416S 72" MIL051055
416S 96" MIL052960
417S 36" US9066359
417S 36" DBA059553
417S 36" MIL	056494
417S 36" SCA.058889
417S 48" DBA024802
417S 48" MIL057023
417S 72" DBA075007
417S 72" MIL057024
417S 96" MIL060172
418S 36" US10B031199
418S 36" MIL	056495
418S 48" MIL062685
418S 72" US3048580
418S 72" MIL059607
418S 96" MIL066488
419S 36" MIL056496
419S 48" DBA108927
420S 36" MIL061332
420S 48" MIL030506
420S 72" MIL073999
421S 36" MIL	059872
421S 72" DBA068739
421S 72" MIL064918
422S 36" MIL064486
422S 48" MIL085099
422S 72" MIL064485
423S 72" MIL082531
424S 36" MIL066013
424S 48" MIL095418

Thresholds

426S 36" DBA002015
426S 36" MIL	061695
426S 48" MIL077225
426S 72" MIL	064254
426S 96" MIL064253
427S 36" MIL061190
427S 48" MIL061133
427S 72" MIL061125
427S 96" DBA134871
428S 36" MIL	069001
428S 48" MIL030450
428S 72" DBA066973
428S 72" MIL	059870
428S 96" DBA021942
430S 36" MIL062855
430S 48" MIL088799
430S 72" DBA095313
430S 72" MIL070161
430S 72" SCA.084515
431S 36" DBA070641
431S 36" GLD048973
431S 36" MIB.053331
431S 36" MIL051455
431S 48" DBA078959
431S 48" MIL051456
431S 72" DBA055522
431S 72" GLD066756
431S 72" MIB.067194
431S 72" MIL051458
431S 96" MIL096450
432S 36" BLA095183
432S 36" DBA059786
432S 36" MIL053172
432S 48" US10B095706
432S 48" MIL062853
432S 72" US10B095703
432S 72" BLA095185
432S 72" DBA057872
432S 72" MIL053822
433S 36" DBA054825
433S 36" GLD058459
433S 36" MIL051463
433S 48" MIL051464
433S 72" DBA063629
433S 72" GLD062034
433S 72" MIL051466

Thresholds

Thresholds

434S 36" MIL	.052038
434S 36" MIL NEOPRENE	.026655
434S 36" MIL SILICONE	.031084
434S 36" MIL VINYL	.056329
435S 36" GLD	106702
435S 36" MIL NEOPRENE	.028335
435S 72" MIL NEOPRENE	.080550
435S 36" MIL VINYL	.056497
435S 72" MIL VINYL	.056644
436S 36" DBA	.038944
436S 36" MIL	.027686
436S 48" DBA	.093704
436S 48" GLD	.089938
436S 48" MIL	.023620
436S 72" DBA	.075861
436S 72" MIL	.032198
436S 96" MIL	.054106
438S 36" DBA	.046790
438S 36" GLD	.048227
438S 36" MIL	.013799
438S 72" DBA	.045585
438S 72" GLD	.078454
440S 72" GLD	140089
442S 36" MIL	.065007
442S 36" SCA	.071626
442S 48" MIL	.063483
442S 72" MIL	.086139
443S 36" MIL	.065346
444S 36" MIL	.089632
444S 48" MIL	.094554
445S 72" MIL	.051471
445S 96" MIL	.062261
448S 36" DBA	117092
448S 36" MIL	.038781
448S 48" MIL	111712
448S 72" DBA	130861
448S 72" MIL	.037440
448S 96" MIL	.066757
448S 96" MIL NH	139421
450S 36" GLD	131762
450S 48" MIL	.051473
450S 72" GLD	.060490
450S 96" MIL	.012758
451S 48" MIL	.098765
451S 72" MIL	.073016
452S 72" MIL	.092409

Thresholds and Weatherstripping - Stock Numbers

Thresholds

455S 72" GLD	.031990
455S 96" MIL	.070042
460S 72" MIL	.051483
460S 96" MIL	.075035
465S 72" MIL	.051488
470S 36" MIL	.051492
470S 72" GLD	.062275
470S 72" MIL	.051494
477S 48" DBA	144656
477S 36" BLA NEOPRENE	.072390
477S 48" MIL NEOPRENE	.025060
477S 36" MIL VINYL	.089975
477S 48" DBA VINYL	.021980
477S 48" MIL VINYL	.017278
477S 72" MIL VINYL	.094703
478S 36" MIL	144368
478S 36" GLD SILICONE	.088825
480S 36" MIL	.051495
480S 48" DBA	101556
480S 48" MIL	.051496
480S 72" MIL	.062474
481S 36" MIL NEOPRENE	.055791
481S 48" MIL NEOPRENE	.076605
481S 72" MIL NEOPRENE	.055980
481S 36" MIL SILICONE	.072476
481S 36" DBA VINYL	.006126
481S 36" MIL VINYL	.056073
481S 48" DBA VINYL	.063958
481S 48" MIL VINYL	.051940
481S 72" DBA VINYL	.050881
481S 72" MIL VINYL	.054902
484S 36" DBA	.079872
484S 36" MIL	.051516
484S 48" DBA	.050841
484S 48" MIL	.051517
484S 72" DBA	.050882
484S 72" MIL	.051519
484S 96" MIL	.088497
492S 36" MIL	.032347
504S 36" MIL	.051534
504S 72" MIL	.056390
505S 36" MIL	.051542
506S 36" BLA	.052729
506S 36" MIL	.054719
506S 72" BLA	.016492
508S 36" DBA	.020721



Thresholds

508S 36" MIL034315
508S 96" DBA110506
515S 36" MIL PILE026369
516S 36" MIL124421
516S 72" MIL128226
516S 36" MIL NEOPRENE034721
516S 36" MIL SILICONE064022
516S 36" MIL VINYL033033
516S 72" MIL VINYL034574
517S 72" MIL NEOPRENE013993
517S 72" GLD VINYL133469
518S 48" GLD VINYL055794
518S 72" GLD VINYL138533
520S 36" MIL033055
520S 72" MIL051539
520S 36" US10B NEOPRENE029314
520S 36" US10B NEOPRENE NH029318
520S 36" MIL NEOPRENE054613
520S 48" MIL NEOPRENE056182
520S 72" US10B NEOPRENE029312
520S 72" US10B NEOPRENE NH029315
520S 72" MIL NEOPRENE055935
520S 72" SCA NEOPRENE046841
520S 36" US32D SILICONE107239
520S 36" MIL SILICONE064059
520S 48" MIL SILICONE080333
520S 72" US32D SILICONE053973
520S 72" MIL SILICONE064061
520S 36" DBA VINYL054218
520S 36" MIL VINYL051061
520S 36" SCA VINYL001850
520S 36" SCB VINYL120773
520S 48" DBA VINYL079046
520S 48" MIL VINYL051062
520S 72" DBA VINYL054454
520S 72" MIL VINYL051066
520S 72" SCA VINYL017347
520S 72" SCB VINYL120774
520S 96" MIL VINYL057442
532S 36" MIL051548
532S 36" DBA NEOPRENE071073
532S 36" MIL SILICONE073124
532S 72" MIL SILICONE054919
532S 36" US32D VINYL107563
532S 36" MIL VINYL051552
532S 48" MIL VINYL051830

Thresholds

532S 72" VINYL062282
532S 72" MIL VINYL051555
532S 96" MIL VINYL053837
541S 36" 10B NEOPRENE078694
541S 36" MIL NEOPRENE054211
541S 48" 10B NEOPRENE078680
541S 48" DBA NEOPRENE000896
541S 48" MIL NEOPRENE054059
541S 72" MIL NEOPRENE054060
541S 36" CLR VINYL095393
541S 36" DBA VINYL053658
541S 36" MIL VINYL051068
541S 48" CLR VINYL095382
541S 48" MIL VINYL051070
541S 72" MIL VINYL051074
552S 36" 32D VINYL108523
552S 36" MIL VINYL051568
552S 48" MIL VINYL051569
552S 96" MIL VINYL057479
560S 36" MIL VINYL051076
560S 36" MIL VINYL NH008752
560S 48" MIL VINYL051078
560S 48" MIL VINYL NH012801
560S 72" MIL VINYL051082
560S 72" MIL VINYL NH009223
565S 36" SCA NEOPRENE145379
565S 48" MIL NEOPRENE008593
565S 48" SCA NEOPRENE145380
565S 36" MIL VINYL057025
565S 36" SCA VINYL137796
565S 48" SCA VINYL137797
566S 72" MIL VINYL017021
572S 36" DBA025594
572S 72" MIL030908
575S 36" DBA VINYL052358
575S 36" MIL VINYL051084
575S 48" MIL VINYL051086
575S 72" MIL VINYL051090
575S 96" MIL VINYL052982
580S 36" MIL VINYL021041
599S 48" DBA VINYL134849
600S 36" MIL051584
600S 48" MIL022772
603S 36" US10B076299
603S 36" US3104453
603S 36" DBA078404

Thresholds

Thresholds

603S 36" MIL	.051590
603S 48" MIL	.051591
603S 72" DBA	.098807
604S 36" DBA	.053623
604S 36" MIL	.051592
604S 36" SCA	.071847
604S 48" DBA	.074415
604S 48" MIL	.051593
604S 72" US3	.048329
604S 72" DBA	.068183
604S 72" MIL	.063979
604S 72" SCA	.094430
604S 96" MIL	.062565
608S 36" US3	.051218
608S 36" MIL	.006863
608S 48" MIL	.106173
608S 72" US3	.051219
608S 72" DBA	.083909
608S 72" MIL	.065732
608S 96" DBA	.118427
608S 96" MIL	.094020
859S 36" DBA	.021458
859S 36" MIL	.031358

Press-On Weatherstripping

726B 204" BROWN	108247
726B 216" BROWN	.141854
726B 240" BROWN	110396
726B 252" BROWN	.103765
726B 300" BROWN	.137455
726S 204" CHARCOAL	052216
726S 216" CHARCOAL	052583
726S 240" CHARCOAL	052217
726S 252" CHARCOAL	052437
726S 260-FT CHARCOAL	.053002
726S 264" CHARCOAL	.052582
726S 300" CHARCOAL	.052737
726S 520-FT CHARCOAL	053070
726T 204" TAN	.068315
726T 240" TAN	.068312
726T 252" TAN	.139885
726W 204" WHITE	.054222
726W 216" WHITE	.054799
726W 240" WHITE	.054223
726W 252" WHITE	.054224
726W 260-FT WHITE	.054226
726W 264" WHITE	.060177

Thresholds and Weatherstripping - Stock Numbers

Press-On Weatherstripping

726W 300" WHITE	.054225
726W 520-FT WHITE	.054227
728S 204" CHARCOAL	.048276
728S 216" CHARCOAL	.051094
728S 240" CHARCOAL	.049528
728S 252" CHARCOAL	.061881
728S 260-FT CHARCOAL	.047334
728S 264" CHARCOAL	.061882
728S 300" CHARCOAL	.064421
728S 520-FT CHARCOAL	.002601
728W 204" WHITE	.050505
728W 240" WHITE	.056601
728W 300" WHITE	.074080
729B 204" BROWN	.045920
729B 216" BROWN	.055100
729B 252" BROWN	.046133
729B 300" BROWN	.079208
729S 204" BLACK	.015885
729S 252" BLACK	.068776
729S 300" BLACK	.068777
729T 204" TAN	.082927
729T 240" TAN	.103218
729T 252" TAN	.021429
729T 300" TAN	.082930
729W 204" WHITE	.024763
729W 252" WHITE	.027429
729W 300" WHITE	.027430
736S 204" CHARCOAL	089698
736S 216" CHARCOAL	.093251
736S 240" CHARCOAL	096054
736S 252" CHARCOAL	.096055
736S 260-FT CHARCOAL	.095015
736S 264" CHARCOAL	.098132
736S 300" CHARCOAL	.090886
736S 520-FT CHARCOAL	.095014
736T 204" TAN	.018642
736T 252" TAN	.018641
736W 204" WHITE	.096056
736W 216" WHITE	.098957
736W 240" WHITE	.096057
736W 252" WHITE	.096088
736W 260-FT WHITE	.095017
736W 264" WHITE	.046032
736W 300" WHITE	.096033
736W 520-FT WHITE	.095016
737S 204" CHARCOAL	.035450



Press-On Weatherstripping

737S 216" CHARCOAL035449
737S 240" CHARCOAL035447
737S 252" CHARCOAL035422
737S 260-FT CHARCOAL035383
737S 264" CHARCOAL035393
737S 300" CHARCOAL035392
737S 520-FT CHARCOAL035382
737W 204" WHITE035381
737W 216" WHITE035380
737W 240" WHITE035358
737W 252" WHITE035346
737W 260" WHITE035342
737W 264" WHITE035345
737W 300" WHITE035344
737W 520' WHITE035325
719B 36" x 84" BROWN082481
719B 48" x 84" BROWN085139
719B 72" x 84" BROWN082483
719B 84" BROWN082511
719B 84" x 84" BROWN082484
719B 96" BROWN082514
719B 108" BROWN082515
719G 36" x 84" GREY082498
719G 48" x 84" GREY085140
719G 72" x 84" GREY082502
719G 84" GREY082527
719G 84" x 84" GREY082503
719G 96" GREY082530
719G 108" GREY082532
719S 36" x 84" CHARCOAL082491
719S 48" X 84" CHARCOAL085084
719S 72" x 84" CHARCOAL082494
719S 84" CHARCOAL082522
719S 84" x 84" CHARCOAL082496
719S 96" CHARCOAL082524
719S 108" CHARCOAL082525
719T 36" x 84" TAN082504
719T 48" x 84" TAN085141
719T 72" x 84" TAN082507
719T 84" TAN082534
719T 84" x 84" TAN082506
719T 96" TAN082535
719T 108" TAN082538
719W 36" x 84" WHITE082485
719W 48" x 84" WHITE085144
719W 72" x 84" WHITE082487

Press-On Weatherstripping

719W 84" WHITE082517
719W 84" x 84" WHITE082490
719W 96" WHITE082518
719W 108" WHITE082519
720B 36" x 84" BROWN FLEX INTUMECENT SINGLE WING107435
720B 48" X 84" BROWN FLEX INTUMESCENT SINGLE WING107433
720B 72" X 84" BROWN FLEX INTUMESCENT SINGLE WING107434
720B 84" x 84" BROWN FLEX INTUMECENT SINGLE WING112842
720G 36" x 84" GREY FLEX INTUMECENT SINGLE WING112844
720G 84" x 84" GREY FLEX INTUMECENT SINGLE WING112846
720S 36" x 84" CHARCOAL FLEX INTUM SINGLE WING105952
720S 48" X 84" CHARCOAL FLEX INTUM SINGLE WING105953
720S 72" X 84" CHARCOAL FLEX INTUM SINGLE WING105954
720S 84" x 84" CHARCOAL FLEX INTUM SINGLE WING105955
720S 96" X 96" CHARCOAL FLEX INTUM SINGLE WING118211
720T 36" x 84" TAN FLEX INTUMECENT SINGLE WING112851
720T 84" x 84" TAN FLEX INTUMECENT SINGLE WING112853
720W 36" x 84" WHITE FLEX INTUMECENT SINGLE WING112855
720W 48" x 84" WHITE FLEX INTUMECENT SINGLE WING136649
720W 72" x 84" WHITE FLEX INTUMECENT SINGLE WING136650
720W 84" x 84" WHITE FLEX INTUMECENT SINGLE WING112857
721B 36" x 84" BROWN029485
721B 48" x 84" BROWN029488
721B 72" x 84" BROWN029491
721B 84" BROWN047510
721B 84" x 84" BROWN143529
721B 96" BROWN047517
721B 108" BROWN047518
721G 36" x 84" GREY013457
721G 48" x 84" GREY108615
721G 72" x 84" GREY089314
721G 84" GREY087654
721G 96" GREY087652
721S 36" x 84" BLACK029493
721S 48" x 84" BLACK029494
721S 72" x 84" BLACK029496
721S 84" BLACK081187
721S 84" x 84" BLACK000002
721S 96" BLACK081186
721S 96" x 96" BLACK142009
721S 108" BLACK081735
721T 36" x 84" TAN029513
721T 48" x 84" TAN029515
721T 72" x 84" TAN029518
721T 84" TAN097047
721T 96" TAN062335

Press-On Weatherstripping

721T 108" TAN123704
721W 36" x 84" WHITE029520
721W 48" x 84" WHITE029521
721W 72" x 84" WHITE029523
721W 84" WHITE059248
721W 84" x 84" WHITE074859
721W 96" WHITE059123
721W 108" WHITE059122
722B 36" x 84" BROWN086961
722B 48" x 84" BROWN086929
722B 72" x 84" BROWN086793
722B 84" x 84" BROWN086791
722B 96" x 96" BROWN086780
722S 36" x 84" CHARCOAL087124
722S 48" x 84" CHARCOAL087063
722S 72" x 84" CHARCOAL087055
722S 84" x 84" CHARCOAL087054
722S 96" x 96" CHARCOAL087005
722T 36" x 84" TAN086777
722T 48" x 84" TAN086775
722T 72" x 84" TAN086754
722T 84" x 84" TAN086752
722T 96" x 96" TAN086745
722W 36" x 84" WHITE086996
722W 48" x 84" WHITE086993
722W 72" x 84" WHITE086972
722W 84" x 84" WHITE086969
722W 96" x 96" WHITE086966
724B 36" x 84" BROWN047696
724B 48" x 84" BROWN138515
724B 72" x 84" BROWN086997
724B 84" BROWN047527
724B 96" BROWN047528
724B 108" BROWN047530
724G 36" X 84" GREY096307
724G 48" X 84" GREY047045
724G 72" X 84" GREY096358
724G 84" GREY089146
724G 96" GREY093403
724S 36" x 84" CHARCOAL089572
724S 84" CHARCOAL061283
724S 84" x 84" CHARCOAL109589
724S 96" CHARCOAL000241
724S 108" CHARCOAL014723
724T 84" TAN051666
724T 96" TAN051682

Press-On Weatherstripping

724W 84" WHITE033732
724W 96" WHITE107109
727S 36" x 84" CHARCOAL051140
727S 72" x 84" CHARCOAL054064
727S 84" CHARCOAL051139
727S 96" CHARCOAL053646
734S 36" X 84" BROWN026246
734B 72" X 84" BROWN026201
734B 84" BROWN026247
734B 96" BROWN026244
734B 96" X 96" BROWN026200
734B 108" BROWN026211
734G 36" X 84" GREY026193
734G 72" X 84" GREY026189
734G 84" GREY026198
734G 96" GREY026197
734G 96" X 96" GREY026188
734G 108" GREY026194
734S 36" X 84" BLACK026327
734S 72" X 84" BLACK026322
734S 84" BLACK026357
734S 96" BLACK026330
734S 96" X 96" BLACK026321
734S 108" BLACK026329
734T 36" X 84" TAN026171
734T 72" X 84" TAN026145
734T 84" TAN026187
734T 96" X 96" TAN026142
734T 108" TAN026172
725S 84" NEOPRENE060206
725S 96" NEOPRENE060504
738S 204" CHARCOAL164037
738S 240" CHARCOAL164039

Auto-Door Bottoms

730S 36" MIL NEOPRENE072966
730S 36" MIL NEOPRENE051857
730S 42" MIL NEOPRENE054841
730S 48" MIL NEOPRENE051390
730S 36" MIL SILICONE046487
730S 42" MIL SILICONE034849
730S 48" MIL SILICONE087236
740S 36" NEOPRENE076463
740S 36" CLR NEOPRENE055452
740S 36" DBA NEOPRENE052434
740S 36" GLD NEOPRENE057701
740S 42" CLR NEOPRENE085096



Auto-Door Bottoms

740S 42" DBA NEOPRENE059866
740S 42" GLD NEOPRENE074922
740S 48" NEOPRENE080708
740S 48" CLR NEOPRENE087513
740S 48" DBA NEOPRENE052435
740S 48" GLD NEOPRENE066177
740S 36" CLR SILICONE068926
740S 42" US32D SILICONE017715
740S 42" CLR SILICONE069035
740S 48" US32D SILICONE027269
740S 48" CLR SILICONE068927
742S 36" MIL NEOPRENE054065
742S 42" MIL NEOPRENE061380
742S 48" MIL NEOPRENE000739
742S 36" MIL VINYL053529
742S 42" MIL VINYL058976
742S 48" MIL VINYL053865
743S 36" MIL NEOPRENE052842
743S 42" MIL NEOPRENE056039
743S 48" MIL NEOPRENE053078
747S 36" CLR NEOPRENE053563
747S 36" DBA NEOPRENE053781
747S 36" GLD NEOPRENE016063
747S 42" CLR NEOPRENE087210
747S 42" DBA NEOPRENE057863
747S 48" CLR NEOPRENE084717
747S 48" DBA NEOPRENE053735
747S 48" GLD NEOPRENE058145

Door Bottoms & Sweeps

750S 36" US10B NEOPRENE010703
750S 36" US32D NEOPRENE023937
750S 36" CLR NEOPRENE053564
750S 36" DBA NEOPRENE053069
750S 36" GLD NEOPRENE052905
750S 42" US32D NEOPRENE037601
750S 42" CLR NEOPRENE053565
750S 42" DBA NEOPRENE064869
750S 42" GLD NEOPRENE071669
750S 48" US3 NEOPRENE054200
750S 48" US32D NEOPRENE076771
750S 48" CLR NEOPRENE057658
750S 48" DBA NEOPRENE053013
750S 48" GLD NEOPRENE058143
750S 36" US32D SILICONE040289
750S 36" CLR SILICONE043444
750S 36" DBA SILICONE006348

Door Bottoms & Sweeps

750S 42" US32D SILICONE095058
750S 48" US32D SILICONE055864
750S 48" CLR SILICONE070213
752S 36" DBA VINYL015097
752S 36" GLD VINYL057972
752S 36" MIL VINYL061376
752S 42" DBA VINYL027712
752S 42" GLD VINYL088346
752S 42" MIL VINYL067894
752S 48" DBA VINYL040624
752S 48" GLD VINYL039647
752S 48" MIL VINYL007958
752S 48" MIL VINYL TEK078452
753S 36" DBA NEOPRENE061082
753S 36" GLD NEOPRENE077227
753S 36" MIL NEOPRENE051337
753S 42" MIL NEOPRENE067110
753S 48" MIL NEOPRENE051338
754S 36" CLR NEOPRENE083440
754S 36" DBA NEOPRENE052427
754S 42" CLR NEOPRENE083370
754S 42" DBA NEOPRENE005796
754S 48" CLR NEOPRENE083372
756S 36" DBA VINYL054378
756S 36" GLD VINYL058375
756S 36" MIL VINYL052010
756S 42" MIL VINYL061396
756S 48" DBA VINYL055418
756S 48" MIL VINYL052011
759S 36" DBA VINYL027134
759S 36" GLD VINYL066852
759S 36" MIL VINYL060170
759S 42" DBA VINYL027167
759S 42" GLD VINYL104864
759S 42" MIL VINYL036002
759S 48" DBA VINYL066858
759S 48" GLD VINYL093917
759S 48" MIL VINYL032110
770S 36" MIL051349
770S 36" DBA BRUSH065591
770S 36" GLD BRUSH040794
770S 36" MIL BRUSH061333
770S 42" DBA BRUSH065066
770S 42" MIL BRUSH033809
770S 48" DBA BRUSH046311
770S 48" MIL BRUSH084855

Door Bottoms & Sweeps

770S 36" VINYL075567
770S 36" DBA VINYL057644
770S 36" GLD VINYL055454
770S 36" MIL VINYL054681
770S 36" WHP VINYL048479
770S 42" GLD VINYL016288
770S 42" MIL VINYL067931
770S 48" DBA VINYL070746
770S 48" GLD VINYL038496
770S 48" MIL VINYL063484
774S 36" NEOPRENE062304
774S 36" DBA NEOPRENE064438
774S 36" MIL NEOPRENE051357
774S 48" MIL NEOPRENE051358
774S 36" MIL VINYL051359
774S 48" DBA VINYL061377
774S 48" MIL VINYL051360
776S 42" CLR NEOPRENE094490
777S 36" DBA NEOPRENE035004
777S 36" MIL NEOPRENE027008
777S 36" DBA VINYL054611
777S 36" MIL VINYL051363
778S 36" DBA NEOPRENE015955
778S 36" MIL NEOPRENE015977
778S 48" DBA NEOPRENE058254
778S 36" VINYL062294
778S 36" DBA VINYL053780
778S 36" GLD VINYL055193
778S 36" MIL VINYL051365
778S 42" DBA VINYL054862
778S 42" GLD VINYL062642
778S 42" MIL VINYL059750
778S 48" VINYL062641
778S 48" DBA VINYL054896
778S 48" MIL VINYL051366
779S 36" DBA NEOPRENE022886
779S 36" MIL NEOPRENE025961
779S 42" MIL NEOPRENE035071
779S 48" MIL NEOPRENE026920
779S 36" DBA VINYL057067
779S 36" GLD VINYL066396
779S 36" LBA VINYL062297
779S 36" MIL VINYL054773
779S 42" DBA VINYL021025
779S 42" GLD VINYL068655
779S 42" MIL VINYL058978

Door Bottoms & Sweeps

779S 48" DBA VINYL012715
779S 48" GLD VINYL032823
779S 48" MIL VINYL057028
780S 36" MIL NEOPRENE027342
780S 48" MIL NEOPRENE029354
780S 36" DBA VINYL059252
780S 36" GLD VINYL086619
780S 36" MIL VINYL054821
780S 42" DBA VINYL053662
780S 42" MIL VINYL065433
780S 48" DBA VINYL071002
780S 48" MIL VINYL055420
782S 36" BLA NEOPRENE081341
782S 36" DBA NEOPRENE048578
782S 36" MIL NEOPRENE032350
782S 42" GLD NEOPRENE044501
782S 48" MIL NEOPRENE032330
782S 36" VINYL005870
782S 36" DBA VINYL034338
782S 36" GLD VINYL039678
782S 36" MIL VINYL022288
782S 36" WHP VINYL106288
782S 42" DBA VINYL014122
782S 42" MIL VINYL054861
782S 48" MIL VINYL034603
783S 36" MIL115282
783S 36" GLD VINYL098197
783S 36" MIL VINYL037956
783S 48" MIL VINYL037965
787S 36" MIL NEOPRENE055268
789S 36" BLA PILE037433
789S 36" DBA PILE044987
789S 36" GLD PILE032351
789S 36" MIL PILE036194
789S 42" MIL PILE036195
789S 48" MIL PILE036617
801S 36" DBA BRUSH059618
801S 36" GLD BRUSH063248
801S 36" MIL BRUSH053035
801S 42" MIL BRUSH055943
801S 48" DBA BRUSH067890
801S 48" MIL BRUSH054070
802S 36" DBA BRUSH054610
802S 36" GLD BRUSH054786
802S 36" MIL BRUSH053194
802S 42" GLD BRUSH052346



Door Bottoms & Sweeps

802S 42" MIL BRUSH065250
802S 48" DBA BRUSH061397
802S 48" GLD BRUSH067474
802S 48" MIL BRUSH054074
806S 36" DBA BRUSH032352
806S 36" MIL BRUSH035673
806S 48" DBA BRUSH029484
806S 48" MIL BRUSH031581
872S 36" US32D NEOPRENE044304
872S 36" CLR NEOPRENE095928
872S 42" US32D NEOPRENE086947
872S 48" US32D NEOPRENE142033

Jamb Weatherstripping

785S 36" MIL NEOPRENE120166
785S 36" x 84" MIL NEOPRENE120162
785S 36" x 96" GLD NEOPRENE120178
785S 36" x 96" MIL NEOPRENE122126
785S 48" DBA NEOPRENE122470
785S 72" x 84" DBA NEOPRENE120174
785S 72" x 84" MIL NEOPRENE120163
785S 84" DBA NEOPRENE120177
785S 84" GLD NEOPRENE120173
785S 84" MIL NEOPRENE120164
785S 96" DBA NEOPRENE120172
785S 96" MIL NEOPRENE120171
800S 36" MIL BRUSH054784
800S 36" x 84" MIL BRUSH051373
800S 48" x 84" MIL BRUSH051374
800S 72" x 84" MIL BRUSH051375
800S 72" x 96" MIL BRUSH019037
800S 84" DBA BRUSH030583
800S 84" MIL BRUSH056636
800S 96" MIL BRUSH061569
802S 36" DBA BRUSH054610
802S 36" GLD BRUSH054786
802S 36" MIL BRUSH053194
802S 36" x 84" MIL BRUSH051379
802S 48" DBA BRUSH061397
802S 48" GLD BRUSH067474
802S 48" MIL BRUSH054074
802S 48" x 84" MIL BRUSH051380
802S 72" MIL BRUSH055939
802S 72" x 84" MIL BRUSH051381
802S 84" BCA BRUSH101313
802S 84" BLA BRUSH016491
802S 84" DBA BRUSH055941

Jamb Weatherstripping

802S 84" GLD BRUSH054500
802S 84" MIL BRUSH052979
802S 96" BCA BRUSH020711
802S 96" DBA BRUSH054257
802S 96" MIL BRUSH058708
803S 36" MIL BRUSH054075
803S 36" x 84" MIL BRUSH051382
803S 48" x 96" MIL BRUSH048945
803S 72" x 84" MIL BRUSH051394
803S 72" x 96" BLA BRUSH015019
803S 72" x 96" DBA BRUSH030527
803S 84" MIL BRUSH053077
808S 48" MIL BRUSH043629
808S 72" MIL BRUSH040087
808S 84" DBA BRUSH072589
808S 84" MIL BRUSH038341
859S 36" x 84" DBA031883
859S 36" x 84" GLD038948
859S 36" x 84" MIL080290
859S 36" x 96" MIL030375
859S 36" x 108" MIL030376
859S 48" GLD121288
859S 48" MIL067767
859S 48" x 84" MIL071926
859S 48" x 96" MIL042801
859S 72" DBA090769
859S 72" MIL095946
859S 72" x 84" MIL070969
859S 72" x 96" MIL091951
859S 84" DBA086427
859S 84" GLD121287
859S 84" MIL028610
859S 96" MIL091966
859S 120" MIL042496
860S 36" x 84" MIL NEOPRENE051234
860S 36" x 84" MIL VINYL091326
861S 36" MIL NEOPRENE065452
861S 36" x 84" MIL NEOPRENE051235
861S 72" x 84" MIL NEOPRENE051237
861S 84" MIL NEOPRENE065463
862S 36" CLR NEOPRENE083520
862S 36" x 84" CLR NEOPRENE083522
862S 48" CLR NEOPRENE060040
862S 48" x 84" CLR NEOPRENE084994
862S 72" x 84" CLR NEOPRENE083517
862S 72" x 84" DBA NEOPRENE058008

Jamb Weatherstripping

862S 72" x 96" CLR NEOPRENE083632
862S 72" x 96" DBA NEOPRENE055343
862S 84" CLR NEOPRENE083616
862S 84" DBA NEOPRENE073092
862S 96" DBA NEOPRENE061765
863S 36" x 84" CLR NEOPRENE058992
863S 48" x 84" CLR NEOPRENE092863
863S 72" x 84" CLR NEOPRENE087142
863S 84" CLR NEOPRENE084707
864S 36" CLR NEOPRENE083568
864S 36" x 84" CLR NEOPRENE057659
864S 36" x 96" CLR NEOPRENE083570
864S 36" x 108" CLR NEOPRENE062579
864S 48" x 84" CLR NEOPRENE086659
864S 48" x 96" CLR NEOPRENE032695
864S 72" x 84" CLR NEOPRENE083572
864S 72" x 84" DBA NEOPRENE065293
864S 84" CLR NEOPRENE083573
864S 96" CLR NEOPRENE094658
865S 36" DBA NEOPRENE010688
865S 36" GLD NEOPRENE055359
865S 36" MIL NEOPRENE087913
865S 36" x 84" DBA NEOPRENE036985
865S 36" x 84" GLD NEOPRENE091572
865S 36" x 84" MIL NEOPRENE062415
865S 36" x 96" DBA NEOPRENE096197
865S 36" x 96" MIL NEOPRENE017295
865S 36" x 108" DBA NEOPRENE079468
865S 36" x 108" MIL NEOPRENE083004
865S 48" MIL NEOPRENE102562
865S 48" x 84" DBA NEOPRENE101633
865S 48" x 84" GLD NEOPRENE060542
865S 48" x 84" MIL NEOPRENE028997
865S 48" x 96" DBA NEOPRENE125536
865S 48" x 96" MIL NEOPRENE075191
865S 48" x 108" MIL NEOPRENE092260
865S 72" MIL NEOPRENE087915
865S 72" x 84" DBA NEOPRENE081104
865S 72" x 84" GLD NEOPRENE091571
865S 72" x 84" MIL NEOPRENE022917
865S 72" x 96" DBA NEOPRENE036353
865S 72" x 96" MIL NEOPRENE037449
865S 84" MIL NEOPRENE025286
865S 96" GLD NEOPRENE083908
865S 96" MIL NEOPRENE054907
866S 36" DBA NEOPRENE TEK103187

Jamb Weatherstripping

866S 36" MIL NEOPRENE055632
866S 36" x 84" DBA NEOPRENE040799
866S 36" x 84" GLD NEOPRENE067399
866S 36" x 84" MIL NEOPRENE056313
866S 36" x 96" MIL NEOPRENE031942
866S 48" MIL NEOPRENE006290
866S 48" x 84" GLD NEOPRENE078811
866S 48" x 84" MIL NEOPRENE037712
866S 48" x 108" MIL NEOPRENE089576
866S 72" MIL NEOPRENE055553
866S 72" x 84" DBA NEOPRENE092913
866S 72" x 84" GLD NEOPRENE110343
866S 72" x 84" MIL NEOPRENE007786
866S 72" x 96" GLD NEOPRENE105904
866S 72" x 96" MIL NEOPRENE103804
866S 84" GLD NEOPRENE078809
866S 84" MIL NEOPRENE042719
866S 96" DBA NEOPRENE031357
866S 96" MIL NEOPRENE055485
866S 120" MIL NEOPRENE074592
870S 36" US32D NEOPRENE043706
870S 36" x 84" US10B NEOPRENE020778
870S 36" x 84" US32D NEOPRENE041926
870S 36" x 84" CLR NEOPRENE059054
870S 36" x 84" DBA NEOPRENE053497
870S 36" x 84" GLD NEOPRENE016082
870S 36" x 84" WHP NEOPRENE044674
870S 36" x 96" US32D NEOPRENE001160
870S 36" x 96" CLR NEOPRENE083619
870S 36" x 108" US10B NEOPRENE048667
870S 48" US32D NEOPRENE107363
870S 48" CLR NEOPRENE068708
870S 48" x 84" US32D NEOPRENE081517
870S 48" x 84" CLR NEOPRENE063110
870S 48" x 96" CLR NEOPRENE091229
870S 72" US32D NEOPRENE133064
870S 72" CLR NEOPRENE083870
870S 72" x 84" US32D NEOPRENE047924
870S 72" x 84" CLR NEOPRENE083596
870S 72" x 84" DBA NEOPRENE053881
870S 72" x 84" WHP NEOPRENE044675
870S 72" x 96" US32D NEOPRENE001161
870S 72" x 96" CLR NEOPRENE084596
870S 72" x 96" WHP NEOPRENE044676
870S 84" US32D NEOPRENE054591
870S 84" CLR NEOPRENE083597



Jamb Weatherstripping

870S 84" DBA NEOPRENE060876
870S 96" US32D NEOPRENE097748
870S 96" CLR NEOPRENE083884
871S 36" MIL NEOPRENE023335
871S 36" x 84" MIL NEOPRENE051255
871S 48" x 84" MIL NEOPRENE051198
871S 72" x 84" BLA NEOPRENE106806
871S 72" x 84" MIL NEOPRENE051257
871S 84" MIL NEOPRENE063621
873S 36" MIL NEOPRENE053862
873S 36" x 84" DBA NEOPRENE053712
873S 36" x 84" MIL NEOPRENE051263
873S 36" x 96" MIL NEOPRENE058799
873S 48" x 84" MIL NEOPRENE051264
873S 72" x 84" MIL NEOPRENE051265
873S 84" DBA NEOPRENE063162
873S 84" MIL NEOPRENE053864
874S 36" US32D NEOPRENE105906
874S 36" x 84" US32D NEOPRENE064413
874S 36" x 84" MIL NEOPRENE054083
874S 48" US32D NEOPRENE113653
874S 48" x 84" US32D NEOPRENE102263
874S 72" x 84" US32D NEOPRENE102266
874S 72" x 96" US32D NEOPRENE064095
874S 72" x 96" MIL NEOPRENE087114
874S 84" MIL NEOPRENE052592
874S 96" CLR NEOPRENE130963
874S 96" MIL NEOPRENE057221
874S 120" US32D NEOPRENE078861
875S 36" CLR NEOPRENE083401
875S 36" x 84" CLR NEOPRENE058096
875S 36" x 108" CLR NEOPRENE053915
875S 48" CLR NEOPRENE083402
875S 48" x 84" CLR NEOPRENE084882
875S 72" x 84" CLR NEOPRENE059921
875S 84" CLR NEOPRENE084251
875S 36" x 84" CLR SILICONE003880
877S 36" x 84" MIL NEOPRENE072544
878S 36" DBA NEOPRENE005555
878S 36" x 84" CLR NEOPRENE058993
880S 36" x 84" BLA NEOPRENE064900
880S 36" x 84" MIL NEOPRENE051275
880S 72" x 84" MIL NEOPRENE051277
881S 36" MIL NEOPRENE065849
881S 36" x 84" NEOPRENE035415
881S 36" x 84" DBA NEOPRENE084186

Jamb Weatherstripping

881S 36" x 84" MIL NEOPRENE051279
881S 36" x 96" MIL NEOPRENE087921
881S 48" MIL NEOPRENE058998
881S 48" x 84" GLD NEOPRENE058764
881S 48" x 84" MIL NEOPRENE051280
881S 72" GLD NEOPRENE092855
881S 72" MIL NEOPRENE068703
881S 72" x 84" DBA NEOPRENE062108
881S 72" x 84" GLD NEOPRENE034678
881S 72" x 84" MIL NEOPRENE051281
881S 72" x 96" MIL NEOPRENE087923
881S 84" MIL NEOPRENE054328
881S 96" MIL NEOPRENE087019
881S 36" MIL SILICONE065435
881S 36" x 84" GLD SILICONE076415
881S 36" x 84" MIL SILICONE055461
881S 36" x 96" MIL SILICONE080370
881S 36" x 108" MIL SILICONE049936
881S 48" MIL SILICONE070160
881S 48" x 84" MIL SILICONE075414
881S 48" x 96" MIL SILICONE022364
881S 48" x 108" MIL SILICONE056004
881S 72" MIL SILICONE062770
881S 72" x 84" MIL SILICONE062773
881S 72" x 96" MIL SILICONE080371
881S 84" MIL SILICONE054669
881S 96" MIL SILICONE080374
881S 36" DBA VINYL074308
881S 36" MIL VINYL053349
881S 36" x 84" VINYL000159
881S 36" x 84" DBA VINYL058981
881S 36" x 84" MIL VINYL052013
881S 36" x 96" MIL VINYL078158
881S 36" x 108" MIL VINYL072388
881S 48" MIL VINYL055205
881S 48" x 84" MIL VINYL052014
881S 48" x 96" MIL VINYL073151
881S 72" MIL VINYL053348
881S 72" x 84" DBA VINYL058982
881S 72" x 84" MIL VINYL056386
881S 72" x 96" DBA VINYL058983
881S 72" x 96" MIL VINYL063628
881S 84" MIL VINYL055208
881S 96" MIL VINYL062481
881S 36" MIL PILE061446
881S 36" x 84" MIL PILE065534

Jamb Weatherstripping

881S 36" x 96" MIL PILE050803
881S 48" x 84" MIL PILE079361
881S 48" x 96" MIL PILE055447
881S 72" MIL PILE073013
881S 72" x 84" MIL PILE068518
882S 84" CLR BRUSH092969
882S 84" DBA BRUSH092972
882S 84" GLD BRUSH092977
882S 96" CLR BRUSH092971
882S 96" DBA BRUSH092975
882S 96" GLD BRUSH092978
883S 36" CLR BRUSH092979
883S 36" DBA BRUSH092980
883S 36" GLD BRUSH092983
883S 84" CLR BRUSH022506
884S 36" CLR VINYL092987
884S 36" x 84" GLD VINYL145335
884S 48" CLR VINYL092988
884S 84" VINYL112086
884S 84" CLR VINYL092989
884S 84" DBA VINYL092992
884S 84" GLD VINYL093003
884S 96" CLR VINYL092990
884S 96" DBA VINYL093002
884S 96" GLD VINYL093004
885S 72" x 84 CLR NEOPRENE095035
885S 84" NEOPRENE062195
885S 84" CLR SILICONE098428
885S 36" x 84" CLR VINYL094826
885S 36" x 84" DBA VINYL064909
885S 72" x 84" DBA VINYL026261
885S 72" x 96" DBA VINYL098563
885S 84" CLR VINYL054716
885S 96" DBA PILE135972
890S 36" x 84" DBA NEOPRENE054834
890S 36" x 84" MIL NEOPRENE064142
890S 48" x 84" MIL NEOPRENE091396
890S 72" x 84" DBA NEOPRENE054835
890S 72" x 84" MIL NEOPRENE064143
890S 72" x 96" MIL NEOPRENE078079
890S 84" MIL NEOPRENE072200
890S 36" x 84" MIL SILICONE060628
890S 72" x 96" MIL SILICONE093708
890S 36" MIL VINYL065300
890S 36" x 84" DBA VINYL053199
890S 36" x 84" MIL VINYL051287

Jamb Weatherstripping

890S 48" MIL VINYL053842
890S 48" x 84" MIL VINYL051288
890S 72" MIL VINYL069373
890S 72" x 84" MIL VINYL051302
890S 72" x 96" MIL VINYL056203
890S 84" MIL VINYL053181
890S 96" MIL VINYL053841
891S 72" x 84" MIL FVN008055
891S 36" x 84" DBA NEOPRENE055108
891S 36" x 84" GLD NEOPRENE093250
891S 36" x 84" MIL NEOPRENE056722
891S 36" x 96" DBA NEOPRENE014000
891S 36" x 96" MIL NEOPRENE057549
891S 48" x 84" DBA NEOPRENE057018
891S 48" x 84" MIL NEOPRENE057511
891S 48" x 96" DBA NEOPRENE033393
891S 72" x 84" DBA NEOPRENE057019
891S 72" x 84" GLD NEOPRENE074600
891S 72" x 84" MIL NEOPRENE057020
891S 72" x 96" DBA NEOPRENE019682
891S 72" x 96" MIL NEOPRENE061748
891S 84" DBA NEOPRENE008359
891S 84" MIL NEOPRENE073792
891S 96" MIL NEOPRENE025113
891S 36" x 84" DBA SILICONE057068
891S 36" x 84" MIL SILICONE057519
891S 48" x 84" MIL SILICONE059552
891S 72" GASKET ONLY, SILICONE BLACK134581
891S 72" GASKET ONLY, SILICONE BLACK BKG134598
891S 72" x 84" MIL SILICONE061696
891S 72" x 96" MIL SILICONE081032
891S 84" GASKET ONLY, SILICONE BLACK BKG134783
891S 84" MIL SILICONE056283
891S 96" MIL SILICONE056284
891S 36" DBA VINYL003929
891S 36" MIL VINYL052986
891S 36" x 84" CLR VINYL033882
891S 36" x 84" DBA VINYL052356
891S 36" x 84" GLD VINYL052599
891S 36" x 84" MIL VINYL051304
891S 36" x 84" MIL VINYL TEK053838
891S 36" x 96" DBA VINYL054437
891S 36" x 96" MIL VINYL053667
891S 36" x 108" MIL VINYL057520
891S 48" MIL VINYL055375
891S 48" x 84" DBA VINYL052432



Jamb Weatherstripping

891S 48" x 84" GLD VINYL057871
891S 48" x 84" MIL VINYL051305
891S 48" x 96" DBA VINYL054216
891S 48" x 96" MIL VINYL056032
891S 72" MIL VINYL053692
891S 72" x 84" DBA VINYL052357
891S 72" x 84" GLD VINYL054126
891S 72" x 84" MIL VINYL051306
891S 72" x 96" DBA VINYL052433
891S 72" x 96" MIL VINYL052431
891S 84" DBA VINYL064207
891S 84" MIL VINYL053031
891S 96" DBA VINYL071086
891S 96" MIL VINYL053015
892S 36" x 84" DBA NEOPRENE044791
892S 36" x 84" GLD NEOPRENE047155
892S 36" x 84" MIL NEOPRENE044788
892S 48" x 84" MIL NEOPRENE044785
892S 72" x 84" DBA NEOPRENE048297
892S 72" x 84" GLD NEOPRENE071107
892S 72" x 84" MIL NEOPRENE044786
892S 84" MIL NEOPRENE044967
893S 36" DBA PILE055134
893S 36" MIL PILE051285
893S 36" x 84" MIL PILE051314
893S 72" x 84" MIL PILE051313
893S 72" x 84" WHP PILE048452
893S 84" CLR PILE085233
893S 84" DBA PILE058449
893S 84" GLD PILE064959
893S 84" MIL PILE053666
893S 96" MIL PILE056263
896S 36" x 84" DBA NEOPRENE036879
896S 36" x 84" MIL NEOPRENE033668
896S 48" x 84" MIL NEOPRENE037316
896S 48" x 96" MIL NEOPRENE050091
896S 72" x 84" MIL NEOPRENE035258
896S 84" MIL NEOPRENE035980
896S 96" MIL NEOPRENE049422
896S 36" x 84" MIL SILICONE066836
896S 48" x 84" MIL SILICONE051154
896S 36" MIL VINYL063497
896S 36" x 84" GLD VINYL087327
896S 36" x 84" MIL VINYL073543
896S 72" x 84" MIL VINYL074012
896S 84" MIL VINYL033779

Astragals

756S 84" DBA VINYL054120
756S 84" MIL VINYL059622
756S 96" DBA VINYL020114
756S 96" MIL VINYL075551
771S 84" MIL NEOPRENE097923
771S 96" MIL SILICONE123173
771S 84" MIL VINYL037527
771S 96" MIL VINYL046239
771S 84" MIL PILE052983
774S 96" MIL NEOPRENE059422
774S 84" MIL VINYL085136
802S 84" BCA BRUSH101313
802S 84" BLA BRUSH016491
802S 84" DBA BRUSH055941
802S 84" GLD BRUSH054500
802S 84" MIL BRUSH052979
802S 96" BCA BRUSH020711
802S 96" DBA BRUSH054257
802S 96" MIL BRUSH058708
822S 96" MIB060612
822S 96" MIB BULK086203
835S 84" US32D057965
835S 84" DBA054076
835S 84" GLD052598
835S 84" GYP052218
835S 84" MIL051399
835S 96" US32D082492
835S 96" DBA054077
835S 96" GYP054078
835S 96" MIL051401
835S 120" US32D019549
835S 120" DBA028190
835S 120" GYP066347
835S 120" MIL072577
836S 84" DBA052438
836S 84" GLD067594
836S 84" MIL051402
836S 96" DBA065451
836S 96" GLD013885
836S 96" MIL051404
836S 120" DBA056267
836S 120" MIL070159
837S 84" DBA NEOPRENE058049
837S 84" GLD NEOPRENE060491
837S 84" MIL NEOPRENE051407
837S 96" DBA NEOPRENE052767

Astragals

837S 96" MIL NEOPRENE051408
837S 120" MIL NEOPRENE069420
837S 84" DBA SILICONE058625
837S 84" GLD SILICONE062464
837S 84" MIL SILICONE056392
837S 96" DBA SILICONE058626
837S 96" GLD SILICONE079237
837S 96" MIL SILICONE058141
837S 84" DBA VINYL052439
837S 84" GLD VINYL054867
837S 84" MIL VINYL051405
837S 84" WHP VINYL076481
837S 96" BCA VINYL020677
837S 96" DBA VINYL059436
837S 96" GLD VINYL090519
837S 96" MIL VINYL051406
837S 120" GLD VINYL068238
837S 120" MIL VINYL059619
838S 84" MIL PILE056500
838S 96" MIL PILE063241
839SW 84" MIL BRUSH141943
839S 84" MIL BRUSH141944
839S 96" MIL BRUSH141947
839S 120" MIL BRUSH141949
845S 84" MIL PILE051409
846S 84" MIL051410
847S 84" DBA PILE075287
847S 84" GLD PILE000606
847S 96" GLD PILE135979
848S 84" DBA075288
848S 84" GLD128894
849S 84" DBA038794
849S 84" GLD022999
849S 84" MIL014074
849S 96" DBA075587
849S 96" GLD080239
849S 96" MIL031904
872S 84" US32D NEOPRENE046184
872S 84" CLR NEOPRENE053566
872S 84" DBA NEOPRENE052859
872S 84" GLD NEOPRENE053173
872S 96" US32D NEOPRENE028509
872S 96" CLR NEOPRENE083594
872S 120" US32D NEOPRENE060244
872S 120" CLR NEOPRENE084691
874S 84" MIL NEOPRENE052592

Astragals

874S 96" CLR NEOPRENE130963
874S 96" MIL NEOPRENE057221
874S 120" US32D NEOPRENE078861

Spring Bronze

822S 96" MIB060612
822S 96" MIB BULK086203

Rain Drips

810S 40" US32D134678
810S 40" AWP057538
810S 40" DBA052360
810S 40" GLD052597
810S 40" MIL051396
810S 40" WHP038074
810S 52" MIL054095
810S 76" US32D134680
810S 76" DBA052924
810S 76" GLD075081
810S 76" MIL051398
810S 76" WHP038076





One Family. One Brand. One Vision.™

www.hagerco.com

TABLE OF CONTENTS

B	
Barn Door Hardware	
9400 Series Barn Door Packaged Sets	35
Bi-Fold Door Hardware	
9570 Packaged Sets	15
9860 Packaged Sets and 9861 Packaged Sets	16
9890 Packaged Sets and 9891 Packaged Sets	17
By-Pass Door Hardware	
9110 Packaged Sets and 9130 Packaged Sets	4
9514 Packaged Sets and 9583 Packaged Sets	5
9611 Packaged Sets and 9612 Packaged Sets	6
9614 Packaged Sets and 9683 Packaged Sets	7
9673 Packaged Sets and 9674 Packaged Sets	9
9675 Packaged Sets and 9676 Packaged Sets	10
9844 Packaged Sets and 9845 Packaged Sets	11
9875 Packaged Sets	13
9885 Packaged Sets and 9886 Packaged Sets	14
C	
Components for Barn Door Hardware	36-37
Components for Sliding Door Hardware	25-34
Conestoga - How to Order and Pricing	38-39
D	
Door Selection Chart	3
H	
How to Order	2
L	
Lead Times	2
P	
Pocket Door Hardware	
9110 Packaged Sets and 9130 Packaged Sets	18
9628 9629 9630 9631 Framed Kits	19
9678 Packaged Sets	20
9850 Framed Kits	21
9878 Packaged Sets	22
9901 Packaged Sets	23
Q	
Quick Ship	2
S	
Side Mount Selection Chart	2
W	
Wall Mount 9710 Series	24



Sliding Door Hardware

GENERAL INFORMATION

Lead Times

Stock items will typically ship in five working days or less from the order entry date. Made-to-order items will typically ship in 15 working days depending on seasonal volume and order complexity. Special orders including industrials, special machining, and large quantities may need to be scheduled. The anticipated ship date will be included with each order acknowledgement. Please contact Customer Service if product availability is in question.

Quick Ship

Products denoted with **red and bold** pricing are available to order through the Quick Ship program and ship within 24 hours. When ordering these products please visit www.hagerco.com and log in to MyHager to access the 'Quick Ship' portal. Due to the promptness of the fulfillment process, Quick Ship orders are non-cancellable.

Cancellation Notification

Cancellation for made-to-order items must be communicated within 48 hours of order placement.

HOW TO ORDER:

EXAMPLE: 9710 Wall Mount Packaged Set For 1 Door CLA 72"

STOCK NUMBER: 160958

ITEM NUMBER: 971000720000CLA

Side Mount Selection Chart					
Door thickness	3/4" (19mm)	1" (25.4mm)	1-1/8" (29mm)	1-3/8" (35mm)	1-3/4" (44mm)
Front hanger	B	B	A or B	B	A
Rear hanger	A	A	Same as front	B	B
Door gap	3/4"	1/2"	11/16"	9/16"	3/8"
Item #	Description				
Hanger A	9200	Single wheel hanger-offset A			
Hanger B	9201	Single wheel hanger-offset B			
Hanger B	9202	Twin wheel hanger- offset B			
Hanger A	9203	Twin wheel hanger- offset A			
Hanger A	9400	Micro cam hanger-offset A			
Hanger B	9401	Micro cam hanger-offset B			

Hanger Mount Selection Example:

Door thickness: 1-1/8"

Door weight: 60 lbs.

Select single, twin or micro cam hanger

Front hanger: 9400

Rear hanger: 9400

Note: Hanger is stamped "A" or "B" for easy identification for consideration for 9514, 9583, 9614, 9683, 9844 and 9845 by-pass packaged sets located on pages 5, 7 and 10.



Maximum Weight Per Door	Packaged Sets	Description	Parts Bags	Track	Page #
By-Pass					
60#	9514	Aluminum track & hardware for 3/4" - 1-3/8" thick doors.	9814	9810	5
60#	9583	Aluminum track & hardware for 3/4" - 1-3/8" thick doors, for 3 doors.	9814	9810	5
60#	9614	Aluminum track with grooved fascia - hardware for 1-3/8" thick doors.	9540	9820	7
60#	9683	Aluminum track with grooved fascia - hardware for 1-3/8" thick doors.	9401 hangers	9820	7
60#	9844	Galvanized steel & hardware for 1-1/8" - 1-3/8" thick doors.	9540	9840	11
60#	9845	Galvanized steel & hardware for 1-1/8" - 1-3/8" thick doors for 3 doors.	9400/9401 hangers	9840	11
125#	9673	Heavy duty aluminum box track with grooved fascia & hardware for 1-3/8" - 1-3/4" thick doors.	9679	9603	9
125#	9675	Heavy duty aluminum box track & hardware for 1-3/8" & 1-3/4" thick doors.	9679	9602	9
150#	9611	Aluminum double box track & hardware for 1-3/8" & 1-3/4" thick doors.	9892	9821	6
150#	9674	Heavy duty aluminum box track with grooved fascia & hardware for 1-3/8" & 1-3/4" thick doors.	9680	9603	9
150#	9676	Heavy duty aluminum box track & hardware for 1-3/8" & 1-3/4" thick doors.	9680	9602	10
175#	9110	Heavy duty aluminum I-beam track and hardware for 1" - 1-3/4" thick doors. *Must order 2 per by pass.*	9109	9101	4
250#	9612	Aluminum double box track & hardware for 1-3/8" & 1-3/4" thick doors.	9893	9821	6
250#	9875	Heavy duty aluminum box track & hardware for 1-3/8" & 1-3/4" thick doors.	9827 hangers	9801	13
250#	9885	Heavy duty aluminum double track with smooth fascia & hardware for 1-3/8" & 1-3/4" thick doors.	9827 hangers	9803	13
250#	9886	Heavy duty aluminum double track with smooth fascia & hardware for 1-3/8" & 1-3/4" thick doors.	9827 hangers	9803	13
275#	9130	Heavy duty aluminum I-beam track and hardware for 1" thick doors and up. *Must order 2 per by pass.*	9129	9101	4
Bi-Fold Sets					
50#	9570	Aluminum track & hardware for 1-1/8" & 1-3/4" thick doors.	9571	9601	15
125#	9860	Heavy duty aluminum box track & hardware for 1-3/8" & 1-3/4" thick doors.	9894	9821	16
125#	9861	Heavy duty aluminum box track & hardware for 1-3/8" & 1-3/4" thick doors.	9894	9821	14
125#	9890	Heavy duty aluminum box track & hardware for 1-1/8" & 1-3/4" thick doors. Up to 75 lbs per panel for multi fold applications.	9827 hangers	9801	17
125#	9891	"Heavy duty aluminum box track & hardware for 1-1/8" & 1-3/4" thick doors.	9827 hangers	9801	17
Pocket Door Sets					
125#	9678	Heavy duty aluminum box track & hardware for 1-3/8" & 1-3/4" thick doors.	9632	9601	20
150#	9678	Heavy duty aluminum box track & hardware for 1-3/8" & 1-3/4" thick doors.	9633	9101	20
175#	9110	Heavy duty aluminum I-beam track & hardware for 1" thick doors and up.	9109	9101	18
250#	9878	Aluminum box track & hardware for 1-3/8" thick doors and up.	9742	9801	22
250#	9901	Extra heavy duty aluminum box track & hardware for 1-3/8" & 1-3/4" thick doors.	9895	9821	23
275#	9130	Heavy duty aluminum I-beam track & hardware for 1" thick doors and up.	9129	9101	18
Pocket Door Frame Kits All Pocket Door Framed Kits for 1-3/8" Thick Doors					
125#	9631	Pocket Door Packaged Sets for 3'0" wide 6'8" high door	9606 hangers	9601	19
150#	9628	Pocket Door Packaged Sets for 3'0" wide 7'0" high door	9606 hangers	9601	19
150#	9629	Pocket Door Packaged Sets for 3'0" wide 8'0" high door	9606 hangers	9601	19
150#	9630	Pocket Door Packaged Sets for 3'0" wide 9'0" high door	9606 hangers	9601	19
250#	9850	Pocket Door Packaged Sets for 4'0" wide 8'0" high door	9827 hangers	9801	21
250#	9850	Pocket Door Packaged Sets for 4'0" wide 8'6" high door	9827 hangers	9801	21
Wall Mount Sets					
250#	9710	Heavy duty aluminum track & hardware for 1" & 1-3/4" thick doors.	9711	9703	24
Barn Door Pakaged Sets					
250#	All	9400 Series Stainless Steel Barn Door	N/A	N/A	35
250#	All	Conestoga	N/A	N/A	38



Sliding Door Hardware - 9110 and 9130 Packaged Sets - By-Pass



Description	Finish	2018 List	Stock No.	Case Qty.
9110 Packaged Sets for doors up to 175 lbs (79 kg) per door.				
Contents: 9101 track, 9109 parts bag Heavy duty aluminum I-beam track & hardware for 1" - 1-3/4" (25mm - 45mm) thick doors.				
9110-60 - Packaged set for 2'6" door	60" (1524 mm)	117.55	135334	5
9110-72 - Packaged set for 3'0" door	72" (1829 mm)	129.95	135335	
9110-84 - Packaged set for 3'6" door	84" (2134 mm)	141.55	135336	
9110-96 - Packaged set for 4'0" door	96" (2438 mm)	154.05	135337	
9110-120 - Packaged set for 5'0" door	120" (3048 mm)	158.60	135338	
9110-144 - Packaged set for 6'0" door	144" (3658 mm)	185.75	135339	

Note: Must order 2 each 9110 packaged sets

9130 Packaged Sets for doors up to 275 lbs (125 kg) per door.

Contents: 9101 track, 9129 parts bag

9130-60 - Packaged set for 2'6" door	60" (1524 mm)	150.15	135340	5
9130-72 - Packaged set for 3'0" door	72" (1829 mm)	161.00	135341	
9130-84 - Packaged set for 3'6" door	84" (2134 mm)	162.60	135342	
9130-96 - Packaged set for 4'0" door	96" (2438 mm)	177.25	135343	
9130-120 - Packaged set for 5'0" door	120" (3048 mm)	209.80	135344	
9130-144 - Packaged set for 6'0" door	144" (3658 mm)	234.10	135346	

Note: Must order 2 each 9130 packaged sets



9101-60 - I-beam track only, heavy duty aluminum	60" (1524 mm)	AL	54.85	023278	5
9101-72 - I-beam track only, heavy duty aluminum	72" (1829 mm)	AL	68.65	096508	
9101-84 - I-beam track only, heavy duty aluminum	84" (2134 mm)	AL	81.80	096509	
9101-96 - I-beam track only, heavy duty aluminum	96" (2438 mm)	AL	87.45	096707	
9101-120 - I-beam track only, heavy duty aluminum	120" (3048 mm)	AL	114.40	096511	
9101-144 - I-beam track only, heavy duty aluminum	144" (3658 mm)	AL	137.65	096512	
9101-192 - I-beam track only, heavy duty aluminum	192" (4877 mm)	AL	182.75	096513	

Parts Description

9109 - 2 ea. 9102 two wheel hangers, 1 ea. 9115 floor guide. <i>*Up to 175 lbs (79 kg) per door.*</i>	56.95	135690	10
9129 - 2 ea. 9105 four wheel hangers, 1 ea. 9115 floor guide. <i>*Up to 275 lbs (125 kg) per door.*</i>	84.05	135315	10

Components Description

9102 2 Wheel Hanger - For use with 9101 track	US2C	25.00	135310	20
9105 4 Wheel Hanger - For use with 9101 track	US2C	37.50	135312	40
9115 Bottom Door Guide	US2C	8.85	096522	50



- For additional components, refer to component section. 2. Items with the price in **bold and red** are Quick Ship items and ship in 24 hours. Please use stock number when ordering. 3. U/M is each unless otherwise noted.
4. Packaged sets and parts bags are available with optional components by special quotation.



Sliding Door Hardware - 9514 and 9583 Packaged Sets - By-Pass



Description	Finish	2018 List	Stock No.	Case Qty.
9514 Packaged Sets for doors up to 60 lbs (27 kg) each for two (2) doors.				
Contents: 9810 track, 9814 parts bag. Refer to side mount selection chart for combination of hangers. Aluminum track & hardware For 3/4" (19 mm) and 1-3/8" (35mm) thick doors.				
9514-48 - By-pass set for two 24" doors	48" (1219 mm)	37.50	099662	5
9514-60 - By-pass set for two 30" doors	60" (1524 mm)	40.60	099663	
9514-72 - By-pass set for two 36" doors	72" (1829 mm)	45.20	099666	
9514-96 - By-pass set for two 48" doors	96" (2438 mm)	60.05	017418	
9583 Packaged Sets for doors up to 60 lbs (27 kg) each for three (3) doors.				
Contents: 9810 track, 2 ea. 9400 hangers, 4 ea. 9401 hangers, 2 ea. 9353 guides, 3 ea. 2610 pulls				
9583-96 -	96" (2438 mm)	68.65	029415	5
9810-46 - Aluminum track	46-3/8" (1178 mm)	AL 15.80	019702	10
9810-58 - Aluminum track	58-3/8" (1483 mm)	AL 18.85	019703	
9810-70 - Aluminum track	70-3/8" (1788 mm)	AL 22.90	019704	
9810-93 - Aluminum track	93-3/8" (2372 mm)	AL 29.65	019705	
9810-120 - Aluminum track	120" (3048 mm)	AL 37.50	016570	
9810-144 - Aluminum track	144" (3658 mm)	AL 49.90	026064	
Parts Description				
9814 - 2 ea. 9400 hangers, 2 ea. 9401 hangers, 2 ea. 2610 pulls, 1 ea. 9353 guide		14.95	016772	10
9841 - For 1" to 1-1/8", specify 9841 parts bag. 4 ea. 9401 hangers, 2 ea. 9865 pulls, 1 ea. 9351 guide		8.10	099665	10
Components Description				
2610				
Finger Pull	US3	.95	013049	500
	US4	.95	071953	
Material: Brass	US5	.95	067282	
Overall Diameter: 31/32"	US10A	.95	068711	
Finger Pull Diameter: 3/4"	US15	.95	040589	
Pull Clearance: 5/16"	US15A	.95	040590	
Projection: 1/32"	US26	.95	013047	
	US26D	.95	071169	
9351		2.65	096563	50
Door Guide				
9353		2.65	096564	20
Adjustable Door Guide				
9400	US2C	3.35	017417	100
Cam Adjustable Hanger - Small 3/8" (10 mm) offset A				
9401	US2C	3.35	096566	100
Cam Adjustable Hanger - Large 11/16" (18 mm) offset B				
9865	Plastic	1.00	098993	50
Plastic Pull Overall Diameter: 1-31/32" Finger Pull Diameter: 1-19/32" Pull Clearance: 11/32" Projection: 5/64"				

- For additional components, refer to component section.
- Items with the price in **bold and red** are Quick Ship items and ship in 24 hours. Please use stock number when ordering.
- U/M is each unless otherwise noted.
- Packaged sets and parts bags are available with optional components by special quotation.



Sliding Door Hardware - 9611 and 9612 Packaged Sets - By-Pass



Description	Finish	2018 List	Stock No.	Case Qty.	
9611 Packaged Sets for doors up to 150 lbs (68 kg) each.					
9573 spacer kit is used for 1-3/4" (4 mm) doors. No spacer kit required for 1-3/8" (35 mm) doors.					
Contents: 2 ea. 9821 tracks, 9892 parts bag					
For 1-3/8" (35 mm) and 1-3/4" (44 mm) thick doors.					
9611-60 - By-pass set for two 30" doors	60" (1524 mm)	126.85	019404	5	
9611-72 - By-pass set for two 36" doors	72" (1829 mm)	136.40	019402		
9611-96 - By-pass set for two 48" doors	96" (2438 mm)	165.00	019389		
9612 Packaged Sets for doors up to 250 lbs (113 kg) each.					
Contents: 2 pcs 9821 Track, 9893 Parts bag					
9612-60 - By-pass set for two 30" doors	60" (1524 mm)	159.45	019368	5	
9612-72 - By-pass set for two 36" doors	72" (1829 mm)	170.45	019362		
9612-96 - By-pass set for two 48" doors	96" (2438 mm)	185.60	019378		
9821-59 - Aluminum box track	59" (1499 mm)	AL	30.90	019084	10
9821-71 - Aluminum box track	71" (1803 mm)	AL	38.30	019062	
9821-96 - Aluminum box track	96" (2438 mm)	AL	51.05	019061	
9821-144 - Aluminum box track	144" (3658 mm)	AL	73.95	019050	
Grooved fascia for painting					
9709-48 - Aluminum grooved fascia, 2-3/4" (70 mm) wide	48" (1219 mm)	AL	34.40	023321	10
9709-60 - Aluminum grooved fascia, 2-3/4" (70 mm) wide	60" (1524 mm)	AL	51.55	023322	
9709-72 - Aluminum grooved fascia, 2-3/4" (70 mm) wide	72" (1829 mm)	AL	59.15	096603	
9709-96 - Aluminum grooved fascia, 2-3/4" (70 mm) wide	96" (2438 mm)	AL	67.00	096604	
Parts Description					
9892 - 4 ea. 9824 four-wheel hangers w/ top mount plate, 1 ea. 9909 guide, 9573 spacer kit		52.70	019421	10	
9893 - 4 ea. 9825 four-wheel ball bearing hangers w/ top mount plate, 1 ea. 9909 guide, 9573 spacer kit		98.60	019418	10	
Components Description					
9573 Spacer Kit - 3/8" use with 9821 track - For doors 1-3/4" thick		4.95	019014	5	
9824 4 Wheel Hanger w/ Top Mount Plate		27.80	135320	20	
9825 4 Wheel Ball Bearing Hanger w/ Top Mount Plate		34.95	135321	10	
9909 Heavy Duty Adjustable Door Guide From 3/4" to 1-3/4" (19 mm to 44 mm)	US2C	8.10	097528	20	



Sliding Door Hardware - 9614 and 9683 Packaged Sets - By-Pass



Description	Finish	2018 List	Stock No.	Case Qty.	
9614 Packaged Sets for doors up to 60 lbs (27 kg).					
Contents: 9820 track, 9540 parts bag. Refer to side mount selection chart on page 2 for combination of hangers. Aluminum track & hardware with 1-3/4" (44 mm) grooved fascia. For 1-3/8" (35 mm) thick doors.					
9614-48 - By-pass set for two 24" doors	48" (1219 mm)	46.85	099091	5	
9614-60 - By-pass set for two 30" doors	60" (1524 mm)	53.10	099756		
9614-72 - By-pass set for two 36" doors	72" (1829 mm)	60.75	016652		
9683 Packaged Sets for three (3) 32" doors and doors up to 60 lbs. (27 kg) each.					
Contents: 9820 track, 6 ea. 9401 hangers, 2 ea. 9351 guides, and 3 ea. 2610 pulls					
9683-96 - By-pass set for three 32" doors	96" (2438 mm)	85.70	022329		
Grooved fascia for painting					
9820-48 - Aluminum track with 1-3/4" grooved fascia	48" (1219 mm)	AL	29.05	000461	5
9820-60 - Aluminum track with 1-3/4" grooved fascia	60" (1524 mm)	AL	36.05	000462	
9820-72 - Aluminum track with 1-3/4" grooved fascia	72" (1829 mm)	AL	42.15	000463	
9820-84 - Aluminum track with 1-3/4" grooved fascia	84" (2134 mm)	AL	56.95	028175	
9820-96 - Aluminum track with 1-3/4" grooved fascia	96" (2438 mm)	AL	62.30	099664	
9820-120 - Aluminum track with 1-3/4" grooved fascia	120" (3048 mm)	AL	71.75	000464	
9820-144 - Aluminum track with 1-3/4" grooved fascia	144" (3658 mm)	AL	93.45	000460	
Parts Description					
9540 - 4 ea. 9401 hangers, 2 ea. 2610 pull, 1 ea. 9351 guide		9.55	017419	10	
9544 - 4 ea. 9202 hangers, 2 ea. 2630 pull, 1 ea. 9351 guide <i>*Used to increase door weight capacity to 75 lbs*</i>		14.15	017035		
9841 - 4 ea. 9401 hangers, 2 ea. 9865 pull, 1 ea. 9351 guide		8.10	099665		
9842 - 4 ea. 9401 hangers, 2 ea. 2630 pull, 1 ea., 9351 guide		11.10	017424		
9843 - 4 ea. 9202 hangers, 2 ea. 9865 pull, 1 ea. 9351 guide <i>*Used to increase door weight capacity to 75 lbs*</i>		12.65	016912		
Components Description					
2610		US3	0.95	013049	500
Finger Pull		US4	0.95	071953	
Material: Brass		US5	0.95	067282	
Overall Diameter: 31/32"		US10A	0.95	068711	
Finger Pull Diameter: 3/4"		US15	0.95	040589	
Pull Clearance: 5/16"		US15A	0.95	040590	
Projection: 1/32"		US26	0.95	013047	
		US26D	0.95	071169	
2630		US3	4.15	051919	50
Round Flush Pull		US4	4.15	073783	
Material: Brass		US5	4.15	053163	
Overall Diameter: 2-7/16"		US10A	4.15	073053	
Finger Pull Diameter: 2-1/16"		US15	4.15	073056	
Pull Clearance: 11/32"		US15A	4.15	005307	
Projection: 3/32"		US26	4.15	023430	
		US26D	4.15	023431	
9202		US2C	3.35	096562	100
Twin Wheel Hanger - Large 11/16" (18 mm) offset B					

- For additional components, refer to component section. 2. Items with the price in **bold and red** are Quick Ship items and ship in 24 hours. Please use stock number when ordering. 3. U/M is each unless otherwise noted.
4. Packaged sets and parts bags are available with optional components by special quotation.



Sliding Door Hardware - 9614 and 9683 Packaged Sets - By-Pass



Components Description	Finish	2018 List	Stock No.	Case Qty.
9351 Door Guide		2.65	096563	50
9401 Cam Adjustable Hanger - Large 1 1/16" (18 mm) offset B	US2C	3.35	096566	100
9865 Plastic Pull Overall Diameter: 1-31/32" Finger Pull Diameter: 1-19/32" Pull Clearance: 1 1/32" Projection: 5/64"	Plastic	1.00	098993	50



Sliding Door Hardware - 9673 and 9674 Packages Sets - By-Pass



Description	Finish	2018 List	Stock No.	Case Qty.	
9673 Packaged Sets for doors up to 125 lbs (57 kg).					
Contents: 9603 track, 9679 parts bag					
Heavy duty aluminum double box track & hardware with 2-5/8" (66 mm) grooved fascia. For 1-3/8" (35 mm) and 1-3/4" (44 mm) thick doors.					
9673-48 - By-pass set for two 24" doors	48" (1219 mm)	135.40	137170	5	
9673-60 - By-pass set for two 30" doors	60" (1524 mm)	146.20	137171		
9673-72 - By-pass set for two 36" doors	72" (1829 mm)	154.75	137172		
9673-96 - By-pass set for two 48" doors	96" (2438 mm)	189.80	137173		
9674 Packaged Sets for doors up to 150 lbs (68 kg).					
9674-48 - By-pass set for two 24" doors	48" (1219 mm)	177.25	136345	5	
9674-60 - By-pass set for two 30" doors	60" (1524 mm)	187.40	136346		
9674-72 - By-pass set for two 36" doors	72" (1829 mm)	202.15	136347		
9674-96 - By-pass set for two 48" doors	96" (2438 mm)	234.10	136349		
Grooved fascia for painting.					
Double box track w/ built in grooved fascia.					
9603-48 - Aluminum box track with grooved fascia	48" (1219 mm)	AL	60.75	135288	5
9603-60 - Aluminum box track with grooved fascia	60" (1524 mm)	AL	73.25	135289	
9603-72 - Aluminum box track with grooved fascia	72" (1829 mm)	AL	87.20	135290	
9603-96 - Aluminum box track with grooved fascia	96" (2438 mm)	AL	113.70	135291	
9603-120 - Aluminum box track with grooved fascia	120" (3048 mm)	AL	142.40	029359	
9603-144 - Aluminum box track with grooved fascia	144" (3658 mm)	AL	175.05	029360	
Parts Description					
9575 - 4 ea. 9572 hangers w/ top mount plate, 1 ea. 9909 guide		27.45	137167	5	
9679 - 4 ea. 9605 hangers w/ top mount plate, 1 ea. 9909 guide		38.30	096600		
9680 - 4 ea. 9606 ball bearing hangers w/ top mount plate, 1 ea. 9909 guide		90.30	136357		
Components Description					
9572	4 Wheel Hanger w/ Top Mount Plate	US2D	11.85	135316	20
9605	4 Wheel Hanger w/ Top Mount Plate	US2D	5.55	135317	20
9606	4 Wheel Ball Bearing Hanger w/ Top Mount Plate	US2D	17.30	135318	20
9909	Heavy Duty Adjustable Door Guide From 3/4" to 1-3/4" (19 mm to 44 mm)	US2C	8.10	097528	20

- For additional components, refer to component section. 2. Items with the price in **bold and red** are Quick Ship items and ship in 24 hours. Please use stock number when ordering. 3. U/M is each unless otherwise noted.
4. Packaged sets and parts bags are available with optional components by special quotation.



Sliding Door Hardware - 9675 and 9676 Packaged Sets - By-Pass



Description	Finish	2018 List	Stock No.	Case Qty.	
9675 Packaged Sets for doors up to 125 lbs (57 kg) each.					
Contents: 9602 track, 9679 parts bag Heavy duty aluminum double box track & hardware For 1-3/8" (35 mm) and 1-3/4" (44 mm) thick doors.					
9675-48 - By-pass set for two 24" doors	48" (1219 mm)	88.80	137175	5	
9675-60 - By-pass set for two 30" doors	60" (1524 mm)	95.00	137176		
9675-72 - By-pass set for two 36" doors	72" (1829 mm)	104.30	137177		
9675-96 - By-pass set for two 48" doors	96" (2438 mm)	123.00	137178		
9676 Packaged Sets for doors up to 150 lbs (68 kg) each.					
9676-48 - By-pass set for two 24" doors	48" (1219 mm)	135.40	136350	5	
9676-60 - By-pass set for two 30" doors	60" (1524 mm)	136.90	136351		
9676-72 - By-pass set for two 36" doors	72" (1829 mm)	150.95	136352		
9676-96 - By-pass set for two 48" doors	96" (2438 mm)	167.25	136353		
Grooved fascia for painting					
9709-48 - Aluminum grooved fascia, 2-3/4" (70 mm) wide	48" (1219 mm)	AL	34.40	023321	10
9709-60 - Aluminum grooved fascia, 2-3/4" (70 mm) wide	60" (1524 mm)	AL	51.55	023322	
9709-72 - Aluminum grooved fascia, 2-3/4" (70 mm) wide	72" (1829 mm)	AL	59.15	096603	
9709-96 - Aluminum grooved fascia, 2-3/4" (70 mm) wide	96" (2438 mm)	AL	67.00	096604	
9602-46 - Double box track only, heavy duty aluminum	46" (1168 mm)	AL	32.90	096582	5
9602-58 - Double box track only, heavy duty aluminum	58" (1473 mm)	AL	40.60	096583	
9602-70 - Double box track only, heavy duty aluminum	70" (1778 mm)	AL	46.85	096584	
9602-94 - Double box track only, heavy duty aluminum	94" (2388 mm)	AL	60.75	096585	
9602-118 - Double box track only, heavy duty aluminum	118" (2997 mm)	AL	73.25	096586	
9602-142 - Double box track only, heavy duty aluminum	142" (3607 mm)	AL	87.20	096587	
Parts Description					
9575 - 4 ea. 9572 hangers w/ top mount plate, 1 ea. 9909 guide		27.45	137167	5	
9679 - 4 ea. 9605 hangers w/ top mount plate, 1 ea. 9909 guide		38.30	096600	5	
9680 - 4 ea. 9606 ball bearing hangers w/ top mount plate, 1 ea. 9909 guide		90.30	136357	5	
Components Description					
9572 - 4 Wheel Hanger w/ Top Mount Plate	US2D	11.85	135316	20	
9605 - 4 Wheel Hanger w/ Top Mount Plate	US2D	5.55	135317	20	
9606 - 4 Wheel Ball Bearing Hanger w/ Top Mount Plate	US2D	17.30	135318	20	
9909 - Heavy Duty Adjustable Door Guide From 3/4" to 1-3/4" (19 mm to 44 mm)	US2C	8.10	097528	20	



Sliding Door Hardware - 9844 and 9845 Packaged Sets - By-Pass



Description	Finish	2018 List	Stock No.	Case Qty.
9844 Packaged Sets for doors up to 60 lbs (27 kg).				
Contents: 9840 track and 9540 parts bag. Refer to side mount selection chart on page 2 for combination of hangers. Galvanized steel track & hardware For 1-1/8" (29 mm) and 1-3/8" (35 mm) thick doors, use 9844 pkg set. For doors 3/4" (19 mm), 1" (25 mm), and 1-3/4" (44 mm) thick, use track 9840.				
9844-48 - By-pass set for two 24" doors	48" (1219 mm)	29.65	096652	5
9844-60 - By-pass set for two 30" doors	60" (1524 mm)	32.90	096653	
9844-72 - By-pass set for two 36" doors	72" (1829 mm)	36.05	096654	
9844-96 - By-pass set for two 48" doors	96" (2438 mm)	46.05	096655	
9845 Packaged Sets for three (3) doors and doors up to 60 lbs. (27 kg) per door.				
Contents: 9840 track, 2 ea. 9400 hangers, 4 ea. 9401 hangers, 2 ea. 9353 guides, and 3 ea. 2610 pulls				
9845-96 - By-pass set for three 32" doors	96" (2438 mm)	53.10	096668	5
9840-46 - Galvanized steel track	45-1/2" (1156 mm)	US2H 9.55	000931	10
9840-58 - Galvanized steel track	57-1/2" (1461 mm)	US2H 11.10	000932	
9840-70 - Galvanized steel track	69-1/2" (1765 mm)	US2H 13.45	000933	
9840-81 - Galvanized steel track	80-1/2" (2045 mm)	US2H 15.80	017893	
9840-93 - Galvanized steel track	92-1/2" (2350 mm)	US2H 17.30	017006	
9840-120 - Galvanized steel track	120" (3048 mm)	US2H 22.30	017854	
9840-144 - Galvanized steel track	144" (3658 mm)	US2H 26.80	017855	
Parts Description				
9540 - 4 ea. 9401 hangers, 2 ea. 2610 pulls, 1 ea., 9351 guide		9.55	017419	10
9544 - 4 ea. 9202 hangers, 2 ea. 2630 pulls, 1 ea., 9351 guide <i>*Used to increase door weight capacity to 75 pounds*</i>		14.15	017035	
9841 - 4 ea. 9401 hangers, 2 ea. 9865 pulls, 1 ea., 9351 guide		8.10	099665	
9842 - 4 ea. 9401 hangers, 2 ea. 2630 pulls, 1 ea., 9351 guide		11.10	017424	
9843 - 4 ea. 9202 hangers, 2 ea. 9865 pulls, 1 ea., 9351 guide <i>*Used to increase door weight capacity to 75 pounds*</i>		12.65	016912	
Components Description				
2610		US3 0.95	013049	500
Finger Pull		US4 0.95	071953	
Material: Brass		US5 0.95	067282	
Overall Diameter: 31/32"		US10A 0.95	068711	
Finger Pull Diameter: 3/4"		US15 0.95	040589	
Pull Clearance: 5/16"		US15A 0.95	040590	
Projection: 1/32"		US26 0.95	013047	
		US26D 0.95	071169	
2630		US3 4.15	051919	50
Round Flush Pull		US4 4.15	073783	
Material: Brass		US5 4.15	053163	
Overall Diameter: 2-7/16"		US10A 4.15	073053	
Finger Pull Diameter: 2-1/16"		US15 4.15	073056	
Pull Clearance: 11/32"		US15A 4.15	005307	
Projection: 3/32"		US26 4.15	023430	
		US26D 4.15	023431	
9202		US2C 3.35	096562	100
Twin Wheel Hanger - Large 11/16" (18 mm) offset B				

- For additional components, refer to component section. 2. Items with the price in **bold and red** are Quick Ship items and ship in 24 hours. Please use stock number when ordering. 3. U/M is each unless otherwise noted.
4. Packaged sets and parts bags are available with optional components by special quotation.



Sliding Door Hardware - 9844 and 9845 Packaged Sets - By-Pass



Components Description	Finish	2018 List	Stock No.	Case Qty.
9351 Door Guide		2.65	096563	50
9400 Cam Adjustable Hanger - Small 3/8" (10 mm) offset A	US2C	3.35	017417	100
9401 Cam Adjustable Hanger - Large 11/16" (18 mm) offset B	US2C	3.35	096566	100
9865 Plastic Pull Overall Diameter: 1-31/32", Finger Pull Diameter: 1-19/32", Pull Clearance: 11/32", Projection: 5/64"	Plastic	1.00	098993	50



Sliding Door Hardware - 9875 Packaged Sets- By-Pass



Description	Finish	2018 List	Stock No.	Case Qty.		
9875 Packaged Sets for doors up to 250 lbs (113 kg).						
Contents: 2 ea. 9801 tracks, 4 ea. 9827 hangers w/ top mount plate, 1 ea. 9574 spacer, 1 ea. 9909 guide						
Heavy duty Aluminum box track & hardware						
For 1-3/8" (35 mm) and 1-3/4" (44 mm) thick doors.						
9574 spacer kit is used for 1-3/4" (4 mm) doors.						
No spacer kit required for 1-3/8" (35 mm) doors.						
9875-48 - By-pass set for two 24" doors		48" (1219 mm)	183.60	137420	6	
9875-60 - By-pass set for two 30" doors		60" (1524 mm)	231.70	137421		
9875-72 - By-pass set for two 36" doors		72" (1829 mm)	244.10	137422		
9875-96 - By-pass set for two 48" doors		96" (2438 mm)	273.60	137423		
Grooved fascia for painting						
9809-72 - Aluminum grooved fascia, 3-7/8" (98 mm) thick		72" (1829 mm)	AL	92.65	096646	10
9809-96 - Aluminum grooved fascia, 3-7/8" (98 mm) thick		96" (2438 mm)	AL	121.35	096647	
9801-72 - Aluminum box track		72" (1829 mm)	AL	49.90	096641	10
9801-96 - Aluminum box track		96" (2438 mm)	AL	67.00	096642	
9801-120 - Aluminum box track		120" (3048 mm)	AL	84.05	096643	
9801-144 - Aluminum box track		144" (3658 mm)	AL	109.75	096644	
9801-192 - Aluminum box track		192" (4877 mm)	AL	146.20	096645	
Components Description						
9574				4.95	015991	5
Spacer Kit - For use with 9801 - For doors 1-3/8" and 1-3/4" thick						
9827				40.60	018292	10
4 Wheel Ball bearing Hanger w/ Top Mount Plate						
9909			US2C	8.10	097528	20
Heavy Duty Adjustable Door Guide						
From 3/4" to 1-3/4" (19 mm to 44 mm)						

1. For additional components, refer to component section. 2. Items with the price in **bold and red** are Quick Ship items and ship in 24 hours. Please use stock number when ordering. 3. U/M is each unless otherwise noted.
4. Packaged sets and parts bags are available with optional components by special quotation.



Sliding Door Hardware - 9885 and 9886 Packaged Sets - By-Pass



Description	Finish	2018 List	Stock No.	Case Qty.	
9885 Packaged Sets for two (2) doors up to 250 lbs (113 kg) each.					
Contents: 9803 track, 4 ea. 9827 hangers w/ top mount plate, 1 ea. 9909 guide, 1 ea. 9815 center stop for 9886 only. Heavy duty aluminum double box track with 3-1/2" (89 mm) smooth fascia & hardware, for two doors. For 1-3/8" (35 mm) and 1-3/4" (44 mm) thick doors.					
9885-48 - By-pass set for two 24" doors	48" (1219 mm)	209.25	137463	1	
9885-60 - By-pass set for two 30" doors	60" (1524 mm)	234.80	137464		
9885-72 - By-pass set for two 36" doors	72" (1829 mm)	261.30	137465		
9885-96 - By-pass set for two 48" doors	96" (2438 mm)	297.55	137470		
9886 Packaged Sets for four (4) 24" doors up to 250 lbs. (113 kg) each.					
Contents: 9803 track, 8 ea. 9827 hangers w/ top mount plate, 2 ea. 9815 center stops, 2 ea. 9909 adjustable door guides.					
9886-96 - By-pass set for four 24" doors	96" (2438 mm)	424.25	137471	1	
Fascia is meant to be accompanied by decorative trim.					
9803-48 - Double box track w/ smooth fascia, heavy duty aluminum	48" (1219 mm)	AL	104.30	022482	2
9803-60 - Double box track w/ smooth fascia, heavy duty aluminum	60" (1524 mm)	AL	130.75	022483	
9803-72 - Double box track w/ smooth fascia, heavy duty aluminum	72" (1829 mm)	AL	155.60	022484	
9803-96 - Double box track w/ smooth fascia, heavy duty aluminum	96" (2438 mm)	AL	208.35	022485	
9803-120 - Double box track w/ smooth fascia, heavy duty aluminum	120" (3048 mm)	AL	259.70	022486	
9803-144 - Double box track w/ smooth fascia, heavy duty aluminum	144" (3658 mm)	AL	311.85	022487	
Components Description					
9815 Bumper Stop		7.10	096648	20	
9827 4 Wheel Ball bearing Hanger w/ Top Mount Plate		40.60	018292	10	
9909 Heavy Duty Adjustable Door Guide From 3/4" to 1-3/4" (19 mm to 44 mm)	US2C	8.10	097528	20	



Sliding Door Hardware - 9570 Packaged Sets - Bi-Fold



Description	Finish	2018 List	Stock No.	Case Qty.	
9570 Packaged Sets for doors up to 50 lbs (23 kg) bi-fold, 30 lbs per multi fold.					
Contents for 2 door set: 9601 Track, 9569 parts bag.					
Aluminum box track & hardware for 1" (25 mm) - 1-3/4" (44 mm) thick doors.					
9570-36 - Bi-fold set for two 18" doors	36" (914 mm)	AL	53.10	137161	6
9570-48 - Bi-fold set for four 12" doors	48" (1219 mm)	AL	77.95	137162	
9570-60 - Bi-fold set for four 15" doors	60" (1524 mm)	AL	84.05	137163	
9570-72 - Bi-fold set for four 18" doors	72" (1829 mm)	AL	90.30	137164	
9570-96 - Bi-fold set for four 24" doors	96" (2438 mm)	AL	102.00	137165	
9601-35 - Aluminum box track	35" (889 mm)	AL	12.65	097461	10
9601-47 - Aluminum box track	47" (1194 mm)	AL	17.30	096576	
9601-59 - Aluminum box track	59" (1499 mm)	AL	22.35	096577	
9601-71 - Aluminum box track	71" (1803 mm)	AL	24.35	096578	
9601-96 - Aluminum box track	96" (2438 mm)	AL	37.75	096579	
9601-120 - Aluminum box track	120" (3048 mm)	AL	42.15	096580	
9601-144 - Aluminum box track	144" (3658 mm)	AL	49.90	096581	
Parts Description					
9569 - 1 ea. 9572 hanger w/ top mount plate, 9618 pivot set, 9559 aligner, 9558 knob and 9815 bumper stop, 3 ea. 9220 hinges			23.50	016913	10
Components Description					
9220 Non-Mortise Bi-Fold Hinge with Screws		US2D	1.80	099119	600
9558 Wood Knob Knob Diameter: 1-1/2" Base Diameter: 15/16" Fasteners: #8 x 1-3/4" PPHWS		Wood	1.80	096567	100
9559 Aligner		US2D	1.00	096568	200
9572 4 Wheel Hanger w/ Top Mount Plate		US2D	11.85	135316	20
9815 Bumper Stop			7.10	096648	20
9618 Pivot Set - For 9570 series		-	8.10	137182	10



- For additional components, refer to component section. 2. Items with the price in **bold and red** are Quick Ship items and ship in 24 hours. Please use stock number when ordering. 3. U/M is each unless otherwise noted.
4. Packaged sets and parts bags are available with optional components by special quotation.



Sliding Door Hardware - 9860 and 9861 Packaged Sets - Bi-Fold



Description	Finish	2018 List	Stock No.	Case Qty.	
9860 Packaged Sets for doors up to 125 lbs (57 kg) per panel bi-fold.					
Contents: 9821 track, 1 ea. 9894 parts bag, and 3 ea. 1741 hinges Heavy duty Aluminum box track & hardware. For 1-3/8"(35mm) and 1-3/4"(44mm) thick doors.					
9860-30 - Bi-fold set for two 15" doors	30" (762 mm)	99.45	019456	6	
9860-36 - Bi-fold set for two 18" doors	36" (914 mm)	107.15	019452		
9860-48 - Bi-fold set for two 24" doors	48" (1219 mm)	119.75	019451		
9861 Packaged Sets for doors up to 125 lbs. (57 kg) per panel for multi-fold.					
Contents: 9821 track, 2 ea. 9894 parts bag, and 6 ea. 1741 hinges					
9861-48 - Bi-fold set for four 12" doors	48" (1219 mm)	191.10	019446	6	
9861-60 - Bi-fold set for four 15" doors	60" (1524 mm)	198.10	019439		
9861-72 - Bi-fold set for four 18" doors	72" (1829 mm)	211.85	019438		
9861-96 - Bi-fold set for four 24" doors	96" (2438 mm)	232.35	019437		
9821-59 - Aluminum box track	59" (1499 mm)	AL	30.90	019084	10
9821-71 - Aluminum box track	71" (1803 mm)	AL	38.30	019062	
9821-96 - Aluminum box track	96" (2438 mm)	AL	51.05	019061	
9821-144 - Aluminum box track	144" (3658 mm)	AL	73.95	019050	
Parts Description					
9894 - 1 ea. 9825 hanger w/ top mount plate, 9828 bi-fold pivot, 9815 bumper stop, 9559 aligner		88.00	019435	10	
Components Description					
1741 Full Mortise Plain Bearing Hinges with Screws 3-1/2" x 3-1/2"	US2D	1.90	029658	50	
9559 Aligner	US2D	1.00	096568	200	
9815 Bumper Stop		7.10	096648	20	
9825 Ball Bearing Hanger w/ Top Mount Plate		34.95	135321	10	
9828 Heavy Duty Pivot Set with 9815 Bumper Stop		50.50	018286	10	



Sliding Door Hardware - 9890 and 9891 Packaged Sets - Bi-Fold



Description	Finish	2018 List	Stock No.	Case Qty.	
9890 Packaged Sets for doors up to 125 lbs (57 kg).					
Contents: 9801 track, 9827 hangers w/ top mount plate, 9828 pivots & 1741 hinges (3 ea. for 2 doors, 6 ea. for 4 doors) Heavy duty aluminum box track & hardware for 1-1/8"(29mm) and 1-3/4"(44mm) thick doors.					
9890-30 - Bi-fold set for two 15" doors	30" (762 mm)	106.70	017732	6	
9890-36 - Bi-fold set for two 18" doors	36" (914 mm)	111.15	017444		
9890-48 - Bi-fold set for two 24" doors	48" (1219 mm)	124.55	017439		
9891-48 - Bi-fold set for four 12" doors	48" (1219 mm)	189.50	017438	6	
9891-60 - Bi-fold set for four 15" doors	60" (1524 mm)	199.85	017437		
9891-72 - Bi-fold set for four 18" doors	72" (1829 mm)	214.65	017436		
9891-96 - Bi-fold set for four 24" doors	96" (2438 mm)	236.15	017434		
9801-48 - Aluminum box track	48" (1219 mm)	AL	33.25	040426	6
9801-72 - Aluminum box track	72" (1829 mm)	AL	49.90	096641	
9801-96 - Aluminum box track	96" (2438 mm)	AL	67.00	096642	
9801-120 - Aluminum box track	120" (3048 mm)	AL	84.05	096643	
9801-144 - Aluminum box track	144" (3658 mm)	AL	109.75	096644	
9801-192 - Aluminum box track	192" (4877 mm)	AL	146.20	096645	
Components Description					
1741		US2D	1.90	029658	50
Full Mortise Plain Bearing Hinges with Screws 3-1/2" x 3-1/2"					
9827			40.60	018292	10
4 Wheel Ball bearing Hanger w/ Top Mount Plate					
9828			50.50	018286	10
Heavy Duty Pivot Set with 9815 Bumper Stop					



1. For additional components, refer to component section. 2. Items with the price in **bold and red** are Quick Ship items and ship in 24 hours. Please use stock number when ordering. 3. U/M is each unless otherwise noted.
4. Packaged sets and parts bags are available with optional components by special quotation.



Sliding Door Hardware - 9110 and 9130 Packaged Sets - Pocket Door



Description	Finish	2018 List	Stock No.	Case Qty.	
9110 Packaged Sets for doors up to 175 lbs (79 kg) per door.					
Contents: 9101 track, 9109 parts bag Heavy duty aluminum I-beam track & hardware for 1"(25mm) thick doors.					
9110-60 - Packaged set for 2'6" door	60" (1524 mm)	117.55	135334	5	
9110-72 - Packaged set for 3'0" door	72" (1829 mm)	129.95	135335		
9110-84 - Packaged set for 3'6" door	84" (2134 mm)	141.55	135336		
9110-96 - Packaged set for 4'0" door	96" (2438 mm)	154.05	135337		
9110-120 - Packaged set for 5'0" door	120" (3048 mm)	158.60	135338		
9110-144 - Packaged set for 6'0" door	144" (3658 mm)	185.75	135339		
9130 Packaged Sets for doors up to 275 lbs (125 kg) per door.					
Contents: 9101 track, 9129 parts bag					
9130-60 - Packaged set for 2'6" door	60" (1524 mm)	150.15	135340	5	
9130-72 - Packaged set for 3'0" door	72" (1829 mm)	161.00	135341		
9130-84 - Packaged set for 3'6" door	84" (2134 mm)	162.60	135342		
9130-96 - Packaged set for 4'0" door	96" (2438 mm)	177.25	135343		
9130-120 - Packaged set for 5'0" door	120" (3048 mm)	209.80	135344		
9130-144 - Packaged set for 6'0" door	144" (3658 mm)	234.10	135346		
9101-60 - I-beam track only, heavy duty aluminum	60" (1524 mm)	AL	54.85	023278	5
9101-72 - I-beam track only, heavy duty aluminum	72" (1829 mm)	AL	68.65	096508	
9101-84 - I-beam track only, heavy duty aluminum	84" (2134 mm)	AL	81.80	096509	
9101-96 - I-beam track only, heavy duty aluminum	96" (2438 mm)	AL	87.45	096707	
9101-120 - I-beam track only, heavy duty aluminum	120" (3048 mm)	AL	114.40	096511	
9101-144 - I-beam track only, heavy duty aluminum	144" (3658 mm)	AL	137.65	096512	
9101-192 - I-beam track only, heavy duty aluminum	192" (4877 mm)	AL	182.75	096513	
Parts Description					
9109 - 2 ea. 9102 two wheel hangers, 1 ea. 9115 floor guide. <i>*Up to 175 lbs (79 kg) per door.*</i>		56.95	135690	10	
9129 - 2 ea. 9105 four wheel hangers, 1 ea. 9115 floor guide <i>*Up to 275 lbs (125 kg) per door.*</i>		84.05	135315	10	
Components Description					
9102 2 Wheel Hanger - For use with 9101 track	US2C	25.00	135310	20	
9105 4 Wheel Hanger - For use with 9101 track	US2C	39.50	135312	40	
9115 Bottom Door Guide	US2C	8.85	096522	50	



Sliding Door Hardware - 9628 | 9629 | 9630 | 9631 - Pocket Door Framed Kits



Description		Finish	2018 List	Stock No.	Case Qty.
9628 - For 3'0" wide x 9'0" high doors up to 150 lbs (68 kg) per door.	108" (2743 mm)	AL	245.70	136339	1
9629 - For 3'0" wide x 8'0" high doors up to 150 lbs (68 kg) per door.	96" (2134 mm)	AL	223.85	136341	1
9630 - For 3'0" wide x 7'0" high doors up to 150 lbs (68 kg) per door.	84" (2134 mm)	AL	219.30	136343	1
9631 - For 3'0" wide x 6'8" high doors up to 150 lbs (68 kg) per door.	80" (2032 mm)	AL	140.10	137180	1

Note: Packaged sets contents: 9601 track, 1 header assembly, 2 pair of split studs, 2 floor plates and 2 end brackets, 2 each 9606 ball bearing hangers w/ top mount plate, 1 each 9881 bumper, and 1 each 9883 door guide set. For 1-3/8"(35mm) and 1-3/4"(44 mm) thick doors.

Replacement Description					
9601-71 - Aluminum box track	71" (1803 mm)	AL	24.35	096578	10
9601-84 - Aluminum box track	84" (2134 mm)	AL	32.90	045141	
9601-96 - Aluminum box track	96" (2438 mm)	AL	37.75	096579	
9601-120 - Aluminum box track	120" (3048 mm)	AL	42.15	096580	
9601-144 - Aluminum box track	144" (3658 mm)	AL	49.90	096581	
9606 4 Wheel Ball Bearing Hanger w/ Top Mount Plate		US2D	17.30	135318	20
9881 Rubber Bumper			1.00	096685	80
9883 2-Piece Door Guide set with screws			3.70	096686	100



- For additional components, refer to component section. 2. Items with the price in **bold and red** are Quick Ship items and ship in 24 hours. Please use stock number when ordering. 3. U/M is each unless otherwise noted.
4. Packaged sets and parts bags are available with optional components by special quotation.



Sliding Door Hardware - 9678 Packaged Sets - Pocket Door

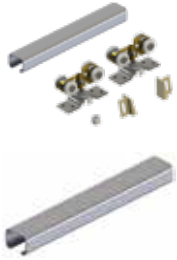

Description	Finish	2018 List	Stock No.	Case Qty.		
9678 Packaged Sets up to 125 lbs. (57 kg) per door.						
Contents: 9601 track, 9632 parts bag. For 1-3/8" (35mm) and 1-3/4" (44mm) thick doors. Heavy duty Aluminum box track & hardware						
9678-72 - Pocket set for 3' door		72" (1829 mm)	83.20	136354	6	
9678-96 - Pocket set for 4' door		96" (2438 mm)	99.65	136356		
9601-71 - Box track only, heavy duty aluminum		71" (1803 mm)	AL	24.35	096578	6
9601-84 - Box track only, heavy duty aluminum		84" (2134 mm)	AL	32.90	045141	
9601-96 - Box track only, heavy duty aluminum		96" (2438 mm)	AL	37.75	096579	
9601-120 - Box track only, heavy duty aluminum		120" (3048 mm)	AL	42.15	096580	
9601-144 - Box track only, heavy duty aluminum		144" (3658 mm)	AL	49.90	096581	
Parts Description						
9632 - 2 ea. 9605 hangers w/ top mount plate, 1 ea. 9883 door guide, 1 ea. 9881 bumper. <i>*Up to 125 lbs (57 kg) per door.*</i>			32.90	135322	10	
9633 - 2 ea. 9606 ball bearing hangers w/ top mount plate, 1 ea. 9883 door guide, 1 ea. 9881 bumper. <i>*Up to 150 lbs (69 kg) per door.*</i>			54.55	135323		
Components Description						
9605 4 Wheel Hanger w/ Top Mount Plate	US2D		5.55	135317	20	
9606 4 Wheel Ball Bearing Hanger w/ Top Mount Plate	US2D		17.30	135318	20	
9881 Rubber Bumper			1.00	096685	80	
9883 2-Piece Door Guide set with screws			3.70	096686	100	



Sliding Door Hardware - 9850 - Pocket Door Framed Kits



Description		Finish	2018 List	Stock No.	Case Qty.
9850 - For 4'0" wide x 8'0" high doors, up to 250 lbs.(113 kg) per door.	96" (2438 mm)	AL	393.25	139083	1
9850 - For 4'0" wide x 8'6" high doors, up to 250 lbs.(113 kg) per door.	102" (2591 mm)	AL	458.45	139085	1
Note: Packaged sets contents: 9801 track, 1 header assembly, 3 pairs of split studs, 2 each 9827 hangers w/ top mount plate, 1 ea. 9881 bumper, 1ea. 9883 door guide set, 3 floor plates and 2 end brackets. For 1-3/8"(35mm) and 1-3/4"(44mm) thick doors.					
Replacement Description					
9801-72 - Box Track only, Heavy Duty Aluminum	72" (1829 mm)	AL	49.90	096641	5
9801-96 - Box Track only, Heavy Duty Aluminum	96" (2438 mm)	AL	67.00	096642	
9801-120 - Box Track only, Heavy Duty Aluminum	120" (3048 mm)	AL	84.05	096643	
9801-144 - Box Track only, Heavy Duty Aluminum	144" (3658 mm)	AL	109.75	096644	
9801-192 - Box Track only, Heavy Duty Aluminum	192" (4877 mm)	AL	146.20	096645	
9827 4 Wheel Ball bearing Hanger w/ Top Mount Plate			40.60	018292	10
9881 Rubber Bumper			1.00	096685	80
9883 2-Piece Door Guide set with screws			3.70	096686	100

1. For additional components, refer to component section. 2. Items with the price in **bold and red** are Quick Ship items and ship in 24 hours. Please use stock number when ordering. 3. U/M is each unless otherwise noted.
4. Packaged sets and parts bags are available with optional components by special quotation.



Sliding Door Hardware - 9878 Packaged Sets - Pocket Door



Description	Finish	2018 List	Stock No.	Case Qty.	
9878 Packaged Sets for doors up to 250 lbs. (113 kg) per door.					
For doors 1-3/8" (35 mm) thick and up. Contents: 9801 track, 9742 parts bag					
9878-72 - Pocket set for 3' door		72" (1829 mm)	134.95	137425	6
9878-96 - Pocket set for 4' door		96" (2438 mm)	179.80	137426	
9801-72 - Box track only, heavy duty aluminum		72" (1829 mm)	AL 49.90	096641	10
9801-96 - Box track only, heavy duty aluminum		96" (2438 mm)	AL 67.00	096642	
9801-120 - Box track only, heavy duty aluminum		120" (3048 mm)	AL 84.05	096643	
9801-144 - Box track only, heavy duty aluminum		144" (3658 mm)	AL 109.75	096644	
9801-192 - Box track only, heavy duty aluminum		192" (4877 mm)	AL 146.20	096645	
Parts Description					
9742 - 2 ea. 9827 hangers w/ top mount plate, 1 ea. 9883 guide set, 1 ea. 9881 bumper			85.70	137418	10
Components Description					
9827 4 Wheel Ball bearing Hanger w/ Top Mount Plate			40.60	018292	10
9881 Rubber Bumper			1.00	096685	80
9883 2-Piece Door Guide set with screws			3.70	096686	100



Sliding Door Hardware - 9901 Packaged Sets - Pocket Door



Description	Finish	2018 List	Stock No.	Case Qty.
9901 Packaged Sets for doors up to 250 lbs. (113 kg)				
Contents: 9821 track, 9895 parts bag				
Extra heavy duty Aluminum box track & hardware for 1-3/8"(35mm) and 1-3/4"(44mm) thick doors.				
9901-72 - Pocket set for 3' doors	72" (1829 mm)	141.70	019361	6
9901-96 - Pocket set for 4' doors	96" (2438 mm)	158.60	019358	
9821-59 - Aluminum box track	59" (1499 mm)	AL 30.90	019084	10
9821-71 - Aluminum box track	71" (1803 mm)	AL 38.30	019062	
9821-96 - Aluminum box track	96" (2438 mm)	AL 51.05	019061	
9821-144 - Aluminum box track	144" (3658 mm)	AL 73.95	019050	
Parts Description				
9895 - 2 ea. 9825 hangers w/ top mount plate, 1 ea. 9883 guide set, 1 ea. 9881 bumper		69.90	019408	10
Components Description				
9825 Ball Bearing Hanger w/ Top Mount Plate		34.95	135321	10
9881 Rubber Bumper		1.00	096685	80
9883 2-Piece Door Guide set with screws		3.70	096686	100

1. For additional components, refer to component section. 2. Items with the price in **bold and red** are Quick Ship items and ship in 24 hours. Please use stock number when ordering. 3. U/M is each unless otherwise noted.
4. Packaged sets and parts bags are available with optional components by special quotation.



Sliding Door Hardware - 9710 Packaged Sets - Wall-Mount

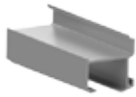

Description	Finish	2018 List	Stock No.	Case Qty.	
9710 Packaged Sets for heavy duty single doors and bi-parting doors up to 250 lbs. (113kg)					
Contents of Packaged Sets: 9703 track, 9704 fascia, 9705 end caps and 9711 parts bags. (2 ea. 9711 parts bags included in 144" pkg set.) Heavy duty aluminum wall-mount box track, anodized fascia, end caps and hardware for 1"(25mm and 1-3/4"(44mm) thick doors.					
9710-60 - Wall-Mount Packaged Set for 1 Door	60" (1524 mm)	CLA	222.05	160955	1
9710-72 - Wall-Mount Packaged Set for 1 Door	72" (1829 mm)	CLA	235.65	160958	
9710-96 - Wall-Mount Packaged Set for 1 Door	96" (2438 mm)	CLA	271.90	160959	
9710-144 - Wall-Mount Packaged Set for 1 or 2 Doors	144" (3658 mm)	CLA	453.20	160991	
9710-60 - Wall-Mount Packaged Set for 1 Door	60" (1524 mm)	DBA	277.60	160961	1
9710-72 - Wall-Mount Packaged Set for 1 Door	72" (1829 mm)	DBA	294.60	160962	
9710-96 - Wall-Mount Packaged Set for 1 Door	96" (2438 mm)	DBA	339.90	160963	
9710-144 - Wall-Mount Packaged Set for 1 or 2 Doors	144" (3658 mm)	DBA	577.05	160989	
9703-60 - Wall-Mount Track-mill finish	60" (1524 mm)	ALM	66.65	160984	5
9703-72 - Wall-Mount Track-mill finish	72" (1829 mm)	ALM	70.70	160985	
9703-96 - Wall-Mount Track-mill finish	96" (2438 mm)	ALM	81.60	160986	
9703-144 - Wall-Mount Track-mill finish	144" (3658 mm)	ALM	156.55	160988	
9703-60 - Wall-Mount Track- dark bronze anodized	60" (1524 mm)	DBA	103.00	160993	5
9703-72 - Wall-Mount Track- dark bronze anodized	72" (1829 mm)	DBA	109.70	160994	
9703-96 - Wall-Mount Track- dark bronze anodized	96" (2438 mm)	DBA	126.70	160995	
9703-144 - Wall-Mount Track- dark bronze anodized	144" (3658 mm)	DBA	243.10	160996	
9704-60 - Wall-Mount Fascia- clear anodized	60" (1524 mm)	CLA	86.65	161003	5
9704-72 - Wall-Mount Fascia- clear anodized	72" (1829 mm)	CLA	91.95	161004	
9704-96 - Wall-Mount Fascia- clear anodized	96" (2438 mm)	CLA	106.10	161005	
9704-144 - Wall-Mount Fascia- clear anodized	144" (3658 mm)	CLA	203.95	161006	
9704-60 - Wall-Mount Fascia-dark bronze anodized	60" (1524 mm)	DBA	133.90	161009	5
9704-72 - Wall-Mount Fascia-dark bronze anodized	72" (1829 mm)	DBA	142.85	161010	
9704-96 - Wall-Mount Fascia-dark bronze anodized	96" (2438 mm)	DBA	164.55	161011	
9704-144 - Wall-Mount Fascia-dark bronze anodized	144" (3658 mm)	DBA	315.20	161012	
Parts Description					
9705 - End Cap Set- anodized		CLA	68.00	161013	10
		DBA	81.60	161014	10
9711 - Parts Bag: 2 ea. 9827 hangers w/ top mount plate, 1 ea. 9115 bottom door guide, 4 ea 9815 bumper stops			66.95	161015	10
Components Description					
9115 Bottom Door Guide		US2C	8.85	096522	50
9815 Bumper Stop			7.10	096648	20
9827 4 Wheel Ball Bearing Hanger w/ Top Mount Plate			40.60	018292	10



Sliding Door Hardware - Components



Description	Finish	2018 List	Stock No.	Case Qty.
330D	US3		086840	20
Pocket Door Latch	US5		086841	
Material: Cast brass	US10	Refer	066707	
Fits: 1-3/8" - 1-3/4" door	US10B	to Trim	056768	
Size: 2-3/4" x 2-1/2"	US15	section	078972	
Finger Pull Extends: 1-3/8"	US15A	for	054061	
Fasteners: #6 x 5/8" OPHWS	US19	pricing	054570	
	US26		086837	
	US26D		086838	



330L	US3		143162	20
Privacy Pocket Door Latch	US5		143164	
Material: Brass	US10	Refer	014365	
Size: 2-3/4" x 2-1/2"	US10B	to Trim	143158	
Finger Pull Extends: 1-3/8"	US15	section	143159	
Strike: 1" x 2-1/4"	US15A	for	143160	
1-3/8" doors	US19	pricing	143166	
Fasteners: #6 x 5/8" OPHWS; #6 x 3/4" FPHWS	US26		143167	
	US26D		143161	



330M	US3		143172	20
Privacy Pocket Door Latch	US5		143178	
Material: Brass	US10	Refer	143168	
Size: 2-3/4" x 2-1/2"	US10B	to Trim	143169	
Finger Pull Extends: 1-3/8"	US15	section	143173	
Strike: 1" x 2-1/4"	US15A	for	143174	
1-3/4" doors	US19	pricing	143175	
Fasteners: #6 x 5/8" OPHWS; #6 x 3/4" FPHWS	US26		143170	
	US26D		143171	



1741	US2D	1.90	029658	50
Full Mortise Plain Bearing				
Hinges with Screws				
3-1/2" x 3-1/2"				



2610	US3	0.95	013049	500
Finger Pull	US4	0.95	071953	
Material: Brass	US5	0.95	067282	
Overall Diameter: 31/32"	US10A	0.95	068711	
Finger Pull Diameter: 3/4"	US15	0.95	040589	
Pull Clearance: 5/16"	US15A	0.95	040590	
Projection: 1/32"	US26	0.95	013047	
	US26D	0.95	071169	













2620	US3	1.60	013081	50
Round Flush Pull	US4	1.60	072997	
Material: Brass	US5	1.60	072148	
Overall Diameter: 31/32"	US10A	1.60	072534	
Finger Pull Diameter: 1-11/16"	US15	1.60	072624	
Pull Clearance: 11/32"	US15A	1.60	072158	
Projection: 5/64"	US26	1.60	072554	
	US26D	1.60	075322	

- For additional components, refer to component section.
- Items with the price in **bold and red** are Quick Ship items and ship in 24 hours. Please use stock number when ordering.
- U/M is each unless otherwise noted.
- Packaged sets and parts bags are available with optional components by special quotation.



Sliding Door Hardware - Components

	Description	Finish	2018 List	Stock No.	Case Qty.	
	2630	US3	4.15	051919	50	
	Round Flush Pull	US4	4.15	073783		
	Material: Brass	US5	4.15	053163		
	Overall Diameter: 2-7/16"	US10A	4.15	073053		
	Finger Pull Diameter: 2-1/16"	US15	4.15	073056		
	Pull Clearance: 11/32"	US15A	4.15	005307		
	Projection: 3/32"	US26	4.15	023430		
		US26D	4.15	023431		
	2640	US3	5.85	096760	50	
	Oblong Flush Pull	US4	5.85	075056		
	Material: Brass	US5	5.85	074270		
	Size: 1-5/16" x 2-3/4"	US10A	5.85	074533		
	Cup Clearance: 5/16"	US15	5.85	074711		
	Fasteners: #6 x 5/8" OPHWS	US15A	5.85	074350		
		US26	5.85	026751		
		US26D	5.85	074664		
	9101-60	60" (1524 mm)	AL	54.85	023278	5
	I-beam track, heavy duty aluminum	72" (1829 mm)	AL	68.65	096508	
		84" (2134 mm)	AL	81.80	096509	
		96" (2438 mm)	AL	87.45	096707	
		120" (3048 mm)	AL	114.40	096511	
		144" (3658 mm)	AL	137.65	096512	
	192" (4877 mm)	AL	182.75	096513		
	9102	US2C	25.00	135310	20	
	2 Wheel Hanger					
	9105	US2C	37.50	135312	40	
	4 Wheel Hanger					
	9109		56.95	135690	10	
	Parts Bag: 2 ea. 9102 two wheel hangers, 1 ea. 9115 floor guide					
	9111	US2C	4.10	096516	20	
	Bottom Roller Guide					
	9113	AL	53.90	135314	10	
	Stop					
	9114-72 - Bottom Guide Track- 72"	72" (1829 mm)	AL	40.60	096519	5
	9114-96 - Bottom Guide Track- 96"	96" (2438 mm)	AL	53.90	096520	5
	9114-144 - Bottom Guide Track- 144"	144" (3658 mm)	AL	81.00	096521	5
	9115	US2C	8.85	096522	50	
	Bottom Door Guide					



Sliding Door Hardware - Components



Description	Finish	2018 List	Stock No.	Case Qty.
9121 Roller Guide - For use with 9122 guide	US2C	16.65	137181	20
9122-48 - Bottom Guide Channel - 3/4" wide x 5/8" tall	AL	21.15	096557	5
9122-60 - Bottom Guide Channel - 3/4" wide x 5/8" tall	AL	26.65	096558	5
9122-72 - Bottom Guide Channel - 3/4" wide x 5/8" tall	AL	31.25	096559	5
9122-96 - Bottom Guide Channel - 3/4" wide x 5/8" tall	AL	41.45	096560	5
9122-120 - Bottom Guide Channel - 3/4" wide x 5/8" tall	AL	52.20	096605	5
9122-132 - Bottom Guide Channel - 3/4" wide x 5/8" tall	AL	56.95	096606	5
9122-144 - Bottom Guide Channel - 3/4" wide x 5/8" tall	AL	62.30	096607	5
9122-192 - Bottom Guide Channel - 3/4" wide x 5/8" tall	AL	83.20	096608	5
9128 Bottom Pivot Bolt and Door Plate with Bottom Pivot Floor Bracket	US2C	39.60	023150	10
9129 Parts Bag: 2 ea. 9105 4-wheel hangers, 1 ea. 9115 floor guide		84.05	135315	10
9169 Top Pivot Assembly	US2C	8.85	096635	10
9200 Hanger - Small 3/8" (10 mm) offset A		1.80	016575	100
9201 Hanger - Large 1 1/16" (18 mm) offset B	US2C	1.80	096561	100
9202 Twin Wheel Hanger - Large 1 1/16" (18 mm) offset B	US2C	3.35	096562	100
9203 Twin Wheel Hanger - Small 3/8" (10 mm) offset A	US2C	3.35	017007	100
9220 Non-Mortise Bi-Fold Hinge with Screws	US2D	1.80	099119	600
9262 - Keyed Lock for pocket door applications	US3	43.70	098994	6
	US26D	44.85	016724	
9264 - Keyed Lock for bifold applications	US3	37.50	016725	6
Keyed Lock - Keyed Alike	US3	37.50	002801	
9268 - Keyed Lock for bypass applications	US3	42.15	016726	6
	US26D	42.95	099251	
Keyed Lock - Keyed Alike	US3	42.15	002804	6
	US26D	42.95	002802	

- For additional components, refer to component section. 2. Items with the price in **bold and red** are Quick Ship items and ship in 24 hours. Please use stock number when ordering. 3. U/M is each unless otherwise noted.
4. Packaged sets and parts bags are available with optional components by special quotation.



Sliding Door Hardware - Components



Description	Finish	2018 List	Stock No.	Case Qty.
9351 Door Guide		2.65	096563	50
9353 Adjustable Door Guide		2.65	096564	20
9354 Carpet Riser	US2C	1.80	003633	50
	US2D	1.80	096565	50
9400 Cam Adjustable Hanger - Small 3/8" (10 mm) offset A	US2C	3.35	017417	100
9401 Cam Adjustable Hanger - Large 11/16" (18 mm) offset B	US2C	3.35	096566	100
9540 Parts Bag: 4 ea. 9401 hangers, 2 ea. 2610 pulls, 1 ea. 9351 guide		9.55	017419	10
9544 Parts Bag: 4 ea. 9202 hangers, 2 ea. 2630 pulls, 1 ea. 9351 guide Used to increase door weight capacity to 75 lbs		14.15	017035	10
9558 Wood Knob Knob Diameter: 1-1/2" Base Diameter: 15/16" Fasteners: #8 x 1-3/4" PPHWS	Wood	1.80	096567	100
9559 Aligner	US2D	1.00	096568	200
9566 Knob Material: Zinc Knob Diameter: 1-1/4" Projection: 1" Fasteners: #8 - 32 x 2" PPHMS; #8 - 32 x 1-3/4" PPHMS	US3	6.80	099824	100
	US4	7.65	098635	
	US5	7.65	028859	
	US10A	7.65	098634	
	US10B	7.65	098633	
	US15	7.65	098632	
	US15A	7.65	098629	
	US26	6.80	098628	
US26D	7.65	098627		



Sliding Door Hardware - Components



Description	Finish	2018 List	Stock No.	Case Qty.		
9567 Rose - For use with 9566 knob Material: Zinc Base Diameter: 1-3/4" Projection: 15/32" Fasteners: #8 - 32 x 2" PPHMS; #8 - 32 x 1-3/4" PPHMS	US3	3.20	099825	100		
	US4	3.40	098626			
	US5	3.40	018102			
	US10A	3.40	098625			
	US10B	3.40	098624			
	US15	3.40	098623			
	US15A	3.40	098622			
	US26	3.20	098621			
	US26D	3.40	098620			
	9569 Parts Bag: 1 ea. 9572 hanger w/ top mount plate, 9618 pivot set, 9559 aligner, 9558 knob and 9815 bumper stop, 3 ea. 9220 hinges		23.50	016913	10	
9572 4-Wheel Hanger w/ Top Mount Plate	US2D	11.85	135316	20		
9573 Spacer Kit - 3/8" use with 9821 track - For doors 1-3/4" thick		4.95	019014	5		
9574 Spacer Kit - For use with 9801 - For doors 1-3/8" and 1-3/4" thick		4.95	015991	5		
9575 Parts Bag: 4 ea. 9572 hangers w/ top mount plate, 1 ea. 9909 guide		27.45	137167	5		
9601-71 - Aluminum box track		71" (1803 mm)	AL	24.35	096578	
9601-84 - Aluminum box track		84" (2134 mm)	AL	32.90	045141	
9601-96 - Aluminum box track		96" (2438 mm)	AL	37.75	096579	
9601-120 - Aluminum box track		120" (3048 mm)	AL	42.15	096580	
9601-144 - Aluminum box track		144" (3658 mm)	AL	49.90	096581	
9602-46 - Double box track only, heavy duty aluminum		46" (1168 mm)	AL	32.90	096582	5
9602-58 - Double box track only, heavy duty aluminum		58" (1473 mm)	AL	40.60	096583	
9602-70 - Double box track only, heavy duty aluminum		70" (1778 mm)	AL	46.85	096584	
9602-94 - Double box track only, heavy duty aluminum		94" (2388 mm)	AL	60.75	096585	
9602-118 - Double box track only, heavy duty aluminum		118" (2997 mm)	AL	73.25	096586	
9602-142 - Double box track only, heavy duty aluminum		142" (3607 mm)	AL	87.20	096587	
9603-48 - Aluminum box track with fascia		48" (1219 mm)	AL	60.75	135288	5
9603-60 - Aluminum box track with fascia		60" (1524 mm)	AL	73.25	135289	
9603-72 - Aluminum box track with fascia		72" (1829 mm)	AL	87.20	135290	
9603-96 - Aluminum box track with fascia		96" (2438 mm)	AL	113.70	135291	
9603-120 - Aluminum box track with fascia		120" (3048 mm)	AL	142.40	029359	
9603-144 - Aluminum box track with fascia		144" (3658 mm)	AL	175.05	029360	
9605 4-Wheel Hanger w/ Top Mount Plate	US2D	5.55	135317	20		

- For additional components, refer to component section.
- Items with the price in **bold and red** are Quick Ship items and ship in 24 hours. Please use stock number when ordering.
- U/M is each unless otherwise noted.
- Packaged sets and parts bags are available with optional components by special quotation.



Sliding Door Hardware - Components



Description	Finish	2018 List	Stock No.	Case Qty.	
9606 4-Wheel Ball Bearing w/ Top Mount Plate	US2D	17.30	135318	20	
9610 Replacement Top Mount Plate	US2C	1.80	142410	20	
9618 Pivot Set - For 9570 series	-	8.10	137182	10	
9632 Pocket Parts Bag -125 lbs (57 kg) Consists of: 2 ea. 9605 hangers w/ top mount plate, 1 ea. 9883 guide set, 1 ea. 9881 bumper		32.90	135322	10	
9633 Parts Bag : 2 ea. 9606 ball bearing hangers w/ top mount plate, 1 ea. 9883 guide set, 1 ea. 9881 bumper		54.55	135323	10	
9634 Pocket Door Adapter Kit For 1-3/4" (45 mm) thick doors		8.50	097519	10	
9639 Double Pocket Door Adapter Kit Joins two frames in middle of doorway	US2C	24.35	096595	1	
9679 4 ea. 9605 hangers w/ top mount plate, 1 ea. 9909 guide		38.30	137179	20	
9680 4 ea. 9606 ball bearing hangers w/ top mount plate, 1 ea. 9909 guide		90.30	136357	20	
9703-60 - Wall-Mount Track-mill finish	60" (1524 mm)	ALM	66.65	160984	5
9703-72 - Wall-Mount Track-mill finish	72" (1829 mm)	ALM	70.70	160985	
9703-96 - Wall-Mount Track-mill finish	96" (2438 mm)	ALM	81.60	160986	
9703-144 - Wall-Mount Track-mill finish	144" (3658 mm)	ALM	156.55	160988	
9703-60 - Wall-Mount Track- dark bronze anodized	60" (1524 mm)	DBA	103.00	160993	5
9703-72 - Wall-Mount Track- dark bronze anodized	72" (1829 mm)	DBA	109.70	160994	
9703-96 - Wall-Mount Track- dark bronze anodized	96" (2438 mm)	DBA	126.70	160995	
9703-144 - Wall-Mount Track- dark bronze anodized	144" (3658 mm)	DBA	243.10	160996	



Sliding Door Hardware - Components



Description		Finish	2018 List	Stock No.	Case Qty.
9704-60 - Wall-Mount Fascia- clear anodized	60" (1524 mm)	CLA	86.65	161003	5
9704-72 - Wall-Mount Fascia- clear anodized	72" (1829 mm)	CLA	91.95	161004	
9704-96 - Wall-Mount Fascia- clear anodized	96" (2438 mm)	CLA	106.10	161005	
9704-144 - Wall-Mount Fascia- clear anodized	144" (3658 mm)	CLA	203.95	161006	
9704-60 - Wall-Mount Fascia-dark bronze anodized	60" (1524 mm)	DBA	133.90	161009	5
9704-72 - Wall-Mount Fascia-dark bronze anodized	72" (1829 mm)	DBA	142.85	161010	
9704-96 - Wall-Mount Fascia-dark bronze anodized	96" (2438 mm)	DBA	164.55	161011	
9704-144 - Wall-Mount Fascia-dark bronze anodized	144" (3658 mm)	DBA	315.20	161012	
9705 - End Cap Set- anodized		CLA	68.00	161013	10
		DBA	81.60	161014	10
9709-60 - Fascia only, 2-3/4" (70 mm) wide	60" (1524 mm)	AL	51.55	023322	
9709-72 - Fascia only, 2-3/4" (70 mm) wide	72" (1829 mm)	AL	59.15	096603	
9709-96 - Fascia only, 2-3/4" (70 mm) wide	96" (2438 mm)	AL	67.00	096604	
9711			66.95	161015	10
Parts Bag: 2 ea. 9827 hangers w/ top mount plate, 1 ea. 9115 bottom door guide, 4 ea. 9815 bumper stops					
9742			85.70	137418	10
Parts Bag: 2 ea. 9816 hangers w/ top mount plate, 1 ea. 9883 guide set, 1 ea. 9881 bumper					
9801-72 - Box Track, Heavy Duty Aluminum	72" (1829 mm)	AL	49.90	096641	5
9801-96 - Box Track, Heavy Duty Aluminum	96" (2438 mm)	AL	67.00	096642	
9801-120 - Box Track, Heavy Duty Aluminum	120" (3048 mm)	AL	84.05	096643	
9801-144 - Box Track, Heavy Duty Aluminum	144" (3658 mm)	AL	109.75	096644	
9801-192 - Box Track, Heavy Duty Aluminum	192" (4877 mm)	AL	146.20	096645	
9803-48 - Double Box Track w/ Fascia, Heavy Duty Aluminum	48" (1219 mm)	AL	104.30	022482	2
9803-60 - Double Box Track w/ Fascia, Heavy Duty Aluminum	60" (1524 mm)	AL	130.75	022483	
9803-72 - Double Box Track w/ Fascia, Heavy Duty Aluminum	72" (1829 mm)	AL	155.60	022484	
9803-96 - Double Box Track w/ Fascia, Heavy Duty Aluminum	96" (2438 mm)	AL	208.35	022485	
9803-120 - Double Box Track w/ Fascia, Heavy Duty Aluminum	120" (3048 mm)	AL	259.70	022486	
9803-144 - Double Box Track w/ Fascia, Heavy Duty Aluminum	144" (3658 mm)	AL	311.85	022487	
9809-72 - Aluminum Fascia, 3-7/8" (98 mm) high	72" (1829 mm)	AL	92.65	096646	10
9809-96 - Aluminum Fascia, 3-7/8" (98 mm) high	96" (2438 mm)	AL	121.35	096647	
9810-46 - Aluminum Track	46-3/8" (1178 mm)	AL	15.80	019702	10
9810-58 - Aluminum Track	58-3/8" (1483 mm)	AL	18.85	019703	
9810-70 - Aluminum Track	70-3/8" (1788 mm)	AL	22.90	019704	
9810-93 - Aluminum Track	93-3/8" (2372 mm)	AL	29.65	019705	
9810-120 - Aluminum Track	120" (3048 mm)	AL	37.50	016570	
9810-144 - Aluminum Track	144" (3658 mm)	AL	49.90	026064	

- For additional components, refer to component section.
- Items with the price in **bold and red** are Quick Ship items and ship in 24 hours. Please use stock number when ordering.
- U/M is each unless otherwise noted.
- Packaged sets and parts bags are available with optional components by special quotation.



Sliding Door Hardware - Components



Description	Finish	2018 List	Stock No.	Case Qty.	
9814 Parts bag: 2 ea. 9400 hangers, 2 ea. 9401 hangers, 2 ea. 2610 pulls, 1 ea. 9353 guide set. For 1" to 1-1/8" doors, specify 9841 parts bag.		14.95	016772	10	
9815 Bumper Stop		7.10	096648	20	
9820-48 - Aluminum track with 1-3/4" grooved fascia	48" (1219 mm)	AL	29.05	000461	5
9820-60 - Aluminum track with 1-3/4" grooved fascia	60" (1524 mm)	AL	36.05	000462	
9820-72 - Aluminum track with 1-3/4" grooved fascia	72" (1829 mm)	AL	42.15	000463	
9820-84 - Aluminum track with 1-3/4" grooved fascia	84" (2134 mm)	AL	56.95	028175	
9820-96 - Aluminum track with 1-3/4" grooved fascia	96" (2438 mm)	AL	62.30	099664	
9820-120 - Aluminum track with 1-3/4" grooved fascia	120" (3048 mm)	AL	71.75	000464	
9820-144 - Aluminum track with 1-3/4" grooved fascia	144" (3658 mm)	AL	93.45	000460	
9821-59 - Aluminum box track	59" (1499 mm)	AL	30.90	019084	10
9821-71 - Aluminum box track	71" (1803 mm)	AL	38.30	019062	
9821-96 - Aluminum box track	96" (2438 mm)	AL	51.05	019061	
9821-144 - Aluminum box track	144" (3658 mm)	AL	73.95	019050	
9824 4-Wheel Hanger w/ Top Mount Plate		27.80	135320	20	
9825 4-Wheel Ball Bearing Hanger w/ Top Mount Plate		34.95	135321	10	
9827 4-Wheel Ball bearing Hanger w/ Top Mount Plate		40.60	018292	10	
9828 Heavy Duty Pivot Set with 9815 Bumper Stop		50.50	018286	10	
9840-46 - Galvanized steel track	45-1/2" (1156 mm)	US2H	9.55	000931	10
9840-58 - Galvanized steel track	57-1/2" (1461 mm)	US2H	11.10	000932	
9840-70 - Galvanized steel track	69-1/2" (1765 mm)	US2H	13.45	000933	
9840-81 - Galvanized steel track	80-1/2" (2045 mm)	US2H	15.80	017893	
9840-93 - Galvanized steel track	92-1/2" (2350 mm)	US2H	17.30	017006	
9840-120 - Galvanized steel track	120" (3048 mm)	US2H	22.30	017854	
9840-144 - Galvanized steel track	144" (3658 mm)	US2H	26.80	017855	



Sliding Door Hardware - Components



Description	Finish	2018 List	Stock No.	Case Qty.
9841 Parts Bag: 4 ea. 9402 hangers, 2 ea. 9865 pulls, 1 ea. 9351 guide		8.10	099665	10



9842 Parts Bag: 4 ea. 9402 hangers, 2 ea. 9630 pulls, 1 ea. 9351 guide		11.10	017424	10
--	--	-------	--------	----



9843 Parts Bag: 4 ea. 9401 hangers, 2 ea. 9865 pulls, 1 ea. 9351 guide. Used to increase door weight capacity to 75 lbs		12.65	016912	10
---	--	-------	--------	----



9865 Plastic Pull Overall Diameter: 1-31/32" Finger Pull Diameter: 1-19/32" Pull Clearance: 11/32" Projection: 5/64"	Plastic	1.00	098993	50
--	---------	------	--------	----



9877 Door Guide, 2 pieces required per door		1.80	016843	50
---	--	------	--------	----



9880 Stop	US2C	1.80	096684	10
---------------------	------	------	--------	----



9881 Rubber Bumper		1.00	096685	80
------------------------------	--	------	--------	----



9882 Pocket Door Edge Pull Material: Brass Finger Pull Extends: 3/4" Faceplate: 3/4" x 3-7/8" Fasteners: #6 x 5/8" FPHWS	US3	14.60	049582	100
	US4	17.65	049583	
	US10	14.60	049578	
	US10B	17.65	049580	
	US26	17.65	049579	
	US26D	17.65	049581	



9883 2-Piece Door Guide Set with Screws		3.70	096686	100
---	--	------	--------	-----



9884 Pocket Door Edge Pull Material: Zinc Finger Pull Extends: 1-1/16" Faceplate: 21/32" x 3-1/2" Fasteners: #6 x 5/8" FPHWS	US3	7.75	099056	40
--	-----	------	--------	----

- For additional components, refer to component section.
- Items with the price in **bold and red** are Quick Ship items and ship in 24 hours. Please use stock number when ordering.
- U/M is each unless otherwise noted.
- Packaged sets and parts bags are available with optional components by special quotation.









Sliding Door Hardware - Components



Description	Finish	2018 List	Stock No.	Case Qty.
9889 1-Piece Guide		1.80	096687	20
9892 Parts Bag: 4 ea. 9824 4-wheel hangers w/ top mount plate, 1 ea. 9909 guide, 1 ea. 9573 spacer kit		52.70	019421	10
9893 Parts Bag: 4 ea. 9825 4-wheel ball bearing hangers w/ top mount plate, 1 ea. 9909 guide, 1ea. 9573 spacer kit		98.60	019418	10
9894 Parts Bag: 1 ea. 9825 4-wheel ball bearing hanger w/ top mount plate, 1 ea. 9828 pivot set with 9815 bumper stop, 9559 aligner		88.00	019435	10
9895 Parts Bag: 2 ea. 9825 4-wheel ball bearing hangers w/ top mount plate, 1 ea. 9883 guide, 1 ea. 9881 bumper		69.90	019408	10
9900 Reversible Side Mount Bracket	US2C	7.10	003775	20
9909 Heavy Duty Adjustable Door Guide From 3/4" to 1-3/4" (19 mm to 44 mm)	US2C	8.10	097528	20



Sliding Door Hardware - 9400 Series Stainless Barn Door

	Description	Finish	2018 List	Stock No.	Case Qty.
	9432 Packaged Sets - Top Mount Stick 2m SS Round Rail Includes stainless steel track with two end caps, hangers with wall brackets, one bottom door guide, two track stops, mounting and installation hardware				
	9432-78 - Top Mount Stick 2m (78-3/4") SS Round Rail	32D	525.00	183635	1
	9432-96 - Top Mount Stick 2m (96-3/4") SS Round Rail	32D	610.00	183636	1
	9433 Packaged Sets - Top Mount Dual Wheel 2m SS Round Rail Includes stainless steel track with two end caps, hangers with wall brackets, one bottom door guide, two track stops, mounting and installation hardware				
	9433-78 - Top Mount Dual Wheel 2m (78-3/4") SS Round Rail	32D	590.00	183637	1
	9433-96 - Top Mount Dual Wheel 2m (96-3/4") SS Round Rail	32D	733.35	183638	1
	9435 Packaged Sets - Top Mount Spoke Wheel 2m SS Round Rail Includes stainless steel track with two end caps, hangers with wall brackets, one bottom door guide, two track stops, mounting and installation hardware				
	9435-78 - Top Mount Spoke Wheel 2m (78-3/4") SS Round Rail	32D	530.00	183641	1
	9435-96 - Top Mount Spoke Wheel 2m (96-3/4") SS Round Rail	32D	595.00	183642	1
	9436 Packaged Sets - Face Mount Strap Stick 2m SS Round Rail Includes stainless steel track with two end caps, hangers with wall brackets, one bottom door guide, two track stops, mounting and installation hardware				
	9436-78 - Face mount Strap Stick 2m (78-3/4") SS Round Rail	32D	580.00	183643	1
	9436-96 - Face mount Strap Stick 2m (96-3/4") SS Round Rail	32D	605.00	183644	1
	9437 Packaged Sets - Face Mount Strap Dual Wheel 2m SS Round Rail Includes stainless steel track with two end caps, hangers with wall brackets, one bottom door guide, two track stops, mounting and installation hardware				
	9437-78 - Face mount Strap Dual Wheel 2m (78-3/4") SS Round Rail	32D	782.80	183646	1
	9437-96 - Face mount Strap Dual Wheel 2m (96-3/4") SS Round Rail	32D	795.00	183647	1
	9438 Packaged Sets - Face Mount Strap Triangle 2m SS Round Rail Includes stainless steel track with two end caps, hangers with wall brackets, one bottom door guide, two track stops, mounting and installation hardware				
	9438-78 - Face Mount Strap Triangle 2m (78-3/4") SS Round Rail	32D	760.00	183650	1
	9438-96 - Face Mount Strap Triangle 2m (96-3/4") SS Round Rail	32D	840.00	183651	1
	9462 Packaged Sets - Flat Rail Stick Strap SS Flat Track Includes stainless steel track, hangers with wall brackets, one bottom door guide, two track stops, mounting and installation hardware				
	9462-78 - Flat Rail Stick Strap SS 72" Flat Track	32D	666.70	183683	1
	9462-96 - Flat Rail Stick Strap SS 96" Flat Track	32D	733.35	183684	1

- For additional components, refer to component section.
- Items with the price in **bold and red** are Quick Ship items and ship in 24 hours. Please use stock number when ordering.
- U/M is each unless otherwise noted.
- Packaged sets and parts bags are available with optional components by special quotation.



Sliding Door Hardware - Stainless Barn Door Components



Description	Finish	2018 List	Stock No.	Case Qty.
1-269-8663 Round Rail Connector SS304 satin nickel	32D	32.95	181901	1
1-269-8664 Flat Rail Connector SS304 satin nickel	32D	32.95	181902	1
1-269-8665 Tool set for 05WG; 06WG; 07WG (round rail)		3.45	183156	1
1-269-8666 Tool set for 01W; 02W (round rail)	32D	3.45	183163	1
1-269-8667 End Cap	32D	8.80	183164	1
1-269-8668 Guide for wood door		5.50	183165	1
1-269-8669 Door Stop	32D	38.45	183166	1
1-269-8670 Guide for glass door	32D	27.50	183167	1
1-269-8671 Top Mount Stick Sliding Door Roller for Wood, SS304 Satin	32D	137.35	183168	1
1-269-8672 Top Mount Dual Wheel Sliding Door Roller for Wood, SS304 Satin	32D	384.55	183170	1
1-269-8673 Top Mount Spoke Wheel Sliding Door Roller for Wood, SS304 Satin	32D	329.60	183171	1
1-269-8674 Strap Stick Sliding Door Roller for Wood and Glass, SS304 Satin	32D	274.70	183172	1
1-269-8675 Strap Dual Wheel Sliding Door Roller for Wood and Glass, SS304 Satin	32D	466.95	183173	1
1-269-8676 Strap Triangle Sliding Door Roller for Wood and Glass, SS304 Satin	32D	329.60	183176	1



Sliding Door Hardware - Stainless Barn Door Components



Description	Finish	2018 List	Stock No.	Case Qty.
1-269-8677 Flat Rail Stick Sliding Door Carrier for Wood SS304 Satin	32D	184.05	183179	1
1-269-8678 Flat Rail Door Stopper Left, SS304 Satin	32D	54.95	183180	1
1-269-8679 Flat Rail Door Stopper Right, SS304 Satin	32D	54.95	183181	1
1-269-8680 Flat Rail Anti Jump	32D	3.30	183182	1

1. For additional components, refer to component section. 2. Items with the price in **bold and red** are Quick Ship items and ship in 24 hours. Please use stock number when ordering. 3. U/M is each unless otherwise noted.
4. Packaged sets and parts bags are available with optional components by special quotation.



Conestoga Barn Door - How to Order

IMPORTANT:

1. Track is ordered separately from hardware kit.
2. Track and Carrier Hardware are shipped in separate cartons.

Single Door Solution:

1. **9450 Track:** Specify length (72" or 96").
2. **Carrier Hardware Kit:** Specify style – Includes all mounting hardware.

Example:

9450 - 72 / 9450 - 96

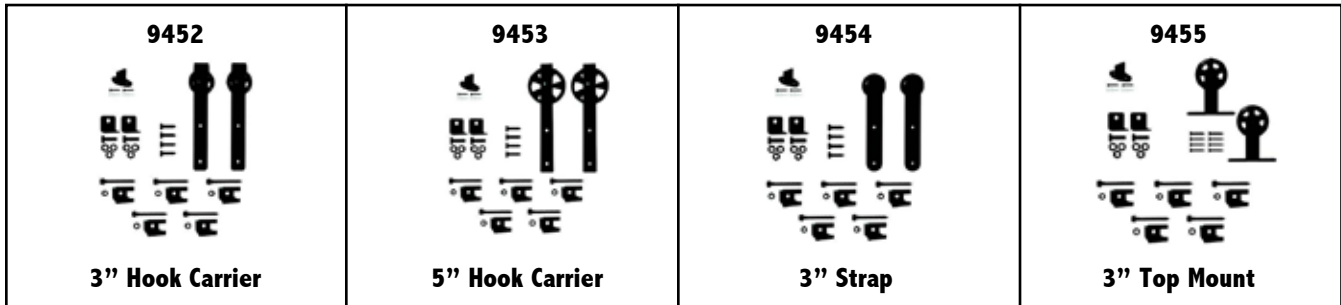

Bi-Part Door Solution:

If using two doors that are 3' wide, order a 6' track per door, for a total of 12'. This allows the doors to clear the door opening when in the open position. Order one carrier hardware kit per door and one Splice Kit.

To Order:

1. **9450 Track:** Specify quantity and length.
2. **Carrier Hardware Kit:** Specify quantity and carrier style. Example: Order 2 of part number 9453, 5" hook carrier style – Includes all mounting hardware.

Example:

9450 - 72 / 9450 - 96

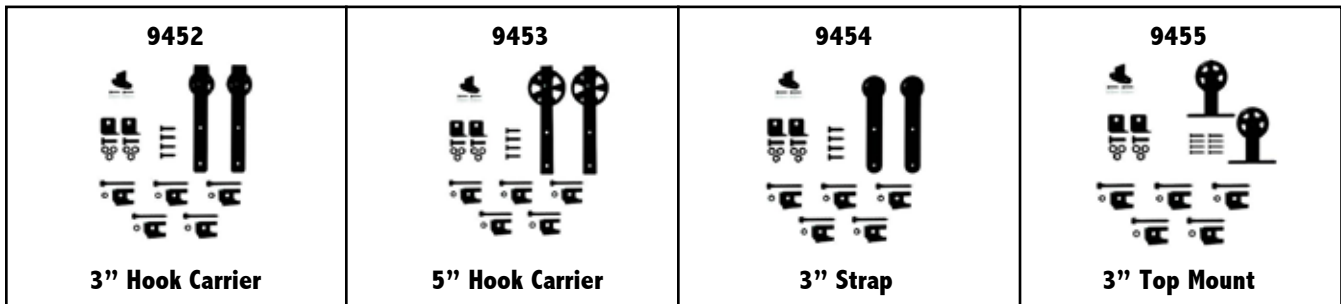

3. **Splice Kit:** Order 1 of part number 1-269-8691 Flat Rail Splice Kit.



Conestoga Barn Door - Price Sheet

Stock Number	Hager Part Number	Description	2018 List
Conestoga Barn Door			
Rail Only			
186243	9450-72	72" Black Powder Coated Flat Rail	\$113.35
186251	9450-96	96" Black Powder Coated Flat Rail	\$158.70
Hanger Kits Less Rail: All kits include two carriers, stops, floor guide and rail mounting brackets and fasteners.			
188467	9452	3" Hook Carrier Kit Less Rail - Black Powder Coated	\$570.70
188468	9453	5" Hook Carrier Kit Less Rail - Black Powder Coated	\$733.35
188469	9454	3" Strap Carrier Kit Less Rail - Black Powder Coated	\$526.65
188470	9455	3" Top Mount Carrier Kit Less Rail - Black Powder Coated	\$555.45
Optional Components			
Single Carrier w/ Fastners			
186264	1-269-8685	3" Hook Carrier - Black Powder Coated	\$274.50
186266	1-269-8686	5" Hook Carrier - Black Powder Coated	\$381.20
186267	1-269-8687	3" Strap Carrier - Black Powder Coated	\$205.90
186270	1-269-8688	3" Top Mount Carrier - Black Powder Coated	\$222.30
Privacy Latch and Pull			
186296	1-269-8693	Sliding Door Privacy Latch & Strike Plate - Black Powder Coated	\$57.35
186299	1-269-8694	4" x 1-3/4" x 7/16" Flush Pull - Black Powder Coated	\$57.35
Accessories			
186289	1-269-8689	Brack Kit: Includes 1 wall mount braket with fastener	\$25.50
186290	1-269-8690	Stop Kit: Inclues 2 end Stops with fasteners	\$76.00
186292	1-269-8691	Splice Kit: Includes splice componentsand fastners for joining rails	\$48.30





One Family. One Brand. One Vision.™

www.hagerco.com

TABLE OF CONTENTS

D

Door Controls

Concealed Door Closers 12
 Door Closers Accessories..... 13
 Floor Springs..... 12
 Patch Fittings 13
 Surface Door Closers..... 12

E

Euroline Hinges

1191..... 18
 1279..... 18
 7191..... 17
 7192..... 17
 BB1168..... 18
 BB1191 18
 BB1199..... 18
 BB1279..... 18
 BB6191 17

Exit Devices

Exit Devices 14
 Exit Trim 14
 Miscellaneous 14

L

Locks

Lever Sets7-10
 Lock Bodies.....5-6
 Lock Cylinders 11
 Lock Functions2-4
 Miscellaneous Lock Accessories6-7

T

Trim and Auxiliary

Coat & Hat Hooks..... 15
 Door Stops 15
 Flushbolts 15
 Miscellaneous 16
 Signage..... 15-16



Lock Functions

Euroline Introduction

Most of us in the door hardware industry are familiar with ANSI - American National Standards Institute, BHMA - Builders Hardware Manufacturers Association, along with UL - Underwriters Laboratories and Intertek. However these standards and fire codes, which are strictly enforced in the United States and Canada, are not customary in approximately 90% of the rest of the world.

European standards - EN and CE - are dominant in Europe, the Middle East and most of Asia. Any hardware products sold into areas that embrace these standards must meet their cycle and fire tests, which are completely different than those of ANSI and UL.

Hager Companies launched the Euroline in late 2008 to provide a comprehensive product line that meets and exceeds EN and CE standards. It currently consists of a complete product portfolio including hinges, trim and auxiliary, door controls, exit devices, mortise locks, cylinders, levers, and accessories.

Since that time the product line has expanded and Hager Companies has been successful in marketing in Latin America, the Middle East and Asia. In addition, our Euroline products recently passed separate stringent fire tests in Mainland China. This will allow Hager Companies to furnish our products throughout the Peoples Republic of China on commercial buildings.

As always, service is our number one priority and that is true for our global customers as well. We have representatives across the globe as well as distribution centers in Dubai, United Arab Emirates and Zhuhai, China.





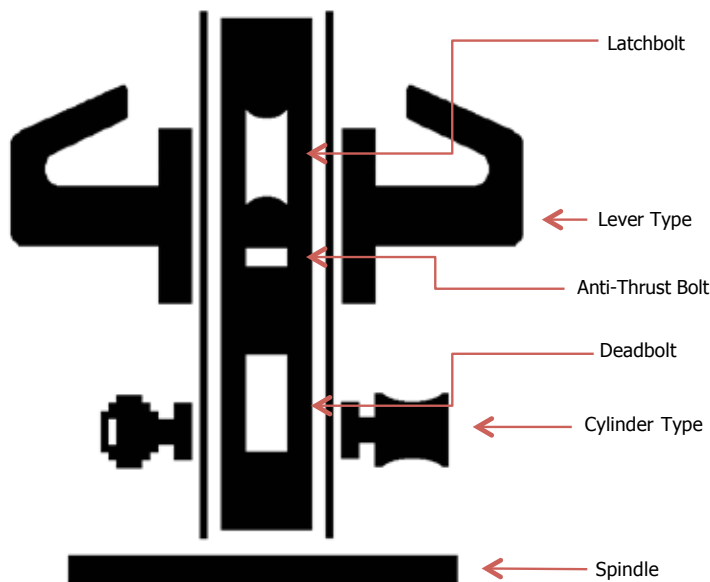

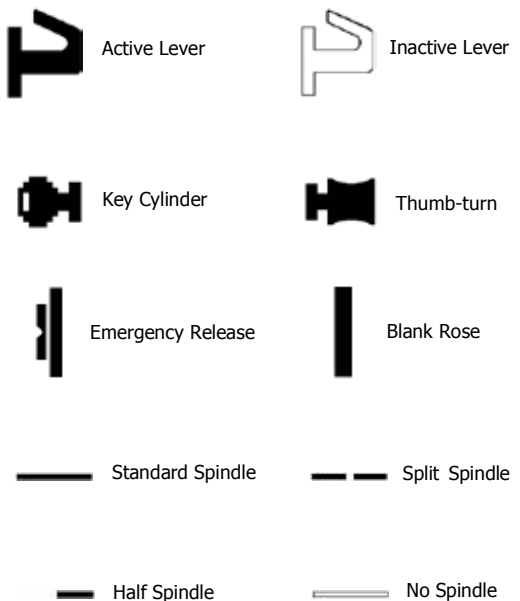

European locksets are sold in component form: lock body, lever set and cylinder. This allows end users to mix and match cylinders, levers and lock bodies. It also allows multiple mechanical and electronic keyways to be used interchangeably. This modular approach allows for greater flexibility on the jobsite.

Lock Components



Symbol Key











Picture	Function	Function Description	Required Parts
	Passage	Latchbolt operated by lever from either side at all times.	3800U-55L Leverset
	Bathroom Indicator	Latchbolt operated by lever from either side at all times. Deadbolt operated by thumbturn from inside and by emergency release with indicator from outside.	3800U-55B Leverset 2-669-0736
	Privacy	Latchbolt operated by lever from either side at all times. Deadbolt operated by thumbturn from inside and by emergency release from outside.	3800U-55S Leverset 3000R
	Classroom	Latchbolt operated by lever from either side. Deadbolt operated by key from outside. Operating inside lever retracts both latchbolt and deadbolt simultaneously.	3800U-55P Leverset Split Spindle* 3000H
	Storeroom	Latchbolt operated by key from outside or by operating inside lever. Outside lever never retracts latchbolt.	3800U-55M Leverset Half Spindle** 3000H
	Security Storeroom	Latchbolt operated by key from outside or by operating inside lever. Outside lever never retracts latch. Anti-thrust bolt.	3800U-55T Leverset Half Spindle** 3000H
	Exit	Latchbolt operated by lever from either side. Deadbolt operated by key from outside and by thumbturn from inside. Operating inside lever retracts both latchbolt and deadbolt simultaneously.	3800U-55P Leverset Split Spindle* 3000C
	Entrance	Latchbolt operated by lever from either side. Deadbolt operated by key from either side.	3800U-55S Leverset 3000D

* Use the split spindle in place of the spindle that comes with the leverset.

** Use the half spindle going into the inside lever in place of the spindle that comes with the leverset.











Lock Functions

Picture	Function	Function Description	Required Parts
	Bedroom	Latchbolt operated by lever from either side. Deadbolt operated by thumbturn from inside and emergency release from outside. Operating inside lever retracts both latchbolt and deadbolt simultaneously.	3800U-55P Leverset Split Spindle* 3000R
	Dormitory	Latchbolt operated by lever from either side. Deadbolt operated by key from outside and thumbturn from inside.	3800U-55S Leverset 3000C
	Institutional	Latchbolt operated by key from either side. Neither lever retracts latchbolt.	3800U-55M Leverset** 3000D
	Security Institutional	Latchbolt operated by key from either side. Neither lever retracts latchbolt. Anti-thrust bolt.	3800U-55T Leverset** 3000D
	Security Classroom	Latchbolt operated by lever from either side. Deadbolt operated by key from inside or outside. Operating inside lever retracts both latchbolt and deadbolt simultaneously.	3800U-55P Leverset Split Spindle* 3000D
	Double Deadbolt	Deadbolt operated by key from either side. No latchbolt.	3800U-55F 3000D
	Privacy Deadbolt	Deadbolt operated by key from outside and by thumbturn from inside. No latchbolt.	3800U-55F 3000C
	Single Deadbolt	Deadbolt operated by key from outside only. No latchbolt.	3800U-55F 3000H

* Use the split spindle in place of the spindle that comes with the leverset.

** Do not install the spindle that comes with the leverset.



	Description	Finish	2018 List	Stock No.	Case Qty.	Box Qty.
	Lock Bodies					
	3800U-20H Sliding Door Mortise Lock	US32D	26.65	138187	20	1
	3800U-60H Sliding Door Mortise Lock	US32D	26.65	138188	20	1
	3800U-55B Bathroom Mortise Lock CE: 3X510F-BG20 CertiFire: CF5283	US32D	28.85	136178	20	1
	3800U-55D Small Mortise Lock	US32D	24.05	136175	20	1
	3800U-55F Deadbolt Mortise Lock CE: 3X510F3BC00 CertiFire: CF5283	US32D	28.85	136179	20	1
	3800U-55L Latch Mortise Lock CE: 3X510F-B020 CertiFire: CF5283	US32D	28.85	136181	20	1
	3800U-55M Nightlatch Mortise Lock CE: 3X510F-B020 CertiFire: CF5283 Requires 2-669-0732 Half Spindle	US32D	28.85	136180	20	1
	3800U-60N Latch Small Mortise Lock	US32D	24.05	150655	20	1



Lock Body Finish Price Adder
 US3: \$6.50
 US4: \$4.25
 US5: \$6.50
 US10B: \$4.25
 US32: \$3.15

U/M - Each

- 50 Piece Minimum Order Quantity per Lock for Above Finishes
- Above Finishes Not Available on 3800U-20H or 3800U-60H



Locks

	Description	Finish	2018 List	Stock No.	Case Qty.	Box Qty.
	Lock Bodies					
	3800U-55P Anti-Panic Mortise Lock CE: 376B1342A B/D CertiFire: CF5283 Requires 2-669-0733 Split Spindle	US32D	28.85	136182	20	1
	3800U-55S Sash Mortise Lock CE: 3X510F3BC20 CertiFire: CF5283	US32D	26.15	136177	20	1
	3800U-55T Nightlatch w/ Anti-Thrust Bolt Mortise Lock CE: 3X510F2BB20 CertiFire: CF5283 Requires 2-669-0732 Half Spindle	US32D	28.85	136183	20	1

Lock Body Finish Price Adder

U/M - Each

US3: \$6.50





US4: \$4.25

US5: \$6.50





US10B: \$4.25





US32: \$3.15

- 50 Piece Minimum Order Quantity per Lock for Above Finishes
- Above Finishes Not Available on 3800U-20H or 3800U-60H

	Description	Finish	2018 List	Stock No.	Case Qty.	Box Qty.
	Miscellaneous Lock Accessories					
	3910 Padlock	US26D	51.25	152895	54	1
	2-669-1364 Blank Cylinder Rose	US32D	3.25	174072	200	20
	2-669-0644 Replacement Rose Kit	US32D	6.10	125929	20	10
	2-669-0645 Lever Spindle Extension Kit - Round Rose Levers	US32D	9.15	125930	100	N/A
	2-669-1363 Lever Spindle Extension Kit - Square Rose Levers	US32D	9.15	172838	100	N/A



	Description	Finish	2018 List	Stock No.	Case Qty.	Box Qty.
	Miscellaneous Lock Accessories					
	2-669-0732 Half Spindle	US32D	6.45	136184	500	1
	2-669-0733 Split Spindle	US32D	8.05	136185	500	1
	2-669-0735 Strike Dust Box	US32D	1.70	140210	100	1
	2-669-0736 Bathroom Turn Indicator w/ Emergency Release	US32D	23.25	140211	50	1

	Description	Finish	2018 List	Stock No.	Case Qty.	Box Qty.
	Lever Sets					
	6801 Tube Lever	US32D	24.35	114777	20	1
	6802 Tube Lever	US32D	24.35	146399	20	1
	6803 Tube Lever	US32D	24.35	114782	20	1
	6805 Tube Lever	US32D	24.35	114785	20	1









Lever Set Finish Price Adder
 US3: \$15.00
 US4: \$6.50
 US5: \$6.50
 US10B: \$6.50
 US32: \$8.50

U/M - Each

- 200 Piece Minimum Order Quantity per Lever Set for Above Finishes



Locks









	Description	Finish	2018 List	Stock No.	Case Qty.	Box Qty.
	Lever Sets					
	6806 Tube Lever	US32D	24.35	114803	20	1
	6807 Solid Lever	US32D	53.10	114804	20	1
	6808 Solid Lever	US32D	53.10	114805	20	1
	6809 Solid Lever	US32D	56.15	114806	20	1
	6810 Cast Hollow Lever	US32D	53.10	114807	20	1
	6811 Tube Lever	US32D	26.00	114808	20	1
	6812 Tube Lever	US32D	28.85	114809	20	1
	6813 Tube Lever	US32D/ US32 Dual Finish	28.85	114810	20	1
	6814 Cast Hollow Lever	US32D/ US32 Dual Finish	51.85	138154	20	1

Lever Set Finish Price Adder

US3: \$15.00
 US4: \$6.50
 US5: \$6.50
 US10B: \$6.50
 US32: \$8.50

U/M - Each

- 200 Piece Minimum Order Quantity per Lever Set for Above Finishes

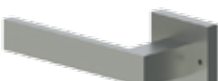
	Description	Finish	2018 List	Stock No.	Case Qty.	Box Qty.
	Lever Sets					
	6815 Solid Lever	US32D	46.50	138155	20	1
	6816 Cast Hollow Lever	US32D/ US32 Dual Finish	52.75	138157	20	1
	6817 Solid Lever	US32D	45.75	138158	20	1
	6818 Solid Lever	US32D	50.80	138159	20	1
	6819 Cast Hollow Lever	US32D/ US32 Dual Finish	50.40	138160	20	1
	6820 Tube Lever	US32D	24.00	138161	20	1
	6821 Tube Lever	US32D/ US32 Dual Finish	25.50	138162	20	1
	6822 Solid Lever	US32D	43.20	138163	20	1
	6823 Solid Lever Handed	US32D	67.35	RH: 172831 LH: 172832	20	1

Lever Set Finish Price Adder









- US3: \$15.00
- US4: \$6.50
- US5: \$6.50
- US10B: \$6.50
- US32: \$8.50

U/M - Each

- 200 Piece Minimum Order Quantity per Lever Set for Above Finishes

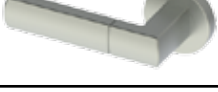

Locks

	Description	Finish	2018 List	Stock No.	Case Qty.	Box Qty.
	Lever Sets					
	6824 Solid Lever	US32D	50.80	138165	20	1
	6825 Cast Hollow Lever	US32D	46.40	138166	20	1
	6826 Solid Lever	US32D	40.50	138167	20	1
	6827 Solid Lever	US32D	52.10	138168	20	1
	6828 Cast Hollow Lever	US32D	48.55	138169	20	1
	6829 Cast Hollow Lever	US32D	46.75	138170	20	1
	6830 Solid Lever Handed	US32D/ US32 Dual Finish	73.60	RH: 172833 LH: 172834	20	1
	6831 Solid Lever Handed	US32D	63.20	RH: 172835 LH: 172836	20	1
	6832 Solid Lever	US32D/ US32 Dual Finish	50.05	138174	20	1

Lever Set Finish Price Adder

US3: \$15.00

US4: \$6.50





US5: \$6.50

US10B: \$6.50

US32: \$8.50

U/M - Each

- 200 Piece Minimum Order Quantity per Lever Set for Above Finishes

	Description	Finish	Size	2018 List	Stock No.	Case Qty.	Box Qty.
	Lock Cylinders						
	3000 - H Series	US15	40mm	18.80	175593	60	1
	Half Cylinders		45mm	21.15	175616		
			50mm	21.15	*		
	3000 - C Series	US15	60mm	24.35	175599	60	1
	Thumbturn Cylinder		70mm	28.10	175602		
			75mm	28.10	*		
			80mm	30.40	175612		
	3000 - D Series	US15	60mm	21.40	175598	60	1
	Double Cylinder		70mm	24.90	175601		
			75mm	24.90	*		
			80mm	27.50	175611		
	3000 - R Series	US15	60mm	20.55	175597	60	1
	Thumbturn Cylinder with Emergency Release		70mm	22.40	175600		
			80mm	26.55	175610		

Keying Charges

Keyed Different (KD): No Charge

Keyed Alike (KA): No Charge

Master Keyed (MK/GMK): Add \$21.10 to list price of cylinder

Extra Cut Keys: \$6.05

Blank Keys: \$3.30

Key Markings (Standard Key Symbols): No Charge

Key Markings (Non-Standard Key Symbols): \$6.05

Custom Cylinder Markings (Side Only): \$6.05

Bitting Lists (No Charge if ordered with Master Keying): \$83.95

6 & 7 Pin Cylinders for Master Keying Only

U/M - Each

Cylinder Finish Price Adder

US3: No Charge









US26: No Charge

- 200 Piece Minimum Order Quantity per Lock for Above Finishes

* Master keyed item only. Inquire with Hager Customer Service for SKU.







Door Controls

		Description	Finish	2018 List	Stock No.	Case Qty.	Box Qty.
		Surface Door Closers					
	5800V Surface Door Closer Size 3 CE - 4:8:3:1:1:3	ALM	62.85	142378	10	1	
	5800R Surface Door Closer Size 2-5 CE - 4:8:2/5:1:1:3 CertiFire: CF5390	ALM	141.40	142357	10	1	
	5800X Surface Door Closer Size 3-6 CE - 4:8:3/6:1:1:3 CertiFire: CF5390	ALM	135.10	189533	10	1	
		Concealed Door Closers					
	5800C Concealed Door Closer Size 3	ALM	88.00	142358	10	1	
	5800D Concealed Door Closer Size 2-4 CE - 4:8:2/4:1:1:3 CertiFire: CF5392	ALM	207.35	142372	10	1	
		Floor Springs					
	5800F Floor Spring Size 3 CE - 3:8:3:1:1:3	US32D	178.10	177677	4	1	
	5815F Floor Spring w/ 90 Degree Hold Open Size 3	US32D	178.10	177680	4	1	
	5800H Heavy Duty Floor Spring Size 3-6 CE - 3:8:3/6:1:1:3	US32D	391.40	181055	4	1	
	5815H Heavy Duty Floor Spring w/ 90 Degree Hold Open Size 3-6	US32D	391.40	181056	4	1	

Note: Additional finishes available on most items. Inquire with Hager Customer Service for pricing.



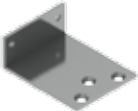

U/M - Each

Door Controls

	Description	Finish	2018 List	Stock No.	Case Qty.	Box Qty.
	Door Closers Accessories					
	2-659-0087 Surface Closer Track Arm For 5800R, X, V	ALM	37.25	122869	25	1
	2-659-0088 Surface Closer Cover For 5800R	US32D	35.75	122870	17	1
	2-659-0097 Surface Closer Parallel Arm Bracket For 5800R, X, V	ALM	8.85	138151	100	1
	2-659-0149 Surface Closer Hold Open Arm For 5800R, X, V	ALM	41.00	153843	10	1

Note: Additional finishes available on most items. Inquire with Hager Customer Service for pricing.

U/M - Each



	Description	Finish	2018 List	Stock No.	Case Qty.	Box Qty.
	Patch Fittings					
	651 Bottom Patch Fitting	US32	25.15	134144	10	1
	652 Top Patch Fitting	US32	25.15	134145	10	1
	653 Overpanel Patch Fitting	US32	25.15	134146	10	1
	654 Corner Overpanel and Sidelight Patch Fitting	US32	40.55	134147	10	1
	655 Bottom Lock Patch Fitting	US32	53.45	134148	10	1
	2-659-0150 Heavy Duty Top Pivot	ALM	18.20	154746	10	1



Note: Additional finishes available on most items. Inquire with Hager Customer Service for pricing.

U/M - Each



Exit Devices

	Description	Finish	Size	2018 List	Stock No.	Case Qty.	Box Qty.
	Exit Devices						
	4201R	ALM	915mm	149.35	143111	4	1
	Push Bar Rim Exit Device	ALM	1219mm	200.85	143137	4	1
	CE - 3:7:6:B:1:4:2:2:B:A	US32D	915mm	164.80	143108	4	1
		US32D	1219mm	216.30	143117	4	1
	4201S	ALM	915mm x 2135mm	195.70	143187	4	1
	Push Bar Surface Vertical Rod Exit Device	ALM	1219mm x 2135mm	242.05	143189	4	1
	CE - 3:7:6:B:1:4:2:2:B:C	US32D	915mm x 2135mm	211.15	143184	4	1
		US32D	1219mm x 2135mm	257.50	143188	4	1



	Description	Finish	2018 List	Stock No.	Case Qty.	Box Qty.
	Exit Trim					
	42CE	US32D	119.45	193685	20	1
	Cylinder Escutcheon Trim William Lever					
	42KE	US32D	70.15	170013	12	1
	Key-in-Lever Trim Withnell Lever					



	Description	Finish	2018 List	Stock No.	Case Qty.	Box Qty.
	Miscellaneous					
	2-649-5011	US32D	13.05	195626	1	
	Double Door Strike					

Note: Additional finishes available on most items. Inquire with Hager Customer Service for pricing.

U/M - Each

	Description	Finish	2018 List	Stock No.	Case Qty.	Box Qty.
	Flushbolts					
	280E Dust Proof Strike	US32D	9.85	114930	300	10
	1420 Manual Flush Bolt	US32D	17.90	114811	100	2



	Description	Finish	2018 List	Stock No.	Case Qty.	Box Qty.
	Door Stops					
	248E Pedestal Door Stop	US32D	9.00	114951	200	10
	248U Pedestal Door Stop	US32D	14.95	123266	100	10





	Description	Finish	2018 List	Stock No.	Case Qty.	Box Qty.
	Coat & Hat Hooks					
	6630 Coat & Hat Hook	US32D	9.30	114948	200	10
	6640 Coat & Hat Hook	US32D	9.50	114950	200	10

	Description	Finish	2018 List	Stock No.	Case Qty.	Box Qty.
	Signage					
	371F Signage Female	US32D	9.00	122875	20	10
	371M Signage Male	US32D	9.00	122873	20	10



Trim & Auxiliary

	Description	Finish	2018 List	Stock No.	Case Qty.	Box Qty.
	Signage					
	371U Signage Universal	US32D	9.00	122877	20	10
	371H Signage Disabled	US32D	9.00	122876	20	10
	371S Signage No Smoking	US32D	9.00	122874	20	10

	Description	Finish	2018 List	Stock No.	Case Qty.	Box Qty.
	Miscellaneous					
	299D Concealed Door Chain	US32D	25.35	114952	48	1
	1757 Door Viewer	US26D	7.95	133689	200	1
		US3	7.95	133690		
	277E Surface Bolt	US15	11.05	133809	50	1
	277T Indicator Thumbturn Bolt	US32D	16.55	138118	50	1

Note: Additional finishes available on most items. Inquire with Hager Customer Service for pricing.

U/M - Each



Description	Size	Finish	2018 List	Stock No.	Case Qty.	Box Qty.
BB6191 Stainless Full Mortise Standard Weight Ball Bearing CE Certified CertiFire: CF5288	89mm x 89mm	US3	19.10	117673	48	2
		US5	16.50	117306		
		US10B	16.50	117296		
		US32D	13.25	117686		
	102mm x 76mm	US3	22.00	117308	48	2
		US5	16.50	117691		
		US10B	16.50	117688		
		US32D	12.55	117689		
	102mm x 89mm	US3	24.55	117702	48	2
		US5	18.20	117758		
		US10B	18.20	117309		
		US32D	14.55	117729		
102mm x 102mm	US3	25.35	117311	48	2	
	US5	19.70	117780			
	US10B	19.75	117310			
	US32D	15.40	117777			
127mm x 89mm	US3	29.80	117359	48	2	
	US5	22.80	117362			
	US10B	22.80	117344			
	US32D	18.45	117782			

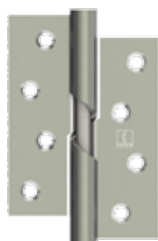

7191 Rising Butt Hinge Stainless Full Mortise Raises Door Upon Opening Handed	102mm x 76mm (LH)	US32D	12.40	135300	60	2
	102mm x 76mm (RH)		12.40	135304		
	102mm x 102mm (LH)		15.15	146537		
	102mm x 102mm (RH)		15.15	146538		



7192 Falling Butt Hinge Stainless Full Mortise Lowers Door Upon Opening Handed	102mm x 76mm (LH)	US32D	13.60	146542	60	2
	102mm x 76mm (RH)		13.60	146541		
	102mm x 102mm (LH)		15.60	146540		
	102mm x 102mm (RH)		15.60	146539		

Non-Removable Pin (NRP) Adder: \$3.65 each
 Protective Clear Coat Adder: \$0.50 each







U/M - Each

Please note that minimum order in case quantities only, no broken cases.

- Notes:
- Additional finishes available on most items. Inquire with Hager Customer Service for pricing on US10, US4, and US32.
 - For pricing on sizes not listed, please contact your Hager Sales Representative or Hager Customer Service.



Export Commercial Hinges

	Description	Size	Finish	2018 List	Stock No.	Case Qty.	Box Qty.
	1279	76mm x 76mm	US26D	11.35	53908	100	2
	Steel	89mm x 89mm		11.60	36829	48	3
	Full Mortise	102mm x 102mm		11.90	36832	48	3
	Standard Weight	114mm x 102mm		12.35	36678	48	3
		114mm x 114mm		12.35	37714	48	3
	BB1279	89mm x 89mm	US26D	13.50	36822	48	3
	Steel	102mm x 102mm		16.65	37710	48	3
	Full Mortise	114mm x 102mm		18.50	34213	48	3
	Standard Weight Ball Bearing	114mm x 114mm		18.50	34215	48	3
	BB1168	114mm x 102mm	US26D	34.35	37715	48	3
	Steel	114mm x 114mm		34.35	36680	48	3
	Full Mortise Heavy Weight Ball Bearing						
	1191	76mm x 76mm	US32D	16.35	53021	100	2
	Stainless	89mm x 89mm		21.00	52987	48	3
	Full Mortise	102mm x 102mm		24.20	37716	48	3
	Standard Weight	114mm x 102mm		31.00	36679	48	3
		114mm x 114mm		31.00	38646	48	3
	BB1191	89mm x 89mm	US32D	22.85	61669	48	3
	Stainless	102mm x 102mm		29.85	37717	48	3
	Full Mortise	114mm x 102mm *		38.60	35597	48	3
	Standard Weight	114mm x 114mm *		38.60	35419	48	3
	Ball Bearing	127mm x 114mm		58.25	82255	48	3
	BB1199	114mm x 102mm *	US32D	61.35	36817	48	3
	Stainless	114mm x 114mm *		61.35	35433	48	3
	Full Mortise Heavy Weight Ball Bearing	127mm x 114mm		90.05	44553	48	3

Non-Removable Pin (NRP) Adder:	\$3.65 each
Hospital Tip (HT) Adder:	\$7.30 each
Safety Stud (SH) Adder:	\$5.10 each
Round Corner (RC) Adder:	\$2.90 each
Stainless Steel Pin (114mm) Adder:	\$3.65 each
Protective Clear Coat Adder:	\$0.50 each

U/M - Each

- Notes:
- Additional finishes available on most items. Inquire with Hager Customer Service for pricing on US10, US4, and US32
 - For pricing on sizes not listed, please contact Hager Customer Service.

* Available in 316 Stainless Steel. Add \$20.25 to list price of hinge



One Family. One Brand. One Vision.™

www.hagerco.com

2310	5	3810E	45
2317	5	3810S	43
2327	5	3817E	45
2340	5	3817S	43
2510	8	3827E	45
2517	8	3827S	43
2525	8	3830S	49
2527	8	3831S	49
2540	8	3832S*	49
2550	8	3833S	49
2553	8	3834S	49
2570	8	3840E	46
2580	8	3840S	44
2903	24	3844E	46
2903	47	3844S	44
2904	24	3850E	46
2904	47	3850S	44
2908	24	3853E	46
2908	47	3853S	44
2909	24	3856E	46
2909	47	3856S	44
3114	12	3857E*	46
3115	12	3857S*	44
3118	12	3860S	48
3214	16	3861E*	46
3215	16	3861S*	44
3216	16	3862S*	48
3220	16	3863S	48
3221	16	3864S	48
3222	16	3870E	44
3410	22	3870S	42
3417	22	3880E	44
3440	22	3880S	44
3450	23	3881E	46
3453	23	3881S	44
3470	23	3882E*	46
3473	23	3882EL	47
3480	23	3882S*	44
3480ELEU	24	3896E	46
3495	23	3896S	44
3510	30	3901	58
3517	30	3901	62
3525	30	3901	64
3527	30	3902	59
3540	31	3902	62
3550	31	3902	64
3553	31	3903	58
3570	31	3904	59
3573	31	3905	59
3579	31	3907	57
3580	31	3907	61
3610	36	3908	57
3617	36	3908	60
3640	36	3908	61
3653	36	3911	11
3670	36	3911	27
3680	36	3911	65
3710	39	3912	35
3753	39	3912	65
3796	39	3914	37



3915	37	3947	32
3916	25	3947	40
3917	9	3948	9
3917	33	3948	32
3918	51	3948	40
3919-C	63	3949	9
3919-Z	63	3949	32
3920	40	3949	40
3921	40	3950	9
3922	9	3950	32
3922	34	3950	40
3923	9	3951	37
3923	34	3952	37
3924	10	3953	37
3924	34	3954	37
3925	9	3955	56
3925	34	3956	56
3926	10	3956	63
3926	34	3958	10
3927	10	3958	26
3927	34	3958	34
3928	51	3958	38
3929	13	3958	41
3929	17	3959	6
3930	13	3959	9
3930	17	3959	17
3930	40	3959	33
3932	25	3959	38
3932	29	3959	40
3933	6	3959	65
3933	10	3960 or 3906 (Hager Keyway Only)	57
3933	29	3961	56
3933	34	3962	57
3933	38	3962	63
3933	41	3964	24
3934	10	3965	9
3934	26	3965	32
3934	34	3966	25
3934	38	3967	9
3934	41	3967	32
3935	6	3968	65
3935	10	3968	65
3935	26	3971	59
3935	29	3972	59
3935	34	3973	59
3936	25	3974	59
3937	9	3975	60
3937	33	3976	60
3938	37	3977	60
3939	37	3978	60
3940	13	3979	65
3940	17	3980	66
3941	13	3981-BLU or RED (Best A)	60
3941	17	3981-C	60
3942	17	3981-U	60
3943	24	3982-BLU or RED (Best A)	60
3944	25	3982-C or 3969 (Hager SFIC Only)	60
3945	24	3982-U or 3909 (Hager SFIC Only)	60
3946	25	3983	61
3947	9	3984	60

3984	58	2-300-0066	38
3985	51	2-300-0068	38
3986	51	2-300-0074	38
3987	51	2-300-0091	7
3988	51	2-300-0092	7
3989	51	2-300-0093	7
3990	51	2-300-0105	18
3991	51	2-300-0106	18
3992	25	2-300-0107	18
3993	25	2-300-0108	18
3994	32	2-300-0109	18
3995	33	2-300-0110	18
3996	34	2-300-0111	18
3997	34	2-300-0112	18
3998	56	2-300-0113	18
3998	60	2-300-0114	18
3999	52	2-300-0115	18
2-300-0001	14	2-300-0116	18
2-300-0002	14	2-300-0118	59
2-300-0003	14	2-300-0138	41
2-300-0004	14	2-300-0140	41
2-300-0005	14	2-300-0141	41
2-300-0006	14	2-300-0175	64
2-300-0007	14	2-639-3109	13
2-300-0008	14	2-639-3109	17
2-300-0009	14	2-639-3109	41
2-300-0010	14	2-639-3151	13
2-300-0011	14	2-639-3152	14
2-300-0018	18	2-639-3153	14
2-300-0019	18	2-639-3154	14
2-300-0020	18	2-639-3155	14
2-300-0021	18	2-639-3156	14
2-300-0022	18	2-639-3157	14
2-300-0023	18	2-639-3168	13
2-300-0024	18	2-639-3218	19
2-300-0025	18	2-639-3219	19
2-300-0026	18	2-639-3220	19
2-300-0027	18	2-639-3221	19
2-300-0028	18	2-639-3222	19
2-300-0029	18	2-639-3223	19
2-300-0036	27	2-639-3230	19
2-300-0038	27	2-639-3231	19
2-300-0039	27	2-639-3233	19
2-300-0041	27	2-639-3234	19
2-300-0042	27	2-639-3235	19
2-300-0043	27	2-639-3236	19
2-300-0044	27	2-639-3238	14
2-300-0045	27	2-639-3238	19
2-300-0045	35	2-639-3239	14
2-300-0048	10	2-639-3239	19
2-300-0048	35	2-639-3490	26
2-300-0050	10	2-639-3490	29
2-300-0050	35	2-639-3523	10
2-300-0052	10	2-639-3523	35
2-300-0052	35	2-639-3577	10
2-300-0058	10	2-639-3577	32
2-300-0058	35	2-639-3703	19
2-300-0059	35	2-639-3704	19
2-300-0060	35	2-639-3705	19
2-300-0064	38	2-639-3706	19



2-639-3707	19	2-639-7520	67
2-639-3708	19	2-639-7522	67
2-639-7000	57	2-639-7523	68
2-639-7001	57	2-639-7524	68
2-639-7002	57	2-639-7526	68
2-639-7003	57	2-639-7527	68
2-639-7005	57	2-639-7528	68
2-639-7006	58	2-639-7530	68
2-639-7007	58	2-639-7531	68
2-639-7008	58	2-639-7532	68
2-639-7018	58	2-639-7534	68
2-639-7058	59	2-639-7535	68
2-639-7060	61	2-639-7536	68
2-639-7061	62	2-639-7536	68
2-639-7082	62	2-639-7537	68
2-639-7083	62	2-639-7536	65
2-639-7084	62	2-639-7570	65
2-639-7085	63	2-639-7572	65
2-639-7086	63	2-639-7573	65
2-639-7087	58	2-639-7574	65
2-639-7090	62	2-639-7578	64
2-639-7091	62	2-639-7601	7
2-639-7094	58	2-639-7603	7
2-639-7095	62	2-639-7604	7
2-639-7143	20	2-639-7605	7
2-639-7144	20	2-639-7606	7
2-639-7146	13	2-639-7607	6
2-639-7147	13	2-639-7608	6
2-639-7148	13	2-639-7609	6
2-639-7149	13	2-639-7610	6
2-639-7150	13	2-639-7617	6
2-639-7151	19	2-639-7619	6
2-639-7152	19	2-639-7620	6
2-639-7153	19	2-639-7621	6
2-639-7154	20	2-639-7622	6
2-639-7155	20	2-639-7645	64
2-639-7156	20	2-639-7646	64
2-639-7157	20	2-639-7647	64
2-639-7158	20	2-639-7649	63
2-639-7159	38	2-639-7680	66
2-639-7160	15	2-647-0012	66
2-639-7160	20	2-647-0013	66
2-639-7161	15	2-647-0014	66
2-639-7161	20	2-647-0015	66
2-639-7163	15	2-647-0016	66
2-639-7163	20	2-647-0017	66
2-639-7164	15	2-647-0018	66
2-639-7164	20	2-647-0019	66
2-639-7165	20	2-647-0020	66
2-639-7166	20	2-649-0045	66
2-639-7167	15	2-649-0046	66
2-639-7167	20	2-649-0047	66
2-639-7192	58	2-649-0048	66
2-639-7322	58	2-649-0050	66
2-639-7511	67	2-649-0051	66
2-639-7512	67	2-649-0052	66
2-639-7513	67	2-649-0053	67
2-639-7517	67	2-649-0054	67
2-639-7518	67	2-649-0055	67
2-639-7519	67		



2-649-0056.....	67	2-669-0389.....	52
2-649-0057.....	67	2-669-0408.....	53
2-649-0058.....	67	2-669-0410.....	53
2-649-0059.....	67	2-669-0411.....	53
2-649-0137.....	59	2-669-0415.....	53
2-669-0111.....	53	2-669-0417.....	53
2-669-0112.....	53	2-669-0418.....	53
2-669-0115.....	53	2-669-0422.....	53
2-669-0116.....	54	2-669-0424.....	53
2-669-0119.....	54	2-669-0425.....	53
2-669-0120.....	54	2-669-0597.....	55
2-669-0123.....	54	2-669-0600.....	55
2-669-0124.....	54	2-669-0603.....	55
2-669-0127.....	54	2-669-0604.....	55
2-669-0128.....	54	2-669-0605.....	55
2-669-0131.....	54	2-669-0613.....	55
2-669-0132.....	54	2-669-0615.....	55
2-669-0135.....	54	2-669-0616.....	55
2-669-0136.....	54	2-669-0635.....	55
2-669-0139.....	54	2-669-0636.....	55
2-669-0140.....	54	2-669-0641.....	55
2-669-0143.....	54	2-669-0643.....	55
2-669-0144.....	54	DPM.....	47
2-669-0147.....	54	LM.....	47
2-669-0148.....	54	RX.....	47
2-669-0157.....	54	Stainless Mortise Lock Levers (each).....	51
2-669-0158.....	54	Zinc Mortise Lock Levers (each).....	51
2-669-0167.....	54		
2-669-0168.....	54		
2-669-0224.....	52		
2-669-0226.....	52		
2-669-0230.....	52		
2-669-0232.....	52		
2-669-0236.....	52		
2-669-0238.....	52		
2-669-0242.....	52		
2-669-0244.....	52		
2-669-0248.....	52		
2-669-0250.....	52		
2-669-0254.....	52		
2-669-0256.....	52		
2-669-0296.....	52		
2-669-0298.....	52		
2-669-0302.....	52		
2-669-0304.....	52		
2-669-0308.....	53		
2-669-0310.....	53		
2-669-0314.....	53		
2-669-0316.....	53		
2-669-0320.....	53		
2-669-0322.....	53		
2-669-0326.....	53		
2-669-0328.....	53		
2-669-0365.....	53		
2-669-0366.....	54		
2-669-0389.....	11		
2-669-0389.....	26		
2-669-0389.....	29		
2-669-0389.....	35		
2-669-0389.....	38		



380F	21	5905	17
380G	21	5905	20
380H	21	5906	12
380R	21	5906	17
380S	21	5907	12
381A	22	5907	17
381B	22	5908	12
381C	22	5908	17
381D	22	5909	7
381E	22	5911	12
381H	23	5911	17
381S	23	5912	12
381W	23	5912	17
5100 Series	5	5913	12
5101	6	5913	17
5102	6	5913	20
5103	6	5914	12
5104	6	5914	17
5106	6	5915	17
5107	6	5916	17
5108	7	5917	17
5109	7	5918	12
5110	7	5919	12
5111	7	5920	13
5112	7	5921	13
5113	7	5922	13
5114	7	5923	13
5115	7	5932	13
5125	7	5935	7
5200 Series	10	5936	13
5201	11	5936	18
5202	11	5940	7
5203	11	5941	8
5204	11	5942	8
5207	11	5943	8
5300 Series	15	5946	8
5301	16	5950	8
5302	16	5950	13
5303	16	5950	18
5304	16	5954	8
5307	16	5955	8
5400 Series	19	5956	13
5401	19	5956	13
5403	20	5957	13
5404	20	5957	13
5900	11	5961	8
5900	16	5962	8
5900	18	6000 Series Accessories	25
5901	11	6000 Series Screwpacks	25
5901	16	6000 Series Screwpacks	26
5902	11	6015 Series - Medium Duty Concealed Mount	24
5902	16	6015 Series - Medium Duty Surface Mount	24
5902	20	6016 Series - Medium Duty Concealed Mount	24
5903	12	6016 Series - Medium Duty Surface Mount	24
5903	16	6017 Series - Medium Duty Concealed Mount	25
5903	20	6017 Series - Medium Duty Surface Mount	25
5904	12	7000 Series Accessories	27
5904	17	7000 Series Accessories	27
5904	20	7000 Series Screwpacks	27
5905	12	7015 Series - Heavy Duty Concealed Mount	26

7015 Series - Heavy Duty Surface Mount 26
7016 Series - Heavy Duty Concealed Mount 26
7016 Series - Heavy Duty Surface Mount 26
7017 Series - Heavy Duty Concealed Mount 27
7017 Series - Heavy Duty Surface Mount 27
2-659-0187 8
2-659-0188 8
2-659-0189 8
2-659-0190 8
2-659-0191 13
2-659-0191 18
2-659-0192 13
2-659-0192 18
2-659-0193 13
2-659-0193 18
2-659-0194 13
2-659-0194 18
2-659-0195 9
2-659-0196 9
2-659-0197 9
2-659-0198 9
2-659-0199 14
2-659-0199 18
2-659-0200
2-659-0200 18
2-659-0201 14
2-659-0201 18
2-659-0202 14
2-659-0202 18
2-659-0203 9
2-659-0204 9
2-659-0205 9
2-659-0206 9
2-659-0207 9
2-659-0208 9
2-659-0209 9
2-659-0210 9
2-659-0211 14
2-659-0212 14
2-659-0213 14
2-659-0214 14
2-659-0215 14
2-659-0216 14
2-659-0217 14
2-659-0218 14



45BE	13	4916	46
45CE	15	4917	41
45DT	17	4918	41
45MB	14	4919	41
45MC	16	4920	22
45MD	18	4920	33
45MN	20	4920F	22
45NL	19	4920F	33
45PD	21	4921	22
45PN	21	4923	23
45PT	21	4923F	23
46BE	30	4924	23
46CE	31	4924F	23
46DT	31	4925R	33
46NK	32	4926	23
46NL	32	4927	23
47BE	36	4928	24
47BT	40	4929	24
47CE	37	4929C	24
47DT	37	4930R	42
47KD	38	4930S	42
47KE	39	4931R	24
47KN	39	4931S	25
47KP	40	4932C	25
47NL	38	4932R	42
47PD	40	4932S	42
47PN	40	4933R	42
47PT	40	4933S	42
47RD	41	4934	25
47RN	41	4934F	42
313LE (313LF w/Plastisol)	22	4936	25
313SE (313SF w/Plastisol)	22	4936	42
3901	46	4937	25
3902	47	4937	42
4501 CLB	12	4940	25
4501 CVR	11	4941R	34
4501 D	13	4945	26
4501 M	12	4945F	26
4501 N	13	4950	34
4501 RIM	9	4951	34
4501 SVR	10	4952	34
4501 SVR LBR	9	4953	45
4601 RIM	30	4953	46
4701 RIM	36	4960R	34
4701 SVR	36	4965R	35
4900T	45	2-647-0012	48
4900U	45	2-647-0013	48
4902	46	2-647-0014	48
4904	45	2-647-0015	48
4905	45	2-649-0010	42
4907	46	2-649-0011	43
4910	41	2-649-0012	43
4911	41	2-649-0013	43
4912	46	2-649-0014	43
4912	45	2-649-0021	43
4913	46	2-649-0022	43
4914	41	2-649-0023	43
4915	41	2-649-0024	43
4915	22	2-649-0025	43
4916	45	2-649-0026	43



2-649-0027	43	2-649-0096	43
2-649-0028	43	2-649-0097	43
2-649-0031	26	2-649-0098	43
2-649-0032	26	2-649-0099	43
2-649-0033	26	2-649-0100	43
2-649-0034	26	2-649-0101	43
2-649-0035	26	2-649-0102	43
2-649-0036	26	2-649-0103	43
2-649-0037	26	2-649-0137	44
2-649-0038	26	2-649-0141	47
2-649-0038	35	2-649-0142	44
2-649-0039	26	2-649-0144	44
2-649-0039	35	2-649-0145	44
2-649-0040	26	2-649-0146	44
2-649-0040	35	2-649-0147	44
2-649-0041	26	2-649-0164	44
2-649-0041	35	2-649-0166	28
2-649-0042	26	2-649-0167	28
2-649-0042	35	2-649-0168	28
2-649-0043	26	2-649-0168	35
2-649-0043	35	2-649-0177	28
2-649-0044	26	2-649-0177	44
2-649-0044	35	2-649-0178	28
2-649-0045	47	2-649-0179	28
2-649-0046	47	2-649-0180	28
2-649-0047	47	2-649-0181	28
2-649-0048	47	2-649-0182	28
2-649-0049	27	2-649-0183	28
2-649-0050	47	2-649-0183	44
2-649-0051	47	2-649-0184	44
2-649-0052	47	2-649-0185	44
2-649-0053	47	2-649-0203	29
2-649-0054	47	2-649-0204	29
2-649-0055	47	2-649-0205	29
2-649-0056	47	2-649-0206	29
2-649-0057	47	2-649-0207	29
2-649-0058	48	2-649-0208	29
2-649-0059	48	2-649-0214	26
2-649-0060	27	2-649-0214	35
2-649-0061	27	2-649-0215	26
2-649-0062	27	2-649-0215	35
2-649-0063	27	2-649-0216	26
2-649-0064	27	2-649-0216	35
2-649-0065	27	2-649-0217	26
2-649-0066	27	2-649-0217	35
2-649-0074	27	2-649-0218	26
2-649-0075	27	2-649-0218	35
2-649-0076	27	2-649-0219	26
2-649-0077	27	2-649-0219	35
2-649-0078	27	2-649-0220	26
2-649-0079	27	2-649-0220	35
2-649-0080	27	2-649-1074	29
2-649-0081	27	2-649-1074	35
2-649-0082	28	2-649-1090	29
2-649-0083	28	2-649-1090	35
2-649-0084	28	2-649-1108	29
2-649-0085	28	2-649-1109	29
2-649-0086	28	2-649-4703	44
2-649-0087	28		
2-649-0088	28		
2-649-0095	28		



29KS ADD	3	2-659-0171	18
29KS ASD	3	2-659-0172	18
29KS MDD	3	2-659-0173	18
29KS MSD	3	2-659-0174	19
2901	3	2-659-0175	19
2902	3	2-659-0176	19
2903	3	2-659-0177	19
2904	3	2-659-0178	19
2908	3	2-659-0179	19
2909	3	2-659-0180	19
2915	4	2-659-0181	19
2916	4	2-659-0182	20
2916P	4	2-659-0183	20
2925	5	2-659-0184	20
2928 RC	5	2-659-0185	20
2928 SC	5	2-659-0186	20
2930 CYL	5	2-659-0220	13
2930 MDB	5	2-659-0221	13
2930 MOR	5	2-659-0222	13
2941 Magnetic Lock	6	2-659-0223	13
2942 Magnetic Lock	6	2-659-0224	13
2951 Magnetic Lock	6	2-659-0225	13
2952 Magnetic Lock	7	2-659-0226	13
2953 Magnetic Lock	7	2-659-0227	13
2954 Magnetic Lock	7	2-659-0228	13
2958 Delayed Egress Magnetic Lock	9	2-659-0229	13
2958 T Tandem Delayed Egress Magnetic Lock	9	2-659-0230	13
2961 Magnetic Shear Lock	9	2-659-0231	13
2965 Magnetic Shear Lock	9	2-659-0232	13
2972 Exit Switch	10	2-659-0233	13
2972T Exit Switch with Integrated Adjustable Timer	10	2-659-0234	14
2973 Code Compliant Exit Switch	10	2-659-0235	14
2977 Exit Switch	10	2-659-0236	14
2978 Touchless Exit Switch	10	2-659-0237	14
4801 Pressure Sense Bar	10	2-659-0240	20
8218 Single Operator	15	2-659-0241	18
8219 Simultaneous Pair Operator	15	2-659-0242	19
8221 Double Egress Simultaneous Pair Operator	15	2-659-0243	19
8418 Single Operator	12	2-659-0275	15
8419 Simultaneous Pair	12	2-659-0276	15
8420 Independent Pair	12	2-659-0277	15
8421 Double Egress Simultaneous Pair	12	2-659-0278	15
8422 Double Egress Independent Pair	12	2-659-0279	15
8423 Single Operator with Mechanical Closer	12	2-659-0280	15
2928 6R	5	2-659-0283	16
2928 7R	5	2-659-0284	16
2-659-0151	13	2-659-0285	16
2-659-0152	13	2-659-0286	16
2-659-0153	13	2-659-0287	16
2-659-0154	13	2-659-0288	16
2-659-0161	17	2-659-0289	16
2-659-0162	17	2-659-0290	16
2-659-0163	17	2-659-0291	16
2-659-0164	17	2-659-0292	16
2-659-0165	18	2-659-0293	16
2-659-0166	18	2-659-0294	16
2-659-0167	18	2-659-0295	16
2-659-0168	18	2-659-0296	16
2-659-0169	18	2-659-0297	16
2-659-0170	18	2-659-0298	16

2-659-0299	16	2-679-0581	9
2-659-0300	16	2-679-0583	9
2-659-0301	16	2-679-0600	9
2-659-0303	17	2-679-0601	9
2-659-0304	17	2-679-0611 PIR Egress Sensor	11
2-659-0305	17	2-679-0612 PIR Egress Sensor	11
2-659-0306	17	2-679-0620	11
2-679-0021	4	2-679-0621	11
2-679-0022	4	2-679-0622	11
2-679-0023	4	2-679-0623	11
2-679-0024	4	2-679-0624	11
2-679-0028	6	2-679-0625	11
2-679-0029	6	2-679-0626	11
2-679-0100	6	2-679-0640	11
2-679-0101	6	2-679-0641	11
2-679-0102	6	2-679-0642	11
2-679-0103	6	2-679-0650	11
2-679-0104	6	2-679-0661	3
2-679-0105	6	2-679-0662	3
2-679-0106	6	2-679-0664	3
2-679-0107	6	2-679-0669	4
2-679-0108	6	2-679-0700	4
2-679-0120	7	2-679-0703	4
2-679-0121	7	2-679-0704	4
2-679-0130	7	2-679-0705	4
2-679-0131	7	2-679-0706	4
2-679-0160	7	2-679-0708	4
2-679-0161	7	2-679-0708	11
2-679-0180	7		
2-679-0181	7		
2-679-0190	7		
2-679-0191	7		
2-679-0200	7		
2-679-0201	7		
2-679-0204	7		
2-679-0205	8		
2-679-0210	8		
2-679-0220	8		
2-679-0281	8		
2-679-0283	8		
2-679-0291	8		
2-679-0293	8		
2-679-0311	8		
2-679-0313	8		
2-679-0321	8		
2-679-0323	8		
2-679-0381	8		
2-679-0383	8		
2-679-0391	8		
2-679-0393	8		
2-679-0411	8		
2-679-0413	8		
2-679-0421	8		
2-679-0423	8		
2-679-0491	9		
2-679-0493	9		
2-679-0501	9		
2-679-0503	9		
2-679-0571	9		
2-679-0573	9		



100	12	1279 - Continued 2	58
251	12	1303	64
252	12	1577	64
253	12	1578	65
254	12	1712	65
263	12	1713	65
265	12	1716	65
305	12	1717	65
417	12	1722	65
430	12	1723	65
451	12	1728	66
452	12	1729	66
453	12	1850	66
454	13	1850 LP	66
455	13	AB700	17
456	13	AB700 - Continued..	18
457	13	AB7001	68
458	13	AB7002	69
495	13	AB701	20
496	13	AB702	20
497	13	AB703	20
500	14	AB750	20
510	14	AB750 - Continued..	21
511	14	AB7501	69
512	14	AB7502	69
550	14	AB7505	69
551	14	AB7506	70
600	14	AB7507	70
610	14	AB7508	70
611	15	AB7509	70
612	15	AB751	22
615	15	AB7511	70
700	15	AB7512	71
700 - Continued..	16	AB752	22
800	23	AB7523	71
920	29	AB753	23
990	31	AB7534	71
992	31	AB800	24
1129	32	AB801	26
1150	32	AB802	26
1173	38	AB803	26
1191	39	AB850	26
1191 - Continued..	40	AB850 - Continued..	27
1250	50	AB8505	71
1251	50	AB8506	71
1251 - Continued..	51	AB8507	71
1252	51	AB8508	72
1253	51	AB8509	72
1255	52	AB851	28
1256	52	AB852	29
1257	52	AB853	29
1258	53	AB920	30
1259	53	AB923	30
1260	53	AB930	31
1260 - Continued..	54	AB933	31
1267	55	BB1109	32
1277	55	BB1129	32
1278	56	BB1138	32
1279	56	BB1160	33
1279 - Continued..	57	BB1162	33



BB1163	33	EC1101	73
BB1165	33	EC1105	74
BB1166	34	ECBB1100	73
BB1167	34	ECBB1100 NRP	73
BB1168	35	ECBB1101	73
BB1168 - Continued.	36	ECBB1101 NRP	73
BB1168 Drop Leaf	75	ECBB1102	73
BB1168 Short Leaf	75	ECBB1102 NRP	73
BB1168 Unequal Leaf Centered	76	ECBB1103	74
BB1173	38	ECBB1103 NRP	74
BB1190	39	ECRC1100	73
BB1191	41	ECRCBB1100	73
BB1191 - Continued.	42	IHTAB750	22
BB1191 - Continued 2	43	IHTAB850	28
BB1191 Drop Leaf	75	IHTHB953	31
BB1191 Short Leaf	75	WT1191	44
BB1191 Unequal Leaf Centered	76	WT1191 - Continued.	45
BB1192	46	WT1279	63
BB1195	46	WT1279 - Continued.	64
BB1196	46	WTAB700	19
BB1197	46	WTAB700 - Continued.	20
BB1199	47	WTAB750	21
BB1199 - Continued.	48	WTAB750 - Continued.	22
BB1199 Drop Leaf	75	WTAB800	25
BB1199 Short Leaf	75	WTAB800 - Continued.	26
BB1199 Unequal Leaf Centered	76	WTAB850	27
BB1260	54	WTAB850 - Continued.	28
BB1261	54	WTBB1168	37
BB1262	54	WTBB1168 - Continued.	38
BB1263	54	WTBB1191	44
BB1264	55	WTBB1191 - Continued.	45
BB1265	55	WTBB1191 - Continued 2	46
BB1266	55	WTBB1199	49
BB1270	55	WTBB1199 - Continued.	50
BB1277	55	WTBB1279	62
BB1278	57	WTBB1279 - Continued.	63
BB1279	59		
BB1279 - Continued.	60		
BB1279 - Continued 2	61		
BB1279 Drop Leaf	75		
BB1279 Short Leaf	75		
BB1279 Unequal Leaf Centered	76		
BB1360	64		
BB1361	64		
BB1362	64		
BB1363	64		
BB1577	65		
BB1578	65		
BB2098	66		
BB2108	66		
BB2109	66		
BB2110	67		
BB2112	67		
BB2113	67		
BB2168	67		
BB2169	68		
BB2171	68		
CB1191	43		
EC1100	72		
EC1100 NRP	72		



1340	4
1541	4
1543	5
1700	18
1710	19
1720	19
1734	5
1741	6
1744	9
1750	10
1751	10
1752	11
1754	11
1760	11
1761	12
1762	12
1764	12
1816	12
1817	12
1818	13
1819	13
1848	16
2617	16
2817	17
7741	17
8741	18
8744	18
8746	18
BB1541	4
BB1543	5
BB1741	7
BB1816	12
BB1817	13
RC1541	4
RC1542	5
RC1641	3
RC1741	7
RC1741	8
RC1748	9
RC1749	9
RC1841	14
RC1842	14
RC1843	15
RC1843	15
RC1846	15
RC1846	16
RC1847	16
RC1847	16
RCBB1541	4
RCBB1542	5
RCBB1741	8
RCBB1842	15

500-048.....	15
500-200.....	15
500-220.....	15
750-134.....	15
750-138.....	15
780-041HD.....	16
780-041LL.....	16
780-045HD.....	16
780-046HD.....	17
780-053.....	17
780-053HD.....	17
780-054HD.....	18
780-057HD.....	18
780-110HD.....	18
780-111.....	19
780-111HD.....	19
780-111LL.....	19
780-112.....	20
780-112HD.....	20
780-112LL.....	20
780-113HD.....	21
780-114HD.....	21
780-124HD.....	21
780-124LL.....	22
780-155HD.....	22
780-157.....	22
780-157HD.....	23
780-208HD.....	23
780-210.....	23
780-210HD.....	24
780-211HD.....	24
780-213HD.....	24
780-224.....	25
780-224HD.....	25
780-224LL.....	25
780-226HD.....	26
780-226LL.....	26
780-235HD.....	26
780-257HD.....	27
780-259HD.....	27
780-300HD.....	27
1200-600XHD.....	28
1200-650XHD.....	28



790-900.....	6
790-903.....	6
790-904.....	6
790-905.....	6
790-906.....	6
790-909.....	7
790-911.....	7
790-915.....	7
790-926.....	7

1E	9	22N	21
1G	9	23Q	22
1J	9	24Q	22
1L	9	25B	22
2E	9	25C	22
2G	10	25N	22
2J	10	25P	23
2L	10	26N	23
3E	10	27N	23
3G	10	27P	23
3J	11	30S	24
3L	11	31E	26
4G	11	31G	26
4H	12	31J	27
4J	12	32E	27
4L	12	32G	28
5D	12	32J	28
5N	12	33E	29
6N	13	33G	29
7N	13	33J	30
8N	13	34G	30
9E	13	34J	31
9G	14	35D	31
9J	14	35N	32
9L	14	36N	32
10L	14	39E	33
10Q	14	39G	33
11E	15	39J	34
11G	15	40R	35
11J	15	50T	37
11L	15	60S	38
12G	15	70S	39
12J	16	80S	40
12L	16	90R	41
13E	16	100T	42
13G	16	110S	43
13J	16	120L	43
13L	17	121L	43
14G	17	122L	43
14H	17	125S	44
14J	17	126S	44
14L	17	127S	44
15C	18	128P	44
15N	18	128S	44
15P	18	129P	44
15S	18	130S	45
16N	18	131S	45
16R	19	133S	45
17N	19	134S	45
19N	19	136S	45
20L	19	137S	46
20N	19	138P	46
20Q	20	139P	46
21E	20	140P	46
21G	20	150B	46
21J	20	150D	47
21L	21	150V	47
22G	21	151B	47
22J	21	151D	47
22L	21	151V	47



152B	48	204S	7
152D	48	208	119
152V	48	209	119
153B	48	210	120
153D	48	211	120
153V	49	212	120
154B	49	214S	7
154D	49	220S	7
154V	49	225S	8
155B	49	230W	65
155D	50	232W	65
155V	50	234W	65
156B	50	236W	66
156D	50	241F	66
156V	51	242F	66
157B	51	243F	66
157D	51	244F	67
157V	51	245F	67
158B	52	246B	67
158D	52	248F	67
158V	52	248G	67
159B	52	249F	67
159D	53	250W	68
159V	53	251W	68
160B	53	252F	68
160D	53	254S	68
160V	54	254W	68
161B	54	255S	68
161D	54	255W	69
161V	54	256S	69
164B	55	256W	69
164D	55	257F	69
164V	55	258F	69
165B	55	259F	69
165D	55	259H	70
165V	56	260W	70
167B	56	267F	70
167D	56	267S	70
167V	56	268F	70
170D	56	268S	70
180H	57	269F	71
180K	57	269T	71
180M	58	270C	71
180P	58	270D	71
180Q	59	270R	71
181H	59	271D	71
181K	60	271W	71
181M	60	272W	72
181P	61	273W	72
181Q	61	274B	72
182H	62	274C	72
182K	62	274D	72
182M	63	275D	72
182P	63	276D	72
182Q	64	277D	73
185G	65	278D	73
190S	7	279D	73
198S	7	280X	73
199B	7	281D	73
199B	119	282D	74

283D	74	340D	85
291D	74	341D	85
292D	75	342D	85
293D	75	345D	85
294D	75	350H	86
295M	76	350L	86
295W	76	350M	86
296W	76	350R	87
297C	76	350W	86
297D	77	351H	87
297F	77	351L	87
297M	77	352M	87
297N	77	352W	87
298D	77	354A	88
300D	78	354B	88
301D	78	360M	88
303W	78	360W	88
305D	78	361H	88
307D	78	361L	88
308D	79	362H	88
310C	79	362L	89
311H	79	364L	89
313S	79	364M	89
318D	80	364N	89
318S	80	364S	89
320R	80	365M	89
321R	80	365W	90
322V	80	366R	90
323S	80	366S	90
324W	81	368E	90
326F	81	368M	90
326W	81	368U	91
327F	81	368W	91
327W	82	369L	91
328F	82	369R	91
329F	82	370M	91
330D	82	370U	91
330L	82	370W	92
330M	83	901P	92
334V	83	902P	92
336A	83	903P	92
336B	83	910B	93
336C	83	910P	92
336D	83	915B	94
336E	83	915P	93
336F	83	920B	94
336G	83	920P	94
336H	84	921B	95
336J	84	921P	95
336K	84	922B	96
336L	84	922P	95
336M	84	923B	97
336N	84	923P	96
336P	84	924B	97
336Q	84	924P	97
336R	84	925B	99
337A	84	925P	98
337B	84	926B	99
337C	85	926P	99
337D	85	930B	100



930P	100	1446	122
932P	100	1447	122
933B	101	1448	122
933P	101	1449	122
934B	102	1755	122
934P	101	1756	123
936P	102	1758	123
937P	102	1759	123
940P	102	1765	123
941P	103	1766	123
945P	103	1795	123
946P	103	1797	124
951P	103	1798	124
952P	103	1799	124
956P	103	1801	124
957P	103	2610	117
960B	104	2620	118
960P	103	2630	118
961B	104	2640	118
961P	104	6601	125
962P	104	9558	118
963P	105	9566	118
967P	105	9567	118
970P	106	9865	119
974B	107	9882	119
974P	106	9884	119
975B	108	A30S	25
975P	108	A40R	36
976B	109	A50T	38
976P	108	BL6209	124
980B	110	BL6211	124
980P	109	BL6212	124
981B	112	BL6610	125
981P	111	BL6793	125
982B	112	BL6794	125
982P	112	CSK	8
983B	113	P4E	11
983P	113	P8N	13
984B	114	SA	8
984P	114	T4E	11
985B	115		
985P	114		
986B	115		
986P	115		
987B	115		
987P	115		
988B	116		
988P	115		
990B	117		
990P	116		
1412	120		
1413	120		
1414	121		
1415	121		
1416	121		
1418	121		
1419	121		
1439	122		
1442	117		
1443	117		

400S 6
401S 6
402S 6
403S 6
404S 6
406S 6
407S 6
408S 6
410S 6
411S 6
412S 7
413S 7
415S 7
416S 7
417S 7
418S 7
419S 7
420S 7
421S 7
422S 7
423S 7
424S 8
426S 8
427S 8
428S 8
430S 8
431S 8
432S 8
433S 8
434S 8
435S 8
436S 8
438S 9
440S 9
442S 9
443S 9
444S 9
445S 9
448S 9
450S 9
451S 9
452S 9
455S 10
460S 10
465S 10
470S 10
477S 10
478S 10
480S 10
481S 10
484S 10
492S 10
503S 10
504S 10
505S 10
506S 11
508S 11
515S 11
516S 11
517S 11

518S 11
520S 11
532S 11
541S 11
552S 12
560S 12
565S 12
572S 12
575S 12
580S 12
599S 13
600S 13
603S 13
604S 13
608S 13
626S 13
627S 13
651S 13
652S 13
653S 14
654S 15
655S 15
676S 15
677S 15
701S 15
710S 15
717S 15
718S 15
719 15
720 15
721 16
722 16
724 16
725 16
726 16
727 17
728 17
729 17
730S 17
734 17
736 18
737 18
738 18
739 18
740S 19
742S 19
743S 19
747S 19
750S 20
752S 20
753S 20
754S 20
756S 20
759S 21
770S 21
771S 21
774S 21
776S 21
777S 21



778S	21	896S	27
779S	22	900S	28
780S	22	901S	28
782S	22	902S	28
783S	22	903S	28
785S	22	904S	28
787S	22	905S	28
789S	22	906S	28
800S	22		
801S	23		
802S	23		
803S	23		
806S	23		
808S	23		
810S	23		
822S	23		
835S	24		
836S	24		
837S	24		
838S	24		
839S	24		
844S	24		
845S	24		
846S	25		
847S	24		
848S	24		
849S	24		
859S	25		
860S	25		
861S	25		
862S	25		
863S	25		
864S	25		
865S	25		
866S	25		
870S	25		
871S	26		
872S	26		
873S	26		
874S	26		
875S	26		
877S	26		
878S	26		
880S	26		
881S	26		
882S	27		
883S	27		
884S	27		
885S	27		
890S	27		
891S	27		
892S	27		
893S	27		

330D	25	9353	5
330L	25	9353	28
330M	25	9354	28
1741	16	9400	5
1741	17	9400	12
1741	25	9400	28
2610	5	9401	5
2610	7	9401	8
2610	11	9401	12
2610	25	9401	28
2620	25	9432-78	35
2630	7	9433-78	35
2630	11	9435-78	35
2630	26	9435-96	35
2640	26	9436-78	35
9101-60	4	9437-78	35
9101-60	26	9438-78	35
9101-72	18	9462-78	35
9102	4	9462-96	35
9102	18	9514-48	5
9102	26	9540	7
9105	4	9540	11
9105	18	9540	28
9105	26	9544	7
9109	4	9544	11
9109	18	9544	28
9109	26	9558	15
9110-60	4	9558	28
9110-60	18	9559	15
9111	26	9559	16
9113	26	9559	28
9114-72	26	9566	28
9115	4	9567	29
9115	18	9569	15
9115	24	9569	29
9115	26	9570-36	15
9121	27	9572	9
9122-48	27	9572	10
9128	27	9572	15
9129	4	9572	29
9129	18	9573	6
9129	27	9573	29
9130-60	4	9574	13
9130-60	18	9574	29
9169	27	9575	9
9200	27	9575	10
9201	27	9575	29
9202	7	9583-96	5
9202	11	9601-35	15
9202	27	9601-71	19
9203	27	9601-71	20
9220	15	9601-71	29
9220	27	9602-46	10
9262	27	9602-46	29
9264	27	9602-58	10
9268	27	9603-48	9
9351	5	9603-48	29
9351	8	9605	9
9351	12	9605	10
9351	28	9605	20



9605	30	9815	14
9606	9	9815	15
9606	10	9815	16
9606	19	9815	24
9606	20	9815	32
9606	30	9820-48	7
9610	30	9820-48	32
9611-60	6	9821-59	6
9614-48	7	9821-59	16
9618	15	9821-59	23
9618	30	9821-59	32
9628	19	9824	6
9629	19	9824	32
9630	19	9825	6
9631	19	9825	16
9632	20	9825	23
9632	30	9825	32
9633	20	9827	13
9633	30	9827	14
9634	30	9827	17
9639	30	9827	21
9673-48	9	9827	22
9674-48	9	9827	24
9675-48	10	9827	32
9676-48	10	9828	16
9678-72	20	9828	17
9679	9	9828	32
9679	10	9840-46	11
9679	30	9840-46	32
9680	9	9841	5
9680	10	9841	7
9680	30	9841	11
9683-96	7	9841	33
9703-60	24	9842	7
9703-60	30	9842	11
9704-60	24	9842	33
9704-60	31	9843	7
9705	24	9843	11
9705	31	9843	33
9709-48	6	9844-48	11
9709-48	10	9845-96	11
9709-60	31	9850	21
9710-60	24	9860-30	16
9711	24	9861-48	16
9711	31	9865	5
9742	22	9865	8
9742	31	9865	12
9801-48	17	9865	33
9801-72	13	9875-48	13
9801-72	21	9877	33
9801-72	22	9878-72	22
9801-72	31	9880	33
9803-48	14	9881	19
9803-48	31	9881	20
9809-72	13	9881	21
9809-72	31	9881	22
9810-46	5	9881	23
9810-46	31	9881	33
9814	5	9882	33
9814	32	9883	19

988320
988321
988322
988323
988333
988433
9885-48.....14
9886-96.....14
988934
9890-30.....17
98926
989234
98936
989334
989416
989434
989523
989534
990034
9901-72.....23
99096
99099
990910
990913
990914
990934
1-269-8663.....36
1-269-8664.....36
1-269-8665.....36
1-269-8666.....36
1-269-8667.....36
1-269-8668.....36
1-269-8669.....36
1-269-8670.....36
1-269-8671.....36
1-269-8672.....36
1-269-8673.....36
1-269-8674.....36
1-269-8675.....36
1-269-8676.....36
1-269-8677.....37
1-269-8678.....37
1-269-8679.....37
1-269-8680.....37

