

FALCON®

Locks

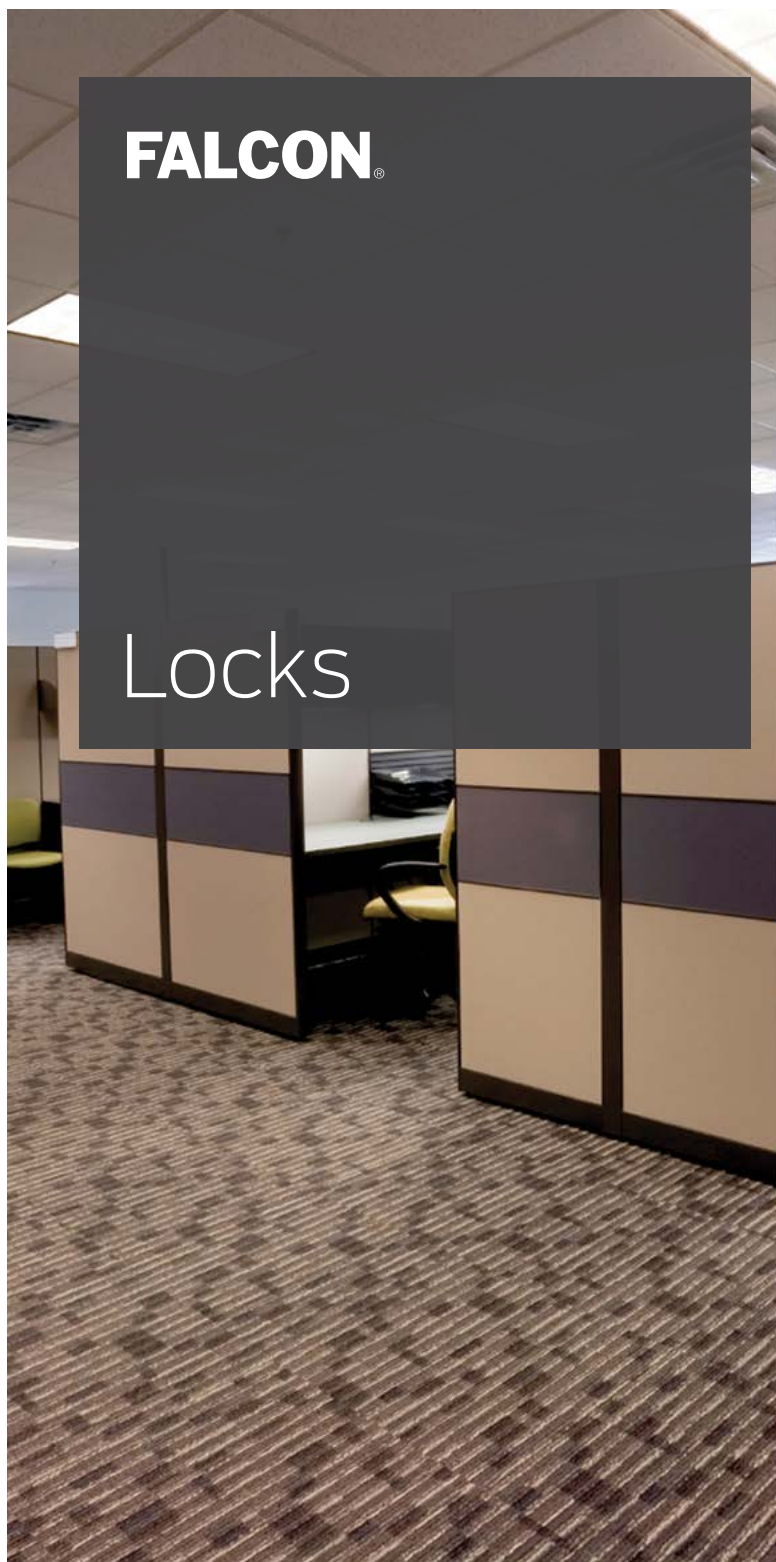

Contents

- 4-5 Lock type comparison chart
- 6 Lock type definitions and door handing diagram
- 7 Finish swatch reference chart
- 8-21 MA Series Grade 1 mortise lock
- 22-33 RU Series Grade 1 retrofit unit lock
- 34-43 T Series Grade 1 cylindrical lock
- 44-53 X Series Grade 1 cylindrical knob lock
- 54-61 K Series Grade 1 cylindrical lock
- 62-71 B Series Grade 2 cylindrical lock
- 72-83 W Series Grade 2 cylindrical lock
- 84-89 H2 Series Grade 2 interconnected lock
- 90-99 D Series Grade 1 and 2 deadbolts
- 100 K900 Series padlocks
- 101 Construction keying information sheet
- 102 Product identification example



www.falconlock.com



US 877.671.7011
Canada 800.900.4734



www.youtube.com/falconhardware



Falcon "How To" app



The Falcon difference

Safety, security and uncompromising value

At Falcon, we know that every product you sell not only has to meet local building codes, but also your expectations for performance and quality. We take your expectations seriously, and that's why we build our locks to deliver durability, convenience and unmatched value. After all, we've built our reputation on the same standards that you have – providing quality products at a reasonable price and delivered on time. It's the way we do business and it's what makes Falcon locks a powerful choice no matter your project.

Lock type comparison

Falcon offers a variety of Grade 1 and Grade 2 cylindrical, deadbolt, mortise, interconnected, and extra-heavy duty pre-assembled unit locks that fit a variety of applications and door functions.



T Series



K Series



X Series



B Series



W Series

Cylindrical

	T Series	K Series	X Series	B Series	W Series
Features	<ul style="list-style-type: none"> Grade 1 certified Wide variety of functions and options Can accept competitive standard cylinders SFIC and FSIC 	<ul style="list-style-type: none"> Grade 1 certified Most common functions, lever styles and finishes Affordable price 	<ul style="list-style-type: none"> Grade 1 certified Corrosion resistant option Compatible with competitive SFIC 	<ul style="list-style-type: none"> Grade 2 certified Perfect replacement for existing locks or new construction Compatible with competitive SFIC 	<ul style="list-style-type: none"> Grade 2 certified Two rose diameter options to match most commercial door trim
Application	<ul style="list-style-type: none"> Ideal for new construction and retrofit applications where Grade 1 security is needed 	<ul style="list-style-type: none"> Where Grade 1 security and reliability are needed, but cost is a concern 	<ul style="list-style-type: none"> Where a Grade 1 security lock is needed and corrosive marine conditions could be a concern 	<ul style="list-style-type: none"> Where frequent use is expected and durability is needed, but Grade 1 security isn't required 	<ul style="list-style-type: none"> Applications with nontraditional door trim where cost is a concern
Options	<ul style="list-style-type: none"> 15 commercial functions 8 finishes 7 lever designs 	<ul style="list-style-type: none"> 8 commercial functions 2 finishes 3 lever designs 	<ul style="list-style-type: none"> 10 commercial functions 6 finishes 3 knob designs 2 rose options 	<ul style="list-style-type: none"> 10 commercial functions 5 finishes 2 lever designs 	<ul style="list-style-type: none"> 12 commercial lever functions 8 commercial knob functions 8 finishes 7 lever/2 knob designs 2 rose options

Lock type comparison



D100 Series



D200 Series



RU Series



MA Series



H2 Series

Deadbolt

Unit

Mortise

Interconnected

Features

- | | | | | |
|------------------------------------------------------------------------------------------------------------------------------------------------------------------------------------|------------------------------------------------------------------------------------------------------------------------------------------------------------------------------------|-------------------------------------------------------------------------------------------------------------------------------------------------------------------------------------------------|--------------------------------------------------------------------------------------------------------------------------------------------------------------------------------------------------------------------|----------------------------------------------------------------------------------------------------------------------------------------------------------------------------------------------------------|
| <ul style="list-style-type: none"> ▪ Grade 1 certified for security ▪ Supplemental protection against break-in ▪ Compatible with competitive SFIC | <ul style="list-style-type: none"> ▪ Grade 2 certified for security ▪ Supplemental protection against break-in ▪ Compatible with competitive SFIC | <ul style="list-style-type: none"> ▪ Grade 1 certified ▪ Old-fashioned style with modern strength, security and convenience ▪ Compatible with competitive SFIC | <ul style="list-style-type: none"> ▪ Grade 1 certified ▪ One of Falcon's toughest locks that is built to stand up to constant use without fail ▪ Compatible with competitive SFIC | <ul style="list-style-type: none"> ▪ Grade 2 certified ▪ Large inner plate that connects lock and deadbolt ▪ Exterior has the appearance of a tubular lock and deadbolt |
|------------------------------------------------------------------------------------------------------------------------------------------------------------------------------------|------------------------------------------------------------------------------------------------------------------------------------------------------------------------------------|-------------------------------------------------------------------------------------------------------------------------------------------------------------------------------------------------|--------------------------------------------------------------------------------------------------------------------------------------------------------------------------------------------------------------------|----------------------------------------------------------------------------------------------------------------------------------------------------------------------------------------------------------|

Application

- | | | | | |
|------------------------------------------------------------------------------------------------------|------------------------------------------------------------------------------------------------------|------------------------------------------------------------------------------------------------------------------------------------|-----------------------------------------------------------------------------------------------------------------------------------------------------------------------------------------------------------|--------------------------------------------------------------------------------------------------------------------------------------------------------------------------------------|
| <ul style="list-style-type: none"> ▪ Where supplemental, Grade 1 security is required | <ul style="list-style-type: none"> ▪ Where supplemental, Grade 2 security is required | <ul style="list-style-type: none"> ▪ Retrofitting older and historical buildings where Grade 1 security is required | <ul style="list-style-type: none"> ▪ Where a tough-as-nails, reliable and durable Grade 1 security lock is required ▪ Facilities where a large variety of applications are needed | <ul style="list-style-type: none"> ▪ Where strength and security are required, but cost is a concern ▪ Used in multi-family applications for one step egress |
|------------------------------------------------------------------------------------------------------|------------------------------------------------------------------------------------------------------|------------------------------------------------------------------------------------------------------------------------------------|-----------------------------------------------------------------------------------------------------------------------------------------------------------------------------------------------------------|--------------------------------------------------------------------------------------------------------------------------------------------------------------------------------------|

Options

- | | | | | |
|--------------------------------------------------------------------------------------------------|--------------------------------------------------------------------------------------------------|------------------------------------------------------------------------------------------------------------------------------|---------------------------------------------------------------------------------------------------------------------------------------------------------------------------------------------------------|----------------------------------------------------------------------------------------------------------------------------|
| <ul style="list-style-type: none"> ▪ 5 commercial functions ▪ 5 finishes | <ul style="list-style-type: none"> ▪ 8 commercial functions ▪ 5 finishes | <ul style="list-style-type: none"> ▪ 12 commercial functions ▪ 2 finishes ▪ 2 lever designs | <ul style="list-style-type: none"> ▪ 26 commercial functions ▪ 9 finishes ▪ 8 lever designs ▪ 1 knob design ▪ Rose (sectional) and escutcheon option | <ul style="list-style-type: none"> ▪ 2 commercial functions ▪ 5 finishes ▪ 5 lever design |
|--------------------------------------------------------------------------------------------------|--------------------------------------------------------------------------------------------------|------------------------------------------------------------------------------------------------------------------------------|---------------------------------------------------------------------------------------------------------------------------------------------------------------------------------------------------------|----------------------------------------------------------------------------------------------------------------------------|

Lock type definitions

Cylindrical locks

A cylindrical lock, also referred to as a bored lock, is a lock in which a large hole is bored into the door face of a door and a smaller cross-bore hole is bored into the door edge. These locks fit a variety of applications and can be Grade 1 or Grade 2.

Deadbolt locks

A deadbolt lock is a supplemental lock that provides an extra measure of protection against break-ins. Can be Grade 1 or Grade 2 certified.

Mortise locks

A mortise lock is the strongest, most adaptable lock that offers the best aesthetics in the Falcon line. This lock offers the most heavy-duty security and is designed to handle high traffic, high abuse applications. Offered in Grade 1 only.

Interconnected locks

An interconnected lock is primarily utilized for multi-family front door applications where security is needed but cost is a concern. This lock offers both a door lock and deadbolt that are connected through an inner plate. This lock is offered in Grade 2.

Unit locks

These locks are designed specifically for retrofitting older and historical buildings. These locks combine an old-fashioned design with modern strength, security, and reliability.

Padlocks





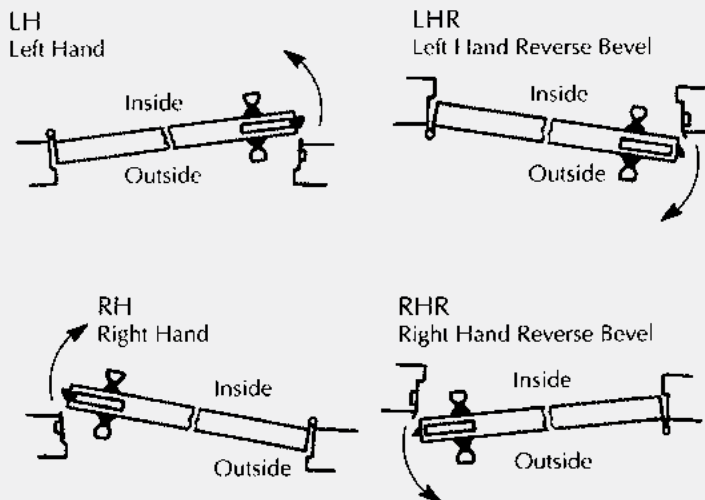





A portable lock hanging by a pivoted hook on the object fastened holding together two parts of something (such as a chain or a gate) to prevent use, theft, vandalism or harm. Padlocks are popular for its low cost and an impact-resistant designs.

Door handing

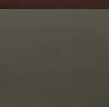

Finishes

The latest in modern techniques and equipment are used to apply the highest quality finish. Extra steps assure durable, consistent finishes and long useful life.

Color		US number	BHMA number
	Bright brass	US3	605
	Satin brass	US4	606
	Satin bronze	US10	612
	Oil rubbed bronze	US10B	613
	Aged bronze	US11	643e
	Satin nickel	US15	619
	Matte black	US19	622
	Bright chrome	US26	625
	Bright chrome	US26D	626
	Satin stainless steel	US32D	630

Note: Not all finishes are standard across all products. Please see price book for specific finish and lever options.

Although we apply the finest available protective plating and/or enamel coating to the surface of our products, these finishes have limitations and in time may deteriorate either from exposure to weather, pollution, perspiration, extremes of climate, frequency of use or other factors. Deterioration of these finishes is, therefore, not a defect, but a normal process which is unavoidable. Our company cannot accept responsibility for finish deterioration in these circumstances and therefore the finishes cannot be guaranteed. These products will not be refinished or replaced under our warranty should deterioration of finishes occur.

MA Series

Grade 1 mortise lever and knob locks

The Falcon MA Series lock delivers high performance at an affordable cost for your office, hospital, education, or other commercial projects. One of Falcon's toughest and most dependable locks, the MA Series, provides security and is built to stand up to constant use without fail. The MA Series also makes retrofit easy with an interchangeable core that can be removed for quick, easy re-keying and is compatible with SFIC products from other manufacturers. Plus they're backed by one of the best names in the business - Allegion.

Features



*Excludes MA551

**For 605, 606, 613, 625 and 626

MA Series

Features

Door thickness: Standard accommodates thickness of 1³/₄" to 2¹/₂".

Backset: 2³/₄" only.

Case: Cold formed steel, zinc dichromate plated, .090" thick. Optional lead wrapping available.

Hubs: Hardened steel.

Handing: Right hand is standard; left hand optional. Reversible in the field.

Cylinders: Solid brass cylinder and plug. 5, 6 or 7-pin are available on standard cylinders. 6 or 7-pin are available on interchangeable core cylinder. Furnished with two nickel silver keys standard.

Keyways: Falcon "G" keyway standard on standard cylinder. "A" keyway standard on I/C cylinder. See price book for optional keyways

Bind resistant trim: Heavy-duty through-bolted inserts clamp the trim on the door assuring proper alignment. Provided with 8-32 screws for strength and thread sealant to prevent loosening.

Latch bolt: Two-piece stainless steel, mechanical anti-friction bolt. ³/₄" projection.

Dead bolt: 1" throw, stainless steel with two ¹³/₁₆" diameter hardened steel, free-turning, saw-resistant roller.

Faceplates: (armored front) 1¹/₄" x 8" brass or stainless steel adjustable for door bevel. Reinforced by heavy gauge steel with stabilizing ribs.

Strike: Brass or stainless steel. Meets ANSI A115.1 for frame preparation. Strike is non-handed.

Electrified functions: Available in 12 or 24 VDC.

Indicator options: Occupied/Vacant or Locked/Unlocked.

ANSI/BHMA: Meets ANSI/BHMA 156.13, Series 1000.

UL: 3 hour A label.

Specifications

- Provide mortise locksets that comply with ANSI A156.13, Series 1000, Operational Grade 1 and Security Grade 1 with all standard trims and conventional mortise cylinders.
- Locksets comply with UL10B - neutral pressure and UL10C/UBC 7-2 –positive pressure testing requirements. All locks shall be UL listed for 3 hour fire door.
- Lock case shall be non-handed, reversible without opening the lock case, and shall be manufactured of zinc dichromate plated steel. Lock case shall be interchangeable for knob or lever applications without modifying the chassis, and shall be constructed with a screw configuration that limits access to operating parts.
- Latchbolt shall be 2-piece anti-friction type manufactured from stainless steel, with a standard 2³/₄" backset, a full ³/₄" throw and be field reversible. Deadbolt shall have 1" throw and shall be constructed of stainless steel, incorporating two ³/₁₆" diameter security roller pins.
- All trim shall be cast, forged, or wrought and through bolted with thread patch coated screws. Lever trim to have individual heavy duty springs for lever return, and independent rotation in both directions. Return to door style levers meets the ¹/₂" California State Fire Marshall requirement.
- Spindles to be independent, designed to 'break-away' at a maximum of 480 in./lbs. to prevent damage to the lock chassis.
- Provide standard non-handed curved lip strikes.
- Cylinders to be secured by a dual retainer.
- Acceptable manufacturer: Falcon Lock

Lever/knob styles

Cast or forged levers (Avalon, Dane and Quantum, Boardwalk, Broadway, Latitude and Longitude) and wrought brass or stainless levers/knobs (Sutro and Hana), wrought rose and forged or wrought escutcheons are standard.

Avalon-Gala (AG)



Dane-Gala (DG)



Hana-Gala (HG)



Quantum-Gala (QG)



Sutro-Gala (SG)



Boardwalk (BRK)*



Broadway (BRW)*



Latitude (LAT)*



Longitude (LON)*



* Available in Q1 2017

Trim styles

Gala rose (G)

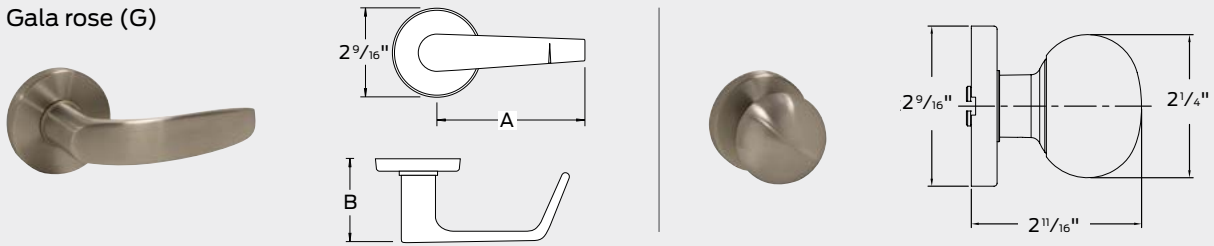

Napa escutcheon (N)

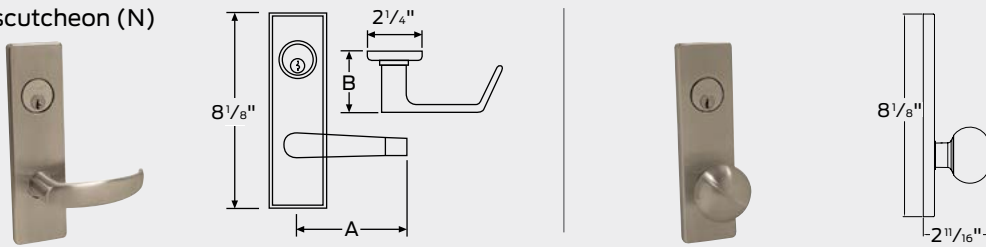

Number	A - width	B - projection
AG/AN	4 1/2"	2 7/8"
DG/DN	4 1/2"	2 1/2"
QG/QN	4 3/4"	3"
SG/SN	4 7/8"	3"

Note: Falcon MA Series is available in several design combinations; "G" Gala rose or "N" Napa escutcheon and "H" Hana knob designation or four levers "A" Avalon, "D" Dane, "Q" Quantum and "S" Sutro. When specifying, example: AN, Avalon (A) lever - with Napa (N) escutcheon.

Trim finishes chart









Description	ANSI No.	Available on
Bright brass	605	All trim
Satin brass	606	All trim
Oil rubbed bronze	613	All trim
Satin nickel	619	Lever trim only
Matte black	622	Lever trim only
Bright chrome	625	All trim
Satin chrome	626	All trim
Satin stainless steel	630	All trim
Aged bronze	643e	Lever trim only

Functions

To order Falcon MA Series locksets, please consult page 21 for ordering information and assistance.

 Indicates interchangeable core available.

 Indicates indicator trim available.

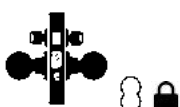







Catalog number	ANSI	Function outside/inside	Name	Description
MA101	F 01		Passage/closet latchset	Latch bolt operated by knob/lever from either side at all times.
MA161	F 31		Connecting room/exit lock	Latch bolt operated by knob/lever from inside. No trim outside. Auxiliary dead latch.
MA301	F 02		Privacy lock	Latch bolt operated by knob/lever from either side. Dead bolt operated by turn from inside and by emergency release from outside.
MA311	F 19		Privacy lock with inside lever release	Latch bolt operated by knob/lever from either side. Dead bolt operated by turn from inside and emergency release from outside. Operating inside knob/lever retracts both bolts.
MA321	F 22		Privacy lock with no entry lockout	Latch bolt operated by knob/lever from either side except when outside knob/lever is locked by inside turn. Operating inside knob/lever, closing door or operating outside emergency release unlocks outside knob/lever.
MA371	F 14		Store door lock	Latch bolt operated by knob/lever from either side. Dead bolt operated by key from either side.
MA381	F 09		Apartment exit lock	Latch bolt operated by knob/lever from either side, except when outside knob/lever is locked by key from inside. When outside knob/lever is locked, latch bolt is retracted by key from outside or by operating inside lever. Auxiliary dead latch.
MA411	F 30		Asylum lock	Latch bolt operated by key from either side. Both knobs/levers always inoperative. Auxiliary dead latch. Caution: Double cylinder locks on residences and any door, in any structure, which is used for egress are a life safety hazard in times of emergency and their use is not recommended. Installation should be in accordance with existing codes only.
MA431	F 34		Security lock with deadbolt	Latch bolt operated by knob/lever from either side except when outside knob/lever is locked from inside or outside by key. Dead bolt retracted by key from inside or outside. Operating inside knob/lever retracts both bolts and unlocks outside. Latch bolt dead locked when dead bolt is thrown.

Functions

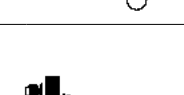
To order Falcon MA Series locksets, please consult page 21 for ordering information and assistance.

 Indicates interchangeable core available.

 Indicates indicator trim available.







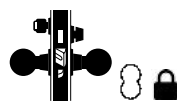

Catalog number	ANSI	Function outside/inside	Name	Description
MA441	F 32		Classroom security lock	Latch bolt operated by knob/lever from either side except when outside knob/lever is locked from inside or outside by key. When outside knob/lever is locked, latch bolt is retracted by key from inside or outside or by operating inside knob/lever. Auxiliary dead latch.
MA451	F 15		Hotel guest lock	Latch bolt operated by key from outside or by operating inside knob/lever. Outside knob/lever is always inoperative. Dead bolt projected by turn from inside and all keys except emergency key are shut out. Operating inside knob/lever retracts both bolts. Auxiliary dead latch.
MA521	F 04		Entry/office lock with button lockout	Latch bolt operated by knob/lever from either side except when outside knob/lever is made inoperative by buttons in face. When outside knob/lever is locked, latch bolt is retracted by key from outside or by operating inside knob/lever. Auxiliary dead latch. Outside knob/lever is unlocked by button on face.
MA531	F 12/ F 20		Apartment corridor lock	Latch bolt operated by knob/lever from either side, except when outside knob/lever is made inoperative by buttons in face. Dead bolt operated by key outside or turn inside. Key outside operates both bolts. Operating inside knob/lever retracts both bolts and outside remains locked. Latch bolt is deadlocked when outside knob/lever is made inoperative or when the dead bolt is projected. When dead bolt is retracted, knob/lever is unlocked by buttons in face.
MA541	F 21		Entry/office lock	Latch bolt operated by knob/lever from either side. Dead bolt operated by key from outside or turn from inside.
MA551	F 06		Holdback lock	Latch bolt operated by lever from either side except when outside lever is locked from outside by key. Latch bolt can be locked in a retracted position by key. When outside lever is locked, latch bolt is retracted by key from outside or by operating inside lever unless latch bolt has been locked in a retracted position. Auxiliary dead latch. To activate the Holdback Function – from the unlocked position rotate the outside lever/knob to retract the latchbolt. Rotate key 360°. Release lever/knob. To release Holdback Function, rotate key 360° clockwise. <small>Note: Chassis is handed.</small>
MA561	F 05		Classroom lock	Latch bolt operated by knob/lever from either side except when outside knob/lever is locked from outside by key. When outside knob/lever is locked, latch bolt is retracted by key from outside, or by operating inside knob/lever. Auxiliary dead latch deadlocks latchbolt when door is closed. Inside knob/lever always free for immediate exit.
MA571	F 13		Dormitory or exit lock	Latch bolt operated by knob/lever from either side. Dead bolt projected by key from outside and turn from inside. Operating inside knob/lever retracts both bolts and unlocks outside.
MA581	F 07		Storeroom lock	Latch bolt operated by key from outside or by operating inside knob/lever. Outside knob/lever is always inoperative. Auxiliary dead latch.

Functions

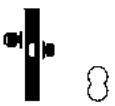
To order Falcon MA Series locksets, please consult page 21 for ordering information and assistance.

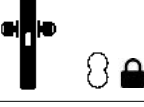
 Indicates interchangeable core available.

 Indicates indicator trim available.

Catalog number	ANSI	Function outside/inside	Name	Description
MA621	F 08/ F 10		Apartment corridor lock with button lockout	Latch bolt is operated by knob/lever from either side, except when outside knob/lever is made inoperative by buttons in face. Dead bolt is operated by turn inside. Key outside operates both bolts. Outside knob/lever is unlocked by button on face.
MA641	NA		Dormitory lock	Latch bolt by knob/lever inside and key outside. Inside knob/lever free. Outside knob/lever rigid. Deadbolt by key outside or T-turn inside. Rotating inside knob/lever retracts both bolts. Deadlocking latch.
MA851	NA		Storeroom-fail safe (EL - 12 or 24V DC) (RX option - request to exit)	Latch bolt operated by knob/lever from either side except when outer knob/lever is electrically locked. When outer knob/lever is locked, latch bolt retracted by key in cylinder outside. Deadlocking latch. <small>Note: Specify 12 or 24V DC.</small>
MA881	NA		Storeroom-fail secure (EU - 12 or 24V DC) (RX option- request to exit)	Latch bolt operated by knob/lever from inside except when outer knob/lever is electrically unlocked, then latch bolt from either side. When locked, key in cylinder outside retracts latch bolt. Deadlocking latch. <small>Note: Specify 12 or 24V DC.</small>
MA911	F 29		Classroom dead lock	Key from outside operates dead bolt. Turn from inside retracts but does not project dead bolt.
MA921	F 18		Outside only deadlock	Dead bolt operated by key from outside only.
MA931	F 16		Two sided deadlock	Dead bolt operated by key from either side. Caution: Double cylinder locks on residences and any door, in any structure, which is used for egress are a life safety hazard in times of emergency and their use is not recommended. Installation should be in accordance with existing codes only.
MA941	F 17		Deadlock with inside turn	Dead bolt operated by key from outside and by turn from inside.
MA12	NA		Single dummy	Single dummy trim
MA18	NA		Double dummy	Double dummy trim

Standard mortise cylinders

Only the finest materials are used in the manufacture of our cylinders. Modern equipment and gauging ensure consistent, reliable production of our entire line of cylinders. We offer a full and complete line of spacer rings, cylinder guards and spring washers, as well as numerous cams to fulfill the requirements of most applications. Standard mortise cylinders are furnished as 5- or 6-pin as standard. 7-pin cylinders are available. All keyed cylinders are supplied with two nickel silver keys.

Standard core MA Series function/cam chart

Catalog number	Outside cam no.	Inside cam no.
MA371	5622	5622
MA381	5621	5620
MA411	5622	5622
MA431	5622	5622
MA441	5622	5622
MA451	5622	
MA521	5622	
MA531	5622	
MA541	5622	
MA551	5622	
MA561	5622	
MA571	5622	
MA581	5622	
MA621	5622	
MA641	5622	
MA851	5622	
MA881	5622	
MA911	5622	
MA921	5622	
MA931	5622	5622
MA941	5622	

Cam numbers
 5622 = standard cam
 5620 = F09 standard inside MA381
 5621 = F09 standard outside MA381

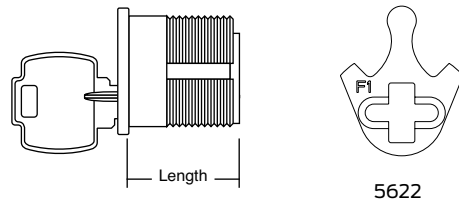

Catalog number	Length	
Standard cylinders		
985	1 1/8"	
987	1 3/8"	
988	1 1/2"	
990	1 3/4"	
992	2"	
Hotel/motel cylinders		
250	1 1/8" RH	6-pin
251	1 1/4" RH	6-pin
252	1 3/8" LH	6-pin
253	1 3/8" LH	7-pin

Special hotel/motel cylinders, furnished with cam A09894-001-00.

Note: To order cylinder separately, order by listing catalog number for required length and cam number as indicated in chart above. Also, specify finish and number of pins.

Example: 986 with A09897-000-00, 626, 6-pin

Interchangeable cores for mortise cylinders

All Falcon MA Series keyed locks are available with mortise cylinders that will accept Falcon small format interchangeable cores (SFIC) as well as some other manufacturers' SFIC. Interchangeable core cylinders are available in 6- or 7-pin configurations, for increased security by quick change of keying. Interchangeable core cylinders allow the capability of immediately changing the keying on any door without the necessity of disassembling the lock. The core is removed by use of a special "control" key. Rotating the key to the right and gently pulling will disengage the core from the housing. The replacement core is then inserted and the control key rotated to the left to "lock" the core in place and the control key is removed.

To order: Falcon mortise locks with interchangeable cores, add "G" 6- or 7-pin in detail area of order.

To order: Falcon mortise locks for interchangeable core, less core (SFIC), add "B" 6- or 7-pin in detail area of order.

Interchangeable core MA Series function/cam chart

Catalog number	Outside cam no.	Inside cam no.
MA371	5622-IC	5622-IC
MA381	5621-IC	5620-IC
MA411	5622-IC	5622-IC
MA431	5622-IC	5622-IC
MA441	5622-IC	5622-IC
MA451	5622-IC	
MA521	5622-IC	
MA531	5622-IC	
MA541	5622-IC	
MA551	5622-IC	
MA561	5622-IC	
MA571	5622-IC	
MA581	5622-IC	
MA621	5622-IC	
MA641	5622-IC	
MA851	5622-IC	
MA881	5622-IC	
MA911	5622-IC	
MA921	5622-IC	
MA931	5622-IC	5622-IC
MA941	5622-IC	

Cam numbers
 5622-IC = interchangeable cam
 5620-IC = F09 Interchangeable Inside MA381
 5621-IC = F09 interchangeable Outside MA381



All keyed cylinders are supplied with two nickel silver keys.

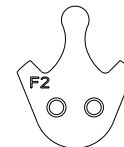
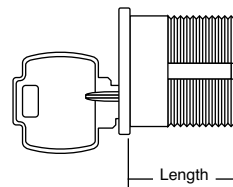

5622-IC

Catalog number	Length
Standard cylinders	
C987	1 ³ / ₈ "
C988	1 ¹ / ₂ "
C990	1 ³ / ₄ "
C992	2"
Hotel/motel cylinders	
C261	1 ¹ / ₂ " RH
C262	1 ⁵ / ₈ " RH
C264	1 ¹ / ₂ " LH
C265	1 ⁵ / ₈ " LH

Special hotel/motel cylinders furnished with cam A12667-007-00.

Note: To order the cylinder housing only, order by listing catalog number for required length and cam number as indicated in the chart. Also specify finish and pin condition.

Example: No. C987 with A12667-003-00, 626, for 7-pin interchangeable core.

Note: Construction keying available. Reference page 101 for more information.

Cylinder guards

Falcon offers two different types of cylinder guards in various thicknesses to work with sectional or escutcheon trim, different door ranges and various cylinder lengths. Our standard cylinder, 985, is 1 1/8" long. The factory will furnish the correct cam(s) and cylinder guard for the function and door thickness specified. The A08790 and A08794 cylinder guards in bar stock brass are available to accommodate different cylinder lengths and door thicknesses as shown.

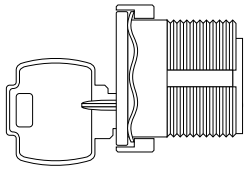

985 cylinder with A08790 cylinder guard.

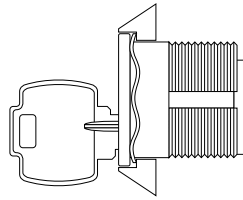

985 cylinder with A08794 cylinder guard.



A08790



A08794

Escutcheon trim ring

Door thickness	Function	985 1 1/8"	986 1 1/4"	(c)987 1 3/8"	(c)988 1 1/2"
1 1/2"	Single cylinder	—	A08790-000	A08790-001	A08790-002
1 1/2"	Double cylinder	A08790-000	—	—	—
1 3/4"	Single cylinder	—	—	A08790-000	A08790-001
1 3/4"	Double cylinder	—	A08790-000	A08790-001	A08790-002
2"	Single cylinder	—	—	A08790-000	A08790-001
2"	Double cylinder	—	—	A08790-000	A08790-001
2 1/4"	Single cylinder	—	—	—	A08790-000
2 1/4"	Double cylinder	—	—	—	—
2 1/2"	Single cylinder	—	—	—	—
2 1/2"	Double cylinder	—	—	—	—

Sectional trim ring

Door thickness	Function	985 1 1/8"	986 1 1/4"	(c)987 1 3/8"	(c)988 1 1/2"
1 1/2"	Single cylinder	A08794-001	A08794-002	—	—
1 1/2"	Double cylinder	A08794-002	A08794-003	—	—
1 3/4"	Single cylinder	A08794-000	A08794-001	A08794-002	—
1 3/4"	Double cylinder	A08794-001	A08794-002	A08794-003	—
2"	Single cylinder	—	A08794-000	A08794-001	A08794-002
2"	Double cylinder	A08794-000	A08794-001	A08794-002	A08794-003
2 1/4"	Single cylinder	—	—	A08794-000	A08794-001
2 1/4"	Double cylinder	—	A08794-000	A08794-001	A08794-002
2 1/2"	Single cylinder	—	—	—	A08794-000
2 1/2"	Double cylinder	—	—	A08794-000	A08794-001

Specify part number and finish when ordering. (e.g. A08790-000-626)

**Single cylinder functions

Blocking ring and cylinder guards

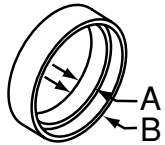

Straight Protective Collar
used on escutcheon trim

Dimensions and part numbers

Dim. A	Dim. B	Part No.
$\frac{3}{32}$ "	$\frac{9}{32}$ "	A08790-000
$\frac{7}{32}$ "	$\frac{13}{32}$ "	A08790-001
$\frac{11}{32}$ "	$\frac{17}{32}$ "	A08790-002
$\frac{15}{32}$ "	$\frac{21}{32}$ "	A08790-003
$\frac{43}{64}$ "	$\frac{55}{64}$ "	A08790-004

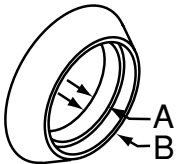

Tapered Protective Collar
used on sectional trim

Dim. A	Dim. B	Part No.
$\frac{3}{32}$ "	$\frac{9}{32}$ "	A08794-000
$\frac{7}{32}$ "	$\frac{13}{32}$ "	A08794-001
$\frac{11}{32}$ "	$\frac{17}{32}$ "	A08794-002
$\frac{15}{32}$ "	$\frac{21}{32}$ "	A08794-003

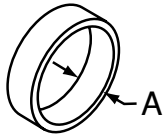

Blocking Ring

Dim. A	Dim. B	Part No.
$\frac{1}{8}$ "	—	008876-000
$\frac{3}{16}$ "	—	008876-005
$\frac{1}{4}$ "	—	008876-001
$\frac{3}{8}$ "	—	008876-002
$\frac{1}{2}$ "	—	008876-003
$\frac{5}{8}$ "	—	008876-004

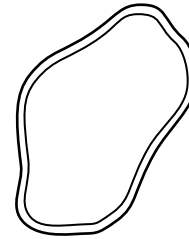

Wave washer included.

To order separately, specify
008789-001-60

Trim packages

Both knob and lever trim packages are available to allow complete replacement of inner and outer trim on any lock function. Packages include inside and outside trim, spindle and mounting screws. Please see current price book for more details.

Trim options



Abrasive coated knobs and levers

All knobs and levers are available with abrasive coating to identify entrances to hazardous areas to the handicapped.

Knurled levers

Levers are available knurled to identify entrances to hazardous areas to the handicapped.

Lead wrapping

MA Series locksets and latchsets are available with lead-wrapping for use on X-ray room doors (or similar situations).

Strikes

Manufactured from heavy gauge brass or stainless steel. Meets ANSI Standard A115.1 for frame preparation. Strikes are available with various lip lengths.



Thumb turn/threaded cylinders

(sold separately)

Standard thumb turn threaded cylinders for deadbolt operation of MA Series locks may be used in lieu of surface mounted thumb turns. Furnished with A09894-1 cam. Available in length indicated and all MA Series finishes.

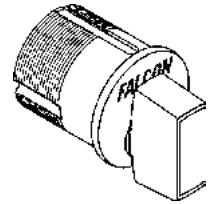

Catalog number	Length
973	1 1/8" RH (turns counter-clockwise)
974	1 1/8" LH (turns clockwise)

Indicators

(Available in Gala Rose & Napa Escutcheon)

Two different variations are available to communicate the status of the door on the outside: Occupied/Vacant or Locked/Unlocked.



Allegion Connect

Cross-category solution using common interconnect components for electrified options.

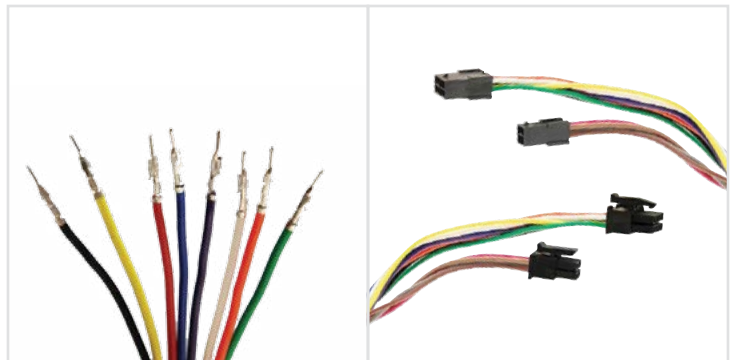

Function cross-reference chart

MA Series Grade 1 mortise locks

ANSI no.	Function	Falcon	Arrow	Stanley Commercial	Corbin/Ruswin	Dorma	Hager	Marks	Sargent	Yale
F 01	MA101	Passage or closet latch	A-B01	QMS/ QME 130	ML2010	9010	3810S/ 3810E	5-55N	8215	8801
F 02	MA301	Privacy, bedroom/bath	-	-	ML2020	-	3840S/ 3840E	5-55L	8268	-
F 04	MA521	Entry lock	A-B22	QMS/ QME 150	ML2051	9050	3853S	5-55E	8205	8807
F 05	MA561	Classroom lock	A-B17	QMS/ QME 160	ML2055	9070	3870S/ 3870S	5-55J	8237	8808
F 06	MA551	Holdback lock	-	-	ML2056	9076	-	5-55JM/JR	8289	8824
F 07	MA581	Storeroom/closet lock	A-B12	QMS/ QME 170	ML2057	9080	3880S/ 3880E	5-55EW	8204	8805
F 08/F 10	MA621	Front door/apartment corridor	A-B21	-	ML2048	-	3861S/ 3861S	5-55A	8247	-
F 09	MA381	Apartment, exit	A-B32	QMS/ QME164	ML2042	9060	-	5-55G	8216	8817-2
F12/F 20	MA531	Apartment corridor door lock	A-B11	QMS/ QME 154	ML2067	9953	3856S/ 3856E	5-55F	8243	8847
F 13	MA571	Dormitory or exit lock	A-B19	QMS/ QME 152	ML2065	9956	-	5-55FW	8225	8822
F 14	MA371	Store door lock	A-B31	QMS/ QME 174	ML2022	9966	-	5-55C	8226	8860-2
F 15	MA451	Hotel guest lock	A-B15/16	-	ML2029	9985	-	5-55H	8250	8820
F 16	MA931	Dead lock	A-B42	-	ML2012	9962	-	-	8222	8814-2
F 17	MA941	Dead lock	A-B41	-	ML2013	9960	-	-	8221	8815
F 18	MA921	Dead lock	A-B40	-	ML2011	9961	-	-	8220	8814
F 19	MA311	Privacy, bedroom/bath	A-B02	QMS/QME 145	ML2030	9940	-	5-55LF	8266	8802
F 21	MA541	Room door lock	A-B13	-	ML2024	9973	3850S	5-55B	8224	8860
F 22	MA321	Privacy, bedroom/bath	A-B26	QMS/QME 140	ML2060	9040	-	5-55LJ	8265	8862
F 29	MA911	Classroom dead lock	-	-	-	9963	-	-	8203	8813ST
F 30	MA411	Asylum or institutional lock	A-B33	QMS/ QME 172	-	9082	3882S/ 3882E	5-55WW	8217	8830-2
F 31	MA161	Exit or communicating lock	-	-	-	9025	-	5-55EX	8213	8828
F 32	MA441	Intruder latch bolt lock	A-B37	QMS/ QME 162	ML2052	9071	3857S/ 3857E	5-55GC	8238	8808-2
F 34	MA431	Intruder dead bolt lock	-	-	-	9967	-	5-55FC	8240	8812-2
NA	MA12	Single dummy	-	QMS/ QME 120	ML2050	-	3817S/ 3817E	5-55DI/ DO	8293	855/ 855FL
NA	MA18	Double dummy	-	QMS/ QME 122	ML2070	-	3827S/ 3827E	5-55DT	8294	836B/ 838FL
NA	MA851	Storeroom-fail safe (EL-12 & 24 VAC or VDC)	A-B181/183	-	ML20903	9080EL	3880EL	5-55EL	8270	8880
NA	MA881	Storeroom-fail secure (EU-12 & 24 VAC or VDC)	A-B177/179	-	ML20905	9080EU	3880EU	5-55EU	8271	8881
NA	MA641	Dormitory lock	-	-	-	-	-	-	-	-

All effort has been made to make this information comprehensive. Since no two products are exactly alike, this data represents those products which are similar. This information was obtained from trade services and is not guaranteed nor meant to represent any product as equal to any other product.

How to order

For correct ordering, and to ensure no delays in shipment of your order, the following descriptive data must be listed in the sequence shown. Necessary information can be found in other parts of this catalog. The example below shows an order for 16 each MA locksets in the 521 Entry function, DG (Dane-Gala) trim design in a 626 (satin chrome) finish, 8 RH (right hand) and 8 LH (left hand) to accommodate doors 1 3/4" thick with AA1-AA16 keying.

- **Quantity:** Indicate the quantity required.
- **Catalog number:** Select catalog number.
- **Trim design:** Indicate letter of knob or lever design followed by letter of rose or escutcheon design.
 - Example: DG-D for Dane lever followed by G for Gala rose.
- **Finish:** When the finish is the same for the outside and inside trim, it is shown once (626). Outside finish always precedes inside finish on split finishes (605 x 625).
- **Latches:** Two-piece mechanical anti-friction standard. All catalog numbers shown in this catalog indicate 2 3/4" backset.
- **Strikes:** 4 7/8" x 1 1/4" x 1 5/16" lip-to-center with curved lip standard. Optional strikes with shorter or longer lip lengths available.
- **Cylinder type:** For 6-pin, add 6-pin. For 7-pin, add 7-pin.
- **Door hand:** See chart.
- **Keying detail:** We suggest using the standard terms developed by the A.H.C. (consult factory).
 - Example: AA1 - Grand Master keyed, Master keyed, change key 1.
- **Interchangeable core:** To order product capable of accepting an interchangeable core, add "B" less SFIC (for interchangeable core). To order product with an interchangeable core, add "SFIC" (with interchangeable core).
 - Example: "G" with Falcon SFIC core.
- **Keyways:** "G" is standard on regular cylinders, "A" is standard on interchangeable cores. Other keyways available. See price book.
- **Additional keys:** Note the total number of keys required.
- **Large bow keys:** Add—"with large bow keys".

How to order example

Qty.	Catalog number	Trim design	Finish	Latch	Strike	Cylinder	Door hand				Detail
							RH	LH	RHR	LHR	
8	MA521P	DG	626	Std	Std	6-pin	X				AA1-AA8 1 3/4" DR
8	MA521P	DG	626	Std	Std	6-pin		X			AA9-AA16 1 3/4" DR

RU Series

Extra heavy-duty preassembled unit locks

When you need to replace an existing notched-style lock and get up to code on ADA accessibility, the Falcon RU Series is a perfect fit. Designed specifically for retrofitting older and historical buildings, this unique lock combines old-fashioned styling with modern strength, security and convenience. Falcon RU Series locks have an interchangeable core that can be removed for quick, easy re-keying. Our interchangeable cores are compatible with SFIC products from other manufacturers, and they're backed by one of the best names in the business.

Features



Large square trim to hide any imperfections in the door

Trim is solid brass

PressureRelease™ outside lever disengages when locked to protect internal mechanisms

Retrofit locks

The RU Series from Falcon is designed to retrofit existing unit locks manufactured by Falcon, Corbin Russwin and Yale. It exceeds ANSI Grade 1 specifications and is UL/ULC listed. The RU Series incorporates Falcon's vandal resistant PressureRelease™ trim to prevent damage to internal mechanism, and it installs with minimal rework to existing doors while preserving the door and frame for cost effective project planning. Falcon's RU Series satisfies all ADA easy access requirements.

Features

- Vandal resistant PressureRelease™ outside lever disengages when locked to prevent damage to internal mechanism
- 2 lever designs
- Complements Falcon's "family" of lever designs
- "Power Spring™" in rose trim prevents lever sag
- 12 commercial lock functions
- 2 standard finishes: 613 and 626
- No exposed mounting screws
- Solid bar stock deadlocking feature prevents latch binding and lock failure due to poor door alignment
- Exceeds 1,000,000 cycle ANSI Grade 1 requirement
- Meets or exceeds all other ANSI A156.2 rigorous Grade 1 specifications for key-in-lever products

Benefits

- Preserves existing facility doors and frames
- Preserves original architectural design without adapter plate or add-ons
- Easy installation with minimal door modifications
- Features a 4" square rose which covers existing mounting holes, most paint lines and required door rework
- Complies with ADA easy access requirements
- UL/ULC listed for 3 Hour A Label doors
- Strikes available to match existing frame preparation
- Reuse existing facility cylinders and key system
- Non-handed chassis and field reversible trim and latch bolt for easy stocking and lower inventory cost
- Key removable outside lever for easy cylinder replacement
- Outside lever secured by a spring-loaded retainer. Retainer cannot be depressed when locks have been locked. Inside lever secured by a set screw. Levers have heavy-duty steel individual return springs in order to prevent lever sag

Specifications

Retrofit locksets shall be Falcon lock RU Series or equal and meet the following requirements:

- Exceeds ANSI A156.2 Grade 1 key-in-lever specifications
- Available with Falcon standard or interchangeable core cylinders in 6 and 7-pin configuration
- Interchangeable core levers are non-removable with core installed
- Available with some 6-pin competitor's keyways
- Accepts interchangeable (removable) cores and standard 6-pin cylinders from the following manufacturers: Arrow, Assa, Best, Corbin Russwin (except Master-Ring), Medeco, Sargent, Schlage and Yale
- PressureRelease™ (clutchable) outside lever
- Heavy duty, solid levers are 5" long and have no inserts
- No exposed mounting screws
- Installs with 10-32 through-bolt screws with thread sealant for extra security and resistance to vibrating loose
- Standard lock is for 1 3/4" thick doors. Also available for 2" and 2 1/4" thick doors
- 2 3/4" backset only
- ANSI strike standard
- Optional OEM strikes available

Lever styles

Levers are solid pressure cast zinc, finished to match mating parts. Roses are wrought brass or bronze, and are installed over pressure cast through-bolted rose inserts. Levers are secured by a spring-loaded retainer. Retainer cannot be depressed when locks have been locked.

Dane (D)



Quantum (Q)















Trim finishes chart

Description	ANSI No.	Available on
Oil rubbed bronze	613	All trim
Satin chrome	626	All trim

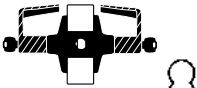
Functions

To order Falcon lock RU Series locksets, please consult page 32 for ordering information and assistance.

 Indicates interchangeable core available.

Catalog number	Function	Name	Description
RU101		Passage/closet set	Latch bolt by levers at all times.
RU301		Privacy lock	Latch bolt by levers. Outside lever locked by push button in inside lever. Rotating inside lever or closing door releases push button. Emergency release in outside lever unlocks door.
RU381		Apartment exit lock	Deadlocking latch bolt by levers except when outside lever is locked by key inside, then by key outside. Inside lever is always locked.
RU411		Asylum lock	Deadlocking latch bolt by key from either side at all times. Both levers inoperable.
RU501		Entry lock	Push button locking. Button on inside locks outside lever until unlocked by key or by rotating inside lever. Inside lever always free. Deadlocking latch bolt.
RU511		Entry/office lock	Turn/push button locking. Pushing and turning button locks outside lever requiring use of key until button is manually unlocked. Push button locking. Pushing button locks outside lever until unlocked by key or by rotating inside lever. Inside lever always free. Deadlocking latch bolt.
RU521		Office lock	Turn button locking. Turning button locks outside lever requiring use of key until button is manually unlocked. Inside lever always free. Deadlocking latch bolt.
RU561		Classroom lock	Deadlocking latch bolt by levers. Outside lever is locked by key in outside lever. Inside lever is always free.
RU571		Dormitory lock	Deadlocking latch bolt by levers except when locked by push button in inside lever. Key in outside lever locks or unlocks lever and releases button. Closing door releases push button. Inside lever always free.
RU581		Storeroom lock	Deadlocking latch bolt by lever inside or key outside. Outside lever is inoperable. Inside lever always free.
RU851		Storeroom (electrified-fail safe)	Latch bolt operated by lever from either side except when outer lever is electrically locked. When outer lever is locked (inoperable), latch bolt retracted by key in cylinder outside dead locking latch bolt. 24V/DC .185AMPS.
RU881		Storeroom (electrified-fail secure)	Deadlocking latch bolt operated by lever inside at all times. Outside lever inoperable until electrically unlocked, then latch bolt from either side. When outside lever is inoperable, latch bolt retracted by key in cylinder outside.

Standard cylinders

The Falcon RU Series accepts the following manufacturers' 6-pin cylinders:



Standard 6-pin cylinders*

- Falcon
- Corbin Russwin
- Medeco
- Sargent
- Yale - Monolock - unit lock
- Arrow
- Peaks
- Schlage
- Assa
- Lori
- Primus (Schlage)
- Yale

* Locks must be modified for some cylinders. Be sure to specify manufacturer when ordering.

Standard cylinders

Catalog number	Description	Function
A23151-05	5-Pin assembly	All except 381 inside cylinder, 571
A23151-06	5-Pin assembly	All except 381 inside cylinder, 571
A23151-07	5-Pin assembly	All except 381 inside cylinder, 571
A23161-05	6-Pin assembly	All except 381 inside cylinder
A23161-06	6-Pin assembly	All except 381 inside cylinder
A23161-07	6-Pin assembly	All except 381 inside cylinder
A23171-05	7-Pin assembly	571
A23171-06	7-Pin assembly	571
A23171-07	7-Pin assembly	571

Note: Specify finish: 606 or 626. Specify keyway: "E", "G" (standard), "H", "K", "L", "N", "P".

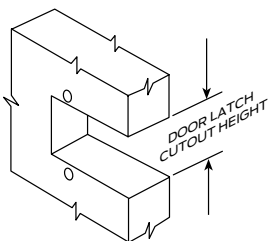

Latch heights currently identified and the manufacturer.

1. 1 3/4" Corbin, Russwin, Yale
2. 2 1/16" Corbin, Falcon
3. 2 5/8" Corbin, Sargent
4. 2 11/16" Russwin (Earliest)

Interchangeable cores

The Falcon RU Series accepts the following manufacturers' interchangeable cores:

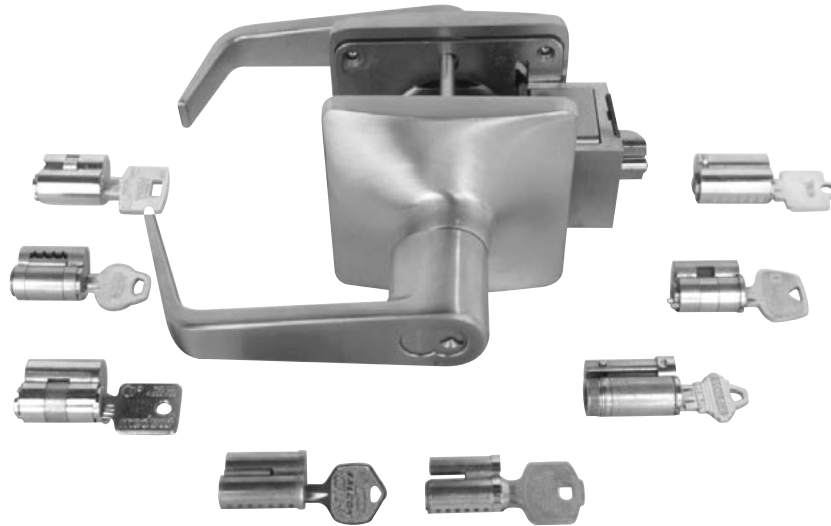

Interchangeable cores*

- Falcon
- Best
- Peaks (Kaba)
- Schlage
- Arrow
- Corbin Russwin
- Primus (Schlage)
- Yale - 32 Series
- Assa
- Sargent
- Medeco

* Locks must be modified for some cylinders. Be sure to specify manufacturer when ordering.

Interchangeable cores

Catalog number	Description
C606	For use in all RU Series I/C keyed locks – 6-pin (cover style)
C607	For use in all RU Series I/C keyed locks – 7-pin (cover style)
CB806	For use in all RU Series I/C keyed locks – 6-pin (cap style)
CB807	For use in all RU Series I/C keyed locks – 7-pin (cap style)

Note: Specify finish: 606 or 626. Specify keyway: "A" (standard or other keyway)

Competitor keyways

Standard cylinders with competitor keyways - 6-pin

Catalog number	Description	Function
A23170-000	Arrow 'O' bitted	All except 381 IS, 571
A23170-0KA	Arrow 'KA' keyed alike 4	All except 381 IS, 571
A23170-0KD	Arrow 'KD' keyed different	All except 381 IS, 571
A23167-000	Corbin 60 'O' bitted	All except 381 IS, 571
A23167-0KD	Corbin 60 'KD' keyed different	All except 381 IS, 571
A23174-000	Corbin Russwin L4 'O' bitted	All except 381 IS, 571
A23168-000	Russwin D1 'O' bitted	All except 381 IS, 571
A23168-0KD	Russwin D1 'KD' keyed different	All except 381 IS, 571
A23166-000	Sargent LA 'O' bitted	All except 381 IS, 571
A23166-0KD	Sargent LA 'KD' keyed different	All except 381 IS, 571
A23160-000	Schlage C 'O' bitted	All except 381 IS, 571
A23160-0KA	Schlage C 'KA' keyed alike 4	All except 381 IS, 571
A23160-0KD	Schlage C 'KD' keyed different	All except 381 IS, 571
A23159-000	Schlage E 'O' bitted	All except 381 IS, 571
A23169-000	Yale 8 (Para) 'O' bitted	All except 381 IS, 571
A23169-0KD	Yale 8 (Para) 'KD' keyed different	All except 381 IS, 571
A23158-000	Yale GA 'O' bitted	All except 381 IS, 571
A23170-011	Arrow 'O' bitted	381 Inside cylinder
A23170-11A	Arrow 'KA' keyed alike 4	381 Inside cylinder
A23170-11D	Arrow 'KD' keyed different	381 Inside cylinder
A23167-011	Corbin 60 'O' bitted	381 Inside cylinder
A23167-11D	Corbin 60 'KD' keyed different	381 Inside cylinder
A23174-011	Corbin Russwin L4 'O' bitted	381 Inside cylinder
A23168-011	Russwin D1 'O' bitted	381 Inside cylinder
A23168-11D	Russwin D1 'KD' keyed different	381 Inside cylinder
A23166-011	Sargent LA 'O' bitted	381 Inside cylinder

Catalog number	Description	Function
A23166-11D	Sargent LA 'KD' keyed different	381 Inside cylinder
A23160-011	Schlage C 'O' bitted	381 Inside cylinder
A23160-11A	Schlage C 'KA' keyed alike 4	381 Inside cylinder
A23160-11D	Schlage C 'KD' keyed different	381 Inside cylinder
A23159-011	Schlage E 'O' bitted	381 Inside cylinder
A23169-011	Yale 8 (Para) 'O' bitted	381 Inside cylinder
A23169-11D	Yale 8 (Para) 'KD' keyed different	381 Inside cylinder
A23158-011	Yale GA 'O' bitted	381 Inside cylinder
A23170-012	Arrow 'O' bitted	571
A23170-12A	Arrow 'KA' keyed alike 4	571
A23170-12D	Arrow 'KD' keyed different	571
A23167-012	Corbin 60 'O' bitted	571
A23167-12D	Corbin 60 'KD' keyed different	571
A23174-012	Corbin Russwin L4 'O' bitted	571
A23168-012	Russwin D1 'O' bitted	571
A23168-12D	Russwin D1 'KD' keyed different	571
A23166-012	Sargent LA 'O' bitted	571
A23166-12D	Sargent LA 'KD' keyed different	571
A23160-012	Schlage C 'O' bitted	571
A23160-12A	Schlage C 'KA' keyed alike 4	571
A23160-12D	Schlage C 'KD' keyed different	571
A23159-012	Schlage E 'O' bitted	571
A23169-012	Yale 8 (Para) 'O' bitted	571
A23169-12D	Yale 8 (Para) 'KD' keyed different	571
A23158-012	Yale GA 'O' bitted	571

Latches

1/2" projection, standard, UL listed

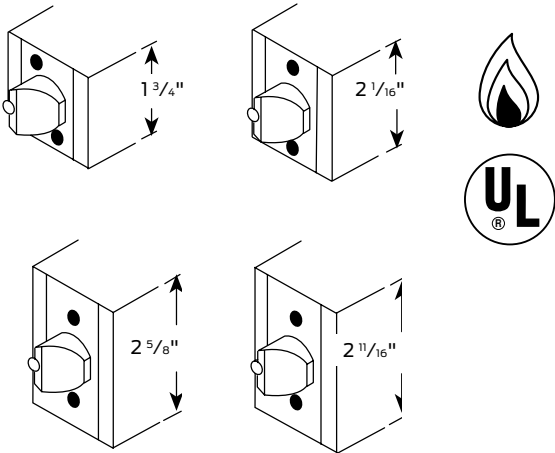

Catalog number	Description	Latch height
A31469-001	2 3/4" backset spring	1 3/4"
A31469-002	2 3/4" backset spring	2 1/16"
A31469-003	2 3/4" backset spring	2 5/8"
A31469-004	2 3/4" backset spring	2 11/16"
A31469-01D	2 3/4" backset deadlocking	1 3/4"
A31469-02D	2 3/4" backset deadlocking	2 1/16"
A31469-03D	2 3/4" backset deadlocking	2 5/8"
A31469-04D	2 3/4" backset deadlocking	2 11/16"

Latches for RU Series locks are 2 3/4" backset for 1 3/4" thick door.
Specify finish: 605, 606, 612, 613, 625, 626.

3/4" projection, optional, UL listed

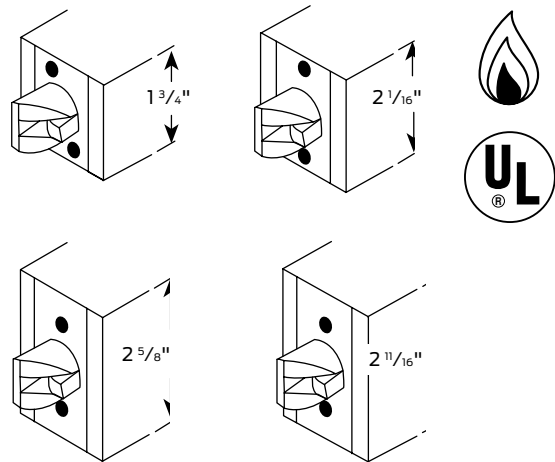

Latches for RU Series locks are 2 3/4" backset, 1 3/4" thick door.
Specify finish: 605, 606, 612, 613, 625, 626.

Strikes and dust boxes

Strikes

Furnished with a 4 7/8" ANSI Strike unless otherwise specified.

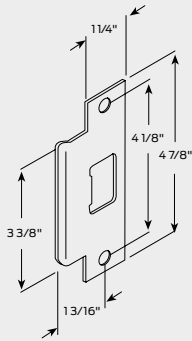

005164-000*
ANSI Prep A115.2

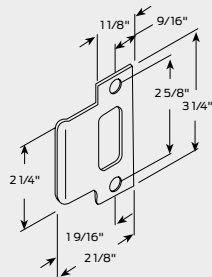

031471-000*
Early Corbin Russwin
single door

Note: Strike, door and
lock same center line

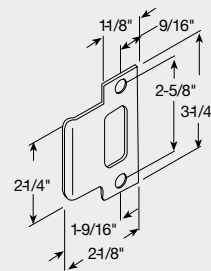

031471-001*
Early Corbin Russwin
single door

Note: Strike center line
is not the same as door
and lock

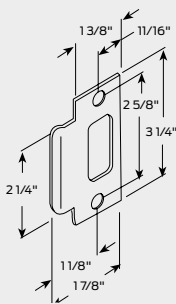

031472-000*
Early Corbin
Russwin pair
of doors

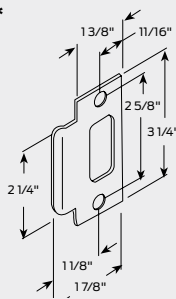

031473-000*
Yale mono pair
of doors

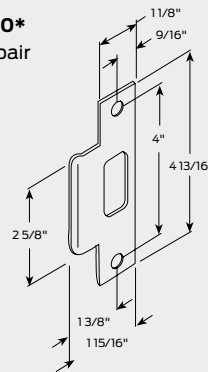

031474-000*
Early Corbin

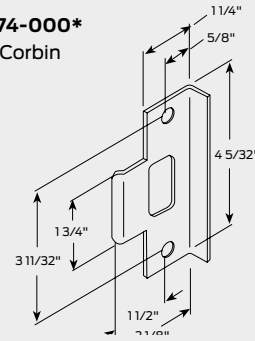

031477-000*
Early Russwin
unit lock

* Specify finish: 605, 606, 612 or 625, 626 or 630

Dust boxes



005099-000-30
1" deep. May be used with any
4 7/8" high (ANSI) strike.

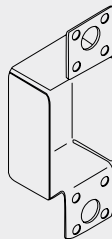

031453-000-30
3/4" deep. May be used
with any 3 1/4" high strike.

Function and trim style cross-reference

RU Series Grade 1 Retrofit unit key-in-lever

ANSI number/grade	Function	Falcon	Corbin/Russwin	Old Corbin unit lock	Old Russwin unit lock	Old Yale mono-lock	Yale mono-lock retrofit	Old Falcon R Series
F75	Passage	RU101	UT5210	310	510	6201	6401	R101
F76	Privacy	RU301	UT5220	320	520	6202	6402	R301
F88	Vestibule	RU381	UT5272	354	546 1/2	6217	6417	R381
F87	Asylum	RU411	—	—	—	6230	—	R411
F82	Entry	RU501	UT5261	361	546	6204	6404	R501
F109	Entry/office	RU511	—	—	—	6207	6407	—
F81	Entry/office	RU521	UT5251	351	540	—	—	R521
F84	Classroom	RU561	UT5255	355	540 5/8	6208	6408	R561
F90	Dormitory	RU571	—	—	—	6222	6422	R571
F86	Storeroom	RU581	UT5257	357	552	6205	6405	R581
	(Electrified storeroom fail-safe)	RU851	—	—	—	—	—	—
	(Electrified storeroom fail-secure)	RU881	—	—	—	—	—	—

Trim styles

Falcon	Corbin/Russwin	Old Corbin unit lock	Old Russwin unit lock	Old Yale mono-lock	Yale mono-lock Retrofit	Old Falcon R Series
Dane	Essex	912LR	Moderalev	Saxon	AU	—
Quantum	—	—	—	—	PB	—

All effort has been made to make this information comprehensive. Since no two products are exactly alike, this data represents those products which are similar. This information was obtained from trade services and is not guaranteed nor meant to represent any product as equal to any other product.

How to order

For correct ordering, and to ensure no delays in shipment of your order, the following descriptive data must be listed in the sequence shown. Necessary information can be found in other parts of this catalog. The example below shows an order for 8 each RU locksets in the 521 Office function, D (Dane) trim design, 626 finish, 1 3/4" latch height, 4 7/8" ANSI strike, less cylinder, prepared for Russwin I/C core with 2 3/4" backset latch, to accommodate doors 1 3/4" thick.

- **Quantity:** Indicate the quantity required.
- **Catalog number:** Select catalog number. All catalog numbers shown in this catalog indicate 2 3/4" backset only. For thicker doors consult factory.
- **Trim design:** Indicate letter of lever design.
 - Example: D=Dane; Q=Quantum.
- **Finish:** When the finish is the same for the outside and inside trim, it is shown once (626). For split finishes, the outside is designated first, then the inside (605 x 625).
- **Latches:** 2 3/4" backset only.
- **Strikes:** 4 7/8" X 1 1/4" ANSI standard. Optional retrofit strikes available: 3/4", 4 3/16" and 4 5/32". See page 30 for more details.
- **Cylinder type:** Locks are furnished with Falcon's standard cylinder unless otherwise specified. See page 26 for details. When ordered "less cylinder" it is necessary to indicate which competitor's standard cylinder or I/C core the lockset must be prepared for.
 - Example: Less cylinder - Prepared for Russwin I/C core and whether the cylinder is 6 or 7 pin.
- **Door hand:** Specify hand RH/LH or RHR/LHR so latch may be assembled to outer trim properly. Field reversible.
- **Keying detail:** We suggest using the standard terms developed by the Door & Hardware Institute.
 - Example: AA1 - Grand master keyed, master keyed, change key 1.
- **Keyways:** "G" is standard on regular cylinders, "A" is standard on interchangeable cores. Other keyways available. See page 28.

How to order example

Qty.	Catalog number	Trim design	Finish	Latch height*	Strike	Handing	Cylinder	Other requirements
8	RU521	D	626	1 3/4"	Std	RHR	Less cylinder	Prepare for Russwin I/C core



T Series

Grade 1, extra heavy-duty
cylindrical lever locks

Simply put, the Falcon T Series lock is the most versatile lockset in the industry. This extra heavy duty lock can accept any manufacturer's cylinder, and the cylinder can easily be removed for quick re-keying. Redesigned with a compression spring behind the cylinder, the T Series is now stronger than ever and lever sag has been virtually eliminated. This adaptable lock is well suited for either new construction or retrofit use in buildings as varied as multi-family, retail, institutional and government/military.

Features

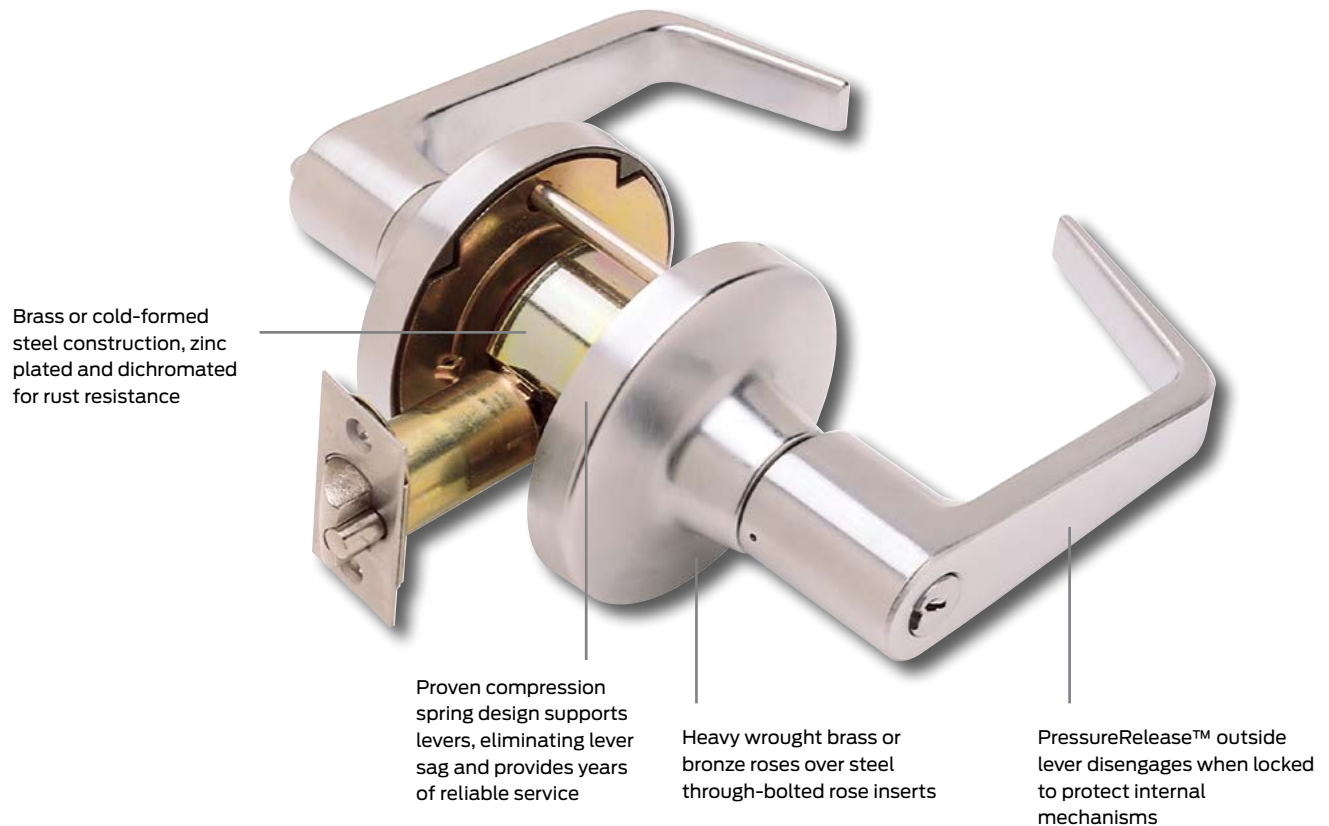

T Series

Features

Door thickness: 1 3/4" to 2 1/8" standard. Thin door adapter kit (A30775-000-00) available for doors thinner than 1 3/4", please specify door thickness.

Backset: 2 3/4" standard. 2 3/8" also available. Link (A22161-005-10) available for 5" backset.

Mechanism: Parts constructed of brass or cold formed steel, zinc plated and dichromated for rust resistance. Springs are stainless steel. compression spring design supports levers, eliminating lever sag and provides years of reliable service.

Attachment: Lock chassis secured to door by threaded mounting nuts. Completely preassembled outer trim and inner spindle assembly are through-bolted over chassis using (2) 10-32 screws. Adding rose and lever to inner spindle assembly completes installation.

Handing: Locks are non-handed.

Cylinders: Drilled with 6-pin chambers, pinned in 5. Pinning in 6 chambers available when specified, at no cost. 7-pin cylinders also available. Cylinder assemblies removable to rekey. Also available with 6 or 7-pin interchangeable core cylinders. Cylinder housings and plugs machined from solid brass. Springs are phosphor bronze. Two nickel silver keys furnished standard. Interchangeable core design is available for small format (SFIC) and large format for most manufacturers, see page 38.

Keywords: "G" keyway standard on conventional cylinders. "A" keyway standard on I/C core cylinders. Also available with some optional keyways.

Trim: Roses are heavy wrought brass or bronze, installed over pressure cast rose inserts which are through-bolted through door. Levers are pressure cast (solid levers—no inserts) material finished to match mating parts.

Latches: 9/16" bolt projection, UL listed with latch faceplates 2 1/4" x 1 1/8" with square corners standard. 3/4" projection, UL listed latch with 2 3/4" backset also available. Adjustable front standard. See page 40 for optional latches.

Strikes: 4 7/8" x 1 1/4" ANSI strike with curved lip to meet ANSI A115.2 door frame preparation standard. Consult page 41 for other available strike sizes and configurations.

Screws: Furnished with combination screws for use in wood or metal doors and frames.

Electrified functions: Available in 24 VDC .185 AMP.

ANSI/BHMA: Meets ANSI/BHMA A156.2, Series 4000, Grade 1.

UL: 3 hour A label.

Specifications

Key-in-lever cylindrical locksets shall be Falcon lock T Series or equal and meet the following requirements:

- All locks shall meet the new ANSI/BHMA A156.2, Series 4000, Grade 1 for key-in-lever locksets.
- Locksets shall be UL Listed (3 hour A Label).
- Locksets shall be provided standard with Pressure Release™ feature. When outside lever is locked, it is not rigid but will move freely without operating the latch bolt.
- Lever trim shall have individual heavy-duty compression springs behind rose for lever return and to prevent lever sag. Trim shall be through-bolted with two (2) 10-32 screws coated with thread sealant to provide strength and resistance to loosening. Inner and outer trim shall "bottom out" to prevent door collapse. Roses shall be minimum of 3 1/2" diameter.
- All lever designs shall be solid and meet the federal ADA and state disability requirements. Inside levers shall be attached by Allen-head set screw to prevent tampering or vandalism.
- Locksets shall adjust to fit door thickness from 1 3/4" to 2 1/8".
- All locksets shall be non-handed and not require field disassembly for re-handing.
- Preparation for door must be non-handed. Acceptable manufacturer: Falcon lock

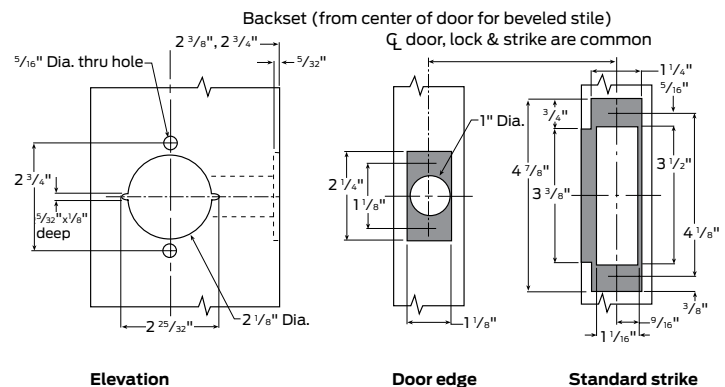

Lever styles

Levers are solid pressure cast zinc, finished to match mating parts. Roses are wrought brass or bronze installed over steel throughbolted rose inserts. Pressure Release™ levers are standard. Levers are secured by a spring-loaded retainer. Retainer cannot be depressed when locks have been locked.

Avalon (A)

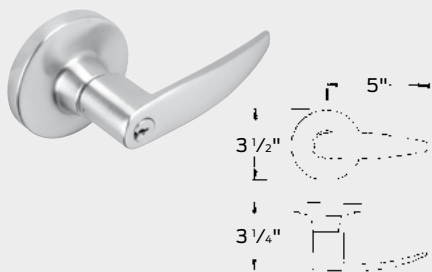

Dane (D)

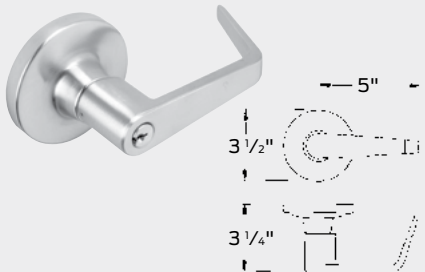

Quantum (Q)



Boardwalk (BRK)*

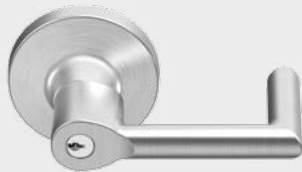

Broadway (BRW)*



Latitude (LAT)*



Longitude (LON)*



* Available in Q1 2017

Abrasive coated levers

Avalon, Dane, and Quantum levers are available with abrasive coating along the length of the lever to identify entrances to hazardous areas to the handicapped. To order add: "with abrasive coated outer lever" in detail section of order.











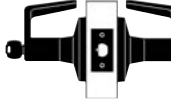

Trim finishes chart

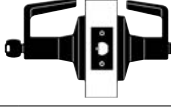
Description	ANSI No.	Available on
Bright brass	605	All trim
Satin brass	606	All trim
Oil rubbed bronze	613	All trim
Satin nickel	619	All trim
Matte black	622	All trim
Bright chrome	625	All trim
Satin chrome	626	All trim
Aged bronze	643e	All trim

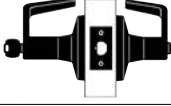
Functions

To order Falcon T Series locksets, please consult page 43 for ordering information and assistance.

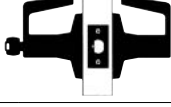
 Indicates interchangeable core available.

Catalog number	Function	Name	Description	ANSI no.
T101		Passage/closet set	Latch bolt by levers at all times.	F75
T301		Privacy lock	Latch bolt by levers. Outside lever locked by push button in inside lever. Rotating inside lever or closing door releases push button. Emergency release in outside lever unlocks door.	F76
T351		Closet lock	Deadlocking latch bolt by turn knob inside or lever outside except when outside lever is locked by key.	
T381		Classroom security lock	Deadlocking latch bolt by levers from either side except when outside lever is locked by key from inside. Outside key only retracts latch. Outside lever is locked and unlocked only by inside key.	F88
T411		Asylum lock	Deadlocking latch bolt operated by key in lever from either side. Both levers always inoperable.	F87
T501		Entry lock	Push button locking. Button on inside locks outside lever until unlocked by key or by rotating inside lever. Inside lever always free. Deadlocking latch bolt.	F82
T511		Entry/office lock	Turn/push button locking. Pushing and turning button locks outside lever requiring use of key until button is manually unlocked. Push button locking. Pushing button locks outside lever until unlocked by key or by rotating inside lever. Inside lever always free. Deadlocking latch bolt.	F109
T521		Office lock	Turn button locking. Turning button locks outside lever requiring use of key until button is manually unlocked. Inside lever always free. Deadlocking latch bolt.	F81
T561		Classroom lock	Deadlocking latch bolt by levers. Outside lever is locked by key in outside lever. Inside lever is always free.	F84
T571		Dormitory lock	Deadlocking latch bolt by levers except when locked by push button in inside lever. Key in outside lever locks or unlocks outside lever and releases button. Closing door releases push button. Inside lever always free.	F90
T581		Storeroom lock	Deadlocking latch bolt by lever inside or key outside. Outside lever is inoperable. Inside lever always free.	F86
T851		Storeroom (electrified-fail safe)	Inside Lever Always Free. Latch bolt operated by lever from either side except when outer lever is electrically locked. When outer lever is locked (inoperable), latch bolt retracted by key in cylinder outside. 24 volt DC .185 Amps, continuous duty.	
T881		Storeroom (electrified - fail secure)	Inside lever always free. Deadlocking latch bolt operated by lever inside at all times. Outside lever inoperable until electrically unlocked, then latch bolt from either side. When outside lever is inoperable latch bolt retracted by key in cylinder outside. 24 volt DC .185 Amps, continuous duty.	
T12		Dummy trim	Single trim-surface mounted rigid lever.	

Cylinders

The Falcon T Series accepts the following competitors standard 6-pin cylinders and Interchangeable cores:

Standard 6-pin cylinders*

- Arrow
- Assa
- Corbin Russwin
- Lori
- Medeco
- Primus (Schlage)
- Sargent
- Schlage
- Yale

I/C removable cores*

- Arrow
- Best
- Corbin Russwin
- Medeco Keymark
- Medeco 32 Series
- Peaks (Kaba)
- Primus (Schlage)
- Sargent
- Schlage
- Yale

*Locks must be modified for some cylinders.
Be sure to specify manufacturer when ordering.

Falcon standard cylinders

Catalog number

5-Pin cylinder	6-Pin cylinder	7-Pin cylinder	Function
A23151-05	A23161-05	A23171-05	All except 381 I/S, 571
A23151-06	A23161-06	A23171-06	381 Inside cylinder
A23151-07	A23161-07	A23171-07	571

Note: Specify finish: 606 or 626. Specify keyway: "E", "G" (standard), "H", "K", "L", "N", "P".

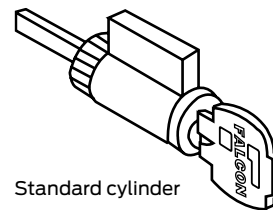

Standard cylinder

Falcon interchangeable cores

Catalog number Description

C606	For use in all T Series I/C keyed locks – 6-pin (cover style)
C607	For use in all T Series I/C keyed locks – 7-pin (cover style)
CB806	For use in all T Series I/C keyed locks – 6-pin (cap style)
CB807	For use in all T Series I/C keyed locks – 7-pin (cap style)

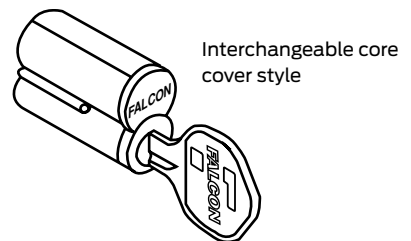

Interchangeable core cover style

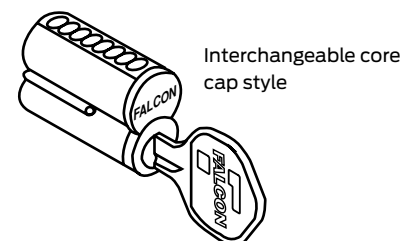

Interchangeable core cap style

Note: Construction keying available. Reference page 101 for more information.

Competitor keyways

Standard cylinders with competitor keyways - 6

Catalog number	Description	Function
A23167-000	Corbin 60 'O' bitted	all except 381 IS, 571
A23167-OKD	Corbin 60 'KD' keyed different	all except 381 IS, 571
A23168-000	Russwin D1'O' bitted	all except 381 IS, 571
A23168-OKD	Russwin D1 'KD' keyed different	all except 381 IS, 571
A23174-000	Corbin/Russwin L4 'O' bitted	all except 381 IS, 571
A23166-000	Sargent LA 'O' bitted	all except 381 IS, 571
A23166-OKD	Sargent LA 'KD' keyed different	all except 381 IS, 571
A23160-000	Schlage C 'O' bitted	all except 381 IS, 571
A23160-OKA	Schlage C 'KA' keyed alike 4	all except 381 IS, 571
A23160-OKD	Schlage C 'KD' keyed different	all except 381 IS, 571
A23159-000	Schlage E 'O' bitted	all except 381 IS, 571
A23169-000	Yale 8 (PARA) 'O' bitted	all except 381 IS, 571
A23169-OKD	Yale 8 (PARA) 'KD' keyed different	all except 381 IS, 571
A23167-011	Corbin 60 'O' bitted	381 inside
A23167-11D	Corbin 60 'KD' keyed different	381 inside
A23168-011	Russwin D1'O' bitted	381 inside
A23168-11D	Russwin D1 'KD' keyed different	381 inside
A23174-011	Corbin/Russwin L4 'O' bitted	381 inside
A23166-011	Sargent LA 'O' bitted	381 inside
A23166-11D	Sargent LA 'KD' keyed different	381 inside
A23160-011	Schlage C 'O' bitted	381 inside
A23160-11A	Schlage C 'KA' keyed alike 4	381 inside
A23160-11D	Schlage C 'KD' keyed different	381 inside
A23159-011	Schlage E 'O' bitted	381 inside
A23169-011	Yale 8 (PARA) 'O' bitted	381 inside
A23169-11D	Yale 8 (PARA) 'KD' keyed different	381 inside
A23167-012	Corbin 60 'O' bitted	571
A23167-12D	Corbin 60 'KD' keyed different	571
A23168-012	Russwin D1'O' bitted	571
A23168-12D	Russwin D1 'KD' keyed different	571
A23174-012	Corbin/Russwin L4 'O' bitted	571
A23166-012	Sargent LA 'O' bitted	571
A23166-12D	Sargent LA 'KD' keyed different	571
A23160-012	Schlage C 'O' bitted	571
A23160-12A	Schlage C 'KA' keyed alike 4	571
A23160-12D	Schlage C 'KD' keyed different	571
A23159-012	Schlage E 'O' bitted	571
A23169-012	Yale 8 (PARA) 'O' bitted	571
A23169-12D	Yale 8 (PARA) 'KD' keyed different	571

Latches

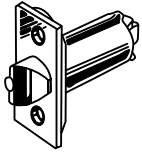

Square corner
9/16"

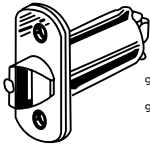

9/16" Radius corner
9/16" Projection



3 Hour



Grade 1, UL listed

Catalog number	Description	Faceplate size	Corner	Projection
A98535-000	2 3/4" Backset spring	2 1/4" x 1 1/8"	Square	9/16"
A98535-00D	2 3/4" Backset deadlocking	2 1/4" x 1 1/8"	Square	9/16"
A98538-000	2 3/4" Backset spring	2 1/4" x 1 1/8"	Radius 9/16"	9/16"
A98538-00D	2 3/4" Backset deadlocking	2 1/4" x 1 1/8"	Radius 9/16"	9/16"

Note: Specify finish 606, 612, 613, 630

Latches for T Series locks are UL Listed. 2 3/4" backset standard.

1" width latch face minimum. Unless otherwise specified, we furnish a 2 1/4" x 1 1/8" x square corner faceplate on 2 3/4" backset latches front standard.

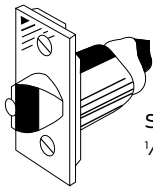

Square corner
1/2" projection

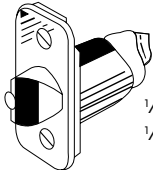

1/4" Radius corner
1/2" projection



3 Hour



Grade 2, UL listed for flat or beveled doors

Catalog number	Description	Faceplate size	Corner	Projection
A92320-000	2 3/8" Backset spring	2 1/4" x 1"	Square	1/2"
A92320-00D	2 3/8" Backset deadlocking	2 1/4" x 1"	Square	1/2"
A92321-000	2 3/8" Backset spring	2 1/4" x 1"	Radius	1/2"
A92321-00D	2 3/8" Backset deadlocking	2 1/4" x 1"	Radius	1/2"
A92330-000	2 3/4" Backset spring	2 1/4" x 1"	Square	1/2"
A92330-00D	2 3/4" Backset deadlocking	2 1/4" x 1"	Square	1/2"
A92331-000	2 3/4" Backset spring	2 1/4" x 1"	Radius	1/2"
A92331-00D	2 3/4" Backset deadlocking	2 1/4" x 1"	Radius	1/2"

Note: Specify finish 606, 612, 613, 630

Latches for T Series locks are UL Listed.

These grade 2 latches have self-adjusting fronts to accommodate beveled or flat front doors. Unless otherwise specified, we furnish a 2 1/4" x 1" x square corner faceplate on these latches.

Strikes, backsets and dustboxes

Strikes

Furnished with a 4 7/8" ANSI Strike unless otherwise specified.

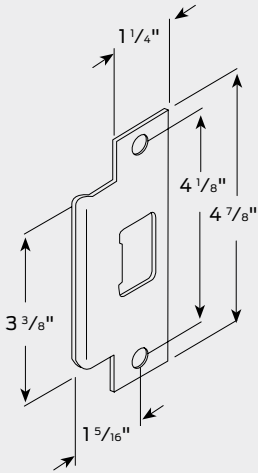

005164-000
ANSI prep A115.2

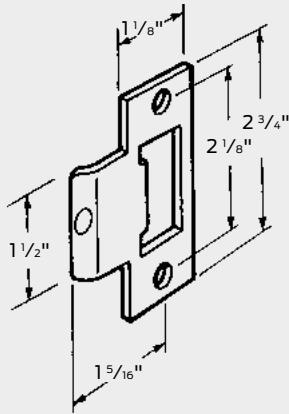

A05185-000
T-strike square corner

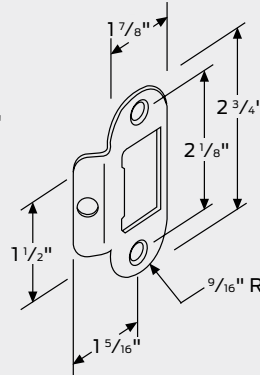

A05185-004
T-strike 9/16" radius

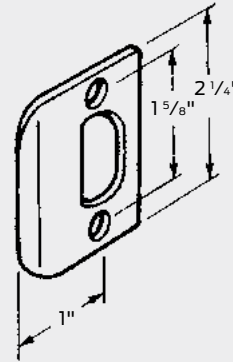

Q001-049
Full lip, square corner

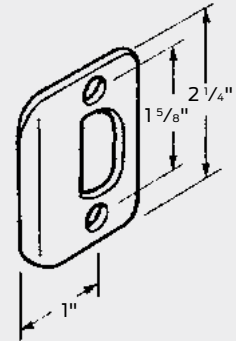

Q001-048
Full lip, 1/4" radius corner

Long backset extension link

A22161-005-00 Link for 5" backset for use with 2 3/4" backset latches (except 3/4" projection).

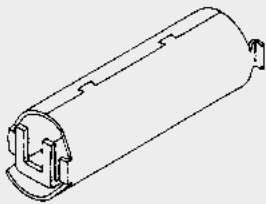

A22161-005-00

Dust boxes



K510-066-PLA (EC 3604)
1" deep. May be used with any 4 7/8" high (ANSI) strike.

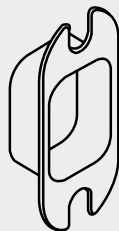

012191-003-70
1/2" deep. May be used with any 2 3/4" high (T) strike.



Q001-059
7/16" deep. May be used with any 2 1/4" (full lip) high strike.

Function and trim style cross-reference

T Series Grade 1 heavy duty cylindrical key-in-lever lock

ANSI no.	Function	Falcon	Arrow	Stanley	Corbin/ Russwin	Hager	Sargent	Yale
F75	Passage	T101	QL01	QCL130	CL3310	3410	10U15	4701LN
F76	Privacy	T301	QL02	QCL140	CL3320	3440	10U65	4702LN
	Closet	T351	-	-	CL3391	-	-	-
F88	Classroom security	T381	-	QCL160/161	CL3372	3495	10G16	-
F87	Asylum	T411	QL33	-	CL3332	-	10G17	4730LN
F82	Entry	T501	-	-	CL3361	-	10G24	4704LN
F109	Dormitory	T511	QL81	QCL150/151	CL3351	3450	-	4707LN
F81	Entry/office	T521	-	-	-	3453	10G05	-
F84	Classroom	T561	QL87	QCL160/161	CL3355	3470	10G37	4708LN
F90	Dormitory	T571	QL89	QCL154/155	-	3473	10G54	4722LN
F86	Storeroom	T581	QL 82	QCL170/171	CL3357	3480	10G04	4705LN
	Storeroom-fail safe	T851	QLE1	QCL192/193	-	3480EL	10G70	-
	Storeroom-fail secure	T881	QLE3	QCL194/195	-	3480EU	10G71	-
	Single dummy	T12	QL08	QCL120	CL3350	3417	10U94	475LN

Trim styles

Falcon	Arrow	Stanley	Corbin	Hager	Russwin	Sargent	Yale
Dane	Sierra	Sierra	15D	Withnell	NZD	LL	Augusta
Quantum	-	Summit	14D	Archer	PZD	LP	Pacific Beach
Avalon	-	Slate	16D	August	AZD	LB	Monroe
Boardwalk	-	-	-	-	-	-	-
Broadway	-	-	-	-	-	-	-
Latitude	-	-	-	-	-	-	-
Longitude	-	-	-	-	-	-	-

All effort has been made to make this information comprehensive. Since no two products are exactly alike, this data represents those products which are similar. This information was obtained from trade services and is not guaranteed nor meant to represent any product as equal to any other product.

How to order

For correct ordering, and to ensure no delays in shipment of your order, the following descriptive data must be listed in the sequence shown. Necessary information can be found in other parts of this catalog. The example below shows an order for 12 each T locksets in the 571 Dormitory function, D (Dane) trim design in a 626 (satin chrome) finish, with 2 3/4" backset latch, to accommodate doors 1 3/4" thick.

- **Quantity:** Indicate the quantity required.
- **Catalog number:** Select function number, cylinder type, and latch style from tables in this section.
- **Trim design:** Indicate letter of lever design required.
 - Example: AVA=Avalon; DAN=Dane; QUA=Quantum.
- **Finish:** When the finish is the same for the outside and inside trim, it is shown once (626). For split finishes, the outside is designated first, then the inside (605 x 625).
- **Latches:** 2 3/4" backset is standard. Adjustable front standard. A Grade 2 latch with a 1" faceplate in 2 3/8" and 2 3/4" backset also available. See page 40. All latches are UL listed 3 Hour.
- **Strikes:** 4 7/8" x 1 1/4" ANSI standard. Optional T-strike or full lip strike available. See page 41.
- **Cylinder type:** 6 pin is standard. For 7-pin add PD7 to product catalog numbers (eg. T501PD7 QUA).
- **Keying detail:** We suggest using the standard terms developed by DHI (Door and Hardware Institute) or ALOA (Associated Locksmiths of America Inc.
 - Example: AA1 - Grand Master keyed, Master keyed, change key 1.
- **Interchangeable core:** To order product capable of accepting an interchangeable core, add suffixes from the keying table to the function number, preceding the latch style.
 - Example: T511JD will be supplied with a FSIC prepped lever to accept a competitor full size interchangeable core.
- **Keyways:** "G" is standard on regular cylinders, "A" is standard on interchangeable cores. Other keyways available. See current pricebook.
- **Additional keys:** Note the total number of keys required.
- **Large bow keys:** Add—"with large bow keys."

How to order example

Line item	Qty.	Product	Outside		Inside		Hand	Latch	Strike	Door thickness	Ext.	DIM	Additional details/keying
			Des	Fin	Des	Fin							
1	20	T511JD	Dan	626				98535	5164	1 3/4"			With 012191-003-70 dust box. FSIC prep IC-YA6

X Series

Grade 1, heavy-duty cylindrical knob locks

When you need a tough, reliable lock that can also withstand the corrosive conditions of a marine environment you need a Falcon X Series lock with our stainless steel (SS) construction. The SS option provides a stainless steel and nonferrous constructed chassis that, when paired with stainless steel trim, provides a Grade 1 lock that is resistant to corrosion when exposed to moisture and salt. This full knob line features an interchangeable core that can be removed for quick, easy re-keying. Our interchangeable cores are compatible with SFIC products from other manufacturers. And they're backed by one of the best names in the business.

Features

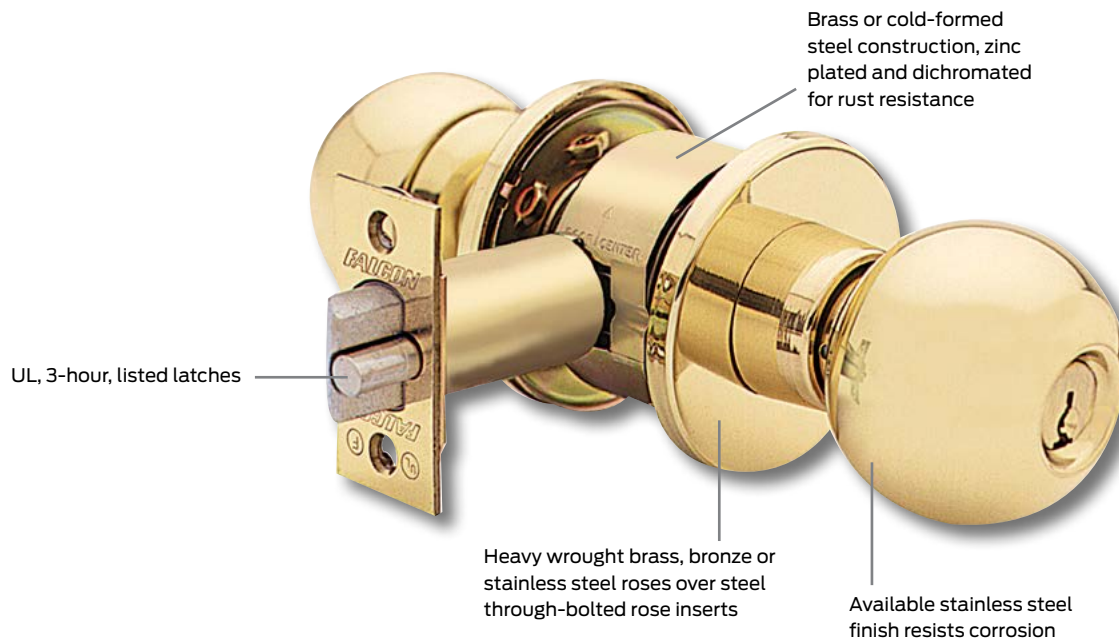

X Series

Features

Door thickness: 1 ³/₈" to 1 ⁷/₈" doors. Locks for thicker doors also available. Consult factory.

Backset: 2 ³/₄" standard. 2 ³/₈" also available.

Mechanism: Parts constructed of brass or cold formed steel, zinc plated and dichromated for rust resistance. Springs are stainless steel. SS Series available with all internal parts of stainless steel or other nonferrous materials.

Attachment: Locks secured to door by threaded collars. Inner collar tightened by special wrench furnished with each lock. Outer rose contains locking plate to prevent unauthorized removal.

Handing: Specify hand of door when ordering. Field reversible.

Cylinders: Drilled with 6-pin chambers, pinned in 5. Pinning in 6 chambers available when specified, at no cost. 7-pin cylinders available in Hana design. Cylinder assemblies removable to rekey or change hand of lock. Also available with 6 or 7-pin interchangeable core cylinders—Elite and Troy designs. Cylinder housings and plugs machined from solid brass. Springs are phosphor bronze. Two nickel silver keys furnished standard. See page 48.

Keyways: "G" keyway standard on standard cylinders. "A" keyway standard on I/C core cylinders. Also available with other keyways and some competitor keyways. See page 50.

Trim: Roses are heavy wrought brass, bronze or stainless steel, installed over wrought steel reinforcing plates. Knobs are brass, bronze or stainless steel secured by a steel knob retainer which cannot be depressed when lock has been locked. See individual designs on pages 46 for details.

Latches: ⁹/₁₆" bolt projection, UL Listed for A-label applications. Standard latch faceplates 2 ¹/₄" x 1 ¹/₈" with square corners to accommodate beveled or flat front doors. ³/₄" projection, UL Listed latch with 2 ³/₄" backset also available.

Strikes: 4 ⁷/₈" x 1 ¹/₄" ANSI strike with curved lip to meet ANSI A115.2 standard door frame preparation standard. Consult Options and Accessories section for other strike sizes and configurations.

Screws: Furnished with combination wood/machine screws for use in wood or metal doors and frames.

ANSI/BHMA: Meets ANSI/BHMA A156.2, Series 4000, Grade 1.

UL: 3 hour A label.

Specifications

Key-in-knob cylindrical locksets shall be Falcon Lock X Series or equal and meet the following requirements:

- All locksets and latchsets shall meet Grade 1 requirements of ANSI/BHMA 156.2, Series 4000.
- Locksets and latchsets shall be UL Listed for use on 3 hour A label doors.
- Locksets and latchsets shall have 3 ¹/₄" diameter round roses.
- Knobs shall be .050" minimum thickness.
- There shall be no exposed screws on trim.
- Locksets and latchsets shall have threaded collars for easy door thickness adjustment on both sides of lock.
- Cylinders shall have a minimum of 6 active pin chambers and shall be furnished with 2 nickel silver keys.
- Locksets shall have 6-pin (or 7-pin) interchangeable cores.

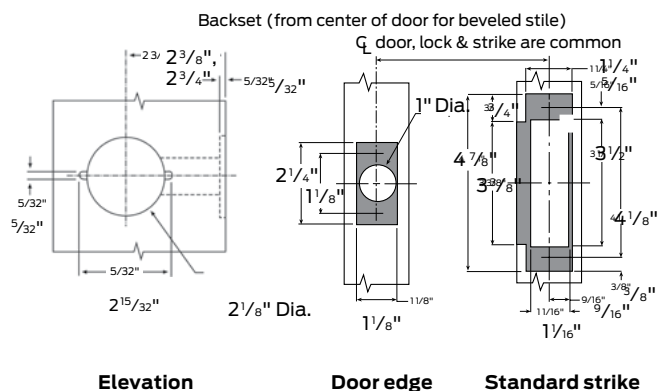

Lever styles

Knobs and roses are wrought brass, bronze or stainless steel (Troy) installed over steel or nonferrous reinforcing plates. Knobs are secured by a spring-loaded retainer. Retainer cannot be depressed when locks have been locked.

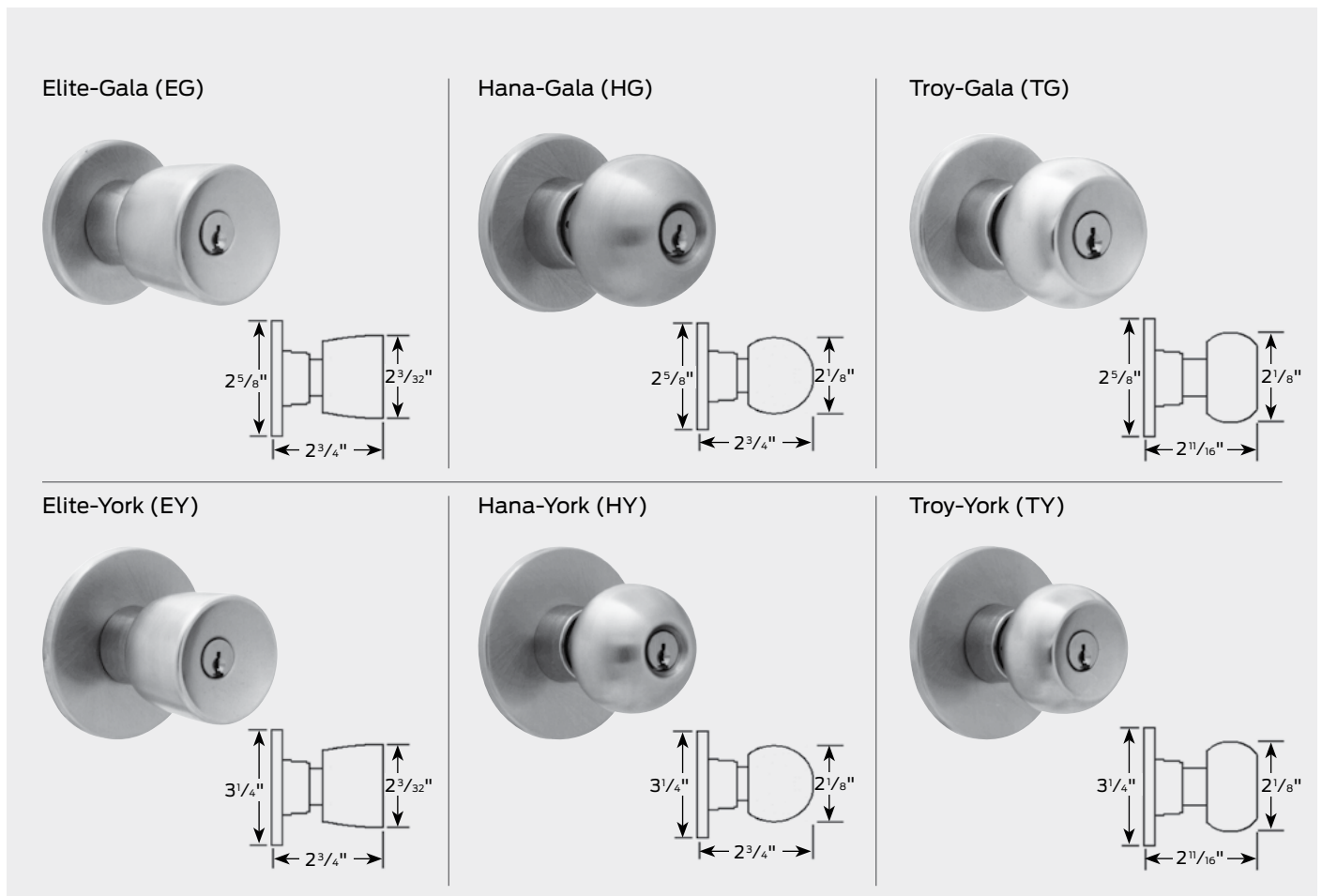

Abrasive coated levers

All trim is available with abrasive coating around the circumference of the knob to identify entrances to hazardous areas to the handicapped. To order, add: "with abrasive coated outer knob" in detail section of order.

Knurled knobs

All heavy duty knobs are available knurled to identify entrances to hazardous areas for the handicapped. To order add: "with knurled knob" (outer or inner) in detail section of order.





Trim finishes chart

Description	ANSI No.	Available on
Bright brass	605	All trim
Satin brass	606	All trim
Satin bronze	612	All trim
Oil rubbed bronze	613	All trim
Bright chrome	625	All trim
Satin chrome	626	All trim
Satin stainless steel	630	Troy knobs only

Functions

To order Falcon T Series locksets, please consult page 54 for ordering information and assistance.

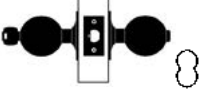
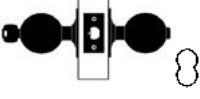
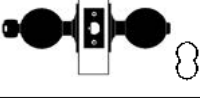
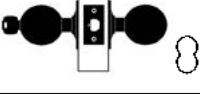
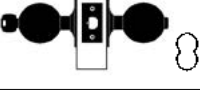
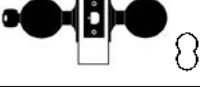
 Indicates interchangeable core available.

Catalog number	Function	Name	Description	ANSI No. & Grade
X101		Passage/closet set	Latch bolt by knobs at all times.	F75
X301		Privacy lock	Latch bolt by knobs. Outside knob locked by push button in inside knob. Rotating inside knob or closing door releases push button. Emergency release in outside knob. Emergency Release Tool 001423-001-30.	F76
X411		Asylum lock	Deadlocking latch bolt by key from either side. Both knobs rigid.	F87
X501		Entry lock	Push button locking. Button on inside locks outside knob until unlocked by key or by rotating inside knob.	F82
X511		Entry/office lock	Turn/push button locking. Pushing and turning button locks outside knob requiring use of key until button is manually unlocked. Push button locking. Pushing button locks outside knob until unlocked by key or by turning inside knob.	F109
X521		Office lock	Turn button locking. Turning button locks outside knob requiring use of key until button is manually unlocked. Inside knob always free.	F81
X561		Classroom lock	Deadlocking latch bolt by knobs. Outside knob is locked by key in outside knob. Inside knob is always free.	F84
X571		Dormitory lock	Deadlocking latch bolt by knobs except when locked by push button in inside knob. Key in outside knob locks or unlocks outside knob and releases button. Closing door releases push button. Inside knob always free.	F90
X581		Storeroom lock	Deadlocking latch bolt by inside knob or key outside. Outside knob rigid.	F86
X12		Single dummy	Single trim—surface mounted.	

Cylinders

Falcon standard cylinders

Catalog number 5-pin cylinder	6-pin cylinder	7-pin cylinder	Knob design	Function
A23151-00	A23161-00	N/A	E, T	561
A23152-00	A23162-00	N/A	E, T	411/501/511/521/581
A23151-02	A23161-02	N/A	E, T	571
A23151-02	A23161-02	A23171-01	H	561
A23152-02	A23162-02	A23172-02	H	411/501/511/521/581
A23151-03	A23161-03	A23171-02	H	571

Note: Specify finish: 606 or 626. Specify keyway: "E", "G" (standard), "H", "K", "L", "N" or "P".

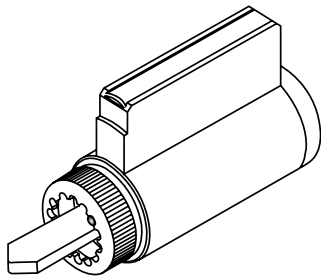

X381 outside
411, 501
511, 521, 581
Hana

Falcon interchangeable cores

Catalog number	Description
C606	For use in all X Series I/C keyed locks-6-pin (cover style)
C607	For use in all X Series I/C keyed locks-7-pin (cover style)
CB806	For use in all X Series I/C keyed locks-6-pin (cap style)
CB807	For use in all X Series I/C keyed locks-7-pin (cap style)

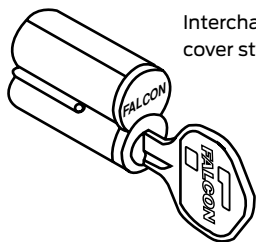

Interchangeable core
cover style

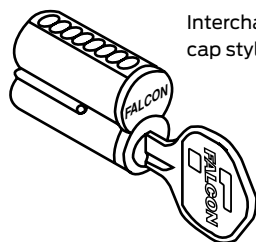

Interchangeable core
cap style

Note: Construction keying available. Reference page 101 for more information.

Competitor keyways

Standard cylinders with competitor keyways — 6-pin

Functions: 411, 501, 511, 521 and 581

Catalog no.	Description	Knob design
A23174-005	Corbin/Ruswin L4 'O' bitted	E,T
A23167-005	Corbin 60 'O' bitted	E,T
A23167-5KD	Corbin 60 'KD' keyed different	E,T
A23168-005	Ruswin D1 'O' bitted	E,T
A23168-5KD	Ruswin D1 'KD' keyed different	E,T
A23166-005	Sargent LA 'O' bitted	E,T
A23166-5KD	Sargent LA 'KD' keyed different	E,T
A23160-005	Schlage C 'O' bitted	E,T
A23160-5KA	Schlage C 'KA' keyed alike 4	E,T
A23160-5KD	Schlage C 'KD' keyed different	E,T
A23159-005	Schlage E 'O' bitted	E,T
A23169-005	Yale 8 (PARA) 'O' bitted	E,T
A23169-5KD	Yale 8 (PARA) 'KD' keyed different	E,T
A23174-006	Corbin/Ruswin L4 'O' bitted	H
A23167-006	Corbin 60 'O' bitted	H
A23167-6KD	Corbin 60 'KD' keyed different	H
A23168-006	Ruswin D1 'O' bitted	H
A23168-6KD	Ruswin D1 'KD' keyed different	H
A23166-006	Sargent LA 'O' bitted	H
A23166-6KD	Sargent LA 'KD' keyed different	H
A23160-006	Schlage C 'O' bitted	H
A23160-6KA	Schlage C 'KA' keyed alike 4	H
A23160-6KD	Schlage C 'KD' keyed different	H
A23159-006	Schlage E 'O' bitted	H
A23169-006	Yale 8 (PARA) 'O' bitted	H
A23169-6KD	Yale 8 (PARA) 'KD' keyed different	H

Note: Specify finish: 606 or 626.

Functions: 561

Catalog no.	Description	Knob design
A23174-001	Corbin/Ruswin L4 'O' bitted	E,T
A23167-001	Corbin 60 'O' bitted	E,T
A23167-1KD	Corbin 60 'KD' keyed different	E,T
A23168-001	Ruswin D1 'O' bitted	E,T
A23168-1KD	Ruswin D1 'KD' keyed different	E,T
A23166-001	Sargent LA 'O' bitted	E,T
A23166-1KD	Sargent LA 'KD' keyed different	E,T
A23160-001	Schlage C 'O' bitted	E,T
A23160-1KA	Schlage C 'KA' keyed alike 4	E,T
A23160-1KD	Schlage C 'KD' keyed different	E,T
A23159-001	Schlage E 'O' bitted	E,T
A23169-001	Yale 8 (PARA) 'O' bitted	E,T
A23169-1KD	Yale 8 (PARA) 'KD' keyed different	E,T

Note: Specify finish: 606 or 626.

Functions: 561 Hana and X571 Troy & Elite

Catalog no.	Description	Knob design
A23174-003	Corbin/Ruswin L4 'O' bitted	E,T, H
A23167-003	Corbin 60 'O' bitted	E,T, H
A23167-3KD	Corbin 60 'KD' keyed different	E,T, H
A23168-003	Ruswin D1 'O' bitted	E,T, H
A23168-3KD	Ruswin D1 'KD' keyed different	E,T, H
A23166-003	Sargent LA 'O' bitted	E,T, H
A23166-3KD	Sargent LA 'KD' keyed different	E,T, H
A23160-003	Schlage C 'O' bitted	E,T, H
A23160-3KA	Schlage C 'KA' keyed alike 4	E,T, H
A23160-3KD	Schlage C 'KD' keyed different	E,T, H
A23159-003	Schlage E 'O' bitted	E,T, H
A23169-003	Yale 8 (PARA) 'O' bitted	E,T, H
A23169-3KD	Yale 8 (PARA) 'KD' keyed different	E,T, H

Note: Specify finish: 606 or 626. Standard cylinders with competitor keyways - 7-Pin

Functions: 571

Catalog no.	Description	Knob design
A23167-004	Corbin 60 O-bitted	H
A23167-4KD	Corbin 60 KD	H
A23174-004	Corbin Ruswin L4 O-bitted	H
A23168-004	Ruswin D1 O-bitted	H
A23168-4KD	Ruswin D1 KD	H
A23166-004	Sargent LA O-bitted	H
A23166-4KD	Sargent LA KD	H
A23160-004	Schlage C O-bitted	H
A23160-4KA	Schlage C KA4	H
A23160-4KD	Schlage C KD	H
A23159-004	Schlage E O-bitted	H
A23169-004	Yale 8 Para O-bitted	H
A23169-4KD	Yale 8 Para KD	H

Note: Specify finish: 606 or 626.

Latches

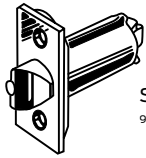

Square corner
9/16" projection

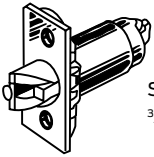

Square corner
3/4" projection

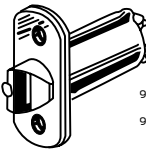

9/16" Radius corner
9/16" projection



3 Hour



Grade 1, UL listed

Catalog number	Description	Faceplate size	Corner	Projection
A98535-000	2 3/4" backset spring	2 1/4" x 1 1/8"	Square	9/16"
A98535-00D	2 3/4" backset deadlocking	2 1/4" x 1 1/8"	Square	9/16"
A98538-000	2 3/4" backset spring	2 1/4" x 1 1/8"	Radius 9/16"	9/16"
A98538-00D	2 3/4" Backset deadlocking	2 1/4" x 1 1/8"	Radius 9/16"	9/16"
A98835-OSD	2 3/4" Backset deadlocking	2 1/4" x 1 1/8"	Square	3/4"
A98838-OSD	2 3/4" Backset deadlocking	2 1/4" x 1 1/8"	Radius 9/16"	3/4"

Note: Specify finish 606, 612, 613, 630

Latches for X Series locks are UL listed. 2 3/4" backset standard.

1 1/8" width latch face minimum. Unless otherwise specified, we furnish a 2 1/4" x 1 1/8" x square corner faceplate on 2 3/4" backset latches front standard.

Grade 2, UL listed for flat or beveled doors

Catalog number	Description	Faceplate size	Corner	Projection
A92320-000	2 3/8" backset spring	2 1/4" x 1"	Square	1/2"
A92320-00D	2 3/8" backset deadlocking	2 1/4" x 1"	Square	1/2"
A92321-000	2 3/8" backset spring	2 1/4" x 1"	Radius	1/2"
A92321-00D	2 3/8" backset deadlocking	2 1/4" x 1"	Radius	1/2"
A92330-000	2 3/4" backset spring	2 1/4" x 1"	Square	1/2"
A92330-00D	2 3/4" backset deadlocking	2 1/4" x 1"	Square	1/2"
A92331-000	2 3/4" backset spring	2 1/4" x 1"	Radius	1/2"
A92331-00D	2 3/4" backset deadlocking	2 1/4" x 1"	Radius	1/2"

Note: Specify finish 606, 612, 613, 630

Latches for X Series locks are UL Listed.

These grade 2 latches have self-adjusting fronts to accommodate beveled or flat front doors. Unless otherwise specified, we furnish a 2 1/4" x 1" x square corner faceplate on these latches.



3 Hour



Strikes, backsets and dustboxes

Strikes

Furnished with a $4\frac{7}{8}$ " ANSI strike unless otherwise specified.

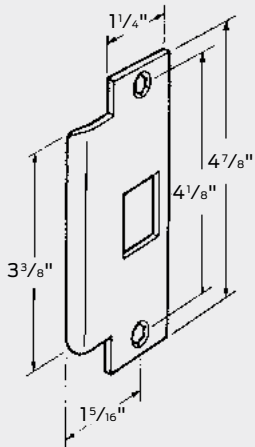

005164-000
ANSI prep A115.2

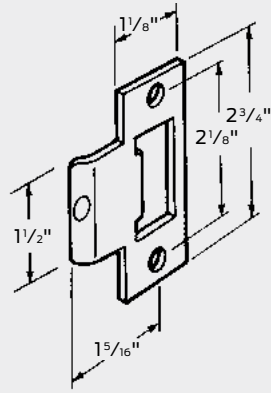

A05185-000
T-strike square corner

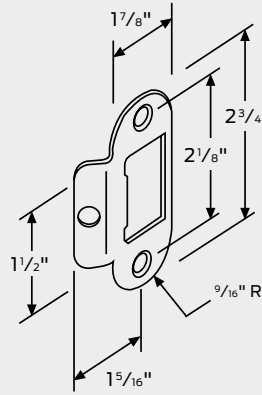

A05133-004
Vermin proof strike for ships

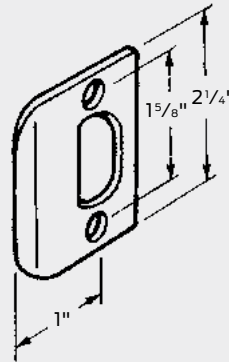

Q001-049
Full lip, square corner

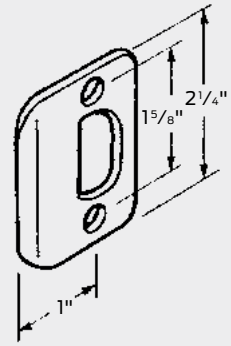

Q001-048
Full lip, $\frac{1}{4}$ " radius corner

Long backset extension link

A22161-005-00 Link for 5" backset for use with $2\frac{3}{4}$ " backset latches (except $\frac{3}{4}$ " projection).

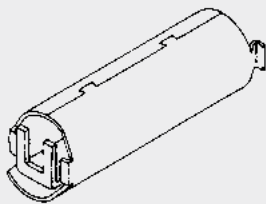

A22161-005-00

Dust boxes



005099-000-30
1" deep. May be used with any $4\frac{7}{8}$ " high (ANSI) strike.

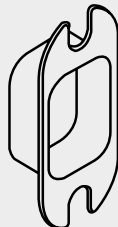

012191-003-70
 $\frac{1}{2}$ " deep. May be used with any $2\frac{3}{4}$ " high (T) strike.

Function and trim style cross-reference

X Series Grade 1 cylindrical key-in-lever lock

ANSI no.	Function	Falcon	Arrow	Best	Corbin/ Russwin	Marks	Sargent	Yale
F75	Passage	X101	H01	83KN	CK4210	80N	8U15	5401
F76	Privacy	X301	H02	83KL	CK4220	80L	8U65	5402
F87	Asylum	X411	H33	83KW	CK4232	80DW	8G17	5430
F82	Entry	X501	H13	83KAB	CK4261	—	8G24	5407
F109	Entry/office	X511	H11	83KAB	CK4251	80AB	8G24	5407
F81	Office	X521	H11	83KAB	CK4251	80A	8G05	5407
F84	Classroom	X561	H17	83KR	CK 4255	80S	8G37	5408
F90	Dormitory	X571	H19	83KT	CK4275	80T	8G54	5422
F86	Storeroom	X581	H12	83KD	CK4257	80F	8G04	5405
	Single dummy	X12	H08	83K1DT	CK4250	80DO	8U93	455

Trim styles

Falcon	Arrow	Best	Corbin/Russwin	Marks	Sargent	Yale
Hana/Gala (HG)	BD	4C	GRC	280	OB	CA
Troy/Gala (TG)	TA	—	—	180	EC	LF
Elite/Gala (EG)	DD	6C	BRC	—	EG	BR

All effort has been made to make this information comprehensive. Since no two products are exactly alike, this data represents those products which are similar. This information was obtained from trade services and is not guaranteed nor meant to represent any product as equal to any other product.

How to order

For correct ordering, and to ensure no delays in shipment of your order, the following descriptive data must be listed in the sequence shown. Necessary information can be found in other parts of this catalog. The example below shows an order for 20 each X locksets in the 301 Privacy function, EG (Elite-Gala) trim design in a 626 (satin chrome) finish, with 2 3/4" backset latch, to accommodate doors 1 3/4" thick.

- **Quantity:** Indicate the quantity required.
- **Catalog number:** Select function number, cylinder type, and latch style from tables in this section.
- **Trim design:** Indicate letter of knob/rose design. EG = Elite/Gala; HY = Hana/York. Outside design always precedes inside design on split designs.
- **Finish:** When the finish is the same for the outside and inside trim, it is shown once (626). Outside finish always precedes inside finish on split finishes (605 x 625).
- **Latches:** 2 3/4" backset is standard. 2 3/8" backset available. All latches are UL listed 3-hour A label.
- **Strikes:** 4 7/8" x 1 1/4" ANSI standard. Optional T-strike or full lip strike available. See page 51.
- **Cylinder type:** 6-pin standard. For 7 pin add PD7 to product catalog numbers (eg. X511PD7 HAN). 7 pin conventional cylinders are available in Hana knob style only.
- **Door hand:** Locks are field reversible. Please specify handing on all keyed locks so that cylinders can be assembled in the upright position.
- **Keying detail:** We suggest using the standard terms developed by DHI (Door and Hardware Institute).
 - Example: AA1 - Grand Master keyed, Master keyed, change key 1.
- **Interchangeable core:** To order product capable of accepting an interchangeable core, add suffices from the keying table to the function number, preceding the latch style.
 - Example: X511HD will be supplied with SFIC keyed construction core.
- **Keyways:** "G" is standard on regular cylinders, "A" is standard on interchangeable cores. Other keyways available.
- **Additional keys:** Note the total number of keys required.
- **Large bow keys:** Add—"with large bow keys."

How to order example

Line item	Qty.	Product	Outside		Inside		Hand	Latch	Strike	Door thickness	Ext.	DIM	Additional details/keying
			Des	Fin	Des	Fin							
1	20	X301S	EG	626			LHR	98535	5185	1 3/4"			With 012191-003-70 dust box

K Series

Grade 1 cylindrical lever locks

High traffic, high abuse door openings demand a Grade 1 quality lock to keep doors secure. When quality and reliability are needed but cost is a concern, the certified ANSI/BHMA Grade 1 Falcon K Series can do the job. The Falcon K Series gets back to basics by offering the most common functions, lever styles and finishes at an affordable price. The K Series features conventional cylinders and small format interchangeable cores that are compatible with SFIC products from other manufacturers. Our conventional cylinders are available in all Falcon conventional key sections, as well as Schlage C keyway, which is now masterkeyed across the complete Falcon product line.

Features

Lever security caps to help prevent undesired lever removal and lever sag after continual use

Four screws through-bolted for added strength, providing high security and peace of mind



UL listed latch standard

Clutching lever design allows the lever to move when locked without unlatching the door, preventing damage to the chassis

Non-handed levers for easy field installation

Conventional cylinders or interchangeable core keying compatible with SFIC products from Falcon or other manufacturers.

K Series

Features

ANSI/BHMA: Meets ANSI/BHMA A156.2, Series 4000, Grade 1.

UL: UL10C 3 hour A label.

Door thickness: Adjustable 1 ³/₈" to 2 ¹/₄". Comes set for a 1 ³/₄" thick door standard.

Backset: 2 ³/₄" standard. 2 ³/₈" optional.

Mechanism: Parts constructed of brass or cold formed steel, zinc plated and dichromated for rust resistance. Springs are stainless steel.

Attachment: Lock chassis secured to door by threaded mounting screws. Completely preassembled outer trim and inner spindle assembly are through-bolted both through and over chassis using four (4) screws to provide strength and resistance to loosening. Adding rose and lever to inner spindle assembly completes installation.

Handing: Locks are non-handed.

Cylinders: Drilled with 6-pin chambers, pinned in 5. Pinning in 6 chambers available when specified, at no cost. Cylinder assemblies removable to rekey. Also available with 6 or 7-pin small format interchangeable core (SFIC) cylinders. Cylinder housings and plugs machined from solid brass. Springs are stainless steel. Two nickel silver keys furnished standard.

Keyways: "G" keyway standard on conventional cylinders. "A" keyway standard on I/C core cylinders. Also available with some optional keyways.

Trim: Roses are heavy wrought brass or bronze, installed over pressure cast rose inserts which are through-bolted through door. Levers are pressure cast (solid levers—no inserts) material finished to match mating parts.

Latches: 2 ¹/₄" x 1 ¹/₈" square corner with 2 ³/₄" backset comes standard; 2 ³/₈" backset option available if specified. Radius corners for both 2 ³/₈" and 2 ³/₄" backsets available if specified. All latches are UL listed and conform to both beveled and non-beveled doors.

Strikes: 4 ⁷/₈" x 1 ¹/₄" ANSI strike with curved lip to meet ANSI A115.2 door frame preparation standard.

Screws: Furnished with combination screws for use in wood or metal doors and frames.

Specifications

Key-in-lever cylindrical locksets shall be Falcon lock K Series or equal and meet the following requirements:

- All locks shall meet the new ANSI/BHMA A156.2, Series 4000, Grade 1 for key-in-lever locksets.
- Locksets shall be UL Listed (3 hour A Label).
- Locksets shall be provided standard with a clutching lever design. When outside lever is locked, it is not rigid but will move freely without operating the latch bolt.
- Lever trim shall have individual torsion springs behind rose for lever return and to prevent lever sag. Trim shall be through bolted with four (4) screws to provide strength and resistance to loosening. Inner and outer trim shall "bottom out" to prevent door collapse. Roses shall be minimum of 3 ¹/₂" diameter.
- All lever designs shall be solid and meet the federal ADA and state disability requirements. Inside levers shall be attached by allen-head set and lever catch to prevent tampering or vandalism.
- Locksets shall adjust to fit door thickness from 1 ³/₈" to 2 ¹/₄".
- All locksets shall be non-handed and not require field disassembly for re-handing.
- Preparation for door must be non-handed.
- Cylinders to be secured by a dual retainer.

Acceptable manufacturer: Falcon Lock

Lever styles

Avalon

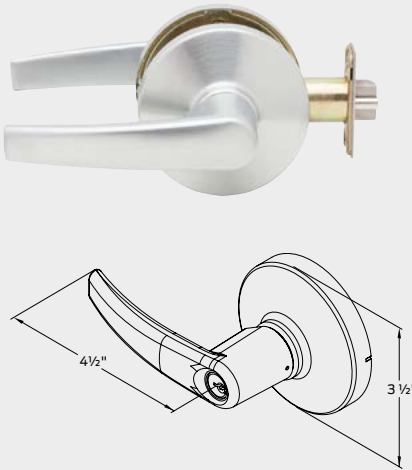

Dane

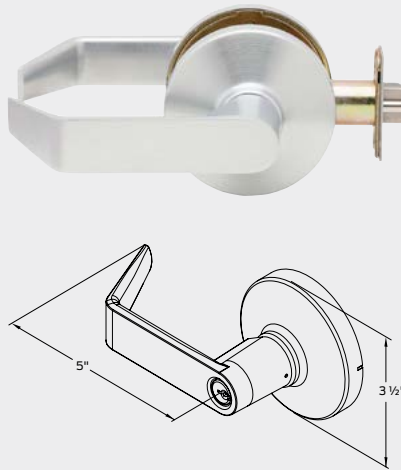

Quantum

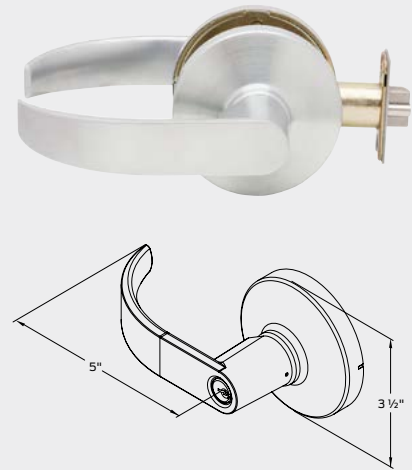











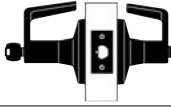

Trim finishes chart

Description	ANSI No.	Available on
Oil rubbed bronze	613	All trim
Satin chrome	626	All trim

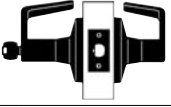
Functions

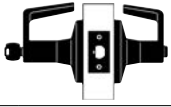
The Falcon K Series offers the industry's most common cylindrical lock functions to cover all of your basic door requirements. Consult page 61 for ordering information and assistance.

 Indicates interchangeable core available.

Catalog number	Function	Name	Description	ANSI no.
K101		Passage/closet latchset	Latch bolt by levers at all times.	F75
K301		Privacy lock	Latch bolt by levers. Outside lever locked by push button in inside lever. Rotating inside lever or closing door releases push button. Emergency release in outside lever unlocks door.	F76
K501		Entry lock 	Push button locking. Button on inside locks outside lever until unlocked by key or by rotating inside lever. Inside lever always free. Deadlocking latch bolt.	F82
K511		Entry/office lock 	Turn/push button locking. Pushing and turning button locks outside lever requiring use of key until button is manually unlocked. Push button locking. Pushing button locks outside lever until unlocked by key or by rotating inside lever. Inside lever always free. Deadlocking latch bolt.	F109
K561		Classroom lock 	Deadlocking latch bolt by levers. Outside lever is locked by key in outside lever. Inside lever is always free.	F84
K571		Corridor lock 	Deadlocking latch bolt by levers except when locked by push button in inside lever. Key in outside lever locks or unlocks outside lever and releases button. Closing door releases push button. Inside lever always free.	F90
K581		Storeroom lock 	Deadlocking latch bolt by lever inside or key outside. Outside lever is inoperable. Inside lever always free.	F86
K12		Dummy trim	Single trim-surface mounted rigid lever.	

Cylinders and competitor keyways

Standard cylinders - 6-pin

Catalog number	Description
Q330-396	Falcon cylinder, G keyway, 6 pin
Q330-397	Falcon cylinder, G keyway, 6 pin to 5 pin
Q630-310	Falcon cylinder, G keyway, 6 pin, K571
Q630-311	Falcon cylinder, G keyway, 6 pin to 5 pin, K571
Q330-391	Schlage cylinder, C keyway, 6 pin
Q630-306	Schlage cylinder, C keyway, 6 pin, K571

Note: Specify finish: 606 or 626

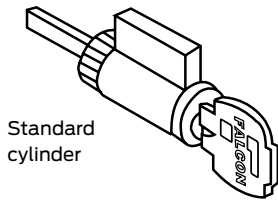

Small format interchangeable core

Catalog number	Description
C606 (6-pin), C607 (7-pin)	For use in all I/C keyed locks (cover style)
CB806 (6-pin), CB807 (7-pin)	For use in all I/C keyed locks (cap style)

Note: Specify finish: 606 or 626
Specify keyway: A (standard) or other keyway

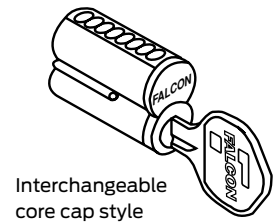
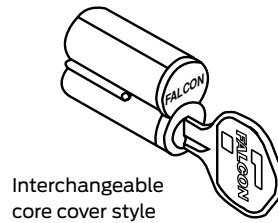

Tailpieces

Catalog number	Description
Q630-289	SFIC tailpiece (K501, K511, K561, & K581)
Q330-392	SFIC tailpiece (K571)
Q330-393	Tailpiece, Falcon G-K501, K511, K561, K581
Q330-394	Tailpiece, Falcon G-K571
Q630-312	Tailpiece, Schlage C-K501, K511, K561, K581
Q630-288	Tailpiece, Schlage C-K571

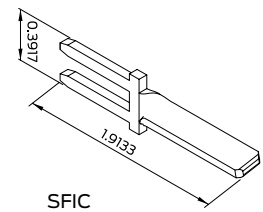
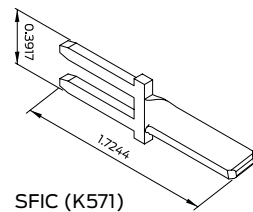
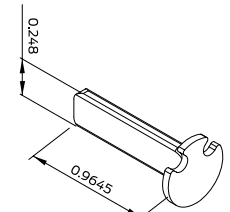
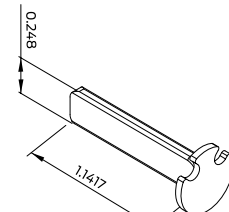
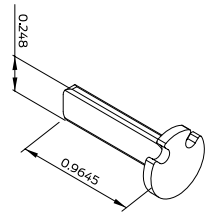

Standard cylinders with competitor keyways - 6-pin

Catalog number	Description
Q330-152	Schlage C
Q330-166	Corbin 60 (0 bit or KD only)
Q330-210	Russwin D1 (0 bit or KD only)
Q330-158	Cor/Russ L4 (0 bit or KD only)
Q330-160	Sargent LA (0 bit or KD only)
Q330-156	Yale 8 (0 bit or KD only)

Note: Construction keying available. Reference page 101 for more information.

Latches, strikes and other accessories

Latches

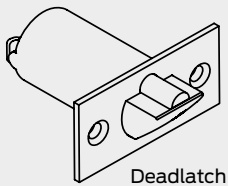

Deadlatch

Deadlatches

Catalog number	Description	Faceplate size	Corner	Projection
Q630-385	2 3/4" Backset with deadlatching	2 1/4" X 1 1/8"	Square	1/2"
Q630-387	2 3/4" Backset with deadlatching	2 1/4" X 1 1/8"	Radius	1/2"
Q630-386	2 3/8" Backset with deadlatching	2 1/4" X 1 1/8"	Square	1/2"
Q630-388	2 3/8" Backset with deadlatching	2 1/4" X 1 1/8"	Radius	1/2"
Q630-302	2 3/4" Backset with deadlatch, non-restoring	2 1/4" X 1 1/8"	Square	1/2"
Q630-274	2 3/4" Backset with deadlatch, non-restoring	2 1/4" X 1 1/8"	Radius	1/2"
Q630-301	2 3/8" Backset with deadlatch, non-restoring	2 1/4" X 1 1/8"	Square	1/2"
Q630-275	2 3/8" Backset with deadlatch, non-restoring	2 1/4" X 1 1/8"	Radius	1/2"

Springlatches

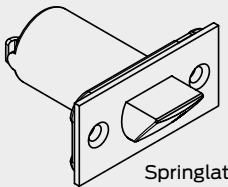

Springlatch

Catalog number	Description	Faceplate size	Corner	Projection
Q630-270	2 3/4" Backset with springlatch	2 1/4" X 1 1/8"	Square	1/2"
Q630-272	2 3/4" Backset with springlatch	2 1/4" X 1 1/8"	Radius	1/2"
Q630-271	2 3/8" Backset with springlatch	2 1/4" X 1 1/8"	Square	1/2"
Q630-273	2 3/8" Backset with springlatch	2 1/4" X 1 1/8"	Radius	1/2"
Q630-266	2 3/4" Backset with springlatch, non-restoring	2 1/4" X 1 1/8"	Square	1/2"
Q630-268	2 3/4" Backset with springlatch, non-restoring	2 1/4" X 1 1/8"	Radius	1/2"
Q630-267	2 3/8" Backset with springlatch, non-restoring	2 1/4" X 1 1/8"	Square	1/2"
Q630-269	2 3/8" Backset with springlatch, non-restoring	2 1/4" X 1 1/8"	Radius	1/2"

Note: All latches are UL listed and conform to both beveled and non-beveled doors. Bolded deadlatches come standard with all keyed functions and bolded springlatches comes standard with all non-keyed functions.

Strikes

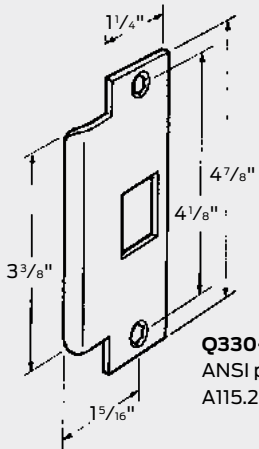

Q330-148
ANSI prep
A115.2

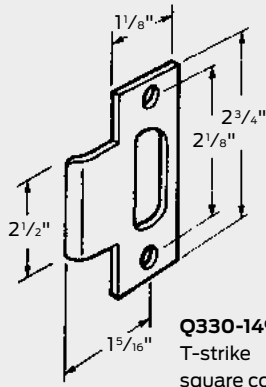

Q330-149
T-strike
square corner

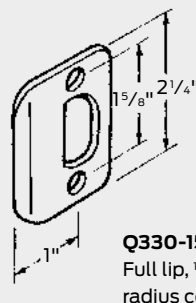

Q330-150
Full lip, 1/4"
radius corner

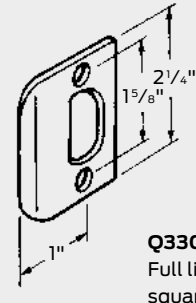

Q330-151
Full lip,
square corner

Other accessories

Faceplates

Catalog number	Description
Q630-279	Faceplate, dead latch, round corner
Q630-278	Faceplate, dead latch, square corner
Q630-277	Faceplate, spring latch, round corner
Q630-276	Faceplate, spring latch, square corner

Screw packs

Catalog number	Description
Q630-254	Screw pack, standard
Q330-399	Screw pack, dummy

Function and trim style cross-reference

ANSI	Function	Falcon	Hager	Stanley Commercial	Yale	PDQ	Cal Royal	Arrow
		K Series	3400 Series	QCL 100 Series	4700LN Series	GT Series	Calypso Series	QL Series
F75	Passage lock	K101	3410	QCL130	4701LN	GT126	CAL30	QL01
F76	Privacy lock	K301	3440	QCL140	4702LN	GT176	CAL20	QL02/72
F82	Entry lock	K501	3450	-	4704LN	GT182	-	-
F109	Entry/office lock	K511	3453	QCL150	4707LN	GT116	CAL00	QL11/81
F84	Classroom lock	K561	3470	QCL160	4708LN	GT148	CAL03	QL17/87
F90	Corridor lock	K571	3473	QCL154	4722LN	GT165	CAL101	QL19/89
F86	Storeroom lock	K581	3480	QCL170	4705LN	GT115	CAL05	QL12/82
	Single dummy trim	K12	3417	QCL120	4755LN	GT211	CAL40	QL08

How to order

Two simple ways to place your Falcon K Series order!

ProExpress™

E-Mail: Order.Pro.Express@allegion.com
Fax: 1.800.924.3551

Standard Falcon order

E-Mail: Order_Entry_Schlage_Commercial@allegion.com
Fax: 1.800.452.0665

Order example

Line item	Qty	Product	Design	Finish	Latch	Strike	Door thickness
1	10	K511PD	DAN	626			

Note: Only specify latch, strike and door thickness if item is not standard

Warranty

The Falcon K Series lock has a limited 10 year warranty.

Please reference **www.us.allegion.com** for Falcon product warranty details.

B Series

Grade 2, medium-duty cylindrical lever locks

When you need a tough, reliable lock for a government/military, retail, industrial or multi-family project, you need a Falcon B Series lock. Our full line of Grade 2 locksets are a perfect replacement for existing locks, or a smart specification in new construction. With upgraded finishes, these locks deliver style as well as strength. Falcon B Series locks feature an interchangeable core that can be removed for quick, easy re-keying, and are compatible with SFIC products from other manufacturers. Most importantly, they're backed by one of the best names in the business.

Features

Heavy wrought brass or bronze roses over steel through-bolted rose inserts

UL Listed 1 1/2 hour

Cylinder housings and plugs machined from solid brass

Brass or cold-formed steel construction with zinc dichromate plating for rust resistance



B Series

Features

Door thickness: 1 3/8" to 2" standard.

Backset: 2 3/4" standard. 2 3/8" also available.

Mechanism: Parts constructed of brass or cold formed steel, zinc plated and dichromated for rust resistance. Springs are stainless steel.

Attachment: Lock chassis secured to door by two screws which pass through a steel rose insert inside and thread directly into the outer rose mounting assembly.

Handing: Locks are non-handed.

Cylinders: Drilled with 6-pin chambers, pinned in 5. Pinning in 6 chambers available when specified, at no cost. Cylinder assemblies removable to rekey. Also available with 6 or 7-pin interchangeable core cylinders. Cylinder housings and plugs machined from solid brass. Springs are phosphor bronze. Two nickel silver keys furnished standard.

Competitor cylinders: The B Series accepts these standard 6-pin cylinders: Assa, Kaba, Lori, Medeco, Primus and Schlage.

Keyways: "G" keyway standard on standard cylinders. "A" keyway standard on I/C core cylinders. Also available with some optional keyways. See page 66.

Trim: Roses are 3 1/2" diameter, heavy wrought brass or bronze, installed over steel rose inserts which are through-bolted through door. Levers are pressure cast zinc (solid levers no inserts) material finished to match mating parts.

Latches: 1/2" bolt projection. UL (3-hour, A Label) listed. Latches have self-adjusting fronts to accommodate beveled or flat doors. 2 3/8" backset with 2 1/4" x 1" latchfaces, 2 3/4" backset with 2 1/4" x 1 1/8" latchfaces. Deadlocking latches have a solid round bar stock DL bar preventing latch jamming and/or lock outs.

Strikes: 4 7/8" x 1 1/4" ANSI strike with curved lip to meet ANSI A115.2 door frame preparation standard. Consult Options and Accessories section for other available strike size and configurations.

Screws: Furnished with combination screws for use in wood or metal doors and frames.

ANSI/BHMA: Exceeds ANSI/BHMA A156.2, Series 4000, Grade 2.

UL: 3 hour, A label.

Specifications

Key-in-lever cylindrical locksets shall be Falcon B Series or equal and meet the following requirements:

- All locks shall meet the new ANSI/BHMA A156.2, Series 4000, Grade 2 test requirements for key-in-lever locksets.
- Locksets shall be UL Listed 3-hour, A Label.
- Lever trim shall have individual heavy-duty springs for lever return and to prevent lever sag. Trim shall be through-bolted with screws coated with thread sealant to provide strength and resistance to loosening.
- Roses shall be 3 1/2" diameter.
- All lever designs shall be solid (no inserts) and meet the federal ADA and state disability requirements.
- Locksets shall adjust to fit door thickness from 1 3/8" to 2".
- All locksets shall be non-handed and not require field disassembly for re-handing.
- Preparation for door must be non-handed. Acceptable manufacturer: Falcon lock

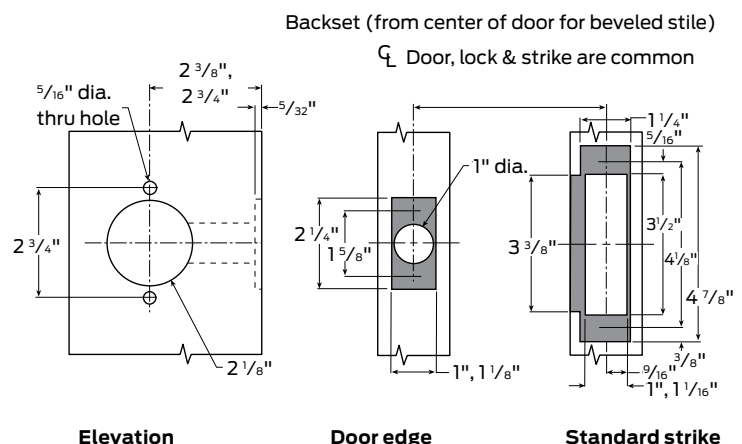

Lever styles

Levers are solid pressure cast zinc, finished to match mating parts. Roses are wrought brass or bronze installed over steel through-bolted rose inserts. Levers are secured by a spring-loaded retainer. Retainer in keyed lever cannot be depressed without key.

Dane (D)

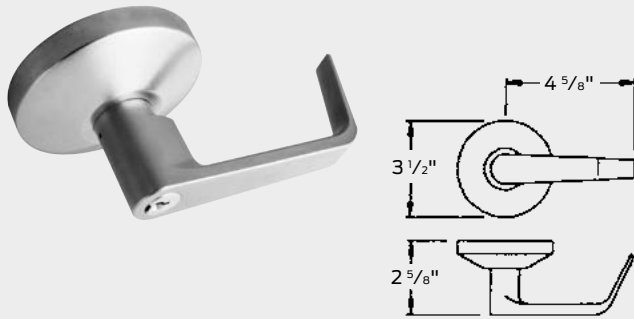

Quantum (Q)

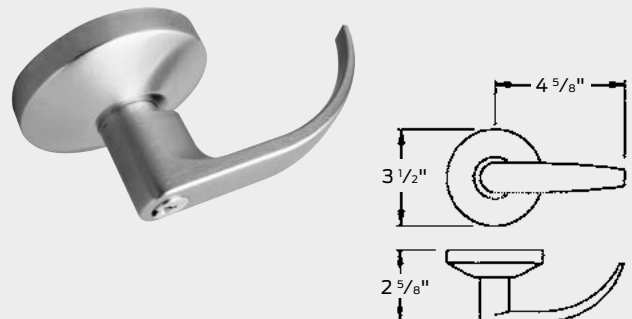

Abrasive strip levers

All levers are available with an abrasive strip along the inside length of the lever to identify entrances that may be hazardous to the handicapped. To order, change trim designation to: 6DA (Dane) or 6QU (Quantum) in trim section of order. Not available on 613 finish as abrasive strip will not hold.











Trim finishes chart

Description	ANSI No.	Available on
Bright brass	605	All trim
Satin brass	606	All trim
Satin bronze	612	All trim
Oil rubbed bronze	613	All trim
Bright chrome	625	All trim
Satin chrome	626	All trim

Functions

To order Falcon B Series locksets, please consult page 70 for ordering information and assistance.

 Indicates interchangeable core available.

Catalog number	Function	Name	Description	ANSI no.
B101		Passage/closet set	Latch bolt by levers at all times.	F75
B161		Communicating/exit latch	Deadlocking latch bolt by inside lever. Non-removable blank plate outside.	
B301		Privacy lock	Latch bolt by levers. Outside lever locked by push button in inside lever. Rotating inside lever or closing door releases push button. Emergency release in outside lever unlocks door.	F76
B341		Connecting room/exit lock	Connecting room/exit lock—Deadlocking latch bolt by inside lever except when locked by key. Non-removable blank plate outside ($2^{2}/_{32}$ " projection).	
B501		Entry lock	Push button locking. Button on inside locks outside lever until unlocked by key or by rotating inside lever. Inside lever always free. Deadlocking latch bolt.	F82
B511		Entry/office lock	Turn/push button locking. Pushing and turning button locks outside lever requiring use of key until button is manually unlocked. Push button locking. Pushing button locks outside lever until unlocked by key or by rotating inside lever. Inside lever always free. Deadlocking latch bolt.	F109
B561		Classroom lock	Deadlocking latch bolt by levers. Outside lever is locked by key in outside lever. Inside lever is always free.	F84
B581		Storeroom lock	Deadlocking latch bolt by lever inside or key outside. Outside lever is rigid. Inside lever is always free.	F86
B611		Dormitory/corridor lock	Deadlocking latch bolt by levers except when locked by push button on inside lever. Key in outside lever locks or unlocks outside lever and releases button. Closing door releases push button. Inside lever is always free.	
B12		Single dummy	Single trim. Surface mounted rigid lever.	

Cylinders and competitor keyways

Falcon standard cylinders

Catalog number	Description
A23155-02	5-pin For use in all B Series except B611*
A23155-06	5-pin For use in all B Series except B611*
A23165-02	6-pin For use in all B Series except B611*
A23165-06	6-pin For use in all B Series except B611*

Note: Specify finish: 606 or 626.
Specify keyway: "E", "G" (standard), "H", "K", "L", "N", "P".
*B611 use same part number except -011, -11D and -11A

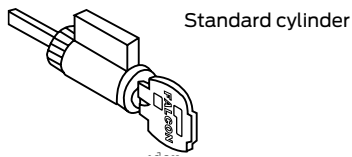

Falcon interchangeable cores

Catalog number	Description
C606	For use in all B Series I/C keyed locks (cover style)
C607	For use in all B Series I/C keyed locks (cover style)
CB806	For use in all B Series I/C keyed locks (cap style)
CB807	For use in all B Series I/C keyed locks (cap style)

Note: Specify finish: 606 or 626.
Specify keyway: "A" (standard) or other keyway.

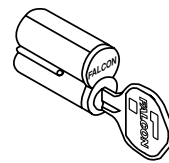

Interchangeable core cover style

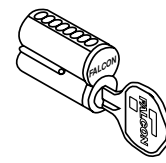

Interchangeable core cap style

Standard cylinders with competitor keyways-6-pin

Catalog number	Description
A23167-013	Corbin 60 'O' bitted
A23167-13D	Corbin 60 'KD' keyed different
A23168-013	Russwin D1 'O' bitted
A23168-13D	Russwin D1 'KD' keyed different
A23174-013	Corbin Russwin L4 'O' bitted
A23174-13A	Corbin Russwin L4 'KA' keyed alike 4
A23166-013	Sargent LA 'O' bitted
A23166-13D	Sargent LA 'KD' keyed different
A23160-013	Schlage C 'O' bitted
A23160-13A	Schlage C 'KA' keyed alike 4
A23160-13D	Schlage C 'KD' keyed different
A23159-013	Schlage E 'O' bitted
A23169-013	Yale 8 (PARA) 'O' bitted
A23169-13D	Yale 8 (PARA) 'KD' keyed different

Note: Specify finish 606 or 626
For B611 use same part number except -011, -11A, -11D

Note: Construction keying available. Reference page 101 for more information.

Latches

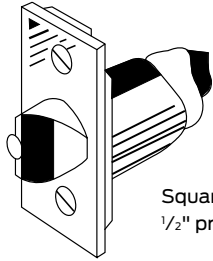

Square corner
1/2" projection

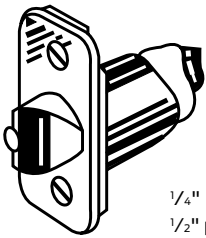

1/4" Radius corner
1/2" projection

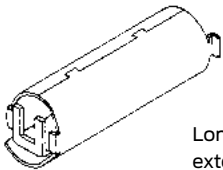

Long backset
extension link



1 1/2 Hour

1/2" projection, UL listed

Catalog number	Description (functions)	Faceplate size	Corner
A57420-000	2 3/8" Backset spring (101)	2 1/4" x 1"	Square
A57420-00D	2 3/8" Backset deadlocking	2 1/4" x 1"	Square
A57421-000	2 3/8" Backset spring (101)	2 1/4" x 1"	Radius
A57421-00D	2 3/8" Backset deadlocking	2 1/4" x 1"	Radius
A57425-000	2 3/8" Backset spring (101)	2 1/4" x 1 1/8"	Square
A57425-00D	2 3/8" Backset deadlocking	2 1/4" x 1 1/8"	Square
A57620-000	2 3/8" Backset spring (301)	2 1/4" x 1"	Square
A57620-00D	2 3/8" Backset deadlocking (611)	2 1/4" x 1"	Square
A57621-000	2 3/8" Backset spring (301)	2 1/4" x 1"	Radius
A57621-00D	2 3/8" Backset deadlocking (611)	2 1/4" x 1"	Radius
A57625-000	2 3/8" Backset spring (301)	2 1/4" x 1 1/8"	Square
A57625-00D	2 3/8" Backset deadlocking (611)	2 1/4" x 1 1/8"	Square
A57430-000	2 3/4" Backset spring (101)	2 1/4" x 1"	Square
A57430-00D	2 3/4" Backset deadlocking	2 1/4" x 1"	Square
A57431-000	2 3/4" Backset spring (101)	2 1/4" x 1"	Radius
A57431-00D	2 3/4" Backset deadlocking	2 1/4" x 1"	Radius
A57435-000	2 3/4" Backset spring (101)	2 1/4" x 1 1/8"	Square
A57435-00D	2 3/4" Backset deadlocking	2 1/4" x 1 1/8"	Square
A57630-000	2 3/4" Backset spring (301)	2 1/4" x 1"	Square
A57630-00D	2 3/4" Backset deadlocking (611)	2 1/4" x 1"	Square
A57631-000	2 3/4" Backset spring (301)	2 1/4" x 1"	Radius
A57631-00D	2 3/4" Backset deadlocking (611)	2 1/4" x 1"	Radius
A57635-000	2 3/4" Backset spring (301)	2 1/4" x 1 1/8"	Square
A57635-00D	2 3/4" Backset deadlocking (611)	2 1/4" x 1 1/8"	Square

Note: Specify finish: 605, 612, 613 or 630.

Latches for B Series locks are UL listed.

2 3/4" backset standard. 2 3/8" optional.

Unless otherwise specified, we furnish a 2 1/4" x 1" x square corner faceplate on 2 3/8" backset latches and 2 1/4" x 1 1/8" x square corner on 2 3/4" backset latches.

A31727-005-00 link for 5" backset. For use with 2 3/8" backset latches.

Strikes and dustboxes

Strikes

Normally furnished with a 4 7/8" ANSI strike unless specified otherwise.

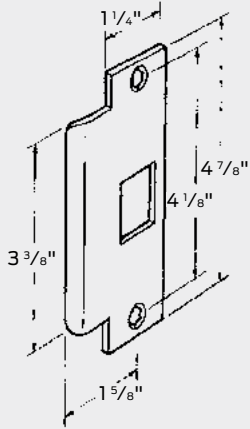

005164-000
ANSI Prep A115.2

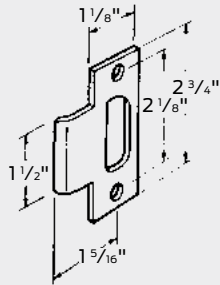

Q001-046
T-strike square corner

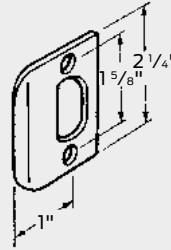

Q001-049
Full lip, square corner

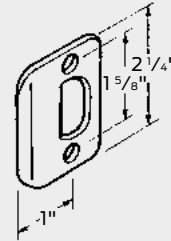

Q001-048
Full lip, 1/4" radius corner

*Specify finish: 605, 606, 612, 613, or 626.

Dust boxes



K510-066-PLA (EC 3604)
1" deep. May be used with any 4 7/8" high (ANSI) strike.



012191-003-70
1/2" deep. May be used with any 2 3/4" high (T) strike.

Function and trim style cross-reference

B Series grade 2 cylindrical key-in-lever

ANSI number/grade	Function	Falcon	Arrow	Stanley	Corbin/Russwin	Hager	Sargent	Yale
F75	Passage	B101	MLX01	QCL230	CL3810	3510	715	5301LN
F76	Privacy	B301	MLX02	QCL240	CL3820	3540	765	5302LN
F82	Entry	B501	MLX11	—	CL3861	3553	—	5304LN
F109	Entry/office	B511	—	QCL250/251	CL3851	3550	—	5307LN
F84	Classroom	B561	MLX17	QCL160/161	CL3855	3570	737	5308LN
F86	Storeroom	B581	MLX12	QCL270/271	CL3857	3580	704	5305LN
F90	Dormitory/corridor	B611	MLX19	QCL254/255	CL3875	—	—	5322LN
	Single dummy	B12	MLX08	QCL220	CL3850	3517	793	5355LN

Trim styles

Falcon	Arrow	Stanley	Corbin/Russwin	Sargent	Yale	Hager
Dane	Sierra	Sierra	NZD	KL	Augusta	Dane-Withnell
Quantum	Broadway	Summit	PZD	KP	Pacific Beach	Quantum-Archer

All effort has been made to make this information comprehensive. Since no two products are exactly alike, this data represents those products which are similar. This information was obtained from trade services and is not guaranteed nor meant to represent any product as equal to any other product.

How to order

For correct ordering, and to ensure no delays in shipment of your order, the following descriptive data must be listed in the sequence shown. Necessary information can be found in other parts of this catalog. The example below shows an order for 12 each B locksets in the 301 Privacy function, D (Dane) trim design in 626 (satin chrome) finish, with 2 3/4" backset latch, to accommodate doors 1 3/4" thick.

- **Quantity:** Indicate the quantity required.
- **Catalog number:** Select catalog number.
- **Trim design:** Indicate letter of lever design.
 - Example: D=Dane; Q=Quantum.
- **Finish:** When the finish is the same for the outside and inside trim, it is shown once (626). For split finishes, the outside is designated first, then the inside (605 x 625).
- **Latches:** 2 3/4" backset standard. 2 3/8" backset available. All latches are UL Listed 1 1/2 hour B Label.
- **Strikes:** 4 7/8" X 1 1/4" ANSI standard. Optional T-strike or full lip strike available. See page 68.
- **Cylinder type:** For 6-pin, add 6-pin.
- **Keying detail:** We suggest using the standard terms developed by A.H.C. (Architectural Hardware Consultants).
 - Example: AA1 - Grand master keyed, master keyed, change key 1.
- **Interchangeable core:** To order product capable of accepting an interchangeable core, add "FIC" (for interchangeable core). To order product with an interchangeable core, add "WIC" (with interchangeable core).
- **Keyways:** "G" is standard on regular cylinders, "A" is standard on interchangeable cores. Other keyways available. See page 66.
- **Additional keys:** Note the total number of keys required. Large bow keys: Add—"with large bow keys."

How to order example

Qty.	Catalog number	Trim design	Finish	Latch	Strike	Cylinder	Detail
12	B301S	Dan	626	Std	Std	-	2 3/4" backset - 1 3/4" door



W Series

Grade 2, medium-duty cylindrical lever and knob locks

Whether your application is government/military, retail, industrial or multi-family, there's a W Series lock that fits perfectly. With two popular lever and knob styles as well as two popular rose diameters (large and small), Falcon W Series can match most commercial door trim. The Falcon W Series locks feature conventional cylinders and small format interchangeable cores that are compatible with SFIC products from other manufacturers. Our conventional cylinders are available in all Falcon conventional key sections as well as Schlage C keyway, which we now masterkey across the complete Falcon product line. The Falcon W Series offers quality product at a value price, and is backed by one of the best names in the business - Allegion.

Features

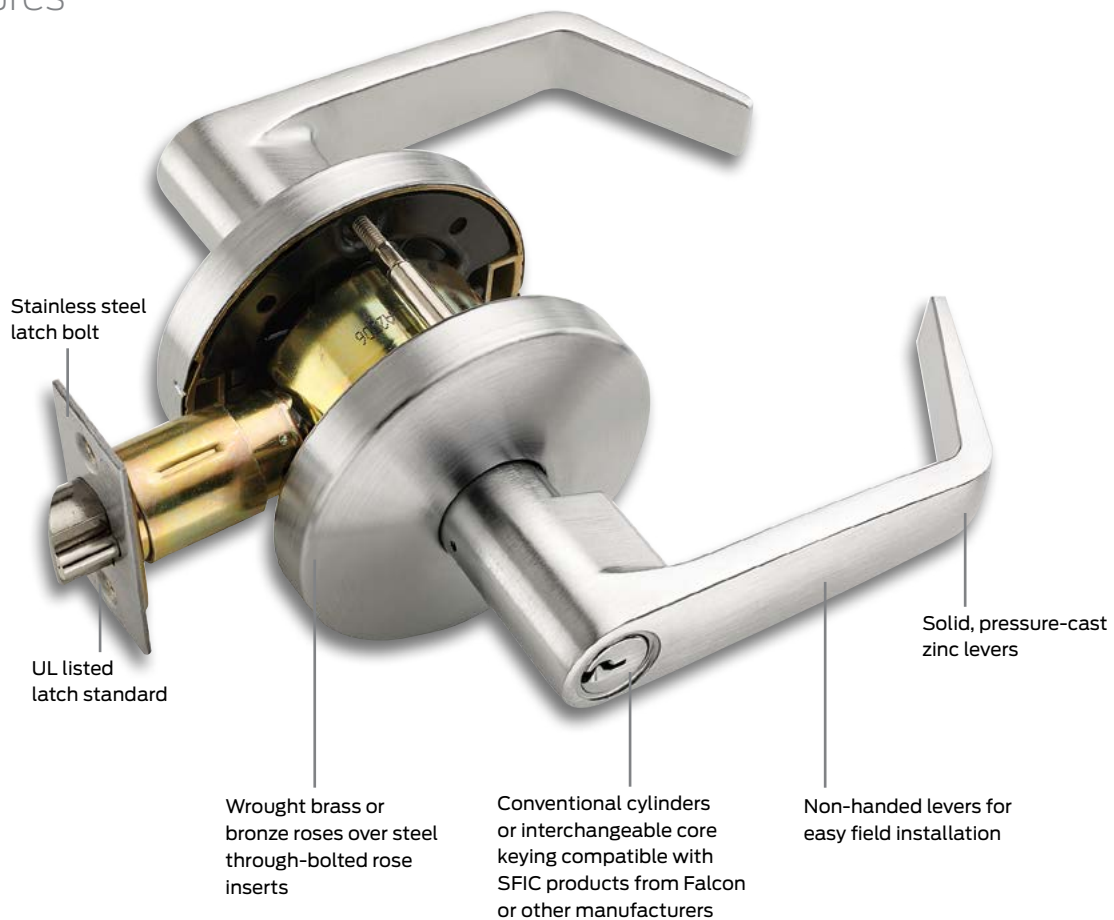

W Series

Features - standard rose

Door thickness: 1³/₈" to 1³/₄" standard.

Backset: 2³/₄" standard; 2³/₈" also available.

Mechanism: Parts constructed of brass or cold-formed steel, zinc plated and dichromated for rust resistance. Springs are stainless steel.

Attachment: Lock chassis secured to door by two screws which pass through a steel rose insert inside and thread directly into the outer rose-mounting assembly, and two screws that screw into the chassis assembly.

Handing: Locks are non-handed.

Cylinder: Pinning in six chambers. Cylinder assemblies removable to re-key. Also available with 6- or 7-pin interchangeable core cylinders. Cylinder housings and plugs machined from solid brass. Springs are stainless steel. Two nickel silver keys furnished standard.

Competitor cylinder: The W Series accepts standard 6-pin cylinders available from Falcon, as well as Schlage, Corbin-Russwin, Yale and Sargent.

Keyways: "G" keyway standard on Falcon standard cylinders. "A" keyway standard on I/C core cylinders. Also available with some optional keyways. Schlage "C" keyway also available on standard cylinders, includes master key. Master keying available on all Falcon and Schlage "C" keyways.

Trim: Roses are heavy wrought brass or bronze, installed over steel rose inserts which are through-bolted through door. Levers are pressure-cast zinc (solid levers-no-inserts) finished to match mating parts.

Latches: 1/2" bolt projection made of stainless steel and UL listed for 3-hour door assemblies. Latches have self-adjusting fronts to accommodate beveled or flat doors. 2³/₈" backset with 1" x 2¹/₄" latch faces or 2³/₄" backset with 1¹/₈" x 2¹/₄" latch faces.

Strikes: 4⁷/₈" x 1¹/₄" ANSI strike with curved lip to meet ANSI A115.2 door frame preparation standard. Consult Options and Accessories section for other available strikes, sizes and configurations.

Screws: Furnished with combination screws for use in wood or metal doors and frames.

ANSI/BHMA: Meets ANSI/BHMA A156.2, Series 4000, Grade 2.

UL: 3-hour A label.

Features - small rose

Door thickness: 1³/₈" to 1³/₄" standard.

Backset: 2³/₈", 2³/₄" standard.

Mechanism: Parts constructed of brass or cold-formed steel, zinc plated and dichromated for rust resistance. Springs are stainless steel.

Attachment: Lock chassis secured to door by two screws which pass through a steel rose insert inside and thread directly into the outer rose-mounting assembly, and two screws that screw into the chassis assembly.

Handing: Locks are non-handed.

Cylinder: Pinning in six chambers. Cylinder assemblies removable to re-key. Also available with 6- or 7-pin interchangeable core cylinders. Cylinder housings and plugs machined from solid brass. Springs are stainless steel. Two nickel silver keys furnished standard.

Competitor cylinder: The W Series accepts standard 6-pin cylinders available from Falcon, as well as Schlage, Corbin-Russwin, Yale and Sargent.

Keyways: "G" keyway standard on Falcon standard cylinders. "A" keyway standard on I/C core cylinders. Also available with some optional keyways. Schlage "C" keyway also available on standard cylinders, includes master key. Master keying available on all Falcon and Schlage "C" keyways.

Trim: Roses are heavy wrought brass or bronze, installed over steel rose inserts which are through-bolted through door. Levers are pressure-cast zinc (solid levers-no-inserts) finished to match mating parts.

Latches: 1/2" bolt projection made of stainless steel and UL listed for 3-hour door assemblies. Latches have self-adjusting fronts to accommodate beveled or flat doors. 2³/₄" backset with 1¹/₈" x 2¹/₄" latch faces.

Strikes: 4⁷/₈" x 1¹/₄" ANSI strike with curved lip to meet ANSI A115.2 door frame preparation standard. Consult Options and Accessories section for other available strikes, sizes and configurations.

Screws: Furnished with combination screws for use in wood or metal doors and frames.

ANSI/BHMA: Meets ANSI/BHMA A156.2, Series 4000, Grade 2.

UL: 3-hour A label.

W Series

Specifications

Key-in-lever cylindrical locksets shall be Falcon W Series or equal and meet the following requirements:

- All locks shall meet ANSI/BHMA A156.2, Series 4000, Grade 2 test requirements for key-in-lever locksets.
- Locksets shall be UL Listed 3-hour, A Label.
- Lever trim shall have individual heavy-duty springs for lever return and to prevent lever sag. Trim shall be through-bolted.
- All lever designs shall be solid (no inserts) and meet the federal ADA and state disability requirements.
- Locksets shall adjust to fit door thickness from $1\frac{3}{8}$ " to $1\frac{3}{4}$ ".
- All locksets shall be non-handed and not require field disassembly for re-handing.
- Preparation for door must be non-handed. Acceptable manufacturer: Falcon lock

Standard rose template

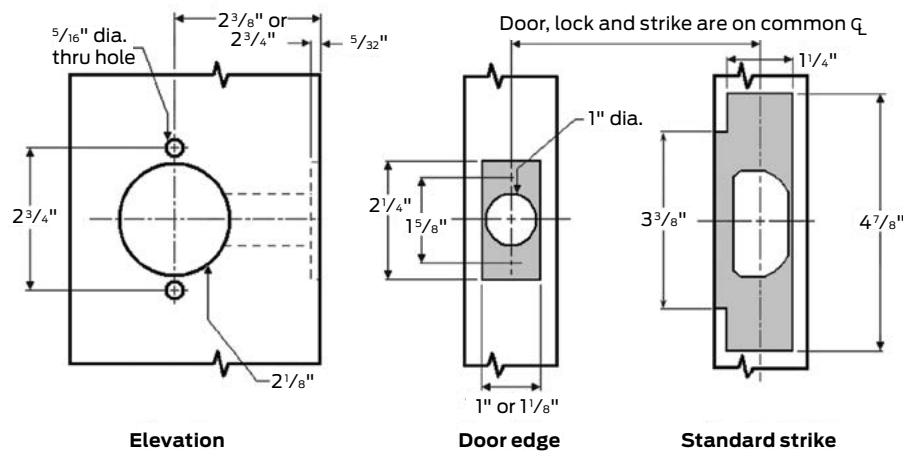

Small rose template

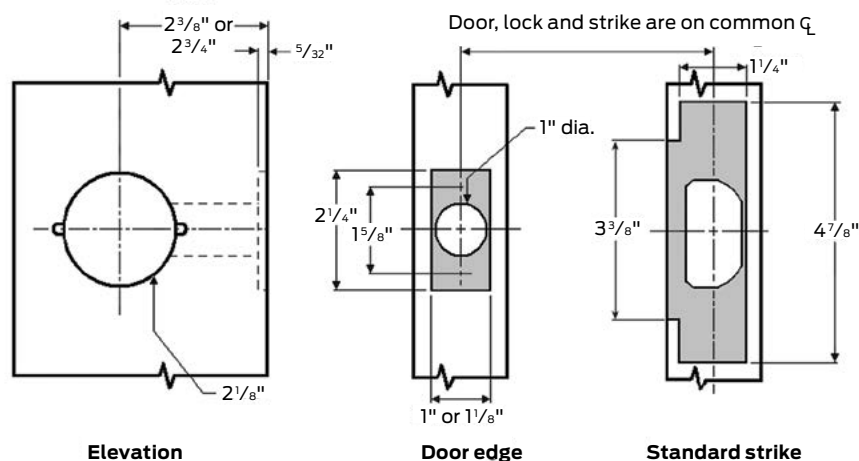

Levers styles

Levers are solid pressure cast zinc, finished to match mating parts. Roses are wrought brass or bronze installed over steel through-bolted rose inserts. A spring-loaded retainer secures levers. Secure side retainer cannot be depressed without a key that operates the lock.

Avalon (A)

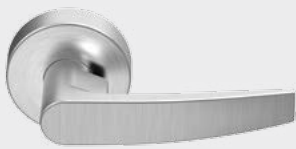

Dane (D)

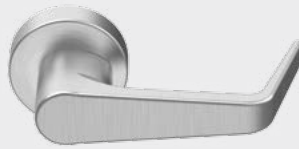

Quantum (Q)

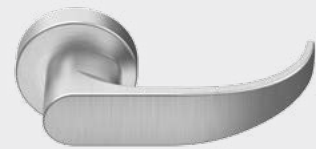

Boardwalk (BRK)*



Broadway (BRW)*



Latitude (LAT)*



Longitude (LON)*



Standard rose
Dane lever
shown

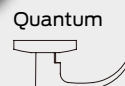

Small rose
Dane lever
shown

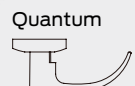

Abrasive lever options

Avalon, Dane, and Quantum levers are available with an abrasive strip along the length of the lever to identify entrances to areas hazardous to the disabled. To order add 6 (for example, 6DA for Dane lever or 6QU for Quantum lever) to the order number.

Trim finishes chart

Description	ANSI No.	Availability
Bright brass	605	All trim
Satin brass	606	Not on small rose
Oil rubbed bronze	613	All trim
Satin nickel	619	All trim
Matte black	622	All trim
Bright chrome	625	All trim
Satin chrome	626	All trim
Aged bronze	643e	All trim

* Available in Q1 2017

Knob styles

Knobs are constructed of brass or cold-formed steel and are zinc-plated and dichromated for rust resistance. Springs are stainless steel. Roses are heavy-wrought brass or bronze, installed over wrought steel reinforcing plates. Knobs are brass or bronze, secured by a steel knob retainer, which cannot be depressed when lock has been locked.

Cointurn
Elite shown



Cylinder
Elite shown



Interchangeable core
Elite shown



Plain
Hana shown



Pushbutton (interior)
Hana shown



Thumbturn (interior)
Hana shown



Elite

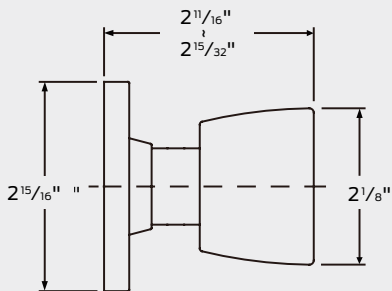



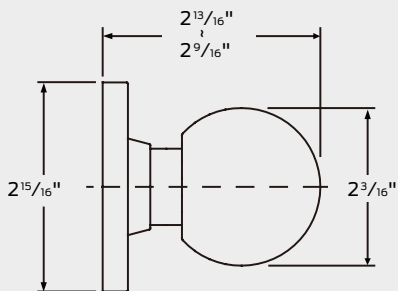



Hana

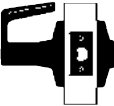

Trim finishes chart

Description	ANSI No.	Availability
Bright brass	605	All trim
Satin brass	606	Not on small rose
Oil rubbed bronze	613	All trim
Bright chrome	625	All trim
Satin chrome	626	All trim

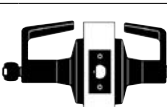
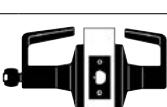

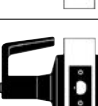
Lever functions

Catalog number	Function	Name	Description	ANSI no.
*W101		Passage/ closet set	Latch bolt by levers at all times.	F75
*W161		Communicating/ exit lock	Deadlocking latch bolt by inside lever. Non-removable blank plate outside. Inside lever is always free.	
W201		Patio lock	Deadlocking latch bolt by levers. Outside lever is locked by push button from inside. Rotating inside lever or closing door releases button and unlocks outside lever.	F77
*W301		Privacy lock	Latch bolt by levers. Outside lever is locked by push button on inside lever. Rotating inside lever or closing door releases push button and frees outside lever. Inside lever is always free. Emergency release in outside lever unlocks door.	F76
W501		Entry lock	Push button locking. Button on inside locks outside lever until unlocked by key or by rotating inside lever. Closing door release push button and unlocks door. Inside lever always free. Deadlock latchbolt.	F82
*W511		Entry/office lock	Deadlocking latch bolt by levers. Turn/push button locking. Pushing and turning button locks outside lever, requiring use of a key for unlocking the door until button is manually unlocked. Pushing button locks outside lever until unlocked by key or by rotating inside lever. Inside lever is always free.	F109
*W561		Classroom lock	Deadlocking latch bolt by levers. Outside lever is locked by key in outside lever. Inside lever is always free.	F84
*W571		Corridor lock	Deadlocking latch bolt. Push Button Locking. Button on the inside locks outside lever until unlocked by key or by rotating inside lever. Closing the door releases button. Inside lever always free. ¹	
*W581		Storeroom lock	Deadlocking latch bolt by lever inside or key outside. Outside lever is always locked. Inside lever is always free.	F86
W711		Apartment entrance lock	Deadlocking latch bolt by levers. Turn/push button locking. Pushing and turning button locks outside lever, requiring use of a key for unlocking the door until button is manually unlocked. Pushing button locks outside lever until unlocked by key, by rotating inside lever, or by closing the door. Inside lever is always free.	
*W12		Single dummy	Single trim, surface-mounted rigid lever.	
*W18		Double dummy	Double trim, surface-mounted rigid levers.	

* Available as small rose

¹ This lock will unlock when the door is closed. If you want your door to remain locked when it closes, please purchase the 501 function.

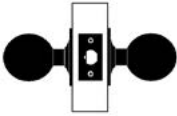
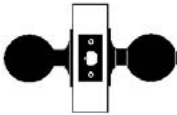
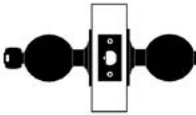
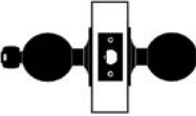
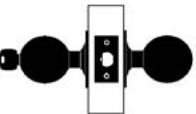
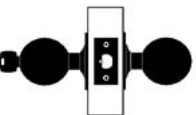
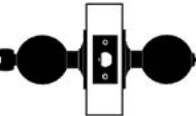
Knob functions

Catalog number	Description	Description	ANSI no.
W101	 Passage/closet set	Latch bolt by knob at all times.	F75
W301	 Privacy lock	Latch bolt by knobs. Outside knob is locked by push button on inside knob. Rotating inside knob or closing door releases push button and frees outside knob. Inside knob is always free. Emergency release in outside knob unlocks door.	F76
W501	 Entry lock	Push button locking. Button on inside locks outside knob until unlocked by key or by rotating inside knob.	F82
W511	 Entry/office lock	Deadlocking latch bolt by knobs. Turn/push button locking. Pushing and turning button locks outside knob, requiring use of a key for unlocking the door until the button is manually unlocked. Pushing button locks outside knob until unlocked by key or by rotating inside knob. Inside knob is always free.	F109
W561	 Classroom lock	Deadlocking latch bolt by knobs. Outside knob is locked by key in outside knob. Inside knob is always free.	F84
W571	Corridor lock	Deadlocking latch bolt. Push button locking. Button on the inside locks outside lever until unlocked by key or by rotating inside lever. Closing the door releases button. Inside lever always free. ¹	
W581	 Storeroom lock	Deadlocking latch bolt by knobs. Outside knob is always locked. Inside knob is always free.	F86
W711	 Apartment entrance lock	Deadlocking latch bolt by knobs. Turn/push button locking. Pushing and turning button locks outside knob, requiring use of a key for unlocking the door until the button is manually unlocked. Pushing button locks outside knob until unlocked by key, by rotating inside knob, or by closing the door. Inside knob is always free.	
W12	 Single dummy	Single trim, surface-mounted rigid knob.	

¹ This lock will unlock when the door is closed. If you want your door to remain locked when it closes, please purchase the 501 function.

Cylinders and competitor keyways

Falcon standard cylinders - 6-pin

Catalog number	Description
Q330-154	Falcon (specify keyway)
Q330-155	Falcon (for W561)

Note: Specify finish: 606 or 626
Specify keyway: G (standard), H, K, L, N, P

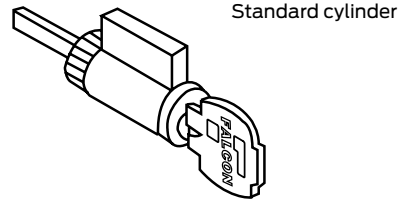

Standard cylinder

Falcon interchangeable core

Catalog number	Description
C606 (6-pin), C607 (7-pin)	For use in all I/C keyed locks (cover style)
CB806 (6-pin), CB807 (7-pin)	For use in all I/C keyed locks (cap style)

Note: Specify finish: 606 or 626
Specify keyway: A (standard) or other keyway

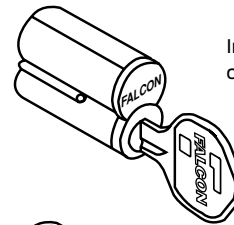

Interchangeable core cover style

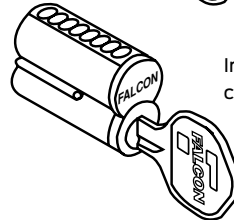

Interchangeable core cap style

Standard cylinders with other keyways - 6-pin

Catalog number	Description
Q330-152	Schlage C
Q330-153	Schlage C for W561
Q330-166	Corbin 60 (0 bit or KD only)
Q330-167	Corbin 60 (0 or KD only) for W561
Q330-210	Russwin D1 (0 bit or KD only)
Q330-211	Russwin D1 (0 bit or KD only) for W561
Q330-158	Cor/Russ L4 (0 bit or KD only)
Q330-159	Cor/Russ L4 (0 bit or KD only) for W561
Q330-160	Sargent LA (0 bit or KD only)
Q330-161	Sargent LA (0 bit or KD only) for W561
Q330-164	Tailpiece for Q330-154 Falcon and Schlage cylinders (All other functions)
Q330-165	Tailpiece for Q330-155 Falcon and Schlage cylinders (W 561 function only)
Q330-168	Tailpiece for SFIC (All functions)
Q330-156	Yale 8 (0 bit or KD only)
Q330-169	Tailpiece for W Lock knobs — SFIC

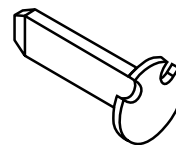

Q330-164
Conventional cylinder tailpiece

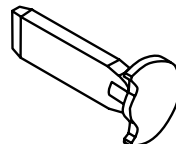

Q330-165
Conventional cylinder tailpiece W561

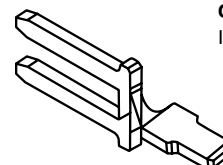

Q330-168
IC core tailpiece

Note: Construction keying available. Reference page 101 for more information.

Latches and strikes

Latches

- Latches for W Series locks are 3-hour UL listed
- 2 3/4" backset standard, 2 3/8" backset optional
- Unless otherwise specified we furnish a 1" x 2 1/4" square corner faceplate on 2 3/8" backset latches, and a 1 1/8" x 2 1/4" square corner faceplate on 2 3/4" backset latches

1/2" Projection, UL listed, stainless steel bolt

Catalog number	Description (functions)	Faceplate size	Corner
Q330-192	2 3/4" backset dead locking (201, 711, 501)	1" x 2 1/4"	Square
Q330-193	2 3/4" backset dead locking (201, 711, 501)	1" x 2 1/4"	Radius
Q330-194	2 3/4" backset dead locking (201, 711, 501)	1 1/8" x 2 1/4"	Square
Q330-195	2 3/4" backset dead locking	1" x 2 1/4"	Square
Q330-196	2 3/4" backset dead locking	1" x 2 1/4"	Radius
*Q330-197	2 3/4" backset dead locking	1 1/8" x 2 1/4"	Square
Q330-198	2 3/8" backset dead locking (201, 711, 501)	1" x 2 1/4"	Square
Q330-199	2 3/8" backset dead locking (201, 711, 501)	1" x 2 1/4"	Radius
*Q330-200	2 3/8" backset dead locking (201, 711, 501)	1 1/8" x 2 1/4"	Square
Q330-201	2 3/8" backset dead locking	1" x 2 1/4"	Square
Q330-202	2 3/8" backset dead locking	1" x 2 1/4"	Radius
*Q330-203	2 3/8" backset dead locking	1 1/8" x 2 1/4"	Square
Q330-204	2 3/4" backset spring latch	1" x 2 1/4"	Square
Q330-205	2 3/4" backset spring latch	1" x 2 1/4"	Radius
*Q330-206	2 3/4" backset spring latch	1 1/8" x 2 1/4"	Square
Q330-207	2 3/8" backset spring latch	1" x 2 1/4"	Square
Q330-208	2 3/8" backset spring latch	1" x 2 1/4"	Radius
*Q330-209	2 3/8" backset spring latch	1 1/8" x 2 1/4"	Square

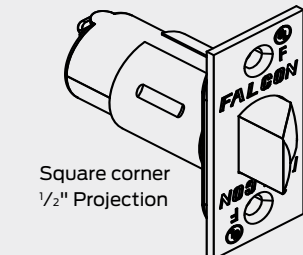
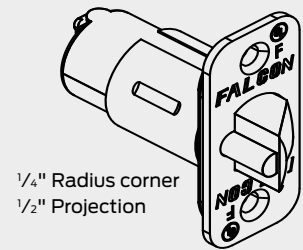

*Available as small rose

Strikes

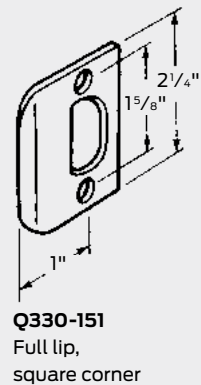
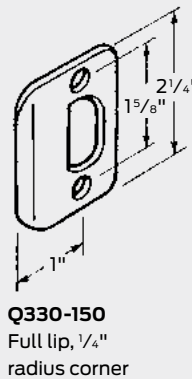
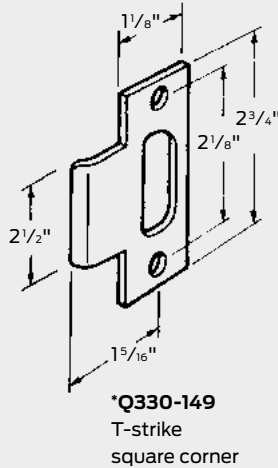
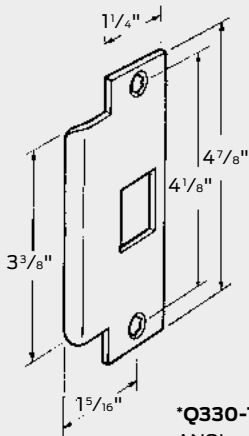

*Available as small rose

Function and trim style cross-reference

W Series grade 2 cylindrical

ANSI number/grade	Function	Falcon	Arrow	Corbin/Russwin	Dorma	Hager	Yale
F75	Passage	W101	RL/RLX/MLX01	CL3810	CL710	2510	4601LN
F111	Comm/exit	W161	RL03	—	CL725	—	4628LN
F77	Patio	W201	—	CL3840	CL730	—	—
F76	Privacy	W301	RL/RLX/MLX72	CL3820	CL740	2540	4602LN
F109	Entry/office	W511	—	CL3851	CL753	2550	4607LN
F84	Classroom	W561	RL/RLX/MLX17	CL3855	CL770	2570	4607LN
F86	Storeroom	W581	RL/RLX/MLX12	CL3851	CL780	2580	4605LN
	Apartment entry	W711	—	—	—	—	—
	Single dummy	W12	RL/RLX/MLX08	CL3850	CL701	2517	4655LN
F82	Entry	W501	RL/RLX/MLX11	CL3861	CL750	2553	4604LN

Trim styles

Falcon	Arrow	Yale	Corbin/Russwin	Dorma	Hager
Dane	Sierra	Augusta	NZD	LR	Withnell
Quantum	Broadway	Pacific Beach	PZD	LC	Archer
Avalon	—	Monroe	—	LG	—
Boardwalk	—	—	—	—	—
Broadway	—	—	—	—	—
Latitude	—	—	—	—	—
Longitude	—	—	—	—	—
Hana	Ball	—	—	—	—
Elite	—	Carolina	—	—	—

All effort has been made to make this information comprehensive. Since no two products are exactly alike, this data represents those products which are similar. This information was obtained from trade services and is not guaranteed nor meant to represent any product as equal to any other product.

How to order

For correct ordering and to ensure no delays in shipment of your order, the following descriptive data must be listed in the sequence shown. Necessary information can be found in other parts of this catalog. The example to the right shows an order for 12 each W locksets in the 581 storeroom function, QUA (Quantum) trim design in a 626 (satin chrome) finish, with a 2 3/4" backset latch, to accommodate doors 1 3/4" thick.

- **Quantity:** Indicate the quantity required.
- **Catalog number:** Select function number, cylinder type, and latch style from tables in this section.
- **Trim design:** Indicate letter of lever design. DAN = Dane; QUA = Quantum; ELI = Elite; HAN = Hana. If Falcon W Series small rose is required, specify SR = Small Rose. Outside design always precedes inside design on split designs. If adding an abrasive lever option, add 6 to design code (example 6DAN).
- **Finish:** When the finish is the same for the outside and inside trim, it is shown once (626). Outside finish always precedes inside finish on split finishes (605 x 625).
- **Latches:** 2 3/4" backset is standard. 2 3/8" backset available. All latches are UL listed 3-hour A label.
- **Strikes:** 4 7/8" x 1 1/4" ANSI standard. For other options, see page 84.
- **Cylinder type:** 6-pin.
- **Keying detail:** We suggest using the standard terms developed by DHI (Door and Hardware Institute) or ALOA (Associated Locksmiths of America).
 - Example: AA1 - Grand Master keyed, Master keyed, change key 1.
- **Interchangeable core:** To order product capable of accepting an interchangeable core, add suffices from the keying table to the function number, preceding the latch style.
 - Example: W511HD will be supplied with SFIC keyed construction core.
- **Keyways:** "G" is standard on regular cylinders. "A" is standard on interchangeable cores. Other keyways available. See page 79.
- **Additional keys:** Note the total number of keys required.
- **Large bow keys:** Add—"with large bow keys" under additional details.

How to order example

Line item	Qty.	Product	Outside		Inside		Hand	Latch	Strike	Door thickness	Ext.	DIM	Additional details/keying
			Des	Fin	Des	Fin							
1	12	W581D	QUA	626			RHR	30-197	30-149	1 3/4"			

H2 Series

Grade 2 interconnected
lever and knob locks

Falcon is committed to delivering a solid product at a solid price. The H2 Series interconnected lock is Falcon's newest offering, featuring single motion egress to meet the latest Life and Safety code requirements.

The H2 Series is BHMA Grade 2 certified and is available in multiple finishes and lever styles for cohesive styling/pairing with other Falcon products.

The H2 Series is designed for multi-family and public restroom applications requiring a durable, robust commercial interconnect lock.

Features

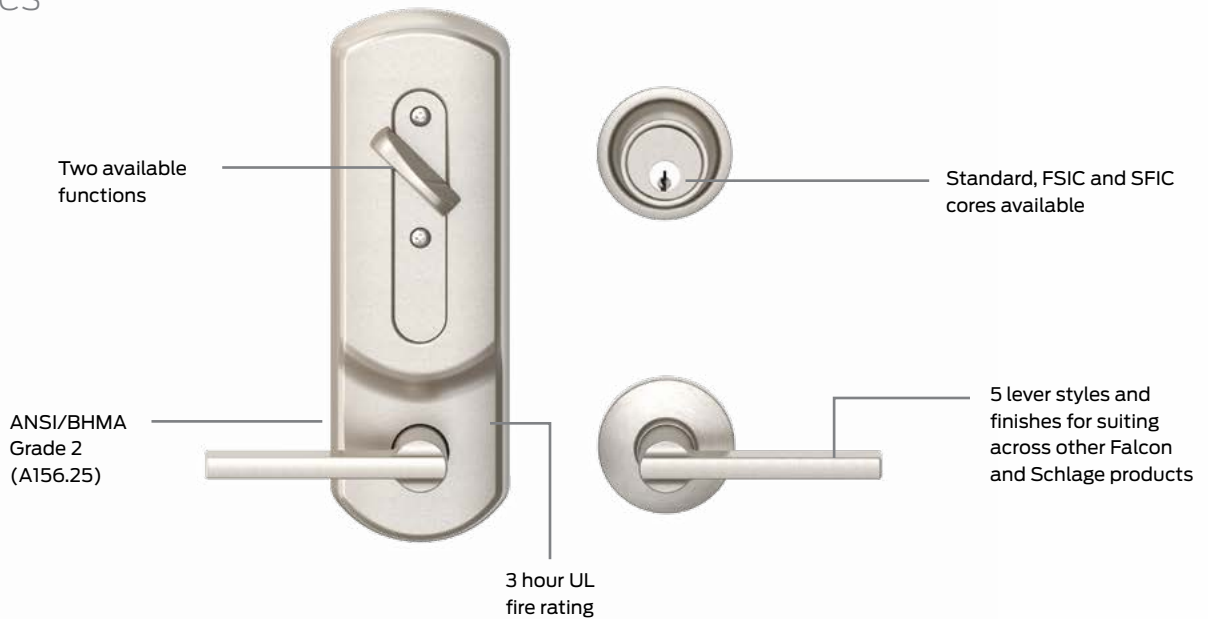

H2 Series

Features

Door thickness: 1 3/4" - 2" door range standard; 1 3/8" available

Backset: 2 3/4" standard, 2 3/8" also available.

Attachment: Outer trims secured to the door by thru-bolts through a steel plate on the inside of the door. Inside escutcheon conceals mounting screws.

Handing: Specify hand of door when ordering. Field reversible.

Cylinders: "G" keyway standard. Drilled in 6 chambers, pinned in 5. Pinning in 6 chambers available when specified. Also available with 6 or 7-pin interchangeable core cylinders in H2101 function only.

Trim: Roses are wrought brass, bronze or stainless steel, installed over wrought steel reinforcing plates. Knobs are brass, bronze or stainless steel secured by steel knob retainer which cannot be depressed when lock has been locked.

Latches: 1/2" projection, deadbolt has 1" projection with 1/4" hardened steel security roller. 2 3/4" backset with 2 1/4" x 1 1/8" latchface. 2 3/8" backset with 2 1/4" x 1" latchface. Other latchfaces available.

Strikes: (1) 2 3/4" x 1 1/8" T-strike and (1) 2 3/4" x 1 1/8" lipless strike.

Mechanism: Cold formed steel, zinc plated and dichromated for rust resistance.

Certification: UL Listed 1 1/2 Hour B Label. Lever-style trim complies with Title 19, California State Fire Marshal and all ADA and barrier-free codes.

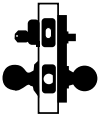
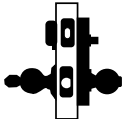
Catalog number	Function	Description	ANSI no.
H2101	 Entry single locking	Deadbolt operated by key from outside or by turn from inside. Bolt automatically deadlocks when fully thrown. Latch retracted by lever from either side. Turning inside lever retracts deadbolt and latch simultaneously for immediate exit.	F94
H2171	 Public bathroom w/occupancy indicator	Deadbolt operated by turn from inside only. Occupancy indicator on outside. Bolt automatically deadlocks when fully thrown. Latch retracted by lever from either side. Turning inside lever retracts deadbolt and latch simultaneously for immediate exit. Not UL rated.	

Lever styles

Most levers can be suited with other Falcon locks and exit device trim. Levers also suite with Schlage residential lever designs, making the Falcon H2 Series perfect for multi-family applications.

Avalon (A)



Dane (D)



Flair (FLA)



Latitude (LAT)



Quantum (Q)



Trim finishes chart

Description	ANSI No.	Availability
Bright brass	605	All trim
Satin nickel	619	All trim
Matte black	622	All trim
Satin chrome	626	All trim
Aged bronze	643e	All trim

Deadbolts

1" projection, standard

Standard deadbolts for H2 Series locks are non-UL listed. Available in $2\frac{3}{8}$ " or $2\frac{3}{4}$ " backsets.

Unless otherwise specified, we furnish a $2\frac{1}{4}$ " x 1" square- corner faceplate on $2\frac{3}{8}$ " backset deadbolts and $2\frac{1}{4}$ " x $1\frac{1}{8}$ " x square corner on $2\frac{3}{4}$ " backset deadbolts.

*Optional UL deadbolt available, except on drive-in deadbolts.

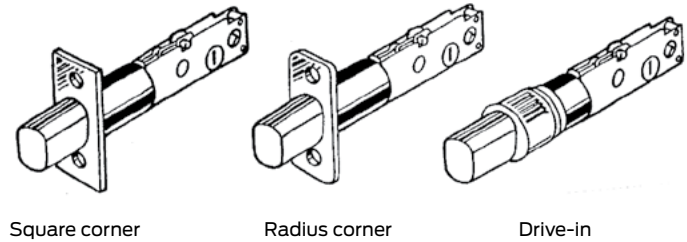

Deadbolts for H2 Series - (except for double cylinder deadlock function and upper trim)

Catalog number	Description	Faceplate size	Corner
A74420-000	$2\frac{3}{8}$ " Backset dead bolt	$2\frac{1}{4}$ " x 1"	Square
A74421-000	$2\frac{3}{8}$ " Backset dead bolt	$2\frac{1}{4}$ " x 1"	Radius
A74425-000	$2\frac{3}{8}$ " Backset dead bolt	$2\frac{1}{4}$ " x $1\frac{1}{8}$ "	Square
A76429-000	$2\frac{3}{8}$ " Backset dead bolt	Drive-in	Round
A74430-000	$2\frac{3}{4}$ " Backset dead bolt	$2\frac{1}{4}$ " x 1"	Square
A74431-000	$2\frac{3}{4}$ " Backset dead bolt	$2\frac{1}{4}$ " x 1"	Radius
A74435-000	$2\frac{3}{4}$ " Backset dead bolt	$2\frac{1}{4}$ " x $1\frac{1}{8}$ "	Square
A76439-000	$2\frac{3}{4}$ " Backset dead bolt	Drive-in	Round

Deadbolts for H2 Series - double cylinder deadlock function only

Catalog number	Description	Faceplate size	Corner
A84420-000	$2\frac{3}{8}$ " Backset dead bolt	$2\frac{1}{4}$ " x 1"	Square
A84421-000	$2\frac{3}{8}$ " Backset dead bolt	$2\frac{1}{4}$ " x 1"	Radius
A84425-000	$2\frac{3}{8}$ " Backset dead bolt	$2\frac{1}{4}$ " x $1\frac{1}{8}$ "	Square
A86429-000	$2\frac{3}{8}$ " Backset dead bolt	Drive-in	Round
A84430-000	$2\frac{3}{4}$ " Backset dead bolt	$2\frac{1}{4}$ " x 1"	Square
A84431-000	$2\frac{3}{4}$ " Backset dead bolt	$2\frac{1}{4}$ " x 1"	Radius
A84435-000	$2\frac{3}{4}$ " Backset dead bolt	$2\frac{1}{4}$ " x $1\frac{1}{8}$ "	Square
A86439-000	$2\frac{3}{4}$ " Backset dead bolt	Drive-in	Round

Specify finish: 606, 613, 626 or 630.

Strikes, dust boxes and cam locks

Strikes

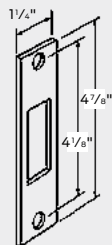

030020-000
ANSI Strike

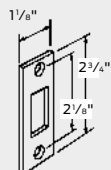

010018-001
Lipless strike

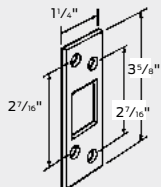

030290-000
T-strike or security

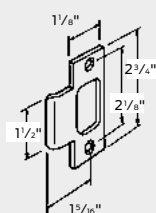

005075-000
T-strike,
square corner

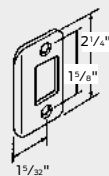

005051-000
Full lip,
square corner

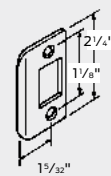

005051-001
Full lip,
1/4 radius corner

Dust boxes

B500-622

Metal dustbox reinforcer for 10-094 strike.

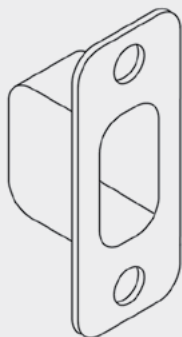

Mounted samples



Individual mounted lock samples are available in auxiliary locks. Mounted locks are fully operative, thus demonstrating their individual features. Light and portable, they may be easily carried for on-site demonstrations.

Cam locks

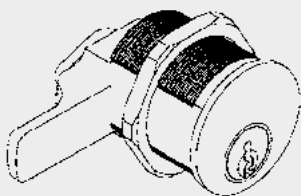

Lazy action operation:

1. Key rotates cam 90°.
2. Set screw limits cam rotation to 90°
3. Key removable in locked or unlocked position.

945 Standard cylinder cam lock

Cam lock for cabinet doors up to 3/4" thick. Large cam measures 1 1/2" center-to-end. Provided with two cam drivers to allow for rigid cam or lazy cam operation. Lock is field-reversible for right hand or left hand doors.

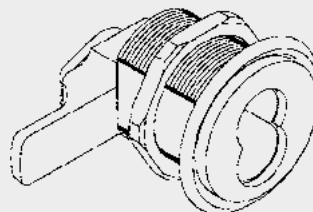

Rigid driver operation:

1. Key rotates cam 360°.
2. Set screw limits cam rotation if required.
3. Key removable in locked position only.

C945 SFIC (less core) cam lock

Cylinders: Furnished with solid brass plug and housing drilled with 6-pin chambers, pinned in 5 unless otherwise specified. Available with 6- or 7-pin interchangeable cores. Furnished with two (2) nickel silver keys standard.

Keyways: "G" keyways standard on standard cylinders. "A" keyway standard on I/C core cylinders.

How to order

For correct ordering, and to ensure no delays in processing of your order, the following descriptive data should be listed in the sequence shown. Necessary information can be found in other parts of this catalog. The example below shows an order for 20 each H2 locksets in the 101 Entry function, in a 626 (satin chrome) finish, to accommodate doors 1 3/4" thick with AA1- AA20 keying.

- **Quantity:** Indicate the quantity required.
- **Catalog number:** Select function number.
- **Cylinder type:** P = conventional cylinder, L=prepped for conventional cylinder, but less cylinder, B=prepped for SFIC, but less cylinder, BB=with Best style capped core, BDC=with disposable construction core, G=with Falcon slide cap core, H=with keyed construction core.
- **Finish:** When the finish is the same for the outside and inside trim, it is shown once (626). Outside finish always precedes inside finish on split finishes (605 x 625).
- **Bolt:** Standard deadbolts for H2 Series locks are non-UL listed. Available in 2 3/8" or 2 3/4" backsets.
- **Latches:** 2 3/4" backset is standard. 2 3/8" backset available. All latches are UL listed 3-hour A label.
- **Strike:** 2 3/4" x 1 1/8" lipless standard. Optional ANSI, T-strike, full lip strikes or security strike available.
- **Cylinder type:** For 6-pin, add 6-pin. For 7-pin, add 7-pin. 7-pin conventional cylinder is not available on the H Series.
- **Door hand:** Not required. All other locks are fully reversible.
- **Keying detail:** We suggest using the standard terms developed by the A.H.C. (Architectural Hardware Consultants).
 - Example: AA1 - Grand Master keyed, Master keyed, change key 1.
- **Interchangeable core:** Specify for 6 or 7 pin if ordering prepped for interchangeable core (SFIC). BD6 or BD7, GD6 or GD7, BB6 or BB7.
- **Keyways:** "G" is standard on regular cylinders. "A" is standard on interchangeable cores. Other keyways available. Please consult factory.
- **Additional keys:** Note the total number of keys required.
- **Large bow keys:** Add—"with large bow keys" under additional details.

How to order example

Qty.	Catalog number	Trim design	Finish	Latch	Strike	Cylinder	Detail
20	H2101	FLA	626	STD	STD	6-pin	AA1-AA20 1 3/4" DR

D Series

Grade 1 and Grade 2 deadbolts

Deadbolt locks provide an extra measure of protection against break-in when used as a supplement to an existing lockset. In applications ranging from military and government projects to multi-family housing, retail and restaurants, Falcon deadbolts deliver superior performance and the flexibility of multiple keying systems. Our full line of Grade 1 and 2 auxiliary locks feature interchangeable cores that are compatible with SFIC products from other manufacturers. Plus they're backed by Allegion, the best name in the business.

Features

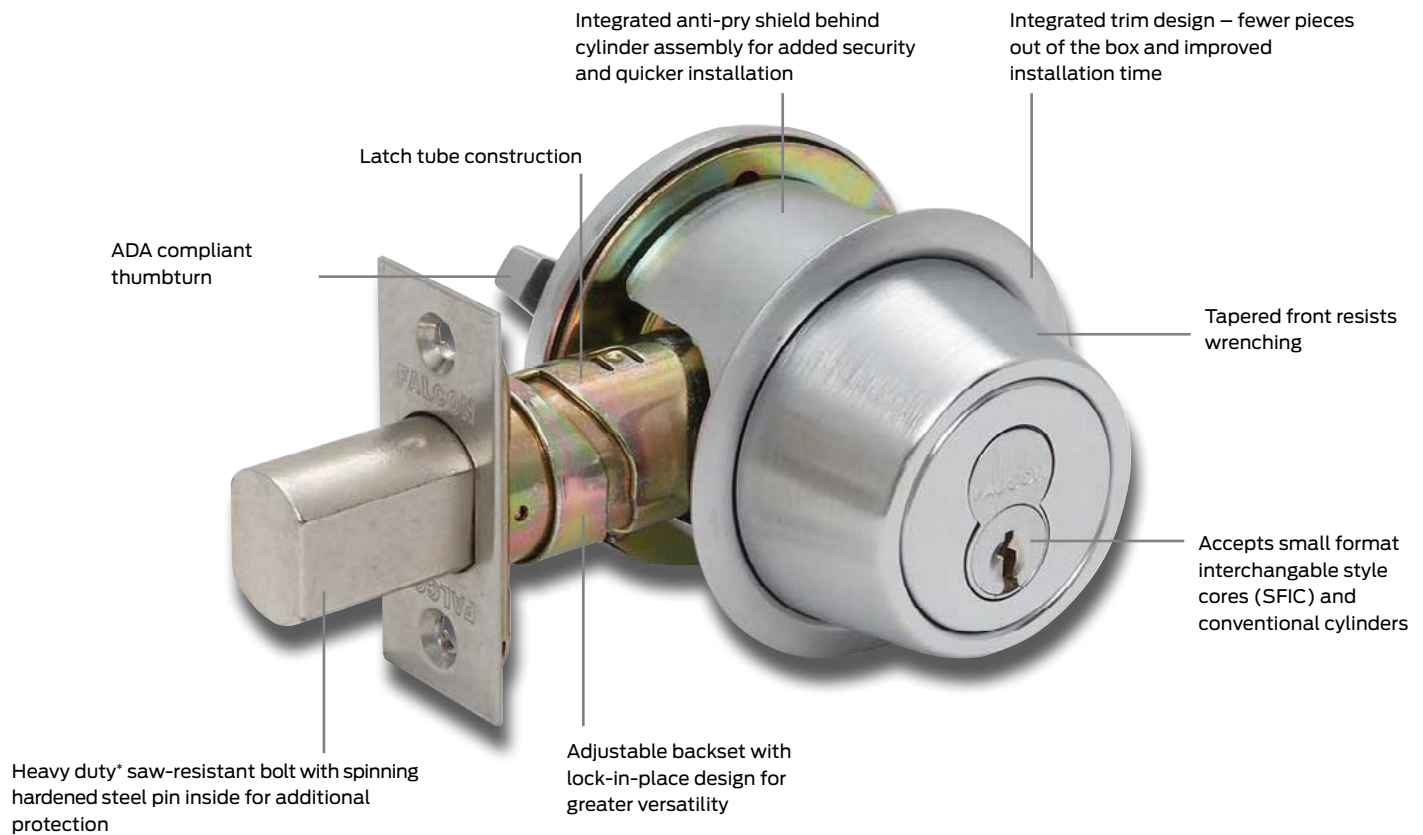

*Grade 1 - High strength steel - powdered
Grade 2 - Zinc

D100 Series

Grade 1, heavy-duty deadbolts

Features

Door thickness: 1³/₈" to 1³/₄" Up to 2¹/₄" door thickness also available.

Backsets: 2³/₈" - 2³/₄" adjustable deadbolt.

Attachment: Locks are solidly attached to the door by 1/4" heat-treated steel bolts. These bolts pass through a steel plate (D111, D121 and D141) or the inner cylinder housing (D131) and thread directly into the back of the outer cylinder housing.

A permanent cap is inserted over the inside cylinder (D131) making the bolts nearly impossible to remove.

Handing: Non-handed. May be used on right hand or left hand doors swinging in or out.

Cylinders: Furnished with solid brass plug and housing, drilled with 6-pin chambers, pinned in 5 unless otherwise specified. Also available with 7-pin cylinders. Available with 6 or 7-pin interchangeable cores. Furnished with two (2) nickel silver keys standard.

Keyways: "G" keyway standard on conventional cylinders. "A" keyway standard on I/C core cylinders. Also available with some optional keyways.

Exposed trim: Wrought brass or bronze reinforced with steel insert.

Deadbolts: Deadbolt locks are furnished with deadbolts which have a full 1" projection. Housed within the deadbolt is a free-turning, 1/4" thick, hardened steel, saw-resistant roller. Furnished standard with 2³/₈" - 2³/₄" adjustable backset and 1¹/₈" x 2¹/₄" faceplate. Optional 1" x 2¹/₄" faceplate. Consult Options and Accessories section for other optional faceplates. D100 bolt is high strength steel.

Strikes: 2³/₄" x 1¹/₈" lipless strike standard. ANSI 4 7/8" x 1¹/₄" lipless, 2¹/₄" full lip strikes, a 2³/₄" x 1¹/₈" T-strike or a security strike are available. Consult options and accessories section.

Screws: Furnished with wood/machine screws for use on wood or metal doors or frames.

ANSI/BHMA Standard: A156.5, 2001, Grade 1.

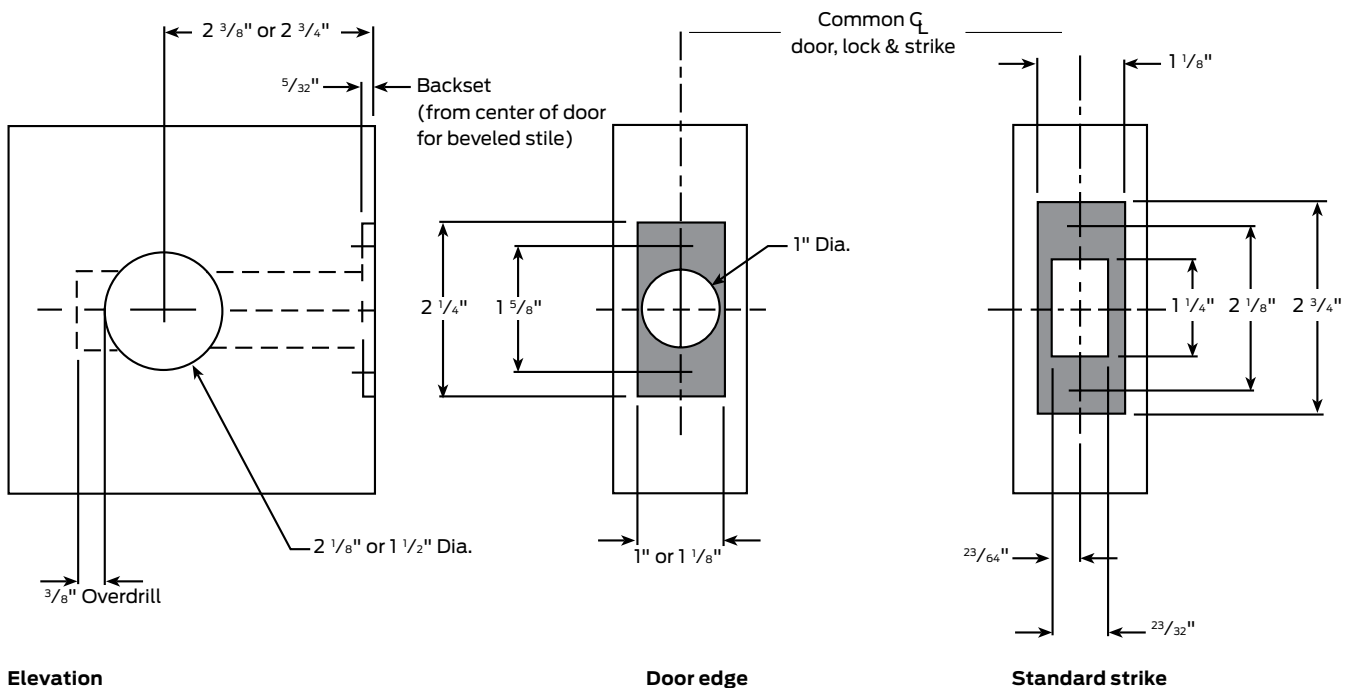

D100 Series styles

Classroom deadbolt (schoolhouse safety)

Deadbolt thrown or retracted by key from outside. Inside turn will only retract bolt. Bolt automatically deadlocks when fully thrown.

ANSI/BHMA E0171



Single cylinder deadbolt

Deadbolt thrown or retracted by key only. Blank plate inside. Bolt automatically deadlocks when fully thrown.

ANSI/BHMA E0161



Double cylinder deadbolt

Deadbolt thrown or retracted by key from either side. Bolt automatically deadlocks when fully thrown.

ANSI/BHMA E0141



Single cylinder deadbolt with turn

Deadbolt thrown or retracted by key or by turn. Bolt automatically deadlocks when fully thrown.

ANSI/BHMA E0151



Trim finishes chart

Description	ANSI No.	Available on
Bright brass	605	All trim
Satin brass	606	All trim
Oil rubbed bronze	613	All trim
Bright chrome	625	All trim
Satin chrome	626	All trim

D200 Series

Grade 2, medium-duty deadbolts

Features

Door thickness: 1³/₈" to 1⁷/₈". For thicker doors, available up to 2¹/₄".

Backsets: 2³/₈"- 2³/₄" adjustable deadbolt.

Attachment: Locks are solidly attached to the door by 1/4" heat-treated steel bolts. These bolts pass through a steel plate (D211, D221 and D241) or the inner cylinder housing (D231) and thread directly into the back of the outer cylinder housing.

Handing: Non-handed. May be used in right hand or left hand doors swinging in or out.

Cylinders: Furnished with solid brass plug and housing, drilled with 6-pin chambers, pinned in 5 unless otherwise specified. Available with 6 or 7-pin interchangeable cores. Furnished with two (2) nickel silver keys standard.

Keyways: "G" keyway standard on conventional cylinders. "A" keyway standard on I/C core cylinders. Also available with some optional keyways.

Exposed trim: Wrought brass or bronze reinforced with steel insert.

Deadbolts: Deadbolt locks are furnished with deadbolts which have a full 1" projection. Housed within the deadbolt is a free-turning, 1/4" thick, hardened steel, saw-resistant roller. Furnished standard with 2³/₈"- 2³/₄" adjustable backset and 1¹/₈" x 2¹/₄" faceplate. Optional 1" x 2¹/₄" faceplate. Consult Options and Accessories section for other optional faceplates. D200 bolt is cast zinc.

Strikes: 2³/₄" x 1¹/₈" lipless standard. ANSI 4⁷/₈" x 1¹/₄" lipless, 2¹/₄" full lip strikes, a 2³/₄" x 1¹/₈" T-strike or a security strike are available. Consult Options and Accessories section.

Screws: Furnished with wood/machine screws for use on wood or metal doors or frames.

ANSI/BHMA Standard: A156.5, 2001, Grade 2.

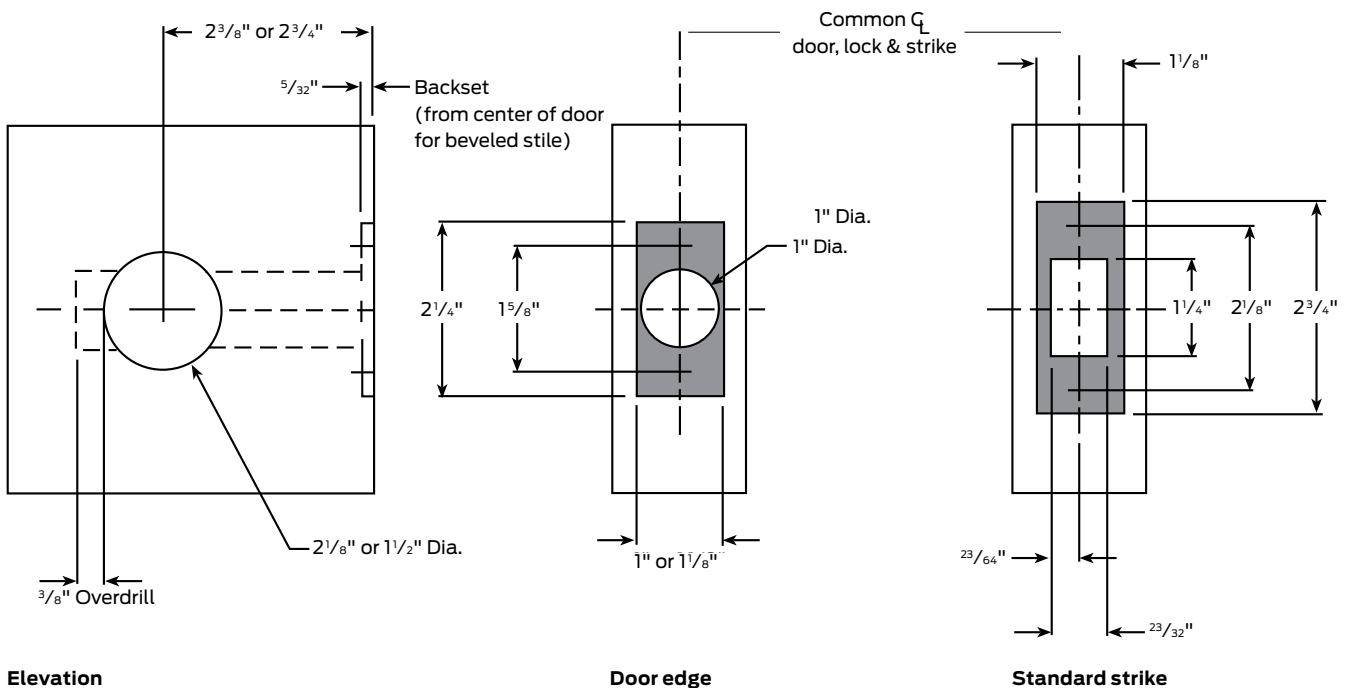

D200 Series styles

Classroom deadbolt (schoolhouse safety)

Deadbolt thrown or retracted by key from outside. Inside turn will only retract bolt. Bolt automatically deadlocks when fully thrown.

ANSI/BHMA E0172



Single cylinder deadbolt

Deadbolt thrown or retracted by key only. Blank plate inside. Bolt automatically deadlocks when fully thrown.

ANSI/BHMA E016



Double cylinder deadbolt

Deadbolt thrown or retracted by key from either side. Bolt automatically deadlocks when fully thrown.

ANSI/BHMA E0142



Single cylinder deadbolt with turn

Deadbolt thrown or retracted by key or by turn. Bolt automatically deadlocks when fully thrown.

ANSI/BHMA E0152



Trim finishes chart

Description	ANSI No.	Available on
Bright brass	605	All trim
Satin brass	606	All trim
Oil rubbed bronze	613	All trim
Bright chrome	625	All trim
Satin chrome	626	All trim

D200 Series lock features

Thumbturn (Inside only)

Deadbolt thrown or retracted by turn unit only. No outside trim. Bolt automatically deadlocks when fully thrown.

ANSI/BHMA E0192



D261

Thumbturn (Inside with occupancy indicator)

Deadbolt thrown or retracted by turn unit only. Occupancy indicator on outside (reads either in use or vacant with color coding). Bolt automatically deadlocks when fully thrown.

Emergency key supplied.



D271

Thumbturn (Inside with blank rose)

Deadbolt thrown or retracted by turn unit only. Outside blank rose. Bolt automatically deadlocks when fully thrown.

ANSI/BHMA E01112



D261M

Function cross-reference

D100 Series – Grade 1

ANSI	Function	Falcon	Stanley	Corbin/ Russwin	Sargent	Yale	Hager
E0171	Schoolhouse safety	D111	QDB186/187	DL3217	487	D161/162	E0141- 3114
E0161	Cylinder X blank	D121	-	DL3211	486	D131/132	E0151- 3115
E0141	Double cylinder	D131	QDB182/183	DL3212	484	D121/122	E0171- 3118
E0151	Cylinder X turn	D141	QDB186/187	DL3213	485	D111/112	-

D200 Series – Grade 2

ANSI	Function	Falcon	Stanley	Russwin	Sargent	Yale	Hager
E0172	Schoolhouse safety	D211	QDB286/287	DL2217	-	D261/262	E0142-3214
E0162	Cylinder X blank	D221	-	DL2211	-	D231/232	E0152-3215
E0142	Double cylinder	D231	QDB282/283	DL2212	474	D221/222	E0192-3220
E0152	Cylinder X turn	D241	QDB288	DL2213	475	D211/212	Thumbturn x occupancy - 3216
E0192	Turn inside only	D261	-	DL2260	479	D241/242	-

Metric conversion table

$\frac{1}{32}$ " = .79 mm	$\frac{3}{16}$ " = 4.76 mm	$\frac{1}{2}$ " = 12.70 mm	$\frac{15}{16}$ " = 23.81 mm
$\frac{1}{16}$ " = 1.58 mm	$\frac{1}{4}$ " = 6.35 mm	$\frac{9}{16}$ " = 14.28 mm	1" = 25.40 mm
$\frac{3}{32}$ " = 2.38 mm	$\frac{5}{16}$ " = 7.93 mm	$\frac{5}{8}$ " = 15.87 mm	$2\frac{3}{8}$ " = 60 mm
$\frac{1}{8}$ " = 3.17 mm	$\frac{11}{32}$ " = 8.73 mm	$\frac{3}{4}$ " = 19.05 mm	$2\frac{3}{4}$ " = 70 mm
$\frac{5}{32}$ " = 3.96 mm	$\frac{3}{8}$ " = 9.52 mm	$\frac{7}{8}$ " = 22.22 mm	5" = 127 mm

Function cross-reference

Mounting screws

Part number	Specify finish	Description		Application	
		Size	Type	Use	Door thickness
Keyed, single conventional cylinder					
B600-100		1/4"-28 x 1 ¹⁵ / ₁₆ "	POH mach.	Mounting	1 ³ / ₈ " - 1 ³ / ₄ "
B600-101		1/4"-28 x 1 ¹⁵ / ₁₆ "	POH mach.	Mounting	1 ³ / ₈ " - 2 ¹ / ₄ "
B600-066		6-32 x 1/4"	PH mach.	Turn	-
B520-298		10-32 x 3/8"	PH mach.	Anti-pry shield	-
Keyed, single SFIC cylinder					
B600-100		1/4"-28 x 1 ¹⁵ / ₁₆ "	POH mach.	Mounting	1 ³ / ₈ " - 2 ¹ / ₄ "
B600-066		6-32 x 1/4"	PH mach.	Turn	-
Keyed, double conventional cylinder					
B600-047		1/4"-28 x 3 ¹³ / ₁₆ "	PH mach.	Mounting	1 ³ / ₈ " - 1 ³ / ₄ "
B600-078		1/4"-28 x 1 ²⁹ / ₆₄ "	PH mach.	Mounting	1 ³ / ₈ " - 2 ¹ / ₄ "
B520-298		10-32 x 3/8"	PH mach.	Anti-pry shield	-
Keyed, double SFIC cylinder					
B600-053		1/4"-28 x 3 ⁶¹ / ₆₄ "	PH mach.	Mounting	1 ³ / ₈ " - 2 ¹ / ₄ "
B520-298		10-32 x 3/8"	PH mach.	Anti-pry shield	-
Keyless, D261					
B600-066		6-32 x 1/4"	PH mach.	Turn	-
B600-048		10-32 x 1/2"	PH mach.	Mounting plate	-
F506-359		#8 x 3/4"	RH wood	Mounting plate	-
Keyless, D261M, D271					
B520-662		10-32 x 1 ³ / ₄ "	POH mach.	Mounting	-
B520-663		10-32 x 1 ³ / ₄ "	POH mach.	Mounting	-
B600-066		6-32 x 1/4"	PH mach.	Turn	-
All functions					
C603-897		#8 x 3/4"	PFH combo.	Deadbolt & strike	-
J520-028		#8 x 2"	PFH wood	2" strike screw	-
R525-256		#12 x 3"	PFH wood	3" metal dust box	-

How to order

For correct ordering, and to ensure no delays in processing of your order, the following descriptive data should be listed in the sequence shown. Necessary information can be found in other parts of this catalog. The example below shows an order for 20 each D deadbolts in the 141 Entry function, in a 626 (satin chrome) finish, to accommodate doors 1 3/4" thick with AA1- AA20 keying.

- **Quantity:** Indicate the quantity required.
- **Catalog number:** Select function number.
- **Cylinder type:** P = conventional cylinder, L=prepped for conventional cylinder, but less cylinder, B=prepped for SFIC, but less cylinder, BB=with Best style capped core, BDC=with disposable construction core, G=with Falcon slide cap core, H=with keyed construction core.
- **Bolt type:** D for deadbolt.
- **Finish:** When the finish is the same for the outside and inside trim, it is shown once (626). Outside finish always precedes inside finish on split finishes (605 x 625).
- **Latches:** 2 3/4" backset is standard. 2 3/8" backset available. All latches are UL listed 3-hour A label.
- **Strikes:** 4 7/8" x 1 1/4" ANSI standard.
- **Cylinder type:** 6-pin.
- **Latch:** 2 3/8" - 2 3/4" universal backset - standard.
- **Strike:** 2 3/4" x 1 1/8" lipless standard. Optional ANSI, T-strike, full lip strikes or security strike available.
- **Cylinder type:** For 6-pin, add 6-pin. For 7-pin, add 7-pin. 7-pin conventional cylinder is not available on the H Series.
- **Door hand:** Not required. All other locks are fully reversible.
- **Keying detail:** We suggest using the standard terms developed by the A.H.C. (Architectural Hardware Consultants).
 - Example: AA1 - Grand Master keyed, Master keyed, change key 1.
- **Interchangeable core:** Specify for 6 or 7 pin if ordering prepped for interchangeable core (SFIC). BD6 or BD7, GD6 or GD7, BB6 or BB7.
- **Keyways:** "G" is standard on regular cylinders. "A" is standard on interchangeable cores. Other keyways available. Please consult factory.
- **Additional keys:** Note the total number of keys required.
- **Large bow keys:** Add—"with large bow keys" under additional details.

How to order example

Qty.	Catalog number	Trim design	Finish	Latch	Strike	Cylinder	Detail
20	D141PD	—	626	STD	STD	6-pin	AA1-AA20 1 3/4" DR



K900 Series

Padlocks

A pin tumbler padlock manufactured from solid bar stock brass, with chrome-plated, case-hardened steel shackle. The entire cylinder assembly is removable for easier rekeying or quick cylinder change. Note: Key is removable in locked position. Padlocks with longer shackles (2" or 6") available when specified. 1" shackle is standard.

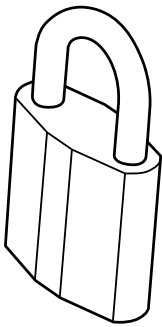

955 Deadlocking type padlock

Cylinders: Furnished with solid brass plug and housing, drilled with 6-pin chambers, pinned in 5 unless otherwise specified. Also available with 7-pin cylinder. Furnished with two (2) nickel silver keys standard.

Keyways: "G" keyway standard on standard cylinders. Interchangeable core (SFIC) padlocks, branded Schlage, are also available. See pricebook for details.

Construction keying

Falcon offers two different construction key systems depending on the size of and application within the project. Both systems permit the installation and use of regular door locks during construction, yet completely preserve the security of the keying system for the ultimate building owner. The Master, Grand Master and change keys are never with the locks during the construction phase of a building. Only the “construction” keys are sent to the job site. Where the job permits, we will utilize the “Lost pin system” as our standard system for construction keying. Larger or more complicated jobs may require the use of our “Blockokey® System” for construction keying.

“Disposable construction” interchangeable cores

This newly designed disposable construction core (1408) is an inexpensive alternative to interior keyed construction cores. This core should be used on interior door applications or where security on a site is not a concern. No keys need to be issued. The disposable core is inserted in the lever or knob and is operated by a thumb turn, which retracts the latch bolt. Please use either brass or permanent construction cores on exterior doors or secured areas.

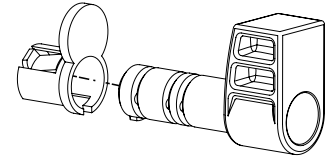

Locks with “Lost pin system”

Our “lost” pin construction key system consists of one construction pin and a shallow hole in the side of the plug.

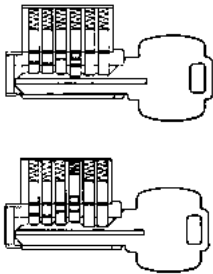

Construction key—KB566

When the “construction” key is used, the construction pin is always in the cylinder plug, sitting on top of the bottom pin.

Master key—KB578

When the Master key is inserted, the construction pin is pushed up into the cylinder housing. As the Master key is rotated to the right, the construction pin will drop into the hole in the plug, thereby eliminating any future use of the construction key.

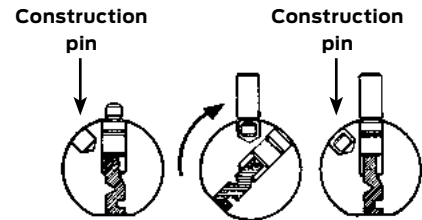

Locks with Blockokey® cylinders

All lock cylinders on a specific project are operable by a special “project key.” Duplicates of this key may be assigned by the building contractor to workmen and subcontractors as required. No regular change keys or Master keys are needed on the job. This eliminates the possibility of subsequent exposure from lost or stolen keys.

How to order locks with Blockokey® cylinders

Blockokey® locksets are ordered by adding the word “Blockokey” after the balance of the ordering information.

Example: 72 Each B511 D 626 1AA-72AA (Blockokey)

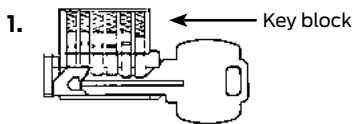

Project key—KB531

Lock cylinder is operated by the special “project key.” The last two pins in the cylinder are held inoperative by the key block.

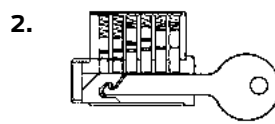

Removal tool – KB536

The special “project key” is canceled out by removal of the key block. A key block removal tool is furnished with the Master keys for the locks. Simply push the removal tool into the keyway, then withdraw it to remove the block. Thereafter, the “project key” will no longer operate the lock cylinder.

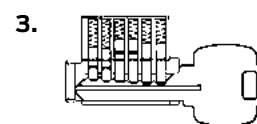

Change or master key—KB578

Cylinder is now only operable by the regular change key or Master key.

Product identification

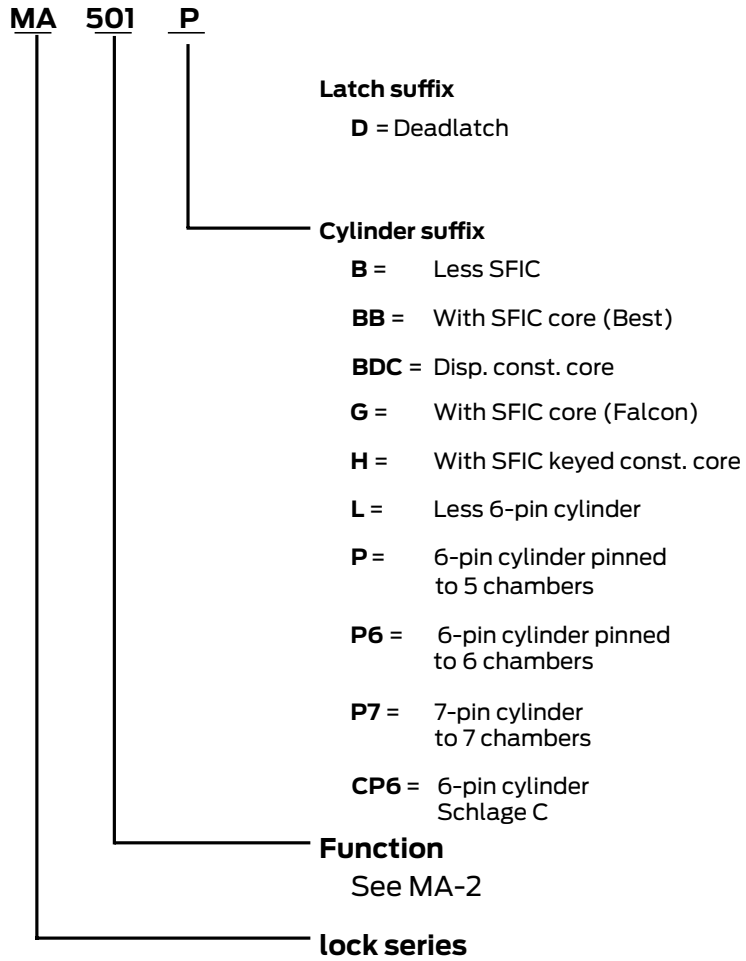

SFIC = Small format (Best® style) interchangeable core

About Allegion

Allegion (NYSE: ALLE) is a global pioneer in safety and security, with leading brands like CISA®, Interflex®, LCN®, Schlage®, SimonsVoss® and Von Duprin®. Focusing on security around the door and adjacent areas, Allegion produces a range of solutions for homes, businesses, schools and other institutions. Allegion is a \$2 billion company, with products sold in almost 130 countries.

For more, visit www.allegion.com

aptiQ ■ LCN ■ **SCHLAGE** ■ STEELCRAFT ■ VON DUPRIN