

777 | 888

IC: Door & Drawer Cabinet Locks for Schlage Full-Size Cores



For SCHLAGE full-size interchangeable core cylinders

**ANSI/BHMA Grade 1
E07121 | E07041**
**Woodwork Institute (WI)
acknowledged product**

SPECIFICATIONS

ANSI/BHMA: Passed ANSI/BHMA A156.11 Grade 1 performance requirements. Equivalent to E07121 (777ICP) / E07041 (888ICP)

Body: Zinc die cast

Cylinder length: 1-7/16"

Barrel diameter: 1-1/8"

Finish: 26D, US3 or 10B

Packaged: Packed 10 per box

CYLINDER INFORMATION

Cylinder: Not included

Accepts: Schlage large format/full-size IC cylinders

- Schlage Quad, Numbered Section, and Schlage Classic IC cores
- Schlage Primus® and Everest large format IC cores
- Mul-T-Lock large format IC cores

Compatible electronic cylinders: VIDEX CyberLock LFIC cylinders

INCLUDED ACCESSORIES

- 7788-PA-D actuator to operate lock without core
- 10-350 plastic spacers (qty 3)
- 10-054 1/4" plastic bar strike
- 10-055 1/2" plastic bar strike

OPTIONAL ACCESSORIES

- Spacers:** 10-350 (1/8" thick), 10-348 (1/4" thick), 10-349 (1/2" thick)
- Strikes:** 10-052, 10-056, 10-057, 10-058, 12-2, 12-3, 12-4
- Trim ring:** TR78
- Through-bolt hardware:** ETS1/ETS4/ETS5 trim plate, ETS1-PL trim pull and ETST1 template

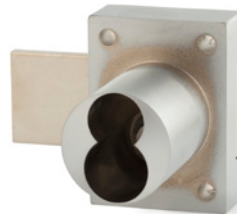

ANSI/BHMA No. E07121

777

Function: Cabinet door lock
Bolt throw: 15/16"

Standard function: Key removable in locked and unlocked position.

Key-retaining function: Specify handing and core type (Standard/Classic or Primus/Everest) when ordering



ANSI/BHMA No. E07041

888

Function: Drawer lock
Bolt throw: 7/8"

Standard function: Key removable in locked and unlocked position.

Key-retaining function: Specify handing and core type (Standard/Classic or Primus/Everest) when ordering

AVAILABLE FINISHES



US26D

US3

US10B

INCLUDED ACCESSORIES

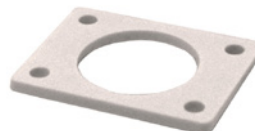

10-350 internal spacers
For a flush fit on varying material thicknesses



10-054 bar strike
1/4" plastic bar strike

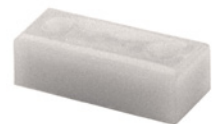

10-055 bar strike
1/2" plastic bar strike

HANDING CHART

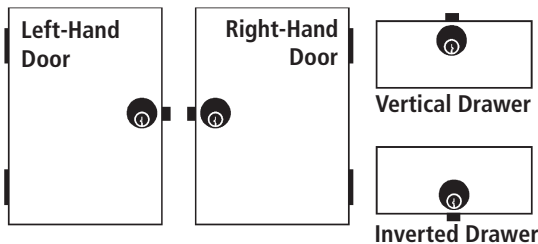

WARNING: This product can expose you to chemicals including chromium, which is known to the State of California to cause cancer and birth defects or other reproductive harm. For more information go to www.P65Warnings.ca.gov.



**OLYMPUS[®]
LOCK^{INC}**

IC: Door & Drawer Cabinet Locks for Schlage Full-Size Cores

OPTIONAL ACCESSORIES

Internal Plastic Spacers

- 10-350 1/8" thick plastic spacers
- 10-348 1/4" thick plastic spacers
- 10-349 1/2" thick plastic spacers

Strikes

- Plastic bar strikes: 10-054, 10-055, 10-057, 10-058.
- Metal strikes: 10-056 12-1, 12-2, 12-3, 12-4

Trim Ring

- TR78 trim ring

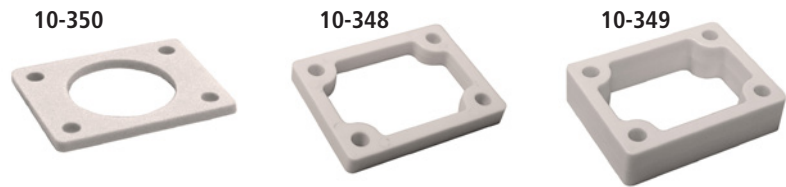

Through-Bolt Mounting Plate

External metal 1/8" or 1/4" through-bolt plate allows for secure and attractive flush mounting of the cabinet lock face. Available in US3 or US26D finish.

- ETS1-125 through-bolt plate, 1/8" thick
- ETS1-250 through-bolt plate, 1/4" thick
- ETS4 through bolt plate for 777, 1/2" thick
- ETS5 through bolt plate for 888, 1/2" thick

Through-Bolt Mounting Plate Template

Allows for proper mounting hole placement of through-bolt plate. Can be used as a 1/8" shim spacer. Available in US3 and US26D finish.

- ETST2 through-bolt plate template

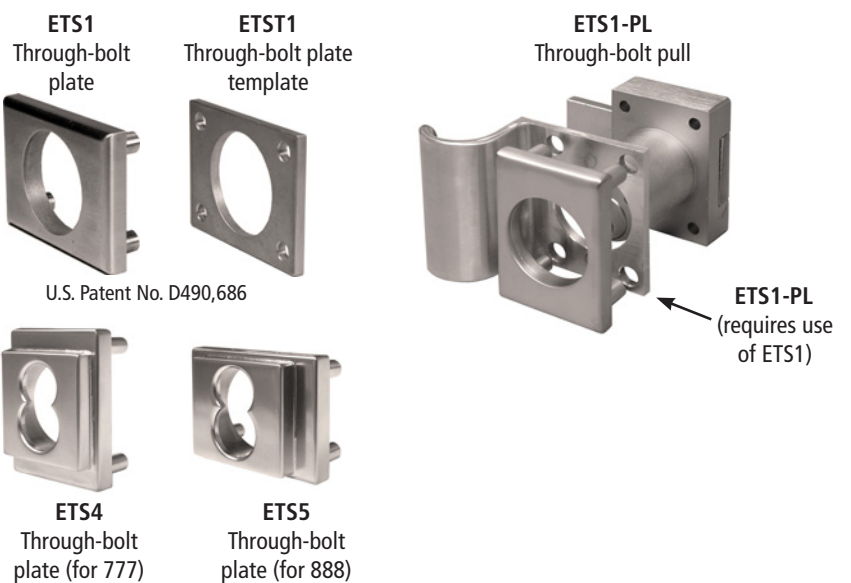

DIMENSIONS

777 Cabinet Door Lock

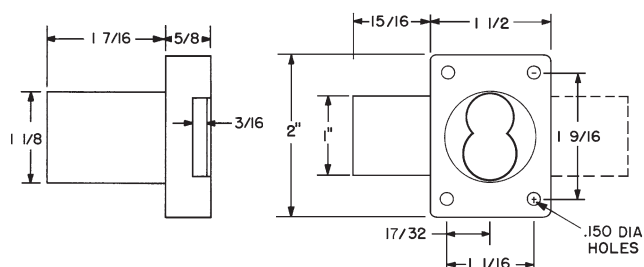

888 Drawer Lock

