

90° Glass Connector Square

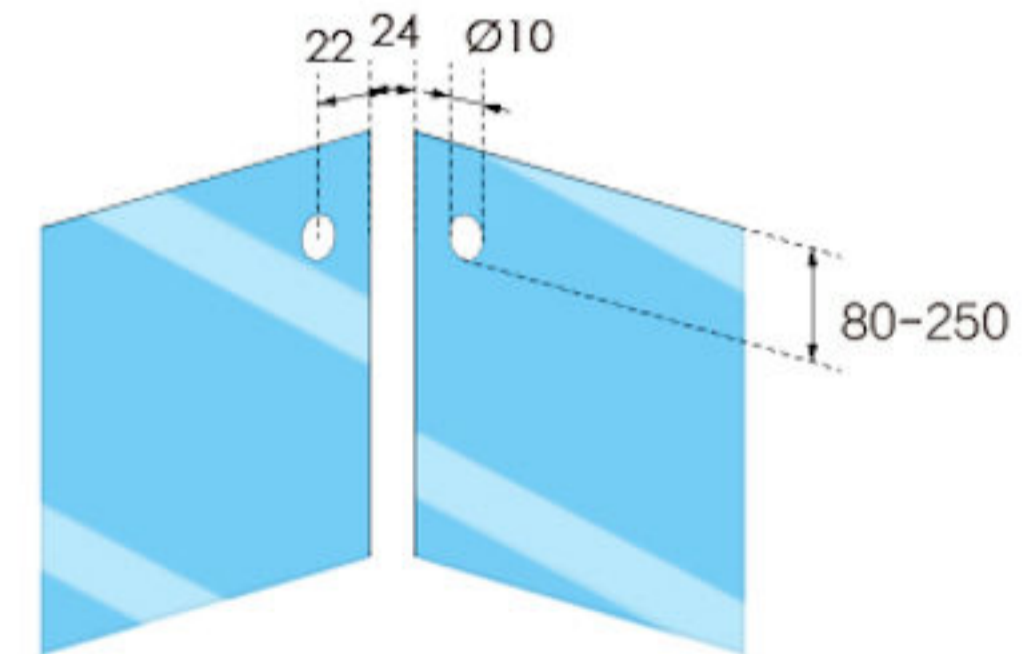
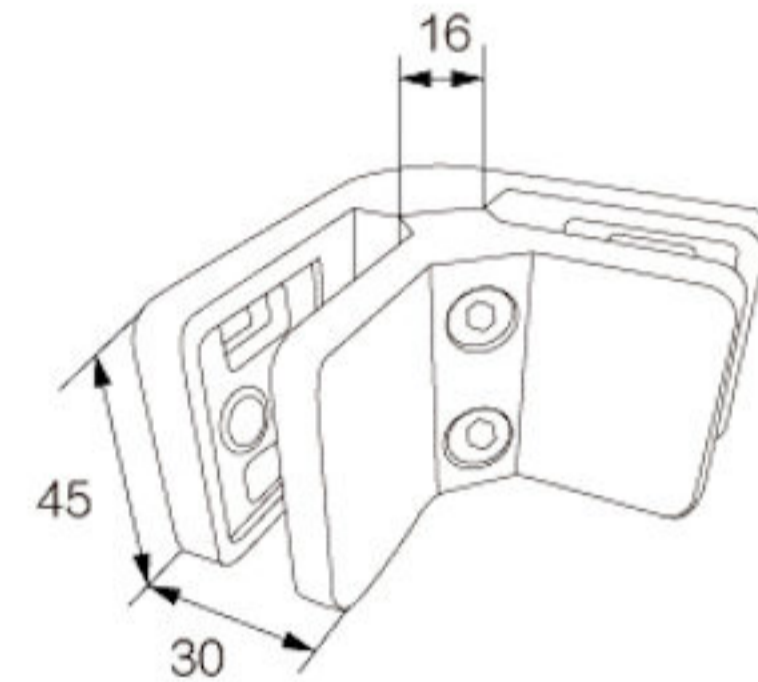
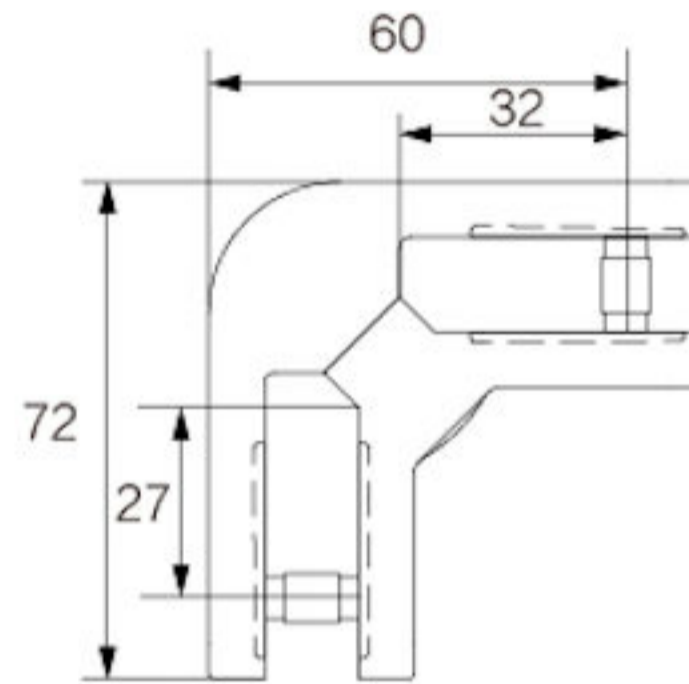

Model	Material	Angle	Glass Thickness
HRGCS6537090170	SS 316	90°	10/12mm

*12mm gaskets included, other gasket sizes sold separately

Raccord de 90° pour verre Carré

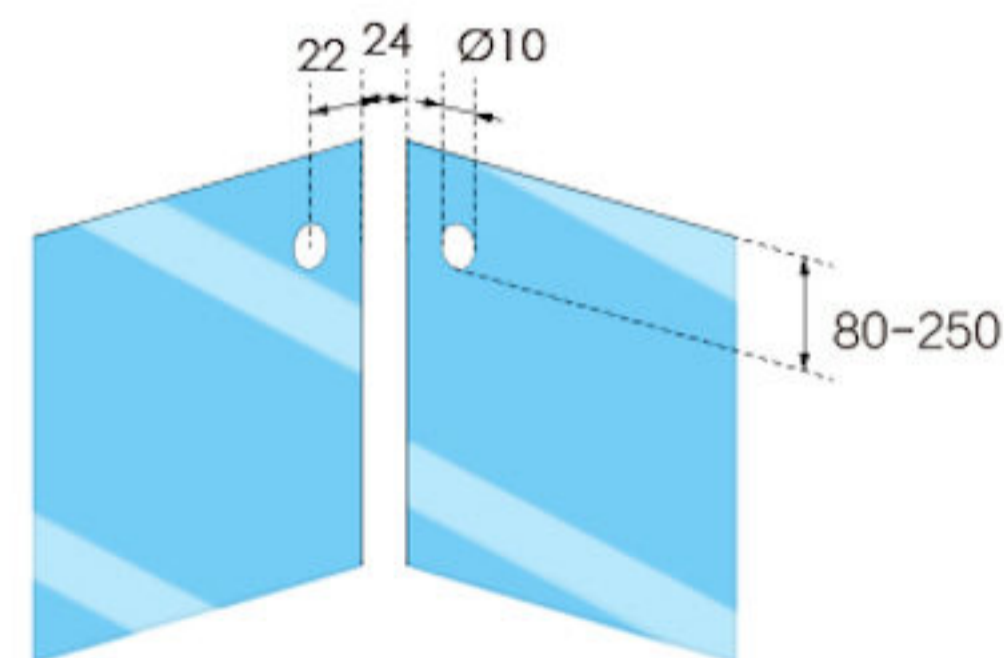
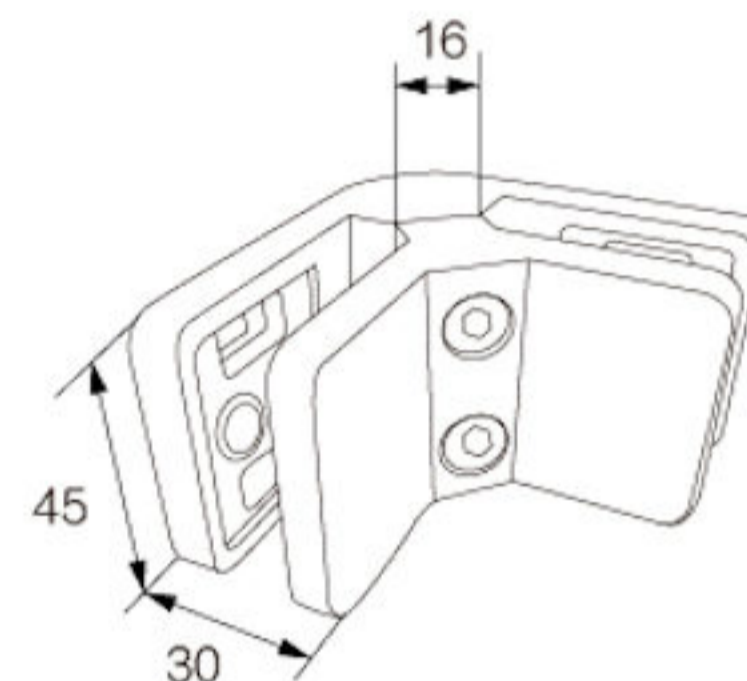
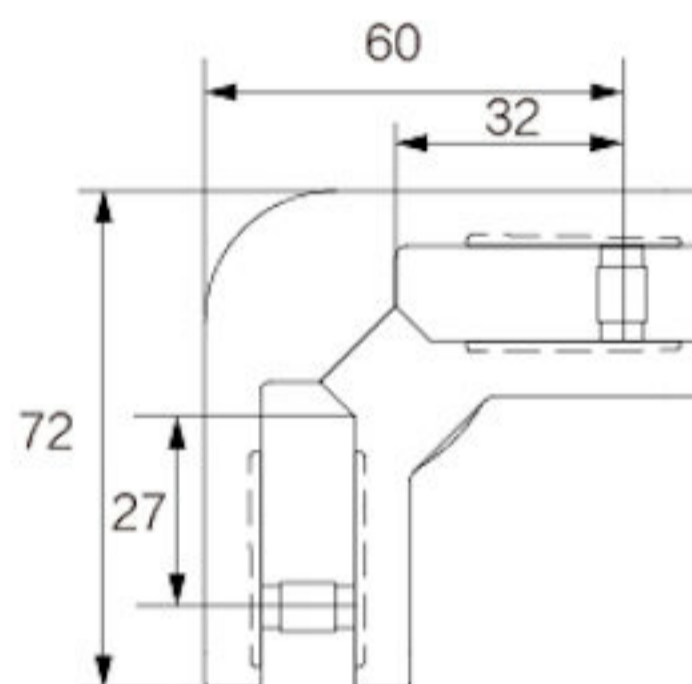

Modèle	Matériel	Angle	Épaisseur de verre
HRGCS6537090170	Al 316	90°	10/12mm

* Joints pour 12mm inclus, autres épaisseurs vendus séparément