

**1900
(U-BRACKET 7/8")**

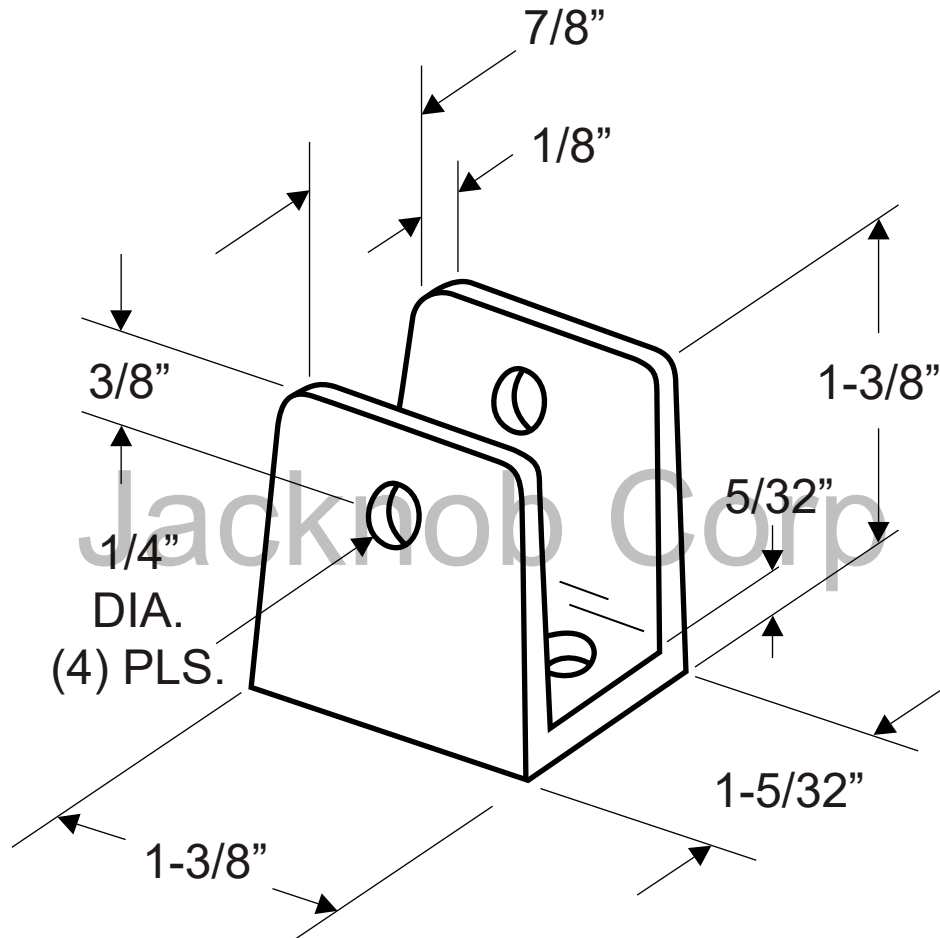

NOTE: TWO HOLES IN BASE