

**2054**  
**(WALL BRACKET - TWO EAR 1/2"x41")**

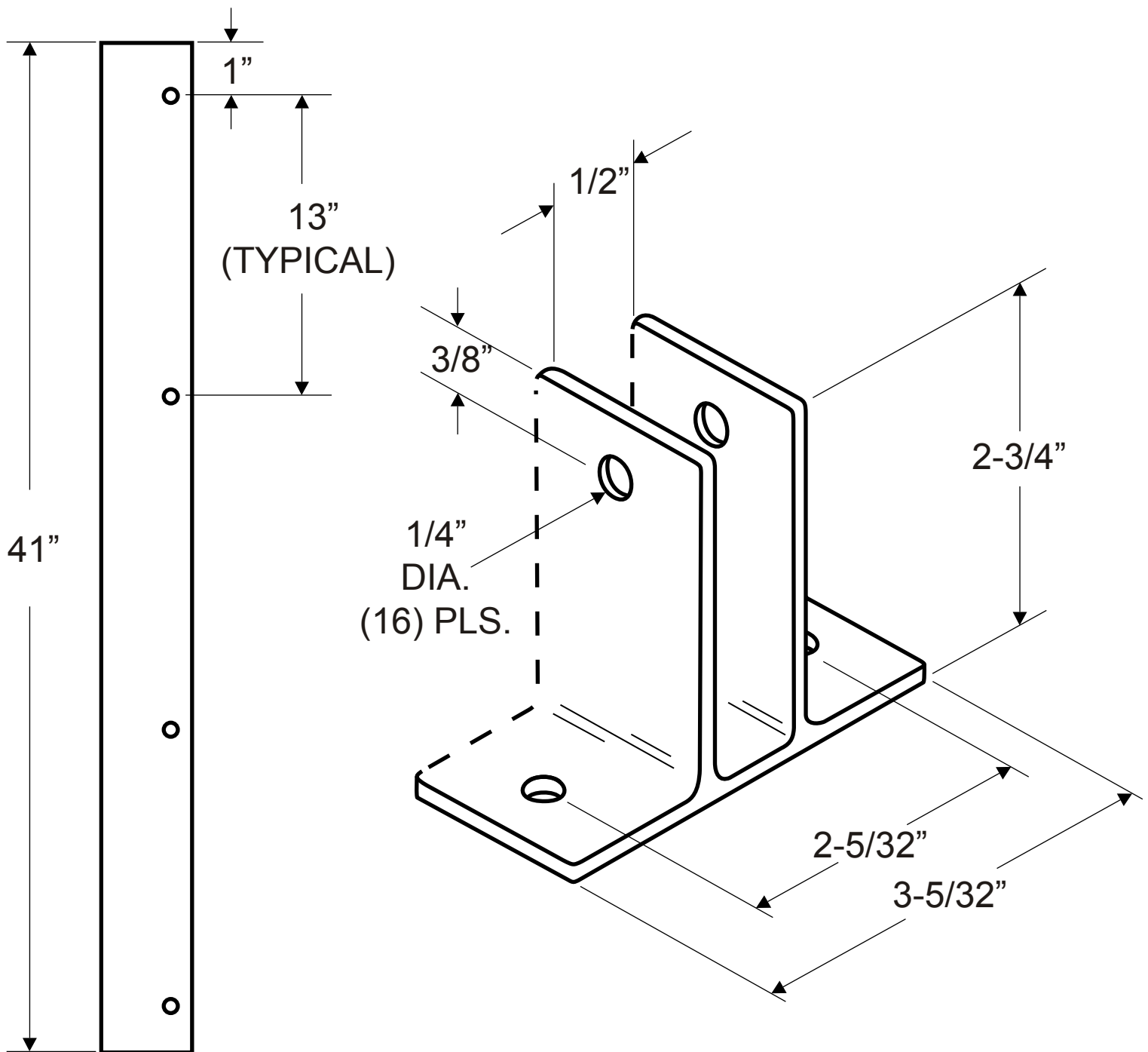

**NOTE: ALL WALL THICKNESS AT 1/8"**