

**1890, 1893
(U-BRACKET 3/4")**

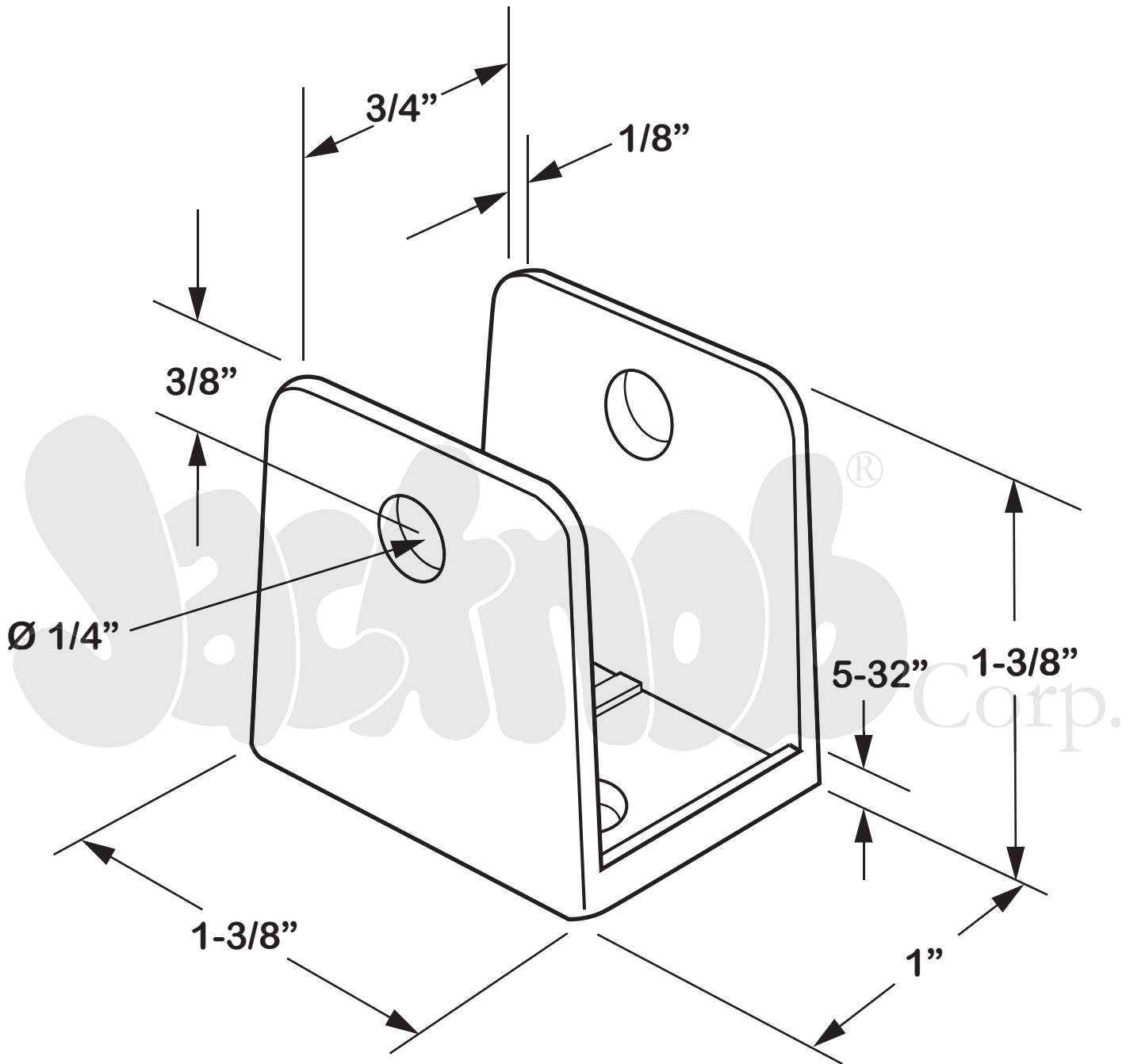

NOTE: TWO HOLES IN BASE

Copyright - 2023 Jacknob Corp. All rights reserved

All dimensions shown are approximate. Do not pre-drill or fabricate based on dimensions shown.

The manufacturer reserves the right to, and may from time to time, make changes in dimensions and designs.