

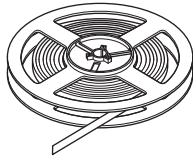

LED3060
LED3061

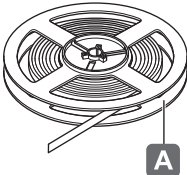

732.28.349



+

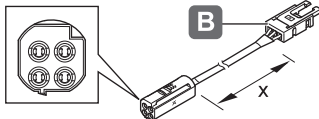

x	24V
2000	833.95.708

+

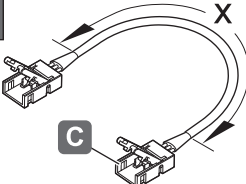

x	24V
50	833.89.197
500	833.89.198
2000	833.89.199

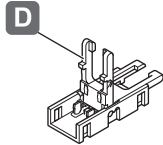

833.89.208

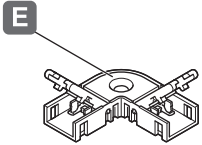

833.89.188

24 V System	W/m	← max. (m) →				mm	T _A
		20W	40W	90W	270W		
LED3060	4,8	4,1	8,3	18,7	18,7	5.000 x 10 x 5	-20 °C – +45 °C
LED3061	9,6	2,0	4,1	9,3	9,3		-4 °F – +113 °F

HDE 29.03.2022

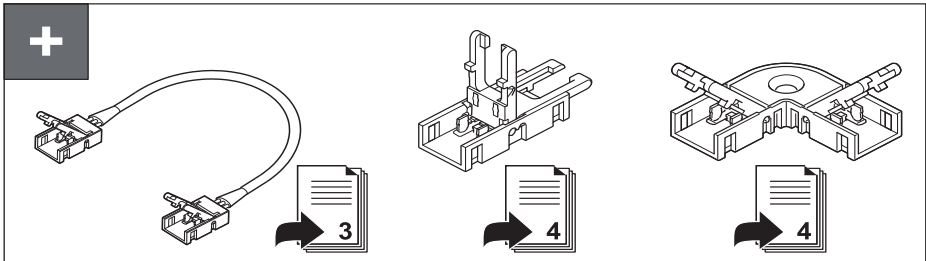
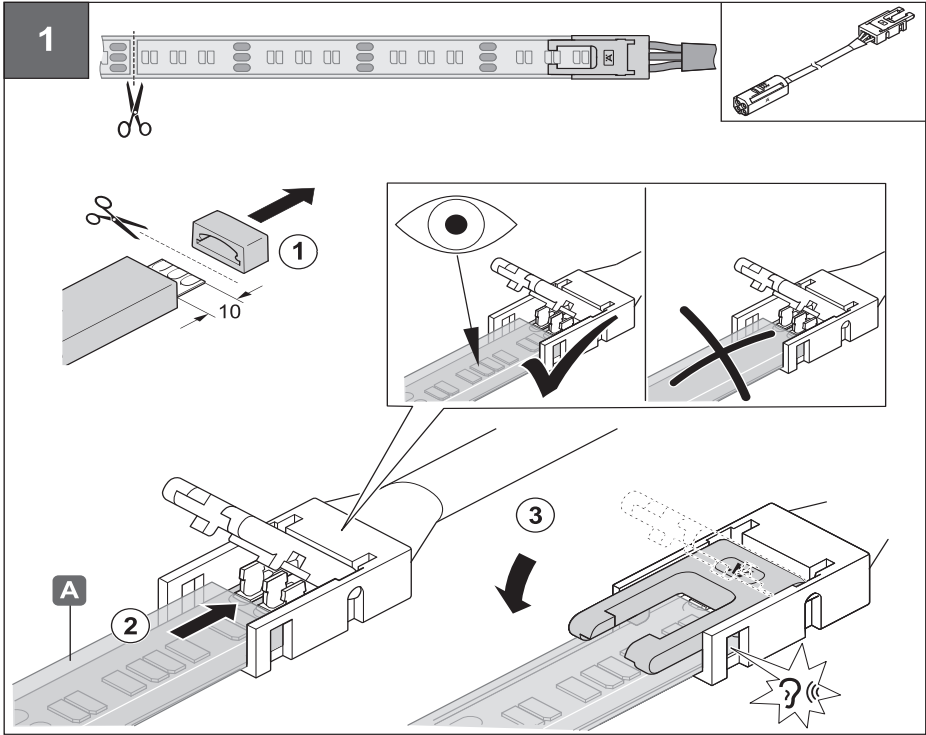
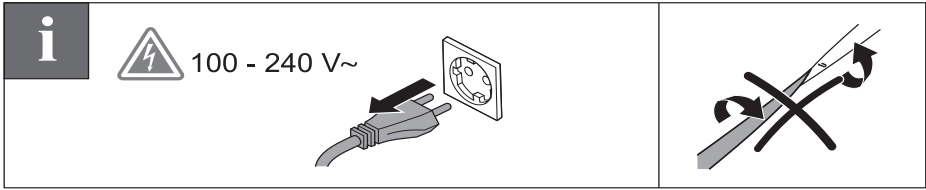

732.28.349

HDE 29.03.2022

2

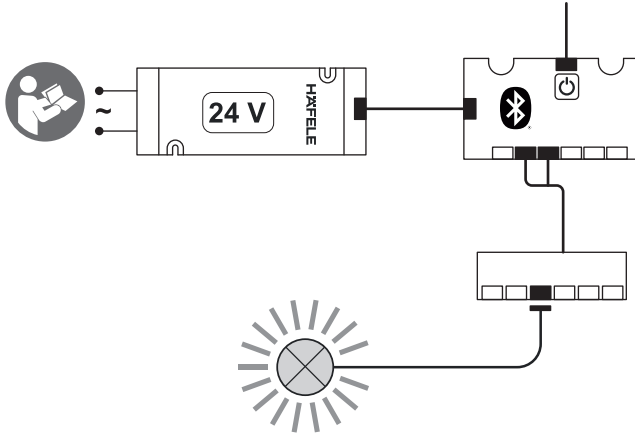

+

„mm“

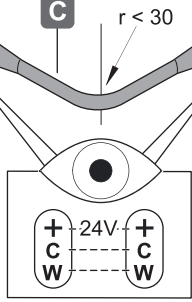
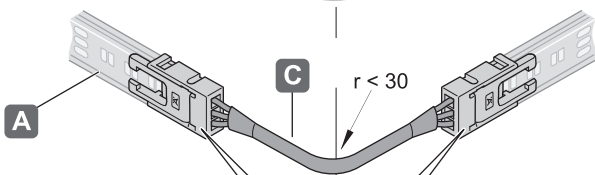
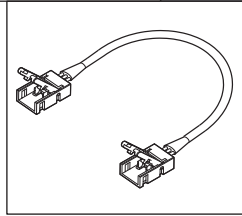
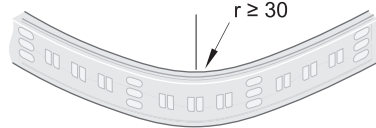

732.28.349

HDE 29.03.2022

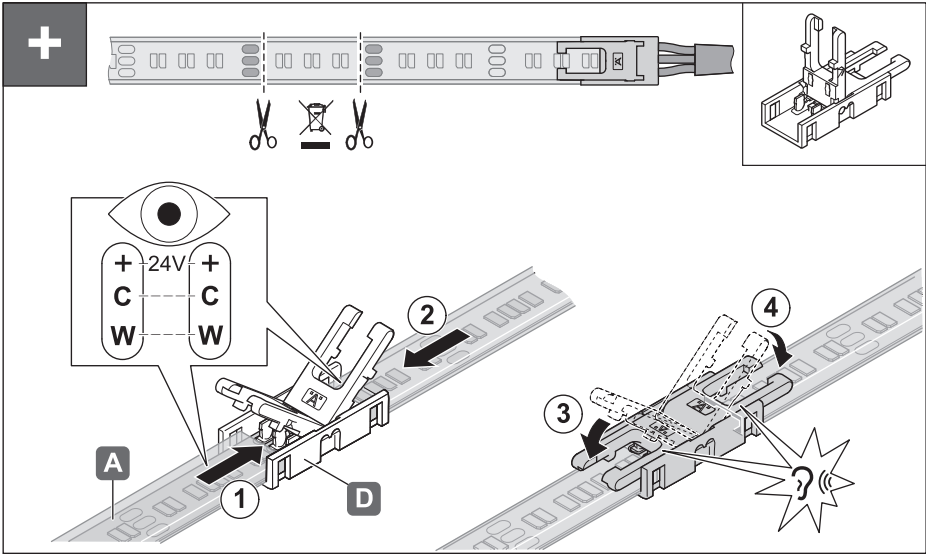

732.28.349

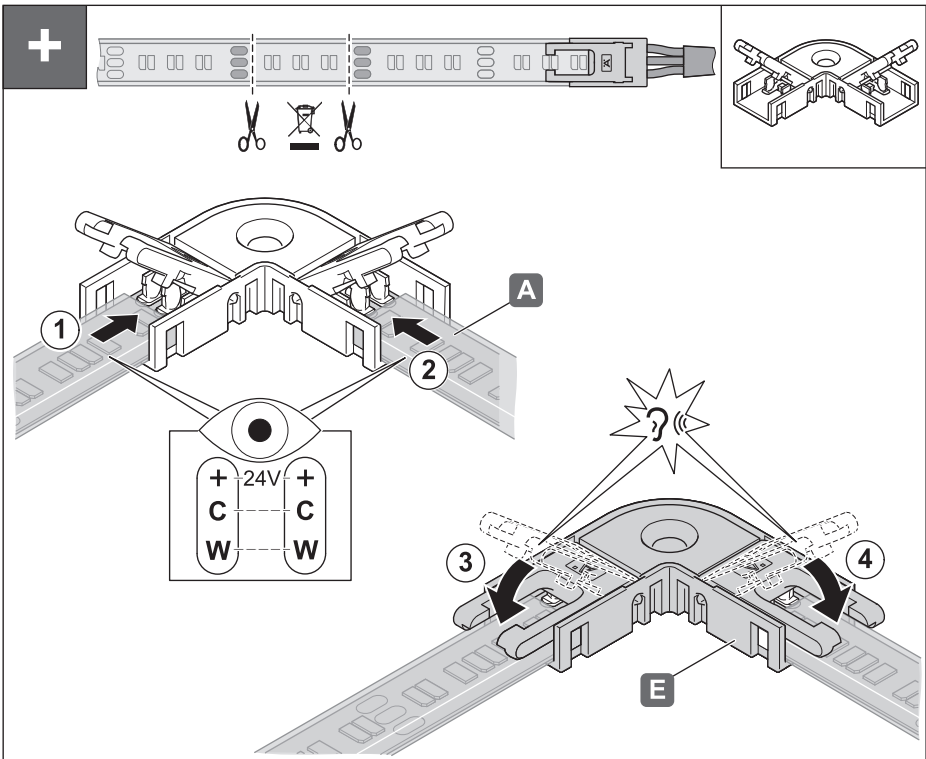

HDE 29.03.2022