



Connect Mesh 4-way Distributor 2-wire with switch

850.00.912
850.00.922

	V	W	T _A	F	
850.00.912	12 V	0–36 W	-25 °C – +45 °C -13 °F – +113 °F	 2.4 GHz 0.6 dBi	105 x 50 x 16 mm 4.13 x 1.97 x 0.63 in
850.00.922	24 V	0–72 W			

732.28.422

i

① 

App
Häfele Connect Mesh

Android





iOS



② 

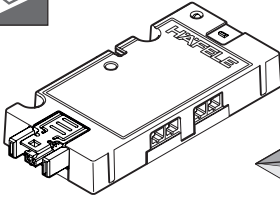

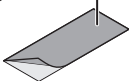

2x **B** 

C 

+

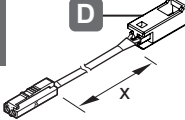

x	12V	24V
500	833.95.712	833.95.719
1000	833.95.713	833.95.718
2000	833.95.714	833.95.717

1 

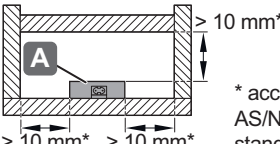

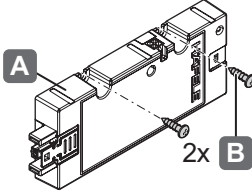

* acc. to AS/NZS standards.

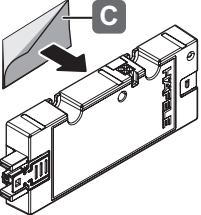

2x **B**



C

	12V System	24V System
 $\times 1$; $\times 2$; ... ; $\times n$	≤ 36 W	≤ 72 W
$\times 1$ + $\times 2$ + ... + $\times n$	≤ 36 W	≤ 72 W
 +  + ... + 	≤ 60 W	≤ 120 W

HDE 12.12.2023

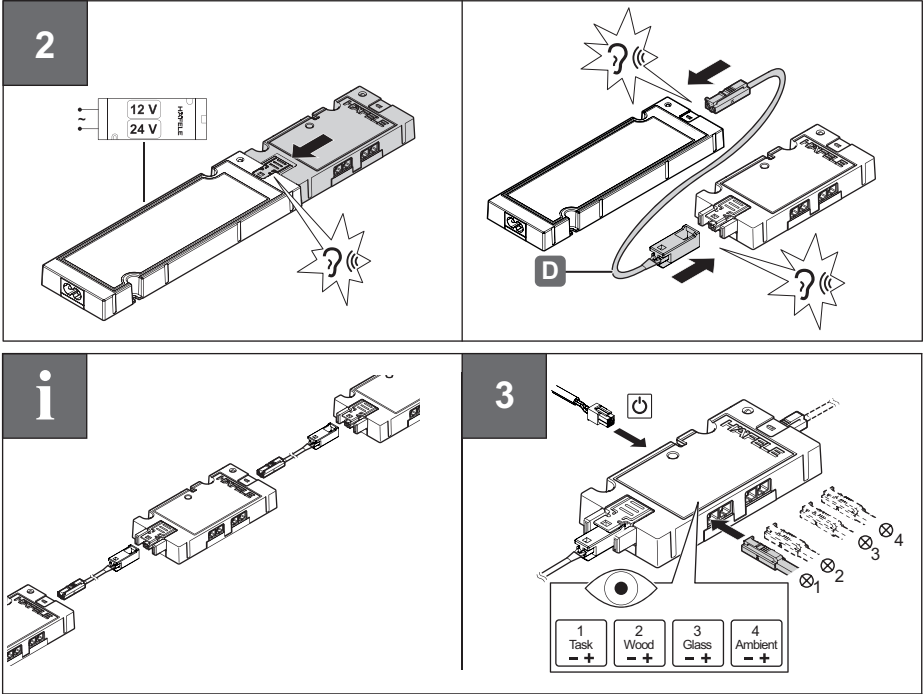

732.28.422

FCC
 "Changes or modifications not expressly approved by the manufacturer could void the user's authority to operate the equipment".

"This device complies with Part 15 of the FCC rules. Operation is subject to the following two conditions: (1) This device may not cause harmful interference, and (2) this device must accept any interference received, including interference that may cause undesired operation."

IC
 "This device complies with Industry Canada licence-exempt RSS standard(s). Operation is subject to the following two conditions: (1) This device may not interference, and (2) this device must accept any interference, including interference that may cause undesired operation of the device."

"Le présent appareil est conforme aux CNR d'Industrie Canada applicables aux appareils radio exempts de licence. L'exploitation est autorisée aux deux conditions suivantes : (1) l'appareil ne doit pas produire de brouillage, et (2) l'utilisateur de l'appareil doit accepter tout brouillage radioélectrique subi, même si le brouillage est susceptible de en compromettre le fonctionnement."

DE
 Hiermit erklärt die HÄFELE SE & Co KG, dass der Funkanlagentyp Connect Mesh 4-fach Verteiler der Richtlinie 2014/53/EU entspricht. Der vollständige Text der EU Konformitätserklärung ist unter der folgenden Internet-Adresse verfügbar: <https://www.haefele.de/de/DOC>

EN
 Hereby, HÄFELE SE & Co KG declares that the radio equipment type Connect Mesh 4-way distributor is in compliance with Directive 2014/53/EU. The full text of the EU declaration of conformity is available at the following internet address: <https://www.haefele.de/en/DOC>

HDE 12.12.2023