

DE: Die Wandverbindung enthält keine Schrauben zur Wandfixierung. Diese müssen vom Kunden selbst besorgt werden. Dabei steht die Fixierung zur Wand in der Verantwortung des Kunden. Für eine ungenügende Fixierung aufgrund ungünstiger Schrauben und Dübeln oder instabiler Wandbeschaffenheit wird keine Haftung übernommen.

GB: The wall bracket is not supplied with screws for fastening it to the wall. Customers must supply the screws themselves. Ensuring proper fastening to the wall is the customer's responsibility. No liability is accepted for inadequate fastening due to the use of unsuitable screws and plugs or insufficient stability of the wall.



<http://support.kesseboehmer.de>



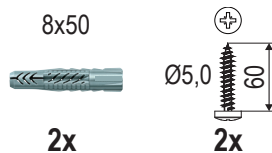
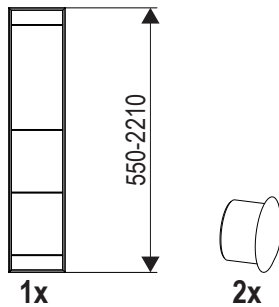

DE Die technischen Darstellungen und Maßangaben – auch bei Abbildungen und Zeichnungen – sind unverbindlich. Konstruktionsverbesserungen sind vorbehalten! **UK** Technical information and stated dimensions (including in illustrations and drawings) must not be regarded as binding. Design subject to change without notice (in interest of improvement)! **FR** Les illustrations techniques et les cotes – y compris sur les schémas et les dessins – sont non contractuelles. Sous réserve d'améliorations de la construction! **IT** Le rappresentazioni tecniche e le indicazioni delle dimensioni – anche nelle figure e nei disegni – non sono vincolanti. Con riserva di miglioramenti di progettazione! **ES** Las descripciones técnicas y los datos dimensionales, inclusive los incluidos en fotos y figuras, son meramente orientativos y no vinculantes. ¡Reservado el derecho a mejoras constructivas! **PT** As descrições técnicas e as indicações de medidas – também em ilustrações e desenhos – não são de natureza imperativa. Salvo melhoramentos de construção! **FI** ekniset piirroksset ja mitat – myös kuvissa ja piirroksissa olevat – ovat sitoumuksetta. Oikeus teknisiin parannuksiin pidätetään! **DK** De tekniske fremstillinger og måleangivelser – også i figurer og tegninger – er vejledende. Forbehold for konstruktionsforbedringer! **CZ** Technické znázornění a rozměry – i na obrázcích a výkresech – jsou nezávazné. Konstrukční změny vyhrazeny! **PL** Prezentacje techniczne i dane wymiarowe – także na rysunkach – są niewiążące. Zmiany konstrukcyjne zastrzeżone! **RU** Иллюстрации технических деталей и указанные размеры, в том числе на рисунках и чертежах, являются ориентировочными. В конструкции возможны изменения! **TR** Teknik resimler ve ebat bilgileri –fotokopi ve çizimler dahil – bağlayıcı değildir. Konstrüksiyon düzeltmeleri saklı tutulmaktadır! **GR** Οι τεχνικές απεικονίσεις και οι διαστάσεις – ακόμα και αυτές που εμφανίζονται στα σχέδια – δεν θεωρούνται δεσμευτικές. Διατηρούμε την επιφύλαξη κατασκευαστικών βελτιώσεων! **JP** 技術データおよび寸法は、改良などによって変更されることがあります。 **CN** 技术图纸和数据 (即使在插图和图纸中) 均不具备法律效力。公司保留进行设计更改的权利!



1

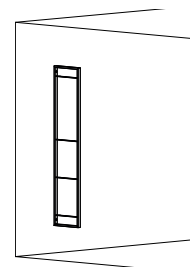
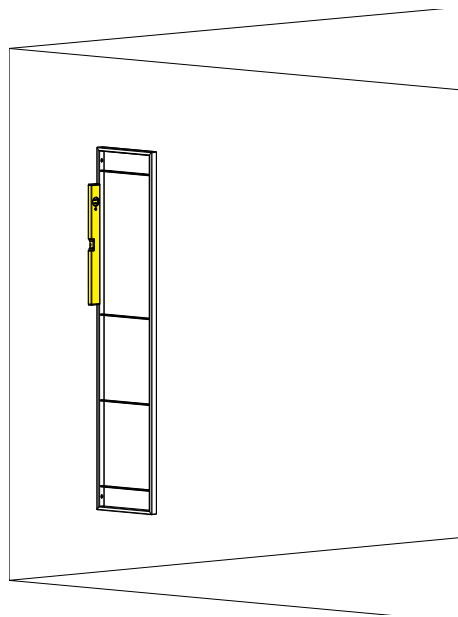
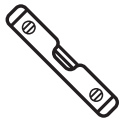

2

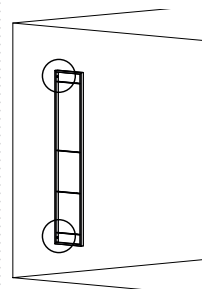
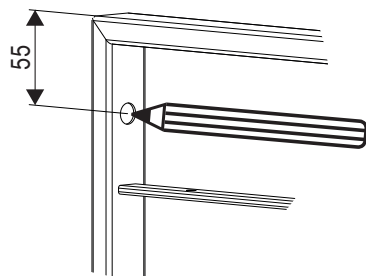

3



2x

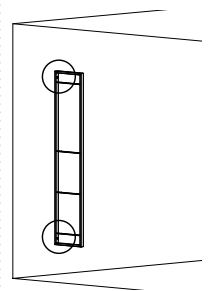
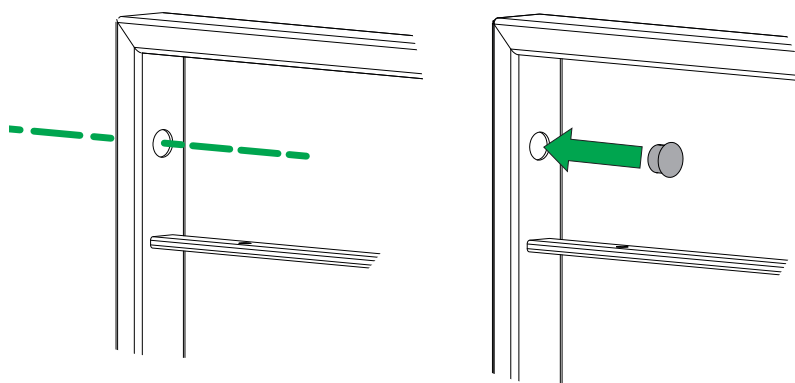
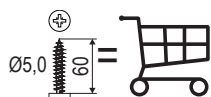



i

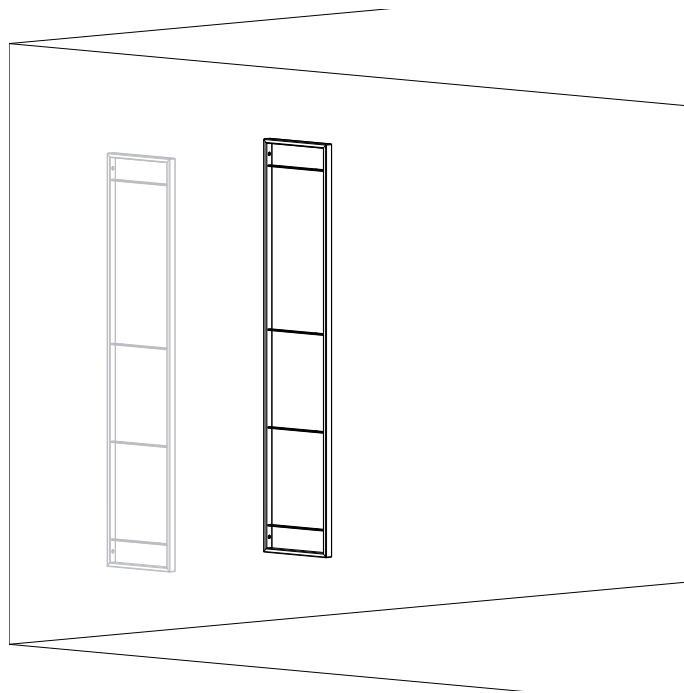

4

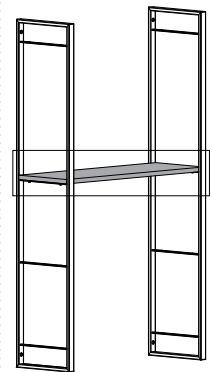
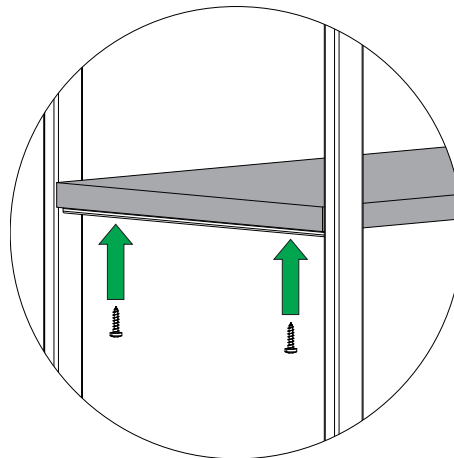
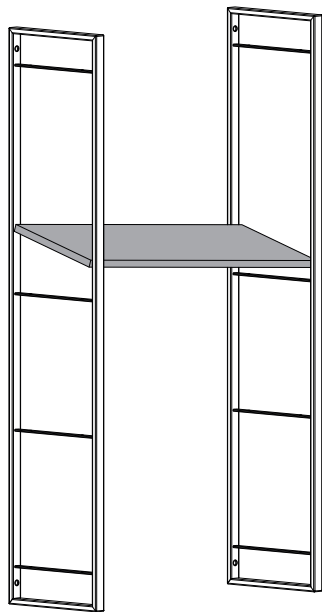

i

