



K PUSH TECH

K PUSH TECH is the fully renewed and extended program of automatic opening systems for doors without handles or knobs.

A special inner mechanism provides a very silent, yet powerful utilization, granting a long durability which makes it perfectly suitable for a wide range of doors.

K PUSH TECH is available:

- with buffer, for cabinets using sprung hinges.
- with magnet, for cabinets using unsprung hinges or negative hinges (Highest magnet strength available in the market).

K PUSH TECH program, includes an innovated range of spring strengths and three lengths of the output paths:

Short – 14 mm, Medium – 20 mm, Long – 37 mm.

Gap between door and cabinet is reduced: activation gap is 1,4 mm, ring thickness is 0,6 mm.

Wide adjustment feature: +6 / -0.45 mm; beyond this negative adjustment the spring is deactivated.



PATENT PENDING
REGISTERED DESIGN
ISO 7170/05



INSTALLATION TO BE EMBEDDED INSIDE THE PANEL

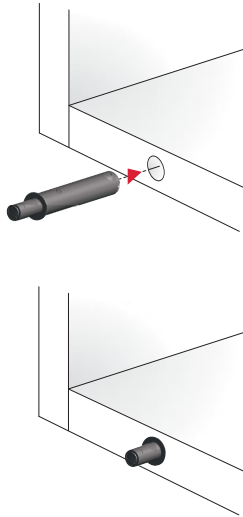

INSTALLATION THROUGH ADAPTER HOUSING

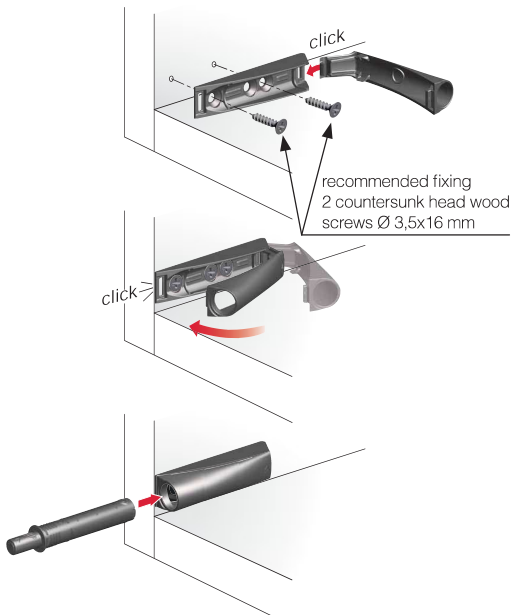

WITH MAGNET
for cabinets using **unsprung hinges**
or **negative hinges**.

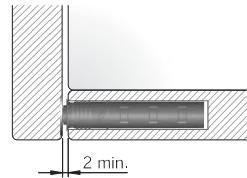

For details refer to
"K PUSH TECH AND
K LOCK DOOR PLATES".

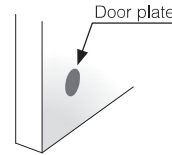

WITH BUFFER
for cabinets using **sprung hinges**.

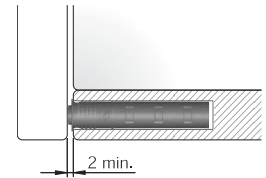

VERSIONS

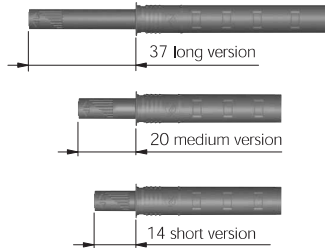

ADJUSTMENTS

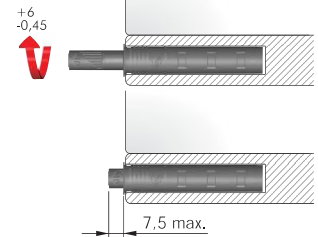

WITH MAGNET
for cabinets using **unsprung hinges**
or **negative hinges**.

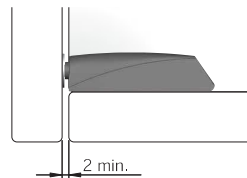

For details refer to
"K PUSH TECH AND
K LOCK DOOR PLATES".

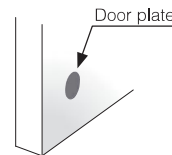

WITH BUFFER
for cabinets using **sprung hinges**.

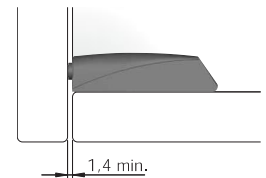

VERSIONS

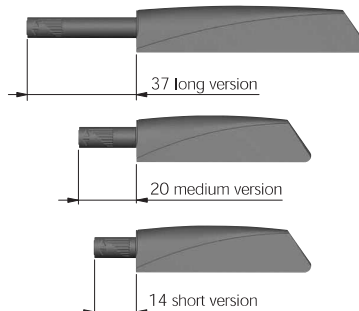

ADJUSTMENTS

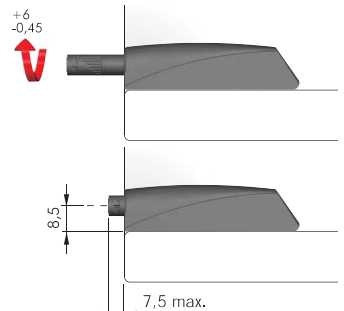



APPLICATION WITH SPRUNG HINGES

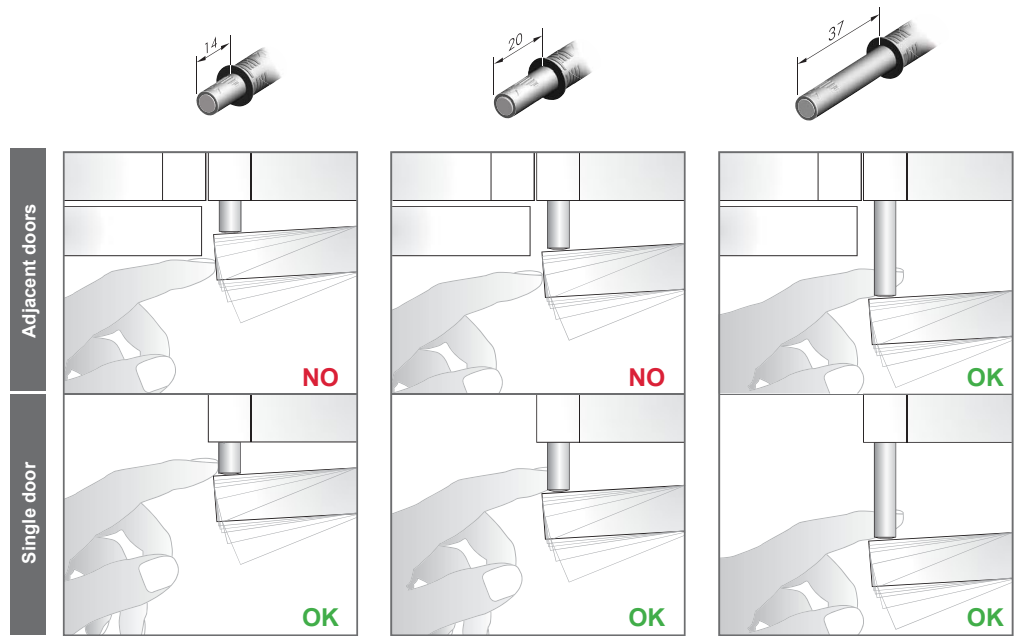
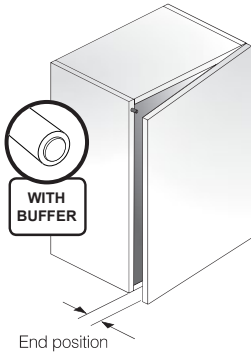
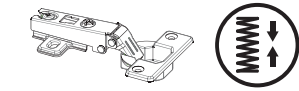

APPLICATION WITH UNSPRUNG HINGES

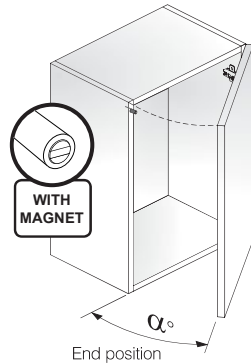

| Door dimensions | Range weight | Indicative α° end door position | | | | |
|------------------|--------------|---|----------------|----------------|----------------|----------------|
| | | 14 | 20 | 20 | 37 | 37 |
| Small door size | 2 - 5 kg | $\pm 30^\circ$ | $\pm 37^\circ$ | $\pm 40^\circ$ | $\pm 55^\circ$ | $\pm 70^\circ$ |
| Medium door size | 5 - 8 kg | $\pm 25^\circ$ | $\pm 30^\circ$ | $\pm 35^\circ$ | $\pm 45^\circ$ | $\pm 50^\circ$ |
| Large door size | 15 - 18 kg | $\pm 20^\circ$ | $\pm 28^\circ$ | $\pm 30^\circ$ | $\pm 40^\circ$ | $\pm 45^\circ$ |
| Maxi door size | 30 - 35 kg | - | $\pm 20^\circ$ | $\pm 25^\circ$ | $\pm 30^\circ$ | $\pm 35^\circ$ |

Small and Medium door size tested with 2 hinges. Large and Maxi size doors tested with 5 hinges. Please note that test results are indicative. End door position may vary depending on hinge brand.

APPLICATION WITH NEGATIVE HINGES

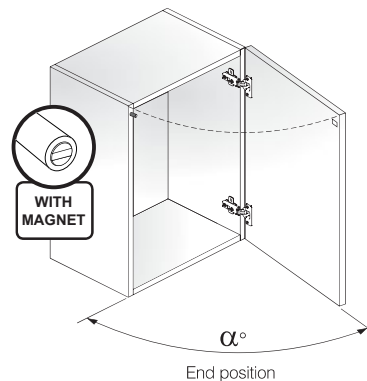

| Door dimensions | Range weight | Indicative α° end door position | | | | |
|------------------|--------------|---|----------------|----------------|-----------------|-----------------|
| | | 14 | 20 | 20 | 37 | 37 |
| Small door size | 2 - 5 kg | $\pm 85^\circ$ | $\pm 90^\circ$ | $\pm 95^\circ$ | Over 95° | Over 95° |
| Medium door size | 5 - 8 kg | $\pm 70^\circ$ | $\pm 85^\circ$ | $\pm 90^\circ$ | Over 95° | Over 95° |
| Large door size | 15 - 18 kg | $\pm 40^\circ$ | $\pm 50^\circ$ | $\pm 60^\circ$ | $\pm 70^\circ$ | $\pm 80^\circ$ |
| Maxi door size | 30 - 35 kg | - | $\pm 35^\circ$ | $\pm 40^\circ$ | $\pm 50^\circ$ | $\pm 60^\circ$ |

Small and Medium door size tested with 2 hinges. Large and Maxi size doors tested with 5 hinges. Please note that test results are indicative. End door position may vary depending on hinge brand.



DROP DOWN DOORS

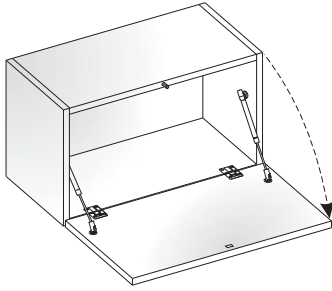

Please note that all technical specifications are based on cabinets assembled only with Italiana Ferramenta products.

APPLICATION WITH: KIMANA HINGES

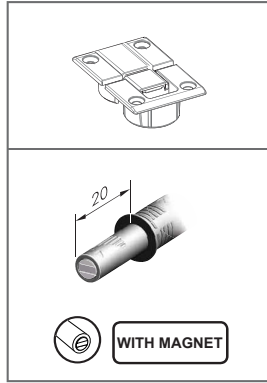

APPLICATION WITH: UNSPRUNG HINGES

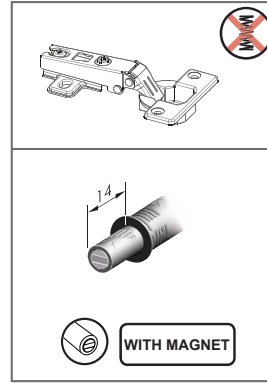

APPLICATION WITH: SPRUNG HINGES

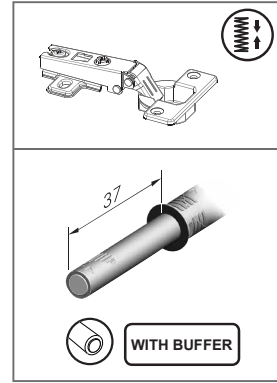

LIFT UP DOORS

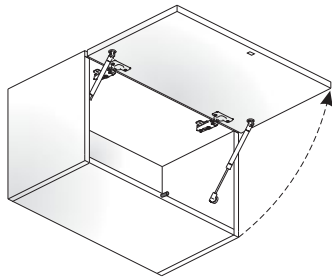

Please note that all technical specifications are based on cabinets assembled only with Italiana Ferramenta products.

APPLICATION WITH: UNSPRUNG HINGES

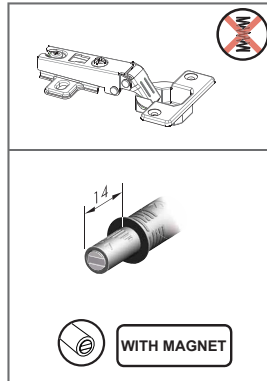

SUGGESTED INSTALLING SPOTS FOR K PUSH TECH

● = K PUSH TECH suggested spot

● = Activating area of K PUSH TECH

BASE CABINETS AND UPPER CABINETS WITH HINGED DOORS

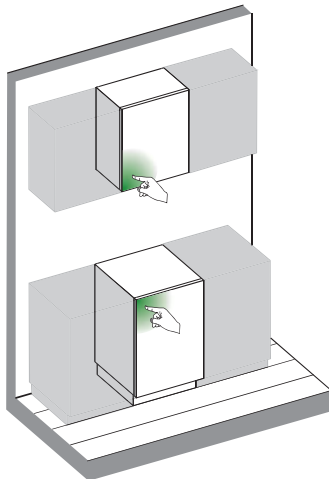
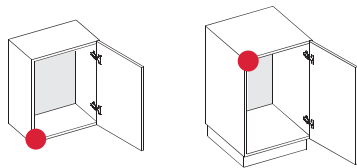

TALL CABINETS WITH HINGED DOORS

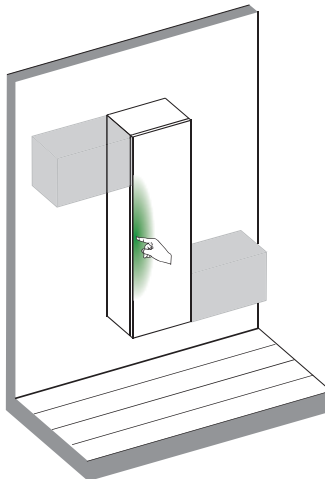
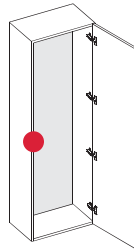

BASE CABINETS AND UPPER CABINETS WITH FLAP DOORS

