



TEL: 800.BRADLEY
FAX: 262.251.5817
bradleycorp.com

Washroom Accessories Service Parts List Price Book 0220WSP

Effective Date February 1, 2020

Table of Contents

Hair-Hand Dryers (Models 2870 thru 2874, 2889, 2896, & 2897)	2
Hand Dryers (Models 2875-28 & 2885-28, 2877-28 & 2887-28)	3
Aerix Hand Dryer (Series 2901)	4
Aerix Hand Dryer (Series 2902-28, 2903-28, 2904-28, & 2905-2873)	5
Aerix + Hand Dryer (Series 2921 & 2922)	6
Aerix + Hand Dryer (Series 2923)	7
Waste Receptacles ***	8
Waste Receptacle Liners	9
Napkin-Tampon Vendors (Models 401, 4017, 4018, 403, 426 & 428)	10
Napkin-Tampon Vendor (Model 407)	11
Napkin-Tampon Vendor (Model 4A20)	12
Toilet Tissue Dispensers (Models 5402, 5412 & 5422) ***	13
Back Clamp and Spindles for Toilet Tissue Dispensers ***	13
Coreless Toilet Tissue Dispensers (Models 5951, 5952, 5426-11, 5426-1195)	14
Soap Dispensers (Models 6542 & 6562; 1993 and later, 6A-00 & 6A-01) ***	15
Soap Drawers and Soap Trays	15
Soap Dispensers (Models 6322, 6324 & 6326; 1993 and later)***	16
Soap Dispenser (Model 6334)	17
Automatic Soap Dispenser (Model 6315)	18
Grab Bar Couplings, Retaining Bracket for Shower Seats	19
Grab Bar Mounting Kits	20-21
Post Sets for Towel Bars, Towel Dispenser Accessories	22
Miscellaneous Parts	22
Collars: Recessed to Semi-Recessed	23
Collars: Recessed to Surface-Mounted	24
Shower Rod Flanges, Diaper Changing Stations, Miscellaneous	25
Mirror Glass, Medicine Cabinet Replacement Shelves	26
Lock & Cam Part Number Reference ***	27
Diplomat™ Lock & Cam Part Number, Kit Reference Guide ***	28









*** USE KIT NUMBERS TO ORDER PARTS

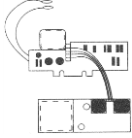
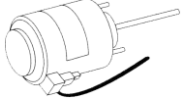
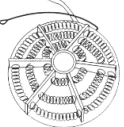

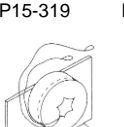
Effective Date February 1, 2020

Hair/Hand Dryers - Cast Iron

Models 2870 Thru 2874, 2889, 2896, & 2897

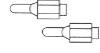
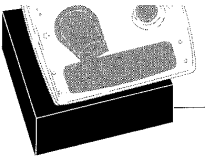
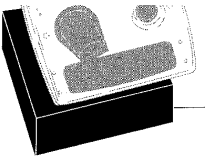
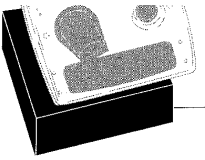
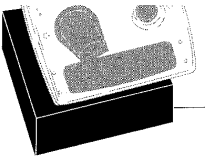
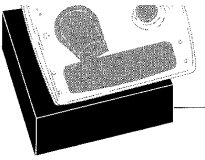
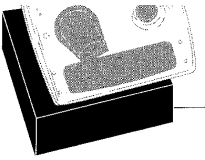
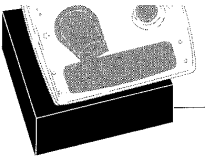
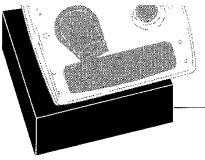
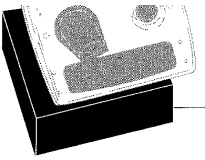
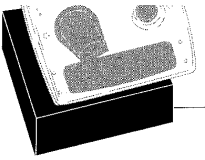
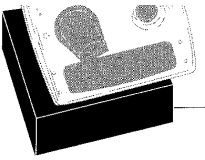
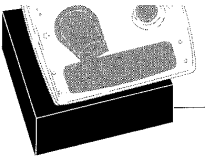
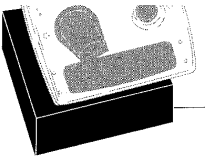
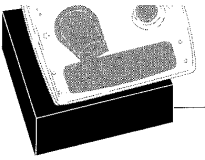
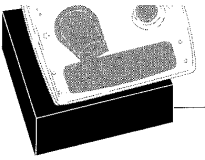
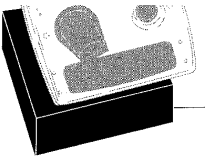
Part No.	Description	Quantity	List Price
 P15-341	P15-317	Motor - 115 Volt	1 \$ 365.10
 P15-317	P15-318	Motor - 208/230 Volt	1 \$ 378.30
 P15-319	P15-319+	Heating Element - 115 Volt - 20AMP	1 \$ 92.80
 P15-298	P15-320+	Heating Element - 230 Volt - 10.5AMP	1 \$ 101.40
 P15-304	P15-346+	Heating Element - 208 Volt - 11 AMP	1 \$ 92.80
 P15-319	P15-298	Screw - Surface Cover	1 \$ 4.00
 P15-298	P15-316	Screw - Recessed Cover	1 \$ 5.80
 P15-301	P15-304	Allen Wrench	1 \$ 11.30
 P15-300	P15-301**+	Timer - 115 Volt - 30 SEC - 60HZ	1 \$ 204.20
 P15-299	P15-302**+	Timer - 208/230 Volt - 30 SEC - 60HZ	1 \$ 204.20
 P15-323	P15-321**+	Timer - 115 Volt - 80 SEC - 60HZ	1 \$ 185.60
 P15-324	P15-322**+	Timer - 208/230 Volt - 80 SEC - 60HZ	1 \$ 185.60
 P15-325	P15-335**+	Timer - 230 Volt - 30 SEC - 50HZ	1 \$ 185.60
 P15-339	P15-336**+	Timer - 230 Volt - 80 SEC - 50HZ	1 \$ 185.60
 P15-339	P15-300	Fuse Block Assembly	1 \$ 14.20
 P15-339	P15-299	Fuse - 2AMP Glass	1 \$ 4.00
 P15-339	P15-323**	Push Button Assembly	1 \$ 69.40
 P15-339	P15-324**	Push Button Spring Kit	1 \$ 8.50
 P15-339	P15-325	Brushes - GE w/Black Cartridge	1 \$ 31.60
Cover - Model 2870 (Surface-Mounted)			
 P15-339	P15-342	White	1 \$ 562.40
Cover - Model 2871			
 P15-339	P15-331A	White	1 \$ 636.10
Cover - Model 2872			
 P15-339	P15-359A	White	1 \$ 614.30
Cover - Model 2873			
 P15-339	P15-330A	White	1 \$ 567.40
Cover - Model 2874			
 P15-339	P15-358A	White	1 \$ 565.40
 P15-339	P15-347	Switch Only (Open Blade Type)	1 \$ 73.20
 P15-339	P15-348	Micro Switch Only	1 \$ 73.20
 P15-339	P15-351	Push Button Adaptor & Bearing Kit	1 \$ 48.50
 P15-339	P15-353	Inlet Grill, Brackets & Rivets (Surface Vandal Resistant)	1 \$ 64.60
 P15-339	P15-354	Inlet Grill, Brackets & Rivets (Recessed Standard)	1 \$ 59.10

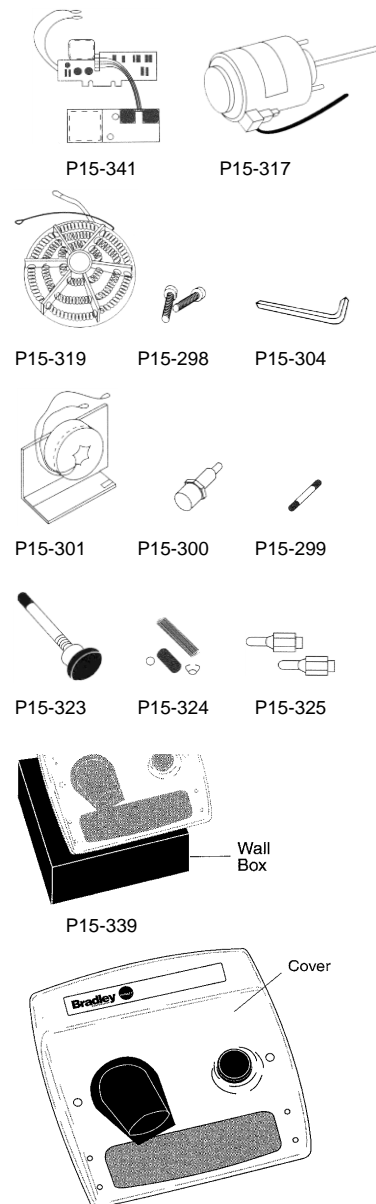

* Models 2870
 ** Models 2871 thru 2874
 + Models need Serial Number when ordering replacement parts.
 +Please have the serial number located on the outside of the cover at hand when ordering service parts to ensure the correct parts are being ordered.







NOTE: Cover includes nozzle and push button.
P15-331A

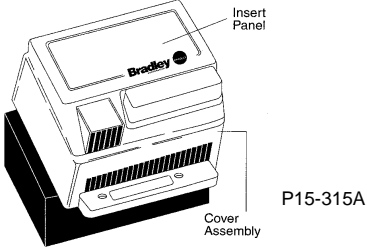

Effective Date February 1, 2020

Hand Dryers

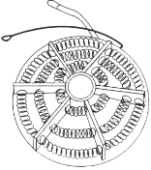
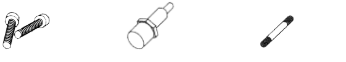
Models 2875 & 2885, 2877 & 2887

	Part No.	Description	Quantity	List Price
	P15-315A	Insert Panel - Snow White	1	\$ 75.80
	P15-315D	Insert Panel - Country Beige	1	\$ 75.80
	P15-315M	Insert Panel - Chrome	1	\$ 75.80
	P15-328+	Cover Assembly - Satin Chrome Finish	1	\$ 560.40
	P15-329+	Cover Assembly - White Finish	1	\$ 410.70
	P15-309	Blower Wheel - 4-3/4" Dia.	1	\$ 33.80
	P15-305+	Motor Kit - 120 Volt - 60HZ	1	\$ 232.30
	P15-307+	Motor Kit - 208/240 Volt - 60HZ	1	\$ 232.30
	P15-306+	Capacitor 120 Volt	1	\$ 62.00
	P15-308+	Capacitor 208/240 Volt	1	\$ 62.00
	P15-310+	Heating Element - 120 Volt	1	\$ 88.80
	P15-311+	Heating Element - 208 Volt	1	\$ 73.20
	P15-333+	Heating Element - 220 Volt	1	\$ 73.20
	P15-298	Screw - Cover	1	\$ 4.00
	P15-300	Fuse Holder - Glass Fuse	1	\$ 14.20
	P15-299	Fuse - 2AMP	1	\$ 4.00
	P15-301+	Timer - 120 Volt - 30 SEC - 60HZ	1	\$ 204.20
	P15-302+	Timer - 208/240 Volt - 30 SEC - 60HZ	1	\$ 204.20
	P15-321+	Timer - 120 Volt - 80 SEC - 60HZ	1	\$ 185.60
	P15-322+	Timer - 208/240 Volt - 80 SEC - 60HZ	1	\$ 185.60
	P15-335+	Timer - 220/240 Volt - 30 SEC - 50HZ	1	\$ 185.60
	P15-336+	Timer - 220/240 Volt - 80 SEC - 50HZ	1	\$ 185.60
	P15-313	Pushbutton Assembly	1	\$ 68.70
	P15-337	Spring & Bumper Kit	1	\$ 10.10
	P15-304	Allen Wrench	1	\$ 11.30

+ Models need Serial Number when ordering replacement parts.

+Please have the serial number located on the outside of the cover at hand when ordering service parts to ensure the correct parts are being ordered.

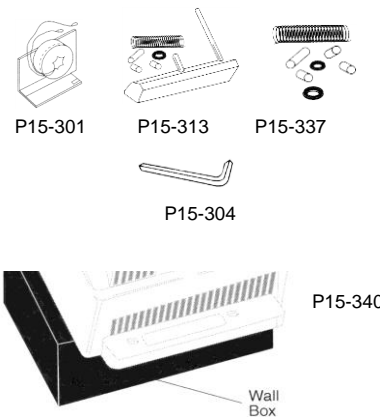



Hand Dryers

Models 2901-2873 and 2901-2874

	Part No.	Description	Item Number	List Price
2901 Series	P15-468A	Replacement cover; white expoy steel	1	\$ 283.90
	P15-468B	Replacement cover; satin stainless steel	1	\$ 376.70
	P15-469	Motor	2	\$ 262.10
	P15-470	Sensor set	3	\$ 161.70
	P15-471	Heating element	4	\$ 60.10
	P15-472	Motor brushes	5	\$ 100.50
	P15-473	Screws and wrench	6	\$ 13.10
	P10-750	Stainless steel recessed kit	N/A	\$ 343.20

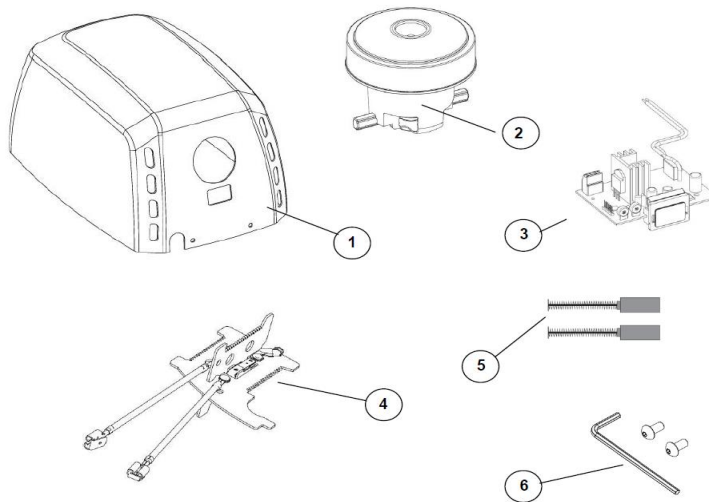



Effective Date February 1, 2020

Hand Dryers

Models 2902-28, 2902-2873, and 2902-2874

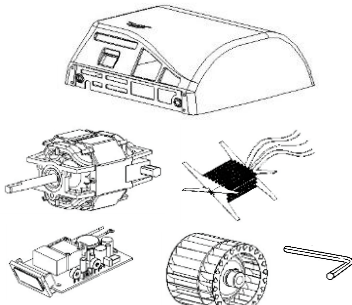
	Part No.	Description	Quantity	List Price
2902-28 Series 	P15-411	Cast Iron Cover - White	1	\$ 464.10
	P15-412	Steel Cover - White	1	\$ 409.50
	P15-413	Stainless Steel Cover - Satin	1	\$ 436.80
	P15-414	Motor	1	\$ 344.00
	P15-415	Heating Element	1	\$ 98.30
	P15-416	Sensor Set	1	\$ 207.50
	P15-417	Motor Brushes	2	\$ 38.20
	P15-418	Turbine	1	\$ 54.60
	P15-419	Wrench	1	\$ 10.90
	P15-444	Rubber Cushions / Silent Blocks	1	\$ 4.40
	P15-445	Sensor Window	1	\$ 16.40
	P15-446	Motor Spring	1	\$ 6.60

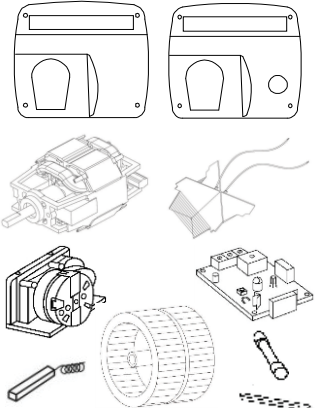
	Part No.	Description	Quantity	List Price
2903-28 and 2904-28 Series 	P15-420	Cast Iron Cover, Sensored - White	1	\$ 791.50
	P15-421	Cast Iron Cover, Push Button - White	1	\$ 842.00
	P15-422	Motor - UL	1	\$ 327.60
	P15-423	Motor - CE	1	\$ 354.90
	P15-424	Heating Element - UL	1	\$ 81.90
	P15-425	Heating Element - CE	1	\$ 87.40
	P15-426	Timer - UL	1	\$ 180.20
	P15-427	Timer - CE	1	\$ 185.60
	P15-428	Sensor Set - UL	1	\$ 191.10
	P15-429	Sensor Set - CE	1	\$ 196.60
	P15-417	Motor Brushes	2	\$ 38.20
	P15-430	Fan Wheel	1	\$ 49.50
	P15-431	Fuse - UL	1	\$ 6.10
	P15-419	Wrench	1	\$ 10.90
	P15-446	Motor Spring	1	\$ 6.60
	P15-447	Sensor Cable (2903 Only)	1	\$ 65.50

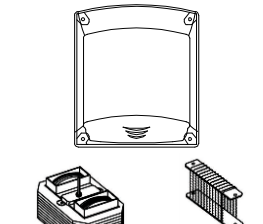
	Part No.	Description	Quantity	List Price
2905-2873 Series 	P15-433	Steel Cover - White	1	\$ 218.40
	P15-434	Motor - UL and Fan Wheel	1	\$ 76.40
	P15-435	Motor - CE and Fan Wheel	1	\$ 81.90
	P15-436	Heating Element - UL	1	\$ 43.70
	P15-437	Heating Element - CE	1	\$ 49.10
	P15-438	Sensor Set - UL	1	\$ 147.40
	P15-439	Sensor Set - CE	1	\$ 152.90
	P15-440	Fan Wheel	1	\$ 21.80
	P15-441	Wrench	1	\$ 10.90

Need Serial Number when ordering replacement parts.
Please have the serial number located on the outside of the cover at hand when ordering service parts to ensure the correct parts are being ordered.



Effective Date February 1, 2020

Hand Dryers

	Part No.	Description	Quantity	Item Number	List Price
2921-W and 2921-S	P15-490	HEPA Filter w/Odor Neutralizing Tablet (1 pk)	1	-	\$ 50.40
	P10-752	Recessed Outlet	1	-	\$ 129.30

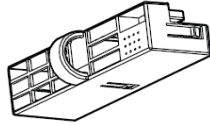

	Part No.	Description	Quantity	Item Number	List Price
2922-2873 and 2922-2874	P15-475	Kit, Sensor	1	1	\$ 56.50
	P15-476	Kit, Dryer Controls	1	2	\$ 88.80
	P15-477	Kit, Motor-120V	1	3	\$ 290.70
	P15-478	Kit, Heating Element - 120V	1	4	\$ 129.30
	P15-482	Kit, Plenum Cap Assy	1	5	\$ 38.20
	P15-483	Air Filter	1	6	\$ 10.90
	P15-484	Kit, Controls Cover	1	7	\$ 10.90
	P15-485	Kit, Nozzle	1	8	\$ 65.50
	P15-486	Kit, Grounding - Model K	1	9	\$ 14.30
	P15-474A	Cover Assy - Alum - White	1	10	\$ 136.50
	P15-474B	Cover Assy - Stainless Steel - Brushed/Satin	1	10	\$ 281.80
	P15-487	Kit, Security Screws	1	11	\$ 4.40
	P15-488	Wrench, Security	1	12	\$ 16.20
	P15-489	Transformer - 120V	1	13	\$ 48.50
	P10-749	Stainless Steel Recess Kit	1	-	\$ 362.60

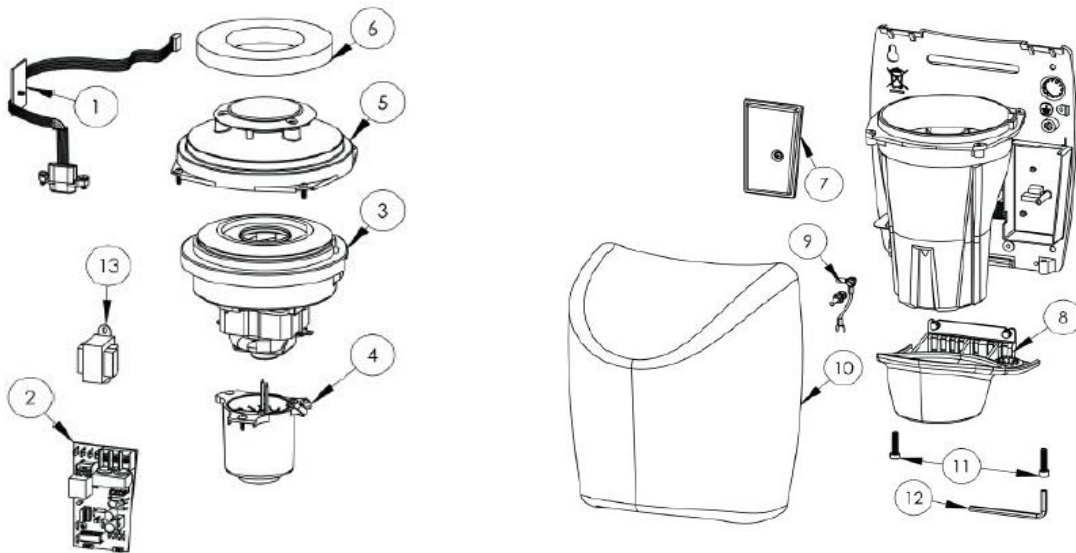

Prices subject to change without notice.
Items may be changed or discontinued
without notice and without incurring obligation.



Hand Dryers

	Part No.	Description	Quantity	Item Number	List Price
2923-28W, -28B and -2874	P15-497	Dryer Controls with Sensor and Transformer	1	1	\$ 94.00
	P15-498	Motor	1	2	\$ 275.20
	P15-499	Replacement Motor Brushes	1	3	\$ 45.90
	P15-500	Heating Element	1	4	\$ 94.00
	P15-501	Front Plenum with Seal	1	5	\$ 24.00
	P15-502	Motor Cap	1	6	\$ 19.70
	P15-503	Cover Assembly - White	1	Not Shown	\$ 156.20
	P15-504	Cover Assembly - Black	1	Not Shown	\$ 156.20
	P15-505	Cover Assembly - Brushed Stainless Steel	1	Not Shown	\$ 329.80
	P15-506	Security Screws (includes wrench)	1	7	\$ 10.90
	P15-488	Security Wrench	1	8	\$ 16.20
	P15-493	HEPA Filter	1	9	\$ 91.80
	P15-494	Top Entry Adapter Kit	1	10	\$ 256.60

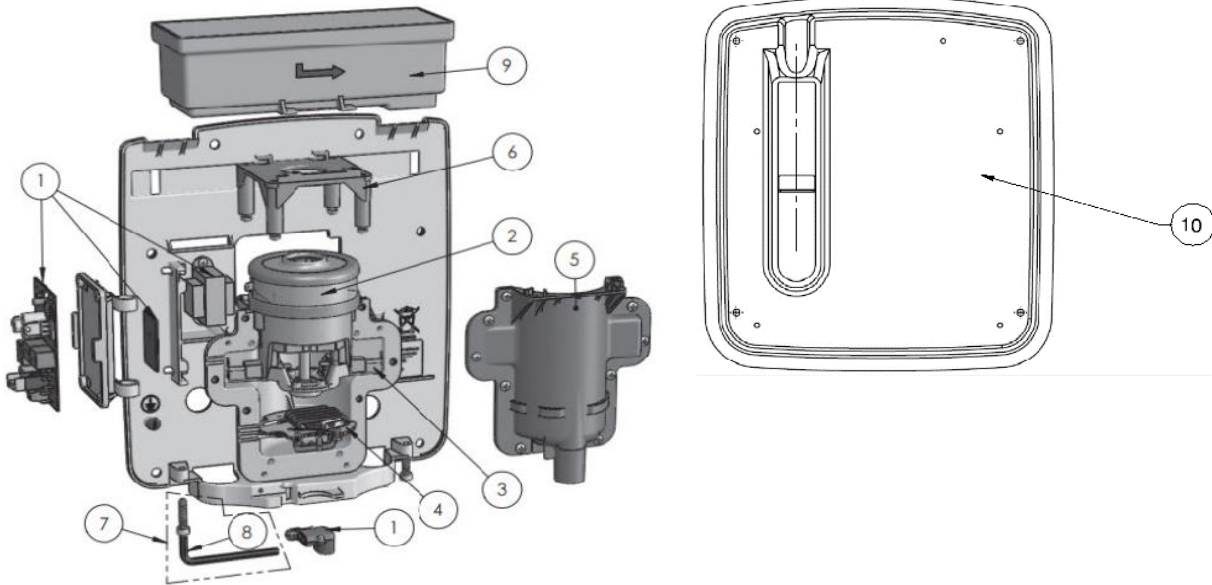



Effective Date February 1, 2020

Waste Receptacles

Molded Plastic & Stainless Steel Waste Receptacles

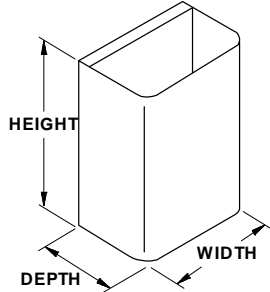

STAINLESS STEEL

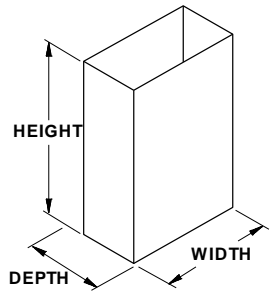

MOLDED PLASTIC

Part No.	* Used On Models	Size (Inches)			Gallons	List Price
		Width	Height	Depth		
P11-028	P 2017, 2018, 2227, 2228, 2252	10-3/4	20	5-1/4	4.9	\$ 64.40
P11-026	P 2027, 2028	10-3/4	20	3-1/2	3.3	\$ 39.10
P11-037	P 2037, 2038	14-1/4	26	7	11.2	\$ 69.70
P11-025	P 225, 2257, 2258, 315, 3157, 3158	10-3/4	38	5-1/4	9.2	\$ 78.80
P11-034	P 2251	10-3/4	38	3	5.3	\$ 61.70
S03-011000000	S 227, 2271, 236-36, 237-36, 334 (before 1/11)	15	23	12-3/4	18	\$ 239.70
A05-011000000	S 334 (after 1/11)	15	23	12-3/4	18	\$ 239.70
700-505	S 229	11-15/16	6	4	1.25	\$ 80.00
A05-005	S 2291	11-15/16	9-1/16	3-15/16	2	\$ 58.50
P11-035	P 2297, 2298	11-15/16	9-1/16	3-9/16	1.7	\$ 31.70
S03-005000000	S 234, 236, 237 (before 1/02)	15	23	8-3/4	12	\$ 231.70
A05-012000000	S 234 (after 1/02); 344, 346 (after 1/11)	15	23	8-3/4	12	\$ 179.90
P11-027	P 235, 2357, 2358	14	23	3-1/2	4.9	\$ 55.00
P11-036	P 238, 238-10, 238-1027, 238-11, 238-27, 238-35	14	23	5-7/8	8.2	\$ 61.50
P11-039	P 403, 428	10-7/8	7	5-3/10	1.5	\$ 72.10
M44-006	P 3251, 3257, 3258	10-3/4	17	3-1/2	2.8	\$ 50.10
A05-007	S 4721.4722	10-1/2	9-1/16	3-15/16	1.5	\$ 55.30
S01-415	S 4731	10-11/16	9-1/16	4	1.5	\$ 60.20
P11-033	P 4737, 4738	9-4/5	7-1/8	3-3/5	1.5	\$ 30.70
P11-032	P 591, 5911	8	10-3/4	3-5/8	0.9	\$ 27.30
P11-031	P 5912, 594, 5942	8	8	3-5/8	1.0	\$ 41.70
M44-048	P 593, 5931, 5932	14	8	3-1/2	1.7	\$ 67.90
P11-038	P 2277	14-1/4	9-3/4	17-3/8	10.5	\$ 52.20
P15-025	S 377 Swing Top Only	13	7	13	n/a	\$ 275.60
P15-098	S 377- 36 Swing Top Only	15	8	15	n/a	\$ 278.50
P15-195	S 377- 38 Swing Top Only	19	10	19	n/a	\$ 313.80
A05-015	S 3251-990002	34	11-7/8	16	14.5	\$ 511.70
A05-023	S 234-36	24	15-3/4	18-3/4	18	\$ 240.20
A05-019	S 3A05, 2A05	16-3/4	23-7/16	8-3/5	12	\$ 283.90
A05-014	S 3A05-36, 2A05-36	12 - 7/16	23 - 7/16	16 - 3/4	18	\$ 331.00
A05-020	S 2A15-36, 2A25-36, 2A95-36	16-7/10	23-2/5	14-1/2	21	\$ 349.40
P11-018	P 4A00, 4A10	10	10-1/4	5-3/5	1.5	\$ 37.80

* P = Plastic, S = Stainless Steel



Effective Date February 1, 2020

Waste Receptacle Liners

PVC Vinyl Liners and Waxed Paper Liners

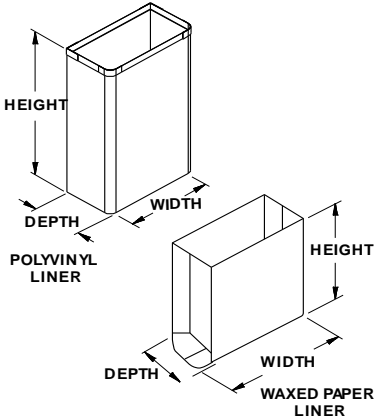









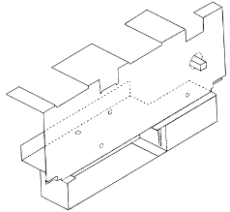

Part No.	Used On Models	Size (Inches)			Kit Part Number	List Price
		Width	Height	Depth		
PVC Vinyl						
P11-001	227, 2271, 234-36, 237-36, 334, 336	14	23	11-3/4		\$ 27.60
P11-004	233, 234, 237, 344, 346	14-3/4	23	7		\$ 25.50
P11-005	355	16	23	12		\$ 27.50
P11-006	356	18	23	9		\$ 27.60
P11-007	357	13-1/2	18	5-1/2		\$ 23.60
P11-041	2A05-36, 3A05-36	16	23	11-1/2		\$ 30.10
P11-042	3A15-11	16	23-1/2	11-1/4		\$ 30.60
P11-043	2A15-36, 2A25-36, and 2A95-36	16	23	13-1/2		\$ 32.80
P11-044	2A05	16	23	7-1/2		\$ 30.80
P20-134	Instructions					\$ 0.20
Waxed						
P11-030	2258, 359, 403, 428, 4721, 4722, 4727, 4731, 4737, 4738, 4781, 4791, 591, 5911, 5912, 594, 5942	9	11	4	P11-022 (Box of 500)	\$ 245.70

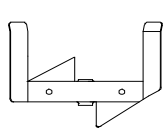

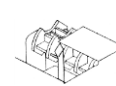
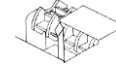
Effective Date February 1, 2020

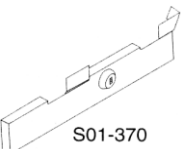
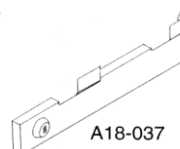
Napkin/Tampon Vendors

Models 401, 4017, 4018, 403, 426 & 428

	Part No.	Description	List Price
 <p>S01-520040</p>	S01-520040*	Free Coin Mounting Plate Assembly	\$ 234.20
	S01-520042*	10¢ Coin Mounting Plate Assembly	\$ 234.20
	S01-520043*	50¢ Coin Mounting Plate Assembly	\$ 234.20
	S01-520044*	\$1 Coin Mounting Plate Assembly	\$ 234.20
	S01-520045*	25¢ Coin Mounting Plate Assembly	\$ 234.20
	P10-517	Slave Shaft (Recommend also purchasing P18-028)	\$ 4.20
	P18-018	Flat Washer	\$ 0.60
	270-072	Cam	\$ 4.80
	P18-028	Retaining Ring	\$ 0.80
	330-106	Napkin Paddle	\$ 11.20
 <p>P10-517 P18-018 270-072 P18-028</p>	330-107	Coined Shaft (Recommend also purchasing P18-028)	\$ 7.80
	P10-524	Tampon Rotor	\$ 10.60
	A19-016***	Free Coin Mechanism Assembly	\$ 65.50
	A19-017***	10¢ Coin Mechanism Assembly	\$ 65.50
 <p>330-106</p>	A19-018***	25¢ Coin Mechanism Assembly	\$ 65.50
	A19-019***	50¢ Coin Mechanism Assembly	\$ 65.50
 <p>330-107</p>	A19-020***	\$1 Coin Mechanism Assembly	\$ 65.50
	A19-021***	€ .50 Coin Mechanism Assembly	\$ 65.50
 <p>M44-074</p>	M44-074	Coin Mechanism Handle	\$ 5.50
	P18-125	Screw	\$ 1.70
 <p>P10-524</p>	S01-370**	Coin Box Cover & Lock Assembly (for units manufactured before 1993)	\$ 33.00
	A18-037**	Coin Box Cover & Lock Assembly (for units manufactured after 1993)	\$ 22.90
 <p>P18-125</p>	A18-048	Tampon Cam Assembly	\$ 36.20
	P10-519	Lock and Key for Coin Box	\$ 7.20
 <p>S01-370</p>	S01-499	Tampon Weight Assembly	\$ 19.40
	S01-374	Napkin Weight Assembly	\$ 21.10
 <p>A18-037</p>	P20-034	Free Label	\$ 1.10
	P20-036	10¢ Label	\$ 1.10
 <p>P10-519 S01-499 S01-374</p>	P20-037	25¢ Label	\$ 1.20
	P20-078	50¢ Label	\$ 1.10
 <p>P20-117</p>	P20-117	\$1 Label	\$ 1.60
	P20-180	€ .50 Label	\$ 1.10
 <p>P18-055</p>	P18-055	Screw	\$ 2.00
	P10-558****	Lock for Door	
 <p>P10-558</p>	P10-526****	Key for Door	
	P20-039	Maintenance and Loading Instructions	\$ 1.90
	100-039	Slip Flange for 401 Only	\$ 73.90

Includes items P10-517 thru A18-037.
** Includes items P10-519 & P10-548.
*** Includes items P18-125 & label.
**** Refer to Lock & Cam Part No. Reference for Kit No.



Effective Date February 1, 2020

Napkin/Tampon Vendors

Model 407

Item	Part No	Description	List Price
1	A18-046	Coin Metal Plate Assembly	\$ 53.60
2	A18-047	Napkin Cam	\$ 24.30
3	A18-048	Tampon Cam	\$ 36.20
4	A19-016***	Free Coin Mechanism Assembly	\$ 65.50
	A19-017***	10¢ Coin Mechanism Assembly	\$ 65.50
	A19-018***	25¢ Coin Mechanism Assembly	\$ 65.50
	A19-019***	50¢ Coin Mechanism Assembly	\$ 65.50
	A19-020***	\$1 Coin Mechanism Assembly	\$ 65.50
	A19-021***	€ .50 Coin Mechanism Assembly	\$ 65.50
5	P18-125	Screw for Coin Mechanism	\$ 1.70
6	P20-034	Free Label	\$ 1.10
	P20-036	10¢ Label	\$ 1.10
	P20-037	25¢ Label	\$ 1.20
	P20-078	50¢ Label	\$ 1.10
	P20-117	\$1 Label	\$ 1.60
	P20-180	€ .50 Label	\$ 1.10
7	A18-037	Coin Box Cover w/ Lock & Key	\$ 22.90
7a	P10-519	Lock and Key for Coin Box	\$ 7.20
8	A18-044	Napkin Weight	\$ 31.70
9	A18-045	Tampon Weight	\$ 33.90
10	P18-026	Screw # 10 x 1"	\$ 0.40
11	P18-055	Screw #10-32 x 1/2"	\$ 2.10
12	P15-399	Lock for Door	\$ 7.40
13	P15-398	Key for Door	\$ 9.60

*** Includes items P18-125 and label

For diagram of parts, please view installation instructions located at www.bradleycorp.com



Effective Date February 1, 2020

Napkin/Tampon Vendors

Model 4A20

Item	Part No.	Description	List Price
1	A18-046	Coin Metal Plate Assembly	\$ 53.60
2	A18-076	Napkin Cam	\$ 24.30
3	A18-075	Tampon Cam	\$ 34.00
4	A19-016***	Free Coin Mechanism Assembly	\$ 65.50
	A19-017***	10¢ Coin Mechanism Assembly	\$ 65.50
	A19-018***	25¢ Coin Mechanism Assembly	\$ 65.50
	A19-019***	50¢ Coin Mechanism Assembly	\$ 65.50
	A19-020***	\$1 Coin Mechanism Assembly	\$ 65.50
	A19-021***	€ .50 Coin Mechanism Assembly	\$ 65.50
5	P18-125	Screw for Coin Mechanism	\$ 1.70
6	P20-034	Free Label	\$ 1.10
	P20-036	10¢ Label	\$ 1.10
	P20-037	25¢ Label	\$ 1.30
	P20-078	50¢ Label	\$ 1.10
	P20-117	\$1 Label	\$ 1.60
	P20-180	€ .50 Label	\$ 1.10
7	A18-037	Coin Box Cover w/ Lock & Key	\$ 22.90
7a	P10-519	Lock and Key for Coin Box	\$ 7.20
8	A18-074	Napkin Weight	\$ 32.40
9	A18-073	Tampon Weight	\$ 33.90
10	P18-055	Screw # 10-32 x 1/2"	\$ 2.10
11	P15-465	Lock for Door	\$ 8.40
12	P15-398	Key for Door	\$ 9.60
13	P20-192	Installation Instructions	N/A*
14	A11-049	Surface-Mounted Collar Assembly	\$ 126.40
15	P18-119	3/4" Hex Nut	\$ 1.20

* For diagram of parts, please view installation instructions located at www.bradleycorp.com

*** Includes items P18-125 and label



Effective Date February 1, 2020

Toilet Tissue Dispensers/Components

Models 5402, 5412 & 5422

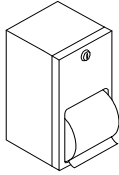

Part No.	Description	Kit Part Number	List Price
P10-571	Plastic Spindle (Kit includes Service Kit & spindle)	P15-407	\$ 4.60
P10-558*	Lock and Cam	P15-399	\$ 7.40
M09-003	Door Panel		\$ 12.20
P10-407	Rivet for Door Panel		\$ 0.20

*Refer to Lock & Cam Part No. Reference for Kit No.

Back Clamp for Toilet Tissue Holders

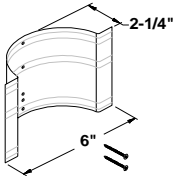

Part No.	Description	List Price
P15-024	510, 5101, 5102, 5103, 5104, 5123*, 5124*, 5125*	\$ 7.10

* Double unit (requires two per unit)

Toilet Tissue Dispenser Spindles

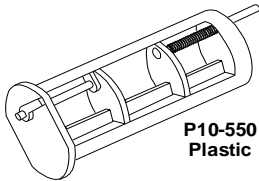

P10-550
Plastic

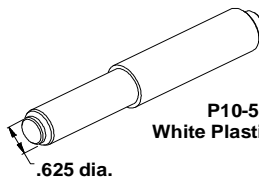

P10-560
White Plastic Roller

.625 dia.

Part No.	Used On Models	Kit Part Number	List Price
P10-550US	5071, 5241* (prior to 1990), 524, 5071-50, 5241-50*		\$ 18.60
P10-550	5071, 5241* (after 1990), 524, 5071-50, 5241-50*		\$ 5.90
P10-560	508, 5084, 5084US, 510, 5102, 5104, 5124*, 523*, 5234*, 5234US*, 5262, 5263*, 5264, 5265*, 5266, 5267*, 5269*		\$ 2.40
S01-459	Theft-Resistant Spindle - will fit following models: 508, 508-32, 5084, 5085, 5086, 510, 5101, 5102, 5103, 5104, 5105, 5124*, 5125*, 5126*, 523*, 5234*, 5235*, 5236*, 5262, 5263*, 5264, 5265*, 5266, 5267*		\$ 9.80
P10-571	5402*, 5412*, 5422*, 590, 5901, 5902, 591, 5911, 5912, 592, 5921, 5922, 594, 5942, 595, 5A00*, 5A10*, 5A20	P15-407	\$ 4.60
P10-613	5084, 5234*, 5085, 5235*, 5106, 5107, 5126*		\$ 7.40
P10-551	540*, 541*, 542*		\$ 14.20
P10-707	Core Adapter for 5424 Single Jumbo Roll		\$ 1.80

* These models require two spindles per unit.

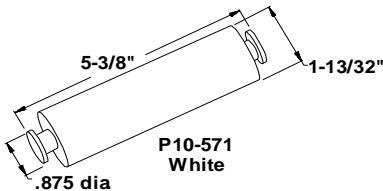

P10-571
White

.875 dia



S01-459
Theft-Resistant

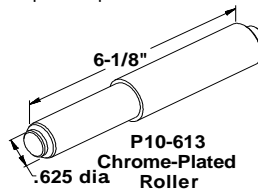

P10-613
Chrome-Plated
Roller

.625 dia

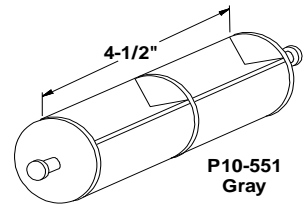

P10-551
Gray



Effective Date February 1, 2020

Dual Coreless Toilet Tissue Dispenser Components

Models 5426-11 & 5426-1195



Part No.	Description	Kit Part Number	List Price
P10-656	Retainer-Catch		\$ 1.80
P10-745	Catch Button		\$ 27.80
P18-123	Compression Spring		\$ 3.80
M27-054	Bracket- Back Pivot Assembly		\$ 67.70

Dual Coreless Toilet Tissue Dispenser/Waste Receptacle Components

Models 5951 & 5952



Part No.	Description	Kit Part Number	List Price
P10-656	Retainer-Catch		\$ 1.80
P10-745	Catch Button		\$ 27.80
P18-123	Compression Spring		\$ 3.80
P10-558	Lock - Clip & Key	P15-399	\$ 7.40
P11-010	Waste - Liner		\$ 35.00
A18-077	Bracket Assembly		\$ 69.90



Effective Date February 1, 2020

Soap Dispensers

Models 6542 & 6562, & 6563 where noted only

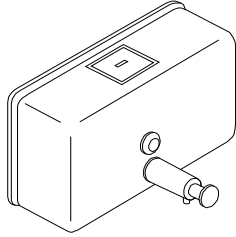

Part No.	Description	Kit Part Number	List Price
P19-212	Liquid Soap Valve (Complete)	P15-408	\$ 28.20
P19-236	Foam Soap Valve (Complete)	P15-510	\$ 31.40
P19-006	Sight Glass (Kit includes Service Kit, (5) per pack)	P15-405	\$ 10.10
P19-140	Mounting Kit (incl. Back Plate, Screws & Key) 6542, 6562, 6583	P19-140	\$ 5.50
P19-213	Repair Kit for Valves P19-212 (incl. Spring, Housing, O-Ring, Duckbill Check & Rubber Washer)	P19-213	\$ 18.90
P15-449	ABS Liquid Soap Valve, 6563 ONLY		\$ 28.20

NOTE: Repair Kits are not available for older valves P19-134 & P19-159. Order new valve P19-212.

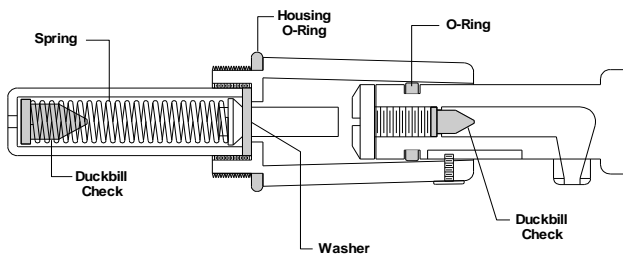

Soap Drawer Assemblies

With Liquid Soap Valve

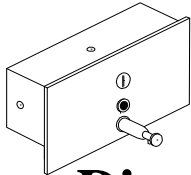

Part No.	Used On Models		List Price
S01-478	643		\$ 103.20
S01-482	644		\$ 163.40
M44-047	Brass Nut 3/4"-28 Hex.		\$ 4.80

Soap Valve For Soap Drawer Assemblies is P19-212 (see above).
Repair Kit For P19-212 is P19-213 (see above).

Soap Dispenser Parts

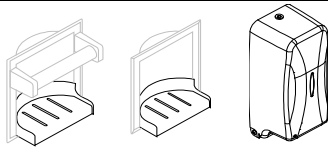

Part No.	Used on Models		List Price
P15-079	Plastic Soap Tray for 9352, 9353, 9362, 9363		\$ 3.00
P15-460	Control Box for 6A00-11		\$ 94.50
P15-461	Key for 6A00-11 and 6A01-11		\$ 2.20
269-2315	Tube for 6A00-11		\$ 6.60
P15-463	Tank for 6A00-11		\$ 6.20
P15-467	Key & Lock Kit for 6A00-11 and 6A01-11		\$ 6.60
P15-479	Control Box for 6A01-11		\$ 94.50
P15-480	Pump for 6A01-11		\$ 16.10
P15-481	Tank for 6A01-11		\$ 6.20



Soap Dispensers

Models 6322, 6324 & 6326 (Components Manufactured 1993 and After)

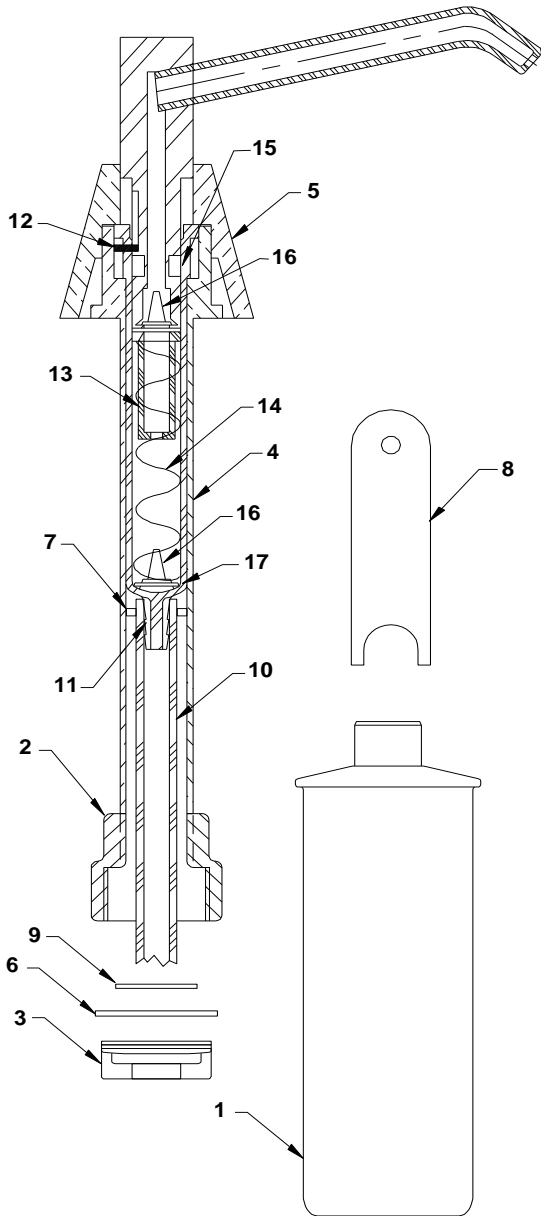

Item	Part No.	Qty	Description	Kit Part Number	List Price
1	P19-151	1	Metal Soap Cont. 16 oz.		\$ 26.60
	P10-287	1	Plastic Soap Cont. 16 oz.		\$ 4.50
	P19-119	1	Plastic Soap Cont. 32 oz.	P15-406	\$ 10.10
Not Shown	P19-053	1	1" Spacer		\$ 5.80
Spout Kits:					
	P19-206	1	2.5" Spout		\$ 107.30
	P19-207	1	4" Spout		\$ 62.70
	P19-208	1	6" Spout		\$ 65.50
Spout Kits include 2, 3, 4, 5, 6, 9 PLUS P19-187 Kit					
2	P19-117	1	Adapter		\$ 1.60
3	P19-121	1	Wing Nut		\$ 0.80
4	P19-116	1	Shank-ABS Plastic		\$ 2.80
	P19-169	1	Shank - Chrome-Plated Brass		\$ 13.00
5		1	Escutcheon		
6		1	Washer, Steel		
9		1	Washer, Neoprene		
Repair Kit P19-187 includes:				P19-187	\$ 15.60
7		1	Cable Tie		
8	P19-118	1	Wrench		\$ 2.30
10		1	Supply Tube		
11		1	Cylinder		
12		1	Screw		
13		1	Plunger Spacer		
14		1	Compression Spring		
15		1	O-Ring		
16		2	Duckbill Check		
17		1	Washer		

Prices subject to change without notice.
Items may be changed or discontinued
without notice and without incurring obligation.



Effective Date February 1, 2020

Soap Dispensers

Model 6334

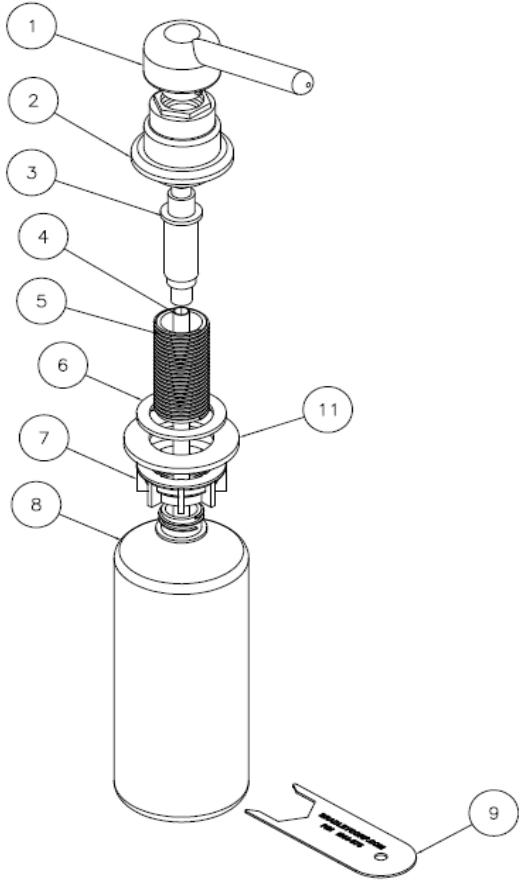

Item	Part No.	Description	List Price
1	P19-223	Plunger Assembly	\$ 77.70
2	P19-224	Flange Assembly	\$ 57.50
3	P19-225	Pump Assembly	\$ 10.90
4	P19-230	Supply Tube	\$ 2.20
5	P19-226	Shank 2-1/4 LG	\$ 3.40
6	P19-229	Washer - Rubber	\$ 2.70
7	P19-228	Nut	\$ 2.70
8	P19-227	Bottle 16 oz.	\$ 2.70
9	M44-075	Wrench	\$ 17.90
10	P20-150	Installation Instructions	\$ 0.60
11	P19-233	Washer - Metal	\$ 5.10



Effective Date February 1, 2020

Automatic Soap Dispenser (Manufactured after 8/24/07)

Model 6315 (No repair parts available for units manufactured before 8/24/07)

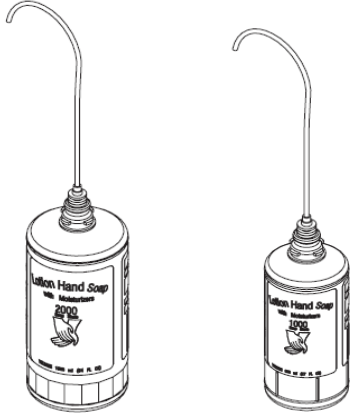
	Part No.	Qty	Description	List Price
	P19-232A	1	1 Case (4 Bottles) 54oz Lotion Soap with Moisturizer	\$ 149.30
	P19-232B	1	1 Case (4 Bottles) 27oz Lotion Soap with Moisturizer	\$ 84.60
	P19-231F	1	AC Adapter for Single Soap Dispenser	\$ 81.90
	P19-231G	1	AC Adapter for up to 4 Dispensers (requires 1 P19-231H per dispenser)	\$ 212.50
	P19-231H	1	Wire assembly (need 1 assembly for every dispenser. Max 4 per P19-231G)	\$ 31.70
	P19-231A	1	Spout Assembly	\$ 71.00
	P19-231B	1	C-Clip	\$ 1.70
	P19-231C	1	Motor Assembly	\$ 128.10
	P19-231D	1	Battery Box	\$ 38.20
	P19-231E	1	Clip - Bottle	\$ 1.70

P19-232A
54 oz., 2000 shot

P19-232B
27 oz., 1000 shot

P19-231F
(AC Adaptor for single soap dispenser)

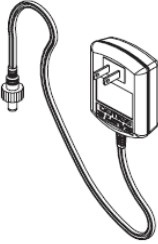

P19-231H (63" cord length)
(Wire assembly)

P19-231C
Motor Assembly

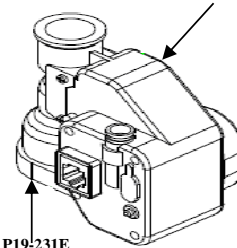

P19-231E
Clip - Bottle

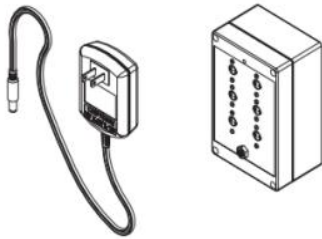

P19-231G (72" cord length)
(AC adaptor for up to 4 soap dispensers)



P19-231A
Spout Assembly



P19-231B
C-Clip

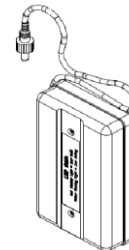

P19-231D
Battery Box

Prices subject to change without notice.
Items may be changed or discontinued
without notice and without incurring obligation.



Effective Date February 1, 2020

Grab Bar Parts

Part No.	Used On Models	List Price
U17-660	812 Coupling	\$ 122.30
U15-660	832 Coupling	\$ 146.70

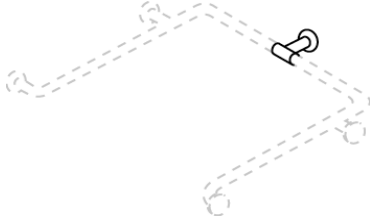

Shower Seat Parts

Part No.	Description	List Price
A18-052	Wall-Mtd. Support Assembly for 9562, 9569, 9591 thru 9594	\$ 44.10
P10-692	Phenolic seat only for 9569	\$ 264.80
P10-755	Phenolic seat only for 9591	\$ 181.30
P10-756	Bradmar seat only for 9592	\$ 222.80
P10-757	Bradmar seat only for 9593	\$ 289.40
P10-758	Bradmar seat only for 9594	\$ 333.10
P10-708	Phenolic seat only for 9562	\$ 194.50
P15-492	Adjustable Level Feet for 957, 9571 and 958	\$ 16.40

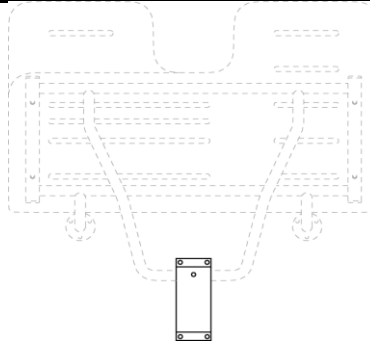

Shower Rods

Part No.	Description	List Price
P10-711	Swivel bracket ends, satin chrome plated zinc for 9530	\$ 36.20
P10-712	Swivel bracket ends, bright chrome plated zinc for 9530-78	\$ 31.90

*includes allen wrench, SS set screws, flathead stainless steel screws, and anchor plugs.



Washroom Accessories Division

TEL: 1-800-BRADLEY FAX: 262-251-5817

Web Site: www.bradleycorp.com

Effective Date February 1, 2012

Series 800 - Mounting Kits and Anchoring Devices

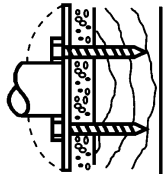
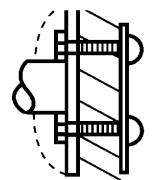
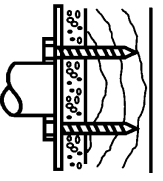
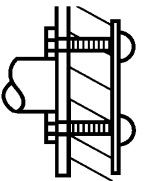
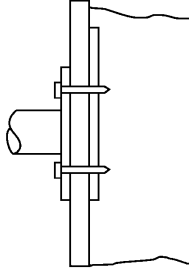
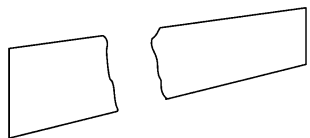
<p>CONCEALED MOUNTING KITS</p>	<p>Stud walls with wood supports</p> <p>899-010 \$1.70 Per Flange BX</p> <p>Material Included:</p> <p>(2) 1/4 x 2-1/2" plated steel hex head lag bolts</p> 	<p>Partition walls</p> <p>899-011 \$16.40 Per Flange</p> <p>Material Included:</p> <p>A. (2) 1/4-20 x 1-3/8" plated steel hex head machine screws</p> <p>B. (2) cap nuts</p> <p>C. (1) backing plate</p> 
<p>EXPOSED MOUNTING KITS</p>	<p>Stud walls with wood supports</p> <p>899-020</p> <p>\$2.70 Per Flange</p> <p>Material Included:</p> <p>(2) #14 x 2-1/2" stainless steel Philips oval head sheet metal screws</p> 	<p>Partition walls</p> <p>899-021 \$17.50 Per Flange</p> <p>Material Included:</p> <p>A. (2) 1/4-20 x 1-1/2" stainless steel Philips oval head machine screws</p> <p>B. (2) cap nuts</p> <p>C. (1) backing plate</p> 
<p>METAL STUD WALL MOUNTING KITS</p>	<p>(Concealed or Exposed)</p> <p>899-014 \$9.90 Per Flange</p> <p>Material Required:</p> <p>A. In-wall anchor plate (not included). Specify and order</p> <p>B. #10 sheet metal screws (furnished by others).</p> <p>C. Metal stud.</p> <p>D. (2) 1/4-20 x 1-1/4" flat head machine screws. (included with Mounting Kit 899-014)</p> <p>E. Wall dimension (to be furnished if over 3/4 inch).</p> 	
<p>IN-WALL ANCHOR PLATE</p>	<p>899-015 x Length (to 96") Must exceed length of Grab Bar by 12"</p> <p>Universal Anchor Plate Please contact customer service for a quotation.</p> <p>Material:</p> <p>4" x 1/8" cold rolled steel - length as specified to 96".</p> <p>Note: Separately order 899-014 mounting kits as required.</p> <p>899-015480 48" x 4" x 1/8"</p> <p>899-015540 54" x 4" x 1/8"</p> 	

Prices subject to change without notice.
Items may be changed or discontinued without notice and without incurring obligation.



Washroom Accessories Division

TEL: 1-800-BRADLEY FAX: 262-251-5817

Web Site: www.bradleycorp.com

Effective Date February 1, 2012

Series 800 - Mounting Kits and Anchoring Devices

Panel walls

899-012 \$2.20 Per Flange

Material Included:

- A. (2) 1/4-20 x 3" plated steel hex head machine screws
- B. (2) toggle nuts

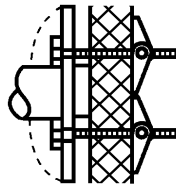

Masonry walls

899-013 \$3.70 Per Flange **BX**

Material Included:

- A. (2) 1/4-20 x 1" plated steel hex head machine screws
- B. (2) 1/4-20 lead anchors

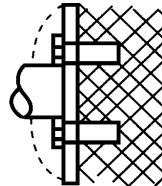

Panel walls

899-022 \$6.60 Per Flange

Material Included:

- A. (2) 1/4-20 x 3" stainless steel Philips oval head machine screws
- B. (2) toggle nuts

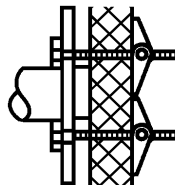

Masonry walls

899-023 \$2.20 Per Flange

Material Included:

- A. (2) 1/4-20 x 1" stainless steel Philips oval head machine screws
- B. (2) 1/4-20 lead anchors

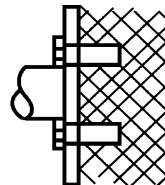

BLOCK WALL MOUNTING KITS

(Concealed or Exposed)

899-016 \$39.40 Per Flange

Material Required (items A-D included with 899-016 Kit):

- A. Front anchor plate 3" x 3" x 1/8" cold rolled steel-center slot punched and 2 fastener holes pre-punched.
- B. (2) 1/4-20 x 1-1/4" umbar-plated Philips oval head rollock tapping screws.
- C. (1) 3/8-16 steel zinc-plated tie rod with nut.
- D. Back anchor plate 3" x 3" x .12" cold rolled steel - tapped for and including 3/8-16 stud and nut.
- E. Finished wall thickness (to be furnished if over 3/4") Additional Charge for thickness over 3/4".
- F. Masonry wall (thickness to be furnished).

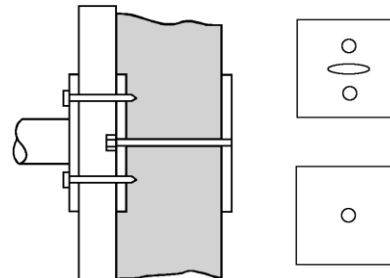

Back Anchor Plate

Installation:

Fasten to studs before wall is applied. Recess as required for flush finish wall application.
 To attach grab bar, drill #2 (.221 diameter) holes
 Attach with 1/4-20 x 1-1/4" umbar-plated Philips oval head rollock tapping screws.



Effective Date February 1, 2020

Post Sets for Towel Bars

	Part No.	Description	List Price
	9054-P00000	9054	\$ 22.70
	9055-P00000	9055	\$ 26.60
	9065-P00000	9065	\$ 22.70
	9066-P00000	9066	\$ 26.60
	926-P00000	926	\$ 17.50
	927-P00000	927	\$ 17.50

Towel Dispenser Accessories

Part No.	Description	List Price
M08-001	Towel Pan for 2017, 225, 2252, 247, 2478 Towel Disp.; 2017, 2018, 2037, 237, 2038, 238 Towel/Waste Unit; 130, 155 Multi-Unit	\$ 35.90
M08-005	Towel Pan for A01, 270 Multi Purpose Unit	\$ 96.20
P10-689	Towel Dispenser Knob (white) and screw pack (5 per) for P10-561	\$ 10.00
P10-561	Towel Dispenser Mechanism for 227 & 2277 Towel/Waste Unit; 2481, 2483, 2484 Roll Towel Disp.; Ps200, S08 Cabinet Assy.	\$ 158.90
P15-394	Spring for P10-561 Towel Dispenser	\$ 0.80
A17-003	Service kit for 236 Towel/Waste Units and 2479 Towel Dispensers. 2 Service part Towel dispenser center pulls, 4 Lip Trims, 1 set of instructions.	\$ 86.90
P10-687	Cone for 236 Towel/Waste Units and 2479 Towel Dispensers	\$ 49.10
P15-397	Cover for 2490	\$ 80.90
P15-390	Key for 2490	\$ 1.30
P15-450	Cover for 2494	\$ 44.80
P15-451	Key for 2494 and 2497	\$ 1.30
P15-452	AC Conversion Pack for 2494	\$ 77.70
P15-453	Cover for 2495	\$ 91.80
P15-454	Key for 2495 and 2496	\$ 1.30
P15-457	Cover for 2497	\$ 48.10
P15-458	Cover for 2496	\$ 81.30
P15-459	AC Conversion Pack for 2496	\$ 180.70
P15-466	Replacement Towel Arms for 2494	\$ 5.50
P10-740	Keyless Handle for 2496	\$ 6.00
P10-741	Keyless Knob for 2497	\$ 2.20

Miscellaneous Parts

Part No.	Description	List Price
P10-695	Shield for 5900 Series Combination Units (after 2004)	\$ 17.60
P18-116	Nylon Snap Rivet for P10-695 (need 2 for each P10-695)	\$ 0.40
P10-012	Mop Holder for 9933, 9934, 9953, 9954, 9955, 9983, 9984, 9985, 9986	\$ 3.30
P18-106	Rivet for 9953,9954,9955	\$ 0.40
P10-642	Magnetic Catch for 175	\$ 3.60



Effective Date February 1, 2020

COLLARS: Recessed to Semi-Recessed

Part Number	Used On Models	List Price
S08-211	130, 155, 170, 175, 334, 344, 346	\$ 82.70
S08-220	2291, 244, 3251	\$ 85.20
S08-230	1471, 2441	\$ 79.80
S08-225	2017, 2018	\$ 149.00
S08-252	2027, 2028	\$ 156.20
A10-002	2037, 2038	\$ 149.60
S08-209	225	\$ 241.30
S08-258	2251	\$ 167.20
S08-244	2252	\$ 153.90
A10-001	227, 2271	\$ 182.80
A11-037	2277	\$ 165.50
S08-228	229	\$ 147.40
S08-222	2297, 2298, 2447, 2448, 3257, 3258	\$ 109.20
S08-210	234 & 235 (prior to March 2011)	\$ 109.20
A10-007	234 & 235 (after March 2011), 2A05	\$ 170.90
S08-205	236, 237, 238	\$ 147.00
S08-243	247	\$ 134.40
A11-029	2481	\$ 128.90
A10-003	2484	\$ 203.20
A10-004	270	\$ 168.70
S08-242	315-35	\$ 162.90
S08-257	3157, 3158	\$ 149.80
S08-226	4017, 4018	\$ 100.80
A11-031	2442, 2443, 4737, 4738	\$ 95.00
A10-008	2A00, 3A05	\$ 125.60
A10-010	2A15, 2A25, 2A95	\$ 193.40
A10-012	2A01, 2A02, 2A09	\$ 168.10

Collars can only be used with fully-recessed units.



Effective Date February 1, 2020

COLLARS: Recessed to Surface-Mtd.

Part Number	Used On Models	List Price
S08-207	130, 155, 170, 175, 334, 344	\$ 99.50
S08-243	2291, 244, 3251	\$ 89.60
S08-219	1471, 2441	\$ 68.10
S08-248	2017, 2018	\$ 179.10
S08-251	2027, 2028	\$ 171.50
A11-018	2037, 2038	\$ 197.70
S08-233	225	\$ 284.30
A11-005	2251	\$ 169.30
S08-241	2252	\$ 223.90
A11-008	227, 2271	\$ 254.70
A11-038	2277	\$ 216.60
S08-227	229	\$ 100.90
S08-235	2297, 2298, 2447, 2448, 3257, 3258	\$ 118.00
S08-201	234 & 235 (prior to March 2011)	\$ 99.40
A11-044	234 & 235 (after March 2011), 2A05	\$ 186.40
A11-002	236, 237, 238	\$ 180.30
A11-007	2442, 2443, 4737, 4738	\$ 104.90
A11-012	247	\$ 136.50
A11-004	2478	\$ 143.10
S08-256	2481	\$ 143.10
A11-041	270	\$ 264.30
S08-229	315-35	\$ 260.00
A11-017	3157, 3158	\$ 188.90
A11-003	346	\$ 110.00
A11-039	4017	\$ 130.60
A11-019	4018	\$ 123.50
A11-040	407	\$ 102.80
S08-245	990	\$ 155.10
A11-045	3A05	\$ 127.80
A11-047	2A15, 2A25, 2A95	\$ 272.30
A11-049	4A20	\$ 126.40
A11-051	2A01, 2A02, 2A09	\$ 164.00
P15-511	962	\$ 242.30

Collars can only be used with fully-recessed units.



Effective Date February 1, 2020

Shower Rod Flanges

Part No.	Used On Models	Description	List Price
701-600	953	1" Exposed Flange	\$ 3.30
701-600A	9531	1-1/4" Exposed Flange	\$ 3.30
9532-F00000	9532	1" Exposed Flange	\$ 13.70
P10-482	9538	1" Concealed Flange	\$ 2.50
U10-666	9538	1" Escutcheon	\$ 2.30
P10-482A	9539	1-1/4" Concealed Flange	\$ 2.90
U12-666	9539	1-1/4" Escutcheon	\$ 2.70

Baby Changing Stations and Toddler Seat

Part No.	Used On Models	Description	List Price
P15-507	961, 9611, 9612	Replacement Strap	\$ 50.70
P11-021	961, 9611, 9612, 962-11, 962, 963, 9631, 9632	Case of 500 White Liners	\$ 152.90
P15-491	962, 962-11, 963, 9631, 9632	Replacement Strap	\$ 32.80
P15-495	964	Replacement Strap	\$ 32.80

Miscellaneous

Part No.	Used On Models	Description	List Price
P10-526*	All Models W/Locks	Key	P15-397
P18-073	All Models W/Torx Head W/Pin Security Screws	Torx Tool Kit	\$ 65.20
330-074	All Mirrors W/H-Hangers	Mirror Release Tool	\$ 35.70
P10-636	All Models W/Locks	Turn Knob Key	\$ 2.90

*Refer to Lock & Cam Part No. Reference for Kit No.



Mirror Glass

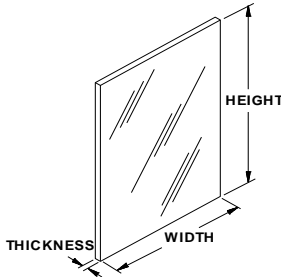

Part No.	Used On Models	Size (Inches)			List Price
		Width	Height	Depth	
P13-002	130, 155	14-13/16	17-13/16	1/4	\$23.40
P13-008	175	16-13/16	30-3/8	1/4	\$46.80

Mirror Accessory		Large Mirrors -100" Plus			
A18-054	Support Bracket Kit	2-1/2	3-3/4	1	\$57.20
Kit includes: two brackets and instruction sheets.					
P10-719	Frameless Mirror Clip Kit - Set of (4). Used on 747 and 747F				\$13.10

Replacement Shelves

For Medicine Cabinets

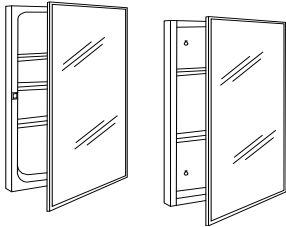
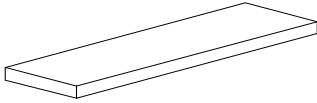

Part No.	Used On Models	Description	List Price
P15-380	9663	Stainless	\$13.30
P15-385	9664	Stainless	\$14.80
260-042	175	Stainless	\$14.70



Lock & Cam Part Number Reference

Model No.	Lock & Cam Part No.	List Price	Model No.	Lock & Cam Part No.	List Price
130-000000	P10-596 (door)	Service Kit	334-000000	P10-568	Service Kit
130-000000	P10-558 (soap disp)	Service Kit	344-000000	P10-568	Service Kit
1471-000000	P10-558	Service Kit	346-000000	P10-568	Service Kit
1471-1100000	P10-558	Service Kit	401 Series	P10-558 (door)	Service Kit
155-000000	P10-596	Service Kit	401 Series	P10-519 (coin box)	\$ 7.20
194-000000	P10-565 (towel disp)	Service Kit	4017-000000	P10-558 (door)	Service Kit
194-000000	P10-558 (soap disp)	Service Kit	4017-000000	P10-519 (coin box)	\$ 7.20
198-000000	P10-565	Service Kit	4018 Series	P10-558 (door)	Service Kit
1981-000000	P10-558	Service Kit	4018 Series	P10-519 (coin box)	\$ 7.20
1985-000000	P10-565	Service Kit	402-000000	P10-558 (door)	Service Kit
2017-000000	P10-565	Service Kit	402-000000	P10-519 (coin box)	\$ 7.20
2027-000000	P10-565	Service Kit	403 Series	P10-558 (door)	Service Kit
2037-000000	P10-565	Service Kit	403 Series	P10-519 (coin box)	\$ 7.20
225-000000	P10-558	Service Kit	404 Series	P10-558 (door)	Service Kit
2251-000000	P10-558	Service Kit	404 Series	P10-519 (coin box)	\$ 7.20
2252-000000	P10-558	Service Kit	407 Series	P10-558 (door)	Service Kit
227-000000	P10-558 (door)	Service Kit	407 Series	P10-519 (coin box)	\$ 7.20
227-000000	P10-568 (W/R)	Service Kit	426 Series	P10-558 (door)	Service Kit
2271-000000	P10-558 (door)	Service Kit	426 Series	P10-519 (coin box)	\$ 7.20
2271-000000	P10-568 (W/R)	Service Kit	428 Series	P10-558 (door)	Service Kit
2277-000000	P10-565	Service Kit	428 Series	P10-519 (coin box)	\$ 7.20
229-000000	P10-558	Service Kit	4721-150000	P10-565	Service Kit
2291-000000	P10-558	Service Kit	4722-101500	P10-565	Service Kit
2297-000000	P10-565	Service Kit	4722-150000	P10-565	Service Kit
233-000000	P10-558 (door)	Service Kit	4731-150000	P10-565	Service Kit
233-000000	P10-568 (W/R)	Service Kit	4737-000000	P10-558	Service Kit
234-000000	P10-568	Service Kit	4781-150000	P10-567	Service Kit
235-000000	P10-558, P10-568	Service Kit	4791-150000	P10-567	Service Kit
236-000000	P10-558 (door)	Service Kit	5402-000000	P10-558	Service Kit
236-000000	P10-568 (W/R)	Service Kit	5412-000000	P10-558	Service Kit
237-000000	P10-558 (door)	Service Kit	5422-000000	P10-558	Service Kit
237-000000	P10-568 (W/R)	Service Kit	5424-000000	P10-558	Service Kit
238-000000	P10-558	Service Kit	5425-000000	P10-565	Service Kit
244-000000	P10-558	Service Kit	583-000000	P10-567	Service Kit
2441-000000	P10-558	Service Kit	584-000000	P10-558	Service Kit
2442-000000	P10-565	Service Kit	5847-000000	P10-558	Service Kit
2447-000000	P10-565	Service Kit	591-000000	P10-558	Service Kit
247-000000	P10-558	Service Kit	5911-000000	P10-558	Service Kit
2481-000000	P10-558	Service Kit	5912-000000	P10-558	Service Kit
250-150000	P10-565	Service Kit	592-000000	P10-558	Service Kit
250-330000	P10-565	Service Kit	5921-000000	P10-558	Service Kit
251-150000	P10-621	Service Kit	5922-000000	P10-558	Service Kit
252-000000	P10-565	Service Kit	5932-000000	P10-558	Service Kit
270-000000	P10-558	Service Kit	594-000000	P10-558	Service Kit
315-350000	P10-558	Service Kit	5942-000000	P10-558	Service Kit
3157-000000	P10-565	Service Kit	643-000000	P10-558	Service Kit
3251-000000	P10-558	Service Kit	6437-000000	P10-558	Service Kit
3257-000000	P10-565	Service Kit	644-000000	P10-558	Service Kit
			9495-000000	P10-567	Service Kit

**P10-526 key unlocks
all locks except
P10-519**

Service Kits

Description	Kit Number	List Price
Key P10-526 (5 keys per kit)	P15-398	\$ 9.60
P10-558 lock, clip, & key kit	P15-399	\$ 7.40
P10-565 lock, clip, & key kit	P15-400	\$ 7.40
P10-567 lock, clip, & key kit	P15-401	\$ 7.40
P10-568 lock, clip, & key kit	P15-402	\$ 7.40
P10-723 lock, clip, & key kit	P15-465	\$ 8.40
P10-621 lock, clip, & key kit	P15-404	\$ 7.40



Diplomat™ Lock & Cam Part Number Reference

Model No.	Lock & Cam Part No.	List Price
2A00	P10-723	Service Kit
2A01	P10-723	Service Kit
2A02	P10-723	Service Kit
2A05	P10-723 (door), P10-568 (W/R)	Service Kit
2A09	P10-723	Service Kit
2A10	P10-558	Service Kit
2A15	P10-723 (door), P10-568 (W/R)	Service Kit
2A25	P10-723 (door), P10-568 (W/R)	Service Kit
2A95	P10-723 (door), P10-568 (W/R)	Service Kit
3A05	P10-568	Service Kit
4A00	P10-558	Service Kit
4A11	P10-558	Service Kit
4A20	P10-723 (door)	Service Kit
4A20	P10-519 (coin box)	\$ 7.20
5A00	P10-558	Service Kit
5A10	P10-558	Service Kit
5A20	P10-558	Service Kit
5A40	P10-558	Service Kit

**P10-526 key unlocks all locks
except
P10-519**

Service Kits		
Description	Kit Number	List Price
Key P10-526 (5 keys per kit)	P15-398	\$ 9.60
P10-558 lock, clip, & key kit	P15-399	\$ 7.40
P10-565 lock, clip, & key kit	P15-400	\$ 7.40
P10-567 lock, clip, & key kit	P15-401	\$ 7.40
P10-568 lock, clip, & key kit	P15-402	\$ 7.40
P10-723 lock, clip, & key kit	P15-465	\$ 8.40
P10-621 lock, clip, & key kit	P15-404	\$ 7.40

Kit Reference Guide

Part No.	Description	Quantity	Kit No.	List Price	Ref. Page
P11-030	Waxed Paper Liner	500	P11-022	\$ 245.70	3
P10-526	Key	5	P15-398	\$ 9.60	14
P10-558	Lock, Clip, & Key	1	P15-399	\$ 7.40	14
P10-565	Lock, Clip, & Key	1	P15-400	\$ 7.40	14
P10-567	Lock, Clip, & Key	1	P15-401	\$ 7.40	14
P10-568	Lock, Clip, & Key	1	P15-402	\$ 7.40	14
P10-596	Lock, Clip, & Key	1	P15-403	\$ 10.60	14
P10-621	Lock, Clip, & Key	1	P15-404	\$ 7.40	14
P19-006	Sight Glass	5	P15-405	\$ 10.10	7
P19-119	32 oz. Plastic Soap Bottle	1	P15-406	\$ 10.10	8
P10-571	Toilet Tissue Spindle	1	P15-407	\$ 4.60	6
P19-212	Soap Valve	1	P15-408	\$ 28.10	7
P19-140	Mounting Kit (Backplate, Screws, Key)	1	P19-140	\$ 5.50	7
P19-213	Repair Kit - Soap Valves	1	P19-213	\$ 18.90	7
P19-187	Repair Kit - Soap Dispenser	1	P19-187	\$ 15.60	8

Date	Page	Change Description	Implemented By
10/15/2018	15	Remove Obsoleted S01-479 Soap Tank Assembly	Kendall Thompson
10/15/2018	15	Add NEW Foam Soap Valve Kit P15-510	Kendall Thompson
11/12/2018	ALL	2019 Price Increase - Effective 2/1/2019	Kendall Thompson
2/4/2019	CDN - ALL	Updated Canadian Price Multiplier 1.32 to 1.34	Kendall Thompson
12/1/2019	ALL	2020 Price Increase - Effective 2/1/2020	Austin Kaatz
4/20/2020	24	Remove Obsoleted S08-208 collar. Replace w/ S08-243	Austin Kaatz
4/20/2020	24	Remove AD3-0008B bcs collar. Replace w/ P15-511	Austin Kaatz