



A WATTS Brand

S19214Y, S19214YF

Pedestal-Mount Halo™ Eye/Face Wash with Stainless Steel Bowl

- Halo™ Delivers the Most Effective Eye/Face Washdown Coverage and Spray Pattern
- Exceeds ANSI/ISEA Z358.1 Specifications
- Industry's Only Self-Draining Design – The Aquaduct™
- Separate Supply and Waste Pipes – Meets CEN and Plumbing Requirements
- Ergonomic Hand Activation Eye/Face Wash Paddle – Easy to Reach from Any Direction
- Barrier Free
- Fully-Assembled and Factory-Tested Eye/Face Wash with Hinged Dust Covers
- Universal Identification Sign and Inspection Tag Included
- Classified by Underwriters Laboratories Inc. to ANSI/ISEA Z358.1.
- Halo™ is Covered by One or More of the Following Patents: 9,700,484; 9,314,398; D662220; D673298; D662605; D685920; D662219; and D671228. Other Patents Pending.



Specifications

Standard Eye/Face Wash Units save space and fit easily into any work environment. Halo eye/face wash, operated by an ergonomic, highly visible push handle, provides effective wash down coverage and spray pattern. Integral strainer reduces debris in the water and also prevents clogging.

This plumbing fixture is not intended to dispense water for human consumption through drinking or for preparation of food or beverages.

Pipe and Fittings

Piping to 1/2" NPT water supply inlet on unit. Piping to 1-1/4" NPT drain outlet for eyewash. 1-1/4" piping assembly manufactured of one of the following materials:

- Galvanized steel with BradTect® safety yellow coating

Ball Valve

1/2" stay-open eye and eye/face wash valve manufactured of the following materials:

- Chrome-plated brass

Eye/Face Wash

The Halo eye/face wash system offers a high performance rinsing platform that provides rapid relief to an individual's eyes and face that have been injured by chemicals or particulate. This system provides the most complete face wash available in the market. The eye/face wash includes an integral 5.1 GPM (19.2 L) flow control, providing water at a safe velocity while maintaining its effectiveness (exceeds minimum water flow of 3.0 GPM (11.4 L) at 30 PSI (2.0 bar)). Eye/face wash is protected by flip open dust covers that open when product is activated. Safe, steady water flow under varying water supply conditions from 30–90 PSI (2.0–6.1 bar) is assured by integral flow control in the sprayhead assembly. Sprayheads are made from an impact resistant ABS plastic.

Bowl

Bowl is constructed of Type 304 corrosion-resistant stainless steel.

Activation

Type 304 Stainless steel push handle (S19214Y) with Type 304 stainless steel foot pedal (S19214YF).

Model	Description
S19214Y	Halo eye/face wash, stainless steel bowl
S19214YF	Halo eye/face wash, stainless steel bowl, foot pedal

Tepid Water Options

[Navigator S19-2000 EFX8
Emergency Thermostatic Mixing Valve](#)

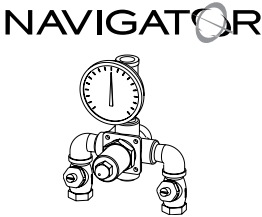

[Keltech CLE-Series
Tankless Water Heater](#)

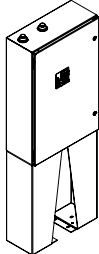

Satisfies ANSI/ISEA Z358.1 tepid water requirements.



S19214Y, S19214YF

Pedestal-Mount Halo™ Eye/Face Wash with Stainless Steel Bowl

S19214 shown with Eye/Face Wash and Stainless Steel Bowl

 Drawing depicts Eyewash. Eye/Face Wash dimensions are the same.

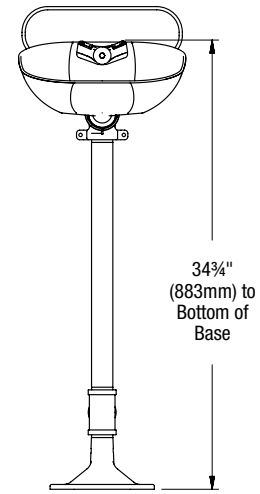
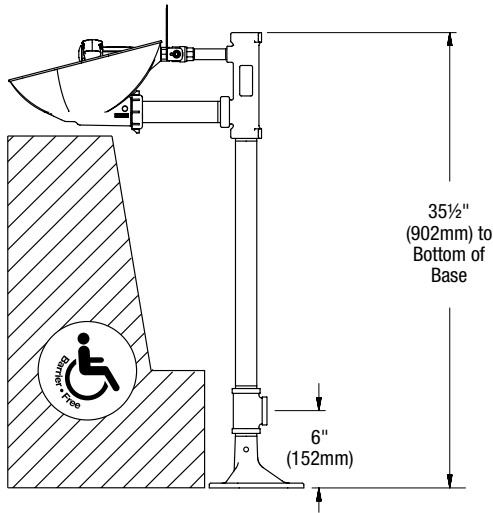

Eye/Face Wash Bowl

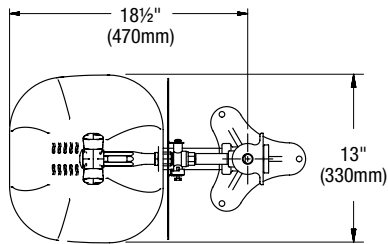

Foot Pedal Activation

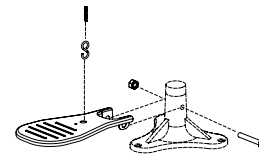

 All dimensions assume standard thread engagement. Variations in manufacturing allow for +/- 1/8" (3mm) per threaded joint. To find the tolerance of a dimension, add the number of thread joints across the length of the dimension and multiply it by 1/8" (3mm).